

FA626 ICE

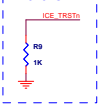

IC2_SCL <<> IC2_SCL
IC2_SDA <<> IC2_SDA

MAC_RX <<> MAC_RXN
MAC_TX <<> MAC_TXN
MAC_TXP <<> MAC_TXPN
MAC_TXN <<> MAC_TXPN

UART0_TX <<> UART0_TXN
UART0_RX <<> UART0_RXN

ActiveLED <<> ActiveLED
PowerLED <<> PowerLED
Default_Sel <<> Default_Sel

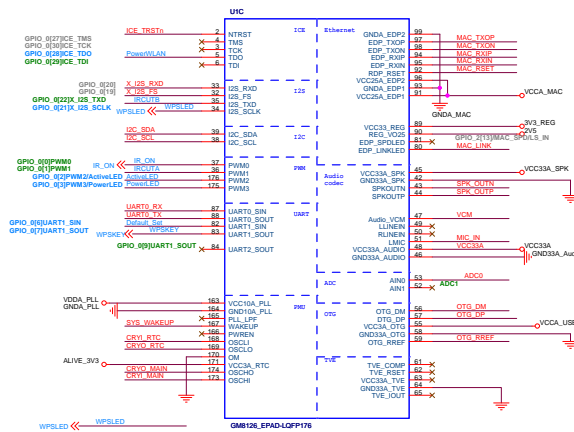

Close to GM8126

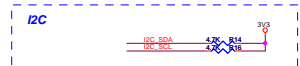

SPK_OUTN <<> SPK_OUTN
SPK_OUTP <<> SPK_OUTP

MIC_IN <<> MIC_IN

MAC_LINK <<> MAC_LINK

Firmware update <<> Firmware update

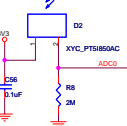

Pin1 setting:

Pin	Function
222-5-222-P21	PowerLED
1-1001	Default (Default)

Pin32k dis:

Pin	Function
220-137-P21	PowerLED
220-137-P21	Default (Default)
1-1001	Default

Firmware update:

Pin	Function
221-222-P21	PowerLED
1-1001	Default

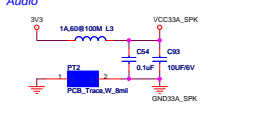
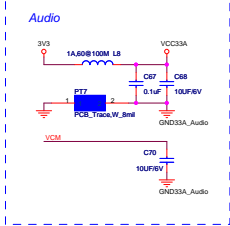
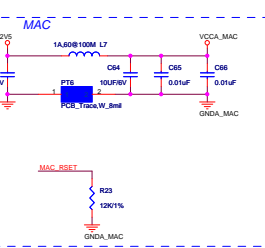
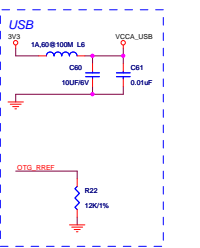
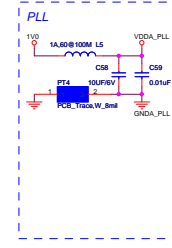
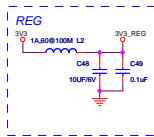
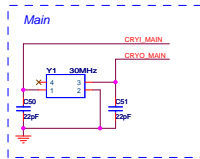
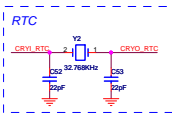
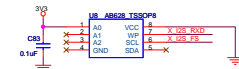
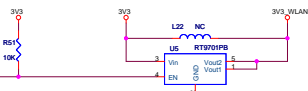
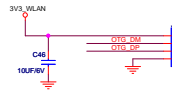

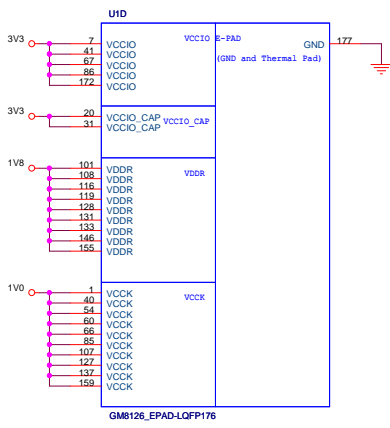

Close to GM8126

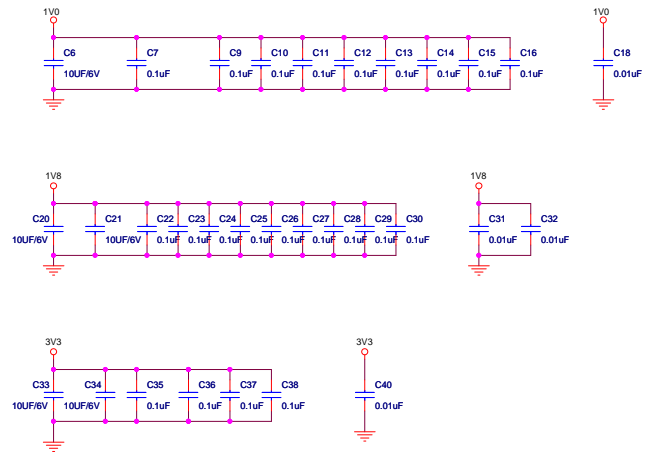

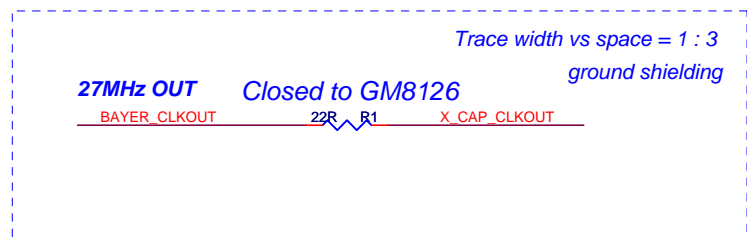
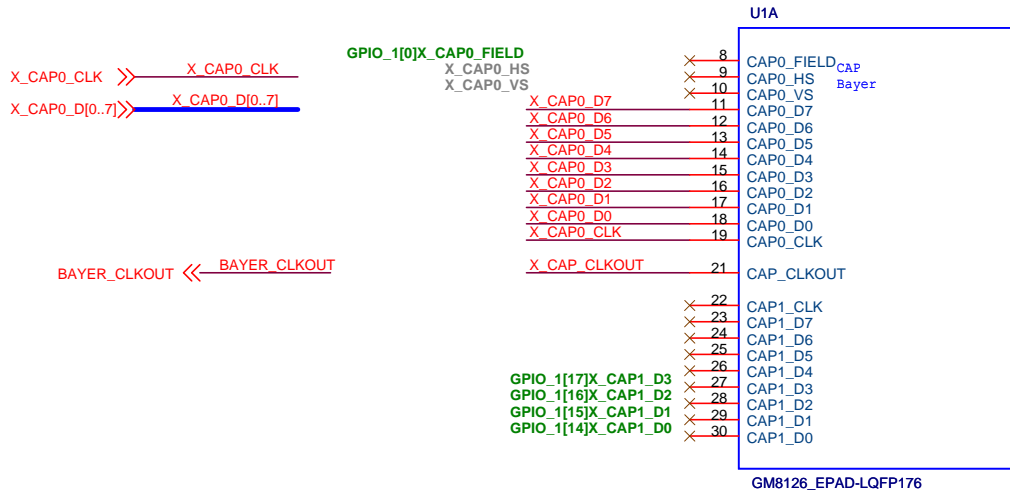

MAC_RXIP >> MAC_RXIP
 MAC_RXIP >> MAC_RXIN
 MAC_TXOP << MAC_TXOP
 MAC_TXON << MAC_TXON

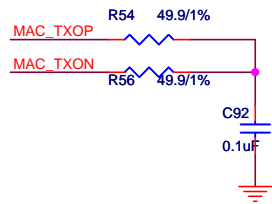
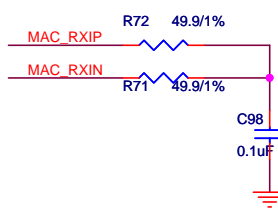
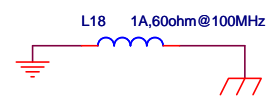
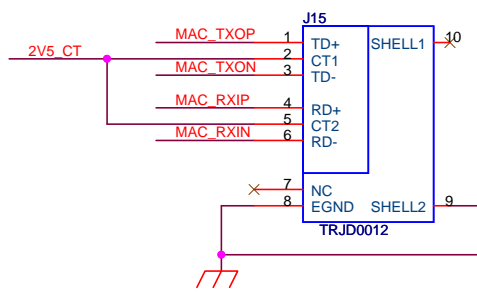
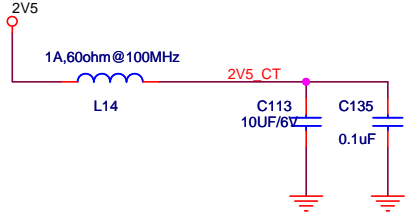

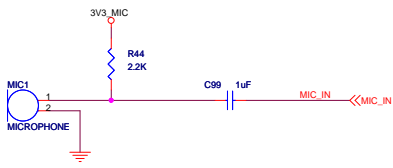
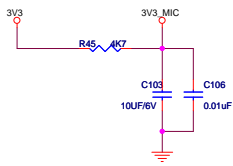

SPK_OUTN >> SPK_OUTN
SPK_OUTP >> SPK_OUTP

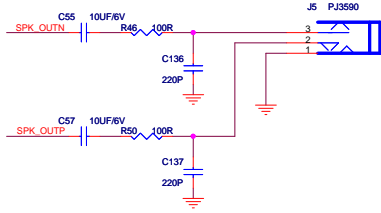

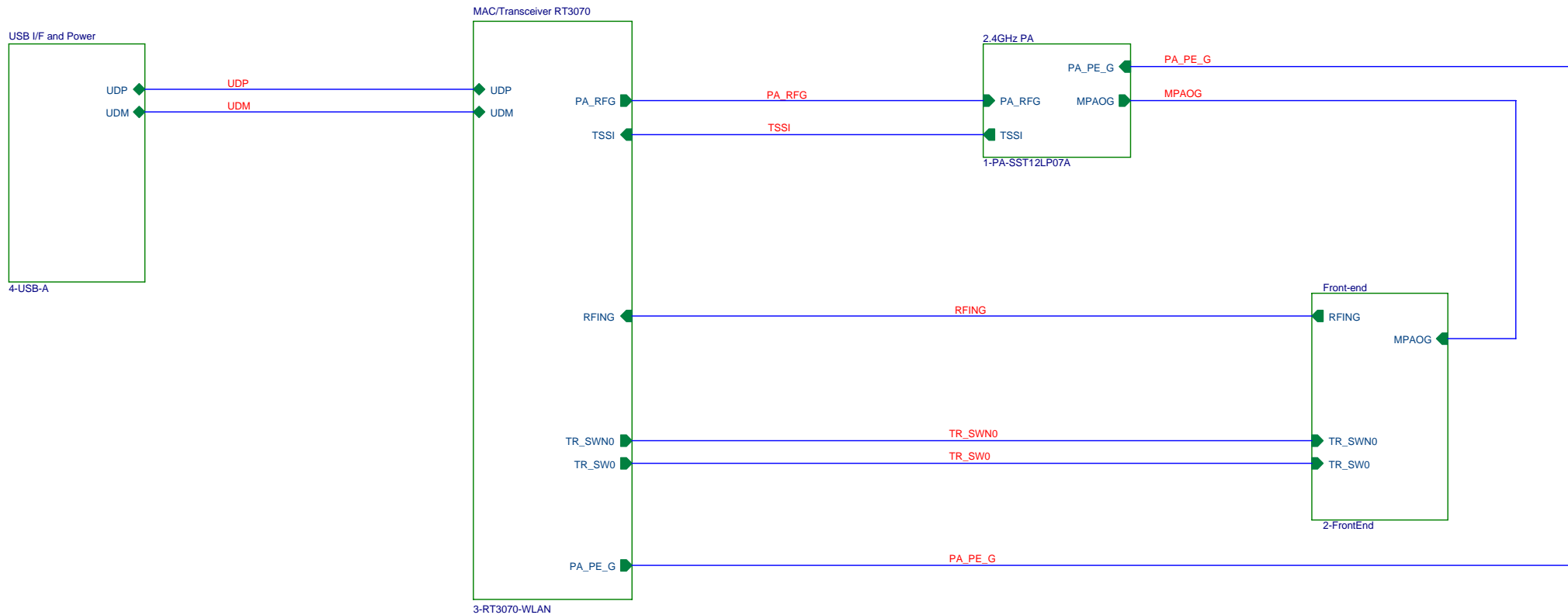

Filename:
PEN-RT3070-QFN-V33ST-A-081013.DSN

	RALINK TECHNOLOGY, CORP.		
	Title 2.4G USB Card - RT3070		
Size B	Document Number PEN-RT3070-V33ST-A.SCH		Rev 3.3
Date: Tuesday, November 25, 2008		Sheet 1 of 6	

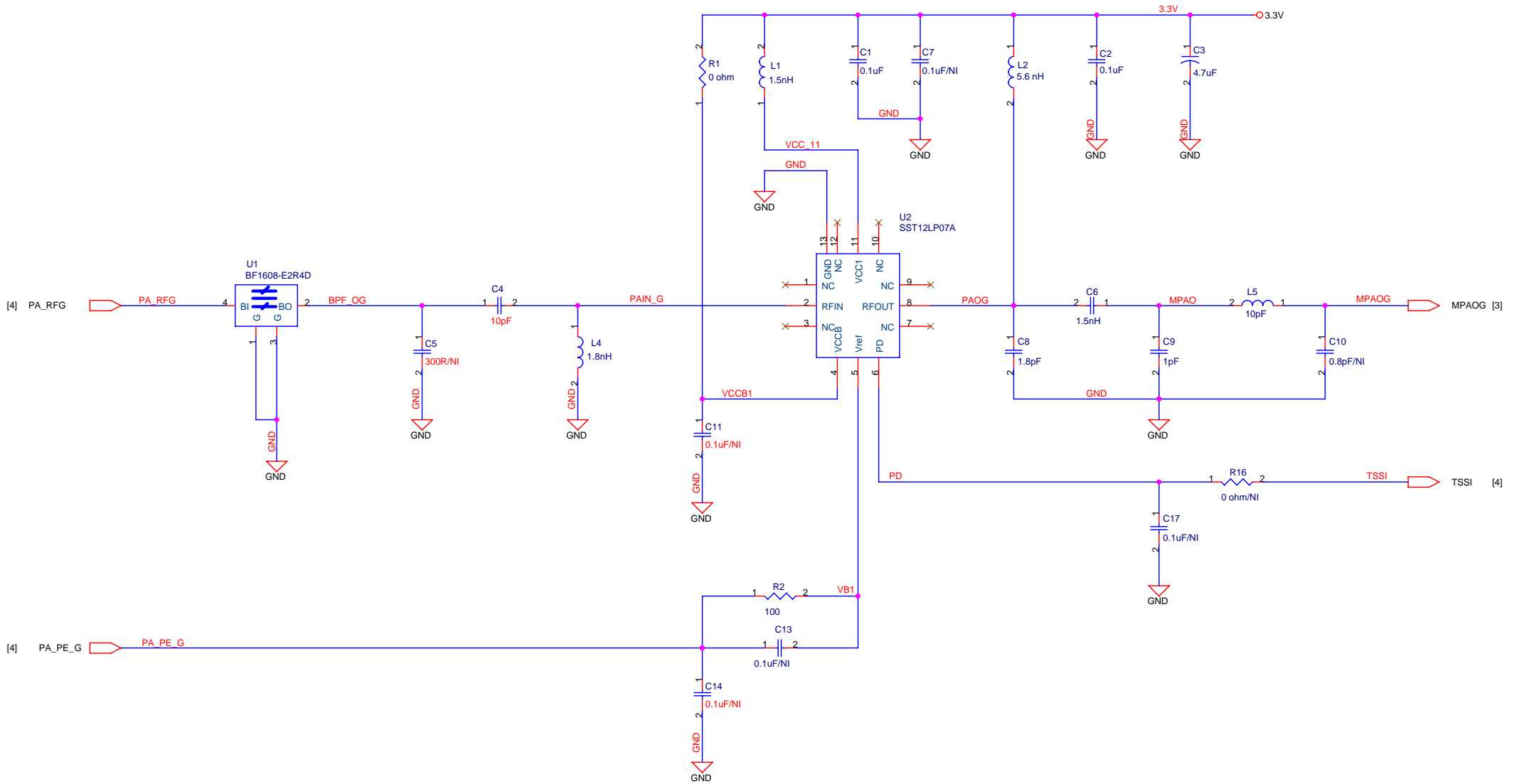

		RALINK TECHNOLOGY, CORP.	
		Title 2.4GHz PA	
Size B	Document Number 1-PA-SST12LP07A.SCH		Rev 3.3
Date:	Wednesday, October 15, 2008		Sheet 2 of 6

Ant. 2412-2462MHz

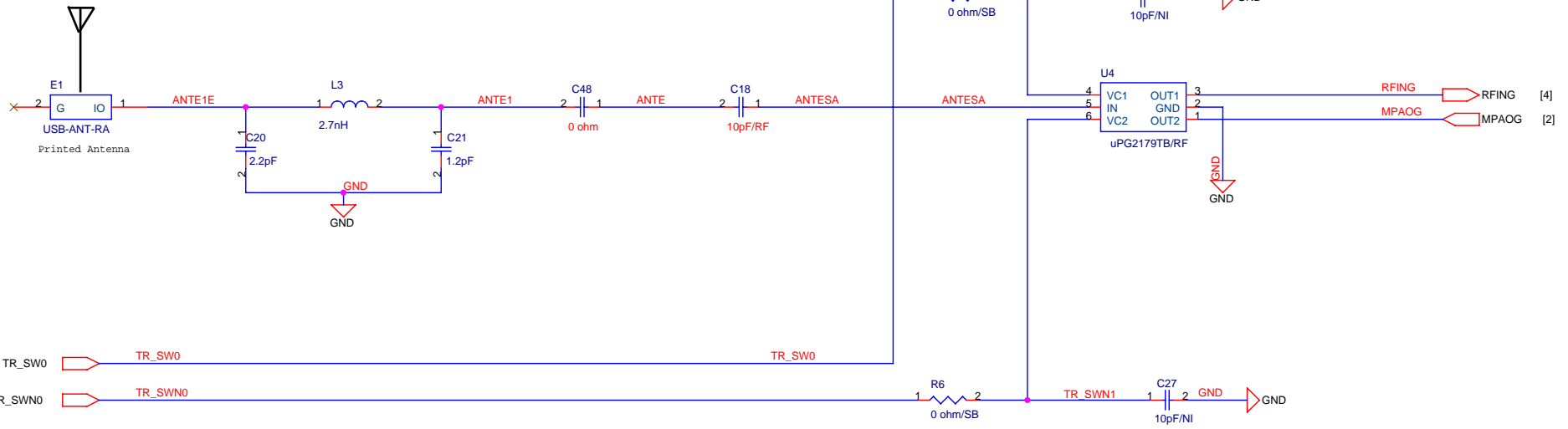



[4] TR_SW0
[4] TR_SWN0

[4]
[2]

		RALINK TECHNOLOGY, CORP.	
		Title Front-End	
Size B	Document Number 2-FrontEnd.SCH		Rev 3.3
Date:	Wednesday, October 15, 2008	Sheet	3 of 6

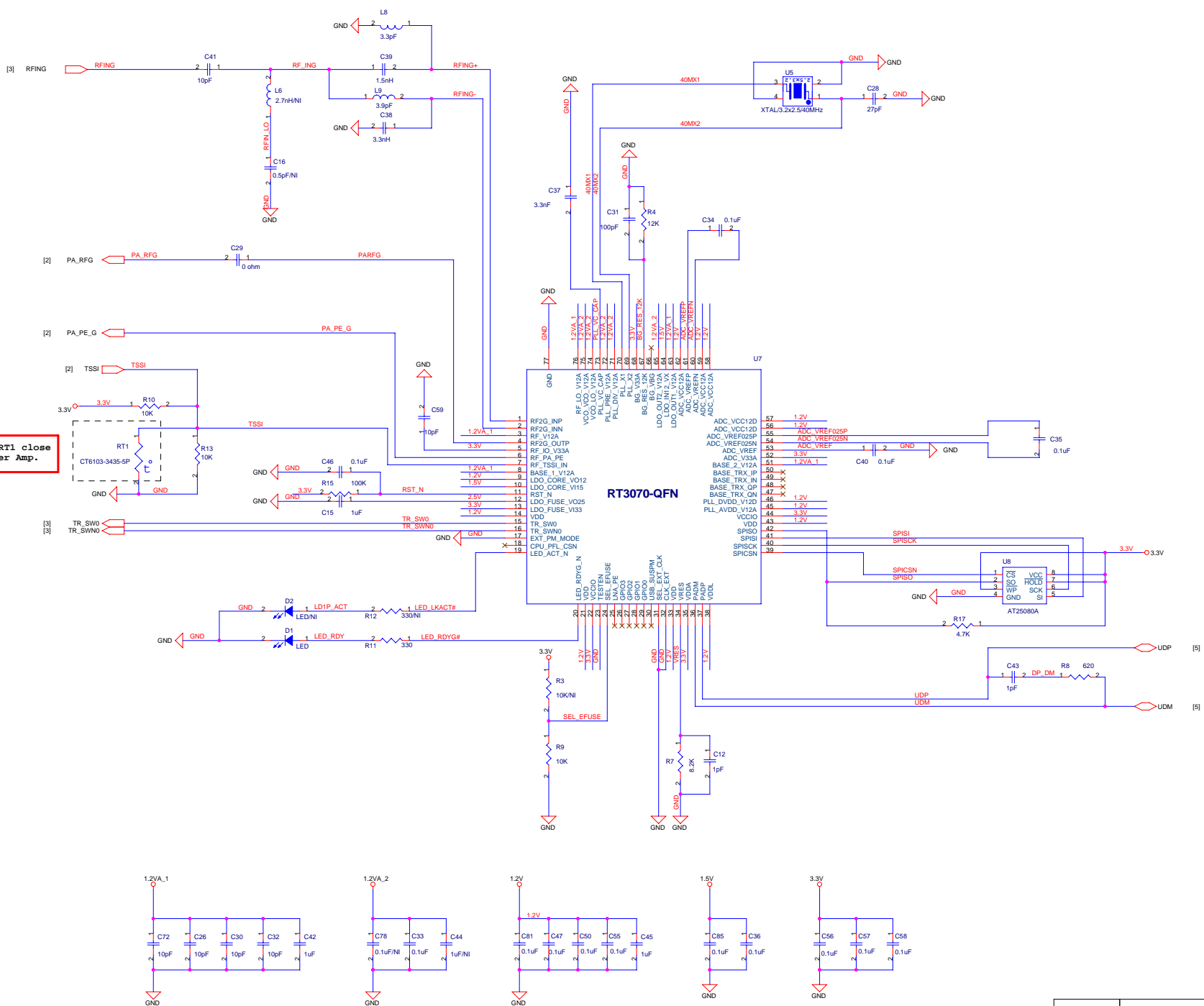
Place RT1 close to Power Amp.



		RALINK TECHNOLOGY, CORP.		
		File	RT3070-WLAN	
Size	Document Number	3-RT3070-WLAN.SCH	Rev	3.3
Date	Wednesday, October 15, 2008	Sheet	4	of 6

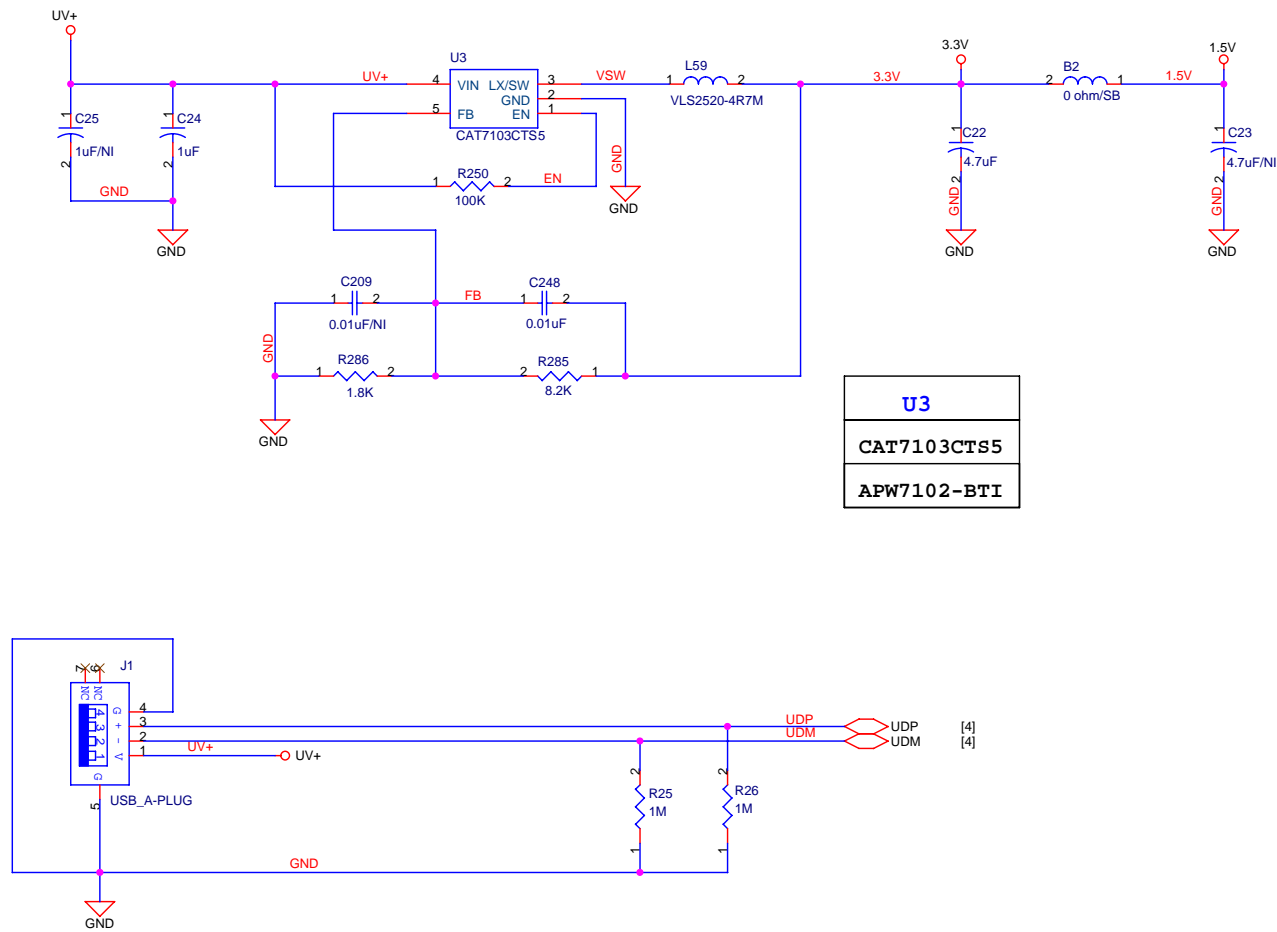

U3
CAT7103CTS5
APW7102-BTI

		RALINK TECHNOLOGY, CORP.	
		Title PEN USB Interface and Power	
Size B	Document Number 4-USB-A.SCH	Rev 3.3	
Date: Tuesday, November 25, 2008	Sheet 5	of 6	