



# FCC RF Test Report

APPLICANT : Texas Instruments  
EQUIPMENT : CC3200STK-WIFIMK  
BRAND NAME : Texas Instruments  
MODEL NAME : CC3200SensorTag  
MARKETING NAME : SimpleLink™ Wi-Fi® Sensor Tag  
FCC ID : Z64-CC3200STK  
STANDARD : FCC Part 15 Subpart C §15.247  
CLASSIFICATION : (DTS) Digital Transmission System

The product was received on Dec. 06, 2016 and testing was completed on Feb. 23, 2017. We, SPORTON INTERNATIONAL INC., would like to declare that the tested sample has been evaluated in accordance with the test procedures and has been in compliance with the applicable technical standards.

The test results in this report apply exclusively to the tested model / sample. Without written approval of SPORTON INTERNATIONAL INC., the test report shall not be reproduced except in full.

Reviewed by: Joseph Lin / Supervisor

Approved by: Jones Tsai / Manager



## SPORTON INTERNATIONAL INC.

No. 52, Hwa Ya 1<sup>st</sup> Rd., Hwa Ya Technology Park, Kwei-Shan District, Tao Yuan City, Taiwan, R.O.C.



# TABLE OF CONTENTS

**REVISION HISTORY..... 3**

**SUMMARY OF TEST RESULT ..... 4**

**1 GENERAL DESCRIPTION ..... 5**

    1.1 Applicant ..... 5

    1.2 Manufacturer ..... 5

    1.3 Product Feature of Equipment Under Test ..... 5

    1.4 Modification of EUT ..... 5

    1.5 Testing Location ..... 6

    1.6 Applicable Standards ..... 6

**2 TEST CONFIGURATION OF EQUIPMENT UNDER TEST ..... 7**

    2.1 Carrier Frequency and Channel ..... 7

    2.2 Test Mode ..... 8

    2.3 Connection Diagram of Test System ..... 9

    2.4 Support Unit used in test configuration and system ..... 10

    2.5 EUT Operation Test Setup ..... 10

    2.6 Measurement Results Explanation Example ..... 10

**3 TEST RESULT ..... 11**

    3.1 6dB and 99% Bandwidth Measurement ..... 11

    3.2 Output Power Measurement ..... 13

    3.3 Power Spectral Density Measurement ..... 14

    3.4 Conducted Band Edges and Spurious Emission Measurement ..... 16

    3.5 Radiated Band Edges and Spurious Emission Measurement ..... 26

    3.6 AC Conducted Emission Measurement ..... 30

    3.7 Antenna Requirements ..... 32

**4 LIST OF MEASURING EQUIPMENT ..... 33**

**5 UNCERTAINTY OF EVALUATION ..... 34**

**APPENDIX A. CONDUCTED TEST RESULTS**

**APPENDIX B. AC CONDUCTED EMISSION TEST RESULT**

**APPENDIX C. RADIATED SPURIOUS EMISSION**

**APPENDIX D. RADIATED SPURIOUS EMISSION PLOTS**

**APPENDIX E. DUTY CYCLE PLOTS**

**APPENDIX F. SETUP PHOTOGRAPHS**



### REVISION HISTORY

REPORT NO.	VERSION	DESCRIPTION	ISSUED DATE
FR6D0643	Rev. 01	Initial issue of report	Feb. 27, 2107



### SUMMARY OF TEST RESULT

Report Section	FCC Rule	Description	Limit	Result	Remark
3.1	15.247(a)(2)	6dB Bandwidth	$\geq 0.5\text{MHz}$	Pass	-
3.1	-	99% Bandwidth	-	Pass	-
3.2	15.247(b)	Power Output Measurement	$\leq 30\text{dBm}$	Pass	-
3.3	15.247(e)	Power Spectral Density	$\leq 8\text{dBm}/3\text{kHz}$	Pass	-
3.4	15.247(d)	Conducted Band Edges	$\leq 20\text{dBc}$	Pass	-
		Conducted Spurious Emission		Pass	-
3.5	15.247(d)	Radiated Band Edges and Radiated Spurious Emission	15.209(a) & 15.247(d)	Pass	Under limit 2.82 dB at 4020.000 MHz
3.6	15.207	AC Conducted Emission	15.207(a)	Pass	Under limit 15.70 dB at 2.750 MHz
3.7	15.203 & 15.247(b)	Antenna Requirement	N/A	Pass	-



# 1 General Description

## 1.1 Applicant

Texas Instruments  
12500 TI BLVD., Dallas Texas, 75243

## 1.2 Manufacturer

Texas Instruments  
12500 TI BLVD., Dallas Texas, 75243

## 1.3 Product Feature of Equipment Under Test

DTS b/g/n

Product Specification subjective to this standard	
Antenna Type	WLAN: PCB Antenna

## 1.4 Modification of EUT

No modifications are made to the EUT during all test items.



### 1.5 Testing Location

Sporton Lab is accredited to ISO 17025 by Taiwan Accreditation Foundation (TAF code : 1190) and the FCC designation No. TW1190 under the FCC 2.948(e) by Mutual Recognition Agreement (MRA) in FCC Test.

<b>Test Site</b>	SPORTON INTERNATIONAL INC.		
<b>Test Site Location</b>	No. 52, Hwa Ya 1 <sup>st</sup> Rd., Hwa Ya Technology Park, Kwei-Shan District, Tao Yuan City, Taiwan, R.O.C. TEL: +886-3-327-3456 FAX: +886-3-328-4978		
<b>Test Site No.</b>	<b>Sporton Site No.</b>		
	TH05-HY	CO05-HY	03CH07-HY

**Note:** The test site complies with ANSI C63.4 2014 requirement.

### 1.6 Applicable Standards

According to the specifications of the manufacturer, the EUT must comply with the requirements of the following standards:

- ♦ FCC Part 15 Subpart C §15.247
- ♦ FCC KDB Publication No. 558074 D01 DTS Meas. Guidance v03r05
- ♦ ANSI C63.10-2013

**Remark:**

1. All test items were verified and recorded according to the standards and without any deviation during the test.
2. This EUT has also been tested and complied with the requirements of FCC Part 15, Subpart B, recorded in a separate test report.



## 2 Test Configuration of Equipment Under Test

- a. The EUT has been associated with peripherals and configuration operated in a manner tended to maximize its emission characteristics in a typical application. Frequency range investigated: conduction emission (150 kHz to 30 MHz), radiation emission (9 kHz to the 10th harmonic of the highest fundamental frequency or to 40 GHz, whichever is lower).
  
- b. AC power line Conducted Emission was tested under maximum output power.

### 2.1 Carrier Frequency and Channel

Frequency Band	Channel	Freq. (MHz)	Channel	Freq. (MHz)
2400-2483.5 MHz	1	2412	7	2442
	2	2417	8	2447
	3	2422	9	2452
	4	2427	10	2457
	5	2432	11	2462
	6	2437	-	-



## 2.2 Test Mode

Final test mode of conducted test items and radiated spurious emissions are considering the modulation and worse data rates as below table.

Modulation	Data Rate
802.11b	1 Mbps
802.11g	6 Mbps
802.11n HT20	MCS0

Test Cases	
AC Conducted Emission	Mode 1: WLAN Idle + USB Cable(Charging from Notebook)



## 2.3 Connection Diagram of Test System

<WLAN Tx Mode>

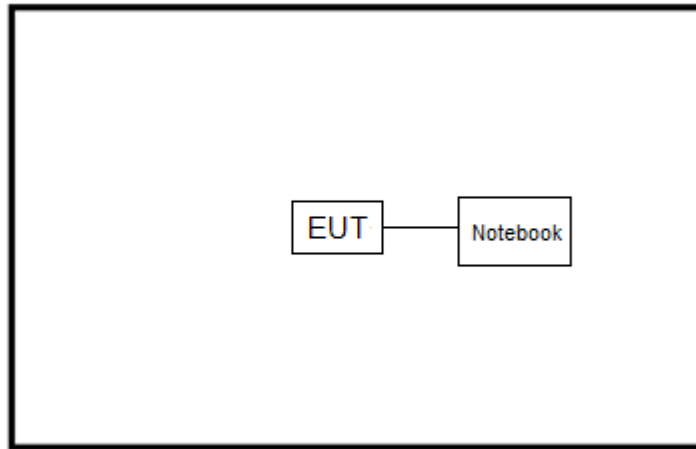

<AC Conducted Emission Mode>

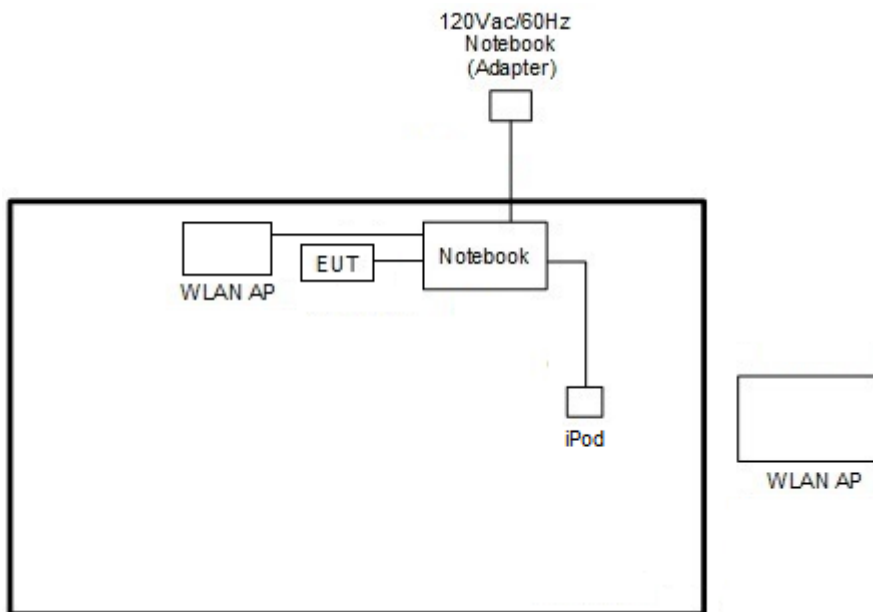



### 2.4 Support Unit used in test configuration and system

Item	Equipment	Trade Name	Model Name	FCC ID	Data Cable	Power Cord
1.	WLAN AP	ASUS	RT-AC66U	MSQ-RTAC66U	N/A	Unshielded, 1.8 m
2.	WLAN AP	D-Link	DIR-628	KA2DIR628A2	N/A	Unshielded, 1.8 m
3.	iPod	Apple	A1285	FCC DoC	Shielded, 1.0 m	N/A
4.	Notebook	DELL	Latitude E3340	FCC DoC/ Contains FCC ID: PD97260NGU	N/A	AC I/P: Unshielded, 1.2 m DC O/P: Shielded, 1.8 m

### 2.5 EUT Operation Test Setup

For WLAN function, programmed RF utility, "Tool" installed in the notebook make the EUT provide functions like channel selection and power level for continuous transmitting and receiving signals.

### 2.6 Measurement Results Explanation Example

For all conducted test items:

The offset level is set in the spectrum analyzer to compensate the RF cable loss and attenuator factor between EUT conducted output port and spectrum analyzer. With the offset compensation, the spectrum analyzer reading level is exactly the EUT RF output level.

Example :

The spectrum analyzer offset is derived from RF cable loss and attenuator factor.

$$\text{Offset} = \text{RF cable loss} + \text{attenuator factor}.$$

Following shows an offset computation example with cable loss 4.2 dB and 10dB attenuator.

$$\begin{aligned} \text{Offset(dB)} &= \text{RF cable loss(dB)} + \text{attenuator factor(dB)}. \\ &= 4.2 + 10 = 14.2 \text{ (dB)} \end{aligned}$$

### 3 Test Result

#### 3.1 6dB and 99% Bandwidth Measurement

##### 3.1.1 Limit of 6dB and 99% Bandwidth

The minimum 6 dB bandwidth shall be at least 500 kHz.

##### 3.1.2 Measuring Instruments

The measuring equipment is listed in the section 4 of this test report.

##### 3.1.3 Test Procedures

1. The testing follows FCC KDB Publication No. 558074 DTS D01 Meas. Guidance v03r05.
2. The RF output of EUT was connected to the spectrum analyzer by RF cable and attenuator. The path loss was compensated to the results for each measurement.
3. Set to the maximum power setting and enable the EUT transmit continuously.
4. Make the measurement with the spectrum analyzer's resolution bandwidth (RBW) = 100 kHz. Set the Video bandwidth (VBW) = 300 kHz. In order to make an accurate measurement. The 6 dB bandwidth must be greater than 500 kHz.
5. For 99% Bandwidth Measurement, the spectrum analyzer's resolution bandwidth (RBW) = 1MHz and set the Video bandwidth (VBW) = 3MHz.
6. Measure and record the results in the test report.

##### 3.1.4 Test Setup





### 3.1.5 Test Result of 6dB and 99% Occupied Bandwidth

Please refer to Appendix A.

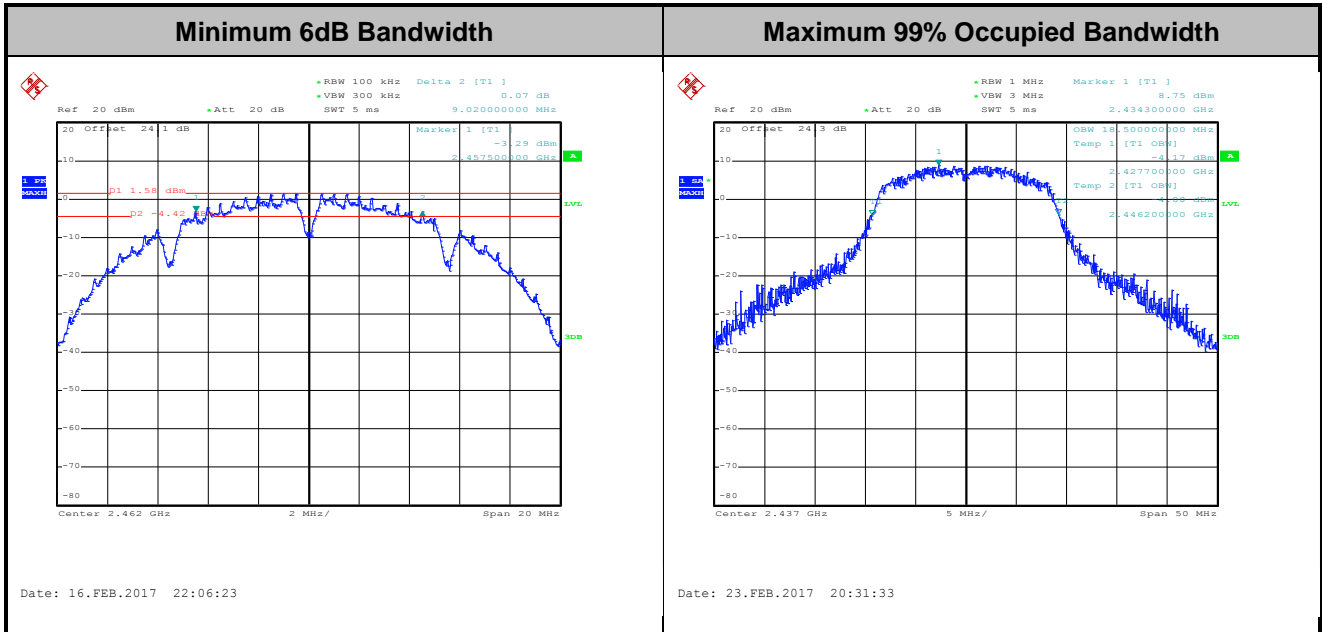

Note : The occupied channel bandwidth is maintained within the band of operation for all of the modulations.

## 3.2 Output Power Measurement

### 3.2.1 Limit of Output Power

For systems using digital modulation in the 2400-2483.5MHz, the limit for peak output power is 30dBm. If transmitting antenna of directional gain greater than 6dBi are used the peak output power from the intentional radiator shall be reduced below the above stated value by the amount in dB that the directional gain of the antenna exceeds 6 dBi. In case of point-to-point operation, the limit has to be reduced by 1dB for every 3dB that the directional gain of the antenna exceeds 6dBi.

### 3.2.2 Measuring Instruments

The measuring equipment is listed in the section 4 of this test report.

### 3.2.3 Test Procedures

1. The testing follows the Measurement Procedure of FCC KDB No. 558074 DTS D01 Meas. Guidance v03r05 section 9.1.2 PKPM1 Peak power meter method.
2. The RF output of EUT was connected to the power meter by RF cable and attenuator. The path loss was compensated to the results for each measurement.
3. Set to the maximum power setting and enable the EUT transmit continuously.
4. Measure the conducted output power and record the results in the test report.

### 3.2.4 Test Setup

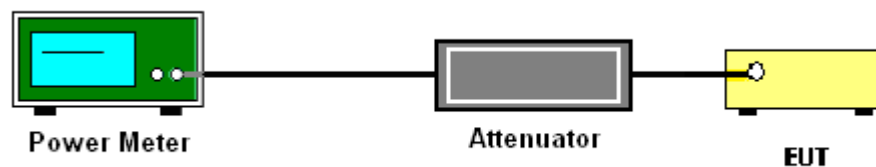

### 3.2.5 Test Result of Peak Output Power

Please refer to Appendix A.

### 3.2.6 Test Result of Average output Power (Reporting Only)

Please refer to Appendix A.

### 3.3 Power Spectral Density Measurement

#### 3.3.1 Limit of Power Spectral Density

The peak power spectral density shall not be greater than 8dBm in any 3kHz band at any time interval of continuous transmission.

#### 3.3.2 Measuring Instruments

The measuring equipment is listed in the section 4 of this test report.

#### 3.3.3 Test Procedures

1. The testing follows Measurement Procedure 10.2 Method PKPSD of FCC KDB Publication No. 558074 D01 DTS Meas. Guidance v03r05
2. The RF output of EUT was connected to the spectrum analyzer by RF cable and attenuator. The path loss was compensated to the results for each measurement.
3. Set to the maximum power setting and enable the EUT transmit continuously.
4. Make the measurement with the spectrum analyzer's resolution bandwidth (RBW) = 3 kHz. Video bandwidth VBW = 10 kHz In order to make an accurate measurement, set the span to 1.5 times DTS Channel Bandwidth. (6dB BW)
5. Detector = peak, Sweep time = auto couple, Trace mode = max hold, Allow trace to fully stabilize. Use the peak marker function to determine the maximum power level.
6. Measure and record the results in the test report.

#### 3.3.4 Test Setup





### 3.3.5 Test Result of Power Spectral Density

Please refer to Appendix A.

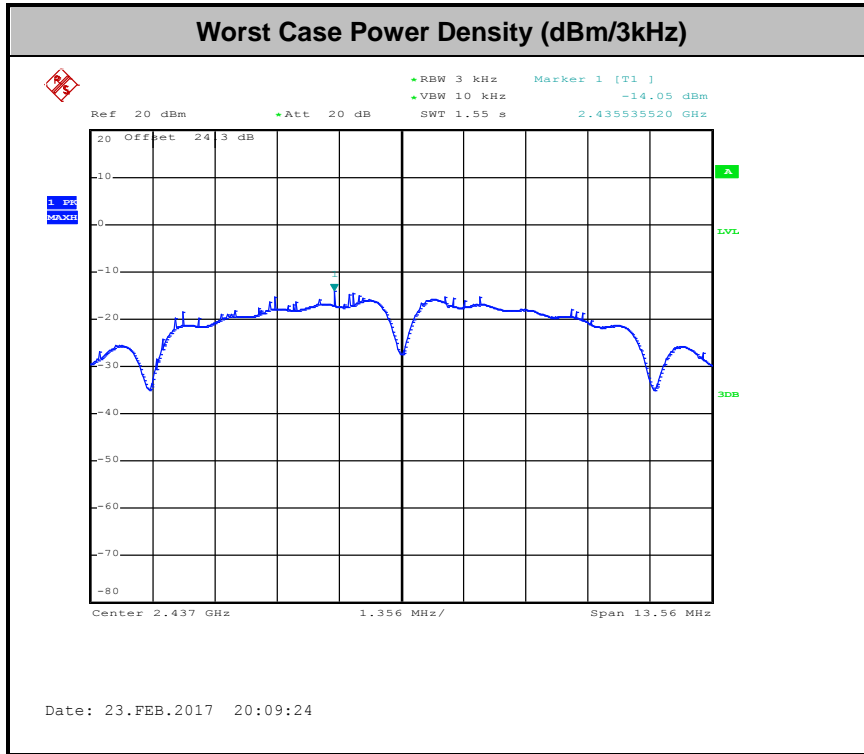

## 3.4 Conducted Band Edges and Spurious Emission Measurement

### 3.4.1 Limit of Conducted Band Edges and Spurious Emission Measurement

In any 100 kHz bandwidth outside of the authorized frequency band, the emissions which fall in the non-restricted bands shall be attenuated at least 20 dB / 30dB relative to the maximum PSD level in 100 kHz by RF conducted measurement and radiated emissions which fall in the restricted bands, as defined in Section 15.205(a), must also comply with the radiated emission limits specified in Section 15.209(a).

### 3.4.2 Measuring Instruments

The measuring equipment is listed in the section 4 of this test report.

### 3.4.3 Test Procedures

1. The testing follows FCC KDB Publication No. 558074 D01 DTS Meas. Guidance v03r05.
2. The RF output of EUT was connected to the spectrum analyzer by RF cable and attenuator. The path loss was compensated to the results for each measurement.
3. Set to the maximum power setting and enable the EUT transmit continuously.
4. Set RBW = 100 kHz, VBW=300 kHz, Peak Detector. Unwanted Emissions measured in any 100 kHz bandwidth outside of the authorized frequency band shall be attenuated by at least 20 dB relative to the maximum in-band peak PSD level in 100 kHz when maximum peak conducted output power procedure is used. If the transmitter complies with the conducted power limits based on the use of RMS averaging over a time interval, the attenuation required under this paragraph shall be 30 dB instead of 20 dB per 15.247(d).
5. Measure and record the results in the test report.
6. The RF fundamental frequency should be excluded against the limit line in the operating frequency band.

### 3.4.4 Test Setup

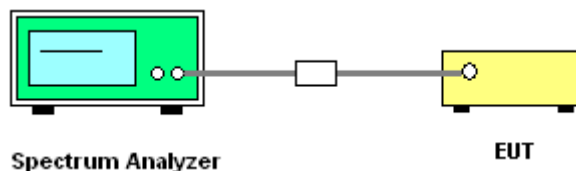





### 3.4.5 Test Result of Conducted Band Edges and Spurious Emission

Test Mode :	802.11b	Temperature :	21~26°C
Test Band :	2.4GHz Low	Relative Humidity :	45~54%
Test Channel :	01	Test Engineer :	Aking Chang

#### WLAN 802.11b Channel 01

<b>100kHz PSD reference Level</b>	<b>Low Channel Plot</b>
-----------------------------------	-------------------------

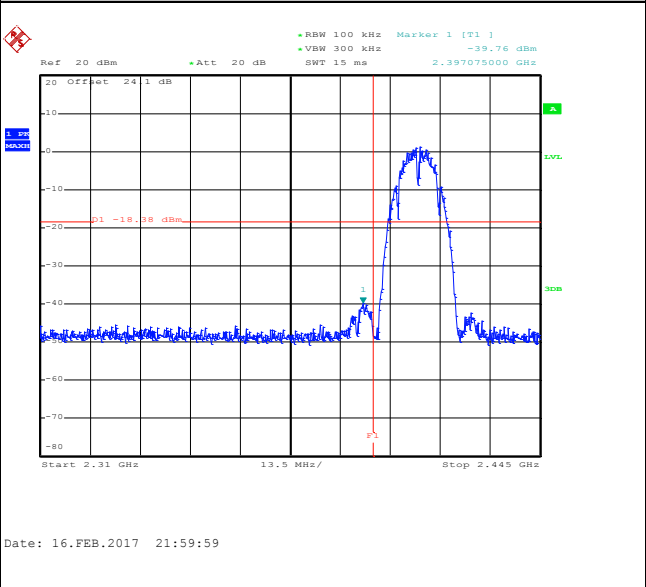
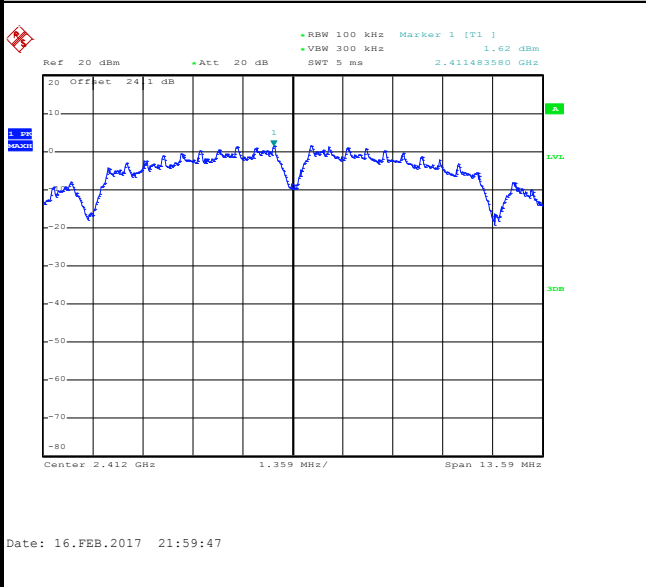

#### Spurious Emission 30MHz~3GHz

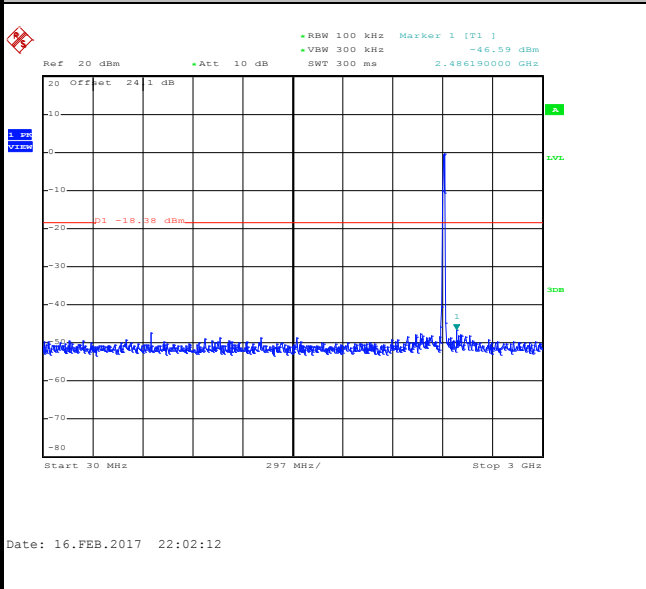

#### Spurious Emission 2GHz~25GHz

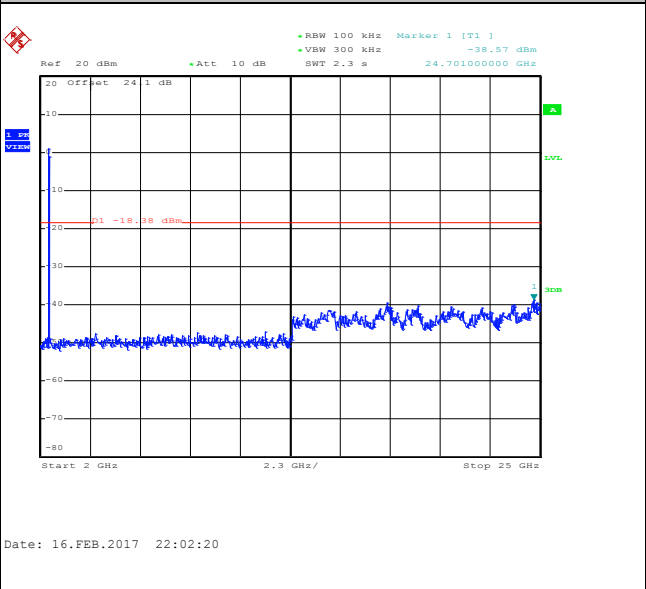



Test Mode :	802.11b	Temperature :	21~26°C
Test Band :	2.4GHz Mid	Relative Humidity :	45~54%
Test Channel :	06	Test Engineer :	Aking Chang

WLAN 802.11b Channel 06

100kHz PSD reference Level

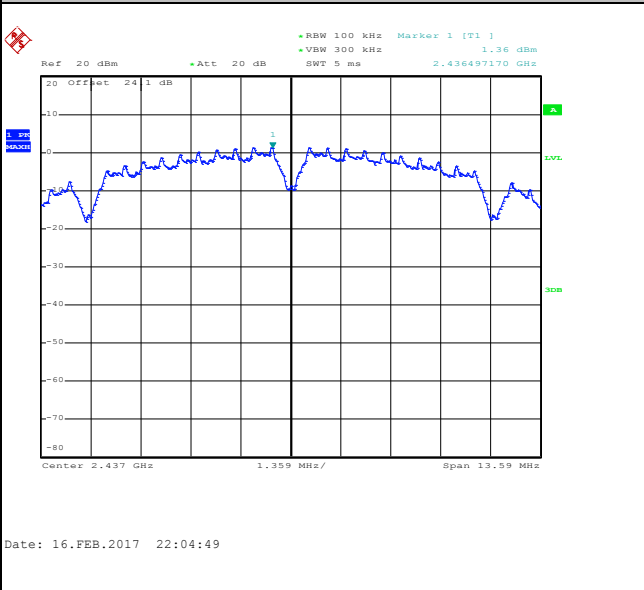

Spurious Emission 30MHz~3GHz

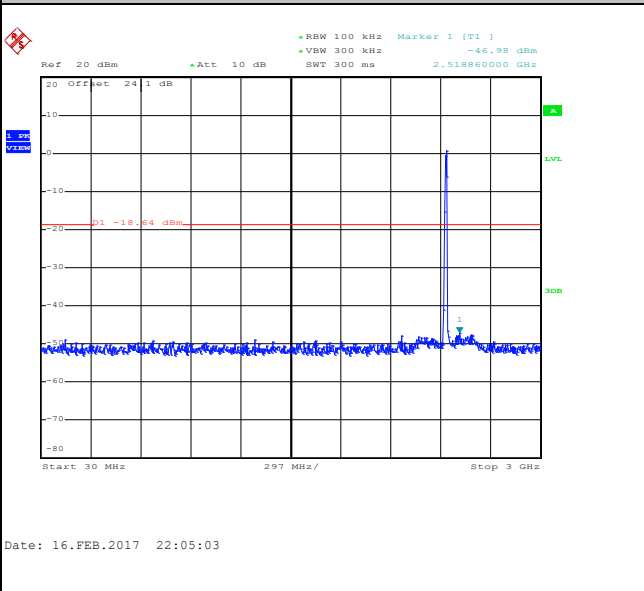

Spurious Emission 2GHz~25GHz

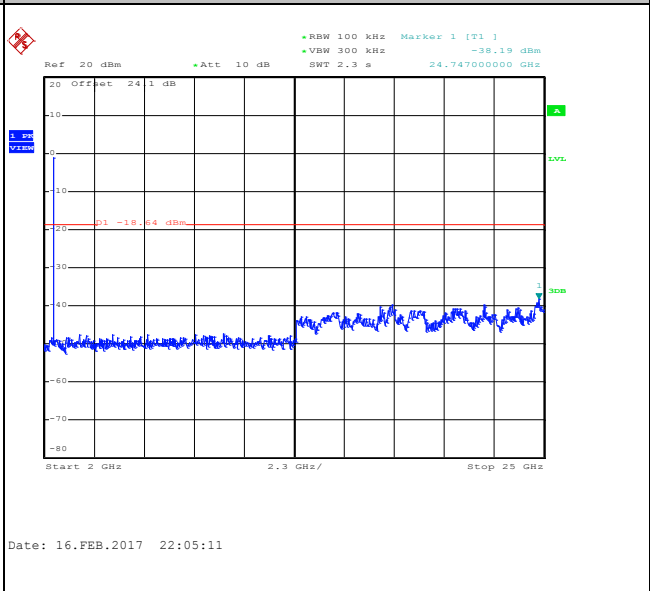



Test Mode :	802.11b	Temperature :	21~26°C
Test Band :	2.4GHz High	Relative Humidity :	45~54%
Test Channel :	11	Test Engineer :	Aking Chang

WLAN 802.11b Channel 11

100kHz PSD reference Level

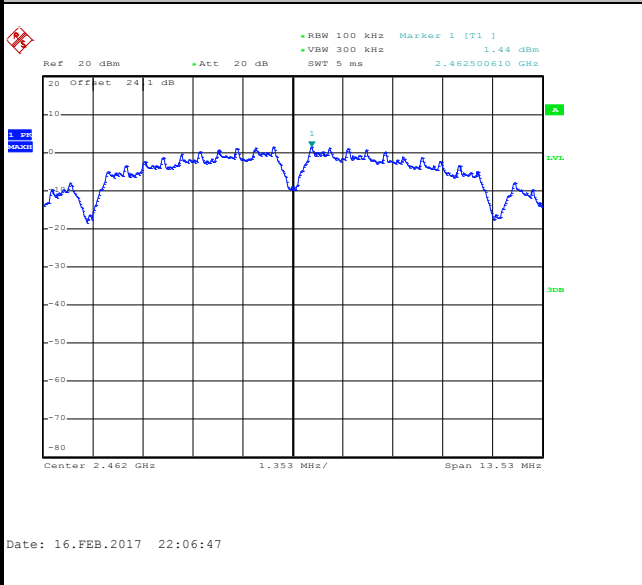

High Channel Plot

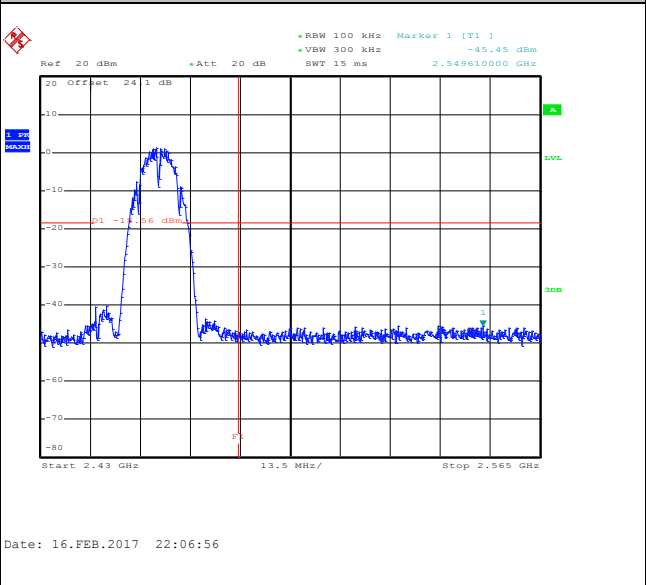

Spurious Emission 30MHz~3GHz

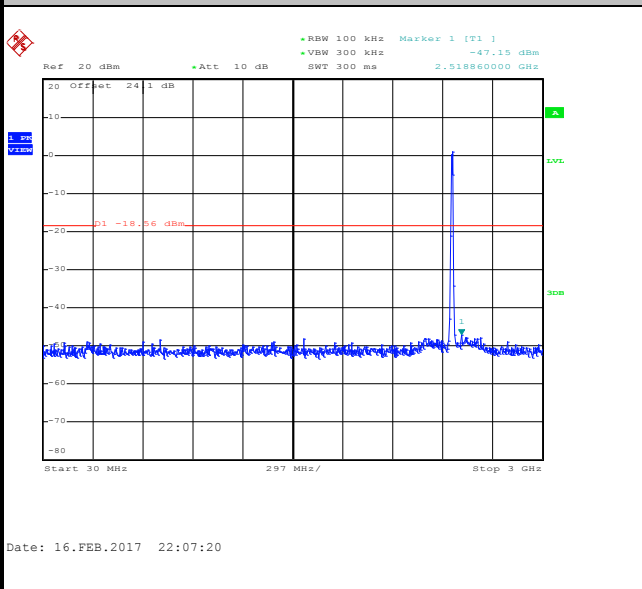

Spurious Emission 2GHz~25GHz

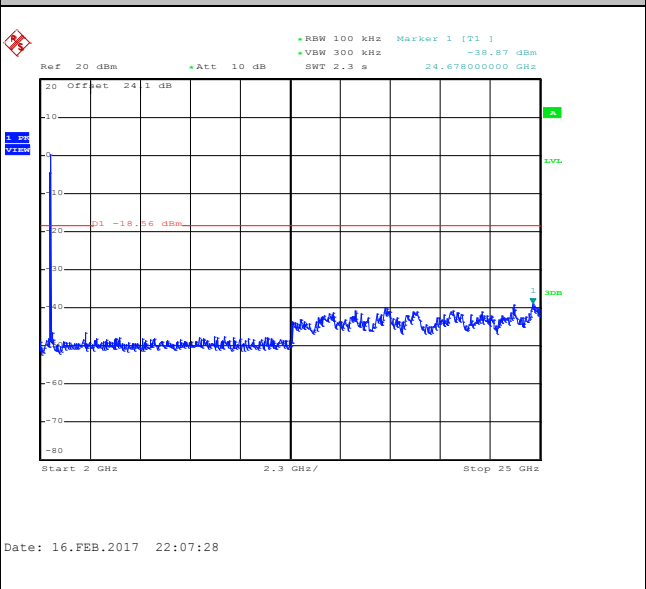



Test Mode :	802.11g	Temperature :	21~26°C
Test Band :	2.4GHz Low	Relative Humidity :	45~54%
Test Channel :	01	Test Engineer :	Aking Chang

WLAN 802.11g Channel 01

100kHz PSD reference Level

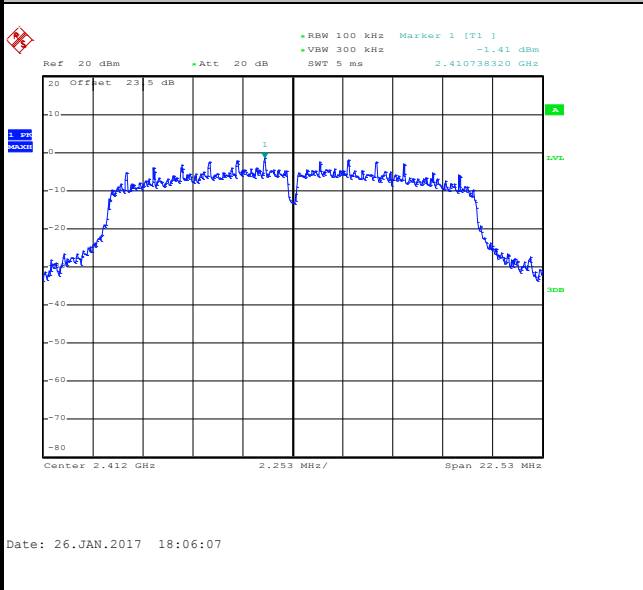

Low Channel Plot

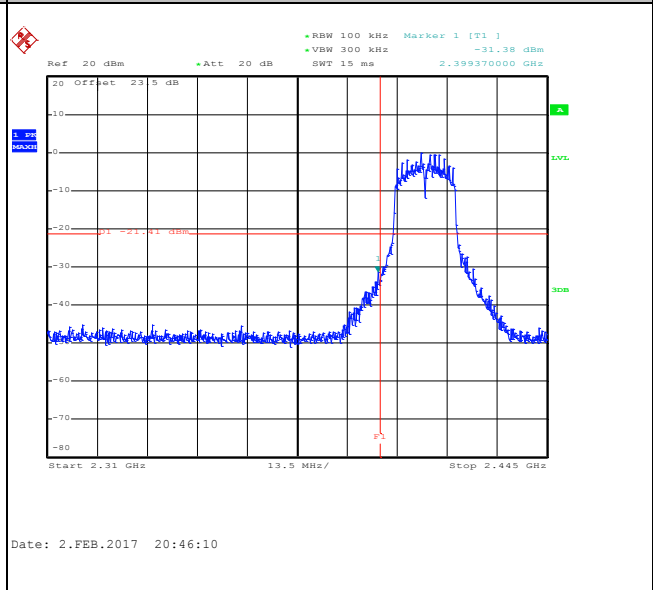

Spurious Emission 30MHz~3GHz

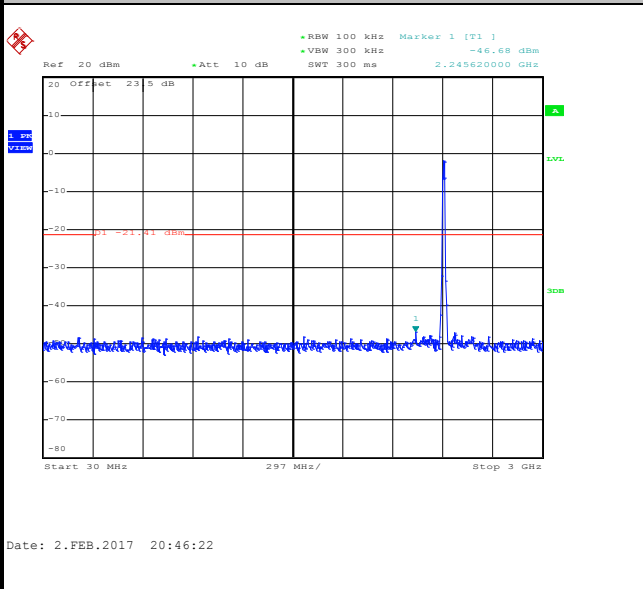

Spurious Emission 2GHz~25GHz

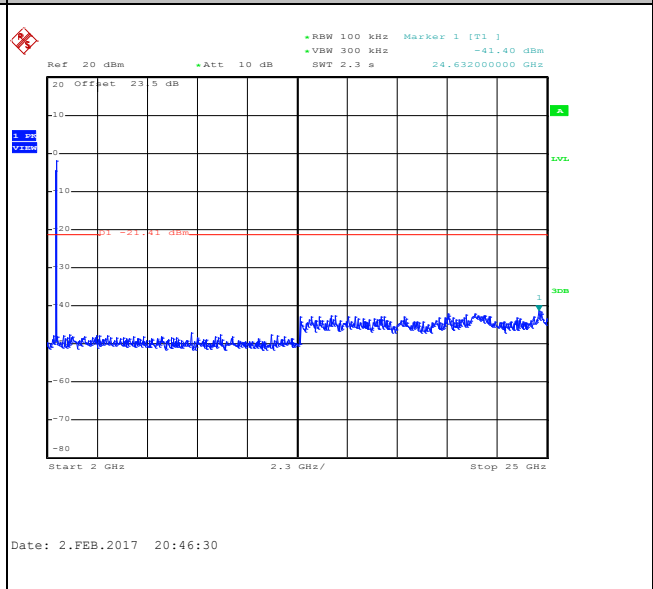



Test Mode :	802.11g	Temperature :	21~26°C
Test Band :	2.4GHz Mid	Relative Humidity :	45~54%
Test Channel :	06	Test Engineer :	Aking Chang

WLAN 802.11g Channel 06

100kHz PSD reference Level

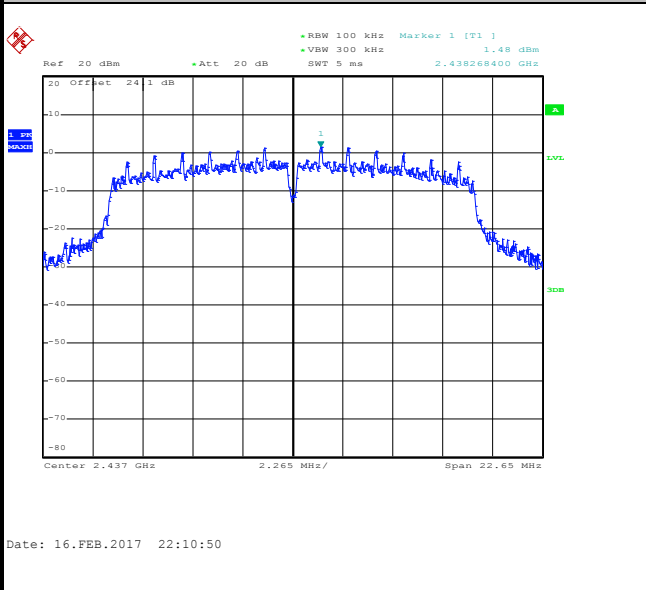

Spurious Emission 30MHz~3GHz

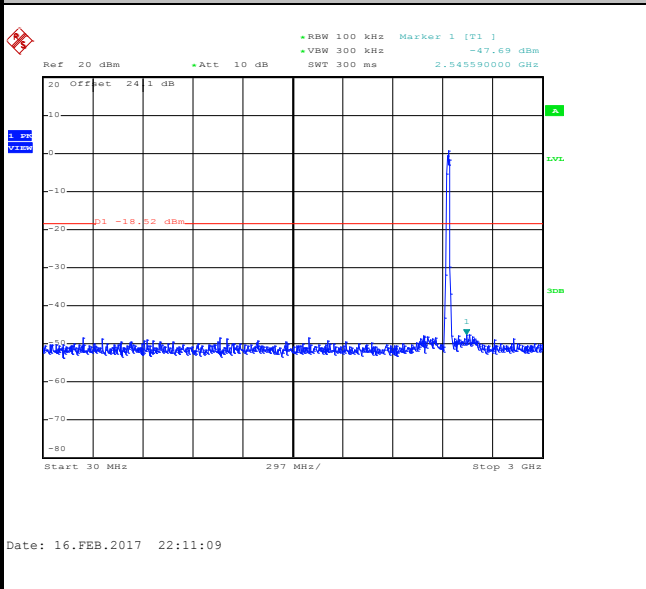

Spurious Emission 2GHz~25GHz

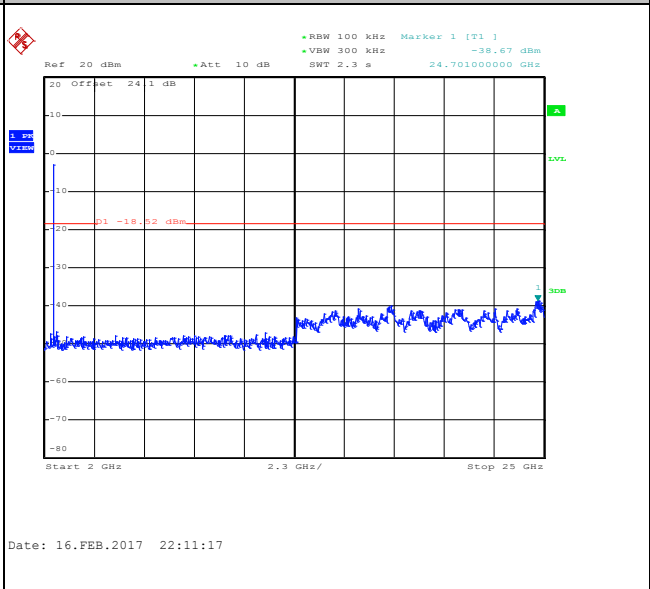



Test Mode :	802.11g	Temperature :	21~26°C
Test Band :	2.4GHz High	Relative Humidity :	45~54%
Test Channel :	11	Test Engineer :	Aking Chang

WLAN 802.11g Channel 11

100kHz PSD reference Level

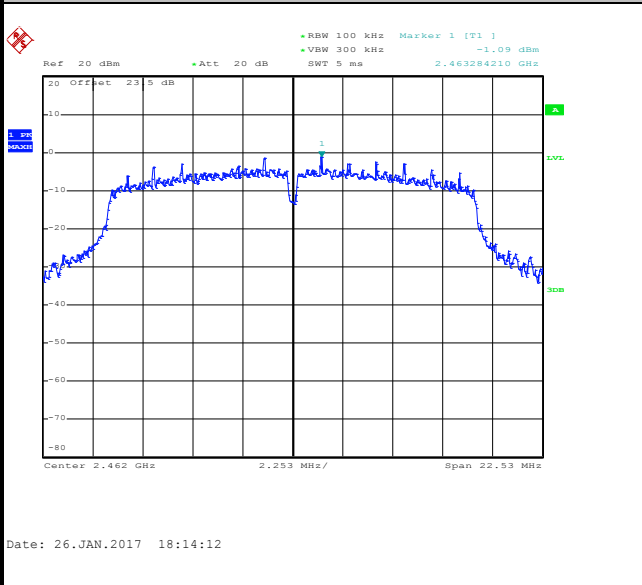

High Channel Plot

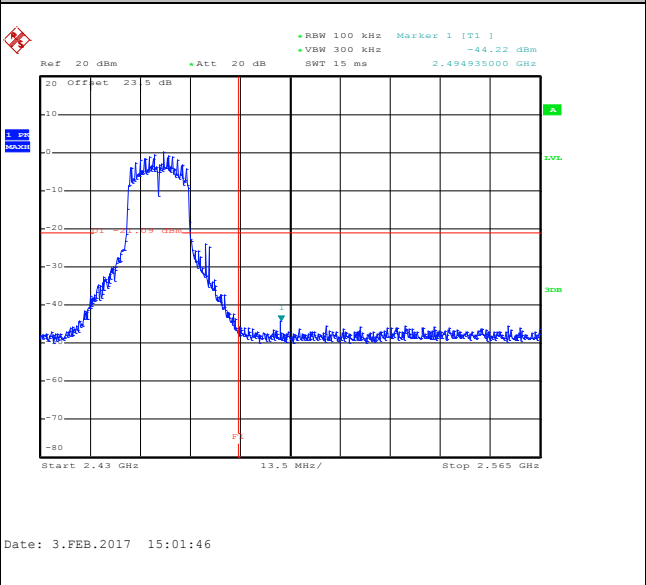

Spurious Emission 30MHz~3GHz

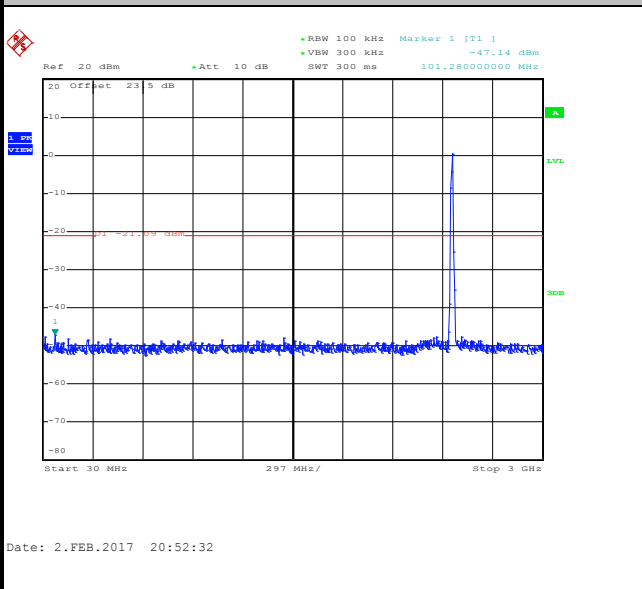

Spurious Emission 2GHz~25GHz

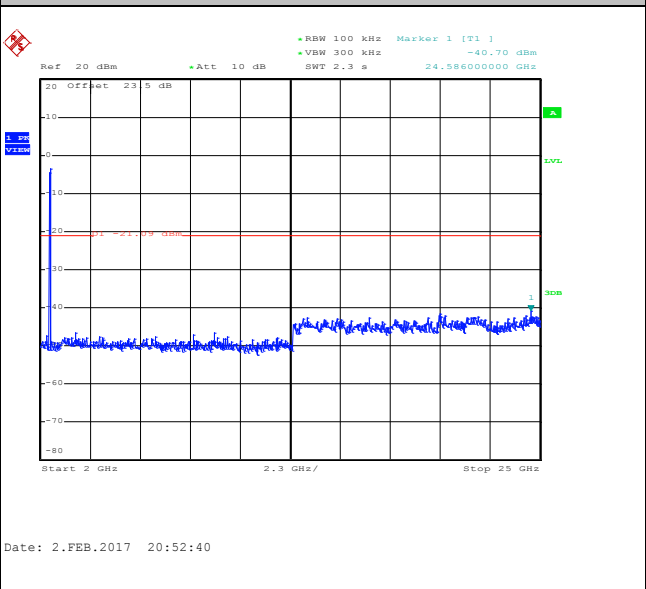



Test Mode :	802.11n HT20	Temperature :	21~26°C
Test Band :	2.4GHz Low	Relative Humidity :	45~54%
Test Channel :	01	Test Engineer :	Aking Chang

WLAN 802.11n HT20 Channel 01

100kHz PSD reference Level

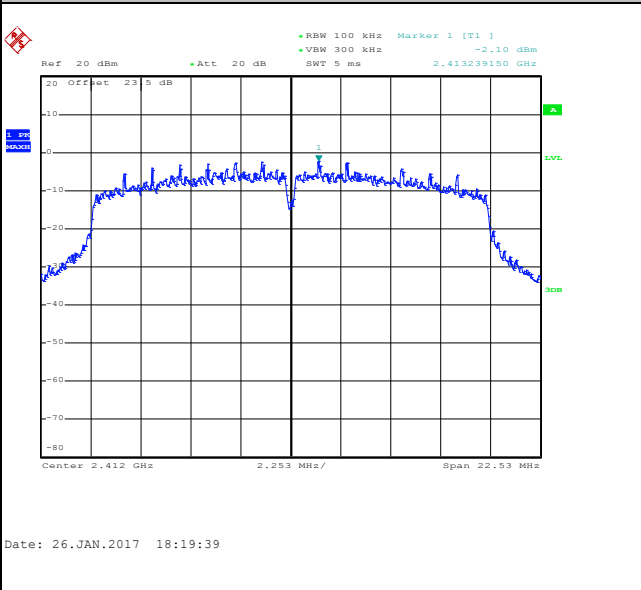

Low Channel Plot

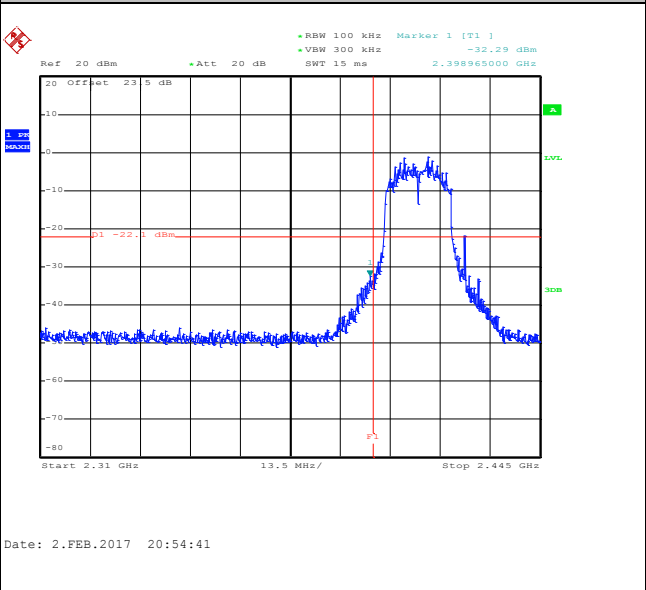

Spurious Emission 30MHz~3GHz

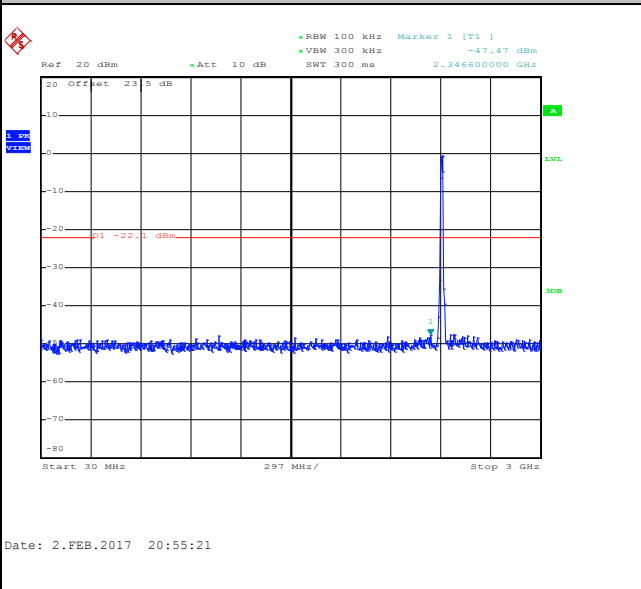

Spurious Emission 2GHz~25GHz

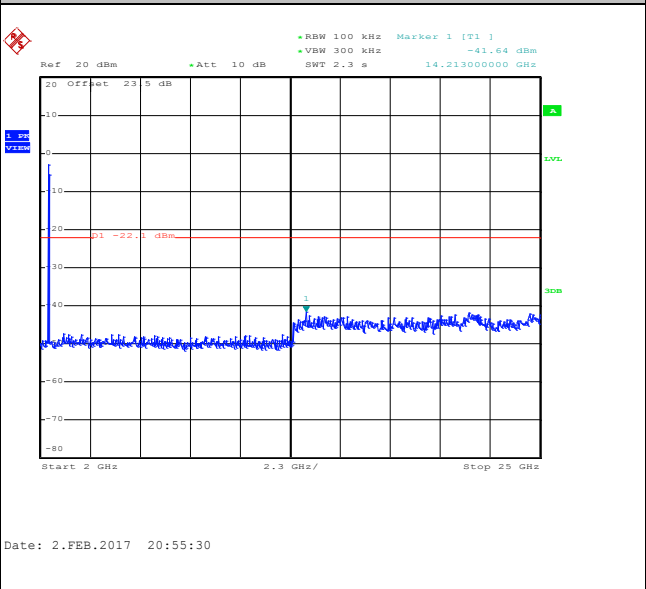



Test Mode :	802.11n HT20	Temperature :	21~26°C
Test Band :	2.4GHz Mid	Relative Humidity :	45~54%
Test Channel :	06	Test Engineer :	Aking Chang

WLAN 802.11n HT20 Channel 06

100kHz PSD reference Level

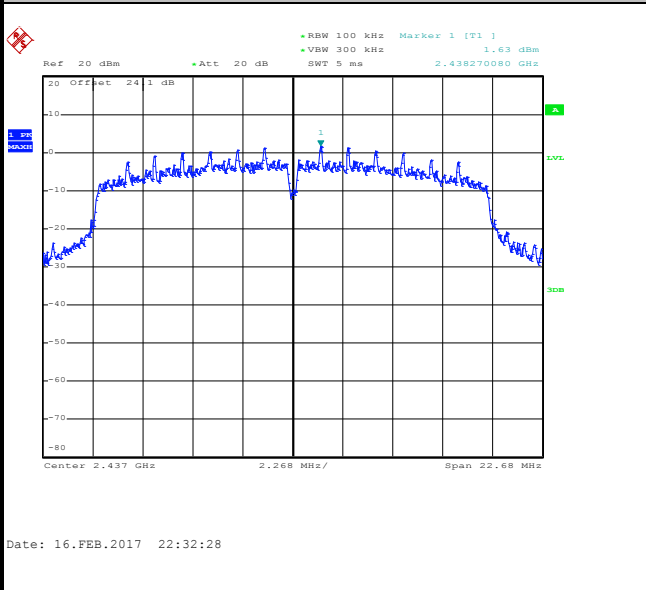

Spurious Emission 30MHz~3GHz

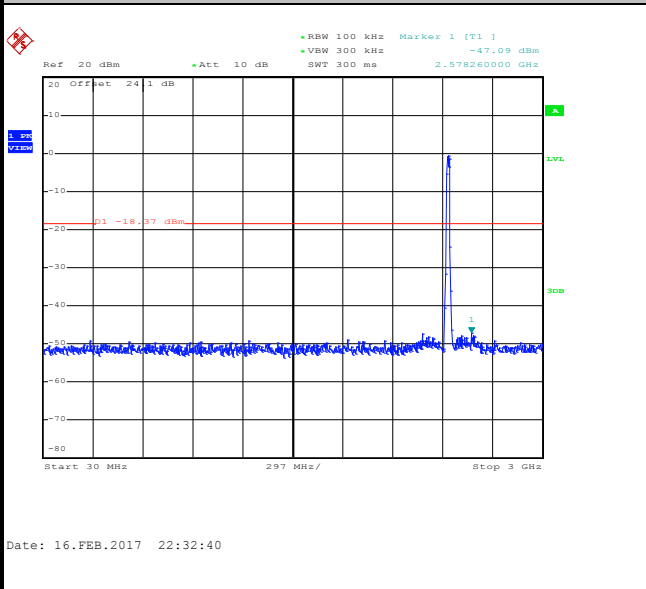

Spurious Emission 2GHz~25GHz

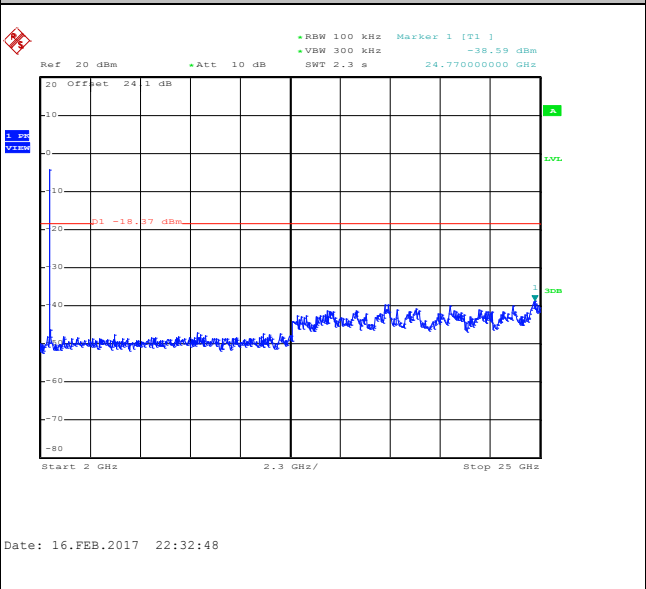





Test Mode :	802.11n HT20	Temperature :	21~26°C
Test Band :	2.4GHz High	Relative Humidity :	45~54%
Test Channel :	11	Test Engineer :	Aking Chang

WLAN 802.11n HT20 Channel 11

100kHz PSD reference Level

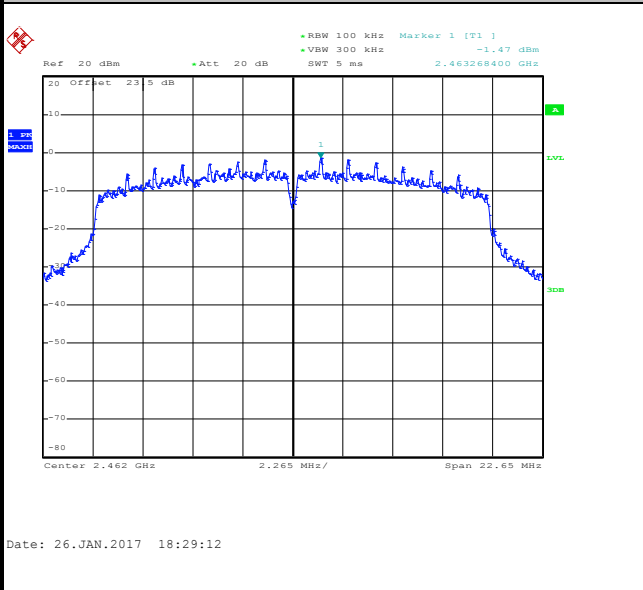

High Channel Plot

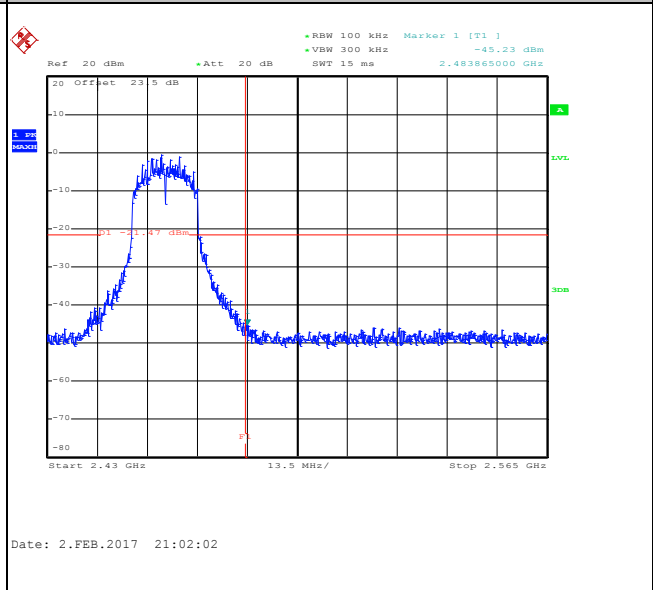

Spurious Emission 30MHz~3GHz

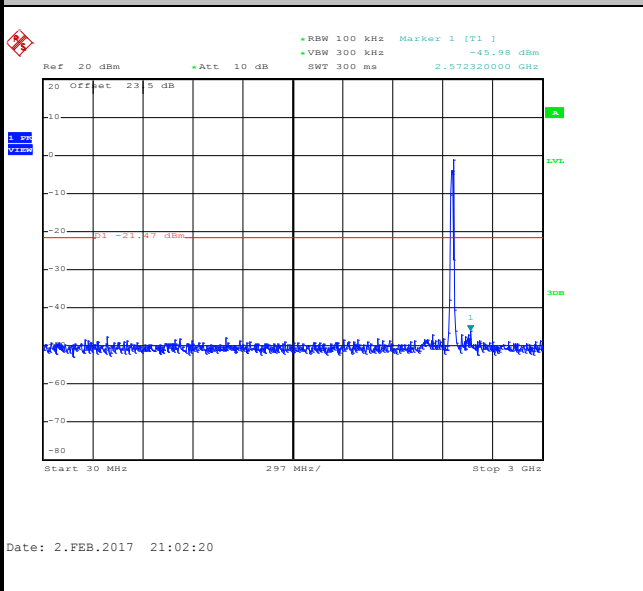

Spurious Emission 2GHz~25GHz

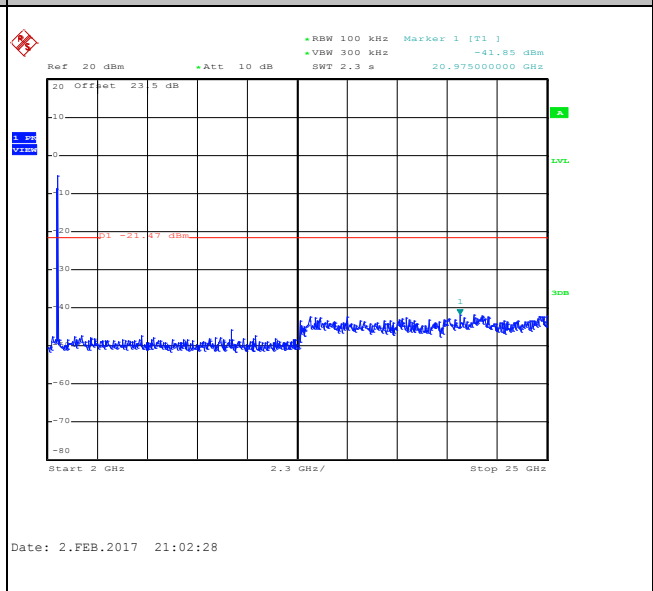



### 3.5 Radiated Band Edges and Spurious Emission Measurement

#### 3.5.1 Limit of Radiated band edge and Spurious Emission Measurement

In any 100 kHz bandwidth outside the intentional radiator frequency band, all harmonics/spurious must be at least 20 dB below the highest emission level within the authorized band. If the output power of this device was measured by spectrum analyzer, the attenuation under this paragraph shall be 30 dB instead of 20 dB. In addition, radiated emissions which fall in the restricted bands must also comply with the FCC section 15.209 limits as below.

Frequency (MHz)	Field Strength (microvolts/meter)	Measurement Distance (meters)
0.009 – 0.490	2400/F(kHz)	300
0.490 – 1.705	24000/F(kHz)	30
1.705 – 30.0	30	30
30 – 88	100	3
88 – 216	150	3
216 - 960	200	3
Above 960	500	3

#### 3.5.2 Measuring Instruments

The measuring equipment is listed in the section 4 of this test report.



### **3.5.3 Test Procedures**

1. The testing follows FCC KDB Publication No. 558074 D01 DTS Meas. Guidance v03r05.
2. The EUT was arranged to its worst case and then tune the antenna tower (from 1 m to 4 m) and turntable (from 0 degree to 360 degrees) to find the maximum reading. A pre-amp and a high pass filter are used for the test in order to get better signal level.
3. The EUT was placed on a turntable with 0.8 meter for frequency below 1GHz and 1.5 meter for frequency above 1GHz respectively above ground.
4. The EUT was set 3 meters from the interference receiving antenna, which was mounted on the top of a variable height antenna tower.
5. Corrected Reading: Antenna Factor + Cable Loss + Read Level - Preamp Factor = Level
6. For measurement below 1GHz, If the emission level of the EUT measured by the peak detector is 3 dB lower than the applicable limit, the peak emission level will be reported. Otherwise, the emission measurement will be repeated using the quasi-peak detector and reported.
7. Use the following spectrum analyzer settings:
  - (1) Span shall wide enough to fully capture the emission being measured;
  - (2) Set RBW=100 kHz for  $f < 1$  GHz; VBW  $\geq$  RBW; Sweep = auto; Detector function = peak; Trace = max hold;
  - (3) Set RBW = 1 MHz, VBW= 3MHz for  $f \geq 1$  GHz for peak measurement.  
For average measurement:
    - VBW = 10 Hz, when duty cycle is no less than 98 percent.
    - VBW  $\geq 1/T$ , when duty cycle is less than 98 percent where T is the minimum transmission duration over which the transmitter is on and is transmitting at its maximum power control level for the tested mode of operation.

### 3.5.4 Test Setup

For radiated emissions below 30MHz



For radiated emissions from 30MHz to 1GHz

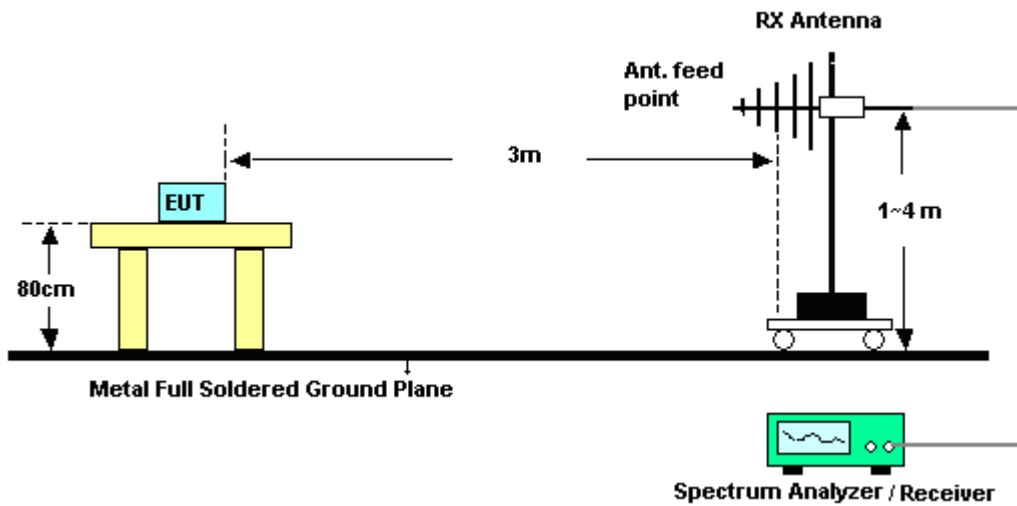

For radiated emissions above 1GHz

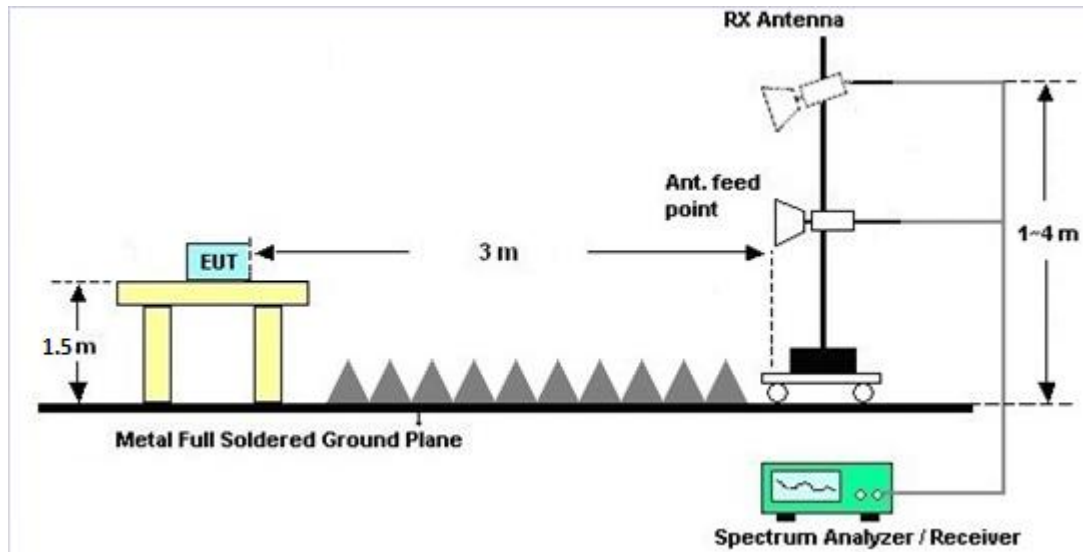

### 3.5.5 Test Results of Radiated Spurious Emissions (9kHz ~ 30MHz)

The low frequency, which started from 9 kHz to 30MHz, was pre-scanned and the result which was 20dB lower than the limit line per 15.31(o) was not reported.

### 3.5.6 Test Result of Radiated Spurious at Band Edges

Please refer to Appendix C and D.

### 3.5.7 Duty Cycle

Please refer to Appendix E.

### 3.5.8 Test Result of Radiated Spurious Emission (30MHz ~ 10<sup>th</sup> Harmonic)

Please refer to Appendix C and D.



### 3.6 AC Conducted Emission Measurement

#### 3.6.1 Limit of AC Conducted Emission

For equipment that is designed to be connected to the public utility (AC) power line, the radio frequency voltage that is conducted back onto the AC power line on any frequency or frequencies within the band 150 kHz to 30 MHz shall not exceed the limits in the following table.

Frequency of Emission (MHz)	Conducted Limit (dBµV)	
	Quasi-Peak	Average
0.15-0.5	66 to 56*	56 to 46*
0.5-5	56	46
5-30	60	50

\*Decreases with the logarithm of the frequency.

#### 3.6.2 Measuring Instruments

The measuring equipment is listed in the section 4 of this test report.

#### 3.6.3 Test Procedures

1. The EUT was placed 0.4 meter from the conducting wall of the shielding room, and it was kept at least 80 centimeters from any other grounded conducting surface.
2. Connect EUT to the power mains through a line impedance stabilization network (LISN).
3. All the support units are connecting to the other LISN.
4. The LISN provides 50 ohm coupling impedance for the measuring instrument.
5. The FCC states that a 50 ohm, 50 microhenry LISN should be used.
6. Both sides of AC line were checked for maximum conducted interference.
7. The frequency range from 150 kHz to 30 MHz was searched.
8. Set the test-receiver system to Peak Detect Function and specified bandwidth (IF bandwidth = 9kHz) with Maximum Hold Mode.

### 3.6.4 Test Setup

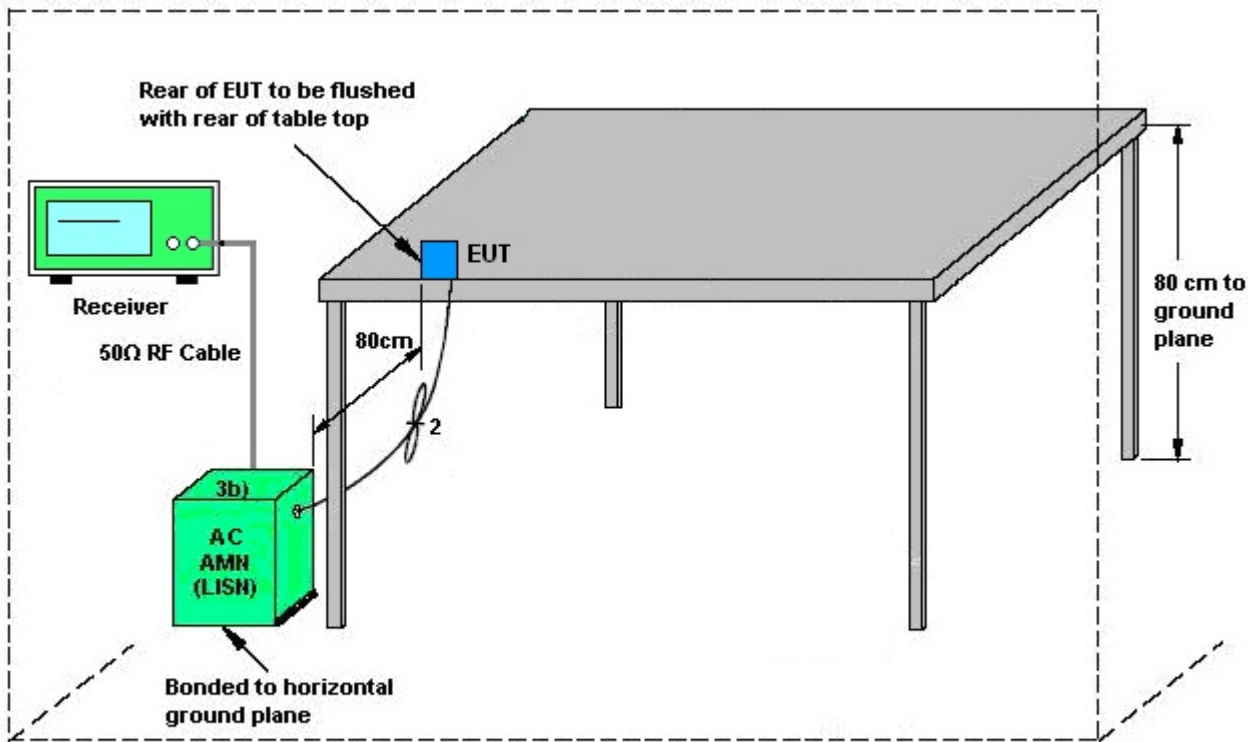

AMN = Artificial mains network (LISN)  
AE = Associated equipment  
EUT = Equipment under test  
ISN = Impedance stabilization network

### 3.6.5 Test Result of AC Conducted Emission

Please refer to Appendix B.



## **3.7 Antenna Requirements**

### **3.7.1 Standard Applicable**

If directional gain of transmitting antennas is greater than 6dBi, the power shall be reduced by the same level in dB comparing to gain minus 6dBi. For the fixed point-to-point operation, the power shall be reduced by one dB for every 3 dB that the directional gain of the antenna exceeds 6 dBi. The use of a permanently attached antenna or of an antenna that uses a unique coupling to the intentional radiator shall be considered sufficient to comply with the FCC rule.

### **3.7.2 Antenna Anti-Replacement Construction**

An embedded-in antenna design is used.

### **3.7.3 Antenna Gain**

The antenna peak gain of EUT is less than 6 dBi. Therefore, it is not necessary to reduce maximum peak output power limit.





## 4 List of Measuring Equipment

Instrument	Manufacturer	Model No.	Serial No.	Characteristics	Calibration Date	Test Date	Due Date	Remark
Power Meter	Anritsu	ML2495A	0932001	300MHz~40GHz	Sep. 29, 2016	Jan. 17, 2017 ~ Feb. 23, 2017	Sep. 28, 2017	Conducted (TH05-HY)
Power Sensor	Anritsu	MA2411B	0846202	300MHz~40GHz	Sep. 29, 2016	Jan. 17, 2017 ~ Feb. 23, 2017	Sep. 28, 2017	Conducted (TH05-HY)
Spectrum Analyzer	Rohde & Schwarz	FSP40	100055	9kHz-40GHz	Jul. 17, 2016	Jan. 17, 2017 ~ Feb. 23, 2017	Jul. 16, 2017	Conducted (TH05-HY)
AC Power Source	ChainTek	APC-1000W	N/A	N/A	N/A	Jan. 25, 2017	N/A	Conduction (CO05-HY)
EMI Test Receiver	Rohde & Schwarz	ESCI 7	100724	9kHz~7GHz	Aug. 30, 2016	Jan. 25, 2017	Aug. 29, 2017	Conduction (CO05-HY)
LISN	Rohde & Schwarz	ENV216	100080	9kHz~30MHz	Nov. 29, 2016	Jan. 25, 2017	Nov. 28, 2017	Conduction (CO05-HY)
LISN	Rohde & Schwarz	ENV216	100081	9kHz~30MHz	Dec. 06, 2016	Jan. 25, 2017	Dec. 05, 2017	Conduction (CO05-HY)
LF Cable	HUBER + SUHNER	RG-214/U	LF01	N/A	Jan. 05, 2017	Jan. 25, 2017	Jan. 04, 2018	Conduction (CO05-HY)
Pulse Limiter	Rohde & Schwarz	ESH3-Z2	100851	N/A	Jan. 05, 2017	Jan. 25, 2017	Jan. 04, 2018	Conduction (CO05-HY)
Bilog Antenna	TESEQ	CBL 6111D&00800 N1D01N-06	35419&03	30MHz to 1GHz	Jan. 07, 2017	Jan. 25, 2017	Jan. 06, 2018	Radiation (03CH07-HY)
Double Ridge Horn Antenna	ESCO	3117	00075962	1GHz ~ 18GHz	Aug. 19, 2016	Jan. 25, 2017	Aug. 18, 2017	Radiation (03CH07-HY)
EMI Test Receiver	Keysight	N9038A (MXE)	MY541300 85	20Hz ~ 8.4GHz	Oct. 26, 2016	Jan. 25, 2017	Oct. 25, 2017	Radiation (03CH07-HY)
Loop Antenna	Rohde & Schwarz	HFH2-Z2	100315	9 kHz~30 MHz	Sep. 02, 2015	Jan. 25, 2017	Sep. 01, 2017	Radiation (03CH07-HY)
Preamplifier	MITEQ	AMF-7D-0010 1800-30-10P	1590075	1GHz ~ 18GHz	Apr. 15, 2016	Jan. 25, 2017	Apr. 14, 2017	Radiation (03CH07-HY)
Preamplifier	COM-POWER	PA-103A	161241	10MHz-1GHz	Mar. 18, 2016	Jan. 25, 2017	Mar. 17, 2017	Radiation (03CH07-HY)
Preamplifier	Agilent	8449B	3008A023 62	1GHz~ 26.5GHz	Oct. 12, 2016	Jan. 25, 2017	Oct. 11, 2017	Radiation (03CH07-HY)
Spectrum Analyzer	Agilent	N9010A	MY534701 18	10Hz~44GHz	Feb. 27, 2016	Jan. 25, 2017	Feb. 26, 2017	Radiation (03CH07-HY)
Antenna Mast	Max-Full	MFA520BS	N/A	1m~4m	N/A	Jan. 25, 2017	N/A	Radiation (03CH07-HY)
Turn Table	ChainTek	Chaintek 3000	N/A	0~360 Degree	N/A	Jan. 25, 2017	N/A	Radiation (03CH07-HY)
Loop Cable	Rohde & Schwarz	N/A	N/A	9KHz~30MHz	Dec. 01, 2015	Jan. 25, 2017	Nov. 30, 2017	Radiation (03CH07-HY)
Preamplifier	MITEQ	JS44-180040 00-33-8P	1840917	18GHz ~ 40GHz	Jun. 14, 2016	Jan. 25, 2017	Jun. 13, 2017	Radiation (03CH07-HY)
SHF-EHF Horn Antenna	SCHWARZBECK	BBHA 9170	BBHA9170 584	18GHz- 40GHz	Nov. 08, 2016	Jan. 25, 2017	Nov. 07, 2017	Radiation (03CH07-HY)



## 5 Uncertainty of Evaluation

### Uncertainty of Conducted Emission Measurement (150kHz ~ 30MHz)

Measuring Uncertainty for a Level of Confidence of 95% ( $U = 2Uc(y)$ )	2.7
---	-----

### Uncertainty of Radiated Emission Measurement (30 MHz ~ 1000 MHz)

Measuring Uncertainty for a Level of Confidence of 95% ( $U = 2Uc(y)$ )	5.7
---	-----

### Uncertainty of Radiated Emission Measurement (1000 MHz ~ 18000 MHz)

Measuring Uncertainty for a Level of Confidence of 95% ( $U = 2Uc(y)$ )	5.5
---	-----

### Uncertainty of Radiated Emission Measurement (18000 MHz ~ 40000 MHz)

Measuring Uncertainty for a Level of Confidence of 95% ( $U = 2Uc(y)$ )	5.2
---	-----

**Appendix A. Test Result of Conducted Test Items**

Test Engineer:	Aking Chang	Temperature:	21~25	°C
Test Date:	2017/01/17~2017/02/23	Relative Humidity:	51~54	%

**TEST RESULTS DATA**  
**6dB and 99% Occupied Bandwidth**

2.4GHz Band								
Mod.	Data Rate	N <sub>TX</sub>	CH.	Freq. (MHz)	99% Occupied BW (MHz)	6dB BW (MHz)	6dB BW Limit (MHz)	Pass/Fail
11b	1Mbps	1	1	2412	14.20	9.06	0.50	Pass
11b	1Mbps	1	6	2437	14.20	9.06	0.50	Pass
11b	1Mbps	1	11	2462	14.25	9.02	0.50	Pass
11g	6Mbps	1	1	2412	17.65	15.02	0.50	Pass
11g	6Mbps	1	6	2437	18.10	15.10	0.50	Pass
11g	6Mbps	1	11	2462	17.80	15.02	0.50	Pass
HT20	MCS0	1	1	2412	18.35	15.02	0.50	Pass
HT20	MCS0	1	6	2437	18.50	15.12	0.50	Pass
HT20	MCS0	1	11	2462	18.35	15.10	0.50	Pass

**TEST RESULTS DATA**  
**Peak Power Table**

2.4GHz Band										
Mod.	Data Rate	N <sub>TX</sub>	CH.	Freq. (MHz)	Peak Conducted Power (dBm)	Conducted Power Limit (dBm)	DG (dBi)	EIRP Power (dBm)	EIRP Power Limit (dBm)	Pass /Fail
11b	1Mbps	1	1	2412	14.22	30.00	3.30	17.52	36.00	Pass
11b	1Mbps	1	6	2437	14.20	30.00	3.30	17.50	36.00	Pass
11b	1Mbps	1	11	2462	14.11	30.00	3.30	17.41	36.00	Pass
11g	6Mbps	1	1	2412	17.73	30.00	3.30	21.03	36.00	Pass
11g	6Mbps	1	6	2437	17.85	30.00	3.30	21.15	36.00	Pass
11g	6Mbps	1	11	2462	17.37	30.00	3.30	20.67	36.00	Pass
HT20	MCS0	1	1	2412	17.64	30.00	3.30	20.94	36.00	Pass
HT20	MCS0	1	6	2437	17.68	30.00	3.30	20.98	36.00	Pass
HT20	MCS0	1	11	2462	17.62	30.00	3.30	20.92	36.00	Pass

**TEST RESULTS DATA**  
**Average Power Table**  
***(Reporting Only)***

2.4GHz Band						
Mod.	Data Rate	N <sub>TX</sub>	CH.	Freq. (MHz)	Duty Factor (dB)	Average Conducted Power (dBm)
11b	1Mbps	1	1	2412	9.43	12.10
11b	1Mbps	1	6	2437	9.43	12.90
11b	1Mbps	1	11	2462	9.43	12.60
11g	6Mbps	1	1	2412	17.21	11.00
11g	6Mbps	1	6	2437	17.21	12.90
11g	6Mbps	1	11	2462	17.21	10.80
HT20	MCS0	1	1	2412	17.45	10.60
HT20	MCS0	1	6	2437	17.45	12.90
HT20	MCS0	1	11	2462	17.45	10.70

**TEST RESULTS DATA**  
**Peak Power Density**

2.4GHz Band								
Mod.	Data Rate	N <sub>TX</sub>	CH.	Freq. (MHz)	Peak PSD (dBm /3kHz)	DG (dBi)	Peak PSD Limit (dBm /3kHz)	Pass/Fail
11b	1Mbps	1	1	2412	-15.49	3.30	8.00	Pass
11b	1Mbps	1	6	2437	-14.05	3.30	8.00	Pass
11b	1Mbps	1	11	2462	-14.86	3.30	8.00	Pass
11g	6Mbps	1	1	2412	-16.95	3.30	8.00	Pass
11g	6Mbps	1	6	2437	-15.19	3.30	8.00	Pass
11g	6Mbps	1	11	2462	-16.05	3.30	8.00	Pass
HT20	MCS0	1	1	2412	-16.79	3.30	8.00	Pass
HT20	MCS0	1	6	2437	-14.71	3.30	8.00	Pass
HT20	MCS0	1	11	2462	-16.64	3.30	8.00	Pass

## Appendix B. AC Conducted Emission Test Results

Test Engineer :	Kai-Chun Chu	Temperature :	22~23°C
		Relative Humidity :	44~45%
Test Voltage :	120Vac / 60Hz	Phase :	Line

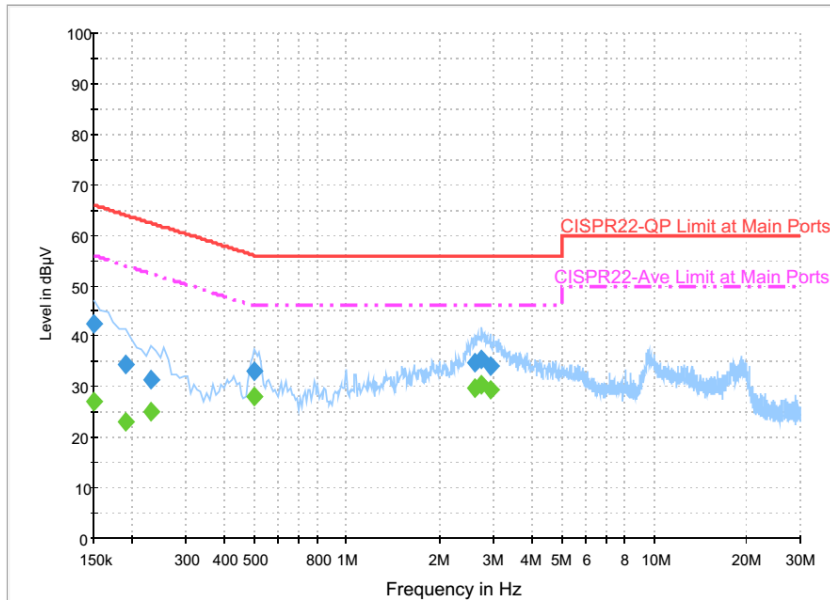

### Final Result : Quasi-Peak

Frequency (MHz)	Quasi-Peak (dBµV)	Filter	Line	Corr. (dB)	Margin (dB)	Limit (dBµV)
0.150000	42.4	Off	L1	19.6	23.6	66.0
0.190000	34.6	Off	L1	19.6	29.4	64.0
0.230000	31.5	Off	L1	19.6	30.9	62.4
0.502000	33.0	Off	L1	19.6	23.0	56.0
2.622000	34.7	Off	L1	19.3	21.3	56.0
2.750000	35.4	Off	L1	19.3	20.6	56.0
2.926000	34.3	Off	L1	19.4	21.7	56.0

### Final Result : Average

Frequency (MHz)	Average (dBµV)	Filter	Line	Corr. (dB)	Margin (dB)	Limit (dBµV)
0.150000	27.0	Off	L1	19.6	29.0	56.0
0.190000	23.2	Off	L1	19.6	30.8	54.0
0.230000	25.0	Off	L1	19.6	27.4	52.4
0.502000	28.2	Off	L1	19.6	17.8	46.0
2.622000	29.7	Off	L1	19.3	16.3	46.0
2.750000	30.3	Off	L1	19.3	15.7	46.0
2.926000	29.3	Off	L1	19.4	16.7	46.0





Test Engineer :	Kai-Chun Chu	Temperature :	22~23°C
		Relative Humidity :	44~45%
Test Voltage :	120Vac / 60Hz	Phase :	Neutral

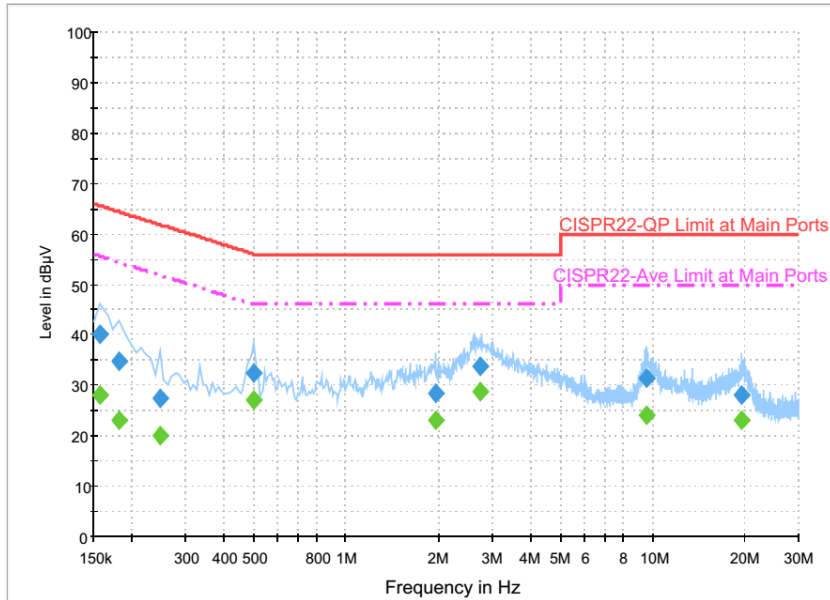

**Final Result : Quasi-Peak**

Frequency (MHz)	Quasi-Peak (dBµV)	Filter	Line	Corr. (dB)	Margin (dB)	Limit (dBµV)
0.158000	40.2	Off	N	19.6	25.4	65.6
0.182000	34.8	Off	N	19.5	29.6	64.4
0.246000	27.6	Off	N	19.5	34.3	61.9
0.502000	32.3	Off	N	19.5	23.7	56.0
1.966000	28.4	Off	N	19.6	27.6	56.0
2.734000	33.6	Off	N	19.3	22.4	56.0
9.622000	31.4	Off	N	19.7	28.6	60.0
19.638000	28.2	Off	N	19.8	31.8	60.0

**Final Result : Average**

Frequency (MHz)	Average (dBµV)	Filter	Line	Corr. (dB)	Margin (dB)	Limit (dBµV)
0.158000	28.0	Off	N	19.6	27.6	55.6
0.182000	23.1	Off	N	19.5	31.3	54.4
0.246000	20.0	Off	N	19.5	31.9	51.9
0.502000	27.0	Off	N	19.5	19.0	46.0
1.966000	23.1	Off	N	19.6	22.9	46.0
2.734000	28.8	Off	N	19.3	17.2	46.0
9.622000	24.1	Off	N	19.7	25.9	50.0
19.638000	23.0	Off	N	19.8	27.0	50.0



### Appendix C. Radiated Spurious Emission

Test Engineer :	Jesse Wang, James Chiu, and Daniel Lee	Temperature :	21~23°C
		Relative Humidity :	47~51%

2.4GHz 2400~2483.5MHz

WIFI 802.11b (Band Edge @ 3m)

WIFI	Note	Frequency	Level	Over	Limit	Read	Antenna	Cable	Preamp	Ant	Table	Peak	Pol.	
Ant.				Limit	Line	Level	Factor	Loss	Factor	Pos	Pos	Avg.		
1		( MHz )	( dBμV/m )	( dB )	( dBμV/m )	( dBμV )	( dB/m )	( dB )	( dB )	( cm )	( deg )	(P/A)	(H/V)	
802.11b CH 01 2412MHz		2387.07	55.2	-18.8	74	50.67	32.19	7.31	34.97	138	332	P	H	
		2336.88	46.39	-7.61	54	42.14	32.03	7.18	34.96	138	332	A	H	
	*	2412	101.84	-	-	97.27	32.24	7.31	34.98	138	332	P	H	
	*	2412	98.82	-	-	94.25	32.24	7.31	34.98	138	332	A	H	
													H	
														H
			2353.47	55.21	-18.79	74	50.85	32.09	7.24	34.97	362	305	P	V
			2389.8	45.47	-8.53	54	40.95	32.19	7.31	34.98	362	305	A	V
	*		2412	96.53	-	-	91.96	32.24	7.31	34.98	362	305	P	V
	*		2412	93.51	-	-	88.94	32.24	7.31	34.98	362	305	A	V
802.11b CH 06 2437MHz		2375.66	55.58	-18.42	74	51.17	32.14	7.24	34.97	160	331	P	H	
		2361.66	47.45	-6.55	54	43.09	32.09	7.24	34.97	160	331	A	H	
	*	2437	104.08	-	-	99.37	32.34	7.36	34.99	160	331	P	H	
	*	2437	100.93	-	-	96.22	32.34	7.36	34.99	160	331	A	H	
			2498.25	57.14	-16.86	74	52.25	32.5	7.4	35.01	160	331	P	H
			2492.65	47.89	-6.11	54	43	32.5	7.4	35.01	160	331	A	H
			2319.1	54.37	-19.63	74	50.17	31.98	7.18	34.96	365	272	P	V
			2384.48	45.58	-8.42	54	41.1	32.14	7.31	34.97	365	272	A	V
	*		2437	97.61	-	-	92.9	32.34	7.36	34.99	365	272	P	V
	*		2437	94.49	-	-	89.78	32.34	7.36	34.99	365	272	A	V
		2494.12	54.7	-19.3	74	49.81	32.5	7.4	35.01	365	272	P	V	
		2498.11	45.83	-8.17	54	40.94	32.5	7.4	35.01	365	272	A	V	



<b>802.11b CH 11 2462MHz</b>	*	2462	103.48	-	-	98.67	32.4	7.4	34.99	156	339	P	H
	*	2462	100.38	-	-	95.57	32.4	7.4	34.99	156	339	A	H
		2491.96	55.98	-18.02	74	51.09	32.5	7.4	35.01	156	339	P	H
		2497.08	47.62	-6.38	54	42.73	32.5	7.4	35.01	156	339	A	H
													H
													H
	*	2462	95.78	-	-	90.97	32.4	7.4	34.99	350	304	P	V
	*	2462	92.69	-	-	87.88	32.4	7.4	34.99	350	304	A	V
		2492.72	54.89	-19.11	74	50	32.5	7.4	35.01	350	304	P	V
		2493.68	45.95	-8.05	54	41.06	32.5	7.4	35.01	350	304	A	V
													V
													V
<b>Remark</b>	1. No other spurious found. 2. All results are PASS against Peak and Average limit line.												



2.4GHz 2400~2483.5MHz

WIFI 802.11b (Harmonic @ 3m)

WIFI Ant. 1	Note	Frequency ( MHz )	Level ( dBμV/m )	Over Limit ( dB )	Limit Line ( dBμV/m )	Read Level ( dBμV )	Antenna Factor ( dB/m )	Cable Loss ( dB )	Preamp Factor ( dB )	Ant Pos ( cm )	Table Pos ( deg )	Peak Avg. (P/A)	Pol. (H/V)
802.11b CH 01 2412MHz		4020	53.43	-20.57	74	70.48	32.99	9.85	59.89	380	64	P	H
		4020	49.96	-4.04	54	67.01	32.99	9.85	59.89	380	64	A	H
		4824	45.33	-28.67	74	59.05	33.64	11.68	59.04	100	0	P	H
													H
		4020	54.15	-19.85	74	71.2	32.99	9.85	59.89	100	295	P	V
		4020	51.18	-2.82	54	68.23	32.99	9.85	59.89	100	295	A	V
		4824	44.43	-29.57	74	58.15	33.64	11.68	59.04	100	0	P	V
802.11b CH 06 2437MHz		4062	53.55	-20.45	74	70.53	33.09	9.8	59.87	373	62	P	H
		4062	49.19	-4.81	54	66.17	33.09	9.8	59.87	373	62	A	H
		4874	44.13	-29.87	74	58	33.54	11.53	58.94	100	0	P	H
		7311	40.27	-33.73	74	49.7	34.69	13.81	57.93	100	0	P	H
		4062	53.01	-20.99	74	69.99	33.09	9.8	59.87	100	281	P	V
		4062	49.84	-4.16	54	66.82	33.09	9.8	59.87	100	281	A	V
		4874	44.56	-29.44	74	58.43	33.54	11.53	58.94	100	0	P	V
		7311	40.16	-33.84	74	49.59	34.69	13.81	57.93	100	0	P	V
802.11b CH 11 2462MHz		4104	52.7	-21.3	74	69.55	33.23	9.77	59.85	364	58	P	H
		4104	48.15	-5.85	54	65	33.23	9.77	59.85	364	58	A	H
		4924	43.65	-30.35	74	57.68	33.44	11.37	58.84	100	0	P	H
		7386	38.96	-35.04	74	48.6	34.47	13.95	58.06	100	0	P	H
		4104	52.41	-21.59	74	69.26	33.23	9.77	59.85	100	282	P	V
		4104	48.98	-5.02	54	65.83	33.23	9.77	59.85	100	282	A	V
		4924	45.11	-28.89	74	59.14	33.44	11.37	58.84	100	0	P	V
		7386	40.74	-33.26	74	50.38	34.47	13.95	58.06	100	0	P	V
Remark	1. No other spurious found. 2. All results are PASS against Peak and Average limit line.												



2.4GHz 2400~2483.5MHz  
WIFI 802.11g (Band Edge @ 3m)

WIFI Ant. 1	Note	Frequency ( MHz )	Level ( dBμV/m )	Over Limit ( dB )	Limit Line ( dBμV/m )	Read Level ( dBμV )	Antenna Factor ( dB/m )	Cable Loss ( dB )	Preamp Factor ( dB )	Ant Pos ( cm )	Table Pos ( deg )	Peak Avg. (P/A)	Pol. (H/V)	
802.11g CH 01 2412MHz		2378.46	56.09	-17.91	74	51.68	32.14	7.24	34.97	136	337	P	H	
		2389.38	48.77	-5.23	54	44.24	32.19	7.31	34.97	136	337	A	H	
	*	2412	103.5	-	-	98.93	32.24	7.31	34.98	136	337	P	H	
	*	2412	96.16	-	-	91.59	32.24	7.31	34.98	136	337	A	H	
													H	
													H	
			2370.27	54.84	-19.16	74	50.43	32.14	7.24	34.97	364	291	P	V
			2364.075	46.87	-7.13	54	42.51	32.09	7.24	34.97	364	291	A	V
	*		2412	97.84	-	-	93.27	32.24	7.31	34.98	364	291	P	V
	*		2412	91.03	-	-	86.46	32.24	7.31	34.98	364	291	A	V
													V	
													V	
802.11g CH 06 2437MHz		2352.28	55.33	-18.67	74	50.97	32.09	7.24	34.97	157	333	P	H	
		2357.88	48.29	-5.71	54	43.93	32.09	7.24	34.97	157	333	A	H	
	*	2437	107.39	-	-	102.68	32.34	7.36	34.99	157	333	P	H	
	*	2437	100.22	-	-	95.51	32.34	7.36	34.99	157	333	A	H	
			2492.79	56.26	-17.74	74	51.37	32.5	7.4	35.01	157	333	P	H
			2498.88	48.42	-5.58	54	43.53	32.5	7.4	35.01	157	333	A	H
			2380.98	54.59	-19.41	74	50.11	32.14	7.31	34.97	365	287	P	V
			2351.72	47.05	-6.95	54	42.69	32.09	7.24	34.97	365	287	A	V
	*		2437	101.37	-	-	96.66	32.34	7.36	34.99	365	287	P	V
	*		2437	94.1	-	-	89.39	32.34	7.36	34.99	365	287	A	V
			2492.65	55.5	-18.5	74	50.61	32.5	7.4	35.01	365	287	P	V
			2494.05	47.41	-6.59	54	42.52	32.5	7.4	35.01	365	287	A	V



<b>802.11g CH 11 2462MHz</b>	*	2462	103.77	-	-	98.96	32.4	7.4	34.99	155	342	P	H
	*	2462	97.3	-	-	92.49	32.4	7.4	34.99	155	342	A	H
		2483.84	56.25	-17.75	74	51.4	32.45	7.4	35	155	342	P	H
		2483.76	49.55	-4.45	54	44.7	32.45	7.4	35	155	342	A	H
													H
													H
	*	2462	96.09	-	-	91.28	32.4	7.4	34.99	352	290	P	V
	*	2462	89.77	-	-	84.96	32.4	7.4	34.99	352	290	A	V
		2485.32	55.19	-18.81	74	50.34	32.45	7.4	35	352	290	P	V
		2483.72	48.14	-5.86	54	43.29	32.45	7.4	35	352	290	A	V
													V
													V
<b>Remark</b>	1. No other spurious found. 2. All results are PASS against Peak and Average limit line.												



2.4GHz 2400~2483.5MHz

WIFI 802.11g (Harmonic @ 3m)

WIFI Ant. 1	Note	Frequency ( MHz )	Level ( dBμV/m )	Over Limit ( dB )	Limit Line ( dBμV/m )	Read Level ( dBμV )	Antenna Factor ( dB/m )	Cable Loss ( dB )	Preamp Factor ( dB )	Ant Pos ( cm )	Table Pos ( deg )	Peak Avg. (P/A)	Pol. (H/V)
802.11g CH 01 2412MHz		4020	52.62	-21.38	74	69.67	32.99	9.85	59.89	335	190	P	H
		4020	45.83	-8.17	54	62.88	32.99	9.85	59.89	335	190	A	H
		4824	42.4	-31.6	74	56.12	33.64	11.68	59.04	100	0	P	H
													H
		4020	56.2	-17.8	74	73.25	32.99	9.85	59.89	102	297	P	V
		4020	48.74	-5.26	54	65.79	32.99	9.85	59.89	102	297	A	V
		4824	41.99	-32.01	74	55.71	33.64	11.68	59.04	100	0	P	V
802.11g CH 06 2437MHz		4062	54.05	-19.95	74	71.03	33.09	9.8	59.87	372	62	P	H
		4062	47.57	-6.43	54	64.55	33.09	9.8	59.87	372	62	A	H
		4874	44.61	-29.39	74	58.48	33.54	11.53	58.94	100	0	P	H
		7311	40.72	-33.28	74	50.15	34.69	13.81	57.93	100	0	P	H
		4062	54.88	-19.12	74	71.86	33.09	9.8	59.87	100	290	P	V
		4062	47.77	-6.23	54	64.75	33.09	9.8	59.87	100	290	A	V
		4874	46.11	-27.89	74	59.98	33.54	11.53	58.94	100	0	P	V
		7311	39.82	-34.18	74	49.25	34.69	13.81	57.93	100	0	P	V
802.11g CH 11 2462MHz		4102	53.48	-20.52	74	70.39	33.18	9.77	59.86	369	177	P	H
		4102	46.93	-7.07	54	63.84	33.18	9.77	59.86	369	177	A	H
		4924	40.08	-33.92	74	54.11	33.44	11.37	58.84	100	0	P	H
		7386	38.82	-35.18	74	48.46	34.47	13.95	58.06	100	0	P	H
		4102	52.79	-21.21	74	69.7	33.18	9.77	59.86	100	276	P	V
		4102	45.48	-8.52	54	62.39	33.18	9.77	59.86	100	276	A	V
		4924	43.34	-30.66	74	57.37	33.44	11.37	58.84	100	0	P	V
		7386	40.01	-33.99	74	49.65	34.47	13.95	58.06	100	0	P	V
Remark	1. No other spurious found. 2. All results are PASS against Peak and Average limit line.												



**2.4GHz 2400~2483.5MHz**  
**WIFI 802.11n HT20 (Band Edge @ 3m)**

WIFI Ant. 1	Note	Frequency ( MHz )	Level ( dBμV/m )	Over Limit ( dB )	Limit Line ( dBμV/m )	Read Level ( dBμV )	Antenna Factor ( dB/m )	Cable Loss ( dB )	Preamp Factor ( dB )	Ant Pos ( cm )	Table Pos ( deg )	Peak Avg. (P/A)	Pol. (H/V)	
802.11n HT20 CH 01 2412MHz		2388.54	56.55	-17.45	74	52.02	32.19	7.31	34.97	117	337	P	H	
		2389.695	49.05	-4.95	54	44.52	32.19	7.31	34.97	117	337	A	H	
	*	2412	102.9	-	-	98.33	32.24	7.31	34.98	117	337	P	H	
	*	2412	96.12	-	-	91.55	32.24	7.31	34.98	117	337	A	H	
													H	
													H	
			2345.595	54.49	-19.51	74	50.19	32.03	7.24	34.97	362	290	P	V
			2365.65	46.86	-7.14	54	42.5	32.09	7.24	34.97	362	290	A	V
		*	2412	97.37	-	-	92.8	32.24	7.31	34.98	362	290	P	V
		*	2412	90.63	-	-	86.06	32.24	7.31	34.98	362	290	A	V
													V	
													V	
802.11n HT20 CH 06 2437MHz		2341.5	55.45	-18.55	74	51.15	32.03	7.24	34.97	112	332	P	H	
		2356.9	48.49	-5.51	54	44.13	32.09	7.24	34.97	112	332	A	H	
		*	2437	107.07	-	-	102.36	32.34	7.36	34.99	112	332	P	H
		*	2437	99.75	-	-	95.04	32.34	7.36	34.99	112	332	A	H
			2496.15	56.06	-17.94	74	51.17	32.5	7.4	35.01	112	332	P	H
			2488.73	48.69	-5.31	54	43.79	32.5	7.4	35	112	332	A	H
			2349.06	54.28	-19.72	74	49.98	32.03	7.24	34.97	365	287	P	V
			2389.8	46.95	-7.05	54	42.43	32.19	7.31	34.98	365	287	A	V
		*	2437	99.88	-	-	95.17	32.34	7.36	34.99	365	287	P	V
		*	2437	93.5	-	-	88.79	32.34	7.36	34.99	365	287	A	V
			2484.04	54.92	-19.08	74	50.07	32.45	7.4	35	365	287	P	V
			2489.22	47.7	-6.3	54	42.8	32.5	7.4	35	365	287	A	V





<b>802.11n</b> <b>HT20</b> <b>CH 11</b> <b>2462MHz</b>	*	2462	104.47	-	-	99.66	32.4	7.4	34.99	156	342	P	H
	*	2462	97.28	-	-	92.47	32.4	7.4	34.99	156	342	A	H
		2484.36	57.87	-16.13	74	53.02	32.45	7.4	35	156	342	P	H
		2483.52	50.07	-3.93	54	45.22	32.45	7.4	35	156	342	A	H
													H
													H
	*	2462	96.33	-	-	91.52	32.4	7.4	34.99	350	303	P	V
	*	2462	89.81	-	-	85	32.4	7.4	34.99	350	303	A	V
		2484.04	55.47	-18.53	74	50.62	32.45	7.4	35	350	303	P	V
		2483.76	47.83	-6.17	54	42.98	32.45	7.4	35	350	303	A	V
													V
												V	
<b>Remark</b>	1. No other spurious found. 2. All results are PASS against Peak and Average limit line.												



2.4GHz 2400~2483.5MHz

WIFI 802.11n HT20 (Harmonic @ 3m)

WIFI Ant. 1	Note	Frequency ( MHz )	Level ( dBμV/m )	Over Limit ( dB )	Limit Line ( dBμV/m )	Read Level ( dBμV )	Antenna Factor ( dB/m )	Cable Loss ( dB )	Preamp Factor ( dB )	Ant Pos ( cm )	Table Pos ( deg )	Peak Avg. (P/A)	Pol. (H/V)
802.11n HT20 CH 01 2412MHz		4020	53.18	-20.82	74	70.23	32.99	9.85	59.89	352	47	P	H
		4020	46.57	-7.43	54	63.62	32.99	9.85	59.89	352	47	A	H
		4824	41.25	-32.75	74	54.97	33.64	11.68	59.04	100	0	P	H
													H
		4020	55.06	-18.94	74	72.11	32.99	9.85	59.89	103	296	P	V
		4020	48.74	-5.26	54	65.79	32.99	9.85	59.89	103	296	A	V
		4824	43.09	-30.91	74	56.81	33.64	11.68	59.04	100	0	P	V
													V
802.11n HT20 CH 06 2437MHz		4062	54.14	-19.86	74	71.12	33.09	9.8	59.87	380	185	P	H
		4062	47.29	-6.71	54	64.27	33.09	9.8	59.87	380	185	A	H
		4874	47.05	-26.95	74	60.92	33.54	11.53	58.94	100	0	P	H
		7311	40.56	-33.44	74	49.99	34.69	13.81	57.93	100	0	P	H
		4068	54.69	-19.31	74	71.67	33.09	9.8	59.87	104	290	P	V
		4068	47.91	-6.09	54	64.89	33.09	9.8	59.87	104	290	A	V
		4874	45.8	-28.2	74	59.67	33.54	11.53	58.94	100	0	P	V
	7311	38.84	-35.16	74	48.27	34.69	13.81	57.93	100	0	P	V	
802.11n HT20 CH 11 2462MHz		4104	50.59	-23.41	74	67.44	33.23	9.77	59.85	380	187	P	H
		4104	43.74	-10.26	54	60.59	33.23	9.77	59.85	380	187	A	H
		4926	39.25	-34.75	74	53.28	33.44	11.37	58.84	100	0	P	H
		7386	39.19	-34.81	74	48.83	34.47	13.95	58.06	100	0	P	H
		4104	50.96	-23.04	74	67.81	33.23	9.77	59.85	380	186	P	V
		4104	42.31	-11.69	54	59.16	33.23	9.77	59.85	380	186	A	V
		4926	41.93	-32.07	74	55.96	33.44	11.37	58.84	100	0	P	V
	7386	40.21	-33.79	74	49.85	34.47	13.95	58.06	100	0	P	V	
Remark	1. No other spurious found. 2. All results are PASS against Peak and Average limit line.												



2.4GHz 2400~2483.5MHz

Emission below 1GHz

2.4GHz WIFI 802.11b (LF)

WIFI Ant.	Note	Frequency	Level	Over Limit	Limit Line	Read Level	Antenna Factor	Cable Loss	Preamp Factor	Ant Pos	Table Pos	Peak Avg.	Pol.	
1		( MHz )	( dBμV/m )	( dB )	( dBμV/m )	( dBμV )	( dB/m )	( dB )	( dB )	( cm )	( deg )	( P/A )	( H/V )	
2.4GHz 802.11b LF		30	27.73	-12.27	40	32.01	26	1.07	31.35	-	-	P	H	
		119.1	38.67	-4.83	43.5	50.78	17.85	1.55	31.51	100	0	P	H	
		142.86	30.43	-13.07	43.5	42.23	17.92	1.78	31.5	-	-	P	H	
		333.6	39.06	-6.94	46	47.15	20.74	2.41	31.24	-	-	P	H	
		456.1	32.26	-13.74	46	37.23	23.23	2.89	31.09	-	-	P	H	
		948.2	33.45	-12.55	46	29.73	30.18	4.07	30.53	-	-	P	H	
														H
														H
														H
														H
														H
														H
			30	27.5	-12.5	40	31.78	26	1.07	31.35	100	0	P	V
			118.83	30.18	-13.32	43.5	42.29	17.85	1.55	31.51	-	-	P	V
			268.41	30.06	-15.94	46	39.62	19.46	2.32	31.34	-	-	P	V
			407.8	32.35	-13.65	46	38.33	22.51	2.67	31.16	-	-	P	V
			456.1	31.32	-14.68	46	36.29	23.23	2.89	31.09	-	-	P	V
			957.3	33.02	-12.98	46	29.26	30.22	4.07	30.53	-	-	P	V
													V	
													V	
													V	
													V	
													V	
Remark	1. No other spurious found. 2. All results are PASS against limit line.													



Note symbol

*	<b>Fundamental Frequency</b> which can be ignored. However, the level of any unwanted emissions shall not exceed the level of the fundamental frequency.
!	Test result is <b>over limit</b> line.
P/A	<b>Peak</b> or <b>Average</b>
H/V	<b>Horizontal</b> or <b>Vertical</b>



A calculation example for radiated spurious emission is shown as below:

WIFI	Note	Frequency	Level	Over	Limit	Read	Antenna	Cable	Preamp	Ant	Table	Peak	Pol.
Ant.				Limit	Line	Level	Factor	Loss	Factor	Pos	Pos	Avg.	
1		( MHz )	( dBμV/m )	( dB )	( dBμV/m )	( dBμV )	( dB/m )	( dB )	( dB )	( cm )	( deg )	(P/A)	(H/V)
802.11b		2390	55.45	-18.55	74	54.51	32.22	4.58	35.86	103	308	P	H
CH 01													
2412MHz		2390	43.54	-10.46	54	42.6	32.22	4.58	35.86	103	308	A	H

- Level(dBμV/m) =  
Antenna Factor(dB/m) + Cable Loss(dB) + Read Level(dBμV) - Preamp Factor(dB)
- Over Limit(dB) = Level(dBμV/m) – Limit Line(dBμV/m)

**For Peak Limit @ 2390MHz:**

- Level(dBμV/m)  
= Antenna Factor(dB/m) + Cable Loss(dB) + Read Level(dBμV) - Preamp Factor(dB)  
= 32.22(dB/m) + 4.58(dB) + 54.51(dBμV) – 35.86 (dB)  
= 55.45 (dBμV/m)
- Over Limit(dB)  
= Level(dBμV/m) – Limit Line(dBμV/m)  
= 55.45(dBμV/m) – 74(dBμV/m)  
= -18.55(dB)

**For Average Limit @ 2390MHz:**

- Level(dBμV/m)  
= Antenna Factor(dB/m) + Cable Loss(dB) + Read Level(dBμV) - Preamp Factor(dB)  
= 32.22(dB/m) + 4.58(dB) + 42.6(dBμV) – 35.86 (dB)  
= 43.54 (dBμV/m)
- Over Limit(dB)  
= Level(dBμV/m) – Limit Line(dBμV/m)  
= 43.54(dBμV/m) – 54(dBμV/m)  
= -10.46(dB)

Both peak and average measured complies with the limit line, so test result is “PASS”.



## Appendix D. Radiated Spurious Emission Plots

Test Engineer :	Jesse Wang, James Chiu, and Daniel Lee	Temperature :	21~23°C
		Relative Humidity :	47~51%

### Note symbol

-L	Low channel location
-R	High channel location



2.4GHz 2400~2483.5MHz

WIFI 802.11b (Band Edge @ 3m)

WIFI	2.4GHz 2400~2483.5MHz Band Edge @ 3m	
ANT	802.11b CH01 2412MHz	
1	Horizontal	Fundamental
Peak	<p>Site : 03CH07-FY            Condition : PEAK_BE_74 3m HF-ANT_130829 HORIZONTAL            Detector : Peak            Project : 6D0643            Mode : 1</p>	<p>Site : 03CH07-FY            Condition : PEAK_74 3m HF-ANT_130829 HORIZONTAL            Detector : Peak            Project : 6D0643            Mode : 1</p>
Avg.	<p>Site : 03CH07-FY            Condition : AVG_BE_74 3m HF-ANT_130829 HORIZONTAL            Detector : Peak            Project : 6D0643            Mode : 1</p>	<p>Site : 03CH07-FY            Condition : AVG_74 3m HF-ANT_130829 HORIZONTAL            Detector : Peak            Project : 6D0643            Mode : 1</p>

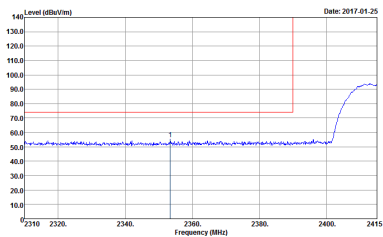
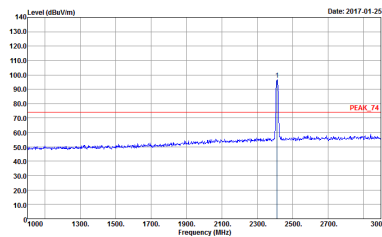
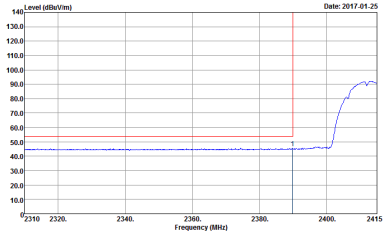
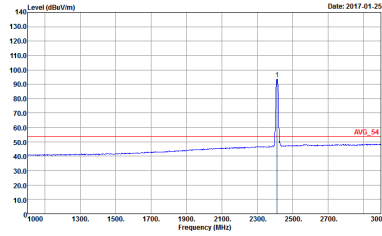

WIFI	2.4GHz 2400~2483.5MHz Band Edge @ 3m	
ANT	802.11b CH01 2412MHz	
1	Vertical	Fundamental
Peak	 <p>           Date: 2017-01-25            Site : 03CH074Y            Condition : PEAK_BE_74 3m HF-ANT_130829 VERTICAL            Detector : RBW:1000.000kHz VBW:3000.000kHz SWT:Auto            Project : Peak            Mode : 6D0643            : 1         </p>	 <p>           Date: 2017-01-25            Site : 03CH074Y            Condition : PEAK_74 3m HF-ANT_130829 VERTICAL            Detector : RBW:1000.000kHz VBW:3000.000kHz SWT:Auto            Project : Peak            Mode : 6D0643            : 1         </p>
Avg.	 <p>           Date: 2017-01-25            Site : 03CH074Y            Condition : AVG_BE_54 3m HF-ANT_130829 VERTICAL            Detector : RBW:1000.000kHz VBW:3.000kHz SWT:Auto            Project : Peak            Mode : 6D0643            : 1         </p>	 <p>           Date: 2017-01-25            Site : 03CH074Y            Condition : AVG_54 3m HF-ANT_130829 VERTICAL            Detector : RBW:1000.000kHz VBW:3.000kHz SWT:Auto            Project : Peak            Mode : 6D0643            : 1         </p>



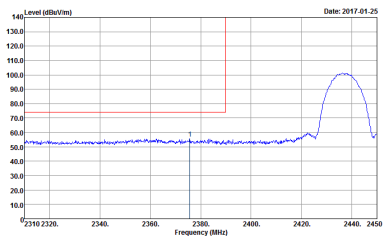
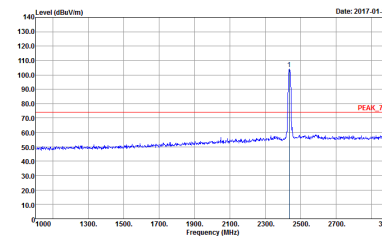
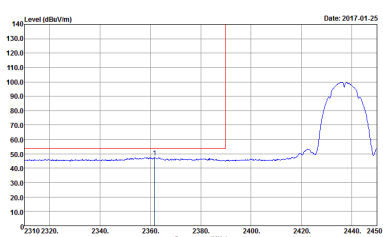
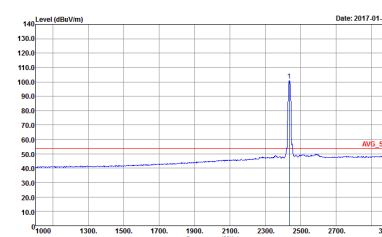

WIFI	2.4GHz 2400~2483.5MHz Band Edge @ 3m	
ANT	802.11b CH06 2437MHz - L	
1	Horizontal	Fundamental
<b>Peak</b>	 <p>Site : 03CH074Y            Condition : PEAK_BE_74 3m HF-ANT_130829 HORIZONTAL            Detector : Peak            Project : 6D0643            Mode : 2</p>	 <p>Site : 03CH074Y            Condition : PEAK_74 3m HF-ANT_130829 HORIZONTAL            Detector : Peak            Project : 6D0643            Mode : 2</p>
<b>Avg.</b>	 <p>Site : 03CH074Y            Condition : AVG_BE_54 3m HF-ANT_130829 HORIZONTAL            Detector : Peak            Project : 6D0643            Mode : 2</p>	 <p>Site : 03CH074Y            Condition : AVG_54 3m HF-ANT_130829 HORIZONTAL            Detector : Peak            Project : 6D0643            Mode : 2</p>

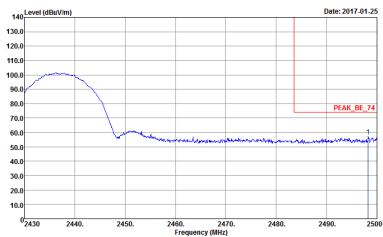
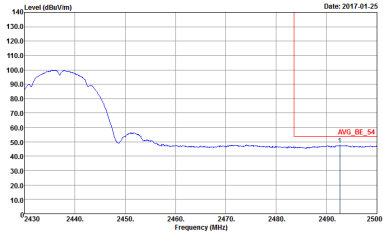

WIFI	2.4GHz 2400~2483.5MHz Band Edge @ 3m	
ANT	802.11b CH06 2437MHz - R	
1	Horizontal	Fundamental
<p><b>Peak</b></p>	 <p>           Site : 63CH074Y            Condition : PEAK_BE_74 3m HF-ANT_130829 HORIZONTAL            Detector : Peak            Project : 620643            Mode : 2         </p>	<p>Left blank</p>
<p><b>Avg.</b></p>	 <p>           Site : 63CH074Y            Condition : AVG_BE_54 3m HF-ANT_130829 HORIZONTAL            Detector : Peak            Project : 620643            Mode : 2         </p>	<p>Left blank</p>



WIFI	2.4GHz 2400~2483.5MHz Band Edge @ 3m	
ANT	802.11b CH06 2437MHz - L	
1	Vertical	Fundamental
Peak	<p>Site : 03CH074Y            Condition : PEAK_BE_74 3m HF-ANT_130829 VERTICAL            Detector : RBW:1000.000kHz VBW:3000.000kHz SWT:Auto            Project : 620643            Mode : 2</p>	<p>Site : 03CH074Y            Condition : PEAK_74 3m HF-ANT_130829 VERTICAL            Detector : RBW:1000.000kHz VBW:3000.000kHz SWT:Auto            Project : 620643            Mode : 2</p>
Avg.	<p>Site : 03CH074Y            Condition : AVG_BE_54 3m HF-ANT_130829 VERTICAL            Detector : RBW:1000.000kHz VBW:3.000kHz SWT:Auto            Project : 620643            Mode : 2</p>	<p>Site : 03CH074Y            Condition : AVG_54 3m HF-ANT_130829 VERTICAL            Detector : RBW:1000.000kHz VBW:3.000kHz SWT:Auto            Project : 620643            Mode : 2</p>

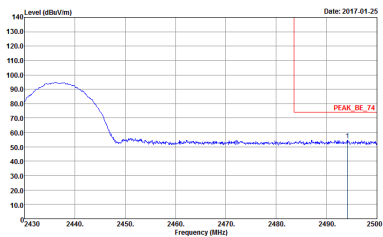
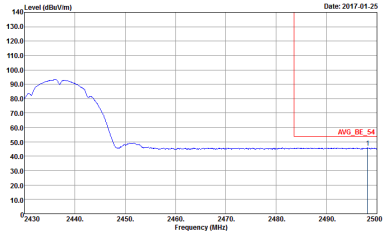

WIFI	2.4GHz 2400~2483.5MHz Band Edge @ 3m	
ANT	802.11b CH06 2437MHz - R	
1	Vertical	Fundamental
<p><b>Peak</b></p>	 <p>Site : 63CH074Y            Condition : PEAK_BE_74 3m HF-ANT_130829 VERTICAL            Detector : Peak            Project : 620643            Mode : 2</p>	<p>Left blank</p>
<p><b>Avg.</b></p>	 <p>Site : 63CH074Y            Condition : AVG_BE_54 3m HF-ANT_130829 VERTICAL            Detector : Peak            Project : 620643            Mode : 2</p>	<p>Left blank</p>

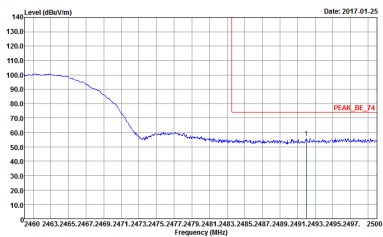
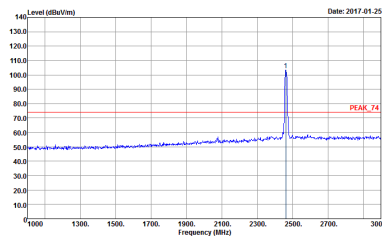
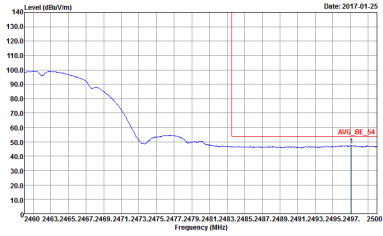
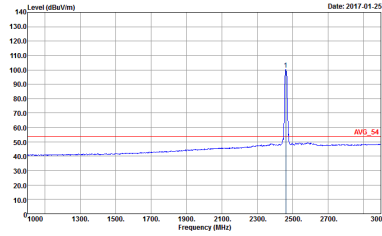

WIFI	2.4GHz 2400~2483.5MHz Band Edge @ 3m	
ANT	802.11b CH11 2462MHz	
1	Horizontal	Fundamental
Peak	 <p>Level (dBm/Vm) vs Frequency (MHz) plot for Horizontal orientation. The plot shows a signal level starting at approximately 100 dBm/Vm at 2400 MHz and decreasing to about 50 dBm/Vm by 2462 MHz. A red vertical line marks the peak at 2462 MHz, labeled 'PEAK_BE_74'.</p> <p>Site : 03CH074Y            Condition : PEAK_BE_74 3m HF-ANT_130829 HORIZONTAL            Detector : Peak            Project : 6D0643            Mode : 3</p>	 <p>Level (dBm/Vm) vs Frequency (MHz) plot for Fundamental orientation. The plot shows a flat baseline at approximately 50 dBm/Vm with a sharp peak at 2462 MHz. A red vertical line marks the peak, labeled 'PEAK_74'.</p> <p>Site : 03CH074Y            Condition : PEAK_74 3m HF-ANT_130829 HORIZONTAL            Detector : Peak            Project : 6D0643            Mode : 3</p>
Avg.	 <p>Level (dBm/Vm) vs Frequency (MHz) plot for Horizontal orientation. The plot shows a signal level starting at approximately 100 dBm/Vm at 2400 MHz and decreasing to about 50 dBm/Vm by 2462 MHz. A red vertical line marks the average level at 2462 MHz, labeled 'AVG_BE_54'.</p> <p>Site : 03CH074Y            Condition : AVG_BE_54 3m HF-ANT_130829 HORIZONTAL            Detector : Peak            Project : 6D0643            Mode : 3</p>	 <p>Level (dBm/Vm) vs Frequency (MHz) plot for Fundamental orientation. The plot shows a flat baseline at approximately 50 dBm/Vm with a sharp peak at 2462 MHz. A red vertical line marks the average level at 2462 MHz, labeled 'AVG_54'.</p> <p>Site : 03CH074Y            Condition : AVG_54 3m HF-ANT_130829 HORIZONTAL            Detector : Peak            Project : 6D0643            Mode : 3</p>



WIFI	2.4GHz 2400~2483.5MHz Band Edge @ 3m	
ANT	802.11b CH11 2462MHz	
1	Vertical	Fundamental
Peak	<p>Site : 03CH074Y            Condition : PEAK_BE_74 3m HF-ANT_130829 VERTICAL            Detector : Peak            Project : 6D0643            Mode : 3</p>	<p>Site : 03CH074Y            Condition : PEAK_74 3m HF-ANT_130829 VERTICAL            Detector : Peak            Project : 6D0643            Mode : 3</p>
	<p>Site : 03CH074Y            Condition : AVG_BE_54 3m HF-ANT_130829 VERTICAL            Detector : Peak            Project : 6D0643            Mode : 3</p>	<p>Site : 03CH074Y            Condition : AVG_54 3m HF-ANT_130829 VERTICAL            Detector : Peak            Project : 6D0643            Mode : 3</p>
Avg.		



2.4GHz 2400~2483.5MHz

WIFI 802.11g (Band Edge @ 3m)

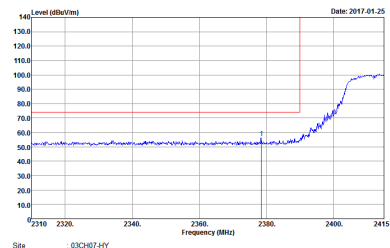
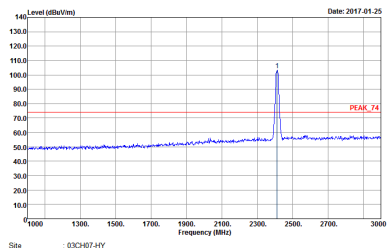
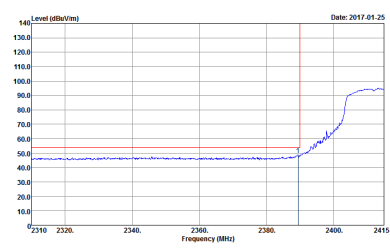
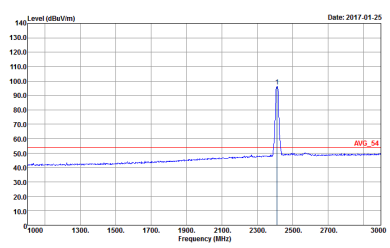
WIFI	2.4GHz 2400~2483.5MHz Band Edge @ 3m	
ANT	802.11g CH01 2412MHz	
1	Horizontal	Fundamental
Peak	 <p>Site : 03CH07-FY            Condition : PEAK_BE_74 3m HF-ANT_130829 HORIZONTAL            Detector : Peak            Project : 6D0643            Mode : 4</p>	 <p>Site : 03CH07-FY            Condition : PEAK_74 3m HF-ANT_130829 HORIZONTAL            Detector : Peak            Project : 6D0643            Mode : 4</p>
Avg.	 <p>Site : 03CH07-FY            Condition : AVG_BE_74 3m HF-ANT_130829 HORIZONTAL            Detector : Peak            Project : 6D0643            Mode : 4</p>	 <p>Site : 03CH07-FY            Condition : AVG_74 3m HF-ANT_130829 HORIZONTAL            Detector : Peak            Project : 6D0643            Mode : 4</p>

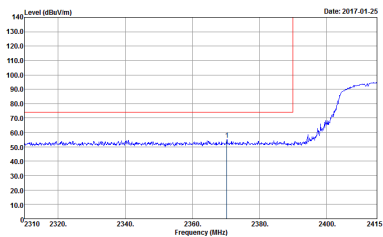
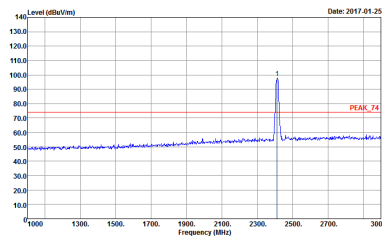
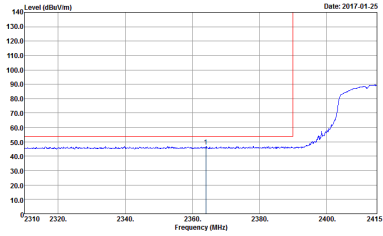
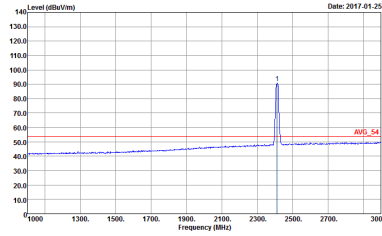

WIFI	2.4GHz 2400~2483.5MHz Band Edge @ 3m	
ANT	802.11g CH01 2412MHz	
1	Vertical	Fundamental
Peak	 <p>Site : 03CH074Y            Condition : PEAK_BE_74 3m HF-ANT_130829 VERTICAL            Detector : Peak            Project : 6D0643            Mode : 4</p>	 <p>Site : 03CH074Y            Condition : PEAK_74 3m HF-ANT_130829 VERTICAL            Detector : Peak            Project : 6D0643            Mode : 4</p>
Avg.	 <p>Site : 03CH074Y            Condition : AVG_BE_54 3m HF-ANT_130829 VERTICAL            Detector : Peak            Project : 6D0643            Mode : 4</p>	 <p>Site : 03CH074Y            Condition : AVG_54 3m HF-ANT_130829 VERTICAL            Detector : Peak            Project : 6D0643            Mode : 4</p>



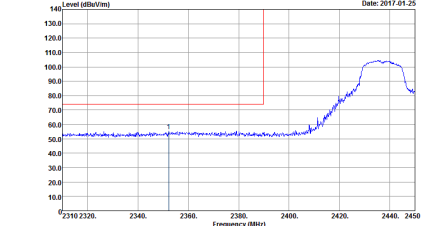
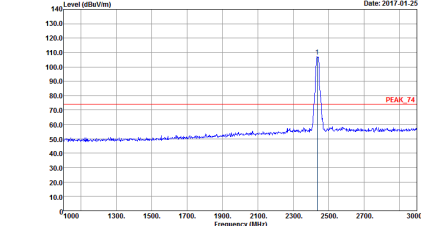
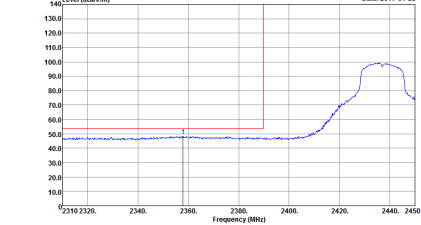
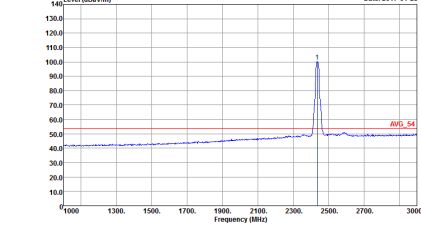

WIFI	2.4GHz 2400~2483.5MHz Band Edge @ 3m	
ANT	802.11g CH06 2437MHz - L	
1	Horizontal	Fundamental
Peak	 <p>Site : 03CH074Y            Condition : PEAK_BE_74 3m HF-ANT_130829 HORIZONTAL            Detector : RBW:1000 000kHz VBW:3000 000kHz SWT:Auto            Project : Peak            Mode : 5</p>	 <p>Site : 03CH074Y            Condition : PEAK_74 3m HF-ANT_130829 HORIZONTAL            Detector : RBW:1000 000kHz VBW:3000 000kHz SWT:Auto            Project : Peak            Mode : 5</p>
Avg.	 <p>Site : 03CH074Y            Condition : AVG_BE_54 3m HF-ANT_130829 HORIZONTAL            Detector : RBW:1000 000kHz VBW:10 000kHz SWT:Auto            Project : Peak            Mode : 5</p>	 <p>Site : 03CH074Y            Condition : AVG_54 3m HF-ANT_130829 HORIZONTAL            Detector : RBW:1000 000kHz VBW:10 000kHz SWT:Auto            Project : Peak            Mode : 5</p>

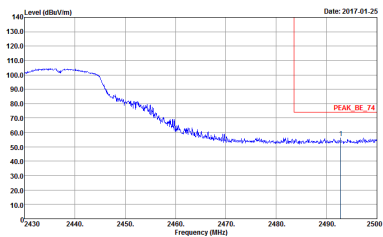
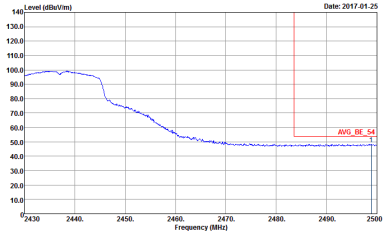

WIFI	2.4GHz 2400~2483.5MHz Band Edge @ 3m	
ANT	802.11g CH06 2437MHz - R	
1	Horizontal	Fundamental
Peak	 <p>           Date: 2017.01.25            Site : 03CH074Y            Condition : PEAK_BE_74 3m HF-ANT_130829 HORIZONTAL            Detector : Peak            Project : 6D0643            Mode : S         </p>	Left blank
Avg.	 <p>           Date: 2017.01.25            Site : 03CH074Y            Condition : AVG_BE_54 3m HF-ANT_130829 HORIZONTAL            Detector : Peak            Project : 6D0643            Mode : S         </p>	Left blank



WIFI	2.4GHz 2400~2483.5MHz Band Edge @ 3m	
ANT	802.11g CH06 2437MHz - L	
1	Vertical	Fundamental
Peak	<p>Date: 2017-01-25</p> <p>Site : 03CH074Y            Condition : PEAK_BE_74 3m HF-ANT_130829 VERTICAL            Detector : Peak            Project : 600643            Mode : 5</p>	<p>Date: 2017-01-25</p> <p>Site : 03CH074Y            Condition : PEAK_74 3m HF-ANT_130829 VERTICAL            Detector : Peak            Project : 600643            Mode : 5</p>
Avg.	<p>Date: 2017-01-25</p> <p>Site : 03CH074Y            Condition : AVG_BE_54 3m HF-ANT_130829 VERTICAL            Detector : Peak            Project : 600643            Mode : 5</p>	<p>Date: 2017-01-25</p> <p>Site : 03CH074Y            Condition : AVG_54 3m HF-ANT_130829 VERTICAL            Detector : Peak            Project : 600643            Mode : 5</p>

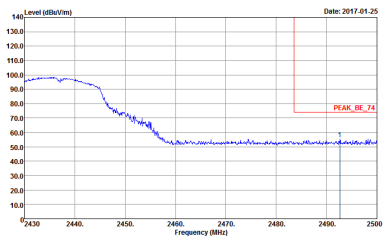
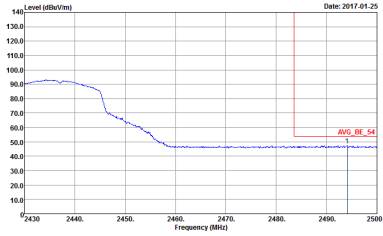

WIFI	2.4GHz 2400~2483.5MHz Band Edge @ 3m	
ANT	802.11g CH06 2437MHz - R	
1	Vertical	Fundamental
<p><b>Peak</b></p>	 <p>Site : 63CH074Y            Condition : PEAK_BE_74 3m HF-ANT_130829 VERTICAL            Detector : Peak            Project : 6D0643            Mode : S</p>	<p>Left Blank</p>
<p><b>Avg.</b></p>	 <p>Site : 63CH074Y            Condition : AVG_BE_54 3m HF-ANT_130829 VERTICAL            Detector : Peak            Project : 6D0643            Mode : S</p>	<p>Left Blank</p>

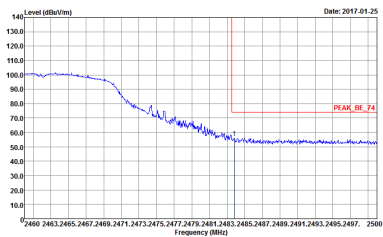
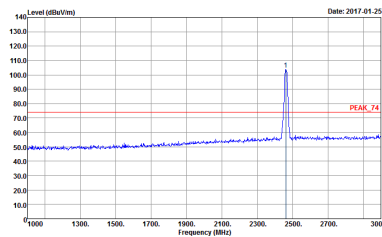
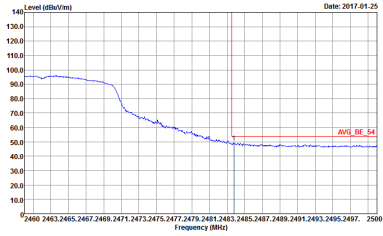
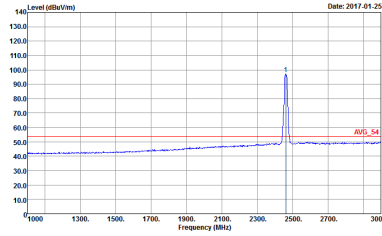

WIFI	2.4GHz 2400~2483.5MHz Band Edge @ 3m	
ANT	802.11g CH11 2462MHz	
1	Horizontal	Fundamental
Peak	 <p>Level (dBm/1m) vs Frequency (MHz) plot for Horizontal orientation. The plot shows a signal level starting at approximately 100 dBm/1m at 2400 MHz and decreasing to about 50 dBm/1m at 2483.5 MHz. A red vertical line marks the peak at 2462 MHz, labeled 'PEAK_BE_74'.</p> <p>Site : 03CH074Y            Condition : PEAK_BE_74 3m HF-ANT_130829 HORIZONTAL            Detector : Peak            Project : 6D0643            Mode : 6</p>	 <p>Level (dBm/1m) vs Frequency (MHz) plot for Fundamental orientation. The plot shows a sharp peak at 2462 MHz with a level of approximately 100 dBm/1m. A red vertical line marks the peak, labeled 'PEAK_74'.</p> <p>Site : 03CH074Y            Condition : PEAK_74 3m HF-ANT_130829 HORIZONTAL            Detector : Peak            Project : 6D0643            Mode : 6</p>
Avg.	 <p>Level (dBm/1m) vs Frequency (MHz) plot for Horizontal orientation. The plot shows the average signal level, which is smoother than the peak plot. A red vertical line marks the average level at 2462 MHz, labeled 'AVG_BE_54'.</p> <p>Site : 03CH074Y            Condition : AVG_BE_54 3m HF-ANT_130829 HORIZONTAL            Detector : Peak            Project : 6D0643            Mode : 6</p>	 <p>Level (dBm/1m) vs Frequency (MHz) plot for Fundamental orientation. The plot shows the average signal level, with a sharp peak at 2462 MHz. A red vertical line marks the average level at 2462 MHz, labeled 'AVG_54'.</p> <p>Site : 03CH074Y            Condition : AVG_54 3m HF-ANT_130829 HORIZONTAL            Detector : Peak            Project : 6D0643            Mode : 6</p>

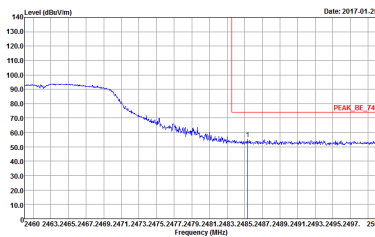
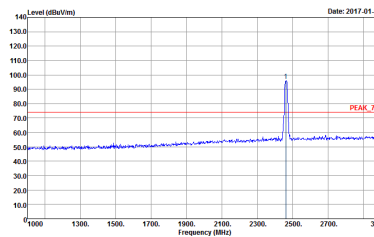
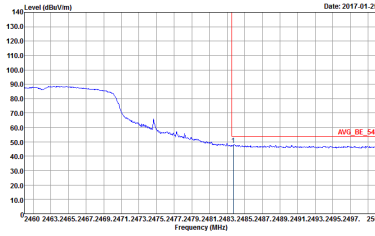
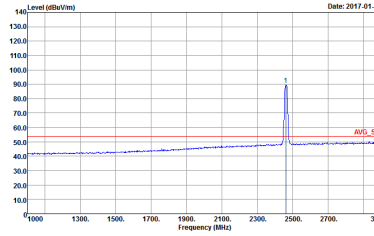

WIFI	2.4GHz 2400~2483.5MHz Band Edge @ 3m	
ANT	802.11g CH11 2462MHz	
1	Vertical	Fundamental
Peak	 <p>Site : 03CH074Y            Condition : PEAK_BE_74 3m HF-ANT_130829 VERTICAL            RBW:1000.000kHz VBW:3000.000kHz SWT:Auto            Detector : Peak            Project : 6D0643            Mode : 6</p>	 <p>Site : 03CH074Y            Condition : PEAK_74 3m HF-ANT_130829 VERTICAL            RBW:1000.000kHz VBW:3000.000kHz SWT:Auto            Detector : Peak            Project : 6D0643            Mode : 6</p>
Avg.	 <p>Site : 03CH074Y            Condition : AVG_BE_54 3m HF-ANT_130829 VERTICAL            RBW:1000.000kHz VBW:10.000kHz SWT:Auto            Detector : Peak            Project : 6D0643            Mode : 6</p>	 <p>Site : 03CH074Y            Condition : AVG_54 3m HF-ANT_130829 VERTICAL            RBW:1000.000kHz VBW:10.000kHz SWT:Auto            Detector : Peak            Project : 6D0643            Mode : 6</p>



2.4GHz 2400~2483.5MHz

WIFI 802.11n HT20 (Band Edge @ 3m)

WIFI	2.4GHz 2400~2483.5MHz Band Edge @ 3m	
ANT	802.11n HT20 CH01 2412MHz	
1	Horizontal	Fundamental
Peak	<p>Site : 03CH07-FY            Condition : PEAK_BE_74 3m HF-ANT_130829 HORIZONTAL            Detector : Peak            Project : 6D0643            Mode : 7</p>	<p>Site : 03CH07-FY            Condition : PEAK_74 3m HF-ANT_130829 HORIZONTAL            Detector : Peak            Project : 6D0643            Mode : 7</p>
Avg.	<p>Site : 03CH07-FY            Condition : AVG_BE_74 3m HF-ANT_130829 HORIZONTAL            Detector : Peak            Project : 6D0643            Mode : 7</p>	<p>Site : 03CH07-FY            Condition : AVG_54 3m HF-ANT_130829 HORIZONTAL            Detector : Peak            Project : 6D0643            Mode : 7</p>



WIFI	2.4GHz 2400~2483.5MHz Band Edge @ 3m	
ANT	802.11n HT20 CH01 2412MHz	
1	Vertical	Fundamental
<b>Peak</b>	<p>Site : 03CH074Y            Condition : PEAK_BE_74 3m HF-ANT_130829 VERTICAL            Detector : Peak            Project : 620643            Mode : 7</p>	<p>Site : 03CH074Y            Condition : PEAK_74 3m HF-ANT_130829 VERTICAL            Detector : Peak            Project : 620643            Mode : 7</p>
<b>Avg.</b>	<p>Site : 03CH074Y            Condition : AVG_BE_54 3m HF-ANT_130829 VERTICAL            Detector : Peak            Project : 620643            Mode : 7</p>	<p>Site : 03CH074Y            Condition : AVG_54 3m HF-ANT_130829 VERTICAL            Detector : Peak            Project : 620643            Mode : 7</p>



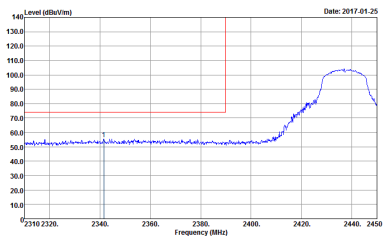
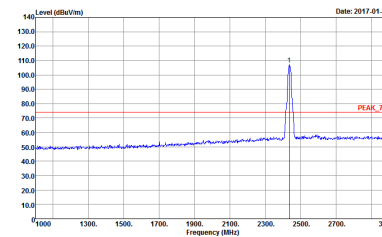
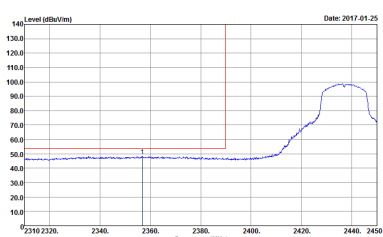
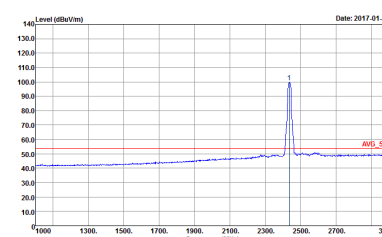

WIFI	2.4GHz 2400~2483.5MHz Band Edge @ 3m	
ANT	802.11n HT20 CH06 2437MHz - L	
1	Horizontal	Fundamental
<b>Peak</b>	 <p>Site : 03CH074Y            Condition : PEAK_BE_74 3m HF-ANT_130829 HORIZONTAL            Detector : Peak            Project : 6D0643            Mode : 0</p>	 <p>Site : 03CH074Y            Condition : PEAK_74 3m HF-ANT_130829 HORIZONTAL            Detector : Peak            Project : 6D0643            Mode : 0</p>
<b>Avg.</b>	 <p>Site : 03CH074Y            Condition : AVG_BE_54 3m HF-ANT_130829 HORIZONTAL            Detector : Peak            Project : 6D0643            Mode : 0</p>	 <p>Site : 03CH074Y            Condition : AVG_54 3m HF-ANT_130829 HORIZONTAL            Detector : Peak            Project : 6D0643            Mode : 0</p>

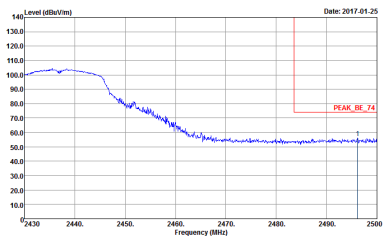
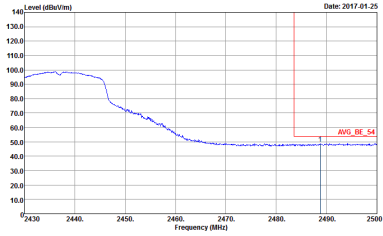

WIFI	2.4GHz 2400~2483.5MHz Band Edge @ 3m	
ANT	802.11n HT20 CH06 2437MHz - R	
1	Horizontal	Fundamental
Peak	 <p>           Date: 2017.01.25            Site : 63CH074Y            Condition : PEAK_BE_74 3m HF-ANT_130829 HORIZONTAL            Detector : Peak            Project : 6D0643            Mode : 0         </p>	Left blank
Avg.	 <p>           Date: 2017.01.25            Site : 63CH074Y            Condition : AVG_BE_54 3m HF-ANT_130829 HORIZONTAL            Detector : Peak            Project : 6D0643            Mode : 0         </p>	Left blank



WIFI	2.4GHz 2400~2483.5MHz Band Edge @ 3m	
ANT	802.11n HT20 CH06 2437MHz - L	
1	Vertical	Fundamental
<b>Peak</b>	<p>Site : 03CH074Y            Condition : PEAK_BE_74 3m HF-ANT_130829 VERTICAL            Detector : Peak            Project : 6D0643            Mode : 8</p>	<p>Site : 03CH074Y            Condition : PEAK_74 3m HF-ANT_130829 VERTICAL            Detector : Peak            Project : 6D0643            Mode : 8</p>
<b>Avg.</b>	<p>Site : 03CH074Y            Condition : AVG_BE_54 3m HF-ANT_130829 VERTICAL            Detector : Peak            Project : 6D0643            Mode : 8</p>	<p>Site : 03CH074Y            Condition : AVG_54 3m HF-ANT_130829 VERTICAL            Detector : Peak            Project : 6D0643            Mode : 8</p>

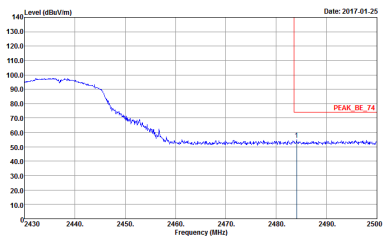
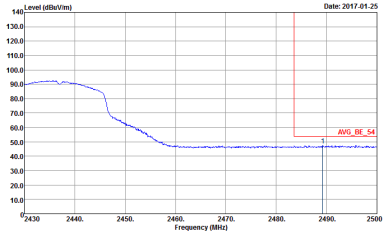

WIFI	2.4GHz 2400~2483.5MHz Band Edge @ 3m	
ANT	802.11n HT20 CH06 2437MHz - R	
1	Vertical	Fundamental
Peak	 <p>           Date: 2017.01.25            Site : 63CH074Y            Condition : PEAK_BE_74 3m HF-ANT_130829 VERTICAL            Detector : Peak            Project : 6D0643            Mode : 0         </p>	Left Blank
Avg.	 <p>           Date: 2017.01.25            Site : 63CH074Y            Condition : AVG_BE_54 3m HF-ANT_130829 VERTICAL            Detector : Peak            Project : 6D0643            Mode : 0         </p>	Left Blank

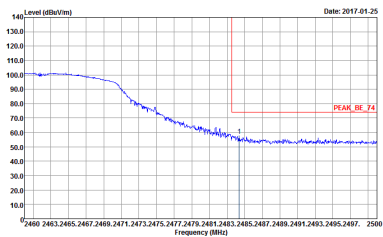
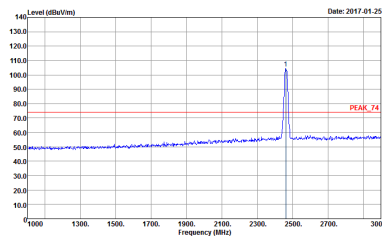
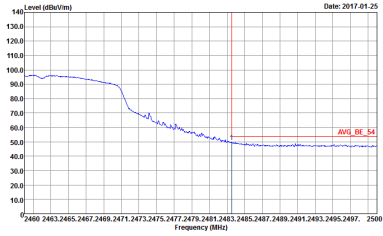
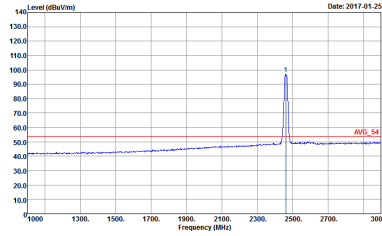

WIFI	2.4GHz 2400~2483.5MHz Band Edge @ 3m	
ANT	802.11n HT20 CH11 2462MHz	
1	Horizontal	Fundamental
Peak	 <p>Level (dBV/m) vs Frequency (MHz) plot for Horizontal orientation. The plot shows a signal level starting at approximately 100 dBV/m at 2400 MHz and decreasing to about 50 dBV/m at 2483.5 MHz. A red vertical line marks the peak at 2462 MHz, labeled 'PEAK_BE_74'.</p> <p>Site : 03CH074Y            Condition : PEAK_BE_74 3m HF-ANT_130829 HORIZONTAL            RBW: 1000.000kHz VBW: 3000.000kHz SWT: Auto            Detector : Peak            Project : 6D0643            Mode : 9</p>	 <p>Level (dBV/m) vs Frequency (MHz) plot for Fundamental orientation. The plot shows a sharp peak at 2462 MHz with a level of approximately 100 dBV/m. A red vertical line marks the peak, labeled 'PEAK_74'.</p> <p>Site : 03CH074Y            Condition : PEAK_74 3m HF-ANT_130829 HORIZONTAL            RBW: 1000.000kHz VBW: 3000.000kHz SWT: Auto            Detector : Peak            Project : 6D0643            Mode : 9</p>
Avg.	 <p>Level (dBV/m) vs Frequency (MHz) plot for Horizontal orientation. The plot shows an average signal level starting at approximately 90 dBV/m at 2400 MHz and decreasing to about 45 dBV/m at 2483.5 MHz. A red vertical line marks the average level at 2462 MHz, labeled 'AVG_BE_54'.</p> <p>Site : 03CH074Y            Condition : AVG_BE_54 3m HF-ANT_130829 HORIZONTAL            RBW: 1000.000kHz VBW: 10.000kHz SWT: Auto            Detector : Peak            Project : 6D0643            Mode : 9</p>	 <p>Level (dBV/m) vs Frequency (MHz) plot for Fundamental orientation. The plot shows a sharp peak at 2462 MHz with an average level of approximately 90 dBV/m. A red vertical line marks the average level, labeled 'AVG_54'.</p> <p>Site : 03CH074Y            Condition : AVG_54 3m HF-ANT_130829 HORIZONTAL            RBW: 1000.000kHz VBW: 10.000kHz SWT: Auto            Detector : Peak            Project : 6D0643            Mode : 9</p>

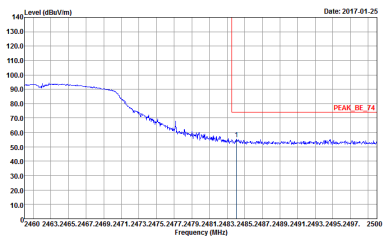
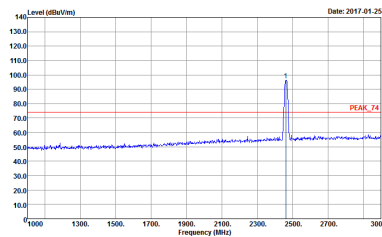
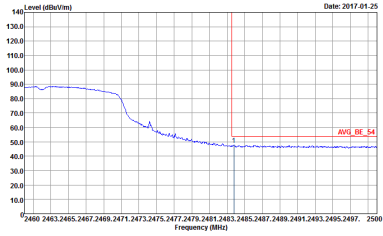
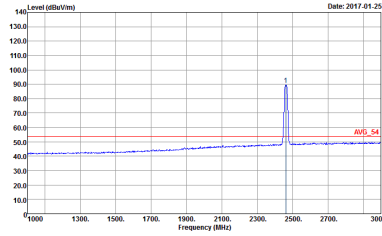

WIFI	2.4GHz 2400~2483.5MHz Fundamental @ 3m	
ANT	802.11n HT20 CH11 2462MHz	
1	Vertical	Fundamental
Peak	 <p>Date: 2017-01-25</p> <p>Site : 03CH074Y            Condition : PEAK_BE_74 3m HF-ANT_130829 VERTICAL            RBW:1000.000kHz VBW:3000.000kHz SWT:Auto            Detector : Peak            Project : 6D0643            Mode : 9</p>	 <p>Date: 2017-01-25</p> <p>Site : 03CH074Y            Condition : PEAK_74 3m HF-ANT_130829 VERTICAL            RBW:1000.000kHz VBW:3000.000kHz SWT:Auto            Detector : Peak            Project : 6D0643            Mode : 9</p>
Avg.	 <p>Date: 2017-01-25</p> <p>Site : 03CH074Y            Condition : AVG_BE_54 3m HF-ANT_130829 VERTICAL            RBW:1000.000kHz VBW:10.000kHz SWT:Auto            Detector : Peak            Project : 6D0643            Mode : 9</p>	 <p>Date: 2017-01-25</p> <p>Site : 03CH074Y            Condition : AVG_54 3m HF-ANT_130829 VERTICAL            RBW:1000.000kHz VBW:10.000kHz SWT:Auto            Detector : Peak            Project : 6D0643            Mode : 9</p>



2.4GHz 2400~2483.5MHz

WIFI 802.11b (Harmonic @ 3m)

WIFI	2.4GHz 2400~2483.5MHz Harmonic @ 3m	
ANT	802.11b CH01 2412MHz	
1	Horizontal	Vertical
Peak Avg.	<p>Site : 03CH07-4Y Condition : PEAK_74 3m SHF-EHF_131029 HORIZONTAL Detector : Peak Project : 600643 Mode : 1</p>	<p>Site : 03CH07-4Y Condition : PEAK_74 3m SHF-EHF_131029 VERTICAL Detector : Peak Project : 600643 Mode : 1</p>

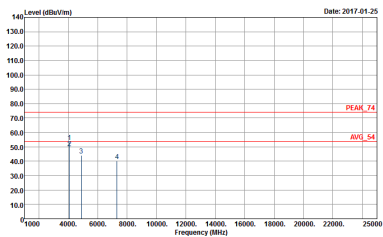
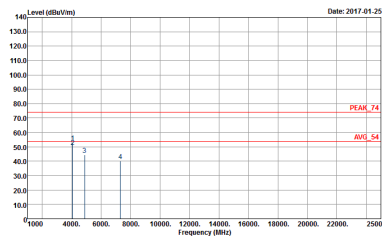

WIFI	2.4GHz 2400~2483.5MHz Harmonic @ 3m	
ANT	802.11b CH06 2437MHz	
1	Horizontal	Vertical
<p>Peak Avg.</p>	 <p>Site : 03CH07-41Y Condition : PEAK_74 3m SHF-EHF_131029 HORIZONTAL Detector : Peak Project : 620643 Mode : 2</p>	 <p>Site : 03CH07-41Y Condition : PEAK_74 3m SHF-EHF_131029 VERTICAL Detector : Peak Project : 620643 Mode : 2</p>





WIFI	2.4GHz 2400~2483.5MHz Harmonic @ 3m	
ANT	802.11b CH11 2462MHz	
1	Horizontal	Vertical
Peak Avg.	<p>Site : 03CH07-41Y Condition : PEAK_74 3m SHF-EHF_131029 HORIZONTAL Detector : Peak Project : 620643 Mode : 3</p>	<p>Site : 03CH07-41Y Condition : PEAK_74 3m SHF-EHF_131029 VERTICAL Detector : Peak Project : 620643 Mode : 3</p>



2.4GHz 2400~2483.5MHz

WIFI 802.11g (Harmonic @ 3m)

WIFI	2.4GHz 2400~2483.5MHz Harmonic @ 3m	
ANT	802.11g CH01 2412MHz	
1	Horizontal	Vertical
Peak Avg.	<p>Site : 03CH07-4Y Condition : PEAK_74 3m SHF-EHF_131029 HORIZONTAL Detector : Peak Project : 600643 Mode : 4</p>	<p>Site : 03CH07-4Y Condition : PEAK_74 3m SHF-EHF_131029 VERTICAL Detector : Peak Project : 600643 Mode : 4</p>

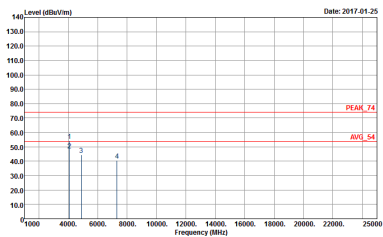
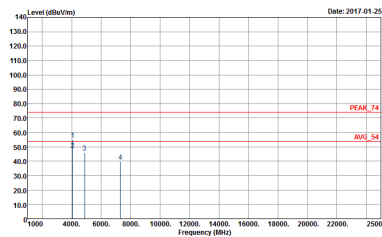

WIFI	2.4GHz 2400~2483.5MHz Harmonic @ 3m	
ANT	802.11g CH06 2437MHz	
1	Horizontal	Vertical
<p>Peak Avg.</p>	 <p>Site : 03CH07-41Y Condition : PEAK_74 3m SHF-EHF_131029 HORIZONTAL Detector : Peak Project : 620643 Mode : 5</p>	 <p>Site : 03CH07-41Y Condition : PEAK_74 3m SHF-EHF_131029 VERTICAL Detector : Peak Project : 620643 Mode : 5</p>



WIFI	2.4GHz 2400~2483.5MHz Harmonic @ 3m	
ANT	802.11g CH11 2462MHz	
1	Horizontal	Vertical
Peak Avg.	<p>Site : 03CH07-41Y Condition : PEAK_74 3m SHF-EHF_131029 HORIZONTAL Detector : Peak Project : 620643 Mode : 6</p>	<p>Site : 03CH07-41Y Condition : PEAK_74 3m SHF-EHF_131029 VERTICAL Detector : Peak Project : 620643 Mode : 6</p>



2.4GHz 2400~2483.5MHz

WIFI 802.11n HT20 (Harmonic @ 3m)

WIFI	2.4GHz 2400~2483.5MHz Harmonic @ 3m	
ANT	802.11n HT20 CH01 2412MHz	
1	Horizontal	Vertical
Peak Avg.	<p>Site : 03CH07-4Y Condition : PEAK_74 3m SHF-EHF_131029 HORIZONTAL Detector : Peak Project : 620643 Mode : 7</p>	<p>Site : 03CH07-4Y Condition : PEAK_74 3m SHF-EHF_131029 VERTICAL Detector : Peak Project : 620643 Mode : 7</p>

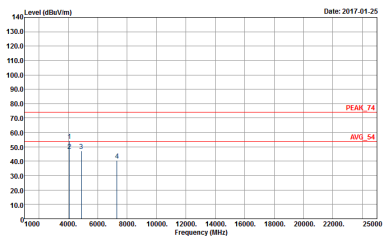
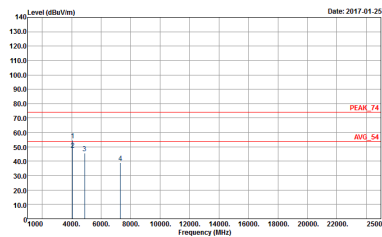

WIFI	2.4GHz 2400~2483.5MHz Harmonic @ 3m	
ANT	802.11n HT20 CH06 2437MHz	
1	Horizontal	Vertical
<p>Peak Avg.</p>	 <p>Site : 03CH07-41Y Condition : PEAK_74 3m SHF-EHF_131029 HORIZONTAL Detector : Peak Project : 620643 Mode : 8</p>	 <p>Site : 03CH07-41Y Condition : PEAK_74 3m SHF-EHF_131029 VERTICAL Detector : Peak Project : 620643 Mode : 8</p>

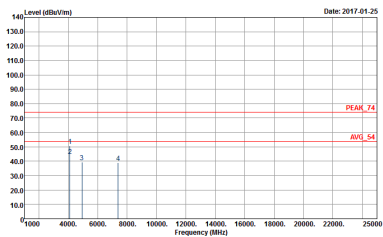
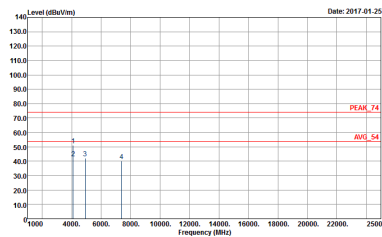

WIFI	2.4GHz 2400~2483.5MHz Harmonic @ 3m	
ANT	802.11n HT20 CH11 2462MHz	
1	Horizontal	Vertical
<p>Peak Avg.</p>	 <p>Site : 03CH074Y Condition : PEAK_74 3m SHF-EHF_131029 HORIZONTAL Detector : Peak Project : 620643 Mode : 9</p>	 <p>Site : 03CH074Y Condition : PEAK_74 3m SHF-EHF_131029 VERTICAL Detector : Peak Project : 620643 Mode : 9</p>



Emission below 1GHz  
2.4GHz WIFI 802.11b (LF)

WIFI	2.4GHz 2400~2483.5MHz	
ANT	802.11b LF	
1	Horizontal	Vertical
QP / Peak	<p>Site : 03CH07-ARY Condition : QP-3m LF-ANT-35419(E) HORIZONTAL Detector : Peak Project : 620643 Mode : 10</p>	<p>Site : 03CH07-ARY Condition : QP-3m LF-ANT-35419(E) VERTICAL Detector : Peak Project : 620643 Mode : 10</p>





## Appendix E. Duty Cycle Plots

Band	T(us)	1/T(kHz)	VBW Setting
802.11b	11420.30	0.09	100Hz
802.11g	1898.60	0.53	1kHz
2.4GHz 802.11n HT20	1768.10	0.57	

**Note:** Duty cycle is non-constant.