FCC Test Report

Report No.: AGC00006220501FE02

FCC ID : Z63-Q2C013

APPLICATION PURPOSE : Original Equipment

PRODUCT DESIGNATION : Bluetooth Dongle

BRAND NAME : ANC, aoni

MODEL NAME : C013

APPLICANT : SHENZHEN AONI ELECTRONIC CO., LTD

DATE OF ISSUE : May 23, 2022

STANDARD(S) : FCC Part 15.247

REPORT VERSION : V1.0

Attestation of Global Compliance (Shenzhen) Co., Ltd



Any report having not been signed by authorized approver, or having been altered without authorization, or having not been stamped by the "Dedicated Testing/Inspection Stamp" is deemed to be invalid. Copying or excerpting portion of, or altering the content of the report is not permitted without the written authorization of AGC. The test results presented in the report apply only to the tested sample. Any objections to report issued by AGC should be submitted to AGC within 15days after the issuance of the test report. Further enquiry of validity or verification of the test report should be addressed to AGC by agc01@agccert.com.

Attestation of Global Compliance(Shenzhen)Co., Ltd
Attestation of Global Compliance(Shenzhen)Std & Tech Co., Ltd
Tel: +86-755 2523 4088 E-mail: agc@agccert.com Web: <http://www.agccert.com/>



REPORT REVISE RECORD

Report Version	Revise Time	Issued Date	Valid Version	Notes
V1.0	/	May 23, 2022	Valid	Initial Release

Any report having not been signed by authorized approver, or having been altered without authorization, or having not been stamped by the "Dedicated Testing/Inspection Stamp" is deemed to be invalid. Copying or excerpting portion of, or altering the content of the report is not permitted without the written authorization of AGC. The test results presented in the report apply only to the tested sample. Any objections to report issued by AGC should be submitted to AGC within 15days after the issuance of the test report. Further enquiry of validity or verification of the test report should be addressed to AGC by agc01@agccert.com.

TABLE OF CONTENTS

1. VERIFICATION OF COMPLIANCE	5
2. GENERAL INFORMATION	6
2.1. PRODUCT DESCRIPTION	6
2.2. TABLE OF CARRIER FREQUENCIES	6
2.3. RELATED SUBMITTAL(S)/GRANT(S).....	7
2.4. TEST METHODOLOGY	7
2.5. SPECIAL ACCESSORIES.....	7
2.6. EQUIPMENT MODIFICATIONS.....	7
2.7. ANTENNA REQUIREMENT	7
3. MEASUREMENT UNCERTAINTY	8
4. DESCRIPTION OF TEST MODES	9
5. SYSTEM TEST CONFIGURATION	10
5.1. CONFIGURATION OF TESTED SYSTEM.....	10
5.2. EQUIPMENT USED IN TESTED SYSTEM	10
5.3. SUMMARY OF TEST RESULTS	10
6. TEST FACILITY	11
7. PEAK OUTPUT POWER	12
7.1. MEASUREMENT PROCEDURE.....	12
7.2. TEST SET-UP (BLOCK DIAGRAM OF CONFIGURATION)	12
7.3. LIMITS AND MEASUREMENT RESULT	13
8. BANDWIDTH	15
8.1. MEASUREMENT PROCEDURE.....	15
8.2. TEST SET-UP (BLOCK DIAGRAM OF CONFIGURATION)	15
8.3. LIMITS AND MEASUREMENT RESULTS	15
9. CONDUCTED SPURIOUS EMISSION	19
9.1. MEASUREMENT PROCEDURE.....	19
9.2. TEST SET-UP (BLOCK DIAGRAM OF CONFIGURATION)	19
9.3. MEASUREMENT EQUIPMENT USED	19
9.4. LIMITS AND MEASUREMENT RESULT	19
10. MAXIMUM CONDUCTED OUTPUT POWER SPECTRAL DENSITY	26
10.1. MEASUREMENT PROCEDURE.....	26
10.2. TEST SET-UP (BLOCK DIAGRAM OF CONFIGURATION)	26
10.3. MEASUREMENT EQUIPMENT USED	26
10.4. LIMITS AND MEASUREMENT RESULT	26
11. RADIATED EMISSION	28
11.1. MEASUREMENT PROCEDURE.....	28
11.2. TEST SETUP.....	29
11.3. LIMITS AND MEASUREMENT RESULT	30
11.4. TEST RESULT.....	30
12. LINE CONDUCTED EMISSION TEST	40
12.1. LIMITS OF LINE CONDUCTED EMISSION TEST.....	40
12.2. BLOCK DIAGRAM OF LINE CONDUCTED EMISSION TEST	40

Any report having not been signed by authorized approver, or having been altered without authorization, or having not been stamped by the "Dedicated Testing/Inspection Stamp" is deemed to be invalid. Copying or excerpting portion of, or altering the content of the report is not permitted without the written authorization of AGC. The test results presented in the report apply only to the tested sample. Any objections to report issued by AGC should be submitted to AGC within 15days after the issuance of the test report. Further enquiry of validity or verification of the test report should be addressed to AGC by agc01@agccert.com.

12.3. PRELIMINARY PROCEDURE OF LINE CONDUCTED EMISSION TEST..... 41
12.4. FINAL PROCEDURE OF LINE CONDUCTED EMISSION TEST 41
12.5. TEST RESULT OF LINE CONDUCTED EMISSION TEST 42
APPENDIX A: PHOTOGRAPHS OF TEST SETUP 44
APPENDIX B: PHOTOGRAPHS OF EUT 44

Any report having not been signed by authorized approver, or having been altered without authorization, or having not been stamped by the “Dedicated Testing/Inspection Stamp” is deemed to be invalid. Copying or excerpting portion of, or altering the content of the report is not permitted without the written authorization of AGC. The test results presented in the report apply only to the tested sample. Any objections to report issued by AGC should be submitted to AGC within 15days after the issuance of the test report. Further enquiry of validity or verification of the test report should be addressed to AGC by agc01@agccert.com.

1. VERIFICATION OF COMPLIANCE

Applicant	SHENZHEN AONI ELECTRONIC CO., LTD
Address	No.5, Bldg., Honghui Industrial Park,2nd Liuxian Road, Xin'An streets, Bao'an District, Shenzhen, China
Manufacturer	SHENZHEN AONI ELECTRONIC CO., LTD
Address	No.5, Bldg., Honghui Industrial Park,2nd Liuxian Road, Xin'An streets, Bao'an District, Shenzhen, China
Factory	SHENZHEN AONI ELECTRONIC CO., LTD
Address	No.5, Bldg., Honghui Industrial Park,2nd Liuxian Road, Xin'An streets, Bao'an District, Shenzhen, China
Product Designation	Bluetooth Dongle
Brand Name	ANC, aoni
Test Model	C013
Date of test	May 11, 2022 to May 23, 2022
Deviation	None
Condition of Test Sample	Normal
Test Result	Pass
Report Template	AGCRT-US-BLE/RF

We hereby certify that:

The above equipment was tested by Attestation of Global Compliance (Shenzhen) Co., Ltd. The test data, data evaluation, test procedures, and equipment configurations shown in this report were made in accordance with the procedures given in ANSI C63.10 (2013) and the energy emitted by the sample EUT tested as described in this report is in compliance with radiated emission limits of FCC part 15.247.

Prepared By 

 Thea Huang
 (Project Engineer) May 23, 2022

Reviewed By 

 Calvin Liu
 (Reviewer) May 23, 2022

Approved By 

 Max Zhang
 (Authorized Officer) May 23, 2022

Any report having not been signed by authorized approver, or having been altered without authorization, or having not been stamped by the "Dedicated Testing/Inspection Stamp" is deemed to be invalid. Copying or excerpting portion of, or altering the content of the report is not permitted without the written authorization of AGC. The test results presented in the report apply only to the tested sample. Any objections to report issued by AGC should be submitted to AGC within 15days after the issuance of the test report. Further enquiry of validity or verification of the test report should be addressed to AGC by agc01@agccert.com.

2. GENERAL INFORMATION

2.1. PRODUCT DESCRIPTION

The EUT is designed as a “Bluetooth Dongle”. It is designed by way of utilizing the GFSK technology to achieve the system operation.

A major technical description of EUT is described as following

Operation Frequency	2.402 GHz to 2.480GHz
RF Output Power	-5.276dBm (Max)
Bluetooth Version	V5.0
Modulation	BR <input type="checkbox"/> GFSK, EDR <input type="checkbox"/> π /4-DQPSK, <input type="checkbox"/> 8DPSK BLE <input checked="" type="checkbox"/> GFSK 1Mbps <input type="checkbox"/> GFSK 2Mbps
Number of channels	40 Channels
Antenna Designation	PCB Antenna (Comply with requirements of the FCC part 15.203)
Antenna Gain	0.63dBi
Hardware Version	V10
Software Version	V05
Power Supply	DC 5V by PC

2.2. TABLE OF CARRIER FREQUENCIES

Frequency Band	Channel Number	Frequency
2400~2483.5MHz	0	2402 MHz
	1	2404 MHz
	:	:
	38	2478 MHz
	39	2480 MHz

Any report having not been signed by authorized approver, or having been altered without authorization, or having not been stamped by the “Dedicated Testing/Inspection Stamp” is deemed to be invalid. Copying or excerpting portion of, or altering the content of the report is not permitted without the written authorization of AGC. The test results presented in the report apply only to the tested sample. Any objections to report issued by AGC should be submitted to AGC within 15days after the issuance of the test report. Further enquiry of validity or verification of the test report should be addressed to AGC by agc01@agccert.com.

2.3. RELATED SUBMITTAL(S)/GRANT(S)

This submittal(s) (test report) is intended for **FCC ID: Z63-Q2C013** filing to comply with the FCC Part 15.247 requirements.

2.4. TEST METHODOLOGY

Both conducted and radiated testing was performed according to the procedures in ANSI C63.10 (2013). Radiated testing was performed at an antenna to EUT distance 3 meters.

2.5. SPECIAL ACCESSORIES

Refer to section 5.2.

2.6. EQUIPMENT MODIFICATIONS

Not available for this EUT intended for grant.

2.7. ANTENNA REQUIREMENT

This intentional radiator is designed with a permanently attached antenna of an antenna to ensure that no antenna other than that furnished by the responsible party shall be used with the device. For more information of the antenna, please refer to the APPENDIX B: PHOTOGRAPHS OF EUT.

3. MEASUREMENT UNCERTAINTY

The reported uncertainty of measurement $y \pm U$, where expanded uncertainty U is based on a standard uncertainty multiplied by a coverage factor of $k=2$, providing a level of confidence of approximately 95%.

Item	Measurement Uncertainty
Uncertainty of Conducted Emission for AC Port	$U_c = \pm 3.1$ dB
Uncertainty of Radiated Emission below 1GHz	$U_c = \pm 4.0$ dB
Uncertainty of Radiated Emission above 1GHz	$U_c = \pm 4.8$ dB
Uncertainty of total RF power, conducted	$U_c = \pm 0.8$ dB
Uncertainty of RF power density, conducted	$U_c = \pm 2.6$ dB
Uncertainty of spurious emissions, conducted	$U_c = \pm 2$ %
Uncertainty of Occupied Channel Bandwidth	$U_c = \pm 2$ %

Any report having not been signed by authorized approver, or having been altered without authorization, or having not been stamped by the "Dedicated Testing/Inspection Stamp" is deemed to be invalid. Copying or excerpting portion of, or altering the content of the report is not permitted without the written authorization of AGC. The test results presented in the report apply only to the tested sample. Any objections to report issued by AGC should be submitted to AGC within 15days after the issuance of the test report. Further enquiry of validity or verification of the test report should be addressed to AGC by agc01@agccert.com.

4. DESCRIPTION OF TEST MODES

NO.	TEST MODE DESCRIPTION
1	Low channel TX
2	Middle channel TX
3	High channel TX

Note:

1. Only the result of the worst case was recorded in the report, if no other cases.
2. For Radiated Emission, 3axis were chosen for testing for each applicable mode.
3. For Conducted Test method, a temporary antenna connector is provided by the manufacture.

Software Setting

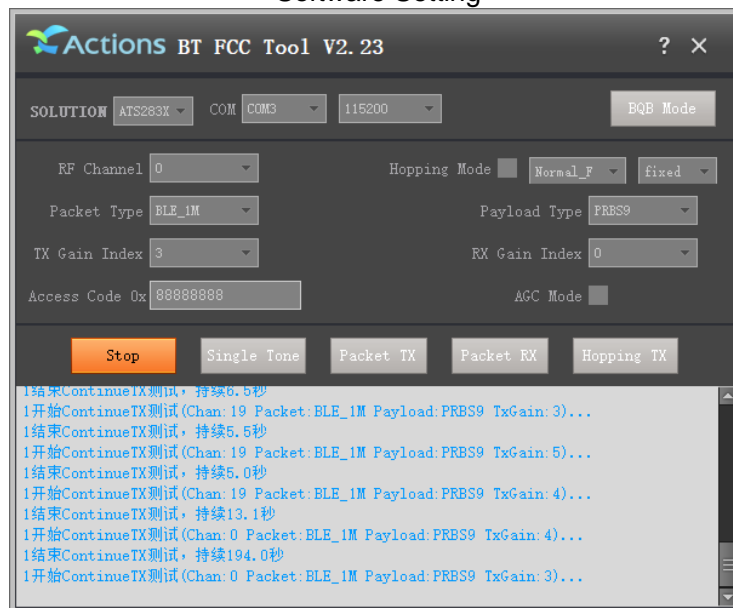

Any report having not been signed by authorized approver, or having been altered without authorization, or having not been stamped by the “Dedicated Testing/Inspection Stamp” is deemed to be invalid. Copying or excerpting portion of, or altering the content of the report is not permitted without the written authorization of AGC. The test results presented in the report apply only to the tested sample. Any objections to report issued by AGC should be submitted to AGC within 15days after the issuance of the test report. Further enquiry of validity or verification of the test report should be addressed to AGC by agc01@agccert.com.

5. SYSTEM TEST CONFIGURATION

5.1. CONFIGURATION OF TESTED SYSTEM

Radiated Emission Configure:

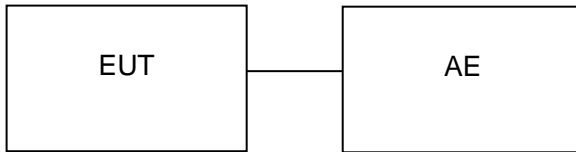

Conducted Emission Configure:

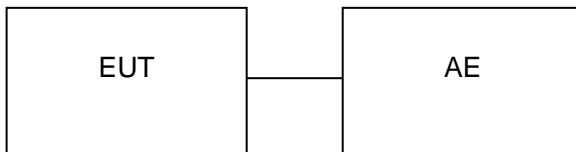

5.2. EQUIPMENT USED IN TESTED SYSTEM

Item	Equipment	Model No.	ID or Specification	Remark
1	Bluetooth Dongle	C013	Z63-Q2C013	EUT
2	Control Box	USB-TTL	N/A	AE
3	Adapter	KT05W050100USU	N/A	AE

5.3. SUMMARY OF TEST RESULTS

FCC RULES	DESCRIPTION OF TEST	RESULT
15.247 (b)(3)	Peak Output Power	Compliant
15.247 (a)(2)	6 dB Bandwidth	Compliant
15.247 (d)	Conducted Spurious Emission	Compliant
15.247 (e)	Maximum Conducted Output Power Density	Compliant
15.209	Radiated Emission	Compliant
15.207	Conducted Emission	Compliant

Any report having not been signed by authorized approver, or having been altered without authorization, or having not been stamped by the "Dedicated Testing/Inspection Stamp" is deemed to be invalid. Copying or excerpting portion of, or altering the content of the report is not permitted without the written authorization of AGC. The test results presented in the report apply only to the tested sample. Any objections to report issued by AGC should be submitted to AGC within 15days after the issuance of the test report. Further enquiry of validity or verification of the test report should be addressed to AGC by agc01@agccert.com.

6. TEST FACILITY

Test Site	Attestation of Global Compliance (Shenzhen) Co., Ltd
Location	1-2/F, Building 19, Junfeng Industrial Park, Chongqing Road, Heping Community, Fuhai Street, Bao'an District, Shenzhen, Guangdong, China
Designation Number	CN1259
FCC Test Firm Registration Number	975832
A2LA Cert. No.	5054.02
Description	Attestation of Global Compliance (Shenzhen) Co., Ltd is accredited by A2LA

TEST EQUIPMENT OF CONDUCTED EMISSION TEST

Equipment	Manufacturer	Model	S/N	Cal. Date	Cal. Due
TEST RECEIVER	R&S	ESPI	101206	Mar. 28, 2022	Mar. 27, 2023
LISN	R&S	ESH2-Z5	100086	Jun. 09, 2021	Jun. 08, 2022
Test software	R&S	ES-K1(Ver.V1.71)	N/A	N/A	N/A

TEST EQUIPMENT OF RADIATED EMISSION TEST

Equipment	Manufacturer	Model	S/N	Cal. Date	Cal. Due
TEST RECEIVER	R&S	ESCI	10096	Mar. 28, 2022	Mar. 27, 2023
EXA Signal Analyzer	Aglient	N9010A	MY53470504	Nov. 17, 2021	Nov. 16, 2022
2.4GHz Filter	EM Electronics	2400-2500	N/A	Mar. 22, 2022	Mar. 21, 2024
Attenuator	ZHINAN	E-002	N/A	Sep. 03, 2020	Sep. 02, 2022
Horn antenna	SCHWARZBECK	BBHA 9170	#768	Oct. 31, 2021	Oct. 30, 2023
Active loop antenna (9K-30MHz)	ZHINAN	ZN30900C	18051	Mar. 12, 2022	Mar. 11, 2024
Double-Ridged Waveguide Horn	ETS LINDGREN	3117	00034609	Apr. 23, 2021	Apr. 22, 2023
Broadband Pre-amplifier	ETS LINDGREN	3117PA	00225134	Sep. 03, 2020	Sep. 02, 2022
ANTENNA	SCHWARZBECK	VULB9168	494	Jan. 08, 2021	Jan. 07, 2023
Test software	Tonscend	JS32-RE (Ver.2.5)	N/A	N/A	N/A

Any report having not been signed by authorized approver, or having been altered without authorization, or having not been stamped by the "Dedicated Testing/Inspection Stamp" is deemed to be invalid. Copying or excerpting portion of, or altering the content of the report is not permitted without the written authorization of AGC. The test results presented in the report apply only to the tested sample. Any objections to report issued by AGC should be submitted to AGC within 15days after the issuance of the test report. Further enquiry of validity or verification of the test report should be addressed to AGC by agc01@agccert.com.

7. PEAK OUTPUT POWER

7.1. MEASUREMENT PROCEDURE

For peak power test:

1. Connect EUT RF output port to the Spectrum Analyzer through an RF attenuator
2. $RBW \geq DTS$ bandwidth
3. $VBW \geq 3 * RBW$.
4. $SPAN \geq VBW$.
5. Sweep: Auto.
6. Detector function: Peak.
7. Trace: Max hold.

Allow trace to stabilize. Use the marker-to-peak function to set the marker to the peak of the emission. The indicated level is the peak output power, after any corrections for external attenuators and cables.

7.2. TEST SET-UP (BLOCK DIAGRAM OF CONFIGURATION) PEAK POWER TEST SETUP

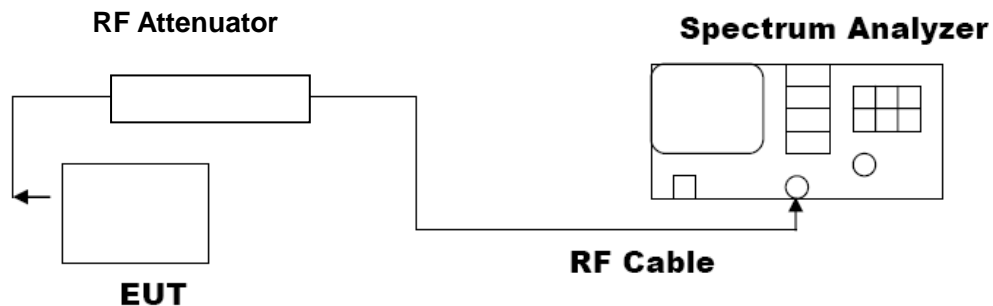

7.3. LIMITS AND MEASUREMENT RESULT

Test Data of Conducted Output Power				
Test Mode	Test Channel (MHz)	Peak Power (dBm)	Limits (dBm)	Pass or Fail
GFSK 1M	2402	-5.276	≤30	Pass
	2440	-5.689	≤30	Pass
	2480	-5.629	≤30	Pass

Test Graphs of Conducted Output Power

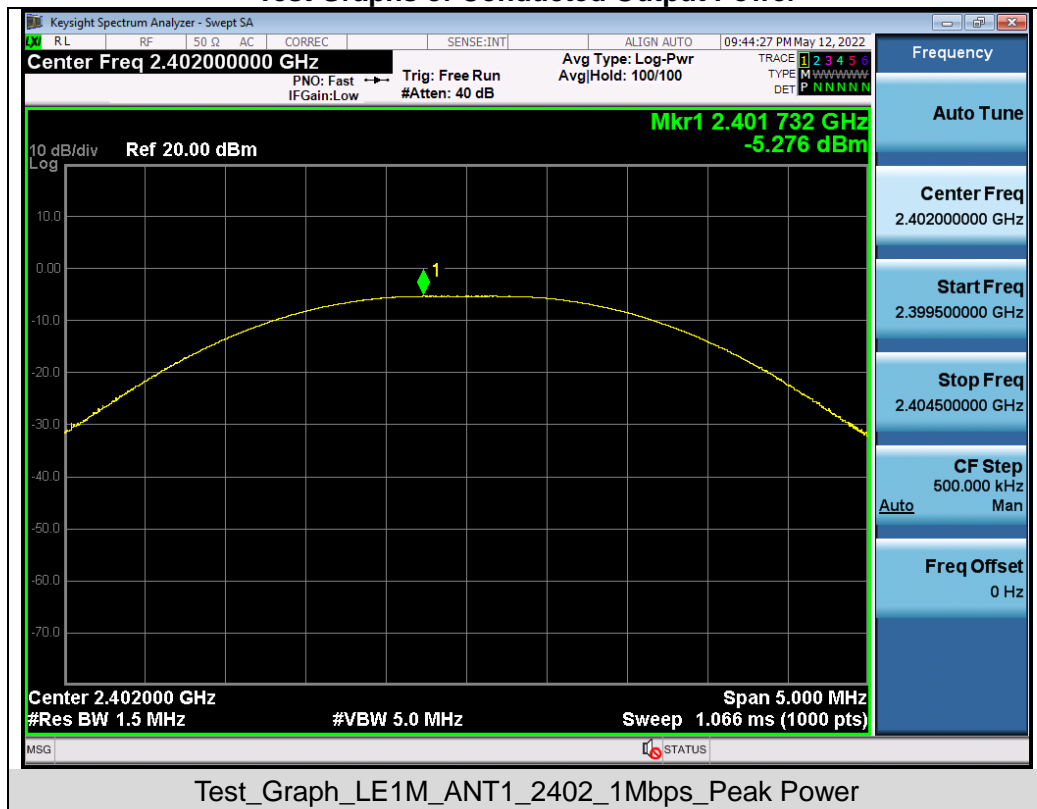

Any report having not been signed by authorized approver, or having been altered without authorization, or having not been stamped by the “Dedicated Testing/Inspection Stamp” is deemed to be invalid. Copying or excerpting portion of, or altering the content of the report is not permitted without the written authorization of AGC. The test results presented in the report apply only to the tested sample. Any objections to report issued by AGC should be submitted to AGC within 15days after the issuance of the test report. Further enquiry of validity or verification of the test report should be addressed to AGC by agc01@agccert.com.

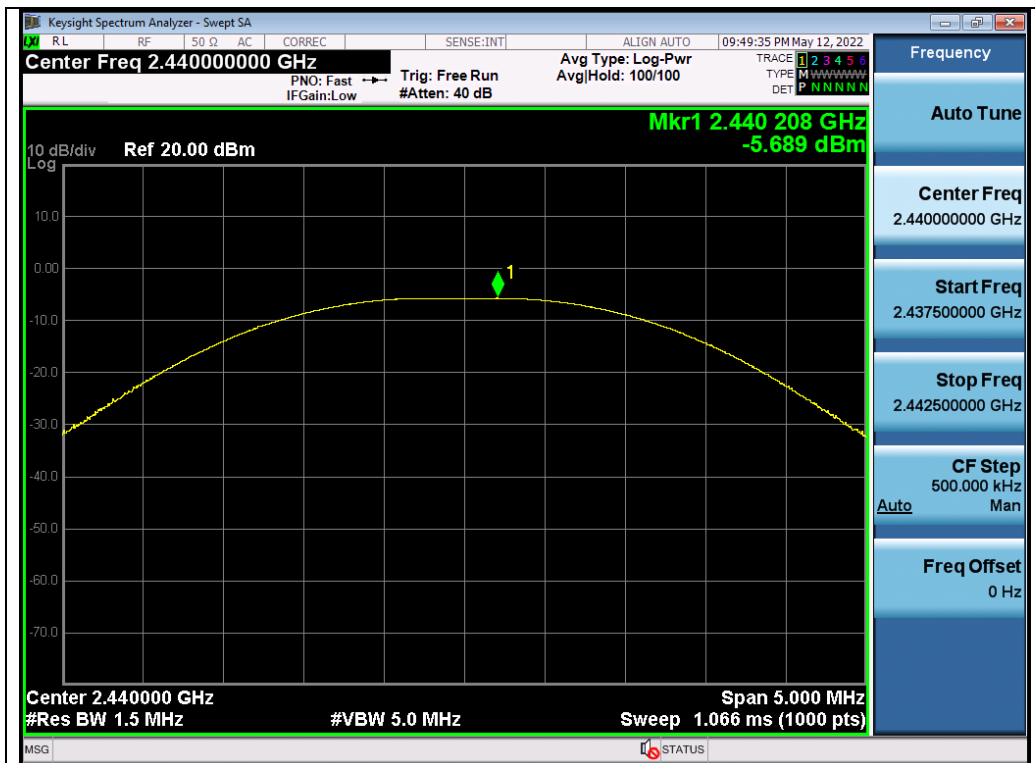

Test_Graph_LE1M_ANT1_2440_1Mbps_Peak Power

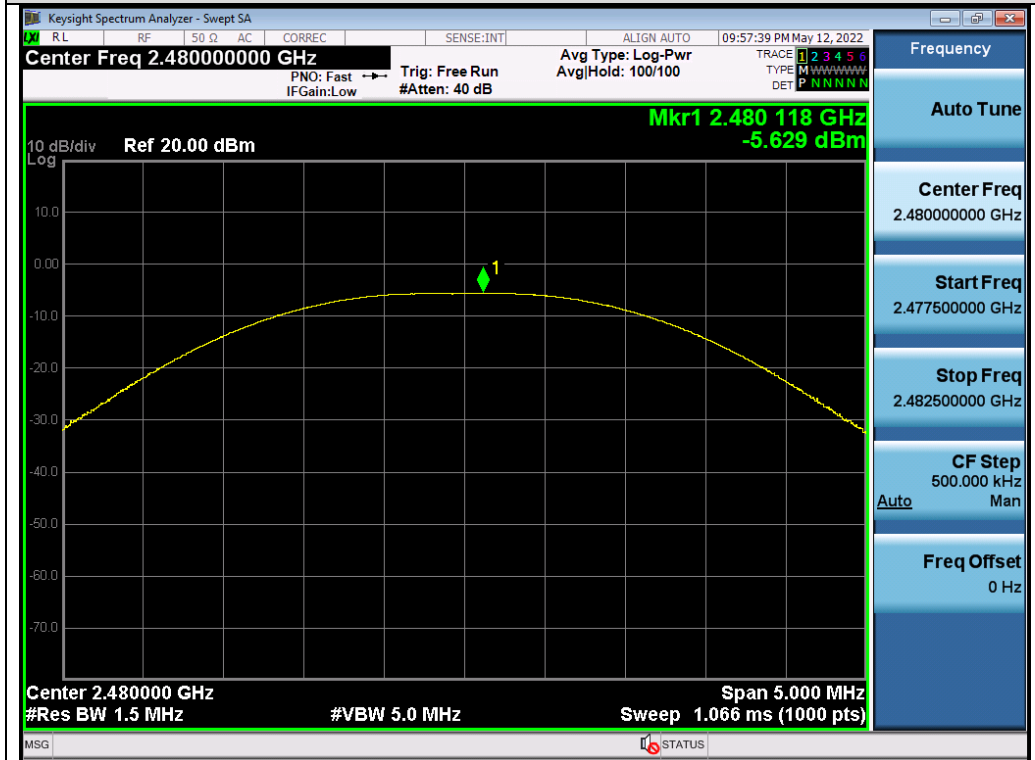

Test_Graph_LE1M_ANT1_2480_1Mbps_Peak Power

Any report having not been signed by authorized approver, or having been altered without authorization, or having not been stamped by the "Dedicated Testing/Inspection Stamp" is deemed to be invalid. Copying or excerpting portion of, or altering the content of the report is not permitted without the written authorization of AGC. The test results presented in the report apply only to the tested sample. Any objections to report issued by AGC should be submitted to AGC within 15days after the issuance of the test report. Further enquiry of validity or verification of the test report should be addressed to AGC by agc01@agccert.com.

8. BANDWIDTH

8.1. MEASUREMENT PROCEDURE

6dB bandwidth:

1. Connect EUT RF output port to the Spectrum Analyzer through an RF attenuator
2. Set the EUT Work on the top, the middle and the bottom operation frequency individually.
3. Set SPA Centre Frequency = Operation Frequency, RBW= 100 kHz, VBW $\geq 3 \times$ RBW.
4. Set SPA Trace 1 Max hold, then View.

Occupied bandwidth:

1. Connect EUT RF output port to the Spectrum Analyzer through an RF attenuator
2. Set the EUT Work on the top, the middle and the bottom operation frequency individually.
3. Set Span = approximately 2 to 5 times the 20 dB bandwidth, centered on a hopping channel
The nominal IF filter bandwidth (3 dB RBW) shall be in the range of 1% to 5% of the OBW and video bandwidth (VBW) shall be approximately three times RBW; Sweep = auto; Detector function = peak
4. Set SPA Trace 1 Max hold, then View.

Note: The EUT was tested according to ANSI C63.10 for compliance to FCC PART 15.247 requirements.

8.2. TEST SET-UP (BLOCK DIAGRAM OF CONFIGURATION)

The same as described in section 7.2.

8.3. LIMITS AND MEASUREMENT RESULTS

Test Data of Occupied Bandwidth and DTS Bandwidth					
Test Mode	Test Channel (MHz)	99% Occupied Bandwidth (MHz)	-6dB Bandwidth (MHz)	Limits (MHz)	Pass or Fail
GFSK 1M	2402	1.024	0.699	≥ 0.5	Pass
	2440	1.024	0.704	≥ 0.5	Pass
	2480	1.025	0.699	≥ 0.5	Pass

Test Graphs of Occupied Bandwidth

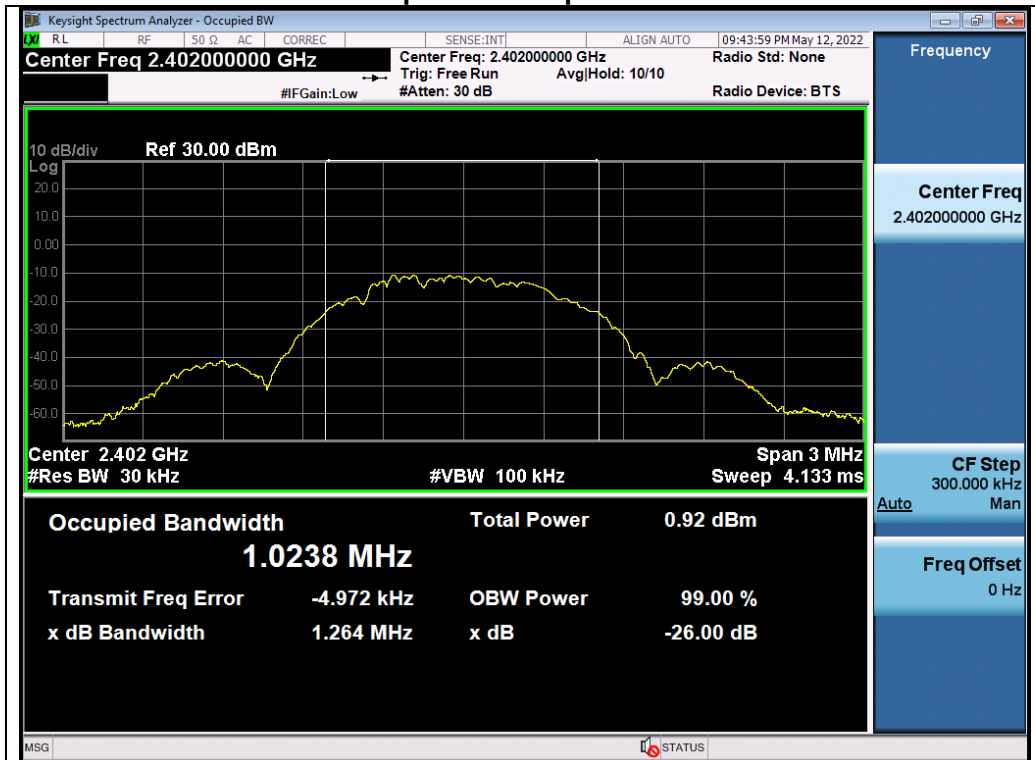

Test_Graph_LE1M_ANT1_2402_1Mbps_OBW

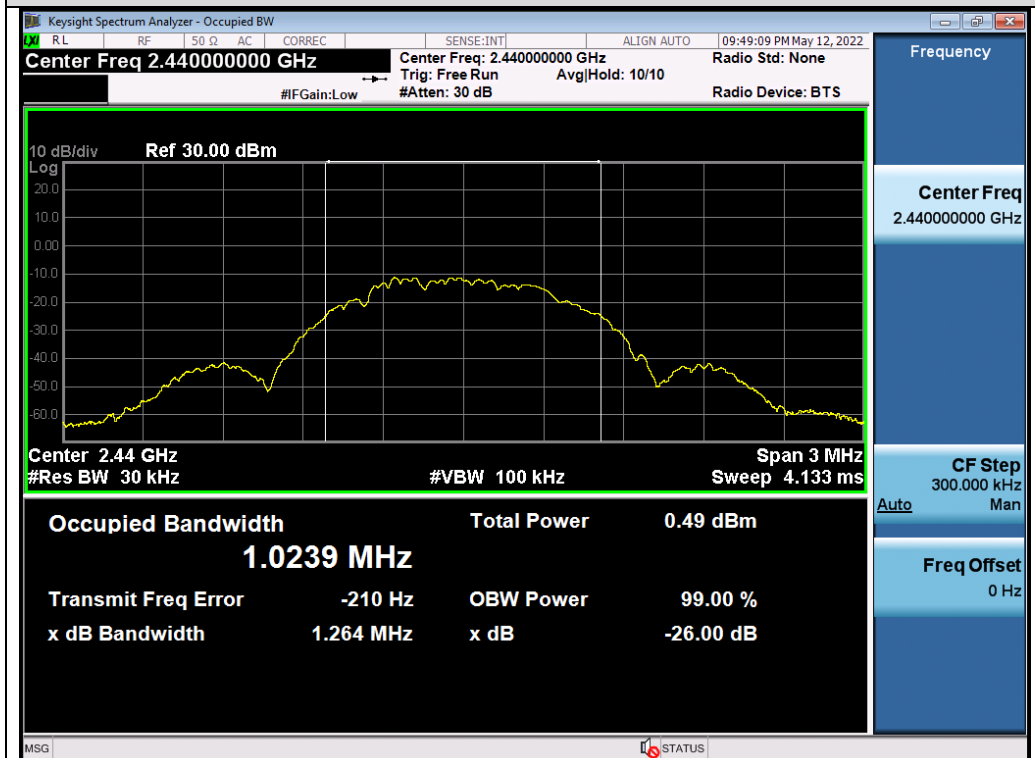

Test_Graph_LE1M_ANT1_2440_1Mbps_OBW

Any report having not been signed by authorized approver, or having been altered without authorization, or having not been stamped by the "Dedicated Testing/Inspection Stamp" is deemed to be invalid. Copying or excerpting portion of, or altering the content of the report is not permitted without the written authorization of AGC. The test results presented in the report apply only to the tested sample. Any objections to report issued by AGC should be submitted to AGC within 15days after the issuance of the test report. Further enquiry of validity or verification of the test report should be addressed to AGC by agc01@agccert.com.

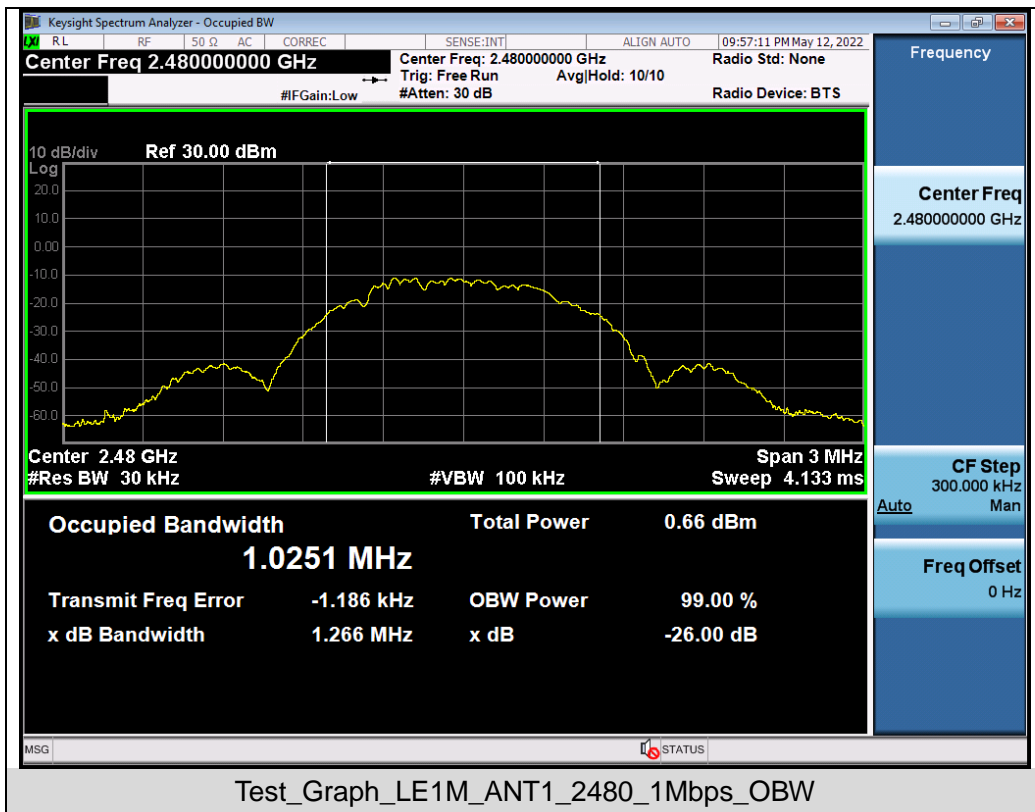

Test Graphs of DTS Bandwidth

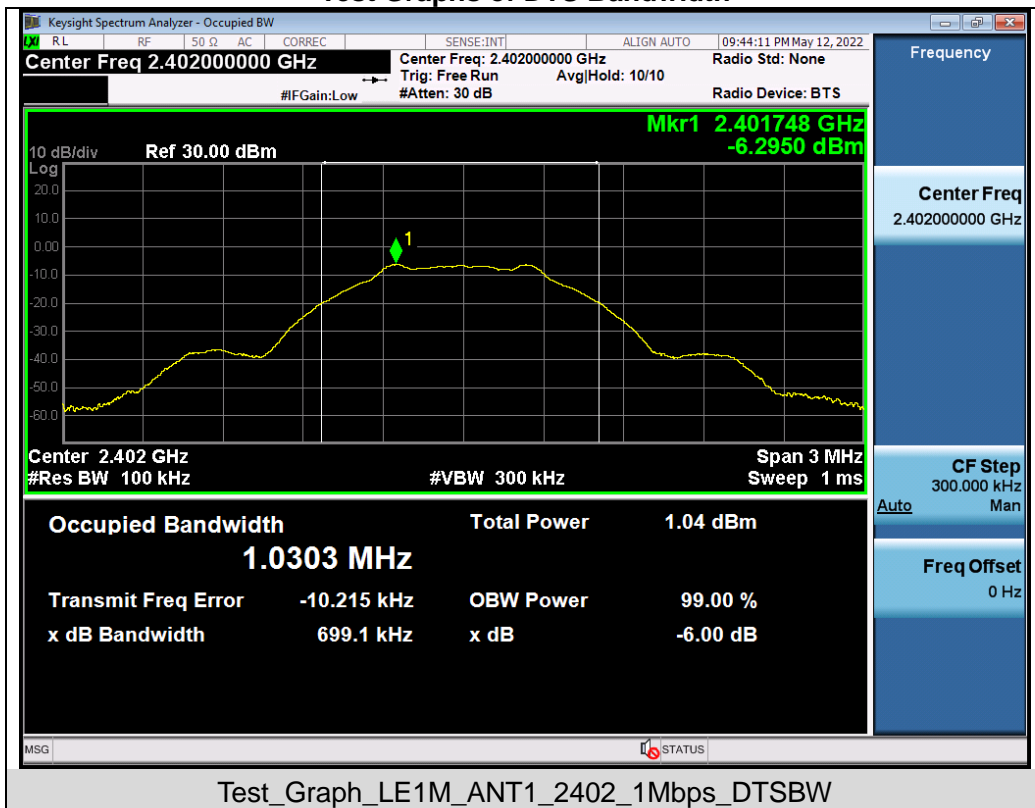

Any report having not been signed by authorized approver, or having been altered without authorization, or having not been stamped by the "Dedicated Testing/Inspection Stamp" is deemed to be invalid. Copying or excerpting portion of, or altering the content of the report is not permitted without the written authorization of AGC. The test results presented in the report apply only to the tested sample. Any objections to report issued by AGC should be submitted to AGC within 15days after the issuance of the test report. Further enquiry of validity or verification of the test report should be addressed to AGC by agc01@agccert.com.



Test_Graph_LE1M_ANT1_2440_1Mbps_DTSBW

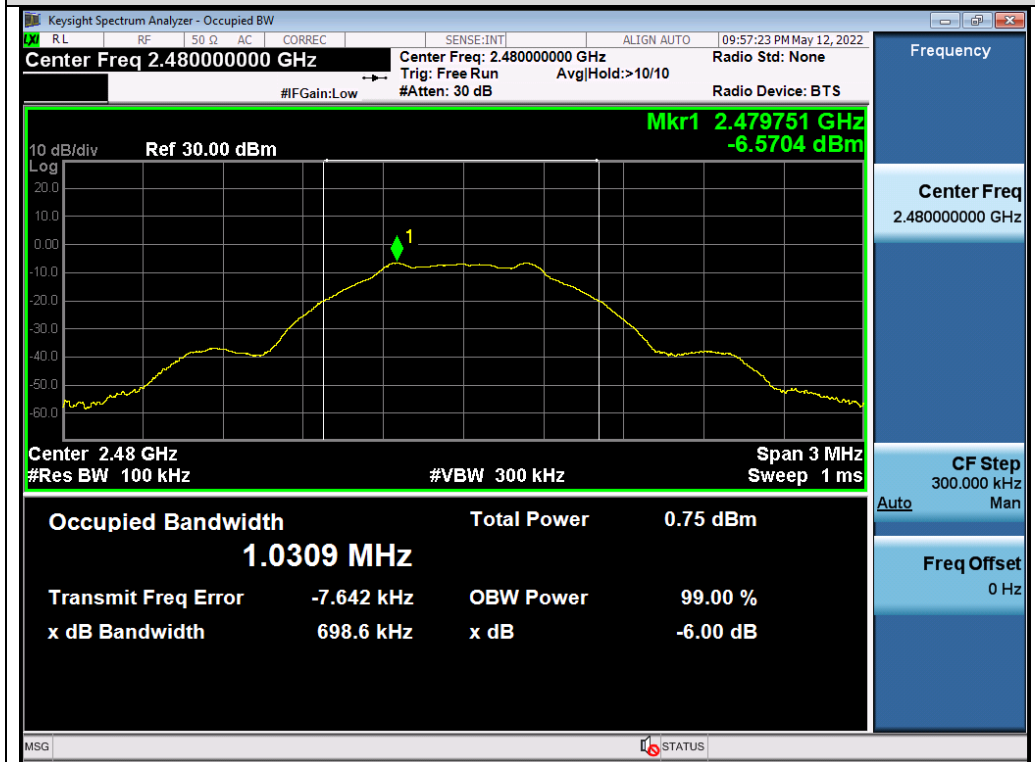

Test_Graph_LE1M_ANT1_2480_1Mbps_DTSBW

Any report having not been signed by authorized approver, or having been altered without authorization, or having not been stamped by the "Dedicated Testing/Inspection Stamp" is deemed to be invalid. Copying or excerpting portion of, or altering the content of the report is not permitted without the written authorization of AGC. The test results presented in the report apply only to the tested sample. Any objections to report issued by AGC should be submitted to AGC within 15days after the issuance of the test report. Further enquiry of validity or verification of the test report should be addressed to AGC by agc01@agccert.com.

9. CONDUCTED SPURIOUS EMISSION

9.1. MEASUREMENT PROCEDURE

1. Connect EUT RF output port to the Spectrum Analyzer through an RF attenuator
2. Set the EUT Work on the top, the middle and the bottom operation frequency individually.
3. Set SPA Trace 1 Max hold, then View.

Note: The EUT was tested according to ANSI C63.10 for compliance to FCC PART 15.247 requirements.

9.2. TEST SET-UP (BLOCK DIAGRAM OF CONFIGURATION)

The same as described in section 7.2.

9.3. MEASUREMENT EQUIPMENT USED

The same as described in section 6.

9.4. LIMITS AND MEASUREMENT RESULT

LIMITS AND MEASUREMENT RESULT		
Applicable Limits	Measurement Result	
	Test Data	Criteria
In any 100 kHz Bandwidth Outside the frequency band in which the spread spectrum intentional radiator is operating, the radio frequency power that is produce by the intentional radiator shall be at least 20 dB below that in 100KHz bandwidth within the band that contains the highest level of the desired power.	At least -20dBc than the reference level	PASS

Any report having not been signed by authorized approver, or having been altered without authorization, or having not been stamped by the "Dedicated Testing/Inspection Stamp" is deemed to be invalid. Copying or excerpting portion of, or altering the content of the report is not permitted without the written authorization of AGC. The test results presented in the report apply only to the tested sample. Any objections to report issued by AGC should be submitted to AGC within 15days after the issuance of the test report. Further enquiry of validity or verification of the test report should be addressed to AGC by agc01@agccert.com.

Test Graphs of Spurious Emissions in Non-Restricted Frequency Bands

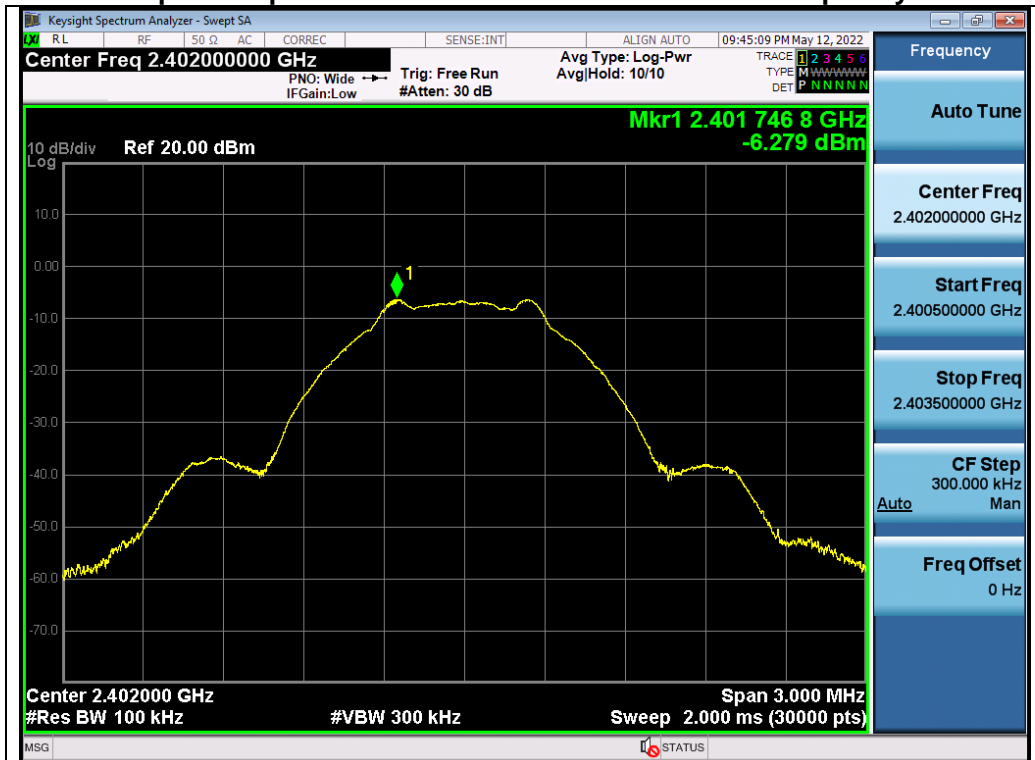

Test_Graph_LE1M_ANT1_2402_1Mbps_Reference Level

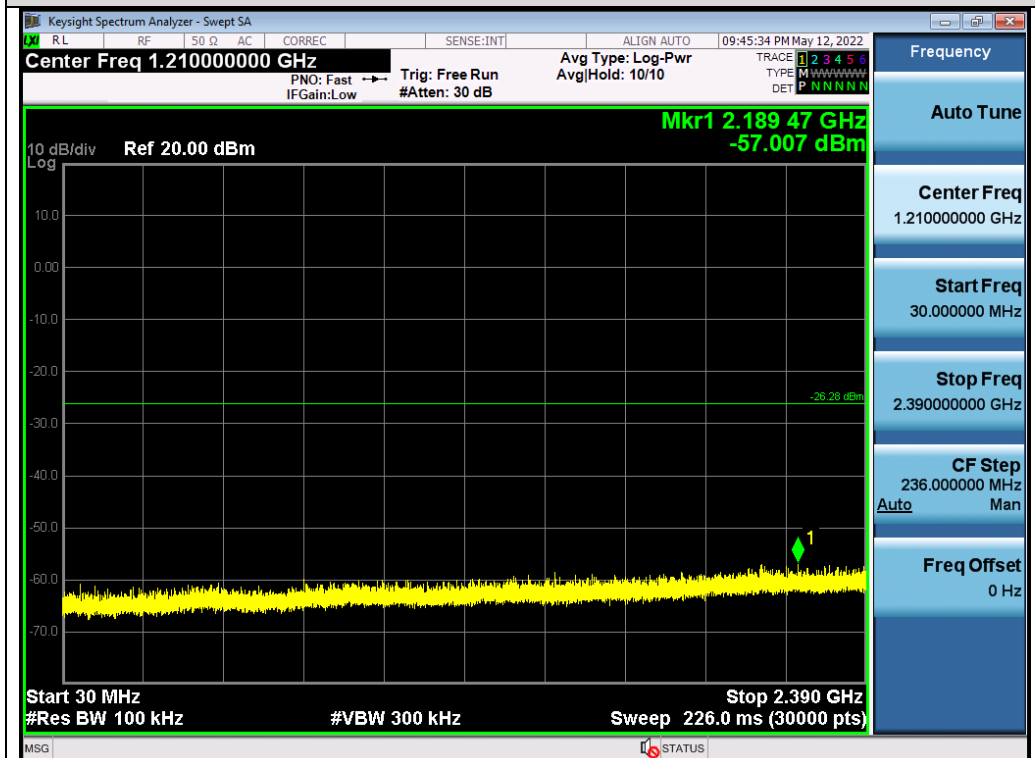

Test_Graph_LE1M_ANT1_2402_1Mbps_Lower Band Emissions

Any report having not been signed by authorized approver, or having been altered without authorization, or having not been stamped by the "Dedicated Testing/Inspection Stamp" is deemed to be invalid. Copying or excerpting portion of, or altering the content of the report is not permitted without the written authorization of AGC. The test results presented in the report apply only to the tested sample. Any objections to report issued by AGC should be submitted to AGC within 15days after the issuance of the test report. Further enquiry of validity or verification of the test report should be addressed to AGC by agc01@agccert.com.

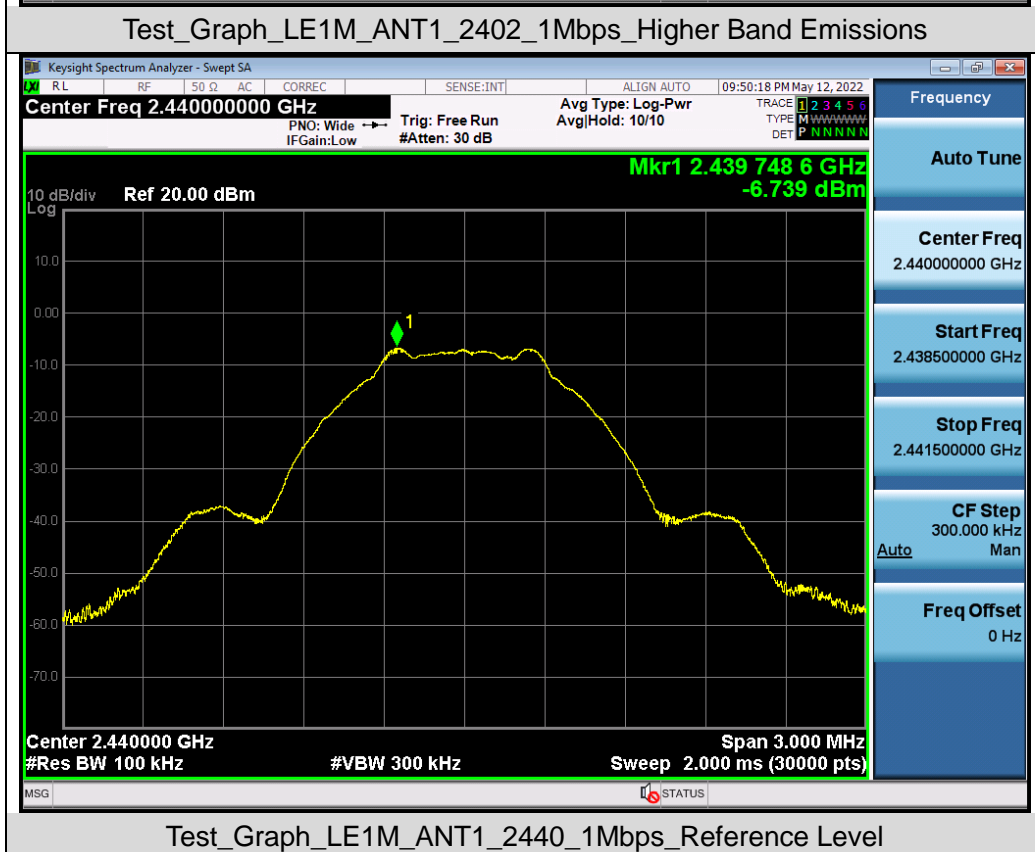
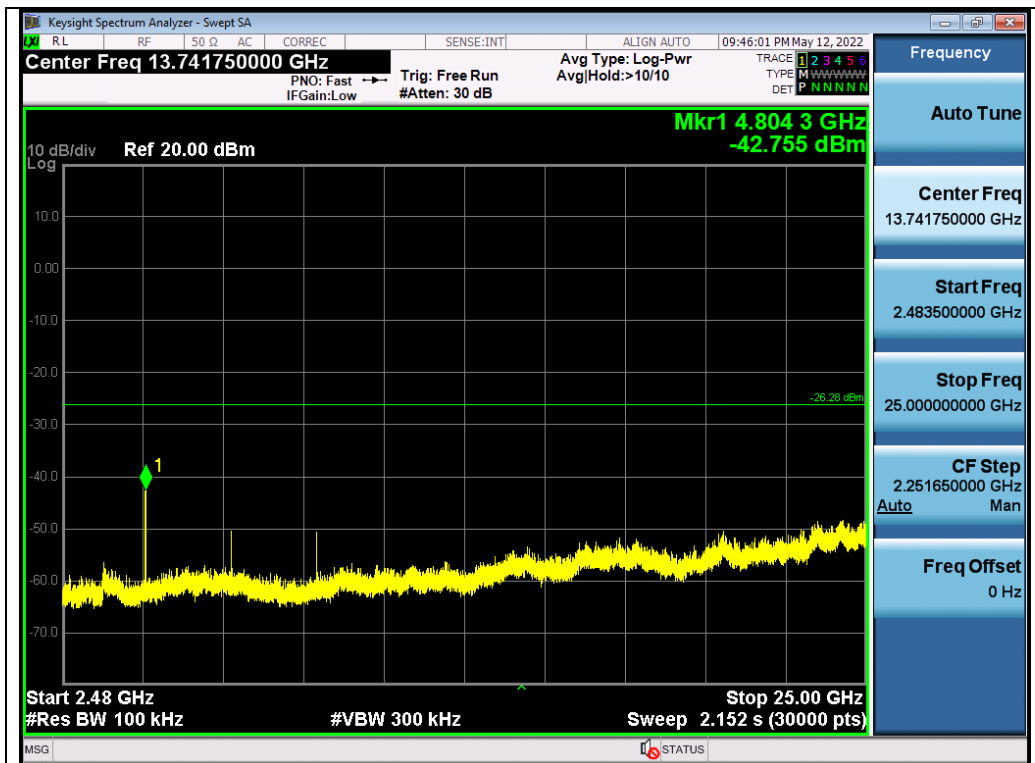

Any report having not been signed by authorized approver, or having been altered without authorization, or having not been stamped by the "Dedicated Testing/Inspection Stamp" is deemed to be invalid. Copying or excerpting portion of, or altering the content of the report is not permitted without the written authorization of AGC. The test results presented in the report apply only to the tested sample. Any objections to report issued by AGC should be submitted to AGC within 15days after the issuance of the test report. Further enquiry of validity or verification of the test report should be addressed to AGC by agc01@agccert.com.

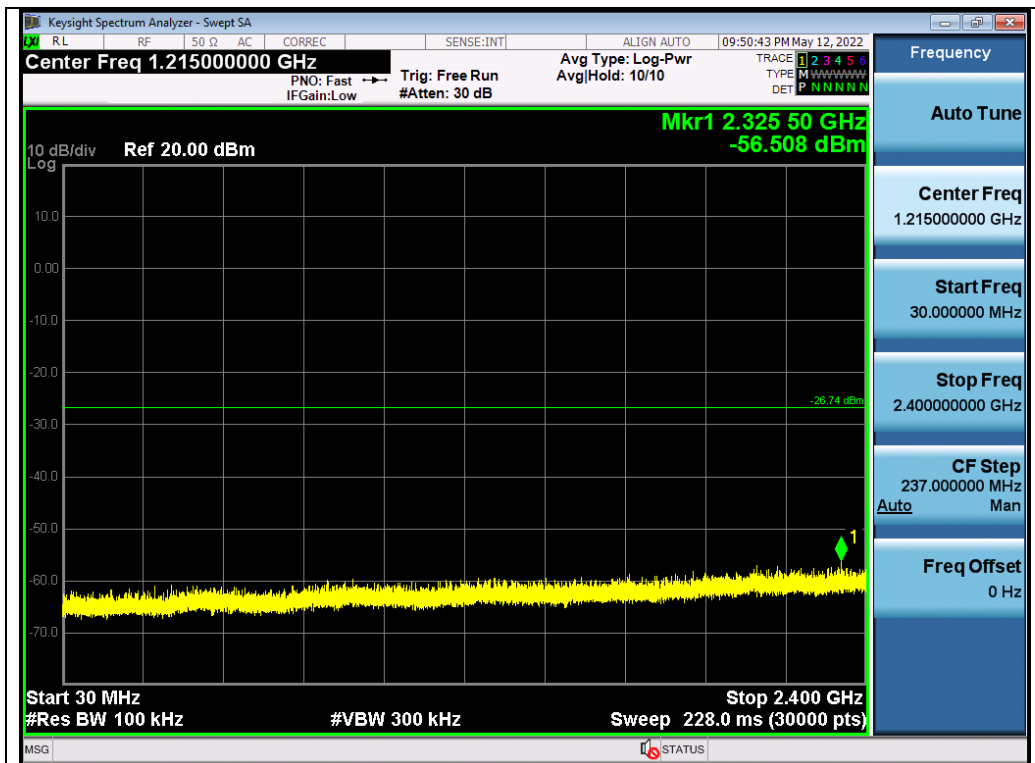

Test_Graph_LE1M_ANT1_2440_1Mbps_Lower Band Emissions

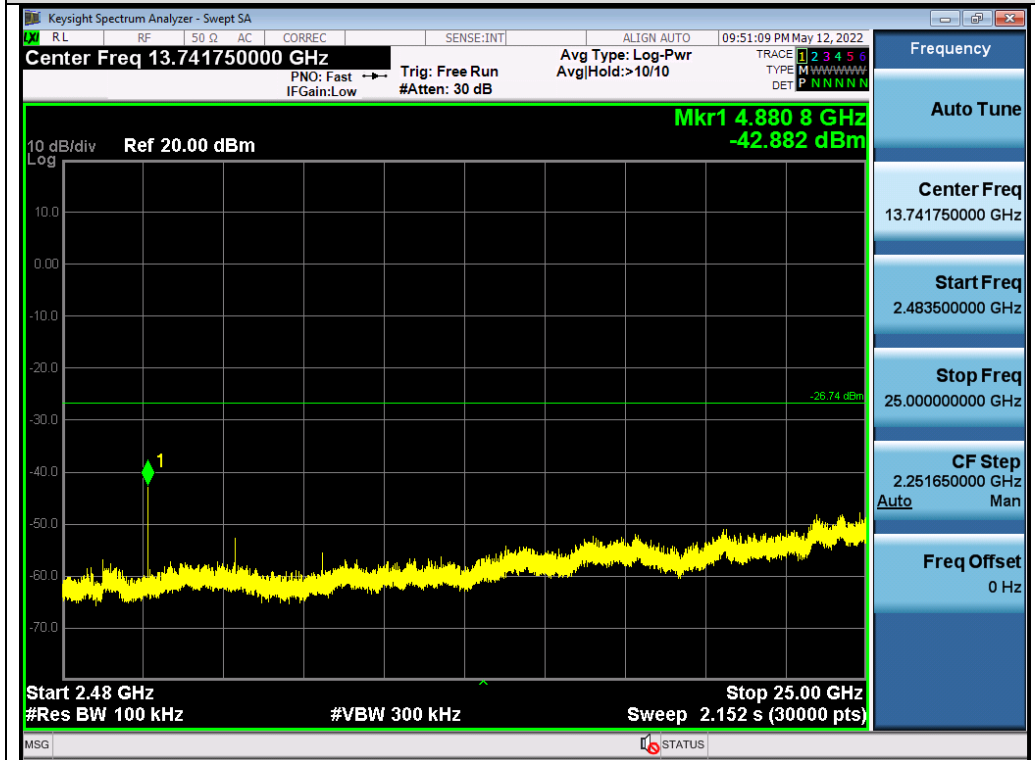

Test_Graph_LE1M_ANT1_2440_1Mbps_Higher Band Emissions

Any report having not been signed by authorized approver, or having been altered without authorization, or having not been stamped by the "Dedicated Testing/Inspection Stamp" is deemed to be invalid. Copying or excerpting portion of, or altering the content of the report is not permitted without the written authorization of AGC. The test results presented in the report apply only to the tested sample. Any objections to report issued by AGC should be submitted to AGC within 15days after the issuance of the test report. Further enquiry of validity or verification of the test report should be addressed to AGC by agc01@agccert.com.



Test_Graph_LE1M_ANT1_2480_1Mbps_Reference Level

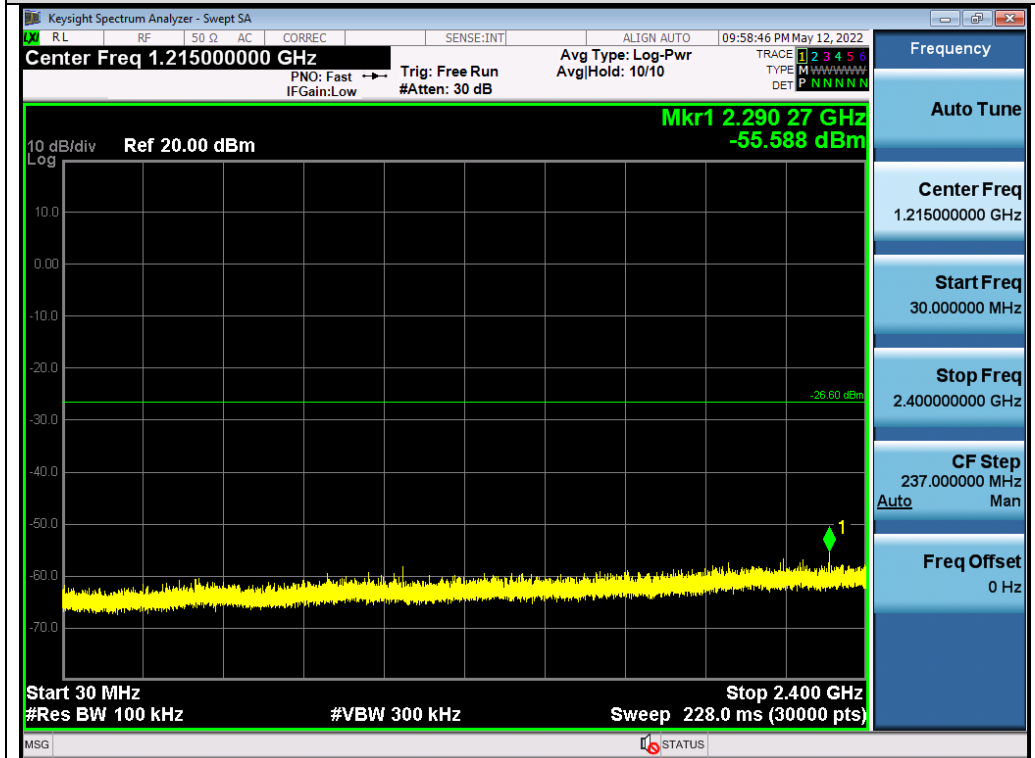

Test_Graph_LE1M_ANT1_2480_1Mbps_Lower Band Emissions

Any report having not been signed by authorized approver, or having been altered without authorization, or having not been stamped by the "Dedicated Testing/Inspection Stamp" is deemed to be invalid. Copying or excerpting portion of, or altering the content of the report is not permitted without the written authorization of AGC. The test results presented in the report apply only to the tested sample. Any objections to report issued by AGC should be submitted to AGC within 15days after the issuance of the test report. Further enquiry of validity or verification of the test report should be addressed to AGC by agc01@agccert.com.

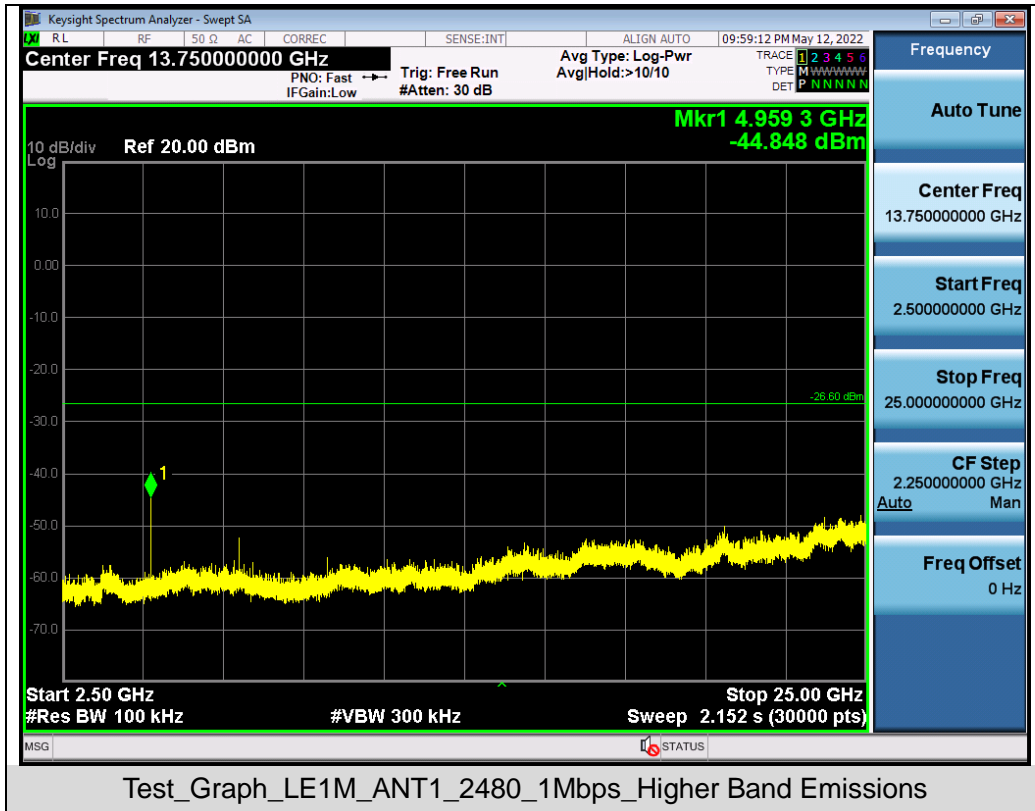

Any report having not been signed by authorized approver, or having been altered without authorization, or having not been stamped by the "Dedicated Testing/Inspection Stamp" is deemed to be invalid. Copying or excerpting portion of, or altering the content of the report is not permitted without the written authorization of AGC. The test results presented in the report apply only to the tested sample. Any objections to report issued by AGC should be submitted to AGC within 15days after the issuance of the test report. Further enquiry of validity or verification of the test report should be addressed to AGC by agc01@agccert.com.

Test Graphs of Band Edge Emissions in Non-Restricted Frequency Bands

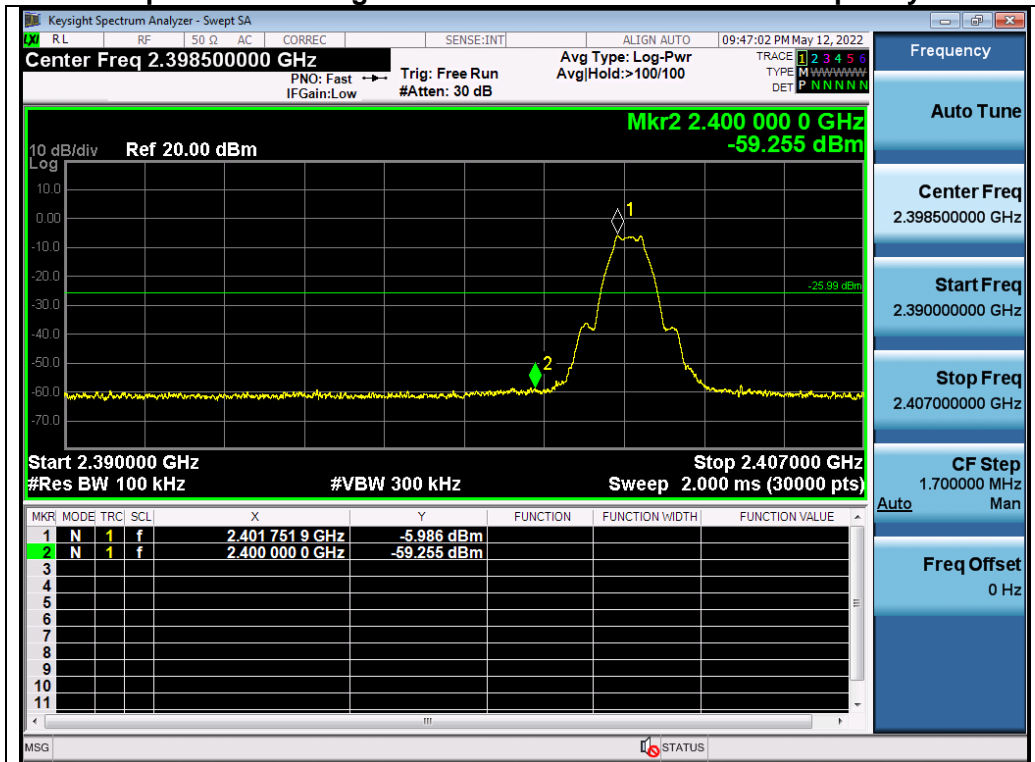

Test_Graph_LE1M_ANT1_2402_1Mbps_Lower Band Edge Emissions

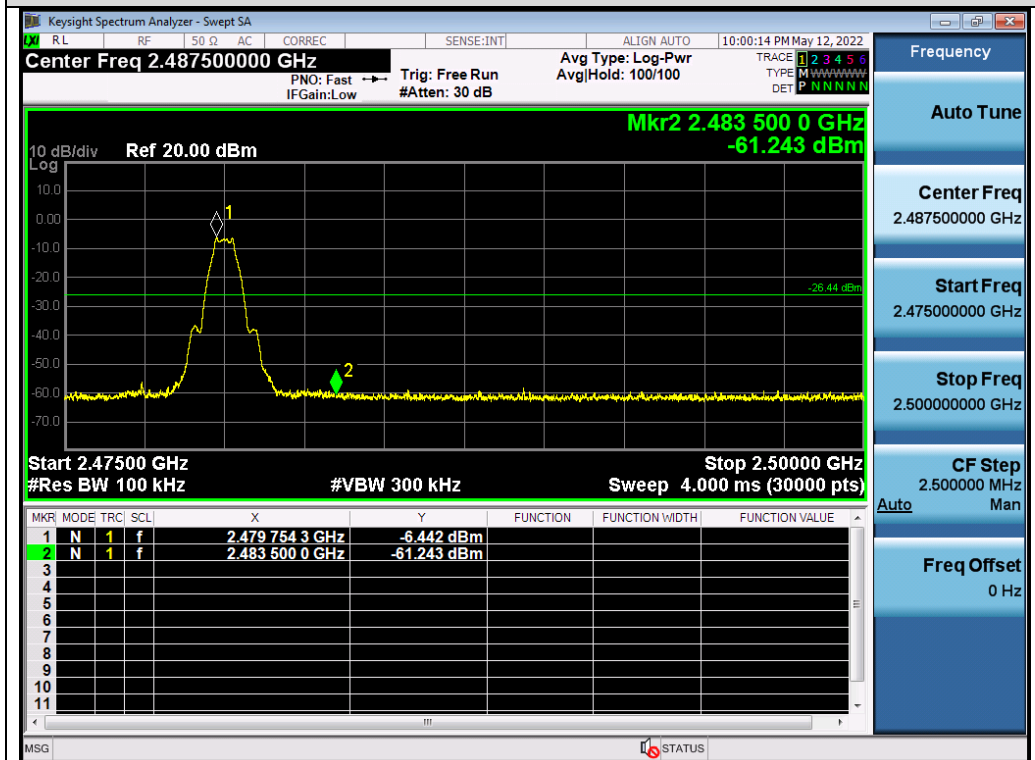

Test_Graph_LE1M_ANT1_2480_1Mbps_Higher Band Edge Emissions

Any report having not been signed by authorized approver, or having been altered without authorization, or having not been stamped by the "Dedicated Testing/Inspection Stamp" is deemed to be invalid. Copying or excerpting portion of, or altering the content of the report is not permitted without the written authorization of AGC. The test results presented in the report apply only to the tested sample. Any objections to report issued by AGC should be submitted to AGC within 15days after the issuance of the test report. Further enquiry of validity or verification of the test report should be addressed to AGC by agc01@agccert.com.

10. MAXIMUM CONDUCTED OUTPUT POWER SPECTRAL DENSITY

10.1. MEASUREMENT PROCEDURE

- (1). Connect EUT RF output port to the Spectrum Analyzer through an RF attenuator
- (2). Set the EUT Work on the top, the middle and the bottom operation frequency individually.
- (3). Set the SPA Trace 1 Max hold, then View.

Note: The method of PKPSD in the KDB 558074 item 8.4 was used in this testing.

10.2. TEST SET-UP (BLOCK DIAGRAM OF CONFIGURATION)

Refer to Section 7.2.

10.3. MEASUREMENT EQUIPMENT USED

Refer to Section 6.

10.4. LIMITS AND MEASUREMENT RESULT

Test Data of Conducted Output Power Spectral Density				
Test Mode	Test Channel (MHz)	Power density (dBm/3kHz)	Limit (dBm/3kHz)	Pass or Fail
GFSK 1M	2402	-20.741	≤8	Pass
	2440	-21.122	≤8	Pass
	2480	-20.973	≤8	Pass

Test Graphs of Conducted Output Power Spectral Density

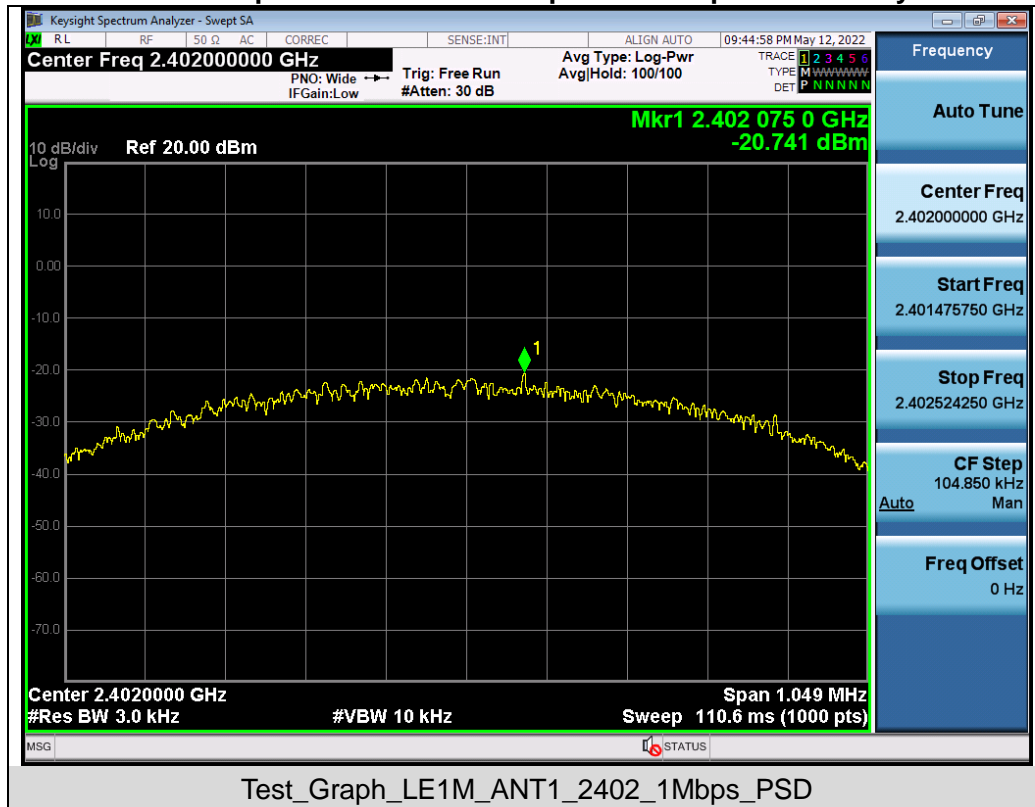

Any report having not been signed by authorized approver, or having been altered without authorization, or having not been stamped by the “Dedicated Testing/Inspection Stamp” is deemed to be invalid. Copying or excerpting portion of, or altering the content of the report is not permitted without the written authorization of AGC. The test results presented in the report apply only to the tested sample. Any objections to report issued by AGC should be submitted to AGC within 15days after the issuance of the test report. Further enquiry of validity or verification of the test report should be addressed to AGC by agc01@agccert.com.



Test_Graph_LE1M_ANT1_2440_1Mbps_PSD

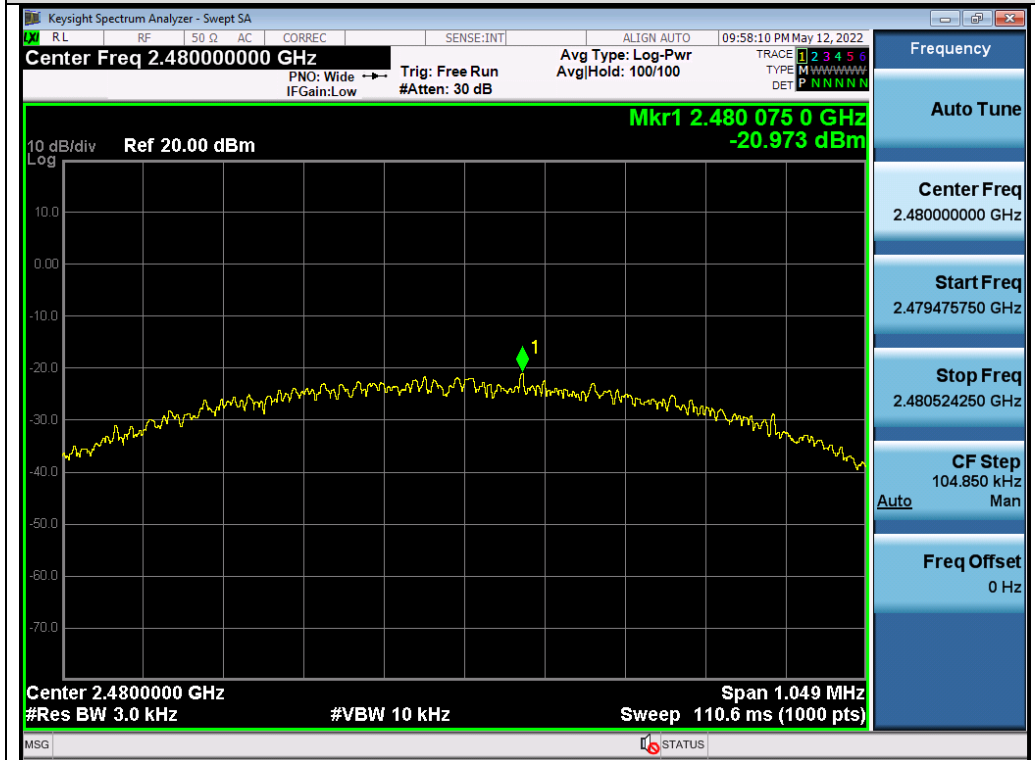

Test_Graph_LE1M_ANT1_2480_1Mbps_PSD

Any report having not been signed by authorized approver, or having been altered without authorization, or having not been stamped by the "Dedicated Testing/Inspection Stamp" is deemed to be invalid. Copying or excerpting portion of, or altering the content of the report is not permitted without the written authorization of AGC. The test results presented in the report apply only to the tested sample. Any objections to report issued by AGC should be submitted to AGC within 15days after the issuance of the test report. Further enquiry of validity or verification of the test report should be addressed to AGC by agc01@agccert.com.

11. RADIATED EMISSION

11.1. MEASUREMENT PROCEDURE

1. The EUT was placed on the top of the turntable 0.8 or 1.5 meter above ground. The phase center of the receiving antenna mounted on the top of a height-variable antenna tower was placed 3 meters far away from the turntable.
2. Power on the EUT and all the supporting units. The turntable was rotated by 360 degrees to determine the position of the highest radiation.
3. The height of the broadband receiving antenna was varied between one meter and four meters above ground to find the maximum emissions field strength of both horizontal and vertical polarization.
4. For each suspected emission, the antenna tower was scan (from 1 M to 4 M) and then the turntable was rotated (from 0 degree to 360 degrees) to find the maximum reading.
5. Set the test-receiver system to Peak or CISPR quasi-peak Detect Function with specified bandwidth under Maximum Hold Mode.
6. For emissions above 1GHz, use 1MHz RBW and 3MHz VBW for peak reading. Place the measurement antenna away from each area of the EUT determined to be a source of emissions at the specified measurement distance, while keeping the measurement antenna aimed at the source of emissions at each frequency of significant emissions, with polarization oriented for maximum response. The measurement antenna may have to be higher or lower than the EUT, depending on the radiation pattern of the emission and staying aimed at the emission source for receiving the maximum signal. The final measurement antenna elevation shall be that which maximizes the emissions. The measurement antenna elevation for maximum emissions shall be restricted to a range of heights of from 1 m to 4 m above the ground or reference ground plane.
7. When the radiated emissions limits are expressed in terms of the average value of the emissions, and pulsed operation is employed, the measurement field strength shall be determined by averaging over one complete pulse train, including blanking intervals, as long as the pulse train does not exceed 0.1 seconds. As an alternative (provided the transmitter operates for longer than 0.1 seconds) or in cases where the pulse train exceeds 0.1 seconds, the measured field strength shall be determined from the average absolute voltage during a 0.1 second interval during which the field strength is at its maximum values.
8. If the emissions level of the EUT in peak mode was 3 dB lower than the average limit specified, then testing will be stopped and peak values of EUT will be reported, otherwise, the emissions which do not have 3 dB margin will be repeated one by one using the quasi-peak method for below 1GHz.
9. For testing above 1GHz, the emissions level of the EUT in peak mode was lower than average limit (that means the emissions level in peak mode also complies with the limit in average mode), then testing will be stopped and peak values of EUT will be reported, otherwise, the emissions will be measured in average mode again and reported.
10. In case the emission is lower than 30MHz, loop antenna has to be used for measurement and the recorded data should be QP measured by receiver. High - Low scan is not required in this case.

11.2. TEST SETUP

Radiated Emission Test-Setup Frequency Below 30MHz

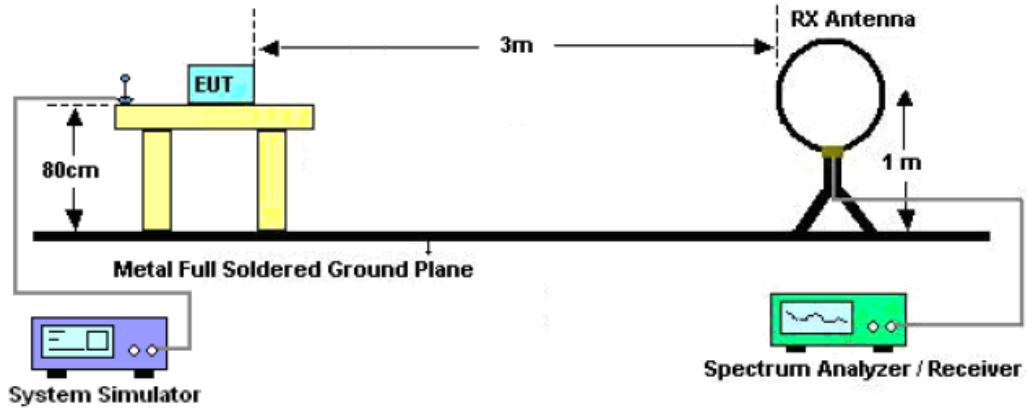

RADIATED EMISSION TEST SETUP 30MHz-1000MHz

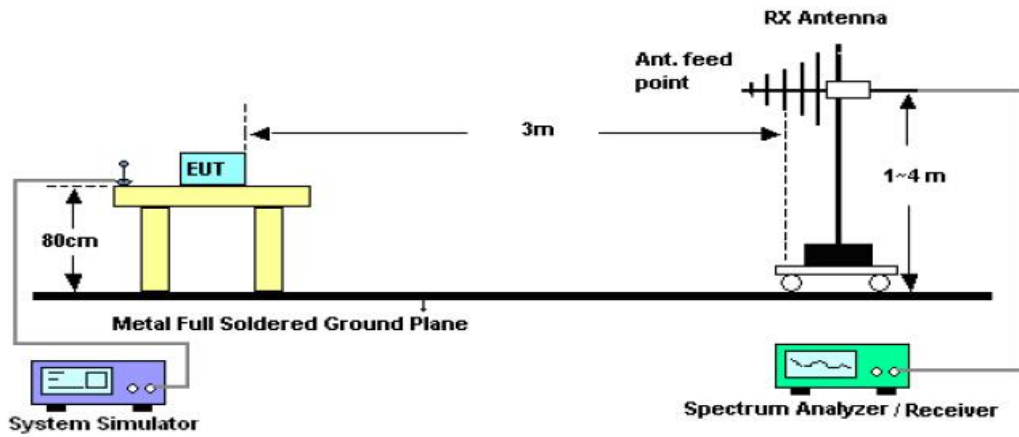

RADIATED EMISSION TEST SETUP ABOVE 1000MHz

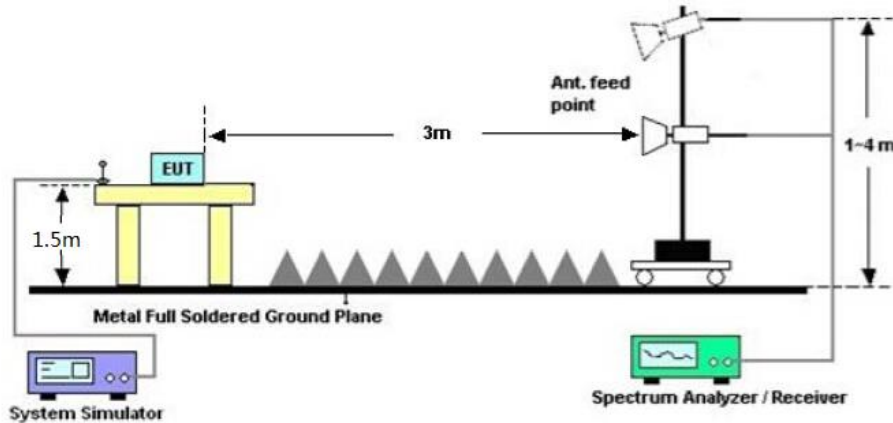

Any report having not been signed by authorized approver, or having been altered without authorization, or having not been stamped by the “Dedicated Testing/Inspection Stamp” is deemed to be invalid. Copying or excerpting portion of, or altering the content of the report is not permitted without the written authorization of AGC. The test results presented in the report apply only to the tested sample. Any objections to report issued by AGC should be submitted to AGC within 15 days after the issuance of the test report. Further enquiry of validity or verification of the test report should be addressed to AGC by agc01@agccert.com.

11.3. LIMITS AND MEASUREMENT RESULT

15.209 Limit in the below table has to be followed

Frequencies (MHz)	Field Strength (microvolts/meter)	Measurement Distance (meters)
0.009~0.490	2400/F(kHz)	300
0.490~1.705	24000/F(kHz)	30
1.705~30.0	30	30
30~88	100	3
88~216	150	3
216~960	200	3
Above 960	500	3

Note: All modes were tested for restricted band radiated emission, the test records reported below are the worst result compared to other modes.

11.4. TEST RESULT

Radiated emission below 30MHz

The amplitude of spurious emissions from 9kHz to 30MHz which are attenuated more than 20 dB below the permissible value need not be reported.

Any report having not been signed by authorized approver, or having been altered without authorization, or having not been stamped by the "Dedicated Testing/Inspection Stamp" is deemed to be invalid. Copying or excerpting portion of, or altering the content of the report is not permitted without the written authorization of AGC. The test results presented in the report apply only to the tested sample. Any objections to report issued by AGC should be submitted to AGC within 15days after the issuance of the test report. Further enquiry of validity or verification of the test report should be addressed to AGC by agc01@agccert.com.

Radiated emission from 30MHz to 1000MHz

EUT	Bluetooth Dongle	Model Name	C013
Temperature	25° C	Relative Humidity	55.4%
Pressure	960hPa	Test Voltage	Normal Voltage
Test Mode	Mode 1	Antenna	Horizontal

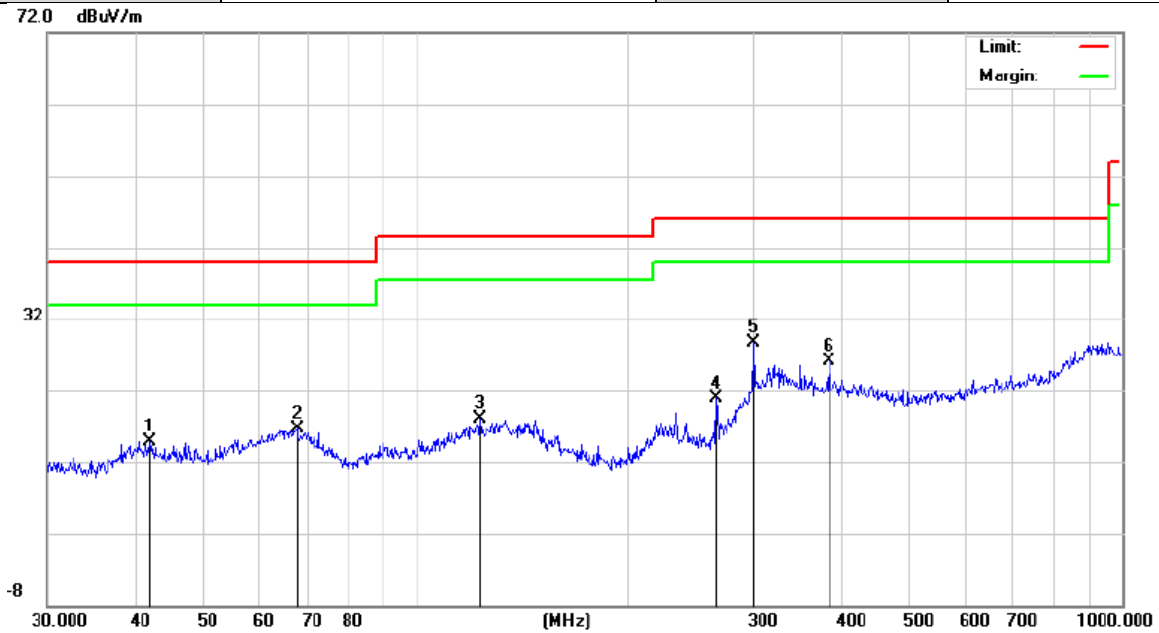

No.	Mk.	Freq. MHz	Reading Level dBuV	Correct Factor dB	Measure- ment dBuV/m	Limit dBuV/m	Over dB	Detector
1		41.8596	5.07	9.84	14.91	40.00	-25.09	peak
2		67.6751	4.72	11.96	16.68	40.00	-23.32	peak
3		122.8340	5.10	12.92	18.02	43.50	-25.48	peak
4		265.6757	8.94	12.06	21.00	46.00	-25.00	peak
5	*	300.3672	10.25	18.44	28.69	46.00	-17.31	peak
6		383.9318	8.28	17.80	26.08	46.00	-19.92	peak

RESULT: PASS

Any report having not been signed by authorized approver, or having been altered without authorization, or having not been stamped by the "Dedicated Testing/Inspection Stamp" is deemed to be invalid. Copying or excerpting portion of, or altering the content of the report is not permitted without the written authorization of AGC. The test results presented in the report apply only to the tested sample. Any objections to report issued by AGC should be submitted to AGC within 15days after the issuance of the test report. Further enquiry of validity or verification of the test report should be addressed to AGC by agc01@agccert.com.

EUT	Bluetooth Dongle	Model Name	C013
Temperature	25° C	Relative Humidity	55.4%
Pressure	960hPa	Test Voltage	Normal Voltage
Test Mode	Mode 1	Antenna	Vertical

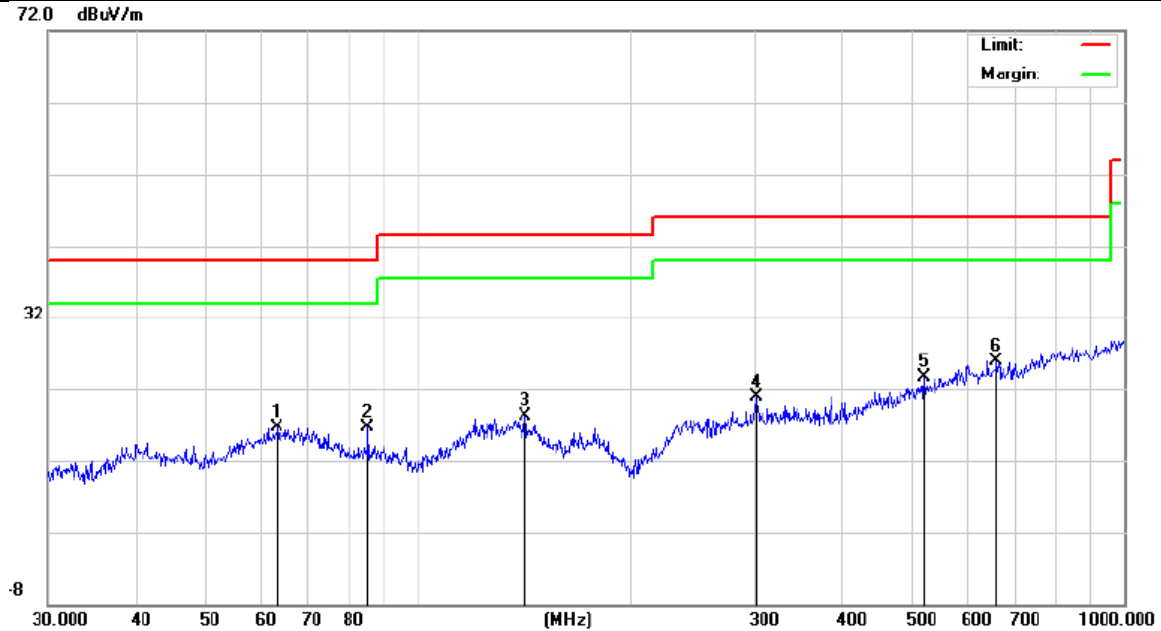

No.	Mk.	Freq. MHz	Reading Level dBuV	Correct Factor dB	Measure- ment dBuV/m	Limit dBuV/m	Over dB	Detector
1		63.3132	4.79	11.95	16.74	40.00	-23.26	peak
2		84.9993	6.76	9.96	16.72	40.00	-23.28	peak
3		141.8262	5.21	13.04	18.25	43.50	-25.25	peak
4		301.4223	6.37	14.46	20.83	46.00	-25.17	peak
5		520.8881	6.01	17.61	23.62	46.00	-22.38	peak
6	*	658.8361	5.88	20.07	25.95	46.00	-20.05	peak

RESULT: PASS

Note:

1. Factor=Antenna Factor + Cable loss, Over=Measurement-Limit.
2. All test modes had been tested. The mode 1 is the worst case and recorded in the report.

Any report having not been signed by authorized approver, or having been altered without authorization, or having not been stamped by the "Dedicated Testing/Inspection Stamp" is deemed to be invalid. Copying or excerpting portion of, or altering the content of the report is not permitted without the written authorization of AGC. The test results presented in the report apply only to the tested sample. Any objections to report issued by AGC should be submitted to AGC within 15days after the issuance of the test report. Further enquiry of validity or verification of the test report should be addressed to AGC by agc01@agccert.com.

Radiated emission above 1GHz

EUT	Bluetooth Dongle	Model Name	C013
Temperature	25° C	Relative Humidity	55.4%
Pressure	960hPa	Test Voltage	Normal Voltage
Test Mode	Mode 1	Antenna	Horizontal

Frequency (MHz)	Meter Reading (dBμV)	Factor (dB)	Emission Level (dBμV/m)	Limits (dBμV/m)	Margin (dB)	Value Type
4804.000	43.63	0.08	43.71	74	-30.29	peak
4804.000	35.28	0.08	35.36	54	-18.64	AVG
7206.000	38.41	2.21	40.62	74	-33.38	peak
7206.000	31.39	2.21	33.6	54	-20.4	AVG

Remark:

Factor = Antenna Factor + Cable Loss – Pre-amplifier.

EUT	Bluetooth Dongle	Model Name	C013
Temperature	25° C	Relative Humidity	55.4%
Pressure	960hPa	Test Voltage	Normal Voltage
Test Mode	Mode 1	Antenna	Vertical

Frequency (MHz)	Meter Reading (dBμV)	Factor (dB)	Emission Level (dBμV/m)	Limits (dBμV/m)	Margin (dB)	Value Type
4804.000	44.62	0.08	44.7	74	-29.3	peak
4804.000	34.78	0.08	34.86	54	-19.14	AVG
7206.000	38.39	2.21	40.6	74	-33.4	peak
7206.000	30.41	2.21	32.62	54	-21.38	AVG

Remark:

Factor = Antenna Factor + Cable Loss – Pre-amplifier.

Any report having not been signed by authorized approver, or having been altered without authorization, or having not been stamped by the “Dedicated Testing/Inspection Stamp” is deemed to be invalid. Copying or excerpting portion of, or altering the content of the report is not permitted without the written authorization of AGC. The test results presented in the report apply only to the tested sample. Any objections to report issued by AGC should be submitted to AGC within 15days after the issuance of the test report. Further enquiry of validity or verification of the test report should be addressed to AGC by agc01@agccert.com.

EUT	Bluetooth Dongle	Model Name	C013
Temperature	25° C	Relative Humidity	55.4%
Pressure	960hPa	Test Voltage	Normal Voltage
Test Mode	Mode 2	Antenna	Horizontal

Frequency (MHz)	Meter Reading (dBμV)	Factor (dB)	Emission Level (dBμV/m)	Limits (dBμV/m)	Margin (dB)	Value Type
4880.000	44.78	0.14	44.92	74	-29.08	peak
4880.000	35.69	0.14	35.83	54	-18.17	AVG
7320.000	39.41	2.36	41.77	74	-32.23	peak
7320.000	31.32	2.36	33.68	54	-20.32	AVG

Remark:

Factor = Antenna Factor + Cable Loss – Pre-amplifier.

EUT	Bluetooth Dongle	Model Name	C013
Temperature	25° C	Relative Humidity	55.4%
Pressure	960hPa	Test Voltage	Normal Voltage
Test Mode	Mode 2	Antenna	Vertical

Frequency (MHz)	Meter Reading (dBμV)	Factor (dB)	Emission Level (dBμV/m)	Limits (dBμV/m)	Margin (dB)	Value Type
4880.000	45.89	0.14	46.03	74	-27.97	peak
4880.000	38.52	0.14	38.66	54	-15.34	AVG
7320.000	40.61	2.36	42.97	74	-31.03	peak
7320.000	32.35	2.36	34.71	54	-19.29	AVG

Remark:

Factor = Antenna Factor + Cable Loss – Pre-amplifier.

Any report having not been signed by authorized approver, or having been altered without authorization, or having not been stamped by the “Dedicated Testing/Inspection Stamp” is deemed to be invalid. Copying or excerpting portion of, or altering the content of the report is not permitted without the written authorization of AGC. The test results presented in the report apply only to the tested sample. Any objections to report issued by AGC should be submitted to AGC within 15days after the issuance of the test report. Further enquiry of validity or verification of the test report should be addressed to AGC by agc01@agccert.com.

EUT	Bluetooth Dongle	Model Name	C013
Temperature	25° C	Relative Humidity	55.4%
Pressure	960hPa	Test Voltage	Normal Voltage
Test Mode	Mode 3	Antenna	Horizontal

Frequency (MHz)	Meter Reading (dBμV)	Factor (dB)	Emission Level (dBμV/m)	Limits (dBμV/m)	Margin (dB)	Value Type
4960.000	44.42	0.22	44.64	74	-29.36	peak
4960.000	35.68	0.22	35.9	54	-18.1	AVG
7440.000	38.75	2.64	41.39	74	-32.61	peak
7440.000	29.49	2.64	32.13	54	-21.87	AVG

Remark:

Factor = Antenna Factor + Cable Loss – Pre-amplifier.

EUT	Bluetooth Dongle	Model Name	C013
Temperature	25° C	Relative Humidity	55.4%
Pressure	960hPa	Test Voltage	Normal Voltage
Test Mode	Mode 3	Antenna	Vertical

Frequency (MHz)	Meter Reading (dBμV)	Factor (dB)	Emission Level (dBμV/m)	Limits (dBμV/m)	Margin (dB)	Value Type
4960.000	42.83	0.22	43.05	74	-30.95	peak
4960.000	34.62	0.22	34.84	54	-19.16	AVG
7440.000	38.59	2.64	41.23	74	-32.77	peak
7440.000	29.55	2.64	32.19	54	-21.81	AVG

Remark:

Factor = Antenna Factor + Cable Loss – Pre-amplifier.

RESULT: PASS

Note:

The amplitude of other spurious emissions from 1G to 25 GHz which are attenuated more than 20 dB below the permissible value need not be reported.

Factor = Antenna Factor + Cable loss - Amplifier gain, Margin=Level-Limit.

The “Factor” value can be calculated automatically by software of measurement system.

Test result for band edge emission at restricted bands

EUT	Bluetooth Dongle	Model Name	C013
Temperature	25° C	Relative Humidity	55.4%
Pressure	960hPa	Test Voltage	Normal Voltage
Test Mode	Mode 1	Antenna	Horizontal

Test Graph for Peak Measurement

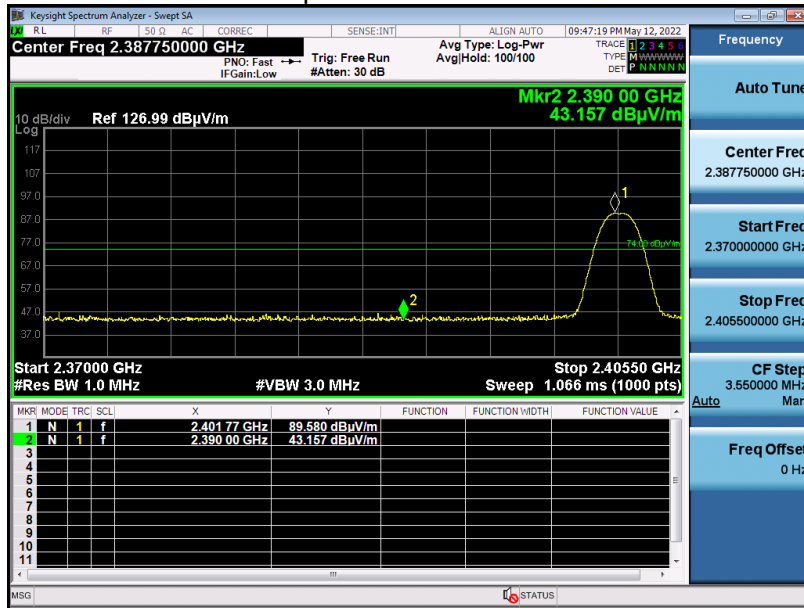

Test Graph for Average Measurement

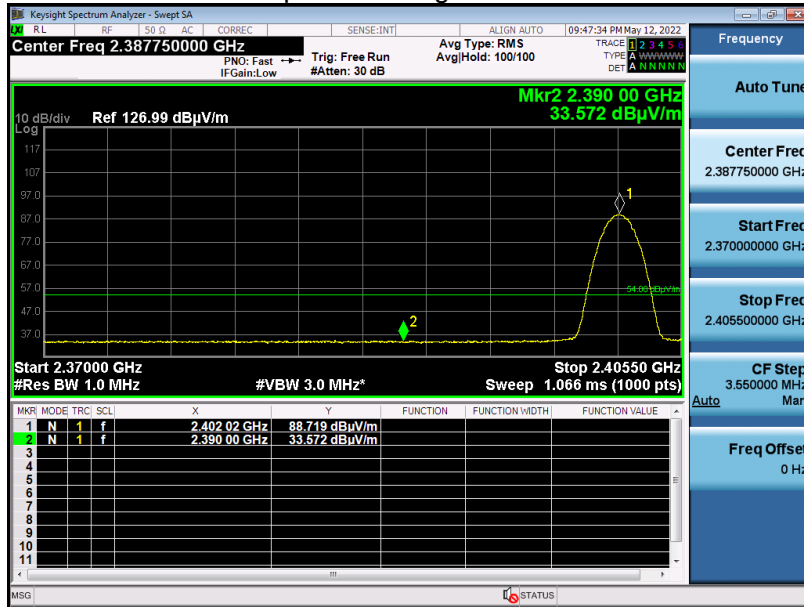

RESULT: PASS

Any report having not been signed by authorized approver, or having been altered without authorization, or having not been stamped by the "Dedicated Testing/Inspection Stamp" is deemed to be invalid. Copying or excerpting portion of, or altering the content of the report is not permitted without the written authorization of AGC. The test results presented in the report apply only to the tested sample. Any objections to report issued by AGC should be submitted to AGC within 15days after the issuance of the test report. Further enquiry of validity or verification of the test report should be addressed to AGC by agc01@agccert.com.

Attestation of Global Compliance(Shenzhen)Co., Ltd
Attestation of Global Compliance(Shenzhen)Std & Tech Co., Ltd
Tel: +86-755 2523 4088 E-mail: agc@agccert.com Web: http://www.agccert.com/

EUT	Bluetooth Dongle	Model Name	C013
Temperature	25° C	Relative Humidity	55.4%
Pressure	960hPa	Test Voltage	Normal Voltage
Test Mode	Mode 1	Antenna	Vertical

Test Graph for Peak Measurement

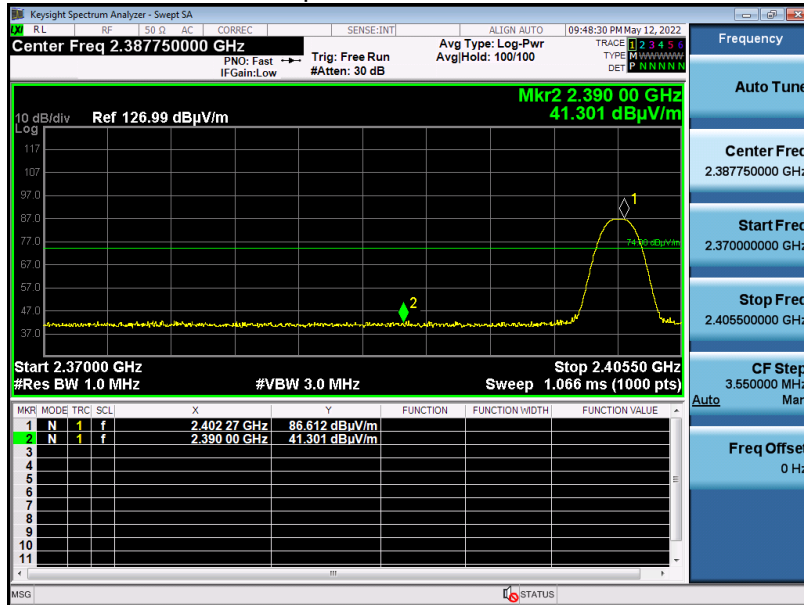

Test Graph for Average Measurement

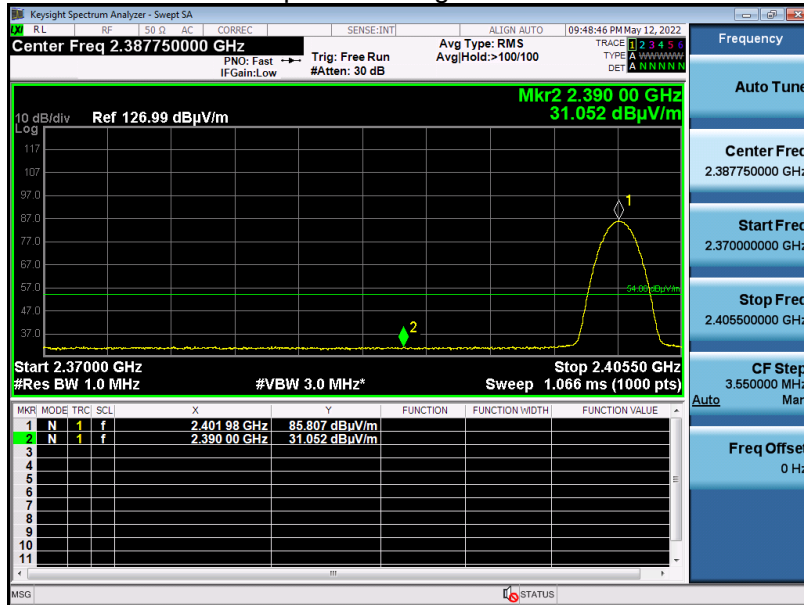

RESULT: PASS

Any report having not been signed by authorized approver, or having been altered without authorization, or having not been stamped by the "Dedicated Testing/Inspection Stamp" is deemed to be invalid. Copying or excerpting portion of, or altering the content of the report is not permitted without the written authorization of AGC. The test results presented in the report apply only to the tested sample. Any objections to report issued by AGC should be submitted to AGC within 15days after the issuance of the test report. Further enquiry of validity or verification of the test report should be addressed to AGC by agc01@agccert.com.

Attestation of Global Compliance(Shenzhen)Co., Ltd
Attestation of Global Compliance(Shenzhen)Std & Tech Co., Ltd
Tel: +86-755 2523 4088 E-mail: agc@agccert.com Web: http://www.agccert.com/

EUT	Bluetooth Dongle	Model Name	C013
Temperature	25° C	Relative Humidity	55.4%
Pressure	960hPa	Test Voltage	Normal Voltage
Test Mode	Mode 3	Antenna	Horizontal

Test Graph for Peak Measurement

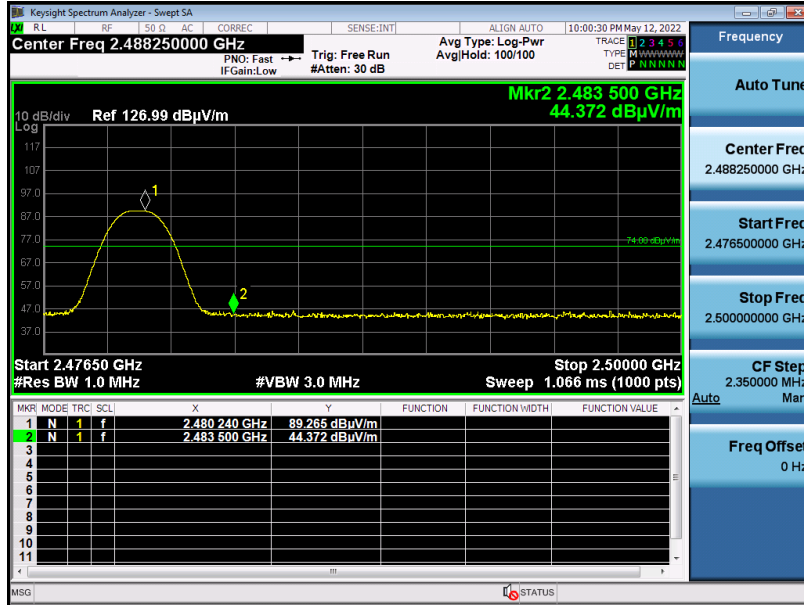

Test Graph for Average Measurement

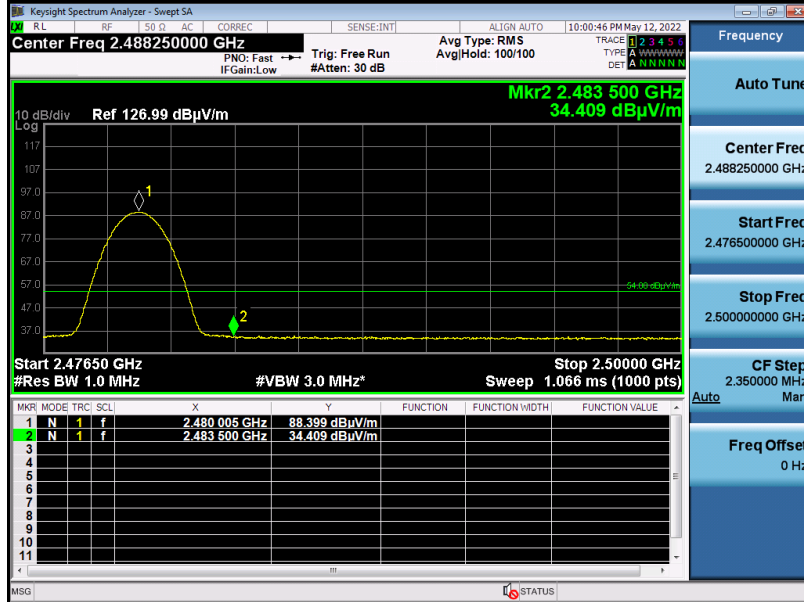

RESULT: PASS

Any report having not been signed by authorized approver, or having been altered without authorization, or having not been stamped by the "Dedicated Testing/Inspection Stamp" is deemed to be invalid. Copying or excerpting portion of, or altering the content of the report is not permitted without the written authorization of AGC. The test results presented in the report apply only to the tested sample. Any objections to report issued by AGC should be submitted to AGC within 15days after the issuance of the test report. Further enquiry of validity or verification of the test report should be addressed to AGC by agc01@agccert.com.

Attestation of Global Compliance(Shenzhen)Co., Ltd
Attestation of Global Compliance(Shenzhen)Std & Tech Co., Ltd
Tel: +86-755 2523 4088 E-mail: agc@agccert.com Web: http://www.agccert.com/

EUT	Bluetooth Dongle	Model Name	C013
Temperature	25° C	Relative Humidity	55.4%
Pressure	960hPa	Test Voltage	Normal Voltage
Test Mode	Mode 3	Antenna	Vertical

Test Graph for Peak Measurement

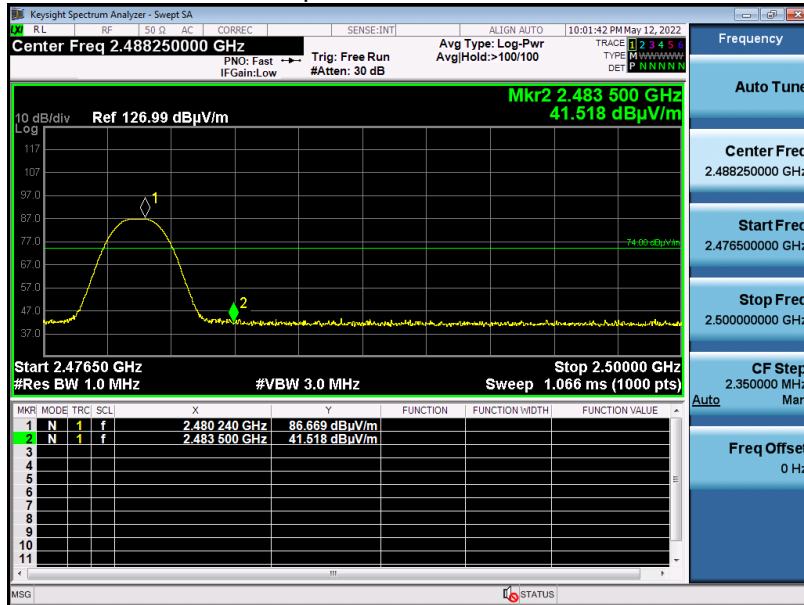

Test Graph for Average Measurement

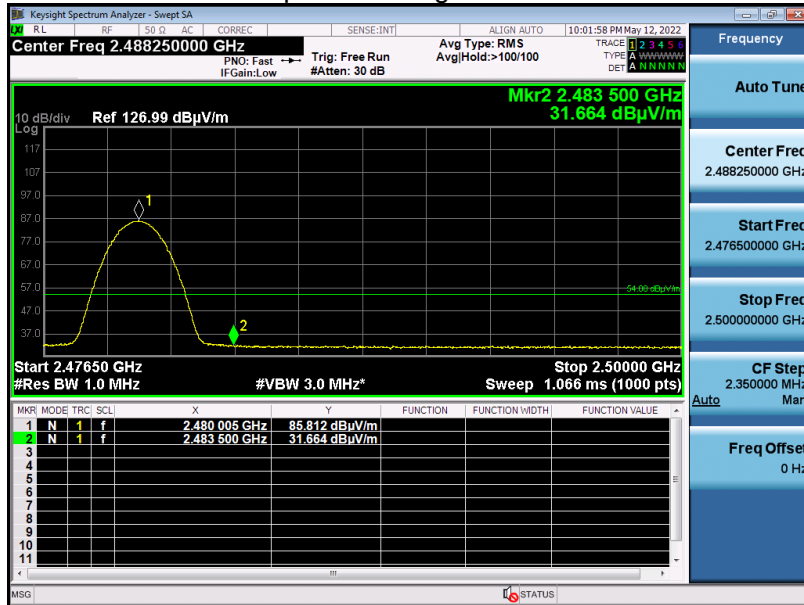

RESULT: PASS

Note: The factor had been edited in the “Input Correction” of the Spectrum Analyzer.

Any report having not been signed by authorized approver, or having been altered without authorization, or having not been stamped by the “Dedicated Testing/Inspection Stamp” is deemed to be invalid. Copying or excerpting portion of, or altering the content of the report is not permitted without the written authorization of AGC. The test results presented in the report apply only to the tested sample. Any objections to report issued by AGC should be submitted to AGC within 15days after the issuance of the test report. Further enquiry of validity or verification of the test report should be addressed to AGC by agc01@agccert.com.

12. LINE CONDUCTED EMISSION TEST

12.1. LIMITS OF LINE CONDUCTED EMISSION TEST

Frequency	Maximum RF Line Voltage	
	Q.P.(dBuV)	Average(dBuV)
150kHz~500kHz	66-56	56-46
500kHz~5MHz	56	46
5MHz~30MHz	60	50

Note:

1. The lower limit shall apply at the transition frequency.
2. The limit decreases linearly with the logarithm of the frequency in the range 0.15 MHz to 0.50 MHz.

12.2. BLOCK DIAGRAM OF LINE CONDUCTED EMISSION TEST

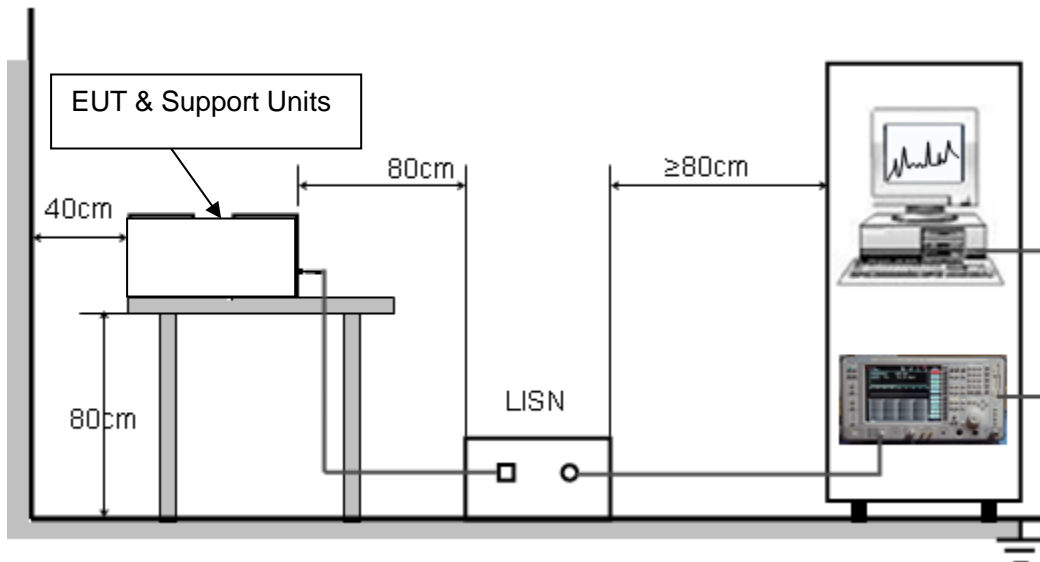

Any report having not been signed by authorized approver, or having been altered without authorization, or having not been stamped by the "Dedicated Testing/Inspection Stamp" is deemed to be invalid. Copying or excerpting portion of, or altering the content of the report is not permitted without the written authorization of AGC. The test results presented in the report apply only to the tested sample. Any objections to report issued by AGC should be submitted to AGC within 15days after the issuance of the test report. Further enquiry of validity or verification of the test report should be addressed to AGC by agc01@agccert.com.

12.3. PRELIMINARY PROCEDURE OF LINE CONDUCTED EMISSION TEST

1. The equipment was set up as per the test configuration to simulate typical actual usage per the user's manual. When the EUT is a tabletop system, a wooden table with a height of 0.8 meters is used and is placed on the ground plane as per ANSI C63.10 (see Test Facility for the dimensions of the ground plane used). When the EUT is a floor-standing equipment, it is placed on the ground plane which has a 3-12 mm non-conductive covering to insulate the EUT from the ground plane.
2. Support equipment, if needed, was placed as per ANSI C63.10.
3. All I/O cables were positioned to simulate typical actual usage as per ANSI C63.10.
4. All support equipment received AC120V/60Hz power from a LISN, if any.
5. The EUT received DC 5V power from adapter which received AC120V/60Hz power from a LISN.
6. The test program was started. Emissions were measured on each current carrying line of the EUT using a spectrum Analyzer / Receiver connected to the LISN powering the EUT. The LISN has two monitoring points: Line 1 (Hot Side) and Line 2 (Neutral Side). Two scans were taken: one with Line 1 connected to Analyzer / Receiver and Line 2 connected to a 50 ohm load; the second scan had Line 1 connected to a 50 ohm load and Line 2 connected to the Analyzer / Receiver.
7. Analyzer / Receiver scanned from 150 kHz to 30MHz for emissions in each of the test modes.
8. During the above scans, the emissions were maximized by cable manipulation.
9. The test mode(s) were scanned during the preliminary test.

Then, the EUT configuration and cable configuration of the above highest emission level were recorded for reference of final testing.

12.4. FINAL PROCEDURE OF LINE CONDUCTED EMISSION TEST

1. EUT and support equipment was set up on the test bench as per step 2 of the preliminary test.
2. A scan was taken on both power lines, Line 1 and Line 2, recording at least the six highest emissions. Emission frequency and amplitude were recorded into a computer in which correction factors were used to calculate the emission level and compare reading to the applicable limit. If EUT emission level was less – 2dB to the A.V. limit in Peak mode, then the emission signal was re-checked using Q.P and Average detector.
3. The test data of the worst case condition(s) was reported on the Summary Data page.

12.5. TEST RESULT OF LINE CONDUCTED EMISSION TEST

Line Conducted Emission Test Line 1-L

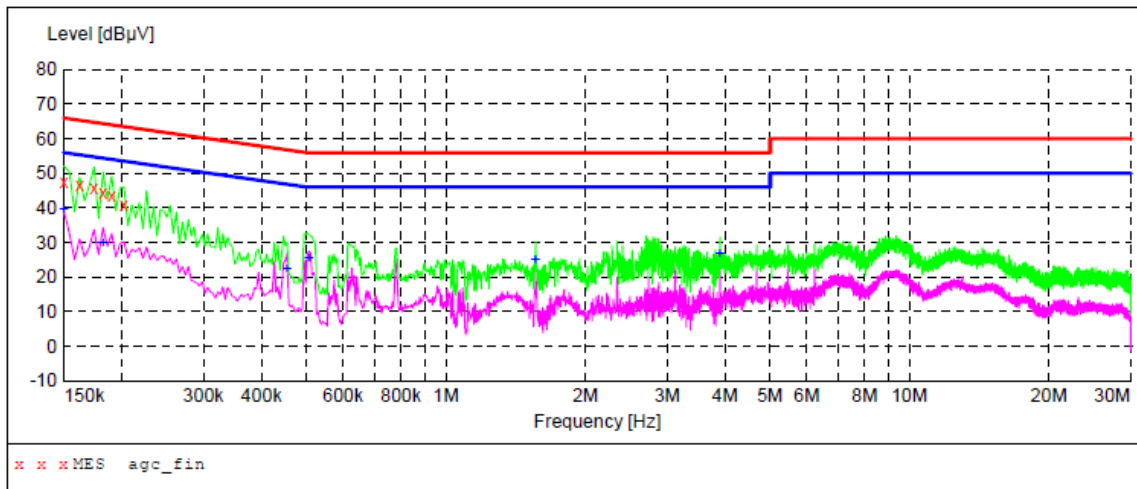

MEASUREMENT RESULT: "agc_fin"

2022/5/17 16:54

Frequency MHz	Level dBµV	Transd dB	Limit dBµV	Margin dB	Detector	Line	PE
0.150000	47.30	6.9	66	18.7	QP	L1	GND
0.162000	46.80	6.8	65	18.6	QP	L1	GND
0.174000	45.60	6.7	65	19.2	QP	L1	GND
0.182000	44.40	6.7	64	20.0	QP	L1	GND
0.190000	43.50	6.6	64	20.5	QP	L1	GND
0.202000	40.90	6.5	64	22.6	QP	L1	GND

MEASUREMENT RESULT: "agc_fin2"

2022/5/17 16:54

Frequency MHz	Level dBµV	Transd dB	Limit dBµV	Margin dB	Detector	Line	PE
0.150000	39.40	6.9	56	16.6	AV	L1	GND
0.182000	30.00	6.7	54	24.4	AV	L1	GND
0.454000	22.40	5.5	47	24.4	AV	L1	GND
0.506000	25.30	5.4	46	20.7	AV	L1	GND
1.558000	25.10	6.1	46	20.9	AV	L1	GND
3.898000	26.90	6.5	46	19.1	AV	L1	GND

Any report having not been signed by authorized approver, or having been altered without authorization, or having not been stamped by the "Dedicated Testing/Inspection Stamp" is deemed to be invalid. Copying or excerpting portion of, or altering the content of the report is not permitted without the written authorization of AGC. The test results presented in the report apply only to the tested sample. Any objections to report issued by AGC should be submitted to AGC within 15days after the issuance of the test report. Further enquiry of validity or verification of the test report should be addressed to AGC by agc01@agccert.com.

Line Conducted Emission Test Line 2-N

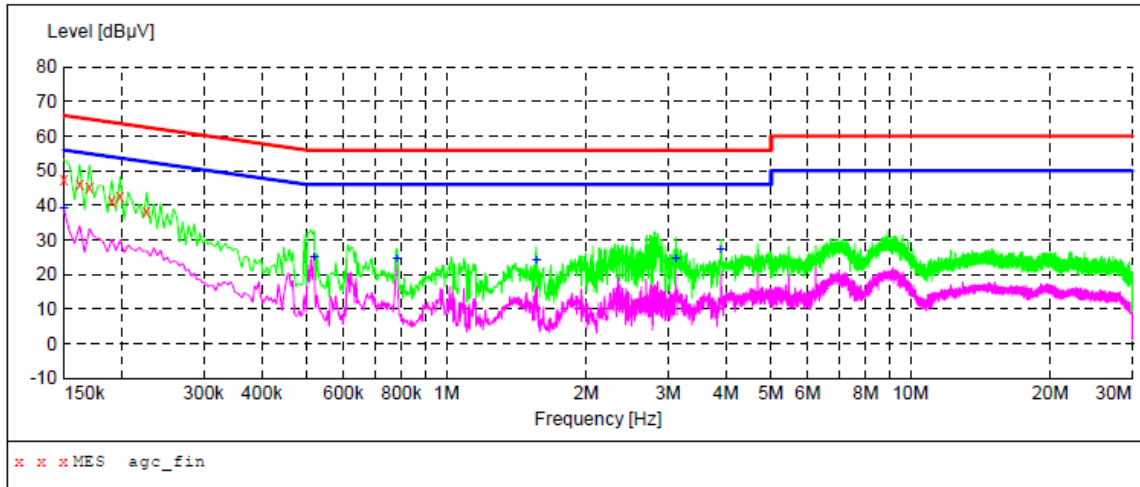

MEASUREMENT RESULT: "agc_fin"

2022/5/17 16:57

Frequency MHz	Level dBµV	Transd dB	Limit dBµV	Margin dB	Detector	Line	PE
0.150000	47.40	6.9	66	18.6	QP	N	GND
0.162000	46.30	6.8	65	19.1	QP	N	GND
0.170000	45.10	6.8	65	19.9	QP	N	GND
0.190000	41.20	6.6	64	22.8	QP	N	GND
0.198000	42.50	6.6	64	21.2	QP	N	GND
0.226000	38.00	6.4	63	24.6	QP	N	GND

MEASUREMENT RESULT: "agc_fin2"

2022/5/17 16:57

Frequency MHz	Level dBµV	Transd dB	Limit dBµV	Margin dB	Detector	Line	PE
0.150000	39.30	6.9	56	16.7	AV	N	GND
0.518000	25.20	5.4	46	20.8	AV	N	GND
0.782000	24.40	5.4	46	21.6	AV	N	GND
1.562000	24.00	6.1	46	22.0	AV	N	GND
3.118000	24.70	6.5	46	21.3	AV	N	GND
3.898000	27.20	6.5	46	18.8	AV	N	GND

RESULT: PASS

Note: All the test modes had been tested, the mode 1 was the worst case. Only the data of the worst case would be record in this test report.

Any report having not been signed by authorized approver, or having been altered without authorization, or having not been stamped by the "Dedicated Testing/Inspection Stamp" is deemed to be invalid. Copying or excerpting portion of, or altering the content of the report is not permitted without the written authorization of AGC. The test results presented in the report apply only to the tested sample. Any objections to report issued by AGC should be submitted to AGC within 15days after the issuance of the test report. Further enquiry of validity or verification of the test report should be addressed to AGC by agc01@agccert.com.

APPENDIX A: PHOTOGRAPHS OF TEST SETUP

Refer to the Report No.: AGC00006220501AP01

APPENDIX B: PHOTOGRAPHS OF EUT

Refer to the Report No.: AGC00006220501AP02

----END OF REPORT----

Any report having not been signed by authorized approver, or having been altered without authorization, or having not been stamped by the "Dedicated Testing/Inspection Stamp" is deemed to be invalid. Copying or excerpting portion of, or altering the content of the report is not permitted without the written authorization of AGC. The test results presented in the report apply only to the tested sample. Any objections to report issued by AGC should be submitted to AGC within 15days after the issuance of the test report. Further enquiry of validity or verification of the test report should be addressed to AGC by agc01@agccert.com.

Attestation of Global Compliance(Shenzhen)Co., Ltd

Attestation of Global Compliance(Shenzhen)Std & Tech Co., Ltd

Tel: +86-755 2523 4088 E-mail: agc@agccert.com Web: <http://www.agccert.com/>



Conditions of Issuance of Test Reports

1. All samples and goods are accepted by the Attestation of Global Compliance (Shenzhen) Co., Ltd (the “Company”) solely for testing and reporting in accordance with the following terms and conditions. The company provides its services on the basis that such terms and conditions constitute express agreement between the company and any person, firm or company requesting its services (the “Clients”).
2. Any report issued by Company as a result of this application for testing services (the “Report”) shall be issued in confidence to the Clients and the Report will be strictly treated as such by the Company. It may not be reproduced either in its entirety or in part and it may not be used for advertising or other unauthorized purposes without the written consent of the Company. The Clients to whom the Report is issued may, however, show or send it, or a certified copy thereof prepared by the Company to its customer, supplier or other persons directly concerned. The Company will not, without the consent of the Clients, enter into any discussion or correspondence with any third party concerning the contents of the Report, unless required by the relevant governmental authorities, laws or court orders.
3. The Company shall not be called or be liable to be called to give evidence or testimony on the Report in a court of law without its prior written consent, unless required by the relevant governmental authorities, laws or court orders.
4. In the event of the improper use of the report as determined by the Company, the Company reserves the right to withdraw it, and to adopt any other additional remedies which may be appropriate.
5. Samples submitted for testing are accepted on the understanding that the Report issued cannot form the basis of, or be the instrument for, any legal action against the Company.
6. The Company will not be liable for or accept responsibility for any loss or damage however arising from the use of information contained in any of its Reports or in any communication whatsoever about its said tests or investigations.
7. Clients wishing to use the Report in court proceedings or arbitration shall inform the Company to that effect prior to submitting the sample for testing.
8. The Company is not responsible for recalling the electronic version of the original report when any revision is made to them. The Client assumes the responsibility to providing the revised version to any interested party who uses them.
9. Subject to the variable length of retention time for test data and report stored hereinto as otherwise specifically required by individual accreditation authorities, the Company will only keep the supporting test data and information of the test report for a period of six years. The data and information will be disposed of after the aforementioned retention period has elapsed. Under no circumstances shall we provide any data and information which has been disposed of after retention period. Under no circumstances shall we be liable for damage of any kind, including (but not limited to) compensatory damages, lost profits, lost data, or any form of special, incidental, indirect, consequential or punitive damages of any kind, whether based on breach of contract of warranty, tort (including negligence), product liability or otherwise, even if we are informed in advance of the possibility of such damages.

Any report having not been signed by authorized approver, or having been altered without authorization, or having not been stamped by the “Dedicated Testing/Inspection Stamp” is deemed to be invalid. Copying or excerpting portion of, or altering the content of the report is not permitted without the written authorization of AGC. The test results presented in the report apply only to the tested sample. Any objections to report issued by AGC should be submitted to AGC within 15 days after the issuance of the test report. Further enquiry of validity or verification of the test report should be addressed to AGC by agc01@agccert.com.