

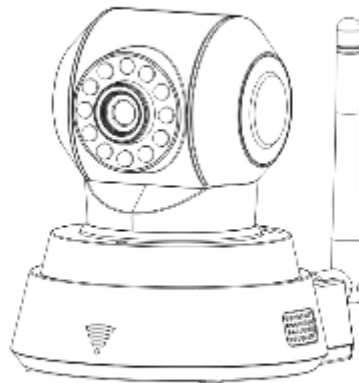

256H1

Quick Installation Guide



Package Contents

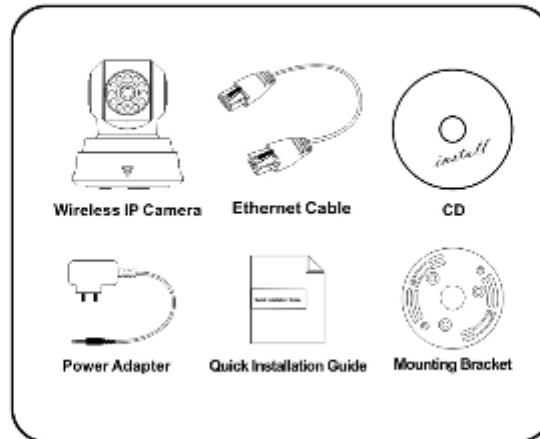

Physical Description

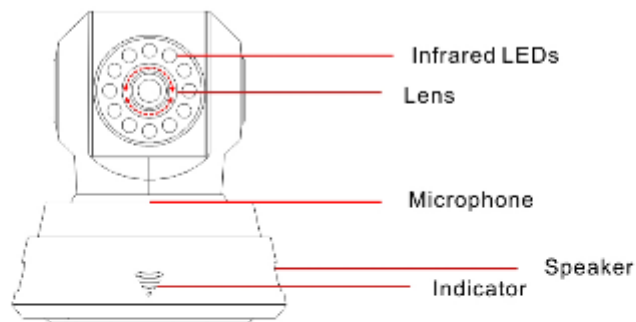

Front View

Speaker: Built-in speaker

Lens: Fixed focus lens(adjustable)

Infrared LEDs: Infrared LEDs for night vision

Microphone: Built-in microphone

Indicator: Power and network indicator

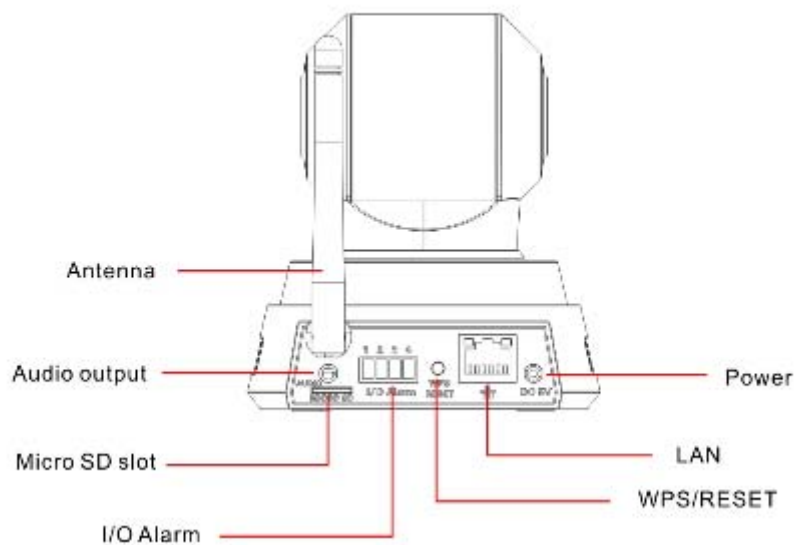

Rear View

LAN: 10/100 Mbps RJ-45 port for wired connection

Power: DC 5V/2A Power supply(After the camera is powered on, it will move horizontally and vertically for about 2 minutes)

WPS/RESET: Wi-Fi Protected Set-up/Reset

Micro SD slot: Up to 32GB SD card for storing the video

Audio Output: External microphone jack

I/O Alarm: 1,2 Alarm output; 3,4 Alarm input

Antenna: Wireless antenna

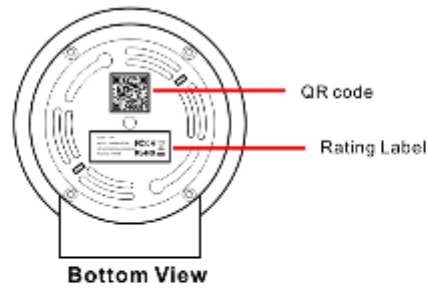

Rating Label: Model No., MAC address, UID, password on the label

Mounting Bracket Installation

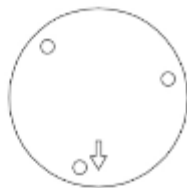

1. Put the stickers on the wall
(Note: The arrow is to indicate the lens direction)

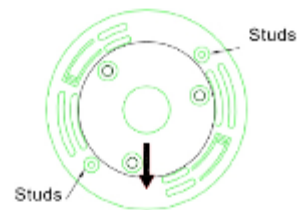

2. Nail the mounting bracket on the wall as per the stickers' guide

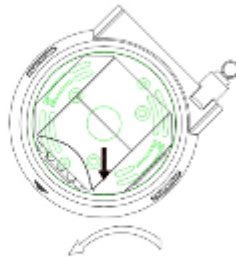

3. Hang the device on the mounting bracket at a 45-degree angle, and then contrarotate the device 45 degree or so



4. Finish

 **Note:**

You need to prepare yourself with the tools like the drill.

Step 1: Connect the IP Camera to Internet

- **Wired Connection**

Two optional ways of wired connection are as followed:

Option 1: Connect IP Camera to the router

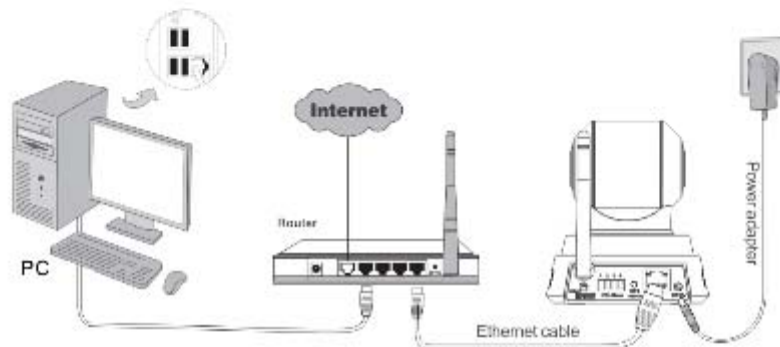

Option 2: Connect IP Camera to computer directly

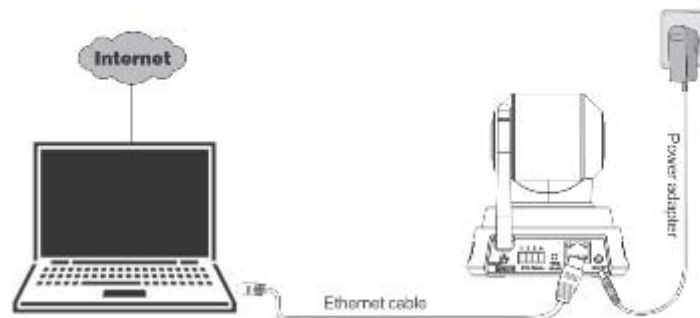

● **WPS (Wi-Fi Protected Set-up) Connection**

- ① Press WPS button on the router when the IP Camera is connected to the power supply 2 minutes.
- ② And then press the WPS button on the IP Camera for 5~9s.
- ③ After release of the WPS button on the IP camera for 2 minutes, the WPS Connection should be successful.
- ④ To confirm your successful WPS Connection, you can search IP Camera on computer or smartphone that has been connected to the Internet by the same router.

 **Note:**

You just need to choose either Wired Connection or WPS Connection. Before using the WPS connection, please make sure that your router supports WPS function and open the WPS function. If your router does not support WPS function or WPS connection failed, please refer to the User Manual in the CD for WIFI Setup.

Step 2: Access to IP Camera in following two optional ways

2.1 Access to IP Camera by Smart Phone (Android or iOS operation system)

- ① Search and install "P2P iCamera" on Google Play for Android devices, or "P2P iCamera" on App store for iOS devices.



- ② Click "P2P iCamera" on your phone to run the APP.



- ③ Click Scan QR Code icon after LOGIN, your phone will go into the QR code scanning mode.



- ④ Scan the QR code on the bottom of the IP Camera, input the default password (888888), and then click 

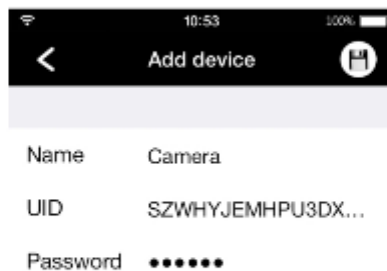

 **Note:**

If the QR code scanning is not successful, please input the UID on the bottom of the camera manually.

- ⑤ After the device has been added successfully, you can click it to check the live video.

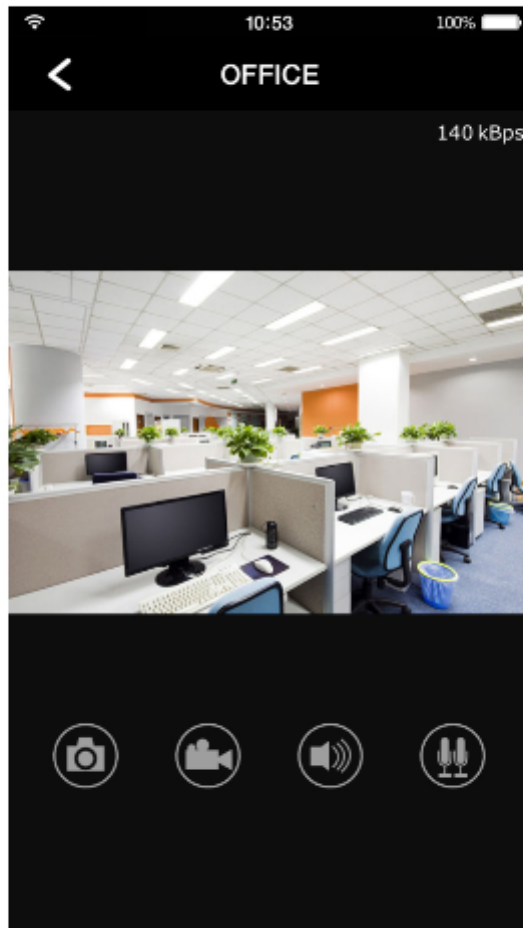

2.2 Access to IP Camera by Personal Computer

After IP camera is connected to PC LAN through router, you could operate IP camera via PC, first please put right CD to CD-ROM, install and run on the related software.

- **Windows system**

Open the disk, double click , and then CD will run automatically.



- **Mac OS**

Open the disk, double click , and then CD will run automatically.



 **Note:**

Please download the software from website If you have no CD driver on PC.

- ① Double click the icon on your desktop to run the software.
Input user name and password, then Click LOGIN



P2P iCamera

Network camera system

User name: [Register](#)

Password:

Remember me Auto login Local mode



Note:
If you don't have user ID, please register firstly.

Register account

User name:

Password:

Affirm password:

E-mail:

② Click the Search button & Add the device in LAN

ID	IP address	Device UID
1	192.168.7.109	A0000FNA9ED7P9H425964
2	192.168.7.147	T7MH2574PMA3W0LWANCJ
3	192.168.7.104	95G056FNA9ED7P9H318
4	192.168.7.190	A0000FNA9ED7P9H14025
5	192.168.7.118	TVGLWC64WCA3F0LWANWJ

or Add the device in WAN

Device name: admin

Device UID: A0000FNA9ED7P9H56815

UID password: 888888

 **Note:**

You only need to add the device at the first time of using.

- ③ Double click the selected screen in the control panel to see the live video

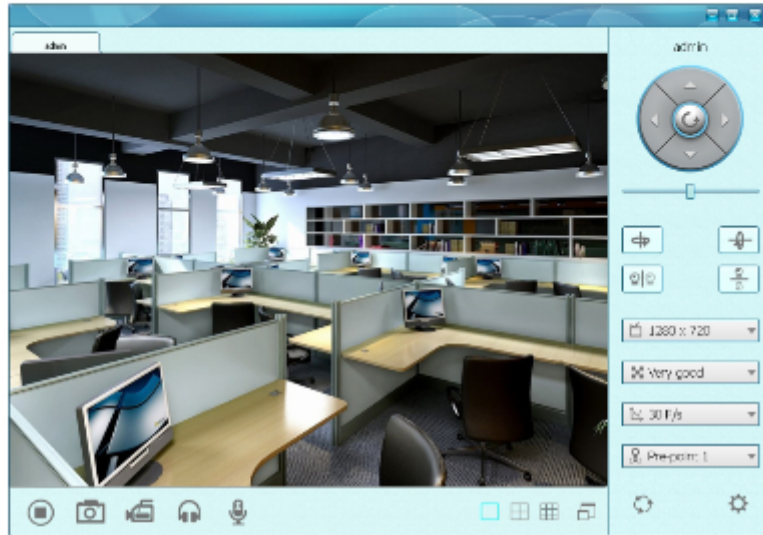

 **Note:**

If the image quality is not good enough, please adjust the lens slowly till you are satisfied.
For more details, please refer to the User Manual in the CD.



SHENZHEN ADNI ELECTRONIC INDUSTRY
CO.,LTD

Factory address: Bldg 5, Honghui Ind.Park, 2nd Liuxian Rd,
Xin'an, Bao'an, Shenzhen 518101 P.R.China
Tel: 0086-0755-29106599
Website: www.anc.cn
E-mail: ipcamera@anc.cn

FCC Requirement

Note: This equipment has been tested and found to comply with the limits for a Class B digital device, pursuant to Part 15 of the FCC Rules. These limits are designed to provide reasonable protection against harmful interference in a residential installation. This equipment generates, uses, and can radiate radio frequency energy, and if not installed and used in accordance with the instructions, may cause harmful interference to radio communications. However, there is no guarantee that interference will not occur in a particular installation. If this equipment does cause harmful interference to radio or television reception, which can be determined by turning the equipment off and on, the user is encouraged to try to correct the interference by one or more of the following measures:

- Reorient or relocate the receiving antenna.
- Increase the separation between the equipment and receiver.
- Connect the equipment into an outlet on a circuit different from that to which the receiver is connected.
- Consult the dealer or an experienced radio/TV technician for help.

You are cautioned that changes or modifications not expressly approved by the party responsible for compliance could void your authority to operate the equipment.

M/N: 256H1

FCC ID: Z63-IPC18

This device complies with Part 15 of the FCC Rules. Operation is subject to the following two conditions:

- (1) this device may not cause harmful interference, and
- (2) this device must accept any interference received, including interference that may cause undesired operation.