

FCC/ISED

RF

TEST REPORT

ISSUED BY  
Shenzhen BALUN Technology Co., Ltd.



FOR

Wi-Fi 11N USB Adapter, Black, 300 Mbps

ISSUED TO  
Compupal (Group) Corporation

No.1555 Jiashan Avenue, Jiashan 314113, Zhejiang, China



Tested by: Hu Chao  
Hu Chao  
(Engineer)  
Date: Oct. 27, 2017

Approved by: Wei Yanquan  
Wei Yanquan  
(Chief Engineer)

Date: Oct. 27, 2017

Report No.: BL-SZ1790157-601

EUT Name: Wi-Fi 11N USB Adapter, Black, 300 Mbps

Model Name: B071Y6Y83W

Brand Name: AmazonBasics

Test Standard: 47 CFR Part 15 Subpart C

RSS-Gen (Issue 4, November 2014)

RSS-247 (Issue 2, February 2017)

FCC ID: Z5Y-B071Y6Y83W

ISED Number: 10828A-B071Y6Y83W

Test conclusion: Pass

Test Date: Sep. 21, 2017 ~ Oct. 17, 2017

Date of Issue: Oct. 27, 2017

*NOTE: This test report of test results only related to testing samples, which can be duplicated completely for the legal use with the approval of the applicant; it shall not be reproduced except in full, without the written approval of Shenzhen BALUN Technology Co., Ltd. BALUN Laboratory. Any objections should be raised within thirty days from the date of issue. To validate the report, please contact us.*

### Revision History

<u>Version</u>	<u>Issue Date</u>	<u>Revisions Content</u>
<u>Rev. 01</u>	<u>Oct. 23, 2017</u>	<u>Initial Issue</u>
<u>Rev. 01</u>	<u>Oct. 27, 2017</u>	<u>Change the Product Type on page 7</u>

## TABLE OF CONTENTS

1	ADMINISTRATIVE DATA (GENERAL INFORMATION) .....	5
1.1	Identification of the Testing Laboratory .....	5
1.2	Identification of the Responsible Testing Location .....	5
1.3	Laboratory Condition .....	5
1.4	Announce .....	5
2	PRODUCT INFORMATION .....	6
2.1	Applicant Information .....	6
2.2	Manufacturer Information .....	6
2.3	Factory Information .....	6
2.4	General Description for Equipment under Test (EUT) .....	6
2.5	Ancillary Equipment .....	6
2.6	Technical Information .....	7
2.7	Additional Instructions .....	9
3	SUMMARY OF TEST RESULTS .....	10
3.1	Test Standards .....	10
3.2	Verdict .....	10
4	GENERAL TEST CONFIGURATIONS .....	11
4.1	Test Environments .....	11
4.2	Test Equipment List .....	11
4.3	Measurement Uncertainty .....	13
4.4	Description of Test Setup .....	13
4.4.1	For Antenna Port Test .....	13
4.4.2	For AC Power Supply Port Test .....	14
4.4.3	For Radiated Test (Below 30 MHz) .....	14
4.4.4	For Radiated Test (30 MHz-1 GHz) .....	15

4.4.5	For Radiated Test (Above 1 GHz).....	15
4.5	Measurement Results Explanation Example.....	16
4.5.1	For conducted test items: .....	16
4.5.2	For radiated band edges and spurious emission test:.....	16
5	TEST ITEMS.....	17
5.1	Antenna Requirements.....	17
5.1.1	Relevant Standards.....	17
5.1.2	Antenna Anti-Replacement Construction .....	17
5.1.3	Antenna Gain .....	18
5.2	Output Power .....	19
5.2.1	Test Limit.....	19
5.2.2	Test Setup .....	19
5.2.3	Test Procedure.....	19
5.2.4	Test Result .....	20
5.3	6dB Bandwidth .....	21
5.3.1	Limit.....	21
5.3.2	Test Setup .....	21
5.3.3	Test Procedure.....	21
5.3.4	Test Result .....	21
5.4	Conducted Spurious Emission .....	22
5.4.1	Limit.....	22
5.4.2	Test Setup .....	22
5.4.3	Test Procedure.....	22
5.4.4	Test Result .....	23
5.5	Band Edge (Authorized-band band-edge).....	24
5.5.1	Limit.....	24
5.5.2	Test Setup .....	24
5.5.3	Test Procedure.....	24
5.5.4	Test Result .....	25
5.6	Conducted Emission .....	26
5.6.1	Limit.....	26
5.6.2	Test Setup .....	26

5.6.3	Test Procedure .....	26
5.6.4	Test Result .....	26
5.7	Radiated Spurious Emission .....	27
5.7.1	Limit.....	27
5.7.2	Test Setup .....	27
5.7.3	Test Procedure .....	27
5.7.4	Test Result .....	30
5.8	Band Edge (Restricted-band band-edge).....	31
5.8.1	Limit.....	31
5.8.2	Test Setup .....	31
5.8.3	Test Procedure .....	31
5.8.4	Test Result .....	31
5.9	Power Spectral density (PSD).....	32
5.9.1	Limit.....	32
5.9.2	Test Setup .....	32
5.9.3	Test Procedure .....	32
5.9.4	Test Result .....	32
ANNEX A	TEST RESULT .....	33
A.1	Output Power .....	33
A.2	Bandwidth.....	35
A.3	Conducted Spurious Emissions .....	40
A.4	Band Edge (Authorized-band band-edge).....	49
A.5	Conducted Emissions.....	53
A.6	Radiated Emission .....	55
A.7	Band Edge (Restricted-band band-edge).....	63
A.8	Power Spectral Density (PSD) .....	67
ANNEX B	TEST SETUP PHOTOS .....	70
ANNEX C	EUT EXTERNAL PHOTOS .....	70
ANNEX D	EUT INTERNAL PHOTOS .....	70

# 1 ADMINISTRATIVE DATA (GENERAL INFORMATION)

## 1.1 Identification of the Testing Laboratory

Company Name	Shenzhen BALUN Technology Co., Ltd.
Address	Block B, 1st FL, Baisha Science and Technology Park, Shahe Xi Road, Nanshan District, Shenzhen, Guangdong Province, P. R. China
Phone Number	+86 755 6685 0100

## 1.2 Identification of the Responsible Testing Location

Test Location	Shenzhen BALUN Technology Co., Ltd.
Address	Block B, 1st FL, Baisha Science and Technology Park, Shahe Xi Road, Nanshan District, Shenzhen, Guangdong Province, P. R. China
Accreditation Certificate	<p>The laboratory has been listed by Industry Canada to perform electromagnetic emission measurements. The recognition numbers of test site are 11524A-1.</p> <p>The laboratory is a testing organization accredited by FCC as a accredited testing laboratory. The designation number is CN1196.</p> <p>The laboratory is a testing organization accredited by American Association for Laboratory Accreditation(A2LA) according to ISO/IEC 17025.The accreditation certificate is 4344.01.</p> <p>The laboratory is a testing organization accredited by China National Accreditation Service for Conformity Assessment (CNAS) according to ISO/IEC 17025. The accreditation certificate number is L6791.</p>
Description	All measurement facilities used to collect the measurement data are located at Block B, FL 1, Baisha Science and Technology Park, Shahe Xi Road, Nanshan District, Shenzhen, Guangdong Province, P. R. China 518055

## 1.3 Laboratory Condition

Ambient Temperature	20 to 25°C
Ambient Relative Humidity	45% - 55%
Ambient Pressure	100 kPa - 102 kPa

## 1.4 Announce

- (1) The test report reference to the report template version v6.0.
- (2) The test report is invalid if not marked with the signatures of the persons responsible for preparing and approving the test report.
- (3) The test report is invalid if there is any evidence and/or falsification.
- (4) The results documented in this report apply only to the tested sample, under the conditions and modes of operation as described herein.
- (5) This document may not be altered or revised in any way unless done so by BALUN and all revisions are duly noted in the revisions section.
- (6) Content of the test report, in part or in full, cannot be used for publicity and/or promotional purposes without prior written approval from the laboratory.

## 2 PRODUCT INFORMATION

### 2.1 Applicant Information

Applicant	Compupal (Group) Corporation
Address	No.1555 Jiashan Avenue, Jiashan 314113, Zhejiang, China

### 2.2 Manufacturer Information

Manufacturer	Compupal (Group) Corporation
Address	No.1555 Jiashan Avenue, Jiashan 314113, Zhejiang, China

### 2.3 Factory Information

Factory	Compupal (Group) Corporation
Address	No.1555 Jiashan Avenue, Jiashan 314113, Zhejiang, China

### 2.4 General Description for Equipment under Test (EUT)

EUT Type	Wi-Fi 11N USB Adapter, Black, 300 Mbps
Model Name Under Test	B071Y6Y83W
Series Model Name	N/A
Description of Model name differentiation	N/A
Hardware Version	N/A
Software Version	N/A
Dimensions (Approx.)	170.6*21.5mm*10.9mm
Weight (Approx.)	15.6g
Network and Wireless connectivity	WIFI 802.11b, 802.11g and 802.11n (HT20/40),

### 2.5 Ancillary Equipment

Note: Not applicable.

## 2.6 Technical Information

The requirement for the following technical information of the EUT was tested in this report:

Frequency Range	802.11b/g/n(20 MHz): 2.412 GHz - 2.462 GHz $f_c = 2412 \text{ MHz} + (N-1)*5 \text{ MHz}$ , where - $f_c$ = "Operating Frequency" in MHz, - N = "Channel Number" with the range from 1 to 11. 802.11n(40 MHz): 2.422 GHz - 2.452 GHz $f_c = 2412 \text{ MHz} + (N-1)*5 \text{ MHz}$ , where - $f_c$ = "Operating Frequency" in MHz, - N = "Channel Number" with the range from 3 to 9.
Modulation Type	DSSS, OFDM
Product Type	<input type="checkbox"/> Mobile <input checked="" type="checkbox"/> Portable <input type="checkbox"/> Fix Location
Antenna Type	PCB Antenna
Antenna Gain	-2.71 dBi
About the Product	Only the WIFI 802.11b, 802.11g and 802.11n (HT20/40) was tested in this report.

Modulation technology	Modulation Type	Transfer Rate (Mbps)
DSSS (802.11b)	DBPSK	1
	DQPSK	2
	CCK	5.5/ 11
OFDM (802.11g)	BPSK	6 / 9
	QPSK	12 / 18
	16QAM	24 / 36
	64QAM	48 / 54
OFDM (802.11n-20MHz)	BPSK	6.5
	QPSK	13/19.5
	16QAM	26/39
	64QAM	52/58.5/65
OFDM (802.11n-40MHz)	BPSK	13.5
	QPSK	27/40.5
	16QAM	54/81/108
	64QAM	121.5/135

Note: Preliminary tests were performed in different data rate in above table to find the worst radiated emission. The data rate shown in the table below is the worst-case rate with respect to the specific test item. Investigation has been done on all the possible configurations for searching the worst cases. The following table is a list of the test modes shown in this test report.

Test Items	Mode	Data Rate	Channel	
Output Power	11b/11g/11n20/11n40	1/6/6.5/13.5 Mbps	1/6/11	3/6/9
6dB Bandwidth	11b/11g/11n20/11n40	1/6/6.5/13.5 Mbps	1/6/11	3/6/9
Conducted Spurious Emission	11b/11g/11n20/11n40	1/6/6.5/13.5 Mbps	1/6/11	3/6/9
Conducted Emission	11b/11g/11n20/11n40	1/6/6.5/13.5 Mbps	1/6/11	3/6/9
Radiated Spurious Emission	11b/11g/11n20/11n40	1/6/6.5/13.5 Mbps	1/6/11	3/6/9
Band Edge	11b/11g/11n20/11n40	1/6/6.5/13.5 Mbps	1/6/11	3/6/9
Power spectral density (PSD)	11b/11g/11n20/11n40	1/6/6.5/13.5 Mbps	1/6/11	3/6/9

Note: The above EUT information in section 2.4 and 2.6 was declared by manufacturer and for more detailed features description, please refer to the manufacturer's specifications or user's manual.



## 2.7 Additional Instructions

EUT Software Settings:

Mode	<input checked="" type="checkbox"/> Special software is used. The software provided by client to enable the EUT under transmission condition continuously at specific channel frequencies individually.
------	--

During testing, Channel and Power Controlling Software provided by the customer was used to control the operating channel as well as the output power level. The RF output power selection is for the setting of RF output power expected by the customer and is going to be fixed on the firmware of the final end product.

EUT Software Settings:

Power level setup in software			
Test Software Version	Realtek		
Support Units (Software installation media)	Description	Manufacturer	Model
	Laptop	Lenovo	X220
Mode	Channel	Soft Set	
802.11 b	Low	34	
	Middle	35	
	High	35	
802.11 g	Low	46	
	Middle	50	
	High	47	
802.11 n20	Low	48	
	Middle	52	
	High	49	
802.11 n40	Low	48	
	Middle	50	
	High	49	

Run software:

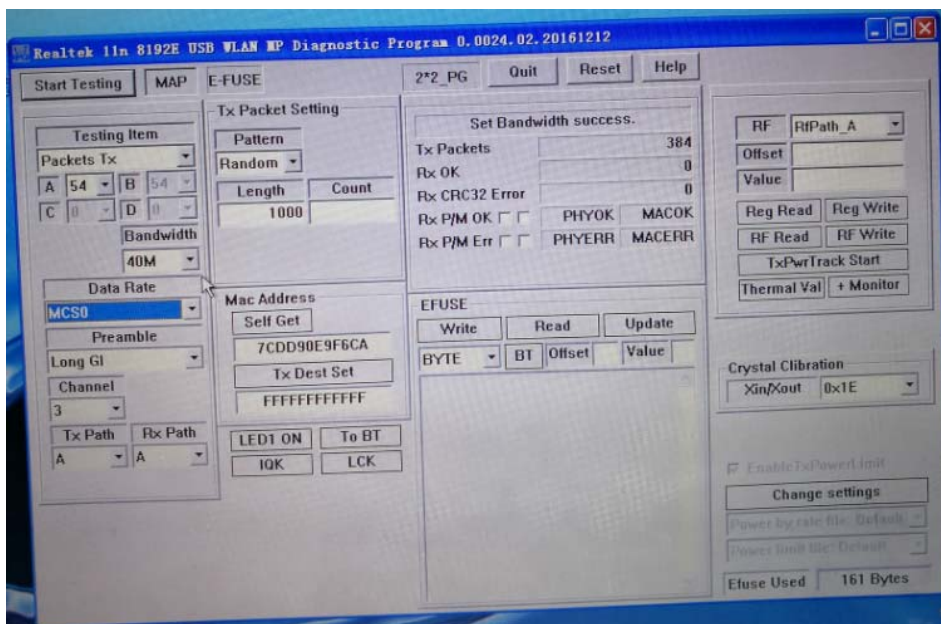

### 3 SUMMARY OF TEST RESULTS

#### 3.1 Test Standards

No.	Identity	Document Title
1	47 CFR Part 15, Subpart C (10-1-15 Edition)	Miscellaneous Wireless Communications Services
2	KDB Publication 558074 D01v04	Guidance for Performing Compliance Measurements on Digital Transmission Systems (DTS) Operating Under §15.247
3	KDB Publication 662911 D01v02r01	Emissions Testing of Transmitters with Multiple Outputs in the Same Band (e.g., MIMO, Smart Antenna, etc)
4	RSS-Gen (Issue 4, Nov. 2014)	General Requirements for Compliance of Radio Apparatus
5	RSS-247 (Issue 2, February 2017)	Digital Transmission Systems (DTSs), Frequency Hopping Systems(FHSs) and Licence-Exempt Local Area Network (LE-LAN) Devices
6	ANSI C63.10-2013	American National Standard of Procedures for Compliance Testing of Unlicensed Wireless Devices

#### 3.2 Verdict

No.	Description	FCC PART No.	ISED Part No.	Test Result	Verdict
1	Antenna Requirement	15.203; 15.247(b)	RSS-247, 5.4 (6)	N/A	Pass <sup>Note 1</sup>
2	Output Power	15.247(b)	RSS-247, 5.4 (4)	ANNEX A.1	Pass
3	6dB Bandwidth	15.247(a)	RSS-GEN, 6.6; RSS-247, 5.2 (1)	ANNEX A.2	Pass
4	Conducted Spurious Emission	15.247(d)	RSS-247, 5.5	ANNEX A.3	Pass
5	Band Edge(Authorized-band band-edge)	15.209; 15.247(d)	RSS-GEN, 8.9; RSS-247, 5.5	ANNEX A.4	Pass
6	Conducted Emission	15.207	RSS-GEN, 8.8	ANNEX A.5	Pass
7	Radiated Spurious Emission	15.209; 15.247(d)	RSS-247, 5.5	ANNEX A.6	Pass
8	Band Edge(Restricted-band band-edge)	15.209; 15.247(d)	RSS-247, 5.5	ANNEX A.7	Pass
9	Power spectral density (PSD)	15.247(e)	RSS-247, 5.2 (2)	ANNEX A.8	Pass
10	Receiver Spurious Emissions	N/A	RSS-Gen, 7.1.2	N/A	N/A <sup>Note 2</sup>

Note 1: Please refer to section 5.1.

Note 2: Only radio communication receivers operating in stand-alone mode within the band 30-960 MHz, as well as scanner receivers, are subject to Industry Canada requirements, so this test is not applicable.

## 4 GENERAL TEST CONFIGURATIONS

### 4.1 Test Environments

During the measurement, the normal environmental conditions were within the listed ranges:

Relative Humidity	45% - 55%	
Atmospheric Pressure	100 kPa - 102 kPa	
Temperature	NT (Normal Temperature)	+22°C to +25°C
Working Voltage of the EUT	NV (Normal Voltage)	5 V

### 4.2 Test Equipment List

Description	Manufacturer	Model	Serial No.	Cal. Date	Cal. Due
Spectrum Analyzer	ROHDE&SCHWARZ	FSV-30	103118	2017.06.22	2018.06.21
Switch Unit with OSP-B157	ROHDE&SCHWARZ	OSP120	101270	2017.06.22	2018.06.21
EMI Receiver	KEYSIGHT	N9038A	MY53220118	2017.09.07	2018.09.06
EMI Receiver	ROHDE&SCHWARZ	ESRP	101036	2017.06.22	2018.06.21
LISN	SCHWARZBECK	NSLK 8127	8127-687	2017.06.22	2018.06.21
Bluetooth Tester	ROHDE&SCHWARZ	CBT	101005	2017.06.22	2018.06.21
Power Splitter	KMW	DCPD-LDC	1305003215	--	--
Power Sensor	ROHDE&SCHWARZ	NRP-Z21	103971	2017.06.22	2018.06.21
Attenuator (20 dB)	KMW	ZA-S1-201	110617091	--	--
Attenuator (6 dB)	KMW	ZA-S1-61	1305003189	--	--
DC Power Supply	ROHDE&SCHWARZ	HMP2020	018141664	2017.06.22	2018.06.21
Temperature Chamber	ANGELANTIONI SCIENCE	NTH64-40A	1310	2017.06.22	2018.06.21
Test Antenna-Loop(9 kHz-30 MHz)	SCHWARZBECK	FMZB 1519	1519-037	2017.06.22	2018.06.21
Test Antenna-Bi-Log(30 MHz-3 GHz)	SCHWARZBECK	VULB 9163	9163-624	2017.06.22	2018.06.21
Test Antenna-Horn(1-18 GHz)	SCHWARZBECK	BBHA 9120D	9120D-1148	2017.06.22	2018.06.21
Test Antenna-Horn(15-26.5 GHz)	SCHWARZBECK	BBHA 9170	9170-305	2017.06.22	2018.06.21
Test Antenna-Horn (18-40 GHz)	A-INFO	LB-180400KF	J211060273	N/A	2018.01.06
Anechoic Chamber	RAINFORD	9m*6m*6m	N/A	2017.02.24	2019.02.23
Anechoic Chamber	EMC Electronic Co., Ltd	20.10*11.60*7.35m	N/A	2016.08.09	2018.08.08
Shielded Enclosure	ChangNing	CN-130701	130703	--	--
Signal Generator	ROHDE&SCHWARZ	SMB100A	177746	2017.06.22	2018.06.21
Power Amplifier	OPHIR RF	5225F	1037	2017.02.17	2018.02.16
Power Amplifier	OPHIR RF	5273F	1016	2017.02.17	2018.02.16
Directional Coupler	Werlantone	C5982-10	109275	N/A	N/A

Description	Manufacturer	Model	Serial No.	Cal. Date	Cal. Due
Directional Coupler	Werlantone	CHP-273E	S00801z-01	N/A	N/A
Feld Strength Meter	Narda	EP601	511WX51129	2017.02.23	2018.02.22
Mouth Simulator	B&K	4227	2423931	2016.11.15	2017.11.14
Sound Calibrator	B&K	4231	2430337	2016.11.09	2017.11.08
Sound Level Meter	B&K	NL-20	00844023	2016.11.11	2017.11.10
Ear Simulator	B&K	4185	2409449	2016.11.15	2017.11.14
Ear Simulator	B&K	4195	2418189	2016.11.15	2017.11.14
Audio analyzer	B&K	UPL 16	100129	2016.11.08	2017.11.07

### 4.3 Measurement Uncertainty

The following measurement uncertainty levels have been estimated for tests performed on the EUT as specified in CISPR 16-4-2.

This uncertainty represents an expanded uncertainty expressed at approximately the 95% confidence level using a coverage factor of k=2.

Measurement	Value
Occupied Channel Bandwidth	±4%
RF output power, conducted	±1.4 dB
Power Spectral Density, conducted	±2.5 dB
Unwanted Emissions, conducted	±2.8 dB
All emissions, radiated	±5.4 dB
Temperature	±1°C
Humidity	±4%

### 4.4 Description of Test Setup

#### 4.4.1 For Antenna Port Test

Conducted value (dBm) = Measurement value (dBm) + cable loss (dB)

For example: the measurement value is 10 dBm and the cable 0.5dBm used, then the final result of EUT:

Conducted value (dBm) = 10 dBm + 0.5 dB = 10.5 dBm

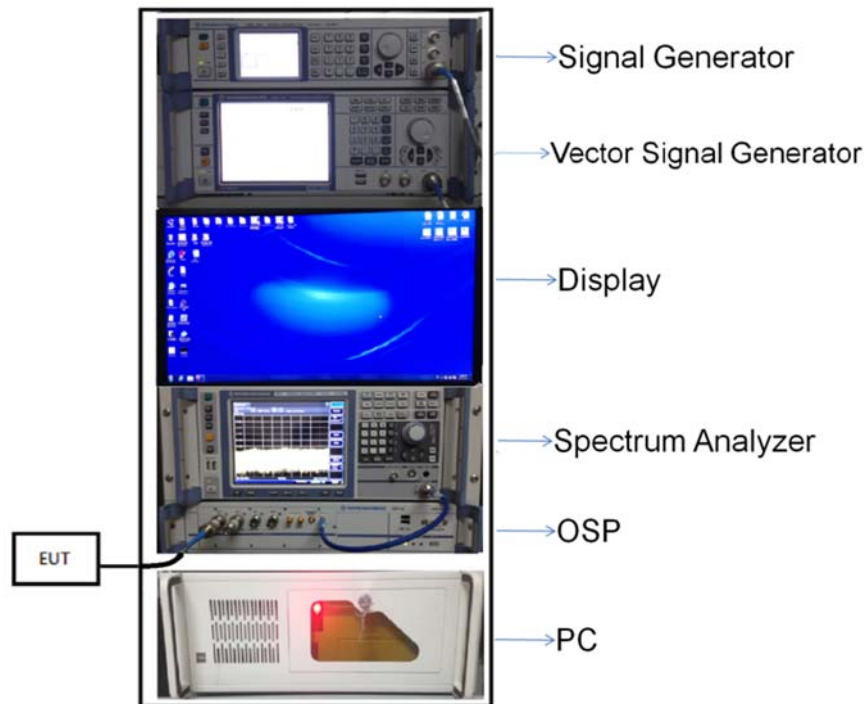

(Diagram 1)

4.4.2 For AC Power Supply Port Test

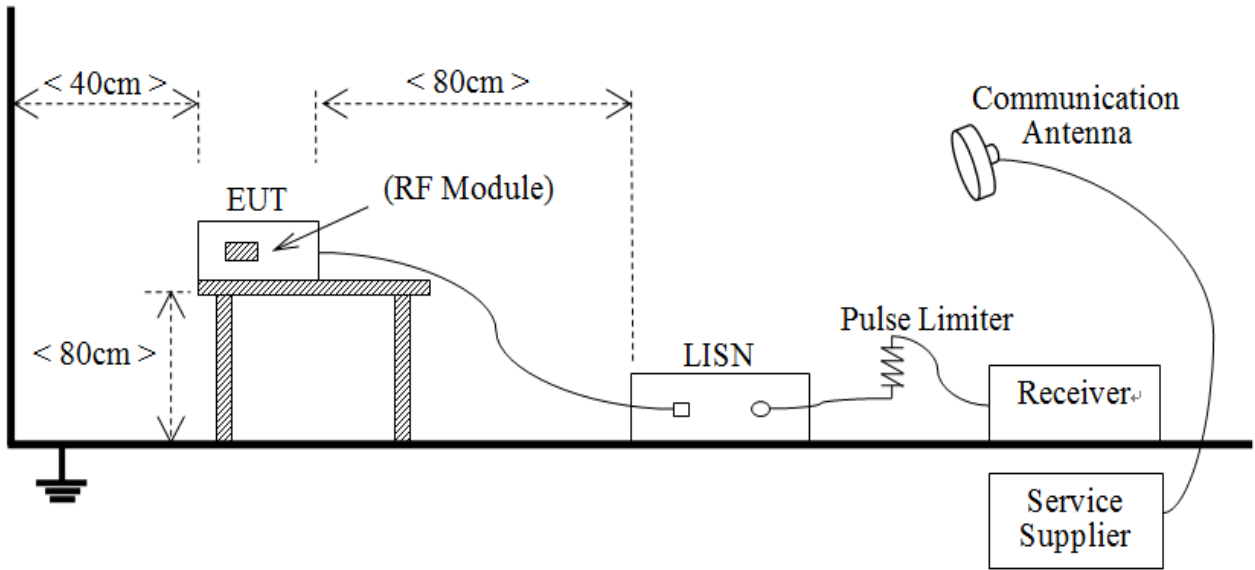

(Diagram 2)

4.4.3 For Radiated Test (Below 30 MHz)

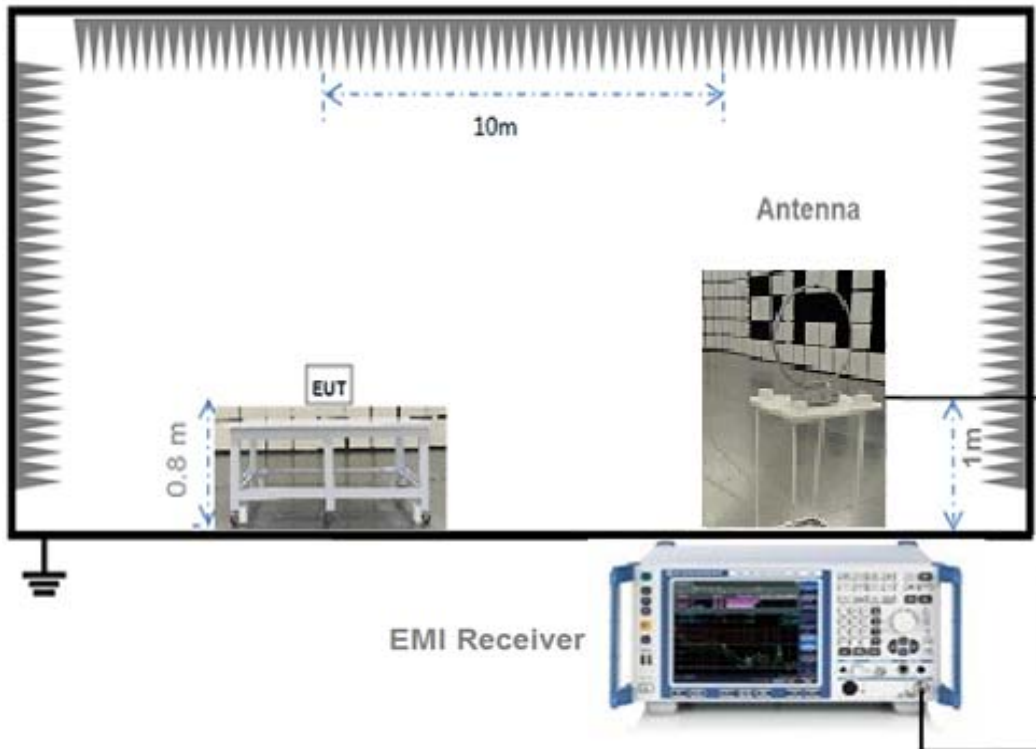

(Diagram 3)

4.4.4 For Radiated Test (30 MHz-1 GHz)

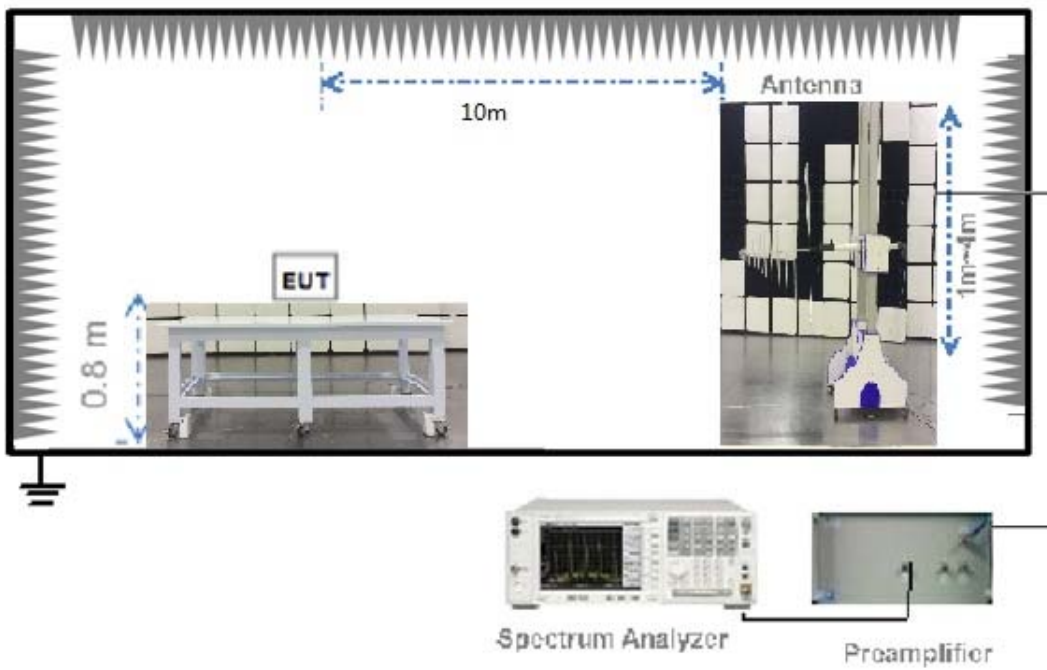

(Diagram 4)

4.4.5 For Radiated Test (Above 1 GHz)

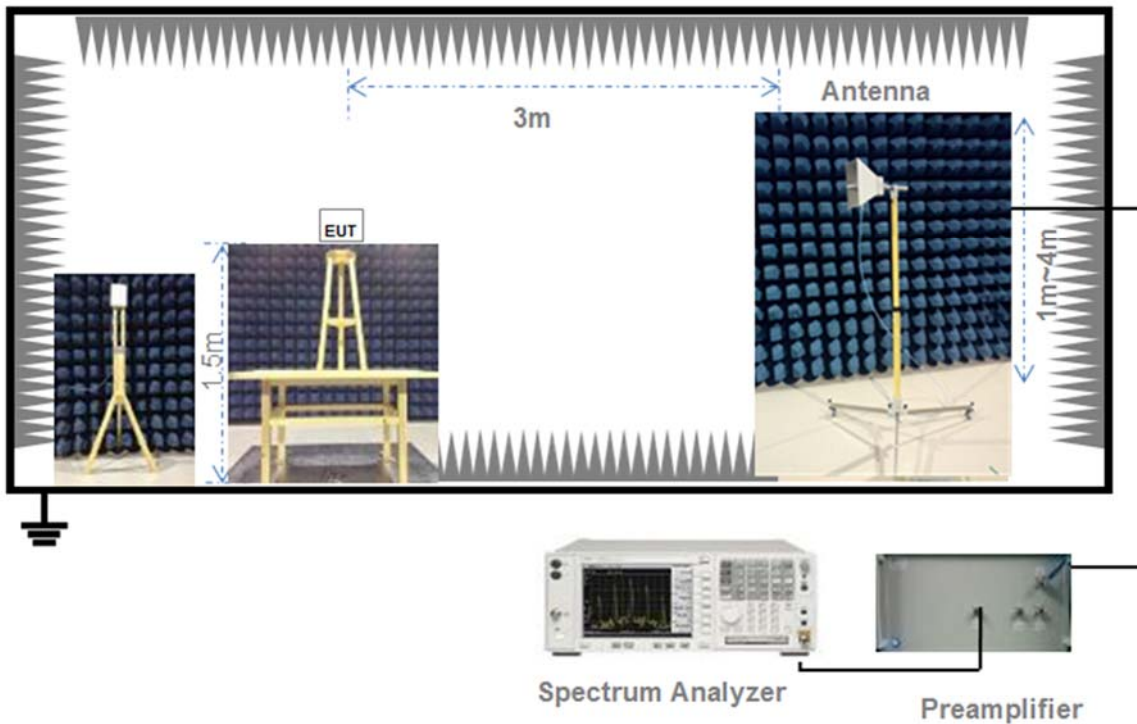

(Diagram 5)

## 4.5 Measurement Results Explanation Example

### 4.5.1 For conducted test items:

The offset level is set in the spectrum analyzer to compensate the RF cable loss and attenuator between EUT conducted output port and spectrum analyzer. With the offset compensation, the spectrum analyzer reading level is exactly the EUT RF output level.

The spectrum analyzer offset is derived from RF cable loss and attenuator factor.

Offset = RF cable loss + attenuator factor.

### 4.5.2 For radiated band edges and spurious emission test:

$$E = \text{EIRP} - 20\log D + 104.8$$

where:

E = electric field strength in dB $\mu$ V/m,

EIRP = equivalent isotropic radiated power in dBm

D = specified measurement distance in meters.

EIRP= Measure Conducted output power Value (dBm) + Maximum transmit antenna gain (dBi) + the appropriate maximum ground reflection factor (dB)



## 5 TEST ITEMS

### 5.1 Antenna Requirements

#### 5.1.1 Relevant Standards

FCC §15.203 & 15.247(b); RSS-247, 5.4 (6)

An intentional radiator shall be designed to ensure that no antenna other than that furnished by the responsible party shall be used with the device. The use of a permanently attached antenna or of an antenna that uses a unique coupling to the intentional radiator shall be considered sufficient to comply with the provisions of this section. The manufacturer may design the unit so that a broken antenna can be replaced by the user, but the use of a standard antenna jack or electrical connector is prohibited. This requirement does not apply to carrier current devices or to devices operated under the provisions of § 15.211, § 15.213, § 15.217, § 15.219, or § 15.221. Further, this requirement does not apply to intentional radiators that must be professionally installed, such as perimeter protection systems and some field disturbance sensors, or to other intentional radiators which, in accordance with § 15.31(d), must be measured at the installation site. However, the installer shall be responsible for ensuring that the proper antenna is employed so that the limits in this part are not exceeded.

If directional gain of transmitting antennas is greater than 6 dBi, the power shall be reduced by the same level in dB comparing to gain minus 6 dBi. For the fixed point-to-point operation, the power shall be reduced by one dB for every 3 dB that the directional gain of the antenna exceeds 6 dBi. The use of a permanently attached antenna or of an antenna that uses a unique coupling to the intentional radiator shall be considered sufficient to comply with the FCC rule.

#### 5.1.2 Antenna Anti-Replacement Construction

The Antenna Anti-Replacement as following method:

Protected Method	Description
The antenna is embedded in the product.	An embedded-in antenna design is used.

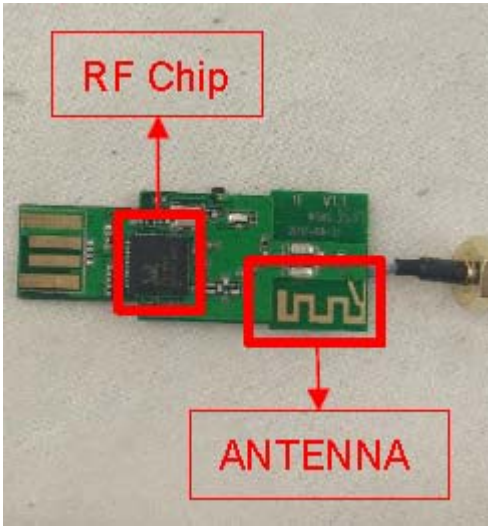
Reference Documents	Item
Photo	

### 5.1.3 Antenna Gain

The antenna peak gain of EUT is less than 6 dBi. Therefore, it is not necessary to reduce maximum peak output power limit.

## 5.2 Output Power

### 5.2.1 Test Limit

FCC § 15.247(b); RSS-247, 5.4 (4)

For systems using digital modulation in the 902-928 MHz, 2400-2483.5 MHz, and 5725-5850 MHz bands: 1 Watt. As an alternative to a peak power measurement, compliance with the one Watt limit can be based on a measurement of the maximum conducted output power. Maximum Conducted Output Power is defined as the total transmit power delivered to all antennas and antenna elements averaged across all symbols in the signaling alphabet when the transmitter is operating at its maximum power control level. Power must be summed across all antennas and antenna elements.

### 5.2.2 Test Setup

See section 4.4.1 for test setup description for the antenna port. The photo of test setup please refer to ANNEX B.

### 5.2.3 Test Procedure

#### Maximum peak conducted output power

The maximum peak conducted output power may be measured using a broadband peak RF power meter. The power meter shall have a video bandwidth that is greater than or equal to the DTS bandwidth and shall utilize a fast-responding diode detector.

#### Maximum conducted (average) output power (Reporting Only)

a) As an alternative to spectrum analyzer or EMI receiver measurements, measurements may be performed using a wideband RF power meter with a thermocouple detector or equivalent if all of the conditions listed below are satisfied.

- 1) The EUT is configured to transmit continuously, or to transmit with a constant duty factor.
  - 2) At all times when the EUT is transmitting, it shall be transmitting at its maximum power control level.
  - 3) The integration period of the power meter exceeds the repetition period of the transmitted signal by at least a factor of five.
- b) If the transmitter does not transmit continuously, measure the duty cycle (x) of the transmitter output signal as described in Section 6.0.
- c) Measure the average power of the transmitter. This measurement is an average over both the on and off periods of the transmitter.
- d) Adjust the measurement in dBm by adding  $10\log(1/x)$ , where x is the duty cycle to the measurement result.

#### Measurements of duty cycle

The zero-span mode on a spectrum analyzer or EMI receiver if the response time and spacing between bins on the sweep are sufficient to permit accurate measurements of the on and off times of the transmitted signal.

Set the center frequency of the instrument to the center frequency of the transmission.

Set  $RBW \geq OBW$  if possible; otherwise, set RBW to the largest available value.

Set  $VBW \geq RBW$ . Set detector = peak or average.

The zero-span measurement method shall not be used unless both RBW and VBW are  $> 50/T$  and the number of sweep points across duration T exceeds 100. (For example, if VBW and/or RBW are limited to 3 MHz, then the zero-span method of measuring duty cycle shall not be used if  $T \leq 16.7$  microseconds.)

#### 5.2.4 Test Result

Please refer to ANNEX A.1.

## 5.3 6dB Bandwidth

### 5.3.1 Limit

FCC §15.247(a); RSS-GEN, 6.6

Make the measurement with the spectrum analyzer's resolution bandwidth (RBW) = 100 kHz. In order to make an accurate measurement, set the span greater than RBW. The 6 dB bandwidth must be greater than 500 kHz.

### 5.3.2 Test Setup

See section 4.4.1 for test setup description for the antenna port. The photo of test setup please refer to ANNEX B.

### 5.3.3 Test Procedure

Use the following spectrum analyzer settings:

Set RBW = 100 kHz.

Set the video bandwidth (VBW)  $\geq$  3 RBW.

Detector = Peak.

Trace mode = max hold.

Sweep = auto couple.

Allow the trace to stabilize.

Measure the maximum width of the emission that is constrained by the frequencies associated with the two outermost amplitude points (upper and lower frequencies) that are attenuated by 6 dB relative to the maximum level measured in the fundamental emission.

### 5.3.4 Test Result

Please refer to ANNEX A.2.

## 5.4 Conducted Spurious Emission

### 5.4.1 Limit

FCC §15.247(d); RSS-247, 5.5

In any 100 kHz bandwidth outside the frequency band in which the spread spectrum or digitally modulated intentional radiator is operating, the radio frequency power that is produced by the intentional radiator shall be at least 20 dB below that in the 100 kHz bandwidth within the band that contains the highest level of the desired power, based on either an RF conducted or a radiated measurement.

### 5.4.2 Test Setup

See section 4.4.1 for test setup description for the antenna port. The photo of test setup please refer to ANNEX B.

### 5.4.3 Test Procedure

The DTS rules specify that in any 100 kHz bandwidth outside of the authorized frequency band, the power shall be attenuated according to the following conditions:

- a) If the maximum peak conducted output power procedure was used to demonstrate compliance as described in 9.1, then the peak output power measured in any 100 kHz bandwidth outside of the authorized frequency band shall be attenuated by at least 20 dB relative to the maximum in-band peak PSD level in 100 kHz (i.e., 20 dBc).
- b) If maximum conducted (average) output power was used to demonstrate compliance as described in 9.2, then the peak power in any 100 kHz bandwidth outside of the authorized frequency band shall be attenuated by at least 30 dB relative to the maximum in-band peak PSD level in 100 kHz (i.e., 30 dBc).
- c) In either case, attenuation to levels below the 15.209 general radiated emissions limits is not required.

The following procedures shall be used to demonstrate compliance to these limits. Note that these procedures can be used in either an antenna-port conducted or radiated test set-up. Radiated tests must conform to the test site requirements and utilize maximization procedures defined herein.

#### Reference level measurement

Establish a reference level by using the following procedure:

Set instrument center frequency to DTS channel center frequency.

Set the span to  $\geq 1.5$  times the DTS bandwidth.

Set the RBW = 100 kHz.

Set the VBW  $\geq 3 \times$  RBW.

Detector = peak.

Sweep time = auto couple.

Trace mode = max hold.

Allow trace to fully stabilize.

Use the peak marker function to determine the maximum PSD level.

### Emission level measurement

Use the following spectrum analyzer settings:

Span = wide enough to capture the peak level of the in-band emission and all spurious emissions (e.g., harmonics) from the lowest frequency generated in the EUT up through the 10th harmonic. Typically, several plots are required to cover this entire span.

Set the RBW = 100 kHz.

Set the VBW  $\geq 3 \times$  RBW.

Detector = peak.

Sweep time = auto couple.

Trace mode = max hold.

Allow trace to fully stabilize.

Use the peak marker function to determine the maximum amplitude level.

Ensure that the amplitude of all unwanted emissions outside of the authorized frequency band (excluding restricted frequency bands) are attenuated by at least the minimum requirements specified in 11.1 a) or 11.1 b). Report the three highest emissions relative to the limit.

#### 5.4.4 Test Result

Please refer to ANNEX A.3.

## 5.5 Band Edge (Authorized-band band-edge)

### 5.5.1 Limit

FCC §15.247(d); RSS-GEN, 8.9, RSS-247, 5.5

In any 100 kHz bandwidth outside the frequency band in which the spread spectrum or digitally modulated intentional radiator is operating, the radio frequency power that is produced by the intentional radiator shall be at least 20 dB below that in the 100 kHz bandwidth within the band that contains the highest level of the desired power, based on either an RF conducted or a radiated measurement.

### 5.5.2 Test Setup

See section 4.4.1 for test setup description for the antenna port. The photo of test setup please refer to ANNEX B.

### 5.5.3 Test Procedure

The following procedures may be used to determine the peak or average field strength or power of an unwanted emission that is within 2 MHz of the authorized band edge. If a peak detector is utilized, use the procedure described in 13.2.1. Use the procedure described in 13.2.2 when using an average detector and the EUT can be configured to transmit continuously (i.e., duty cycle  $\geq 98\%$ ). Use the procedure described in 13.2.3 when using an average detector and the EUT cannot be configured to transmit continuously but the duty cycle is constant (i.e., duty cycle variations are less than  $\pm 2$  percent). Use the procedure described in 13.2.4 when using an average detector for those cases where the EUT cannot be configured to transmit continuously and the duty cycle is not constant (duty cycle variations equal or exceed 2 percent).

When using a peak detector to measure unwanted emissions at or near the band edge (within 2 MHz of the authorized band), the following integration procedure can be used.

Set instrument center frequency to the frequency of the emission to be measured (must be within 2 MHz of the authorized band edge).

Set span to 2 MHz

RBW = 100 kHz.

VBW  $\geq 3 \times$  RBW.

Detector = peak.

Sweep time = auto.

Trace mode = max hold.

Allow sweep to continue until the trace stabilizes (required measurement time may increase for low duty cycle applications)

Compute the power by integrating the spectrum over 1 MHz using the analyzer's band power measurement function with band limits set equal to the emission frequency (femission)  $\pm 0.5$  MHz. If the instrument does not have a band power function, then sum the amplitude levels (in power units) at 100 kHz intervals extending across the 1 MHz spectrum defined by femission  $\pm 0.5$  MHz.

Standard method(The 99% OBW of the fundamental emission is without 2 MHz of the authorized band):

Span: Wide enough to capture the peak level of the emission operating on the channel closest to the band edge, as well as any modulation products that fall outside of the authorized band of operation.



Reference level: As required to keep the signal from exceeding the maximum instrument input mixer level for linear operation. In general, the peak of the spectral envelope shall be more than  $[10 \log (\text{OBW}/\text{RBW})]$  below the reference level. Specific guidance is given in 4.1.5.2.

Attenuation: Auto (at least 10 dB preferred).

Sweep time: Coupled.

Resolution bandwidth: 100 kHz.

Video bandwidth: 300 kHz.

Detector: Peak.

Trace: Max hold.

#### 5.5.4 Test Result

Please refer to ANNEX A.4.

## 5.6 Conducted Emission

### 5.6.1 Limit

FCC §15.207; RSS-GEN, 8.8

For an intentional radiator that is designed to be connected to the public utility (AC) power line, the radio frequency voltage that is conducted back onto the AC power line on any frequency within the band 150 kHz to 30 MHz shall not exceed the limits in the following table, as measured using a 50 $\mu$ H/50 $\Omega$  line impedance stabilization network (LISN).

Frequency range (MHz)	Conducted Limit (dB $\mu$ V)	
	Quai-peak	Average
0.15 - 0.50	66 to 56	56 to 46
0.50 - 5	56	46
0.50 - 30	60	50

### 5.6.2 Test Setup

See section 4.4.2 for test setup description for the AC power supply port. The photo of test setup please refer to ANNEX B.

### 5.6.3 Test Procedure

The maximum conducted interference is searched using Peak (PK), if the emission levels more than the AV and QP limits, and that have narrow margins from the AV and QP limits will be re-measured with AV and QP detectors. Tests for both L phase and N phase lines of the power mains connected to the EUT are performed. Refer to recorded points and plots below.

Devices subject to Part 15 must be tested for all available U.S. voltages and frequencies (such as a nominal 120 VAC, 50/60 Hz and 240 VAC, 50/60 Hz) for which the device is capable of operation. A device rated for 50/60 Hz operation need not be tested at both frequencies provided the radiated and line conducted emissions are the same at both frequencies.

### 5.6.4 Test Result

Please refer to ANNEX A.5.

## 5.7 Radiated Spurious Emission

### 5.7.1 Limit

FCC §15.209&15.247(c); RSS-247, 5.5

Radiated emission outside the frequency band attenuation below the general limits specified in FCC section 15.209(a) is not required. In addition, radiated emissions which fall in the restricted bands, as defined in FCC section 15.205(a), must also comply with the radiated emission limits specified in FCC section 15.209(a).

According to FCC section 15.209 (a), except as provided elsewhere in this subpart, the emissions from an intentional radiator shall not exceed the field strength levels specified in the following table:

Frequency (MHz)	Field Strength ( $\mu\text{V}/\text{m}$ )	Measurement Distance (m)
0.009 - 0.490	2400/F(kHz)	300
0.490 - 1.705	24000/F(kHz)	30
1.705 - 30.0	30	30
30 - 88	100	3
88 - 216	150	3
216 - 960	200	3
Above 960	500	3

Note:

1. For Above 1000 MHz, the emission limit in this paragraph is based on measurement instrumentation employing an average detector, measurement using instrumentation with a peak detector function, corresponding to 20dB above the maximum permitted average limit.
2. For above 1000 MHz, limit field strength of harmonics: 54dBuV/m@3m (AV) and 74dBuV/m@3m (PK).

### 5.7.2 Test Setup

See section 4.4.3 to 4.4.5 for test setup description for the antenna port. The photo of test setup please refer to ANNEX B.

### 5.7.3 Test Procedure

Since the emission limits are specified in terms of radiated field strength levels, measurements performed to demonstrate compliance have traditionally relied on a radiated test configuration. Radiated measurements remain the principal method for demonstrating compliance to the specified limits; however antenna-port conducted measurements are also now acceptable to demonstrate compliance (see below for details). When radiated measurements are utilized, test site requirements and procedures for maximizing and measuring radiated emissions that are described in ANSI C63.10 shall be followed.

Antenna-port conducted measurements may also be used as an alternative to radiated measurements for demonstrating compliance in the restricted frequency bands. If conducted measurements are performed, then proper impedance matching must be ensured and an additional radiated test for cabinet/case spurious emissions is required.

#### General Procedure for conducted measurements in restricted bands

- a) Measure the conducted output power (in dBm) using the detector specified (see guidance regarding measurement procedures for determining quasi-peak, peak, and average conducted output power, respectively).

- b) Add the maximum transmit antenna gain (in dBi) to the measured output power level to determine the EIRP level (see guidance on determining the applicable antenna gain)
- c) Add the appropriate maximum ground reflection factor to the EIRP level (6 dB for frequencies ≤ 30 MHz, 4.7 dB for frequencies between 30 MHz and 1000 MHz, inclusive and 0 dB for frequencies > 1000 MHz).
- d) For devices with multiple antenna-ports, measure the power of each individual chain and sum the EIRP of all chains in linear terms (e.g., Watts, mW).
- e) Convert the resultant EIRP level to an equivalent electric field strength using the following relationship:

$$E = \text{EIRP} - 20\log D + 104.8$$

where:

E = electric field strength in dBμV/m,

EIRP = equivalent isotropic radiated power in dBm

D = specified measurement distance in meters.

- f) Compare the resultant electric field strength level to the applicable limit.
- g) Perform radiated spurious emission test.

Quasi-Peak measurement procedure

The specifications for measurements using the CISPR quasi-peak detector can be found in Publication 16 of the International Special Committee on Radio Frequency Interference (CISPR) of the International Electrotechnical Commission.

As an alternative to CISPR quasi-peak measurement, compliance can be demonstrated to the applicable emission limits using a peak detector.

Peak power measurement procedure

Peak emission levels are measured by setting the instrument as follows:

- a) RBW = as specified in Table 1.
- b) VBW ≥ 3 x RBW.
- c) Detector = Peak.
- d) Sweep time = auto.
- e) Trace mode = max hold.
- f) Allow sweeps to continue until the trace stabilizes. (Note that the required measurement time may be longer for low duty cycle applications).

Table 1—RBW as a function of frequency

Frequency	RBW
9-150 kHz	200-300 Hz
0.15-30 MHz	9-10 kHz
30-1000 MHz	100-120 kHz

> 1000 MHz	1 MHz
------------	-------

If the peak-detected amplitude can be shown to comply with the average limit, then it is not necessary to perform a separate average measurement.

#### Trace averaging across on and off times of the EUT transmissions followed by duty cycle correction

If continuous transmission of the EUT (i.e., duty cycle  $\geq 98$  percent) cannot be achieved and the duty cycle is constant (i.e., duty cycle variations are less than  $\pm 2$  percent), then the following procedure shall be used:

- a) The EUT shall be configured to operate at the maximum achievable duty cycle.
- b) Measure the duty cycle,  $x$ , of the transmitter output signal as described in section 6.0.
- c) RBW = 1 MHz (unless otherwise specified).
- d) VBW  $\geq 3 \times$  RBW.
- e) Detector = RMS, if  $\text{span}/(\# \text{ of points in sweep}) \leq (\text{RBW}/2)$ . Satisfying this condition may require increasing the number of points in the sweep or reducing the span. If this condition cannot be satisfied, then the detector mode shall be set to peak.
- f) Averaging type = power (i.e., RMS).
  - 1) As an alternative, the detector and averaging type may be set for linear voltage averaging.
  - 2) Some instruments require linear display mode in order to use linear voltage averaging. Log or dB averaging shall not be used.
- g) Sweep time = auto.
- h) Perform a trace average of at least 100 traces.
- i) A correction factor shall be added to the measurement results prior to comparing to the emission limit in order to compute the emission level that would have been measured had the test been performed at 100 percent duty cycle. The correction factor is computed as follows:
  - 1) If power averaging (RMS) mode was used in step f), then the applicable correction factor is  $10 \log(1/x)$ , where  $x$  is the duty cycle.
  - 2) If linear voltage averaging mode was used in step f), then the applicable correction factor is  $20 \log(1/x)$ , where  $x$  is the duty cycle.
  - 3) If a specific emission is demonstrated to be continuous ( $\geq 98$  percent duty cycle) rather than turning on and off with the transmit cycle, then no duty cycle correction is required for that emission.

NOTE: Reduction of the measured emission amplitude levels to account for operational duty factor is not permitted. Compliance is based on emission levels occurring during transmission - not on an average across on and off times of the transmitter.

#### Determining the applicable transmit antenna gain

A conducted power measurement will determine the maximum output power associated with a restricted band emission; however, in order to determine the associated EIRP level, the gain of the transmitting antenna (in dBi) must be added to the measured output power (in dBm).

Since the out-of-band characteristics of the EUT transmit antenna will often be unknown, the use of a conservative antenna gain value is necessary. Thus, when determining the EIRP based on the measured conducted power, the upper bound on antenna gain for a device with a single RF output shall be selected as the maximum in-band gain of the antenna across all operating bands, or 2 dBi, whichever is greater. However, for devices that operate in multiple frequency bands while using the same transmit antenna, the highest gain of the antenna within the operating band nearest in frequency to the restricted band emission being measured may be used in lieu of the overall highest gain when the emission is at a frequency that is within 20 percent of the nearest band edge frequency, but in no case shall a value less than 2 dBi be used.

See KDB 662911 for guidance on calculating the additional array gain term when determining the effective antenna gain for a EUT with multiple outputs occupying the same or overlapping frequency ranges in the same band.

#### Radiated spurious emission test

An additional consideration when performing conducted measurements of restricted band emissions is that unwanted emissions radiating from the EUT cabinet, control circuits, power leads, or intermediate circuit elements will likely go undetected in a conducted measurement configuration. To address this concern, a radiated test shall be performed to ensure that emissions emanating from the EUT cabinet (rather than the antenna port) also comply with the applicable limits.

For these cabinet radiated spurious emission measurements the EUT transmit antenna may be replaced with a termination matching the nominal impedance of the antenna. Procedures for performing radiated measurements are specified in ANSI C63.10. All detected emissions shall comply with the applicable limits.

The measurement frequency range is from 30 MHz to the 10th harmonic of the fundamental frequency. The Turn Table is actuated to turn from 0° to 360°, and both horizontal and vertical polarizations of the Test Antenna are used to find the maximum radiated power. Mid channels on all channel bandwidth verified. Only the worst RB size/offset presented.

The power of the EUT transmitting frequency should be ignored.

All Spurious Emission tests were performed in X, Y, Z axis direction. And only the worst axis test condition was recorded in this test report.

Use the following spectrum analyzer settings:

Span = wide enough to fully capture the emission being measured

RBW = 1 MHz for  $f \geq 1$  GHz, 100 kHz for  $f < 1$  GHz

VBW  $\geq$  RBW

Sweep = auto

Detector function = peak

Trace = max hold

#### 5.7.4 Test Result

Please refer to ANNEX A.6.

## 5.8 Band Edge (Restricted-band band-edge)

### 5.8.1 Limit

FCC §15.209&15.247(c); RSS-247, 5.5

Radiated emission outside the frequency band attenuation below the general limits specified in FCC section 15.209(a) is not required. In addition, radiated emissions which fall in the restricted bands, as defined in FCC section 15.205(a), must also comply with the radiated emission limits specified in FCC section 15.209(a).

### 5.8.2 Test Setup

See section 4.4.1 for test setup description for the antenna port. The photo of test setup please refer to ANNEX B.

### 5.8.3 Test Procedure

The measurement frequency range is from 9 kHz to the 10th harmonic of the fundamental frequency. The Turn Table is actuated to turn from 0° to 360°, and both horizontal and vertical polarizations of the Test Antenna are used to find the maximum radiated power. Mid channels on all channel bandwidth verified. Only the worst RB size/offset presented.

The power of the EUT transmitting frequency should be ignored.

All Spurious Emission tests were performed in X, Y, Z axis direction. And only the worst axis test condition was recorded in this test report.

Use the following spectrum analyzer settings:

Span = wide enough to fully capture the emission being measured

RBW = 1 MHz for  $f \geq 1$  GHz, 100 kHz for  $f < 1$  GHz

VBW  $\geq$  RBW

Sweep = auto

Detector function = peak

Trace = max hold

For measurement below 1GHz, If the emission level of the EUT measured by the peak detector is 3 dB lower than the applicable limit, the peak emission level will be reported, Otherwise, the emission measurement will be repeated using the quasi-peak detector and reported.

For transmitters operating above 1 GHz repeat the measurement with an average detector.

### 5.8.4 Test Result

Please refer to ANNEX A.7.

## 5.9 Power Spectral density (PSD)

### 5.9.1 Limit

FCC §15.247(d); RSS-247, 5.2 (2)

The same method of determining the conducted output power shall be used to determine the power spectral density. If a peak output power is measured, then a peak power spectral density measurement is required. If an average output power is measured, then an average power spectral density measurement should be used.

### 5.9.2 Test Setup

See section 4.4.1 for test setup description for the antenna port. The photo of test setup please refer to ANNEX B.

### 5.9.3 Test Procedure

Set analyzer center frequency to DTS channel center frequency.

Set the span to 1.5 times the DTS bandwidth.

Set the RBW to:  $3 \text{ kHz} \leq \text{RBW} \leq 100 \text{ kHz}$ .

Set the VBW  $\geq 3 \text{ RBW}$ .

Detector = peak.

Sweep time = auto couple.

Trace mode = max hold.

Allow trace to fully stabilize.

Use the peak marker function to determine the maximum amplitude level within the RBW.

If measured value exceeds limit, reduce RBW (no less than 3 kHz) and repeat.

### 5.9.4 Test Result

Please refer to ANNEX A.8.



## ANNEX A TEST RESULT

### A.1 Output Power

#### Duty Cycle

Test Mode	Duty Cycle	T (ms)	1/T(kHz)
802.11b	0.976	8.16670	0.1
802.11g	0.906	1.35257	0.7
802.11n-20 MHz	0.934	1.26283	0.8
802.11n-40 MHz	0.729	0.63095	1.6

#### Peak Power Test Data

##### 802.11b Mode:

Channel	Measured Output Peak Power		Limit		Verdict
	dBm	mW	dBm	mW	
Low	18.61	72.61	30	1000	Pass
Middle	18.78	75.51			Pass
High	17.01	50.23			Pass

##### 802.11g Mode:

Channel	Measured Output Peak Power		Limit		Verdict
	dBm	mW	dBm	mW	
Low	22.20	165.96	30	1000	Pass
Middle	24.57	286.42			Pass
High	20.36	108.64			Pass

##### 802.11n-20 MHz Mode:

Channel	Measured Output Peak Power		Limit		Verdict
	dBm	mW	dBm	mW	
Low	22.30	169.82	30	1000	Pass
Middle	24.97	314.05			Pass
High	20.77	119.40			Pass

##### 802.11n-40 MHz Mode:

Channel	Measured Output Peak Power		Limit		Verdict
	dBm	mW	dBm	mW	
Low	22.53	179.06	30	1000	Pass
Middle	24.23	264.85			Pass
High	22.44	175.39			Pass

**E.I.R.P Test Data (For ISED)**
**802.11b Mode:**

Channel	E.I.R.P		Limit		Verdict
	dBm	mW	dBm	W	
Low	15.90	38.90	36	4	Pass
Middle	16.07	40.46			Pass
High	14.30	26.92			Pass

**802.11g Mode:**

Channel	E.I.R.P		Limit		Verdict
	dBm	mW	dBm	W	
Low	19.49	88.92	36	4	Pass
Middle	21.86	153.46			Pass
High	17.65	58.21			Pass

**802.11n-20 MHz Mode:**

Channel	E.I.R.P		Limit		Verdict
	dBm	mW	dBm	W	
Low	19.59	90.99	36	4	Pass
Middle	22.26	168.27			Pass
High	18.06	63.97			Pass

**802.11n-40 MHz Mode:**

Channel	E.I.R.P		Limit		Verdict
	dBm	mW	dBm	W	
Low	19.82	95.94	36	4	Pass
Middle	21.52	141.91			Pass
High	19.73	93.97			Pass

## A.2 Bandwidth

### Test Data

#### 802.11b Mode:

Channel	6 dB Bandwidth (MHz)	99% Bandwidth (MHz)	6 dB Bandwidth Limits (kHz)
Low	10.162600	15.282200	≥500
Middle	10.162600	15.340087	≥500
High	9.662109	15.455861	≥500

#### 802.11g Mode:

Channel	6 dB Bandwidth (MHz)	99% Bandwidth (MHz)	6 dB Bandwidth Limits (kHz)
Low	16.47070	17.887120	≥500
Middle	16.67090	18.002894	≥500
High	16.52075	18.002894	≥500

#### 802.11n-20MHz Mode:

Channel	6 dB Bandwidth (MHz)	99% Bandwidth (MHz)	6 dB Bandwidth Limits (kHz)
Low	17.77197	18.697540	≥500
Middle	17.67188	18.813314	≥500
High	17.82227	18.697540	≥500

#### 802.11n-40MHz Mode:

Channel	6 dB Bandwidth (MHz)	99% Bandwidth (MHz)	6 dB Bandwidth Limits (kHz)
Low	35.77246	36.4	≥500
Middle	35.47217	36.3	≥500
High	35.82227	36.3	≥500

Test plots

6 dB Bandwidth

802.11b LOW CHANNEL

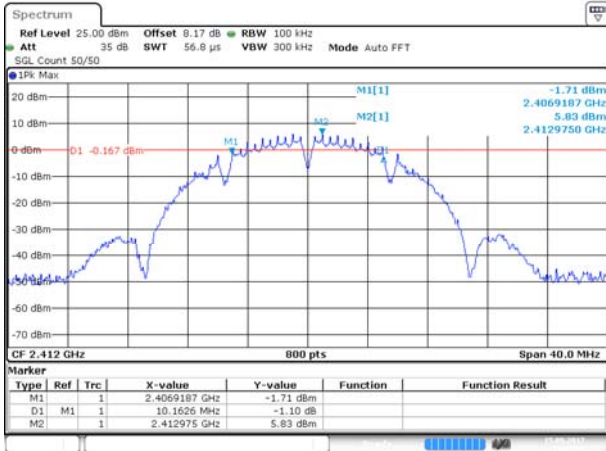

Date: 15 SEP 2017 10:47:37

802.11b MIDDLE CHANNEL

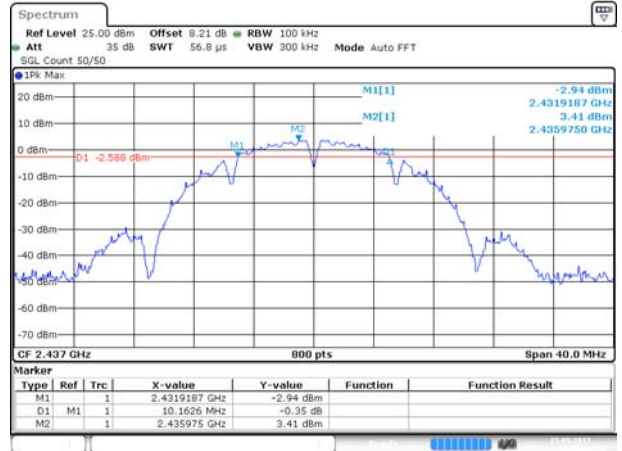

Date: 15 SEP 2017 10:50:46

802.11b HIGH CHANNEL

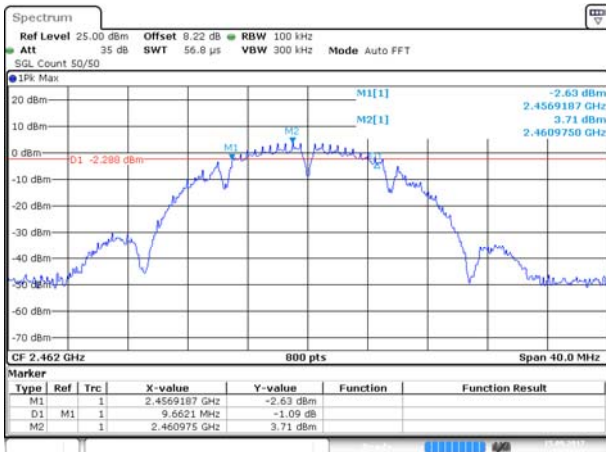

Date: 15 SEP 2017 10:54:30

802.11g LOW CHANNEL

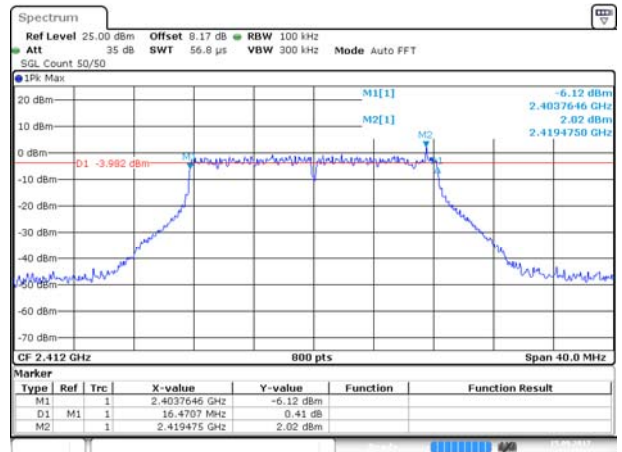

Date: 15 SEP 2017 11:17:10

802.11g MIDDLE CHANNEL

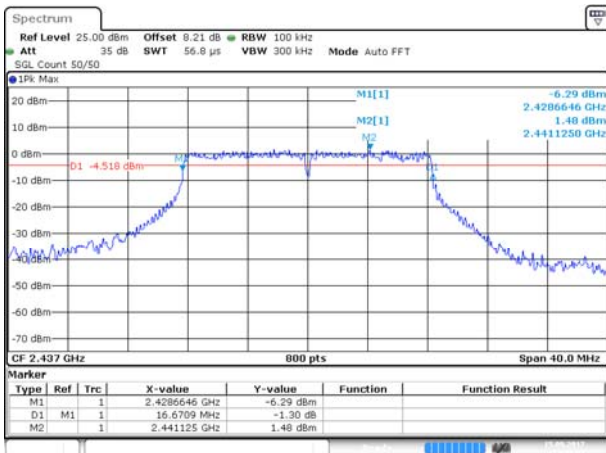

Date: 15 SEP 2017 13:49:36

802.11g HIGH CHANNEL

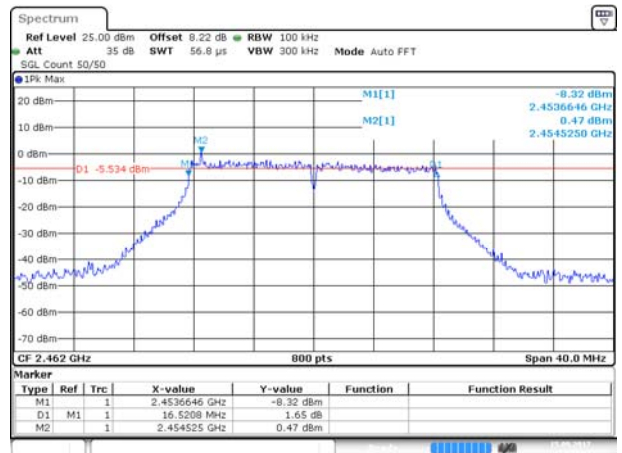

Date: 15 SEP 2017 13:52:11

## 802.11n-20 MHz LOW CHANNEL

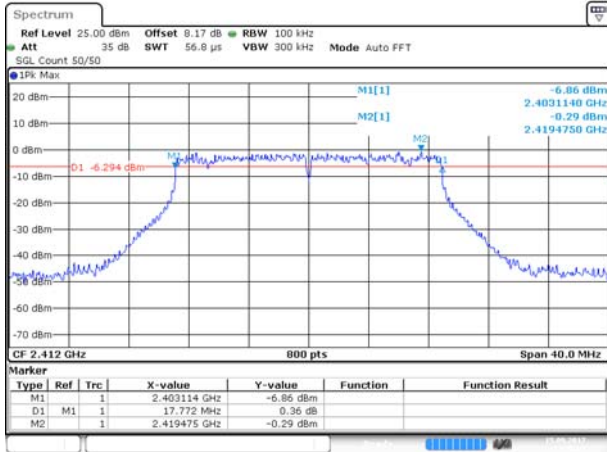

Date: 15 SEP 2017 13:55:02

## 802.11 n-20 MHz MIDDLE CHANNEL

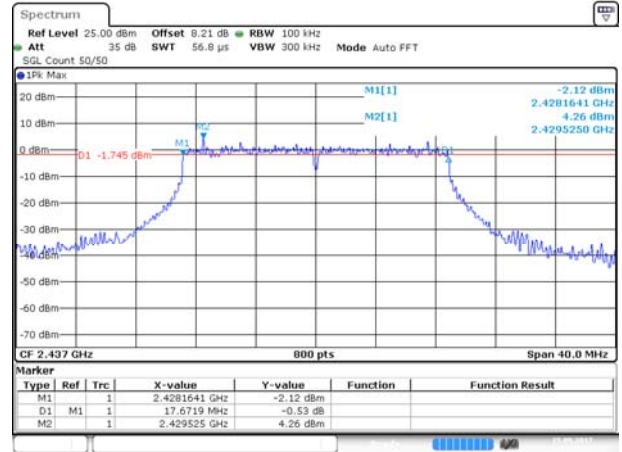

Date: 15 SEP 2017 13:57:53

## 802.11n-20 MHz HIGH CHANNEL

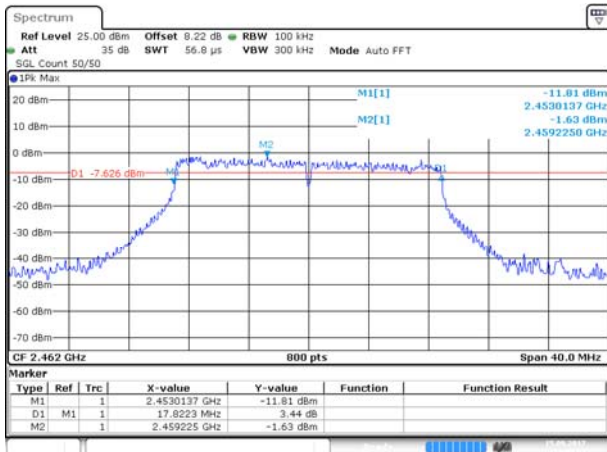

Date: 15 SEP 2017 14:00:58

## 802.11n-40 MHz LOW CHANNEL

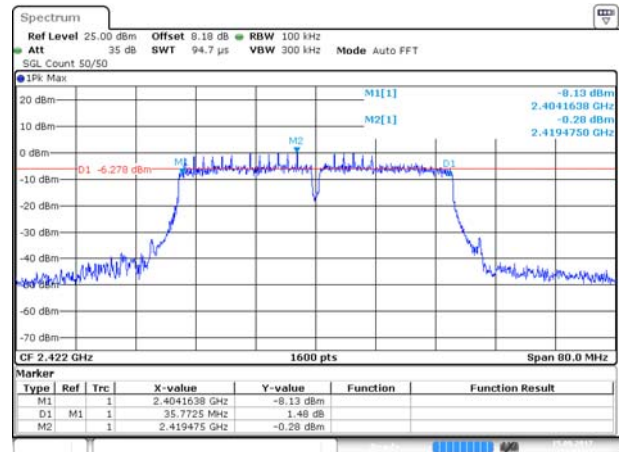

Date: 15 SEP 2017 14:03:20

## 802.11n-40 MHz MIDDLE CHANNEL

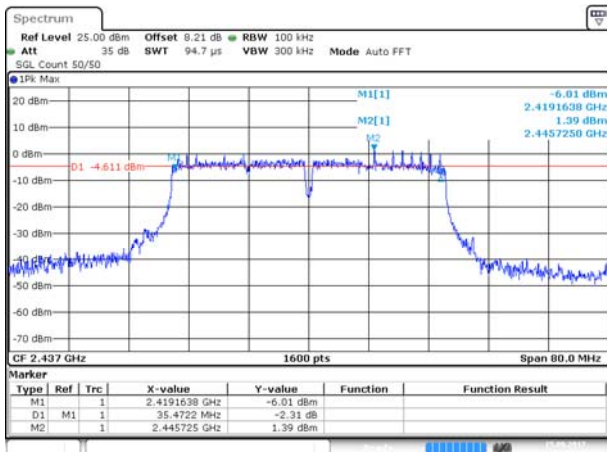

Date: 15 SEP 2017 14:05:47

## 802.11n-40 MHz HIGH CHANNEL

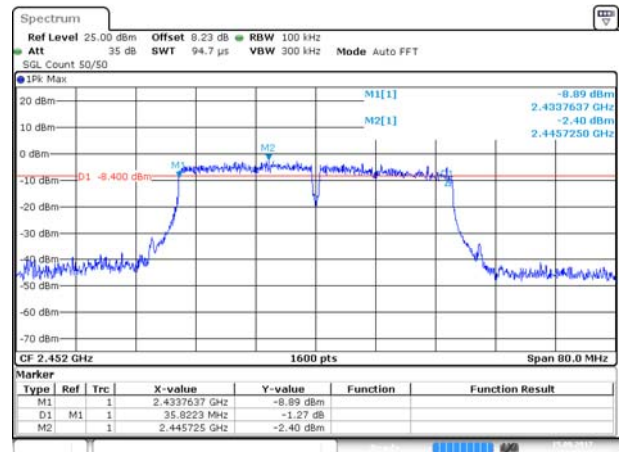

Date: 15 SEP 2017 14:08:42

99% Bandwidth

802.11b LOW CHANNEL

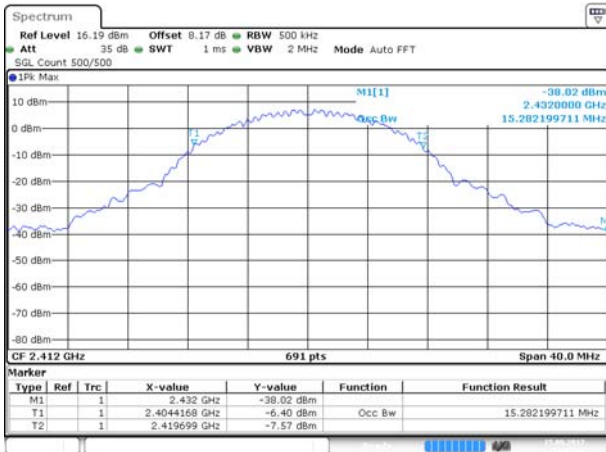

Date: 15 SEP 2017 10:47:45

802.11b MIDDLE CHANNEL

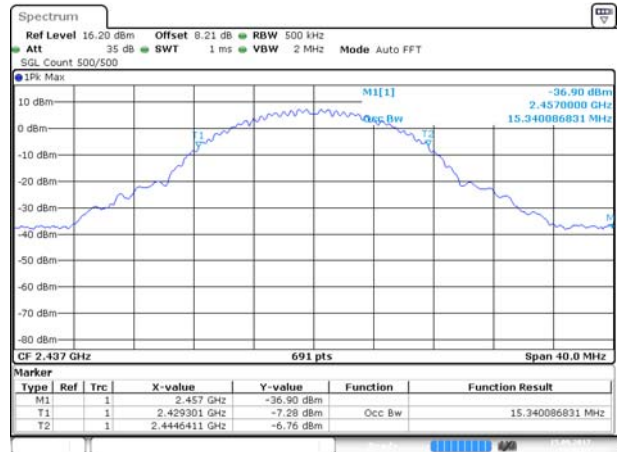

Date: 15 SEP 2017 10:50:55

802.11b HIGH CHANNEL

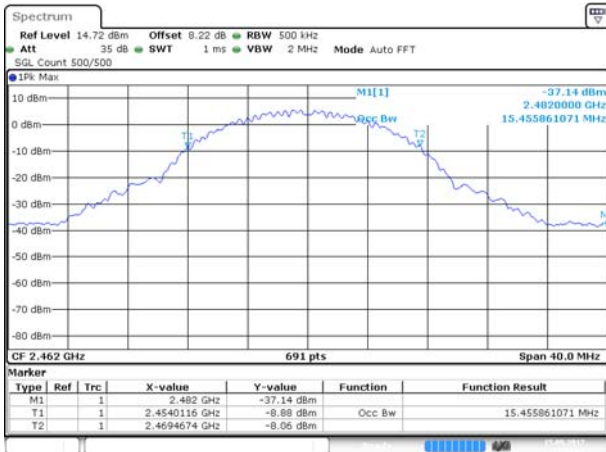

Date: 15 SEP 2017 10:54:39

802.11g LOW CHANNEL



Date: 15 SEP 2017 11:17:18

802.11g MIDDLE CHANNEL



Date: 15 SEP 2017 13:49:45

802.11g HIGH CHANNEL

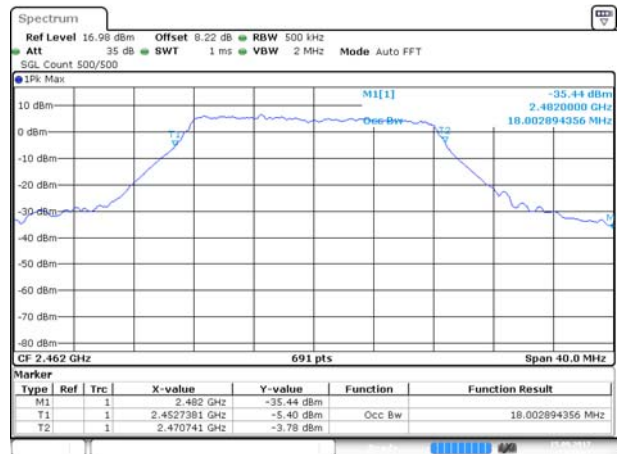

Date: 15 SEP 2017 13:52:19

802.11n-20 MHz LOW CHANNEL



Date: 15 SEP 2017 13:55:11

802.11 n-20 MHz MIDDLE CHANNEL

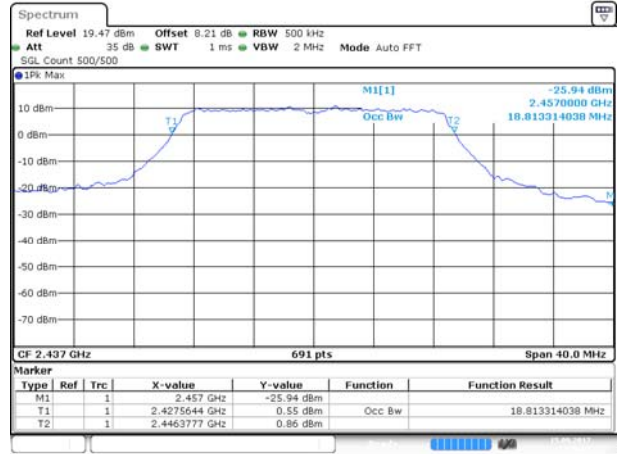

Date: 15 SEP 2017 13:58:01

802.11n-20 MHz HIGH CHANNEL

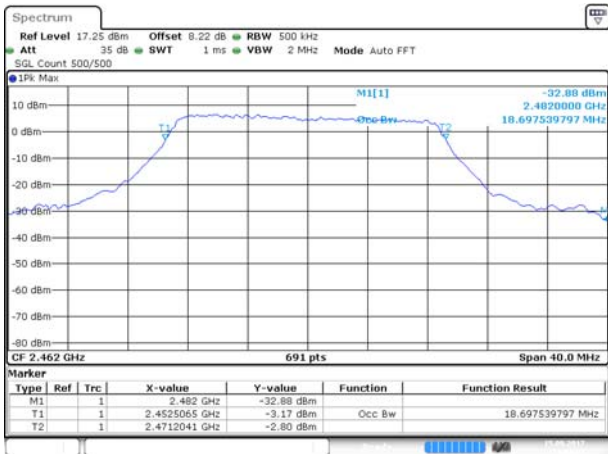

Date: 15 SEP 2017 14:01:07

802.11n-40 MHz LOW CHANNEL

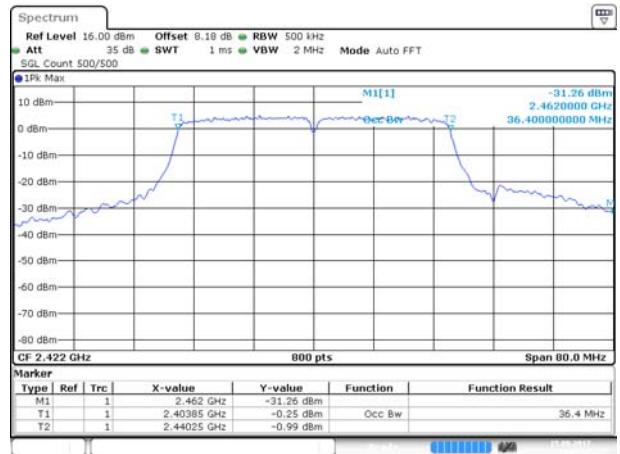

Date: 15 SEP 2017 14:03:31

802.11n-40 MHz MIDDLE CHANNEL

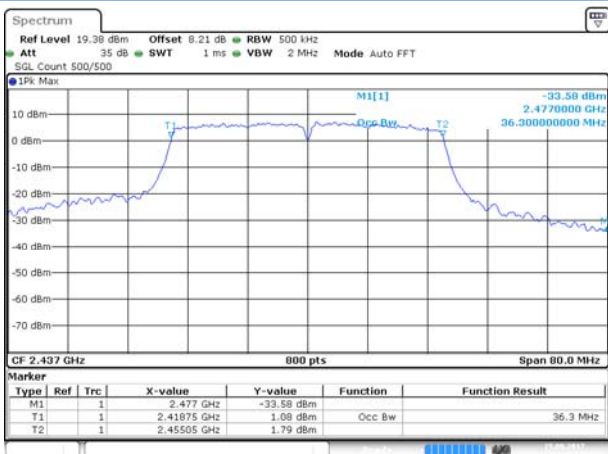

Date: 15 SEP 2017 14:05:56

802.11n-40 MHz HIGH CHANNEL

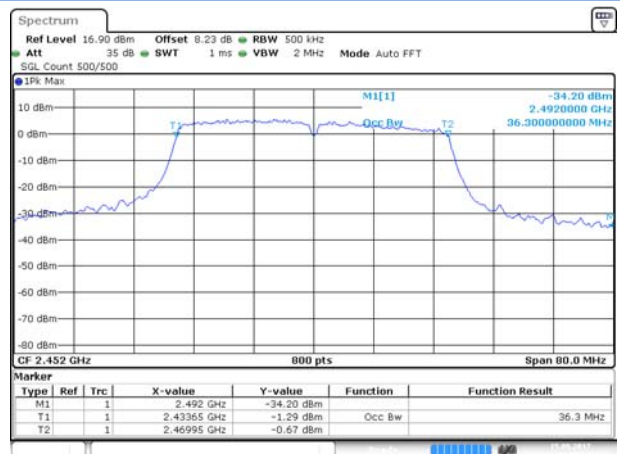

Date: 15 SEP 2017 14:08:52

### A.3 Conducted Spurious Emissions

#### Test Data

##### 802.11b Mode:

Channel	Measured Max. Out of Band Emission (dBm)	Limit (dBm)		Verdict
		Carrier Level	Calculated 20 dBc Limit	
Low	-28.70	6.06	-13.940	Pass
Middle	-29.45	6.55	-13.450	Pass
High	-28.88	4.70	-15.300	Pass

##### 802.11g Mode:

Channel	Measured Max. Out of Band Emission (dBm)	Limit (dBm)		Verdict
		Carrier Level	Calculated 20 dBc Limit	
Low	-29.32	2.45	-17.550	Pass
Middle	-29.28	4.59	-15.410	Pass
High	-29.81	1.23	-18.770	Pass

##### 802.11n-20MHz Mode:

Channel	Measured Max. Out of Band Emission (dBm)	Limit (dBm)		Verdict
		Carrier Level	Calculated 20 dBc Limit	
Low	-29.11	2.49	-17.510	Pass
Middle	-28.85	5.69	-14.310	Pass
High	-29.44	1.80	-18.200	Pass

##### 802.11n-40MHz Mode:

Channel	Measured Max. Out of Band Emission (dBm)	Limit (dBm)		Verdict
		Carrier Level	Calculated 20 dBc Limit	
Low	-28.91	-0.20	-20.200	Pass
Middle	-29.30	1.89	-18.110	Pass
High	-29.08	0.30	-19.700	Pass



Test Plots

802.11b LOW CHANNEL CARRIER LEVEL

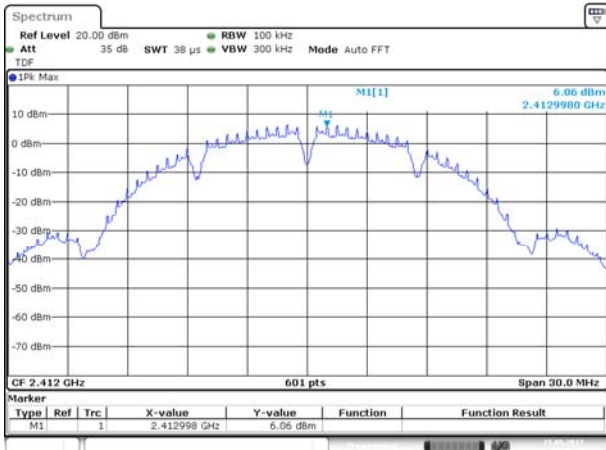

Date: 15 SEP. 2017 10:48:02

802.11b LOW CHANNEL, SPURIOUS 30 MHz ~ 3 GHz

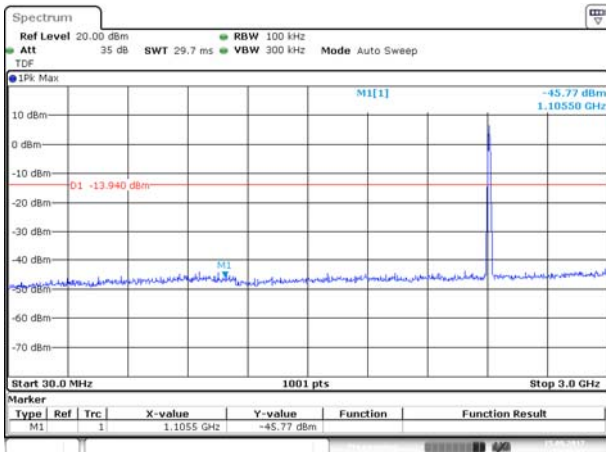

Date: 15 SEP. 2017 10:48:30

802.11b LOW CHANNEL, SPURIOUS 2 GHz ~ 25 GHz

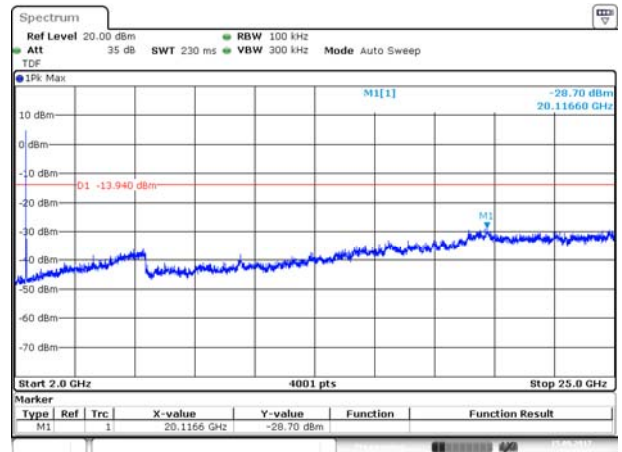

Date: 15 SEP. 2017 10:48:49

802.11b MIDDLE CHANNEL CARRIER LEVEL

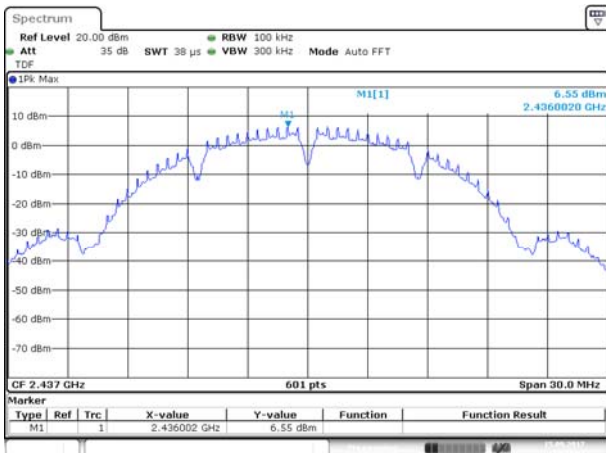

Date: 15 SEP. 2017 10:52:11

802.11b MIDDLE CHANNEL, SPURIOUS  
30 MHz ~ 3 GHz

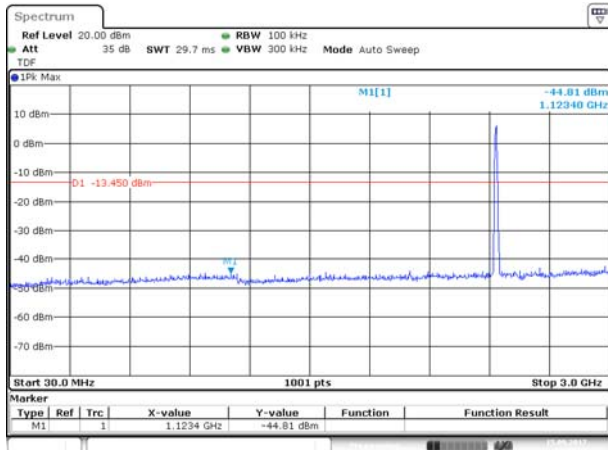

Date: 15.SEP.2017 10:52:51

802.11b MIDDLE CHANNEL, SPURIOUS  
2 GHz ~ 25 GHz

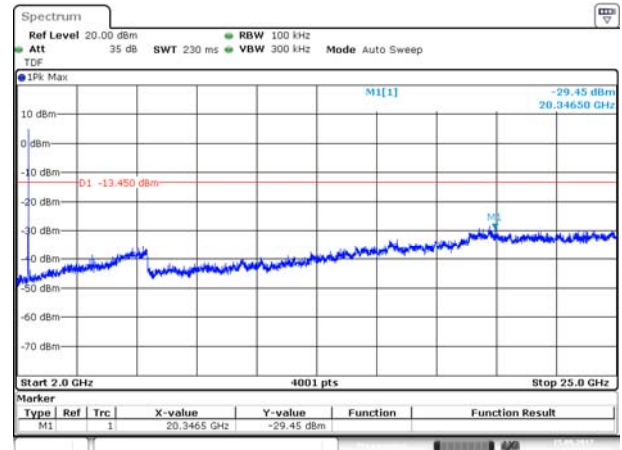

Date: 15.SEP.2017 10:53:11

802.11b HIGH CHANNEL CARRIER LEVEL

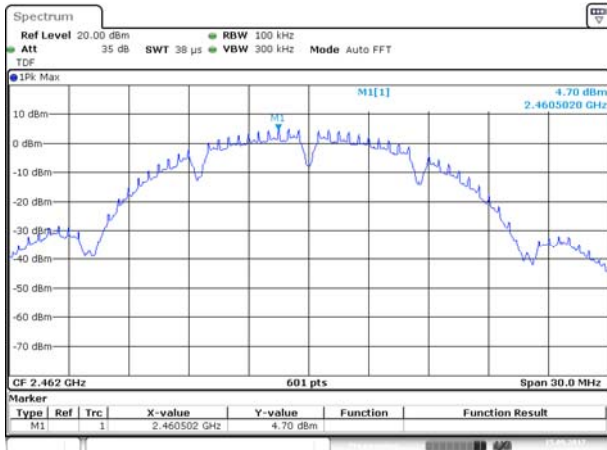

Date: 15.SEP.2017 10:55:22

802.11b HIGH CHANNEL, SPURIOUS  
30 MHz ~ 3 GHz

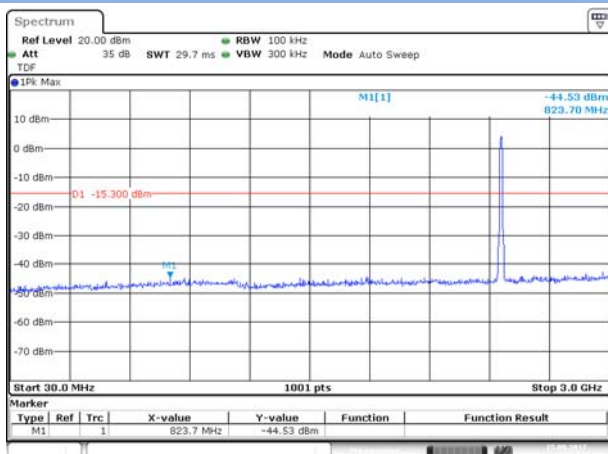

Date: 15.SEP.2017 10:56:39

802.11b HIGH CHANNEL, SPURIOUS  
2 GHz ~ 25 GHz

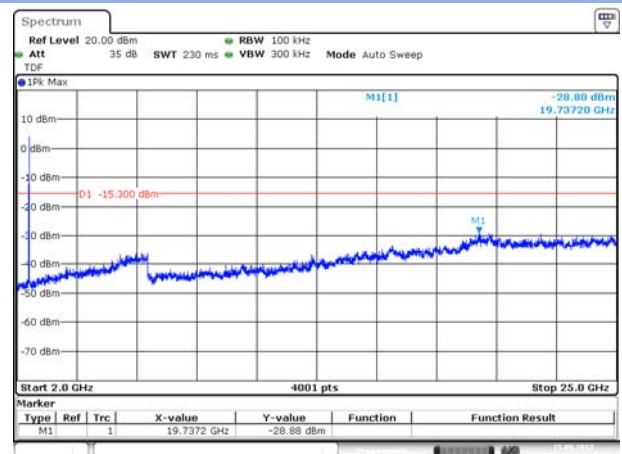

Date: 15.SEP.2017 10:56:53

### 802.11g LOW CHANNEL CARRIER LEVEL

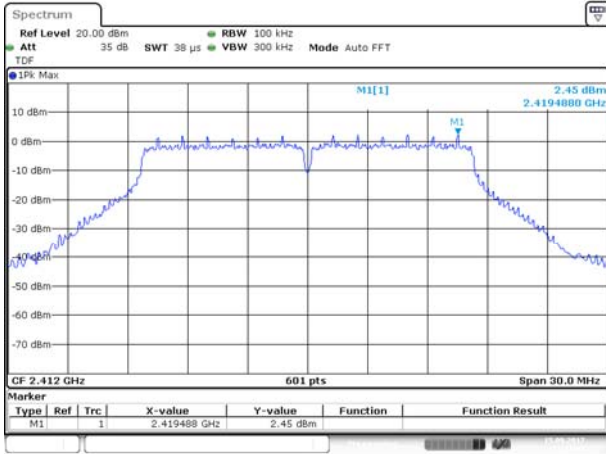

Date: 15.SEP.2017 11:17:44

### 802.11g LOW CHANNEL, SPURIOUS 30 MHz ~ 3 GHz

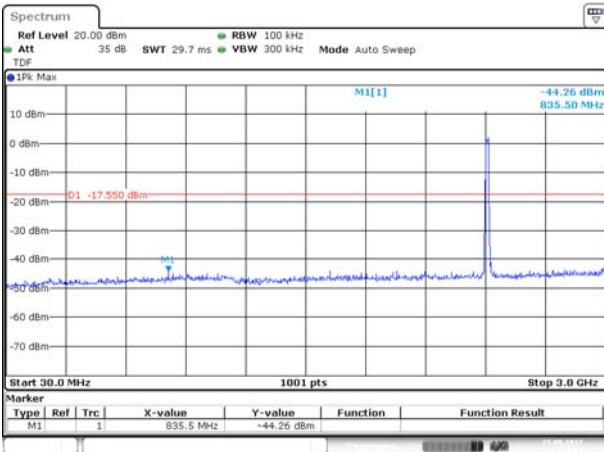

Date: 15.SEP.2017 11:18:17

### 802.11g LOW CHANNEL, SPURIOUS 2 GHz ~ 25 GHz

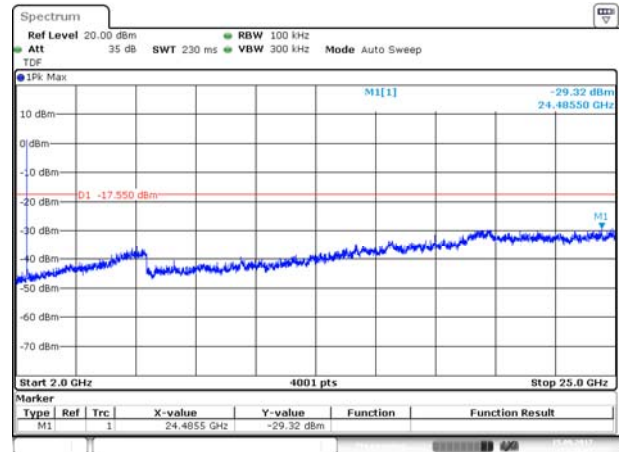

Date: 15.SEP.2017 11:18:41

### 802.11g MIDDLE CHANNEL CARRIER LEVEL

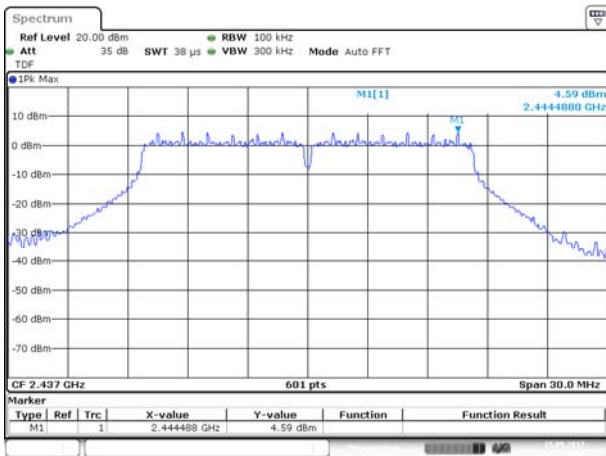

Date: 15.SEP.2017 13:50:07

802.11g MIDDLE CHANNEL, SPURIOUS  
30 MHz ~ 3 GHz

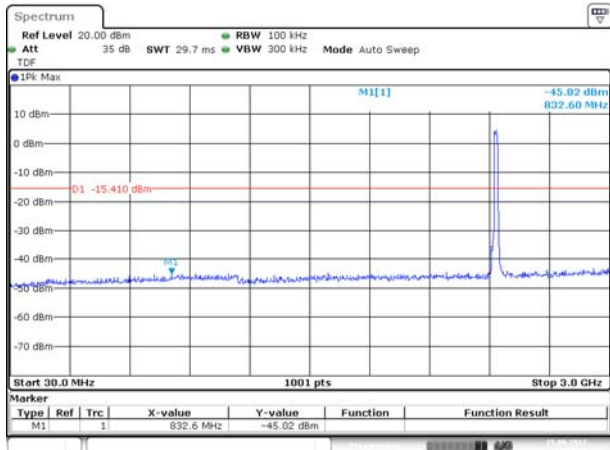

Date: 15 SEP 2017 13:50:50

802.11g MIDDLE CHANNEL, SPURIOUS  
2 GHz ~ 25 GHz

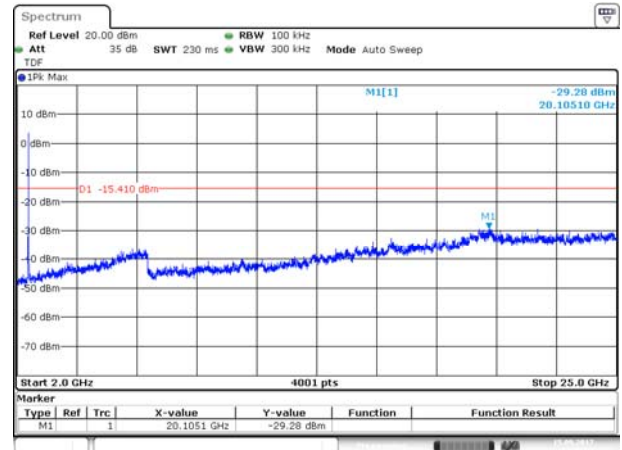

Date: 15 SEP 2017 13:50:59

802.11g HIGH CHANNEL CARRIER LEVEL

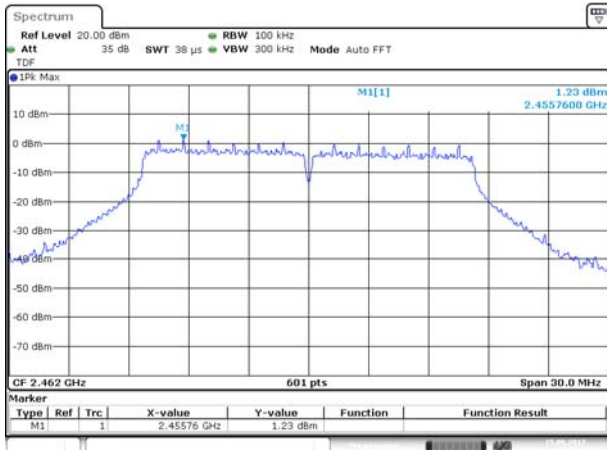

Date: 15 SEP 2017 13:52:44

802.11g HIGH CHANNEL, SPURIOUS  
30 MHz ~ 3 GHz

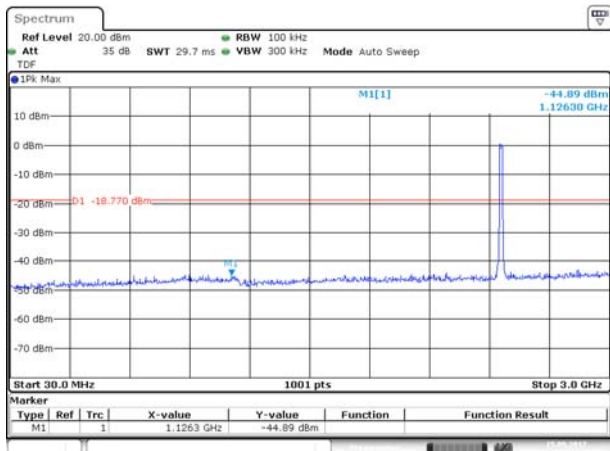

Date: 15 SEP 2017 13:53:18

802.11g HIGH CHANNEL, SPURIOUS  
2 GHz ~ 25 GHz

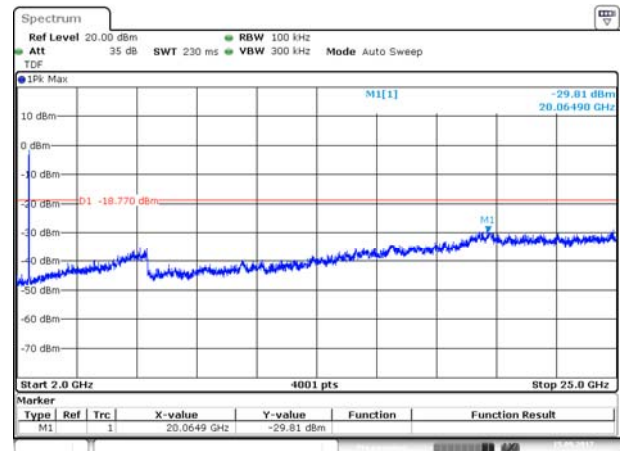

Date: 15 SEP 2017 13:53:31

802.11n-20 MHz LOW CHANNEL CARRIER LEVEL

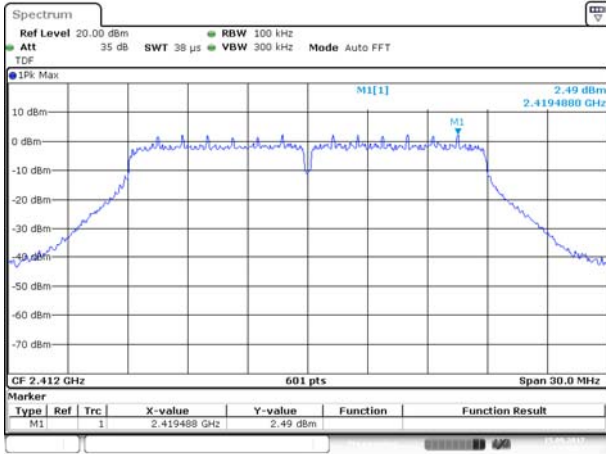

Date: 15.SEP.2017 13:55:23

802.11n-20 MHz LOW CHANNEL, SPURIOUS  
30 MHz ~ 3 GHz

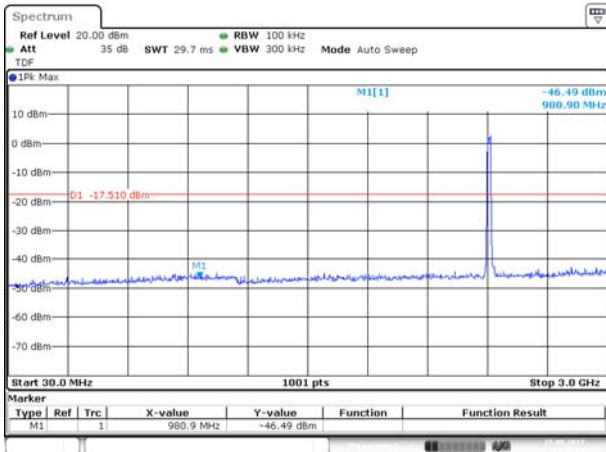

Date: 15.SEP.2017 13:55:58

802.11n-20 MHz LOW CHANNEL, SPURIOUS  
2 GHz ~ 25 GHz

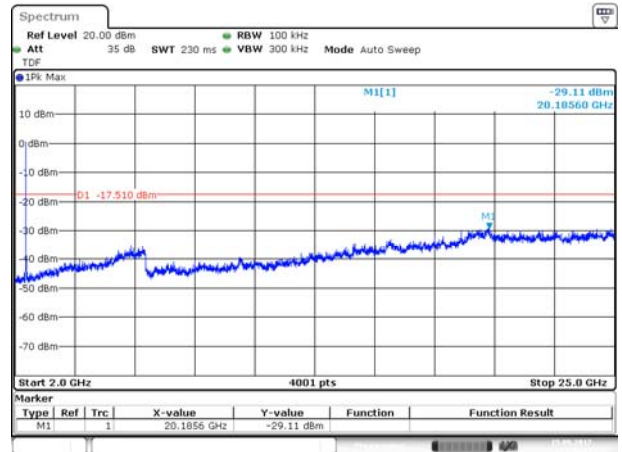

Date: 15.SEP.2017 13:56:16

802.11n-20 MHz MIDDLE CHANNEL CARRIER LEVEL

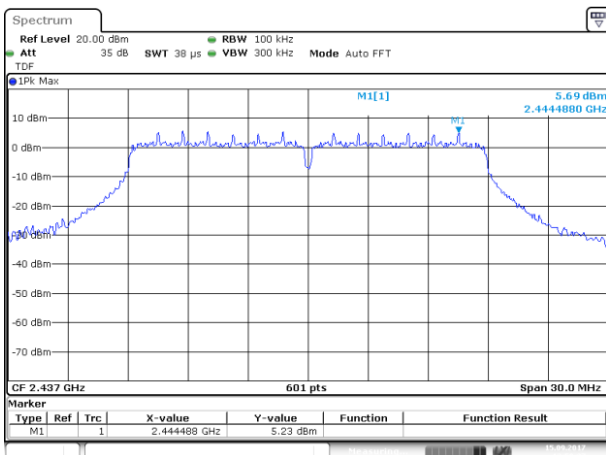

Date: 15.SEP.2017 13:58:38

802.11n-20 MHz MIDDLE CHANNEL, SPURIOUS  
30 MHz ~ 3 GHz

802.11n-20 MHz MIDDLE CHANNEL, SPURIOUS  
2 GHz ~ 25 GHz

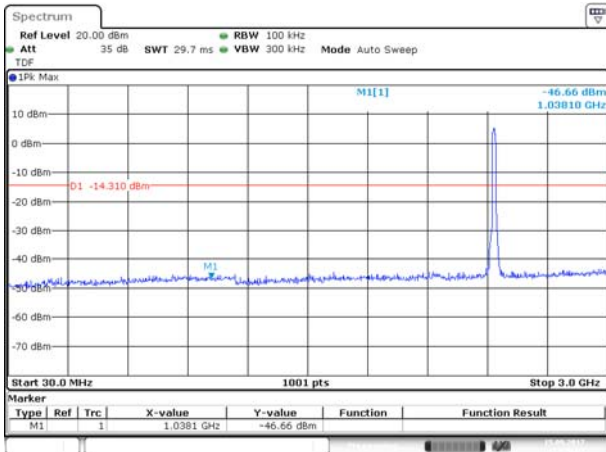

Date: 15 SEP 2017 13:59:05

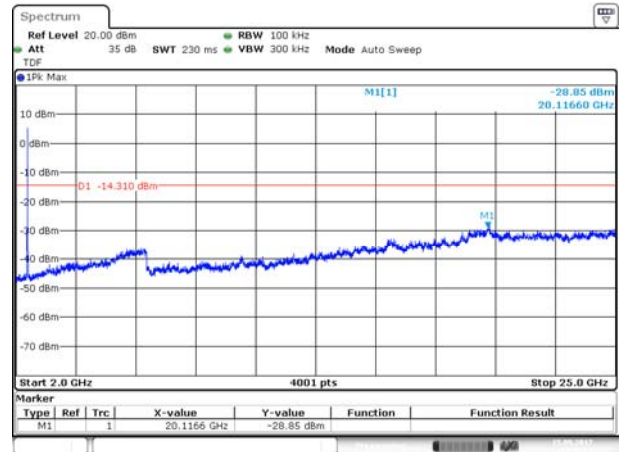

Date: 15 SEP 2017 13:59:52

802.11n-20 MHz HIGH CHANNEL CARRIER LEVEL

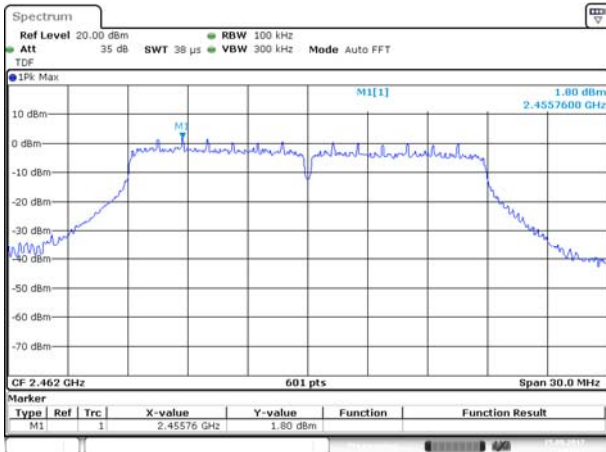

Date: 15 SEP 2017 14:01:23

802.11n-20 MHz HIGH CHANNEL, SPURIOUS  
30 MHz ~ 3 GHz

802.11n-20 MHz HIGH CHANNEL, SPURIOUS  
2 GHz ~ 25 GHz

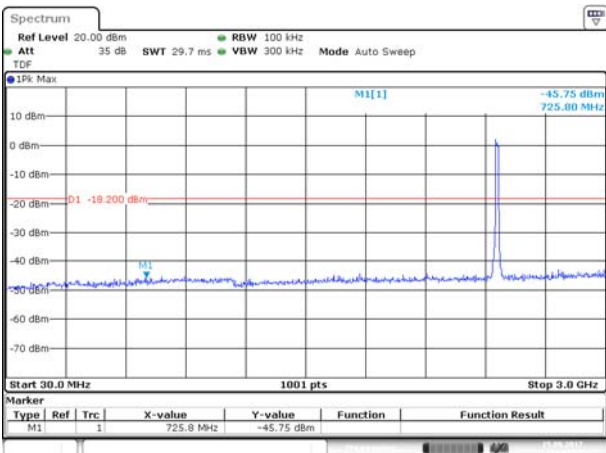

Date: 15 SEP 2017 14:01:51

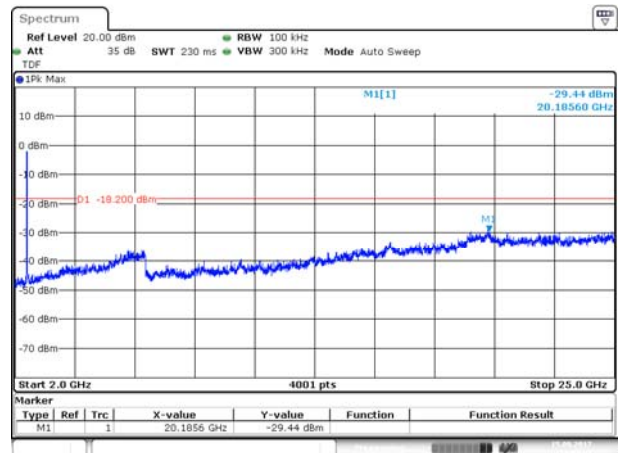

Date: 15 SEP 2017 14:02:02

802.11n-40 MHz LOW CHANNEL CARRIER LEVEL

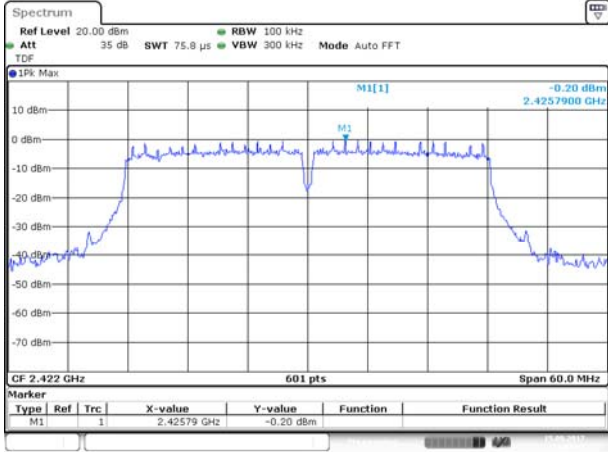

Date: 15.SEP.2017 14:03:42

802.11n-40 MHz LOW CHANNEL, SPURIOUS 30 MHz ~ 3 GHz

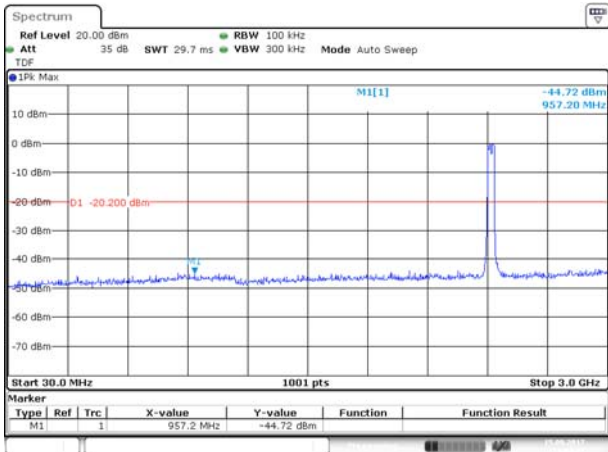

Date: 15.SEP.2017 14:04:17

802.11n-40 MHz LOW CHANNEL, SPURIOUS 2 GHz ~ 25 GHz

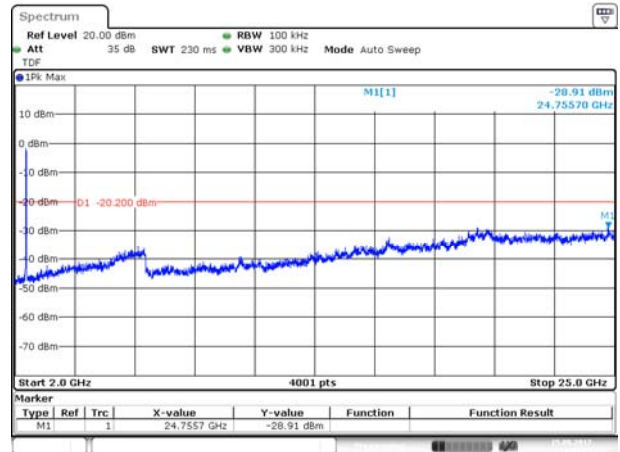

Date: 15.SEP.2017 14:04:31

802.11n-40 MHz MIDDLE CHANNEL CARRIER LEVEL

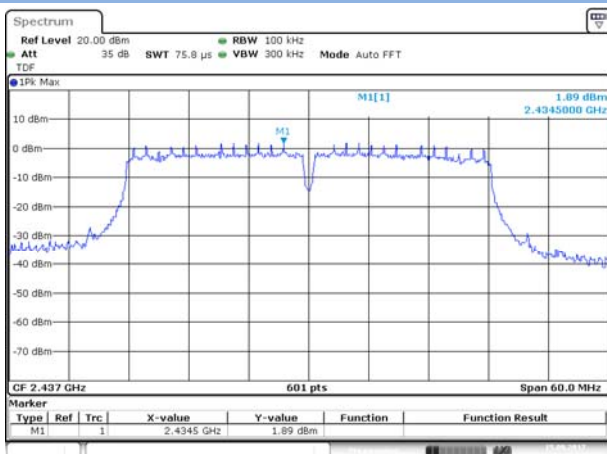

Date: 15.SEP.2017 14:06:34

802.11n-40 MHz MIDDLE CHANNEL, SPURIOUS  
30 MHz ~ 3 GHz

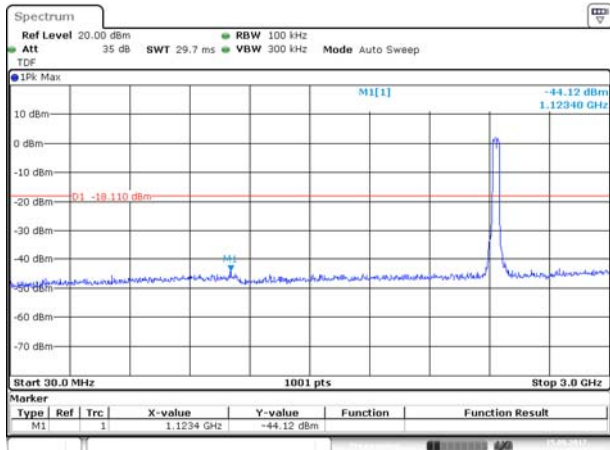

Date: 15.SEP.2017 14:07:04

802.11n-40 MHz MIDDLE CHANNEL, SPURIOUS  
2 GHz ~ 25 GHz

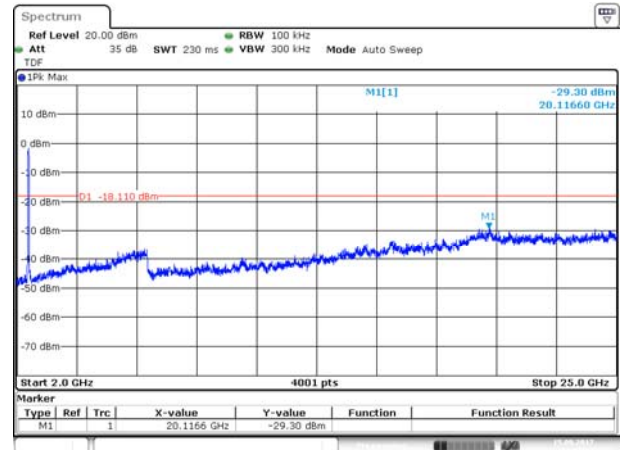

Date: 15.SEP.2017 14:07:15

802.11n-40 MHz HIGH CHANNEL CARRIER LEVEL

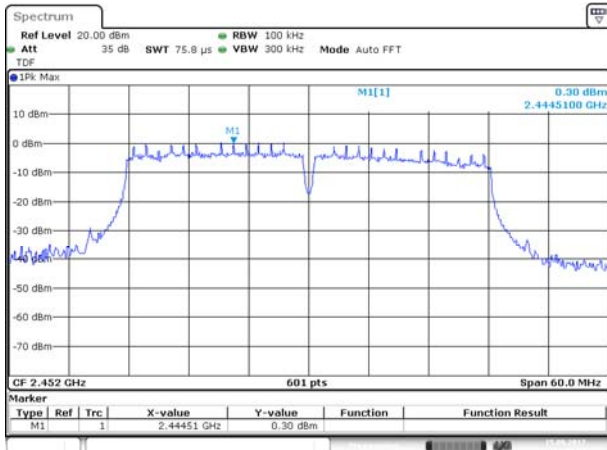

Date: 15.SEP.2017 14:09:04

802.11-n40 MHz HIGH CHANNEL, SPURIOUS  
30 MHz ~ 3 GHz

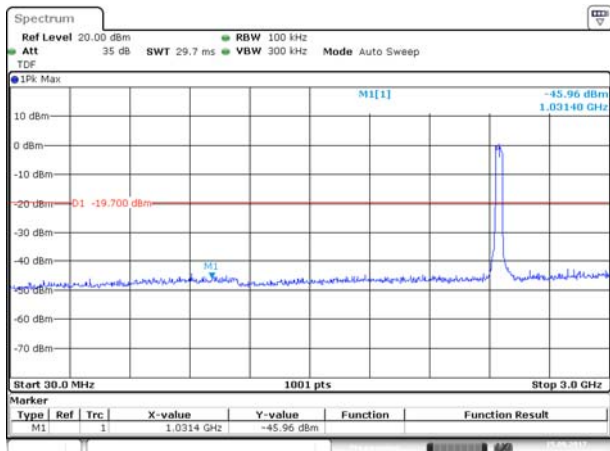

Date: 15.SEP.2017 14:09:29

802.11n-40 MHz HIGH CHANNEL, SPURIOUS  
2 GHz ~ 25 GHz

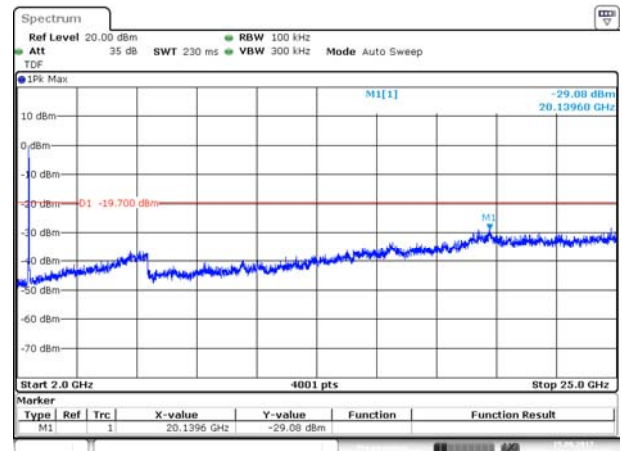

Date: 15.SEP.2017 14:09:38



## A.4 Band Edge (Authorized-band band-edge)

### Test Data

Note: The 99% OBW of the fundamental emission is without 2 MHz of the authorized band.

#### 802.11b Mode:

Channel	Measured Max. Band Edge Emission (dBm)	Limit (dBm)		Verdict
		Carrier Level	Calculated 20 dBc Limit	
Low Channel	-36.56	6.06	-13.940	Pass
High Channel	-47.70	4.70	-15.300	Pass

#### 802.11g Mode:

Channel	Measured Max. Band Edge Emission (dBm)	Limit (dBm)		Verdict
		Carrier Level	Calculated 20 dBc Limit	
Low Channel	-38.81	2.45	-17.550	Pass
High Channel	-48.74	1.23	-18.770	Pass

#### 802.11n-20 MHz Mode:

Channel	Measured Max. Band Edge Emission (dBm)	Limit (dBm)		Verdict
		Carrier Level	Calculated 20 dBc Limit	
Low Channel	-39.40	2.49	-17.510	Pass
High Channel	-47.93	1.8	-18.200	Pass

#### 802.11n-40 MHz Mode:

Channel	Measured Max. Band Edge Emission (dBm)	Limit (dBm)		Verdict
		Carrier Level	Calculated 20 dBc Limit	
Low Channel	-38.61	-0.2	-20.200	Pass
High Channel	-47.68	0.3	-19.700	Pass

Test Plots

802.11b LOW CHANNEL, Carrier level

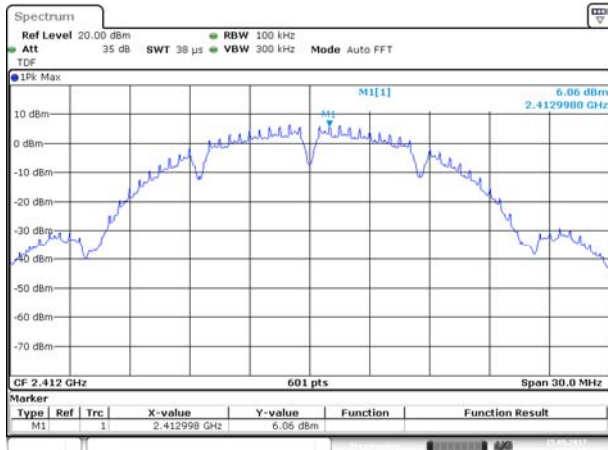

Date: 15.SEP.2017 10:48:02

802.11b LOW CHANNEL, Band Edge

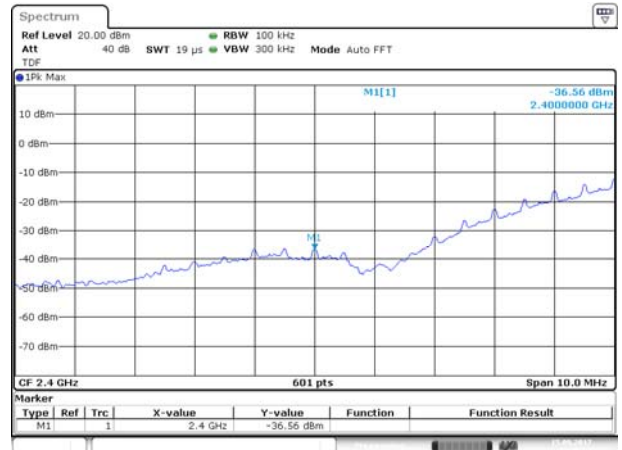

Date: 15.SEP.2017 10:48:57

802.11b HIGH CHANNEL, Carrier level

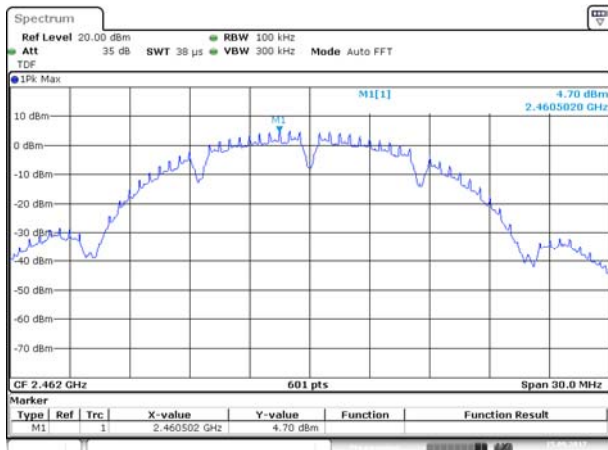

Date: 15.SEP.2017 10:55:22

802.11b HIGH CHANNEL, Band Edge

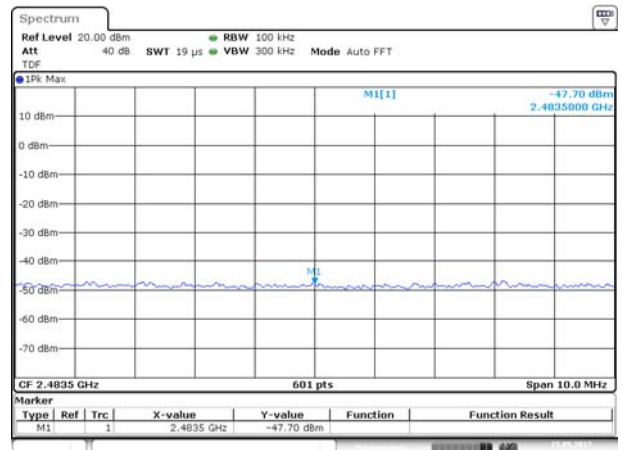

Date: 15.SEP.2017 10:57:02

802.11g LOW CHANNEL, Carrier level

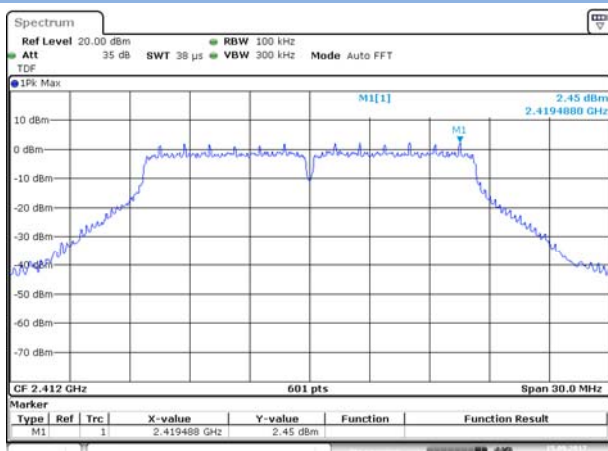

Date: 15.SEP.2017 11:17:44

802.11g LOW CHANNEL, Band Edge

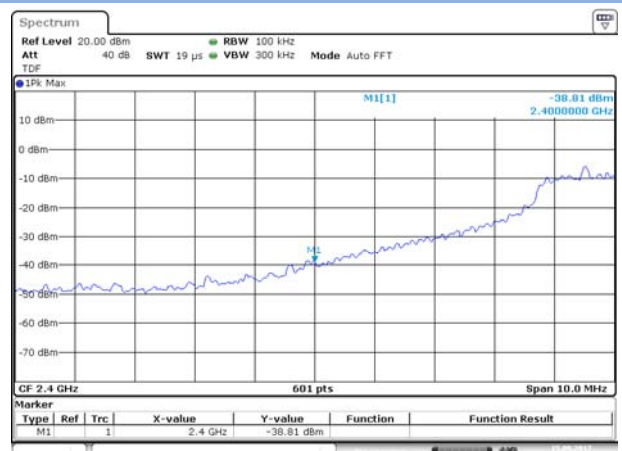

Date: 15.SEP.2017 11:18:47

802.11g HIGH CHANNEL, Carrier level

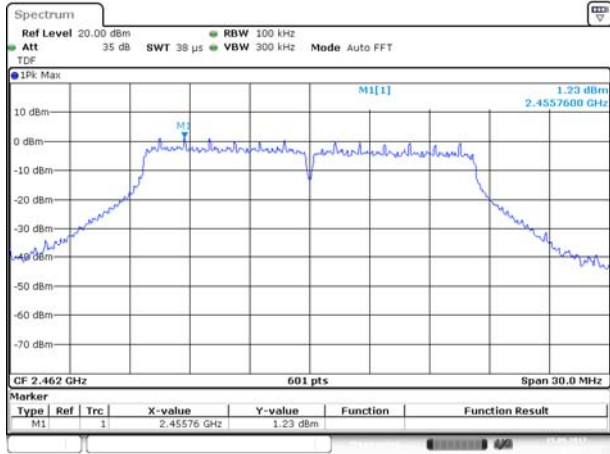

Date: 15 SEP 2017 13:52:44

802.11g HIGH CHANNEL, Band Edge

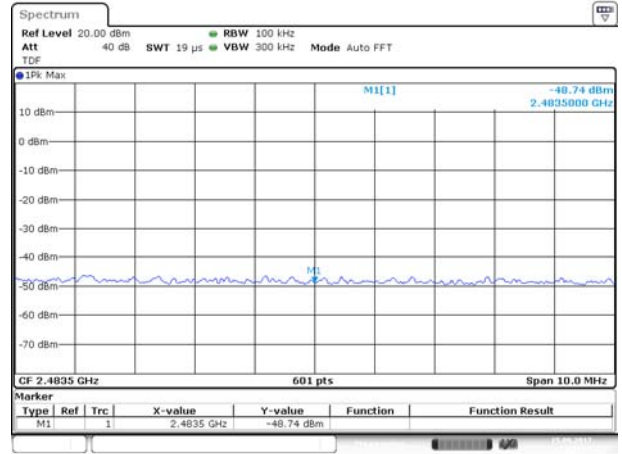

Date: 15 SEP 2017 13:53:39

802.11n-20 MHz LOW CHANNEL, Carrier level

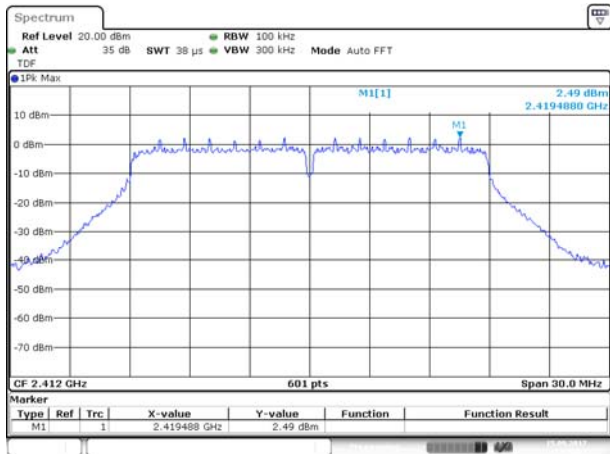

Date: 15 SEP 2017 13:55:23

802.11n-20 MHz LOW CHANNEL, Band Edge

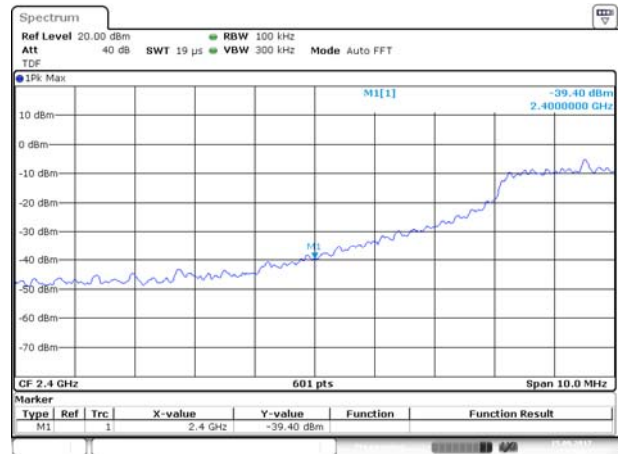

Date: 15 SEP 2017 13:56:24

802.11n-20 MHz HIGH CHANNEL, Carrier level

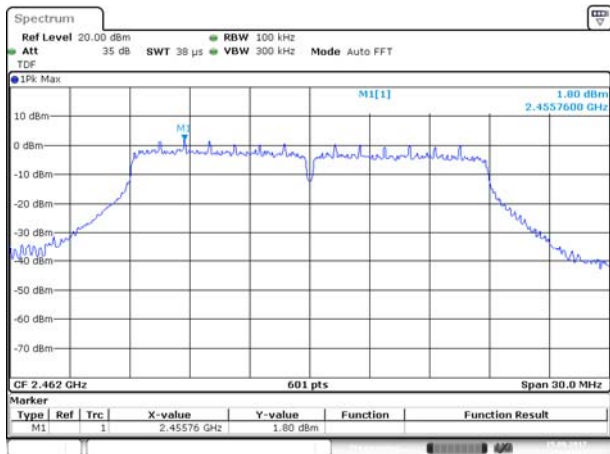

Date: 15 SEP 2017 14:01:23

802.11n-20 MHz HIGH CHANNEL, Band Edge

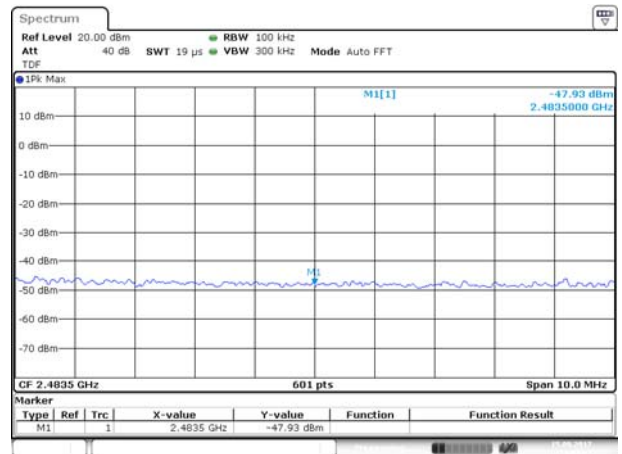

Date: 15 SEP 2017 14:02:11

802.11n-40 MHz LOW CHANNEL, Carrier level

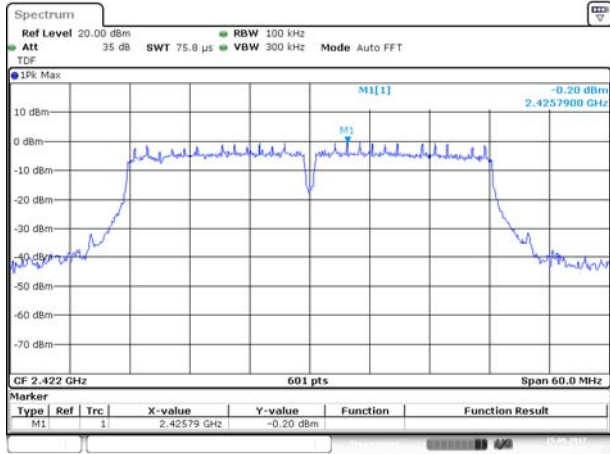

Date: 15 SEP 2017 14:03:42

802.11n-40 MHz LOW CHANNEL, Band Edge

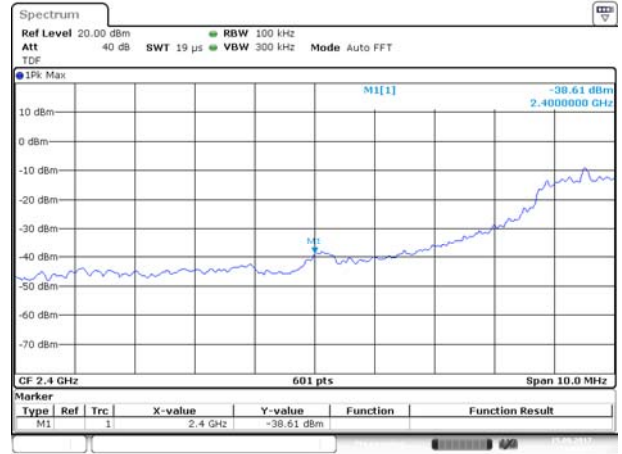

Date: 15 SEP 2017 14:04:39

802.11n-40 MHz HIGH CHANNEL, Carrier level

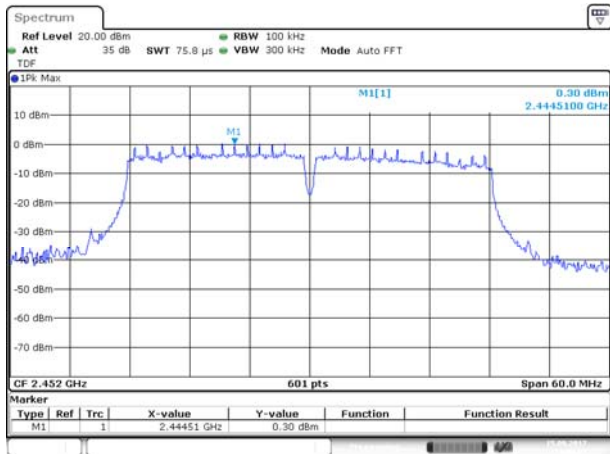

Date: 15 SEP 2017 14:09:04

802.11n-40 MHz HIGH CHANNEL, Band Edge

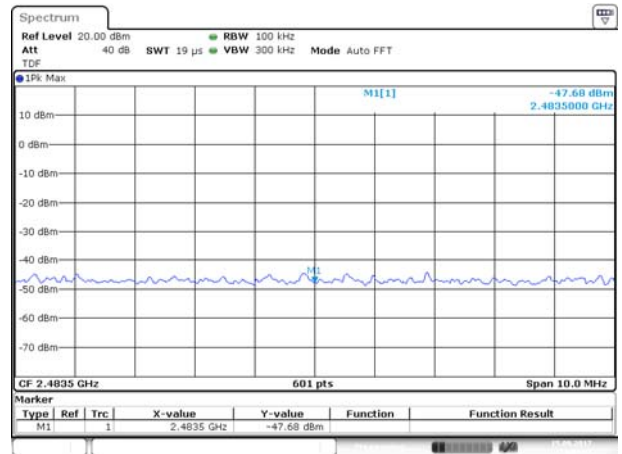

Date: 15 SEP 2017 14:09:46

## A.5 Conducted Emissions

Note: The EUT is working in the Normal link mode.

### Test Data and Plots

#### PHASE L

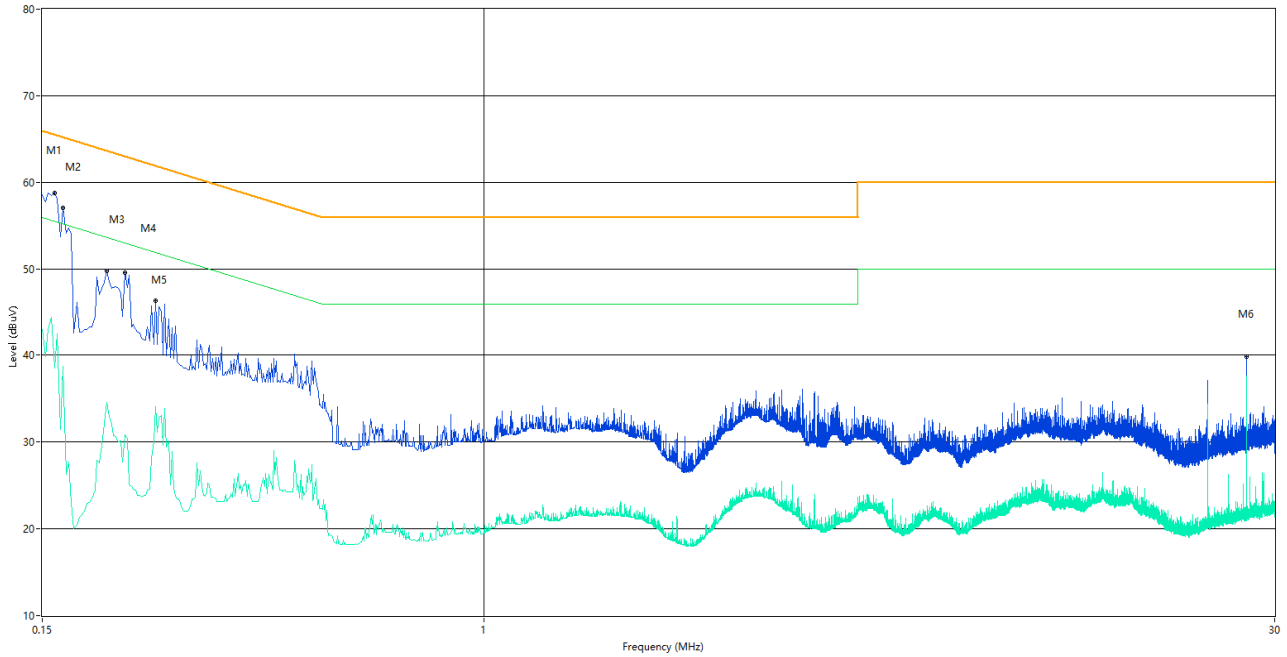

No.	Frequency (MHz)	Results (dBuV)	Factor (dB)	Limit (dBuV)	Margin (dB)	Detector	Line	Verdict
1	0.158	58.8	10.41	65.6	6.80	Peak	L Line	Pass
1**	0.158	38.5	10.41	55.6	17.10	AV	L Line	Pass
2	0.164	57.0	9.41	65.3	8.30	Peak	L Line	Pass
2**	0.164	38.7	9.41	55.3	16.60	AV	L Line	Pass
3	0.198	49.8	9.38	63.7	13.90	Peak	L Line	Pass
3**	0.198	34.5	9.38	53.7	19.20	AV	L Line	Pass
4	0.214	49.6	10.30	63.0	13.40	Peak	L Line	Pass
4**	0.214	30.8	10.30	53.0	22.20	AV	L Line	Pass
5	0.244	46.4	9.47	62.0	15.60	Peak	L Line	Pass
5**	0.244	34.0	9.47	52.0	18.00	AV	L Line	Pass
6	26.622	39.8	11.79	60.0	20.20	Peak	L Line	Pass
6**	26.622	37.6	11.79	50.0	12.40	AV	L Line	Pass

## PHASE N

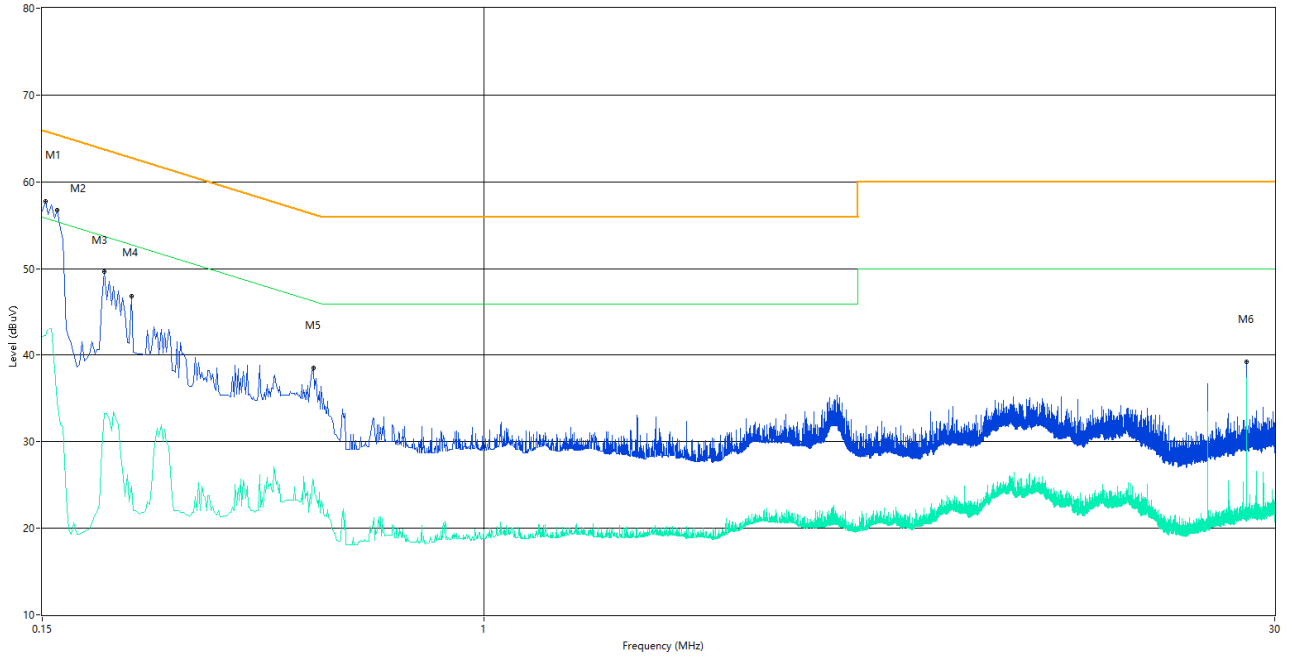

No.	Frequency (MHz)	Results (dBuV)	Factor (dB)	Limit (dBuV)	Margin (dB)	Detector	Line	Verdict
1	0.152	57.8	9.78	65.9	8.10	Peak	N Line	Pass
1**	0.152	42.2	9.78	55.9	13.70	AV	N Line	Pass
2	0.160	56.7	10.29	65.5	8.80	Peak	N Line	Pass
2**	0.160	34.5	10.29	55.5	21.00	AV	N Line	Pass
3	0.196	49.7	9.47	63.8	14.10	Peak	N Line	Pass
3**	0.196	33.3	9.47	53.8	20.50	AV	N Line	Pass
4	0.220	46.9	11.35	62.8	15.90	Peak	N Line	Pass
4**	0.220	24.9	11.35	52.8	27.90	AV	N Line	Pass
5	0.482	38.5	11.13	56.3	17.80	Peak	N Line	Pass
5**	0.482	25.5	11.13	46.3	20.80	AV	N Line	Pass
6	26.622	39.2	11.79	60.0	20.80	Peak	N Line	Pass
6**	26.622	37.4	11.79	50.0	12.60	AV	N Line	Pass

## A.6 Radiated Emission

Note<sup>1</sup>: The symbol of “--” in the table which means not application.

Note<sup>2</sup>: For the test data above 1 GHz, According the ANSI C63.10-2013, where limits are specified for both average and peak (or quasi-peak) detector functions, if the peak (or quasi-peak) measured value complies with the average limit, it is unnecessary to perform an average measurement.

Note<sup>3</sup>: The low frequency, which started from 9 kHz to 30 MHz, was pre-scanned and the result which was 20 dB lower than the limit line per 15.31(o) was not reported.

Note<sup>4</sup>: The EUT is working in the Normal link mode below 1 GHz.

### Test Data and Plots

30 MHz to 1 GHz, ANT H

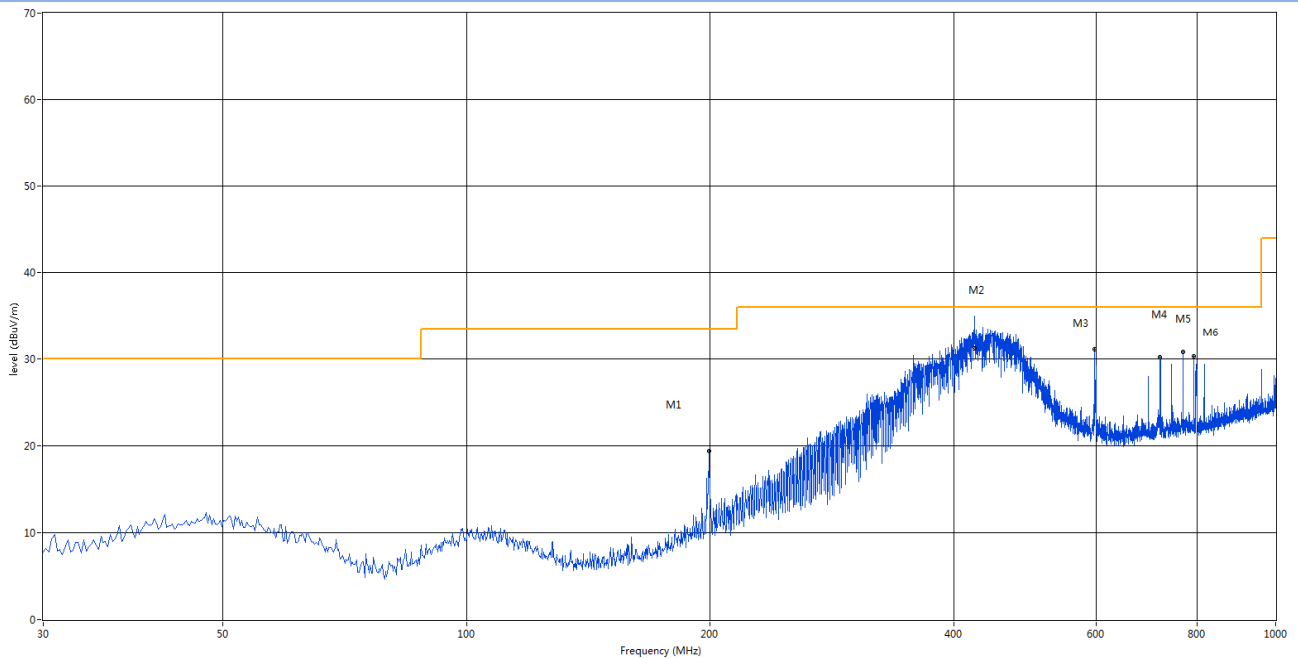

No.	Frequency (MHz)	Results (dBuV/m)	Factor (dB)	Limit (dBuV/m)	Margin (dB)	Detector	Table (o)	Height (cm)	ANT	Verdict
1	199.508	19.42	-14.88	33.5	14.08	Peak	35.00	200	Horizontal	Pass
2	424.794	34.99	-8.98	36.0	1.01	Peak	22.00	229	Horizontal	Pass
2*	424.794	31.17	-8.98	36.0	4.83	QP	22.00	229	Horizontal	Pass
3	597.450	31.09	-5.25	36.0	4.91	Peak	124.00	200	Horizontal	Pass
4	719.912	30.18	-3.56	36.0	5.82	Peak	113.00	100	Horizontal	Pass
5	767.927	30.77	-2.65	36.0	5.23	Peak	92.00	100	Horizontal	Pass
6	791.935	30.25	-2.39	36.0	5.75	Peak	236.00	100	Horizontal	Pass

30 MHz to 1 GHz, ANT V

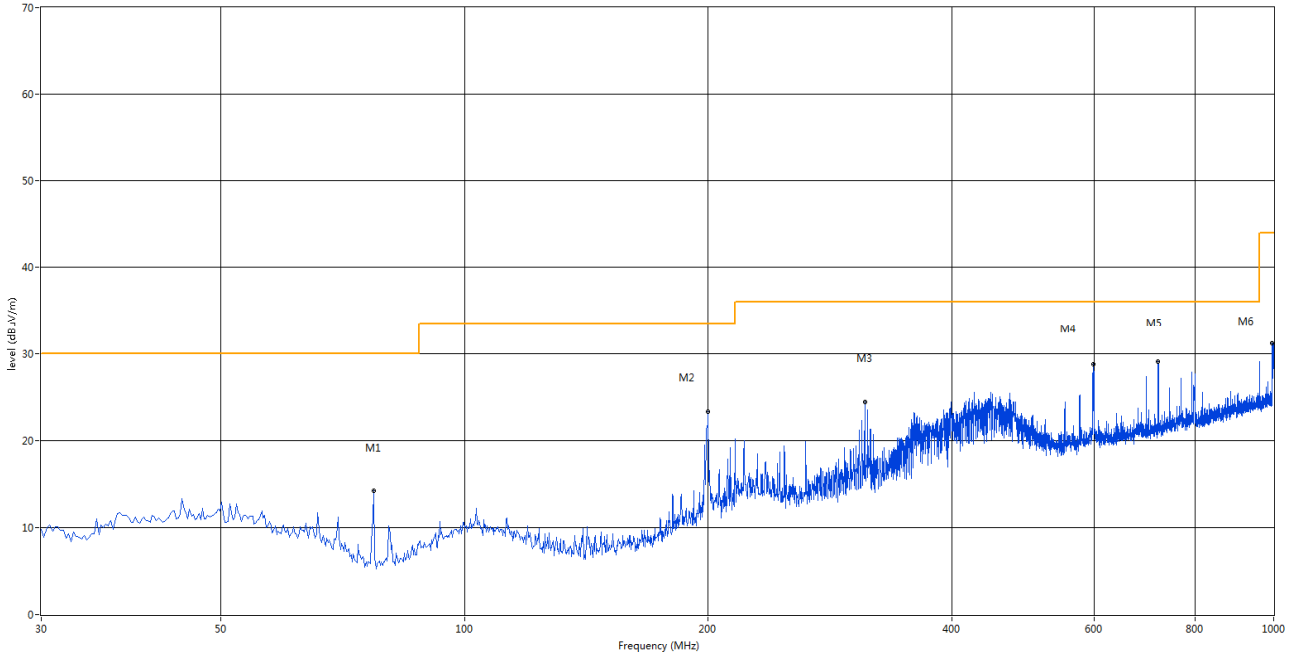

No.	Frequency (MHz)	Results (dBuV/m)	Factor (dB)	Limit (dBuV/m)	Margin (dB)	Detector	Table (o)	Height (cm)	ANT	Verdict
1	77.287	14.20	-19.39	30.0	15.80	Peak	51.00	200	Vertical	Pass
2	199.992	23.30	-14.85	33.5	10.20	Peak	11.00	100	Vertical	Pass
3	312.513	24.44	-11.97	36.0	11.56	Peak	138.00	100	Vertical	Pass
4	598.662	28.77	-5.20	36.0	7.23	Peak	2.00	300	Vertical	Pass
5	719.912	29.08	-3.56	36.0	6.92	Peak	179.00	300	Vertical	Pass
6	995.635	31.19	0.17	44.0	12.81	Peak	0.00	300	Vertical	Pass



Note: The marked spikes near 2400 MHz with circle should be ignored because they are Fundamental signal.

## 1 GHz to 25 GHz, ANT V 802.11b Low Channel

No.	Frequency (MHz)	Results (dBuV/m)	Factor (dB)	Limit (dBuV/m)	Margin (dB)	Detector	Table (o)	Height (cm)	ANT	Verdict
1	2412.77	93.57	11.11	74	-19.57	Peak	151	150	Vertical	N/A
2	2528.13	53.53	11.65	74	20.47	Peak	217.6	150	Vertical	Pass
3	4063.96	51.29	0.00	74	22.71	Peak	36	150	Vertical	Pass
4	6404.33	42.06	20.40	74	31.94	Peak	183.3	150	Vertical	Pass
5	12592.76	44.72	8.72	74	29.28	Peak	244.9	150	Vertical	Pass
6	19269.55	48.53	9.70	74	25.47	Peak	151.1	150	Vertical	Pass

## 1 GHz to 25 GHz, ANT H 802.11b Low Channel

No.	Frequency (MHz)	Results (dBuV/m)	Factor (dB)	Limit (dBuV/m)	Margin (dB)	Detector	Table (o)	Height (cm)	ANT	Verdict
1	2412.62	99.20	11.11	74	-25.20	Peak	183.1	150	Horizontal	N/A
2	2593.58	46.89	11.47	74	27.11	Peak	255.1	150	Horizontal	Pass
3	4060.26	50.41	0.00	74	23.59	Peak	113	150	Horizontal	Pass
4	8369.80	45.99	20.43	74	28.01	Peak	242.5	150	Horizontal	Pass
5	16618.55	44.59	11.26	74	29.41	Peak	9.4	150	Horizontal	Pass
6	24410.98	46.59	13.08	74	27.41	Peak	142.7	150	Horizontal	Pass

## 1 GHz to 25 GHz, ANT V 802.11b Middle Channel

No.	Frequency (MHz)	Results (dBuV/m)	Factor (dB)	Limit (dBuV/m)	Margin (dB)	Detector	Table (o)	Height (cm)	ANT	Verdict
1	2437.25	92.68	11.11	74	-18.68	Peak	269.6	150	Vertical	N/A
2	2525.30	53.88	11.69	74	20.12	Peak	251.9	150	Vertical	Pass
3	4063.18	52.67	0.00	74	21.33	Peak	231.3	150	Vertical	Pass
4	6943.43	47.13	14.28	74	26.87	Peak	79.6	150	Vertical	Pass
5	17512.90	44.27	20.58	74	29.73	Peak	142.1	150	Vertical	Pass
6	18365.64	48.90	11.07	74	25.10	Peak	225.7	150	Vertical	Pass

## 1 GHz to 25 GHz, ANT H 802.11b Middle Channel

No.	Frequency (MHz)	Results (dBuV/m)	Factor (dB)	Limit (dBuV/m)	Margin (dB)	Detector	Table (o)	Height (cm)	ANT	Verdict
1	2437.61	99.24	11.12	74	-25.24	Peak	137.1	150	Horizontal	N/A
2	2594.42	48.23	11.50	74	25.77	Peak	267.8	150	Horizontal	Pass
3	4061.40	50.47	0.00	74	23.53	Peak	124.6	150	Horizontal	Pass
4	8830.28	50.16	17.08	74	23.84	Peak	12.2	150	Horizontal	Pass
5	17013.73	45.65	9.58	74	28.35	Peak	139.2	150	Horizontal	Pass
6	20178.04	49.86	13.60	74	24.14	Peak	164.1	150	Horizontal	Pass

## 1 GHz to 25 GHz, ANT V 802.11b High Channel

No.	Frequency (MHz)	Results (dBuV/m)	Factor (dB)	Limit (dBuV/m)	Margin (dB)	Detector	Table (o)	Height (cm)	ANT	Verdict
1	2462.79	93.96	11.11	74	-19.96	Peak	109.7	150	Vertical	N/A
2	2528.50	53.47	11.69	74	20.53	Peak	350.3	150	Vertical	Pass
3	4063.00	52.03	0.00	74	21.97	Peak	79.6	150	Vertical	Pass
4	9144.76	45.94	17.84	74	28.06	Peak	43.2	150	Vertical	Pass
5	13904.33	41.47	10.59	74	32.53	Peak	41.5	150	Vertical	Pass
6	19449.25	47.79	11.10	74	26.21	Peak	157.1	150	Vertical	Pass

## 1 GHz to 25 GHz, ANT H 802.11b High Channel

No.	Frequency (MHz)	Results (dBuV/m)	Factor (dB)	Limit (dBuV/m)	Margin (dB)	Detector	Table (o)	Height (cm)	ANT	Verdict
1	2462.61	100.01	11.11	74	-26.01	Peak	135.8	150	Horizontal	N/A
2	2594.99	46.64	11.49	74	27.36	Peak	244	150	Horizontal	Pass
3	4058.55	50.37	0.00	74	23.63	Peak	331.7	150	Horizontal	Pass
4	8178.87	50.77	14.87	74	23.23	Peak	321.2	150	Horizontal	Pass
5	12401.83	45.01	9.78	74	28.99	Peak	79.7	150	Horizontal	Pass
6	20138.10	44.71	12.44	74	29.29	Peak	246.8	150	Horizontal	Pass

## 1 GHz to 25 GHz, ANT V 802.11g Low Channel

No.	Frequency (MHz)	Results (dBuV/m)	Factor (dB)	Limit (dBuV/m)	Margin (dB)	Detector	Table (o)	Height (cm)	ANT	Verdict
1	2412.55	92.66	11.12	74	-18.66	Peak	157.9	150	Vertical	N/A
2	2529.32	52.34	11.66	74	21.66	Peak	348.4	150	Vertical	Pass
3	4059.60	51.35	0.00	74	22.65	Peak	259.7	150	Vertical	Pass
4	9751.25	46.07	14.74	74	27.93	Peak	358.5	150	Vertical	Pass
5	14216.31	44.66	8.73	74	29.34	Peak	48.9	150	Vertical	Pass
6	19329.45	43.55	12.56	74	30.45	Peak	19.5	150	Vertical	Pass

## 1 GHz to 25 GHz, ANT H 802.11g Low Channel

No.	Frequency (MHz)	Results (dBuV/m)	Factor (dB)	Limit (dBuV/m)	Margin (dB)	Detector	Table (o)	Height (cm)	ANT	Verdict
1	2412.21	98.88	11.12	74	-24.88	Peak	349.9	150	Horizontal	N/A
2	2595.39	46.38	11.49	74	27.62	Peak	28.6	150	Horizontal	Pass
3	4062.58	50.52	0.00	74	23.48	Peak	263.8	150	Horizontal	Pass
4	8695.51	43.34	16.61	74	30.66	Peak	249.3	150	Horizontal	Pass
5	14403.49	46.47	9.08	74	27.53	Peak	265.5	150	Horizontal	Pass
6	20727.12	44.46	12.16	74	29.54	Peak	16.9	150	Horizontal	Pass

## 1 GHz to 25 GHz, ANT V 802.11g Middle Channel

No.	Frequency (MHz)	Results (dBuV/m)	Factor (dB)	Limit (dBuV/m)	Margin (dB)	Detector	Table (o)	Height (cm)	ANT	Verdict
1	2437.32	93.48	11.12	74	-19.48	Peak	237.1	150	Vertical	N/A
2	2527.63	53.35	11.67	74	20.65	Peak	54.4	150	Vertical	Pass
3	4064.87	52.27	0.00	74	21.73	Peak	95.8	150	Vertical	Pass
4	9302.00	48.57	13.99	74	25.43	Peak	310.7	150	Vertical	Pass
5	14070.72	46.55	9.79	74	27.45	Peak	294.4	150	Vertical	Pass
6	20028.29	51.18	12.87	74	22.82	Peak	263	150	Vertical	Pass

## 1 GHz to 25 GHz, ANT H 802.11g Middle Channel

No.	Frequency (MHz)	Results (dBuV/m)	Factor (dB)	Limit (dBuV/m)	Margin (dB)	Detector	Table (o)	Height (cm)	ANT	Verdict
1	2437.99	99.05	11.11	74	-25.05	Peak	169.4	150	Horizontal	N/A
2	2593.19	47.02	11.49	74	26.98	Peak	312.2	150	Horizontal	Pass
3	4058.10	51.94	0.00	74	22.06	Peak	171.1	150	Horizontal	Pass
4	9661.40	48.05	19.02	74	25.95	Peak	170.9	150	Horizontal	Pass
5	13405.16	45.17	9.08	74	28.84	Peak	219.4	150	Horizontal	Pass
6	20727.12	46.48	12.30	74	27.52	Peak	28.5	150	Horizontal	Pass

## 1 GHz to 25 GHz, ANT V 802.11g High Channel

No.	Frequency (MHz)	Results (dBuV/m)	Factor (dB)	Limit (dBuV/m)	Margin (dB)	Detector	Table (o)	Height (cm)	ANT	Verdict
1	2462.86	93.04	11.12	74	-19.04	Peak	334.5	150	Vertical	N/A
2	2527.00	53.65	11.65	74	20.35	Peak	104.7	150	Vertical	Pass
3	4060.00	52.21	0.00	74	21.79	Peak	166.9	150	Vertical	Pass
4	9470.47	46.69	19.10	74	27.31	Peak	17.5	150	Vertical	Pass
5	12947.59	43.97	9.63	74	30.03	Peak	1.3	150	Vertical	Pass
6	22224.63	43.82	11.29	74	30.18	Peak	222.2	150	Vertical	Pass

## 1 GHz to 25 GHz, ANT H 802.11g High Channel

No.	Frequency (MHz)	Results (dBuV/m)	Factor (dB)	Limit (dBuV/m)	Margin (dB)	Detector	Table (o)	Height (cm)	ANT	Verdict
1	2462.35	100.12	11.12	74	-26.12	Peak	196.6	150	Horizontal	N/A
2	2594.44	46.75	11.49	74	27.25	Peak	106.2	150	Horizontal	Pass
3	4063.65	51.89	0.00	74	22.11	Peak	325.7	150	Horizontal	Pass
4	9886.02	44.33	17.07	74	29.67	Peak	247.4	150	Horizontal	Pass
5	13228.37	50.46	9.06	74	23.54	Peak	139.7	150	Horizontal	Pass
6	22474.21	46.35	10.73	74	27.65	Peak	356.3	150	Horizontal	Pass

## 1 GHz to 25 GHz, ANT V 802.11n20 Low Channel

No.	Frequency (MHz)	Results (dBuV/m)	Factor (dB)	Limit (dBuV/m)	Margin (dB)	Detector	Table (o)	Height (cm)	ANT	Verdict
1	2412.94	93.62	11.12	74	-19.62	Peak	101	150	Vertical	N/A
2	2526.58	50.90	11.65	74	23.10	Peak	116.2	150	Vertical	Pass
3	4059.55	52.43	0.00	74	21.57	Peak	98.6	150	Vertical	Pass
4	6595.26	48.19	14.08	74	25.81	Peak	78.9	150	Vertical	Pass
5	15277.04	47.06	20.15	74	26.94	Peak	17.8	150	Vertical	Pass
6	19279.53	47.19	12.33	74	26.81	Peak	55.1	150	Vertical	Pass

## 1 GHz to 25 GHz, ANT H 802.11n20 Low Channel

No.	Frequency (MHz)	Results (dBuV/m)	Factor (dB)	Limit (dBuV/m)	Margin (dB)	Detector	Table (o)	Height (cm)	ANT	Verdict
1	2412.13	98.45	11.12	74	-24.45	Peak	162.5	150	Horizontal	N/A
2	2597.09	47.47	11.47	74	26.53	Peak	315.7	150	Horizontal	Pass
3	4064.10	51.09	0.00	74	22.91	Peak	92.5	150	Horizontal	Pass
4	6134.78	41.96	20.52	74	32.04	Peak	137.6	150	Horizontal	Pass
5	17159.32	46.13	20.87	74	27.87	Peak	268.9	150	Horizontal	Pass
6	21515.81	47.25	11.28	74	26.75	Peak	132.9	150	Horizontal	Pass

## 1 GHz to 25 GHz, ANT V 802.11n20 Middle Channel

No.	Frequency (MHz)	Results (dBuV/m)	Factor (dB)	Limit (dBuV/m)	Margin (dB)	Detector	Table (o)	Height (cm)	ANT	Verdict
1	2437.88	92.58	11.12	74	-18.58	Peak	193.3	150	Vertical	N/A
2	2526.63	53.73	11.65	74	20.27	Peak	42.1	150	Vertical	Pass
3	4063.89	51.42	0.00	74	22.58	Peak	1.4	150	Vertical	Pass
4	8661.81	48.43	20.33	74	25.57	Peak	112.8	150	Vertical	Pass
5	15984.19	43.82	9.25	74	30.18	Peak	9.6	150	Vertical	Pass
6	24021.63	43.14	12.13	74	30.86	Peak	192	150	Vertical	Pass

## 1 GHz to 25 GHz, ANT H 802.11n20 Middle Channel

No.	Frequency (MHz)	Results (dBuV/m)	Factor (dB)	Limit (dBuV/m)	Margin (dB)	Detector	Table (o)	Height (cm)	ANT	Verdict
1	2437.12	99.04	11.12	74	-25.04	Peak	98.2	150	Horizontal	N/A
2	2594.25	47.44	11.49	74	26.56	Peak	205.8	150	Horizontal	Pass
3	4064.15	50.85	0.00	74	23.15	Peak	206	150	Horizontal	Pass
4	9784.94	40.55	13.69	74	33.46	Peak	126.5	150	Horizontal	Pass
5	14923.46	47.60	8.73	74	26.40	Peak	245.8	150	Horizontal	Pass
6	22613.98	46.59	10.01	74	27.41	Peak	109.6	150	Horizontal	Pass

## 1 GHz to 25 GHz, ANT V 802.11n20 High Channel

No.	Frequency (MHz)	Results (dBuV/m)	Factor (dB)	Limit (dBuV/m)	Margin (dB)	Detector	Table (o)	Height (cm)	ANT	Verdict
1	2462.05	93.32	11.12	74	-19.32	Peak	203.6	150	Vertical	N/A
2	2527.50	52.14	11.69	74	21.86	Peak	303.1	150	Vertical	Pass
3	4059.00	51.18	0.00	74	22.82	Peak	156.6	150	Vertical	Pass
4	10571.13	45.15	16.69	74	28.85	Peak	183.6	150	Vertical	Pass
5	12822.80	45.22	8.71	74	28.78	Peak	82.7	150	Vertical	Pass
6	18064.06	44.37	8.32	74	29.63	Peak	346.2	150	Vertical	Pass

## 1 GHz to 25 GHz, ANT H 802.11n20 High Channel

No.	Frequency (MHz)	Results (dBuV/m)	Factor (dB)	Limit (dBuV/m)	Margin (dB)	Detector	Table (o)	Height (cm)	ANT	Verdict
1	2462.04	99.87	11.11	74	-25.87	Peak	149.2	150	Horizontal	N/A
2	2595.28	47.65	11.50	74	26.35	Peak	277.7	150	Horizontal	Pass
3	4060.65	50.45	0.00	74	23.55	Peak	303.5	150	Horizontal	Pass
4	9762.48	48.09	18.90	74	25.91	Peak	257.3	150	Horizontal	Pass
5	15173.05	43.93	8.75	74	30.08	Peak	285.7	150	Horizontal	Pass
6	19129.78	44.09	11.24	74	29.91	Peak	47.7	150	Horizontal	Pass

## 1 GHz to 25 GHz, ANT V 802.11n40 Low Channel

No.	Frequency (MHz)	Results (dBuV/m)	Factor (dB)	Limit (dBuV/m)	Margin (dB)	Detector	Table (o)	Height (cm)	ANT	Verdict
1	2422.90	92.80	11.11	74	-18.80	Peak	181	150	Vertical	N/A
2	2528.43	53.62	11.69	74	20.38	Peak	285	150	Vertical	Pass
3	4059.59	51.46	0.00	74	22.54	Peak	318.9	150	Vertical	Pass
4	6831.12	43.81	14.17	74	30.19	Peak	32.1	150	Vertical	Pass
5	17200.92	45.08	20.72	74	28.92	Peak	80.4	150	Vertical	Pass
6	20876.87	45.78	10.08	74	28.22	Peak	60	150	Vertical	Pass

## 1 GHz to 25 GHz, ANT H 802.11n40 Low Channel

No.	Frequency (MHz)	Results (dBuV/m)	Factor (dB)	Limit (dBuV/m)	Margin (dB)	Detector	Table (o)	Height (cm)	ANT	Verdict
1	2422.88	99.63	11.11	74	-25.63	Peak	208.7	150	Horizontal	N/A
2	2596.84	47.04	11.50	74	26.96	Peak	199.4	150	Horizontal	Pass
3	4060.54	51.30	0.00	74	22.70	Peak	33.8	150	Horizontal	Pass
4	7381.45	46.70	14.66	74	27.30	Peak	357.5	150	Horizontal	Pass
5	13633.94	44.64	9.53	74	29.36	Peak	208.5	150	Horizontal	Pass
6	18136.86	48.02	10.69	74	25.98	Peak	237.3	150	Horizontal	Pass

## 1 GHz to 25 GHz, ANT V 802.11n40 Middle Channel

No.	Frequency (MHz)	Results (dBuV/m)	Factor (dB)	Limit (dBuV/m)	Margin (dB)	Detector	Table (o)	Height (cm)	ANT	Verdict
1	2437.12	94.28	11.12	74	-20.28	Peak	125.3	150	Vertical	N/A
2	2526.87	52.25	11.69	74	21.75	Peak	185.6	150	Vertical	Pass
3	4064.53	52.64	0.00	74	21.36	Peak	147.9	150	Vertical	Pass
4	8751.66	52.29	14.87	74	21.71	Peak	299.3	150	Vertical	Pass
5	16202.58	44.93	20.65	74	29.07	Peak	328.9	150	Vertical	Pass
6	22114.81	48.84	11.22	74	25.16	Peak	111.5	150	Vertical	Pass

## 1 GHz to 25 GHz, ANT H 802.11n40 Middle Channel

No.	Frequency (MHz)	Results (dBuV/m)	Factor (dB)	Limit (dBuV/m)	Margin (dB)	Detector	Table (o)	Height (cm)	ANT	Verdict
1	2437.38	100.33	11.11	74	-26.33	Peak	142.5	150	Horizontal	N/A
2	2593.24	47.60	11.50	74	26.40	Peak	215.5	150	Horizontal	Pass
3	4061.63	51.71	0.00	74	22.29	Peak	328.3	150	Horizontal	Pass
4	11492.10	50.06	16.24	74	23.94	Peak	349.3	150	Horizontal	Pass
5	13061.98	42.80	9.07	74	31.20	Peak	316.6	150	Horizontal	Pass
6	20986.69	44.72	11.29	74	29.28	Peak	224.4	150	Horizontal	Pass

## 1 GHz to 25 GHz, ANT V 802.11n40 High Channel

No.	Frequency (MHz)	Results (dBuV/m)	Factor (dB)	Limit (dBuV/m)	Margin (dB)	Detector	Table (o)	Height (cm)	ANT	Verdict
1	2452.04	92.67	11.12	74	-18.67	Peak	221.7	150	Vertical	N/A
2	2527.00	53.59	11.65	74	20.41	Peak	323.9	150	Vertical	Pass
3	4064.00	51.40	0.00	74	22.60	Peak	196.6	150	Vertical	Pass
4	10402.66	48.37	20.40	74	25.64	Peak	37	150	Vertical	Pass
5	14372.30	44.69	9.06	74	29.31	Peak	86.6	150	Vertical	Pass
6	18032.86	44.60	11.00	74	29.40	Peak	31.4	150	Vertical	Pass

## 1 GHz to 25 GHz, ANT H 802.11n40 High Channel

No.	Frequency (MHz)	Results (dBuV/m)	Factor (dB)	Limit (dBuV/m)	Margin (dB)	Detector	Table (o)	Height (cm)	ANT	Verdict
1	2452.54	99.04	11.11	74	-25.04	Peak	29	150	Horizontal	N/A
2	2594.97	46.79	11.50	74	27.21	Peak	333.8	150	Horizontal	Pass
3	4060.90	51.14	0.00	74	22.86	Peak	153.3	150	Horizontal	Pass
4	8336.11	44.15	14.18	74	29.85	Peak	252.2	150	Horizontal	Pass
5	13977.12	42.44	10.00	74	31.56	Peak	117.7	150	Horizontal	Pass
6	18324.04	45.94	11.16	74	28.06	Peak	255.5	150	Horizontal	Pass

## A.7 Band Edge (Restricted-band band-edge)

### Test Data

Note<sup>1</sup>: The lowest and highest channels are tested to verify the band edge emissions. Please refer to the following the plots for emissions values.

Note<sup>2</sup>: The test data all are tested in the vertical and horizontal antenna which the trace is max hold. So these plots have shown the worst case.

Note<sup>3</sup>: According the ANSI C63.10-2013, where limits are specified for both average and peak (or quasi-peak) detector functions, if the peak (or quasi-peak) measured value complies with the average limit, it is unnecessary to perform an average measurement.

Test Mode	Test Channel	Frequency (MHz)	Level (dBuV/m)	Limit Line (dBuV/m)	Margin (dB)	Remark	Verdict
802.11b	Low	2390	45.766	74	28.23	PEAK	Pass
		2390	N/A	54	N/A	AVERAGE	Pass
	HIGH	2483.5	46.506	74	27.49	PEAK	Pass
		2483.5	N/A	54	N/A	AVERAGE	Pass
802.11g	Low	2390	56.880	74	17.12	PEAK	Pass
		2390	43.759	54	10.24	AVERAGE	Pass
	HIGH	2483.5	71.995	74	2.01	PEAK	Pass
		2483.5	47.958	54	6.04	AVERAGE	Pass
802.11n20	Low	2390	64.200	74	9.80	PEAK	Pass
		2390	50.741	54	3.26	AVERAGE	Pass
	HIGH	2483.5	63.561	74	10.44	PEAK	Pass
		2483.5	49.298	54	4.70	AVERAGE	Pass
802.11n40	Low	2390	64.589	74	9.41	PEAK	Pass
		2390	53.624	54	0.38	AVERAGE	Pass
	HIGH	2483.5	61.298	74	12.70	PEAK	Pass
		2483.5	51.276	54	2.72	AVERAGE	Pass

802.11b Mode:

LOW CHANNEL, PEAK

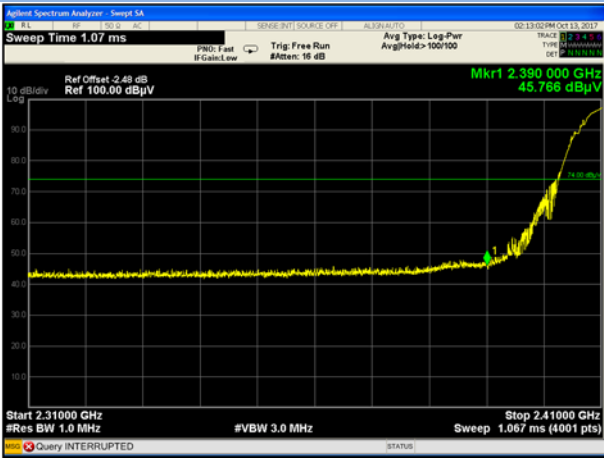

HIGH CHANNEL, PEAK

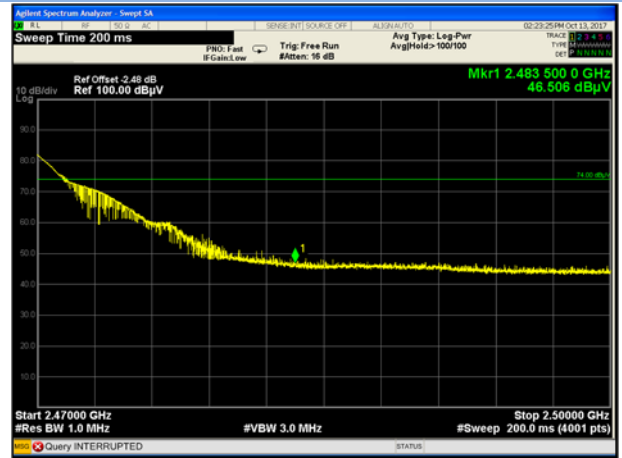

802.11g Mode:

LOW CHANNEL, PEAK

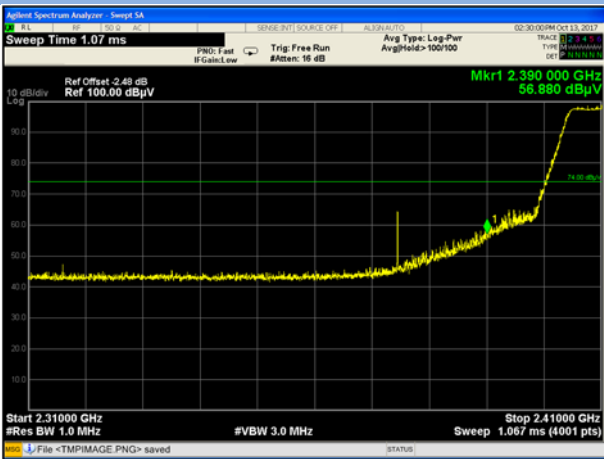

LOW CHANNEL, AV

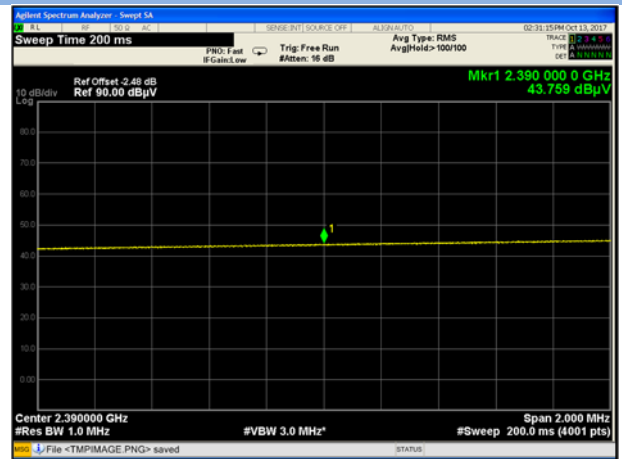

HIGH CHANNEL, PEAK

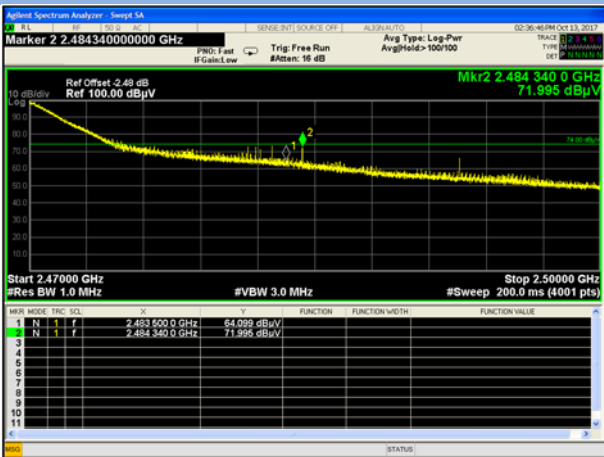

HIGH CHANNEL, AV

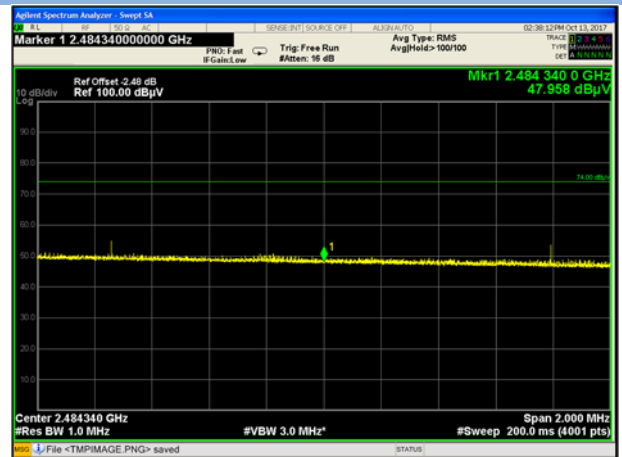



802.11n-20 MHz Mode:

Low CHANNEL, PEAK

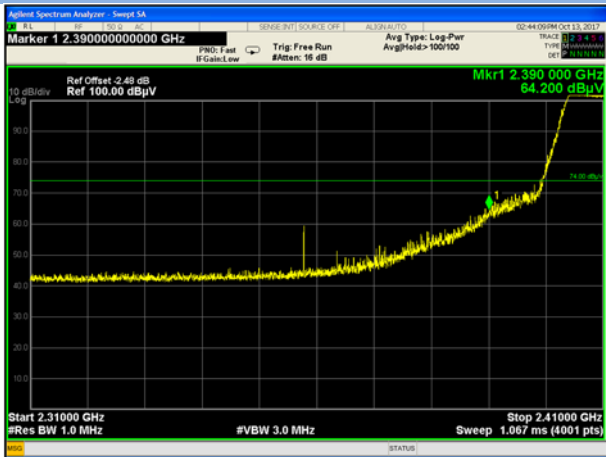

Low CHANNEL, AV

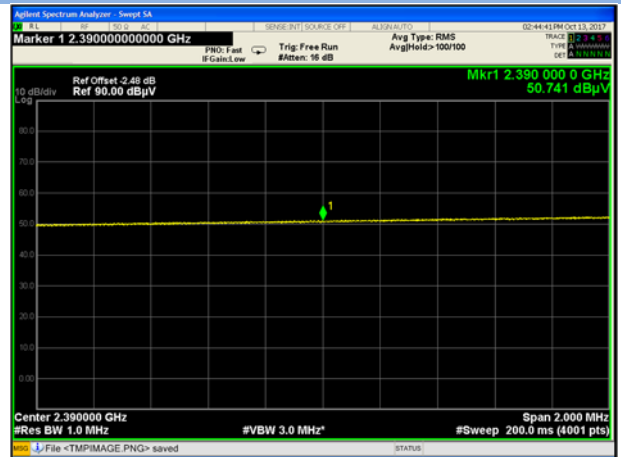

HIGH CHANNEL, PEAK

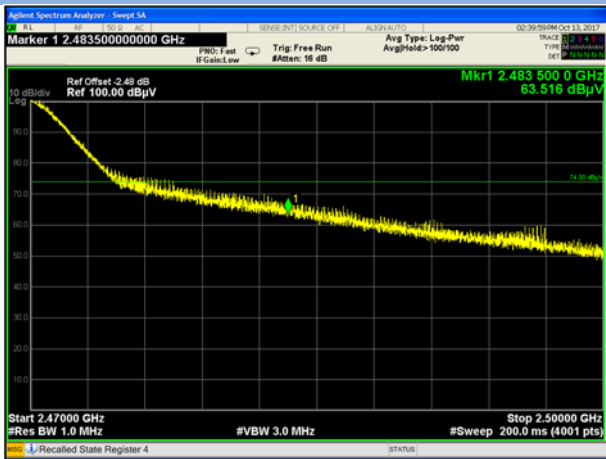

HIGH CHANNEL, AV



802.11n-40 MHz Mode:

Low CHANNEL, PEAK

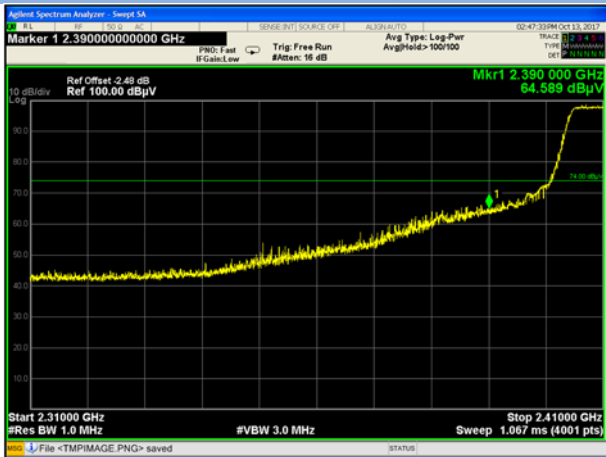

Low CHANNEL, AV

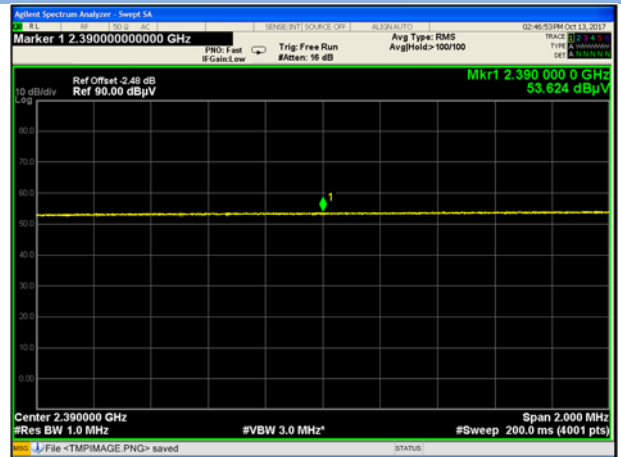

HIGH CHANNEL, PEAK

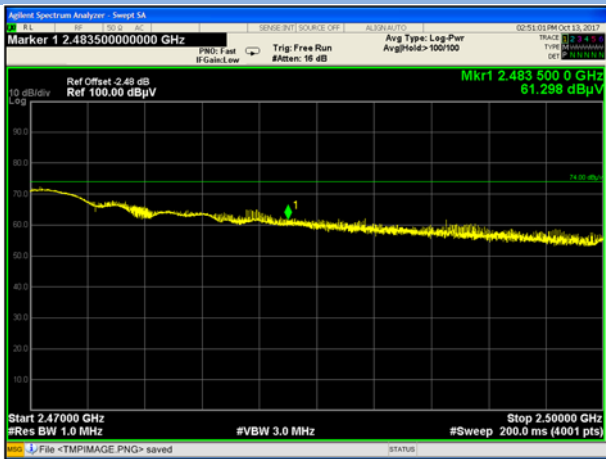

HIGH CHANNEL, AV

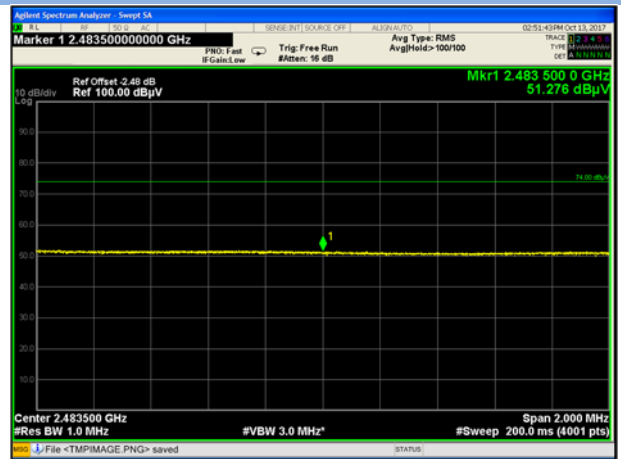

## A.8 Power Spectral Density (PSD)

### Test Data

#### 802.11b Mode:

Channel	Spectral power density (dBm/3kHz)	Limit (dBm/3kHz)
Low	-13.12	8
Middle	-14.15	8
High	-14.86	8

#### 802.11g Mode:

Channel	Spectral power density (dBm/3kHz)	Limit (dBm/3kHz)
Low	-18.45	8
Middle	-14.73	8
High	-18.47	8

#### 802.11n-20 MHz Mode:

Channel	Spectral power density (dBm/3kHz)	Limit (dBm/3kHz)
Low	-16.48	8
Middle	-13.60	8
High	-19.12	8

#### 802.11n-40 MHz Mode:

Channel	Spectral power density (dBm/3kHz)	Limit (dBm/3kHz)
Low	-20.43	8
Middle	-18.06	8
High	-18.54	8

Test plots

802.11b LOW CHANNEL

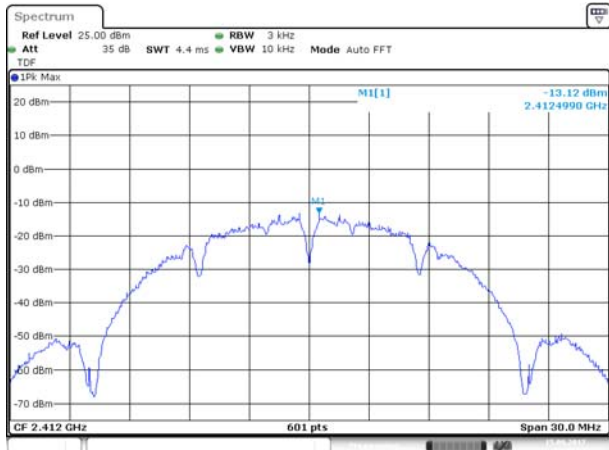

Date: 15 SEP 2017 10:49:57

802.11b MIDDLE CHANNEL



Date: 15 SEP 2017 10:53:34

802.11b HIGH CHANNEL



Date: 15 SEP 2017 10:57:27

802.11g LOW CHANNEL

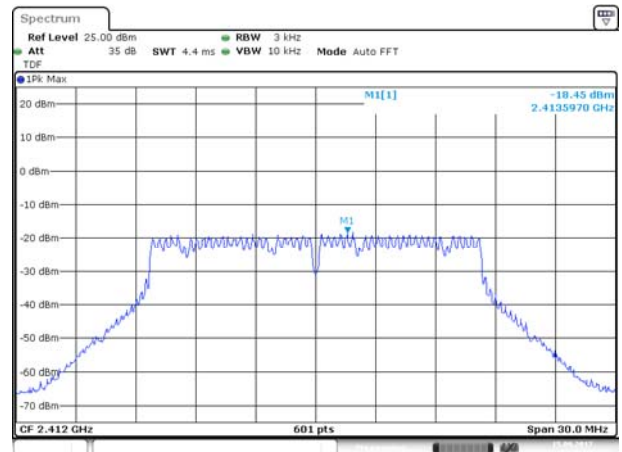

Date: 15 SEP 2017 11:19:08

802.11g MIDDLE CHANNEL

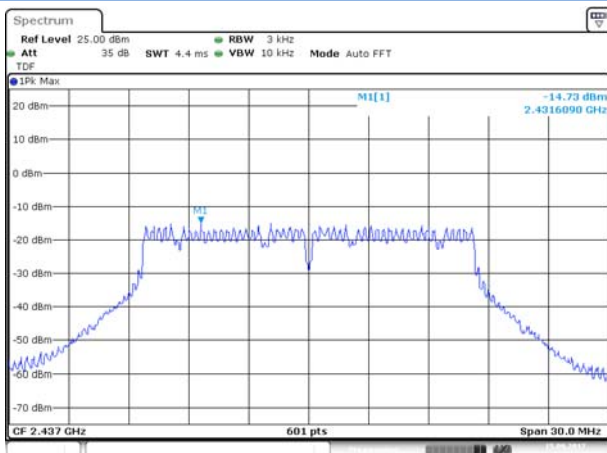

Date: 15 SEP 2017 13:51:17

802.11g HIGH CHANNEL

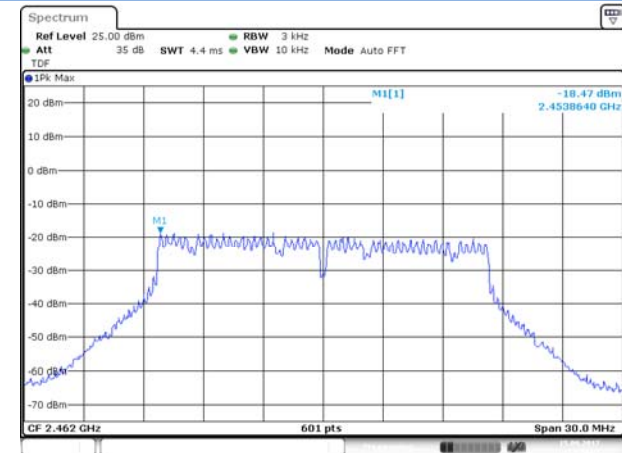

Date: 15 SEP 2017 13:54:05

3

802.11n-20 MHz LOW CHANNEL

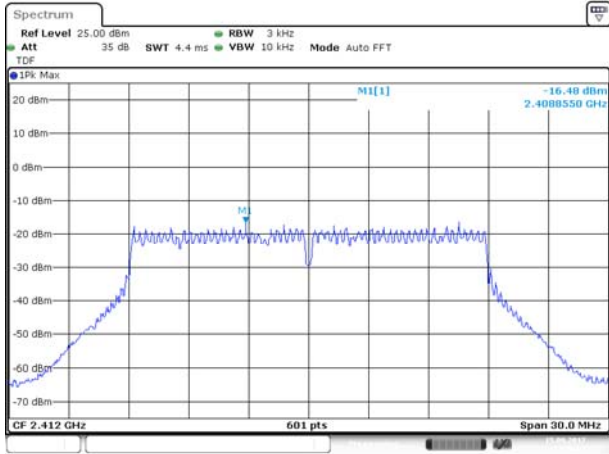

Date: 15 SEP 2017 13:56:57

802.11 n-20 MHz MIDDLE CHANNEL

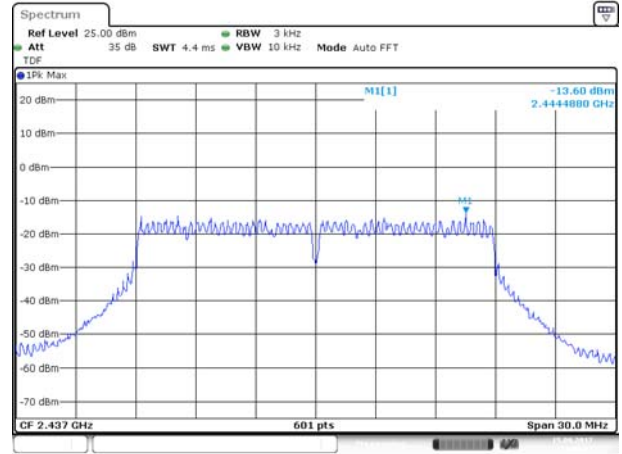

Date: 15 SEP 2017 14:00:11

802.11n-20 MHz HIGH CHANNEL

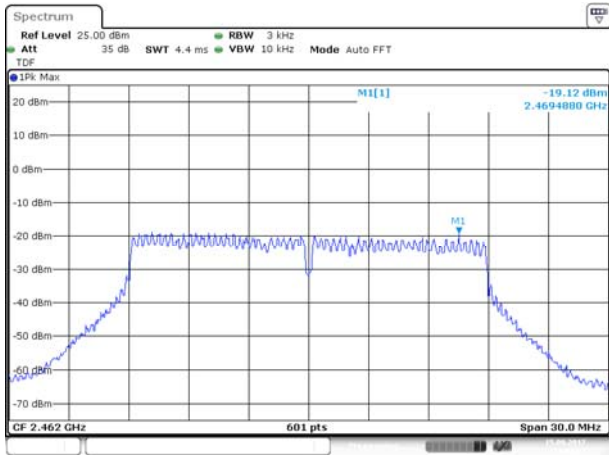

Date: 15 SEP 2017 14:02:32

802.11n-40 MHz LOW CHANNEL

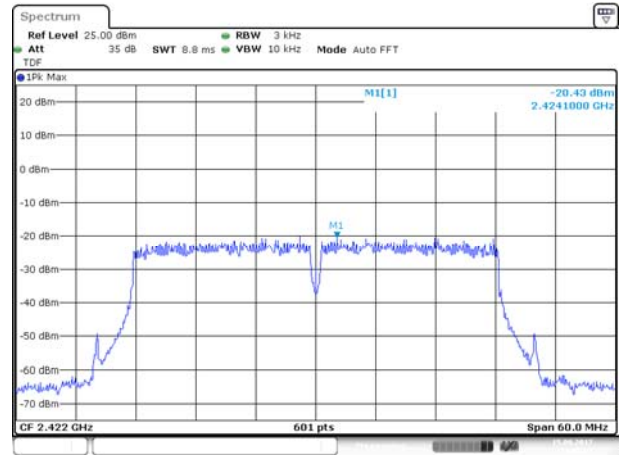

Date: 15 SEP 2017 14:05:02

802.11n-40 MHz MIDDLE CHANNEL

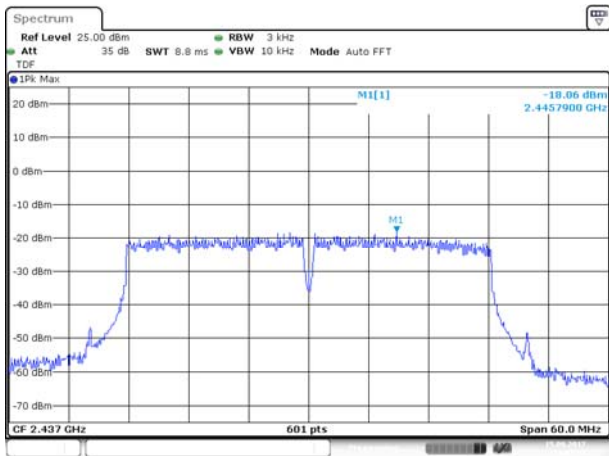

Date: 15 SEP 2017 14:07:30

802.11n-40 MHz HIGH CHANNEL

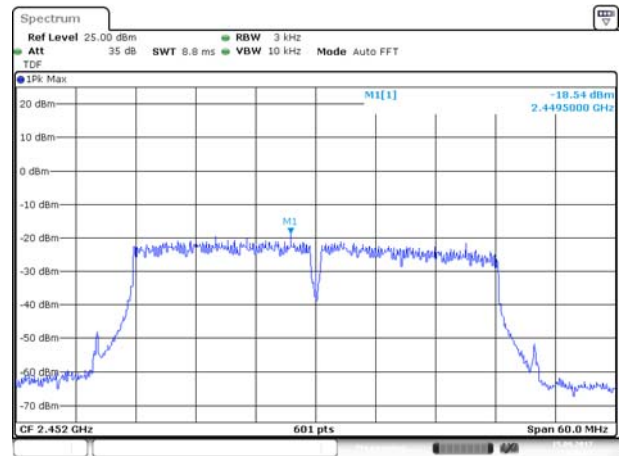

Date: 15 SEP 2017 14:10:08

## **ANNEX B TEST SETUP PHOTOS**

Please refer the document "BL-SZ1790157-AR.pdf".

## **ANNEX C EUT EXTERNAL PHOTOS**

Please refer the document "BL-SZ1790157-AW.pdf".

## **ANNEX D EUT INTERNAL PHOTOS**

Please refer the document "BL-SZ1790157-AI.pdf".

--END OF REPORT--