

FCC Hearing Aid Compatibility (HAC) RF Emission Test Report

Product Name : Smartphone
Model No. : 9788

Applicant : REACH Tech (Xiamen) Co., Ltd
Address : Rm.501, #51, Wanghai Road, Software ParkII, Xiamen, PRC

Date of Receipt : 2013/06/06
Issued Date : 2013/07/04
Report No. : 136148R-HPUSP09V01-A
Report Version : V1.0



The test results relate only to the samples tested.

The test report shall not be reproduced except in full without the written approval of Quietek Corporation.

Test Report Certification

Issued Date: 2013/07/04

Report No.:136148R-HPUSP09V01-A



Product Name : Smartphone
 Applicant : REACH Tech (Xiamen) Co., Ltd
 Address : Rm.501, #51, Wanghai Road, Software ParkII, Xiamen, PRC
 Manufacturer : REACH Tech (Xiamen) Co., Ltd
 Model No. : 9788
 FCC ID : Z5JREACH-9788
 Applicable Standard : 47CFR § 20.19
 ANSI C63.19 2011
 M Category : M3
 Application Type : Certification

The test results relate only to the samples tested.
 The test report shall not be reproduced except in full without the written approval of Quietek Corporation.

Documented By : 

 (Adm. Specialist / April Chen)

Tested By : 

 (Engineer / Wen Lee)

Approved By : 

 (Manager / Vincent Lin)

TABLE OF CONTENTS

Description	Page
1. General Information.....	4
1.1 EUT Description	4
1.2 Test Environment	5
2. HAC Measurement System	6
2.1 DASY5 System Description	6
2.2 HAC Probe	7
2.2.1 HAC E-Field Probe Specification.....	7
2.3 Boundary Detection Unit and Probe Mounting Device	8
2.4 DATA Acquisition Electronics (DAE) and Measurement Server	8
2.5 Robot.....	9
2.6 Light Beam Unit.....	9
2.7 Device Holder	9
2.8 Test Arch Phantom.....	10
3. System Check.....	11
3.1 Dipole Kit.....	11
3.2 System Check.....	12
3.3 System Check Results	12
4. Measurement Description	13
4.1 RF Emission Measurements Reference and Plane.....	13
4.2 Near-Field Emission Automated Test Flowchart.....	14
4.3 Test Procedure Description	15
4.4 Modulation interference factor.....	16
5. HAC RF Emission Limits.....	17
6. Test Equipment List.....	18
7. Measurement Uncertainty.....	19
8. Test Results	20
8.1 HAC RF Emission Test Results Summary.....	20
Appendix.....	21
Appendix A. HAC System Check Data	
Appendix B. HAC RF Emission Measurement Data	
Appendix C. Test Setup Photographs & EUT Photographs	
Appendix D. HAC Probe Calibration Data	
Appendix E. HAC Dipole Calibration Data	

1. General Information

1.1 EUT Description

Product Name	Smartphone
Model No.	9788
FCC ID	Z5JREACH-9788
TX Frequency	GSM 850/WCDMA Band V : 824MHz~849MHz PCS 1900/WCDMA Band II : 1850MHz ~1910MHz WCDMA Band IV : 1710MHz ~1755MHz
RX Frequency	GSM 850/WCDMA Band V : 824MHz~849MHz PCS 1900/WCDMA Band II : 1850MHz ~1910MHz WCDMA Band IV : 2110MHz ~2155MHz
Device Category	Portable
RF Exposure Environment	Uncontrolled
Max. Peak Output Power (Conducted)	GSM 850: 32.06dBm ; PCS 1900: 29.20dBm WCDMA Band II: 22.81dBm ; WCDMA Band IV: 22.51dBm WCDMA Band V: 23.19dBm

Note: Air interface as below

Air interface	frequency	Type	C63.19	Simultaneous	VoIP	VoLTE
GSM	850	Voice	Yes (2011)	WLAN/BT	N/A	N/A
GSM	1900	Voice	Yes (2011)	WLAN/BT	N/A	N/A
WCDMA	II-850	Voice	Yes (2011)	WLAN/BT	N/A	N/A
WCDMA	IV-1700	Voice	Yes (2011)	WLAN/BT	N/A	N/A
WCDMA	V-1900	Voice	Yes (2011)	WLAN/BT	N/A	N/A
GSM	850	Data	N/A	WLAN/BT	Yes	N/A
GSM	1900	Data	N/A	WLAN/BT	Yes	N/A
WCDMA	II-850	Data	N/A	WLAN/BT	Yes	N/A
WCDMA	IV-1700	Data	N/A	WLAN/BT	Yes	N/A
WCDMA	V-1900	Data	N/A	WLAN/BT	Yes	N/A
BT	2.4G	Data	N/A	WWAN	Yes	N/A
WLAN	2.4G	Data	N/A	WWAN	Yes	N/A

1.2 Test Environment

Ambient conditions in the laboratory:

Items	Required	Actual
Temperature (°C)	18-25	22
Humidity (%RH)	30-70	56

Site Description:

Accredited by TAF
Accredited Number: 0914
Effective through: December 12, 2014

Site Name: Quietek Corporation

Site Address: No. 5-22, Rueishu Keng, Linkou Dist.,
New Taipei City 24451,
Taiwan. R.O.C.
TEL: 886-2-8601-3788 / FAX: 886-2-8601-3789
E-Mail: service@quietek.com

2. HAC Measurement System

2.1 DASY5 System Description

The purpose of the Hearing Aid Compatibility extension is to enable measurements of the near electric and magnetic fields generated by wireless communication devices in the region controlled for use by a hearing aid in accordance with ANSI C63.19-2011 and magnetic fields of a wireless device are scanned with free-space probes (e.g., ER3DVX) in a 5 by 5 cm area parallel above the acoustic point. The scanning distance from the device surface depends on the standard version (for ANSI C63.19-2011 15mm from the probe sensor center). The maximum field values in 9 sub-grids of the electrical and a magnetic field scan are evaluated automatically according to the rules defined in the standard and result in a specific “M-class”.

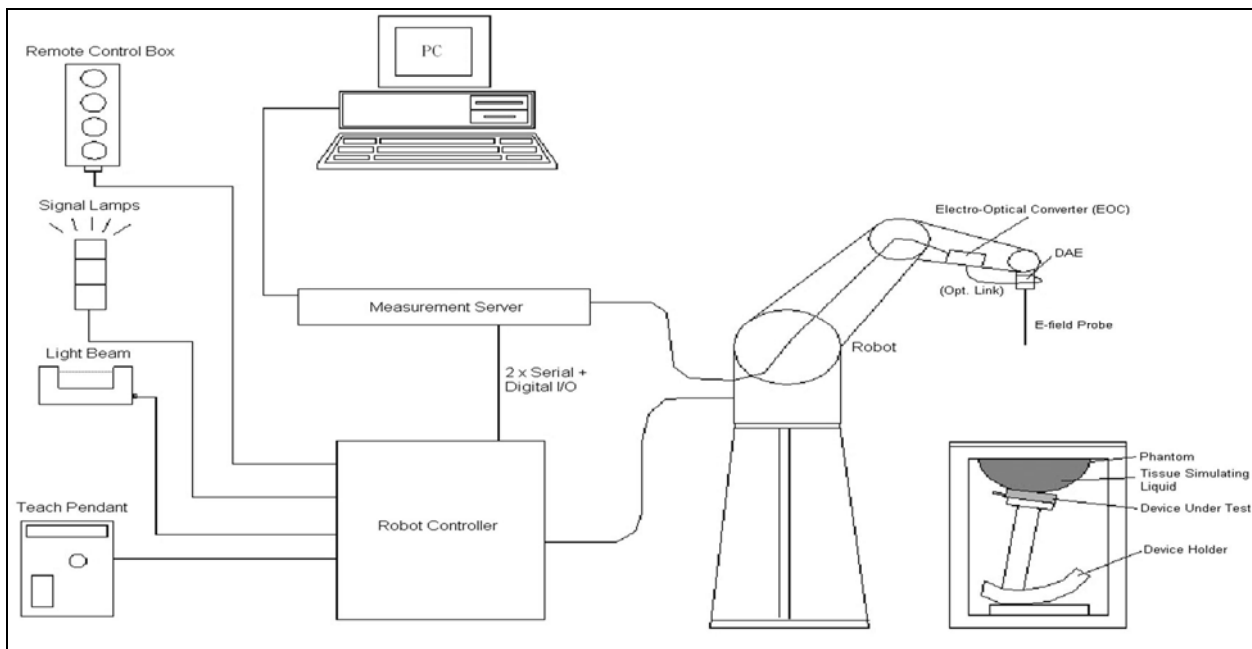

The DASY5 system for performing compliance tests consists of the following items:

- A standard high precision 6-axis robot with controller, teach pendant and software. An arm extension for accommodating the data acquisition electronics (DAE).
- A data acquisition electronics (DAE) which performs the signal amplification, signal multiplexing, AD-conversion, offset measurements, mechanical surface detection, collision detection, etc. The unit is battery powered with standard or rechargeable batteries. The signal is optically transmitted to the EOC.
- The Electro-optical converter (EOC) performs the conversion from optical to electrical signals for the digital communication to the DAE. To use optical surface detection, a

special version of the EOC is required. The EOC signal is transmitted to the measurement server.

- The Light Beam used is for probe alignment. This improves the (absolute) accuracy of the probe positioning.
- A computer running WinXP and the DASY5 software.
- Remote control and teach pendant as well as additional circuitry for robot safety such as warning lamps, etc.
- The Arch phantom, the device holder and other accessories according to the targeted measurement.

2.2 HAC Probe

The E-field free space probe (ER3DV6) needs to be calibrated for the respective signal such that the true time-average RMS value is obtained independent of the field strength. The calibration data are in Appendix D.

2.2.1 HAC E-Field Probe Specification

Model	ER3DV6	
Construction	One dipole parallel, two dipoles normal to probe axis Built-in shielding against static charges	
Frequency	100MHz to 6GHz; Linearity: ± 0.2dB (100MHz to 3GHz)	
Directivity	± 0.2dB in air (rotation around probe axis) ± 0.4dB in air (rotation normal to probe axis)	
Dynamic Range	2V/m to 1000V/m (M3 or better device readings fall well below diode compression point) Linearity: ± 0.2dB	
Dimensions	Overall length: 330mm (Tip: 16mm) Tip diameter: 8mm (Body: 12mm) Distance from probe tip to dipole centers: 2.5mm	

2.3 Boundary Detection Unit and Probe Mounting Device

The DASY probes use a precise connector and an additional holder for the probe, consisting of a plastic tube and a flexible silicon ring to center the probe. The connector at the DAE is flexibly mounted and held in the default position with magnets and springs. Two switching systems in the connector mount detect frontal and lateral probe collisions and trigger the necessary software response.



2.4 DATA Acquisition Electronics (DAE) and Measurement Server

The data acquisition electronics (DAE) consists of a highly sensitive electrometer-grade preamplifier with auto-zeroing, a channel and gain-switching multiplexer, a fast 16 bit AD-converter and a command decoder and control logic unit. Transmission to the measurement server is accomplished through an optical downlink for data and status information as well as an optical uplink for commands and the clock. The input impedance of the DAE4 is 200M Ohm; the inputs are symmetrical and floating. Common mode rejection is above 80dB.



The DASY5 measurement server is based on a PC/104 CPU board with a 400MHz intel ULV Celeron, 128MB chipdisk and 128MB RAM. The necessary circuits for communication with the DAE electronics box, as well as the 16 bit AD converter system for optical detection and digital I/O interface are contained on the DASY5 I/O board, which is directly connected to the PC/104 bus of the CPU board.



2.5 Robot

The DASY5 system uses the high precision robots TX60L type out of the newer series from Stäubli SA (France). For the 6-axis controller DASY5 system, the CS8C robot controller version from Stäubli is used.

The XL robot series have many features that are important for our application:

- High precision (repeatability 0.02 mm)
- High reliability (industrial design)
- Jerk-free straight movements
- Low ELF interference (the closed metallic construction shields against motor control fields)
- 6-axis controller



2.6 Light Beam Unit

The light beam switch allows automatic "tooling" of the probe. During the process, the actual position of the probe tip with respect to the robot arm is measured, as well as the probe length and the horizontal probe offset. The software then corrects all movements, such that the robot coordinates are valid for the probe tip.

The repeatability of this process is better than 0.1 mm. If a position has been taught with an aligned probe, the same position will be reached with another aligned probe within 0.1 mm, even if the other probe has different dimensions. During probe rotations, the probe tip will keep its actual position.



2.7 Device Holder

The HAC device holder is made from SPEAG. The holder supports accurate and reliable positioning of any phone effect on near field $\pm 0.5\text{dB}$. It is used to adjust DUT to suitable position.



2.8 Test Arch Phantom

The HAC Test Arch phantom is used with several sections, each considering the different vertical distances of the DUT or the dipole as well as the different sensor offsets of the E- and H-Field probes. The Test Arch phantom V4.8 includes a single predefined RF phantom section (V4.9 also a TCoil section).





Model	Arch Phantom V 4.9
Dimensions	370 x 370 x 370mm

3. System Check

3.1 Dipole Kit

Model	CD835V3	
Frequency Band	800 ~ 960MHz (free space)	
Return Loss	> 15dB	
Calibration	835MHz (Appendix E)	
Power Capability	50W continuous	
Dimensions	Length: 166mm Height: 330mm	

Model	CD1880V3	
Frequency Band	1710 ~ 2000MHz (free space)	
Return Loss	> 18dB	
Calibration	1880MHz (Appendix E)	
Power Capability	50W continuous	
Dimensions	Length: 80.8mm Height: 330mm	

Model	CD2450V3	
Frequency Band	2250 ~ 2650MHz (free space)	
Return Loss	> 18dB	
Calibration	2450MHz (Appendix E)	
Power Capability	50W continuous	
Dimensions	Length: 59.9mm Height: 330mm	

3.2 System Check

The manufacturer calibrates the probes annually. The HAC measurements of the device were done within 24 hours of system accuracy verification, which was done using calibration dipoles. Unmodulated continuous wave of power level of 20dBm was supplied to a dipole antenna placed under Test Arch. The measurement probes are positioned over the illuminated dipole at 15mm distance from the top surface of the dipole element to the calibration reference point of the sensor, defined by the probe manufacturer.

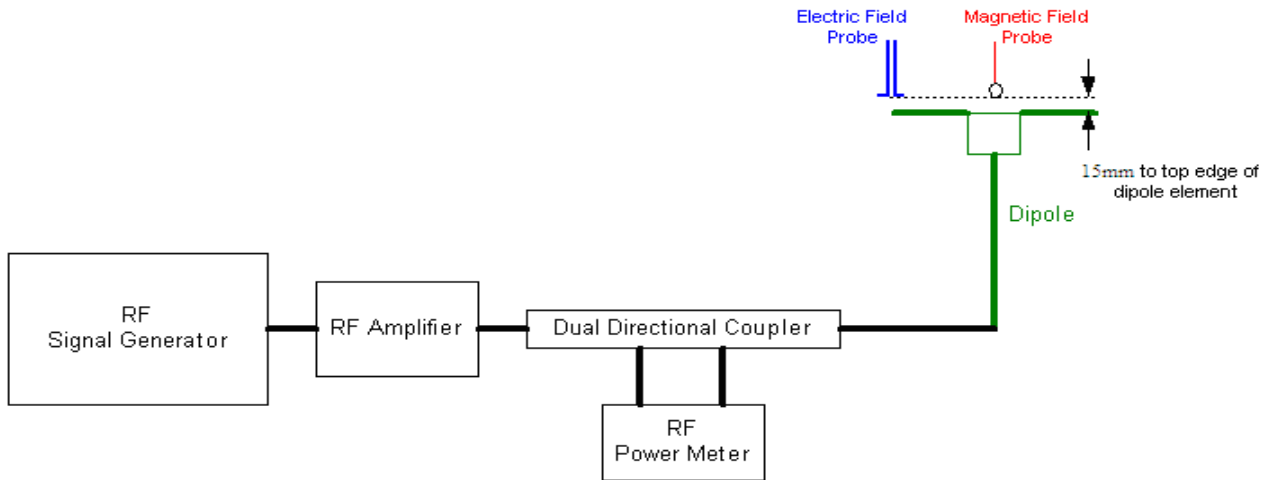

3.3 System Check Results

HAC System Check						
Frequency [MHz]	Input Power (dBm)	Target E-Field (V/m)	Measured E-Field (V/m)		Deviation (%)	Date
			E-Field 1	E-field 2		
835	20	109.1	113.8	105	0.3	2013/07/04
1880	20	91.2	91.63	90.35	-0.23	2013/07/04

1. The measured values were compared with the values provided by the probe manufacturer and must within the allowed tolerance of 25%
2. The deviation is $((E\text{-field } 1 + E\text{-field } 2) / 2 - \text{Target E-field}) / \text{Target E-field} * 100\%$

4. Measurement Description

4.1 RF Emission Measurements Reference and Plane

The figure as below illustrates the references and reference plane that shall be used in the EUT emissions measurement:

- The grid is 5 cm by 5 cm area that is divided into 9 evenly sized blocks or sub-grids.
- The grid is centered on the audio frequency output transducer (speaker) of the EUT.
- The grid is in a reference plane, which is defined as the planar area that contains the highest point in the area of the phone that normally rests against the user's ear. It is parallel to the centerline of the receiver of the EUT and is defined by the points of the receiver-end of the EUT, which, in normal handset use, rest against the ear.
- The measurement plane is parallel to, and 1.5 cm in front of, the reference plane.

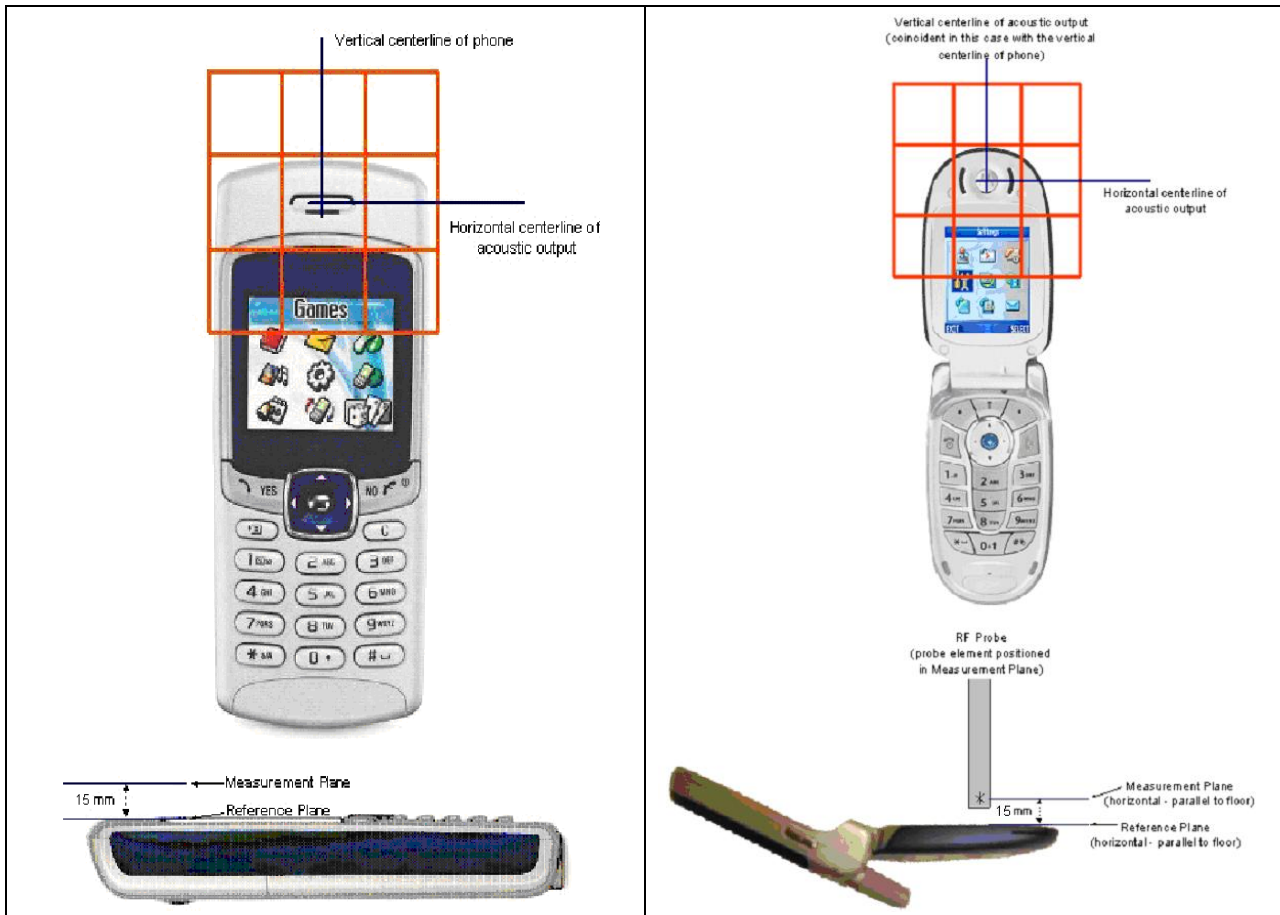

4.2 Near-Field Emission Automated Test Flowchart

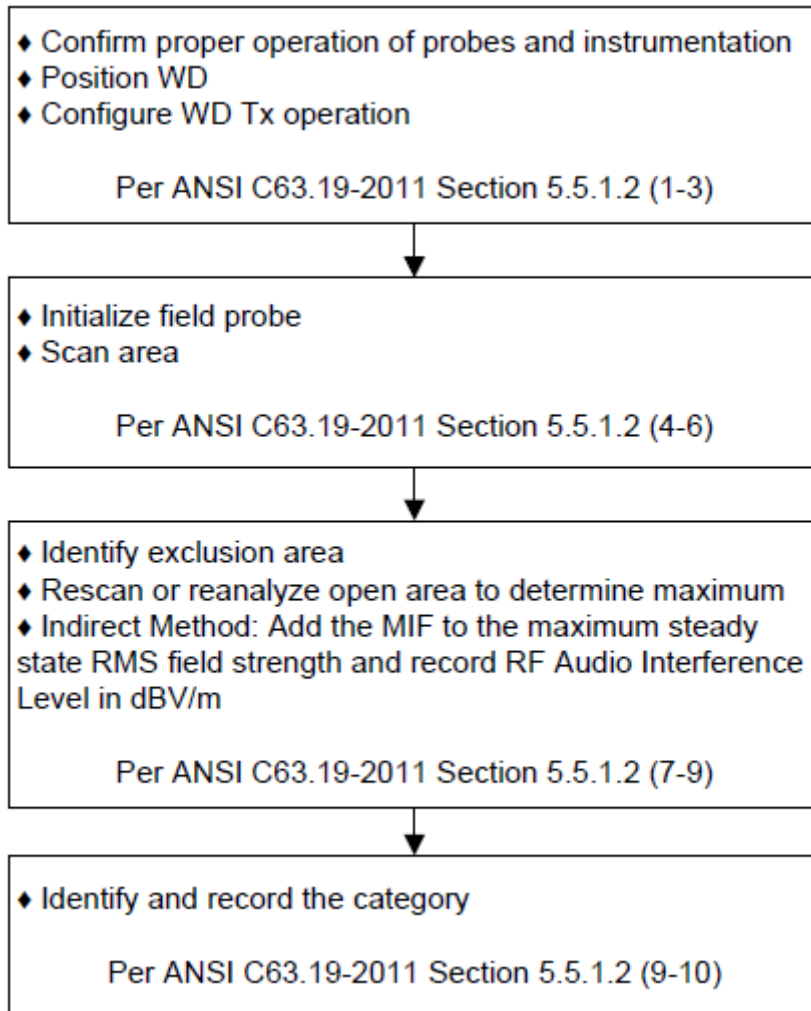

4.3 Test Procedure Description

The following illustrate a typical RF emission test scan over a wireless communication device:

1. Proper operation of the field probe, probe measurement system, other instrumentation, and the positioning system was confirmed.
2. Position the WD in its intended test position, acoustic output point of the device perpendicular to the field probe.
3. The WD operation for maximum rated RF output power was configured and confirmed with the base station simulator, at the test channel and other normal operating parameters as intended for the test. Ensure battery is fully charged before each test.
4. The center sub-grid was centered over the center of the acoustic output (also audio band magnetic output, if applicable). The WD audio output was positioned tangent (as physically possible) to the measurement plane.
5. A surface calibration was performed before each setup change to ensure repeatable spacing and proper maintenance of the measurement plane using the HAC arch.
6. The measurement system measured the field strength at the reference location.
7. Measurements at 2mm or 5mm increments in the 5x 5cm region were performed at a distance 15 mm from the center point of the probe measurement element to the WD. A 360° rotation about the azimuth axis at the maximum interpolated position was measured. For the worst-case condition, the peak reading from this rotation was used in re-evaluating the HAC category.
8. The system performed a drift evaluation by measuring the field at the reference location.

4.4 Modulation interference factor

For any specific fixed and repeatable modulated signal, a modulation interference factor (MIF, expressed in dB) may be developed that relates its interference potential to its steady-state rms signal level or average power level. This factor is a function only of the audio-frequency amplitude modulation characteristics of the signal and is the same for field-strength and conducted power measurements. It is important to emphasize that the MIF is valid only for a specific repeatable audio-frequency amplitude modulation characteristic. Any change in modulation characteristic requires determination and application of a new MIF.

The MIF may be determined using a radiated RF field, a conducted RF signal, or in a preliminary stage, a mathematical analysis of a modeled RF signal:

- a) For the probe and instrumentation included in the measurement of MIF, additional calibration and application of calibration factors are not required.
- b) Using RF illumination or conducted coupling, apply the specific modulated signal in question to the measurement system at a level within its confirmed operating dynamic range.
- c) Measure the steady-state rms level at the output of the fast probe or sensor.
- d) Measure the steady-state average level at the weighting output.
- e) Without changing the square-law detector or weighting system, and using RF illumination or conducted coupling, substitute for the specific modulated signal a 1 kHz, 80% amplitude modulated carrier at the same frequency and adjust its strength until the level at the weighting output equals the step d) measurement.
- f) Without changing the carrier level from step e), remove the 1 kHz modulation and again measure the steady-state rms level indicated at the output of the fast probe or sensor.
- g) The MIF for the specific modulation characteristic is provided by the ratio of the step f) measurement to the step c) measurement, expressed in dB ($20 \times \log(\text{step f})/\text{step c}$)).

The following table lists evaluated by speag, can refer the calibration report in Appendix D

UID	Communcation System	MIF
10021	GSM-FDD(TDMA,GMSK)	3.63
10011	UMTS-FCC(WCDMA)	-27.23

5. HAC RF Emission Limits

The ANSI Standard presents performance requirements for acceptable interoperability of hearing aids with wireless communications devices. When these parameters are met, a hearing aid operates acceptably in close proximity to a wireless communications device.

TELEPHONE RF PARAMETERS < 960MHz	
CATEGORY NEAR FIELD	E-FIELD EMISSION CW
	(dBV/m)
M1	50.0 to 66.0
M2	45.0 to 50.0
M3	40.0 to 45
M4	< 40
TELEPHONE RF PARAMETERS >960MHz	
M1	40.0 to 45.0
M2	35.0 to 40.0
M3	30.0 to 35.0
M4	< 30.0

6. Test Equipment List

Instrument	Manufacturer	Model No.	Serial No.	Last Calibration	Next Calibration
Stäubli Robot TX60L	Stäubli	TX60L	F09/5BL1A1/A06	2009/05/18	only once
Controller	Speaq	CS8c	N/A	2009/05/18	only once
Test Arch Phantom	Speaq	SD HAC P01 BB	1118	N/A	N/A
Speaq Reference Dipole 835MHz	Speaq	CD835V3	1135	2013/05/29	2015/05/28
Speaq Reference Dipole 1900MHz	Speaq	CD1880V3	1117	2013/05/29	2015/05/28
SAM Twin Phantom	Speaq	QD000 P40 CA	Tp 1515	N/A	N/A
Device Holder	Speaq	N/A	N/A	N/A	N/A
Data Acquisition Electronic	Speaq	DAE4	1207	2013/05/22	2014/05/21
E-Field Probe	Speaq	ER3DV6	2466	2013/05/29	2015/05/28
SAR Software	Speaq	DASY52	Version 52.8 (5)	N/A	N/A
Aprél Dipole Spaccer	Aprél	ALS-DS-U	QTK-295	N/A	N/A
Power Amplifier	Mini-Circuit	ZHL-42	D051404-20	N/A	N/A
Directional Coupler	Agilent	778D-012	50550	N/A	N/A
Universal Radio Communication Tester	R&S	CMU 200	104846	2013/05/09	2014/05/08
Vector Network	Anritsu	MS4623B	992801	2012/07/30	2013/07/29
Signal Generator	Anritsu	MG3694A	041902	2012/08/03	2013/08/02
Power Meter	Anritsu	ML2487A	6K00001447	2012/12/15	2013/12/14
Wide Bandwidth Sensor	Anritsu	MA2491A	034457	2012/12/17	2013/12/16

7. Measurement Uncertainty

HAC Uncertainty Budget							
According to ANSI C63.19							
Error Description	Uncert. value	Prob. Dist.	Div.	(ci) E	(ci) H	Std. Unc. E	Std. Unc. H
Measurement System							
Probe Calibration	±5.1%	N	1	1	1	±5.1%	±5.1%
Axial Isotropy	±4.7%	R	$\sqrt{3}$	1	1	±2.7%	±2.7%
Sensor Displacement	±16.5%	R	$\sqrt{3}$	1	0.145	±9.5%	±1.4%
Boundary Effects	±2.4%	R	$\sqrt{3}$	1	1	±1.4%	±1.4%
Phantom Boundary Effect	±7.2%	R	$\sqrt{3}$	1	0	±4.1%	±0.0%
Linearity	±4.7%	R	$\sqrt{3}$	1	1	±2.7%	±2.7%
Scaling with PMR calibration	±10.0%	R	$\sqrt{3}$	1	1	±5.8%	±5.8%
System Detection Limit	±1.0%	R	$\sqrt{3}$	1	1	±0.6%	±0.6%
Readout Electronics	±0.3%	N	$\sqrt{3}$	1	1	±0.3%	±0.3%
Response Time	±0.8%	R	$\sqrt{3}$	1	1	±0.5%	±0.5%
Integration Time	±2.6%	R	$\sqrt{3}$	1	1	±1.5%	±1.5%
RF Ambient Conditions	±3.0%	R	$\sqrt{3}$	1	1	±1.7%	±1.7%
RF Reflections	±12.0%	R	$\sqrt{3}$	1	1	±6.9%	±6.9%
Probe Positioner	±1.2%	R	$\sqrt{3}$	1	0.67	±0.7%	±0.5%
Probe Positioning	±4.7%	R	$\sqrt{3}$	1	0.67	±2.7%	±1.8%
Extrap. and Interpolation	±1.0%	R	$\sqrt{3}$	1	1	±0.6%	±0.6%
Test Sample Related							
Device Positioning Vertical	±4.7%	R	$\sqrt{3}$	1	0.67	±2.7%	±1.8%
Device Positioning Lateral	±1.0%	R	$\sqrt{3}$	1	1	±0.6%	±0.6%
Device Holder and Phantom	±2.4%	R	$\sqrt{3}$	1	1	±1.4%	±1.4%
Power Drift	±5.0%	R	$\sqrt{3}$	1	1	±2.9%	±2.9%
Phantom and Setup Related							
Phantom Thickness	±2.4%	R	$\sqrt{3}$	1	0.67	±1.4%	±0.9%
Combined Std. Uncertainty						±16.3%	±12.3%
Expanded Std. Uncertainty on Power						±32.6%	±24.6%
Expanded Std. Uncertainty on Field						±16.3%	±12.3%

8. Test Results

8.1 HAC RF Emission Test Results Summary

HAC MEASUREMENT						
Product: Smartphone						
Test Mode: E-Field						
Test Band	Antenna Position	Frequency		Conducted Power (dBm)	Peak E-Field(dBV/m)	Rating
		Channel	MHz			
850	Fixed	128	824.2	31.88	41.60	M3
850	Fixed	189	836.4	31.98	41.32	M3
850	Fixed	251	848.8	32.06	41.51	M3
1900	Fixed	512	1850.2	29.07	30.23	M3
1900	Fixed	661	1880	29.16	30.50	M3
1900	Fixed	810	1909.8	29.20	31.08	M3
Band II	Fixed	9262	1852.4	22.48	1.53	M4
Band II	Fixed	9400	1880	22.74	1.50	M4
Band II	Fixed	9538	1907.6	22.81	1.69	M4
Band IV	Fixed	1312	1712.4	22.51	1.07	M4
Band IV	Fixed	1413	1732.6	22.20	1.06	M4
Band IV	Fixed	1513	1752.6	22.47	1.68	M4
Band V	Fixed	4132	826.4	23.03	8.45	M4
Band V	Fixed	4183	836.4	23.11	8.88	M4
Band V	Fixed	4233	846.6	23.19	8.71	M4

Appendix**Appendix A. HAC System Check Data****Appendix B. HAC RF Emission Measurement Data****Appendix C. Test Setup Photographs & EUT Photographs****Appendix D. HAC Probe Calibration Data****Appendix E. HAC Dipole Calibration Data**

Appendix A. HAC System Check Data

Test Laboratory: QuieTek

Date/Time: 7/4/2013

835-2

DUT: HAC-Dipole 835 MHz; Type: D835V3

Communication System: CW; Frequency: 835 MHz; Communication System PAR: 0 dB

Medium parameters used: $\sigma = 0$ S/m, $\epsilon_r = 1$; $\rho = 1000$ kg/m³

Phantom section: RF Section

Measurement Standard: DASYS (IEEE/IEC/ANSI C63.19-2007)

DASY5 Configuration:

- Probe: ER3DV6 - SN2466; ConvF(1, 1, 1); Calibrated: 5/29/2013;
- Sensor-Surface: (Fix Surface)
- Electronics: DAE4 Sn1207; Calibrated: 5/22/2013
- Phantom: HAC Test Arch with AMCC; Type: SD HAC P01 BA;
- Measurement SW: DASYS2, Version 52.8 (5); SEMCAD X Version 14.6.8 (7028)

CD835 /Hearing Aid Compatibility Test at 15mm distance (41x361x1):

Interpolated grid: dx=0.5000 mm, dy=0.5000 mm

Device Reference Point: 0, 0, -6.3 mm

Reference Value = 117.3 V/m; Power Drift = -0.03 dB

PMR not calibrated. PMF = 1.000 is applied.

E-field emissions = 113.8 V/m

Near-field category: M4 (AWF 0 dB)

PMF scaled E-field

Grid 1 M4 109.6 V/m	Grid 2 M4 113.8 V/m	Grid 3 M4 112.9 V/m
Grid 4 M4 61.59 V/m	Grid 5 M4 62.88 V/m	Grid 6 M4 62.34 V/m
Grid 7 M4 102.3 V/m	Grid 8 M4 105.0 V/m	Grid 9 M4 103.6 V/m

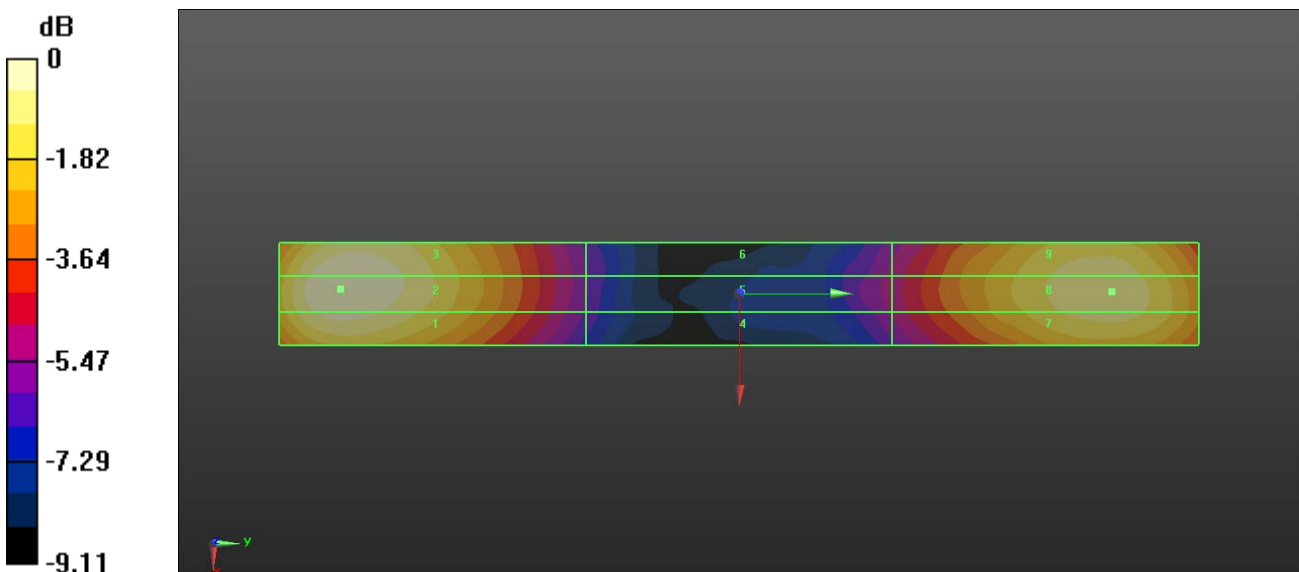

0 dB = 113.8 V/m = 41.12 dBV/m

Test Laboratory: QuieTek

Date/Time: 7/4/2013

1900

DUT: HAC Dipole 1880 MHz; Type: CD1880V3

Communication System: CW; Frequency: 1880 MHz; Communication System PAR: 0 dB

Medium parameters used: $\sigma = 0$ S/m, $\epsilon_r = 1$; $\rho = 1000$ kg/m³

Phantom section: RF Section

Measurement Standard: DASYS (IEEE/IEC/ANSI C63.19-2007)

DASY5 Configuration:

- Probe: ER3DV6 - SN2466; ConvF(1, 1, 1); Calibrated: 5/29/2013;
- Sensor-Surface: (Fix Surface)
- Electronics: DAE4 Sn1207; Calibrated: 5/22/2013
- Phantom: HAC Test Arch with AMCC; Type: SD HAC P01 BA;
- Measurement SW: DASYS2, Version 52.8 (5); SEMCAD X Version 14.6.8 (7028)

CD 1900/Hearing Aid Compatibility Test at 15mm distance (41x181x1):

Interpolated grid: dx=0.5000 mm, dy=0.5000 mm

Device Reference Point: 0, 0, -6.3 mm

Reference Value = 140.0 V/m; Power Drift = -0.06 dB

PMR not calibrated. PMF = 1.000 is applied.

E-field emissions = 91.63 V/m

Near-field category: M3 (AWF 0 dB)

PMF scaled E-field

Grid 1 M3 88.48 V/m	Grid 2 M3 91.63 V/m	Grid 3 M3 90.64 V/m
Grid 4 M3 69.68 V/m	Grid 5 M3 72.04 V/m	Grid 6 M3 71.64 V/m
Grid 7 M3 88.15 V/m	Grid 8 M3 90.35 V/m	Grid 9 M3 88.60 V/m

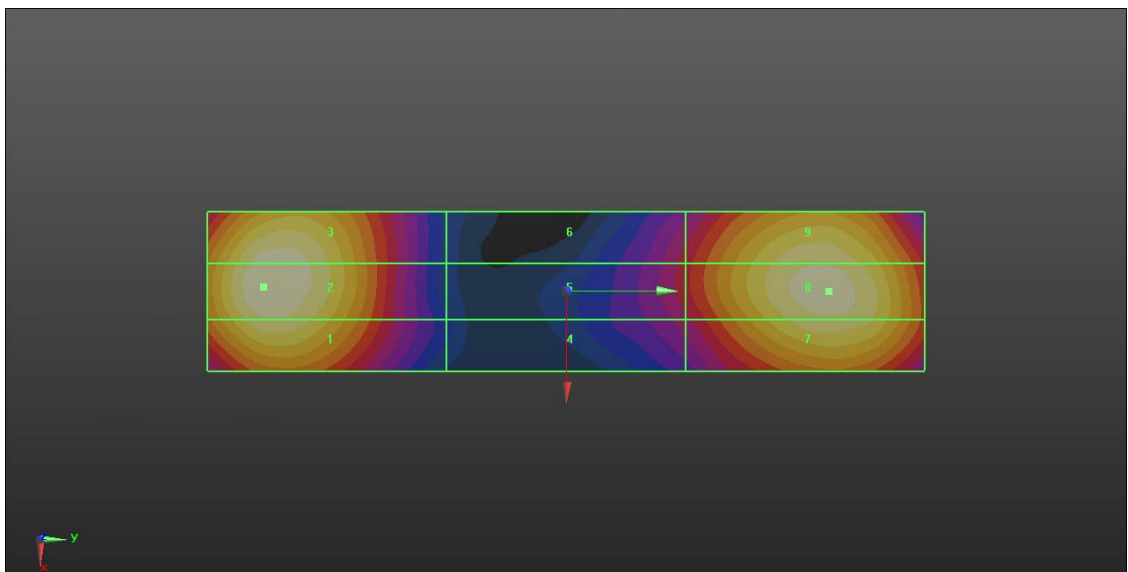

0 dB = 91.63 V/m = 39.24 dBV/m

Appendix B. HAC RF Emission Measurement Data

Test Laboratory: QuieTek

Date/Time: 7/2/2013

GSM 850 CH128

DUT: Smartphone; Type: 9788

Communication System: GSM-FDD (TDMA, GMSK); Frequency: 824.2

MHz; Communication System PAR: 9.39 dB

Medium parameters used: $\sigma = 0$ S/m, $\epsilon_r = 1$; $\rho = 1000$ kg/m³

Phantom section: RF Section

Measurement Standard: DASYS (IEEE/IEC/ANSI C63.19-2011)

DASY5 Configuration:

- Probe: ER3DV6 - SN2466; ConvF(1, 1, 1); Calibrated: 5/29/2013;
- Sensor-Surface: (Fix Surface)
- Electronics: DAE4 Sn1207; Calibrated: 5/22/2013
- Phantom: HAC Test Arch with AMCC; Type: SD HAC P01 BA;
- Measurement SW: DASYS2, Version 52.8 (5); SEMCAD X Version 14.6.8 (7028)

CH128/Hearing Aid Compatibility Test (101x101x1): Interpolated grid: dx=0.5000 mm, dy=0.5000 mm

Device Reference Point: 0, 0, -6.3 mm

Reference Value = 103.0 V/m; Power Drift = -0.07 dB

Applied MIF = 3.63 dB

RF audio interference level = 41.60 dBV/m

Emission category: M3

MIF scaled E-field

Grid 1 M3 40.49 dBV/m	Grid 2 M3 41.35 dBV/m	Grid 3 M3 41.04 dBV/m
Grid 4 M3 40.77 dBV/m	Grid 5 M3 41.6 dBV/m	Grid 6 M3 41.25 dBV/m
Grid 7 M3 40.82 dBV/m	Grid 8 M3 41.39 dBV/m	Grid 9 M3 40.97 dBV/m

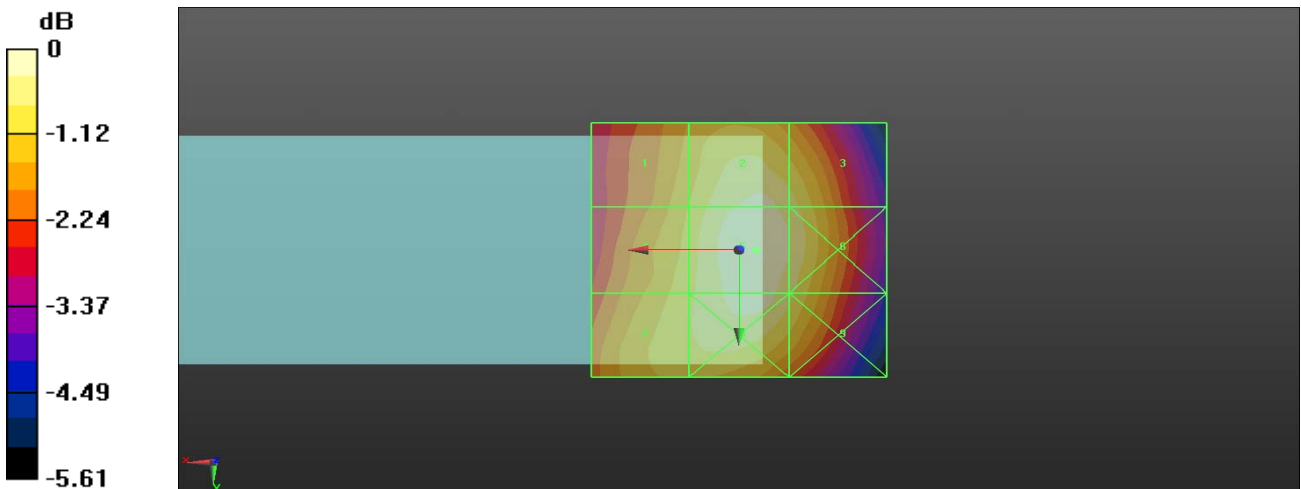

0 dB = 120.2 V/m = 41.60 dBV/m

Test Laboratory: QuieTek

Date/Time: 7/2/2013

GSM 850 CH189

DUT: Smartphone; Type: 9788

Communication System: GSM-FDD (TDMA, GMSK); Frequency: 836.6

MHz; Communication System PAR: 9.39 dB

Medium parameters used: $\sigma = 0$ S/m, $\epsilon_r = 1$; $\rho = 1000$ kg/m³

Phantom section: RF Section

Measurement Standard: DASYS (IEEE/IEC/ANSI C63.19-2011)

DASY5 Configuration:

- Probe: ER3DV6 - SN2466; ConvF(1, 1, 1); Calibrated: 5/29/2013;
- Sensor-Surface: (Fix Surface)
- Electronics: DAE4 Sn1207; Calibrated: 5/22/2013
- Phantom: HAC Test Arch with AMCC; Type: SD HAC P01 BA;
- Measurement SW: DASYS2, Version 52.8 (5); SEMCAD X Version 14.6.8 (7028)

CH189/Hearing Aid Compatibility Test (101x101x1): Interpolated grid: dx=0.5000 mm, dy=0.5000 mm

Device Reference Point: 0, 0, -6.3 mm

Reference Value = 97.41 V/m; Power Drift = 0.12 dB

Applied MIF = 3.63 dB

RF audio interference level = 41.32 dBV/m

Emission category: M3

MIF scaled E-field

Grid 1 M4 39.92 dBV/m	Grid 2 M3 41.16 dBV/m	Grid 3 M3 40.96 dBV/m
Grid 4 M3 40.44 dBV/m	Grid 5 M3 41.32 dBV/m	Grid 6 M3 41.16 dBV/m
Grid 7 M3 40.54 dBV/m	Grid 8 M3 41.14 dBV/m	Grid 9 M3 40.9 dBV/m

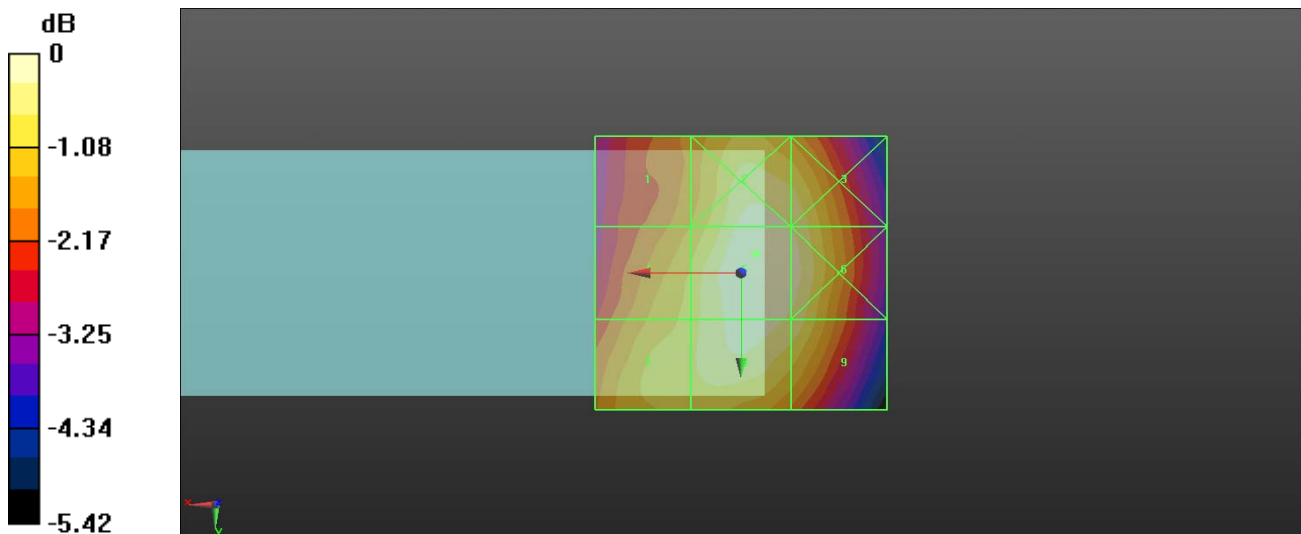

0 dB = 116.5 V/m = 41.33 dBV/m

Test Laboratory: QuieTek

Date/Time: 7/2/2013

GSM 850 CH251

DUT: Smartphone; Type: 9788

Communication System: GSM-FDD (TDMA, GMSK); Frequency: 848.6

MHz; Communication System PAR: 9.39 dB

Medium parameters used: $\sigma = 0$ S/m, $\epsilon_r = 1$; $\rho = 1000$ kg/m³

Phantom section: RF Section

Measurement Standard: DASYS (IEEE/IEC/ANSI C63.19-2011)

DASY5 Configuration:

- Probe: ER3DV6 - SN2466; ConvF(1, 1, 1); Calibrated: 5/29/2013;
- Sensor-Surface: (Fix Surface)
- Electronics: DAE4 Sn1207; Calibrated: 5/22/2013
- Phantom: HAC Test Arch with AMCC; Type: SD HAC P01 BA;
- Measurement SW: DASYS2, Version 52.8 (5); SEMCAD X Version 14.6.8 (7028)

CH251/Hearing Aid Compatibility Test (101x101x1): Interpolated grid: dx=0.5000 mm, dy=0.5000 mm

Device Reference Point: 0, 0, -6.3 mm

Reference Value = 102.2 V/m; Power Drift = -0.03 dB

Applied MIF = 3.63 dB

RF audio interference level = 41.51 dBV/m

Emission category: M3

MIF scaled E-field

Grid 1 M3 40.01 dBV/m	Grid 2 M3 41.21 dBV/m	Grid 3 M3 41.03 dBV/m
Grid 4 M3 40.62 dBV/m	Grid 5 M3 41.51 dBV/m	Grid 6 M3 41.29 dBV/m
Grid 7 M3 40.71 dBV/m	Grid 8 M3 41.29 dBV/m	Grid 9 M3 41.05 dBV/m

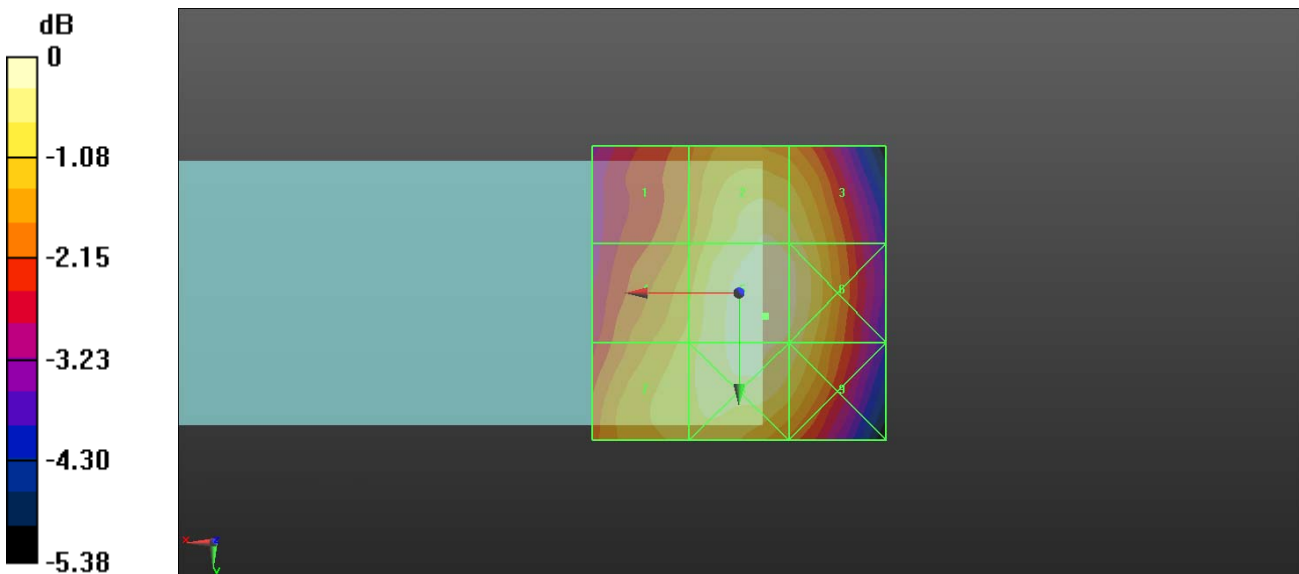

0 dB = 119.0 V/m = 41.51 dBV/m

Test Laboratory: QuieTek

Date/Time: 7/2/2013

PCS 1900 CH512

DUT: Smartphone; Type: 9788

Communication System: GSM-FDD (TDMA, GMSK); Frequency: 1850.2

MHz; Communication System PAR: 9.39 dB

Medium parameters used: $\sigma = 0$ S/m, $\epsilon_r = 1$; $\rho = 1000$ kg/m³

Phantom section: RF Section

Measurement Standard: DASYS (IEEE/IEC/ANSI C63.19-2011)

DASY5 Configuration:

- Probe: ER3DV6 - SN2466; ConvF(1, 1, 1); Calibrated: 5/29/2013;
- Sensor-Surface: (Fix Surface)
- Electronics: DAE4 Sn1207; Calibrated: 5/22/2013
- Phantom: HAC Test Arch with AMCC; Type: SD HAC P01 BA;
- Measurement SW: DASY52, Version 52.8 (5); SEMCAD X Version 14.6.8 (7028)

CH512/Hearing Aid Compatibility Test (101x101x1): Interpolated grid: dx=0.5000 mm, dy=0.5000 mm

Device Reference Point: 0, 0, -6.3 mm

Reference Value = 21.24 V/m; Power Drift = 0.19 dB

Applied MIF = 3.63 dB

RF audio interference level = 30.23 dBV/m

Emission category: M3

MIF scaled E-field

Grid 1 M4 28.68 dBV/m	Grid 2 M4 27.85 dBV/m	Grid 3 M4 27.26 dBV/m
Grid 4 M4 29.8 dBV/m	Grid 5 M3 30.23 dBV/m	Grid 6 M4 29.44 dBV/m
Grid 7 M3 32.06 dBV/m	Grid 8 M3 32.06 dBV/m	Grid 9 M3 30.37 dBV/m

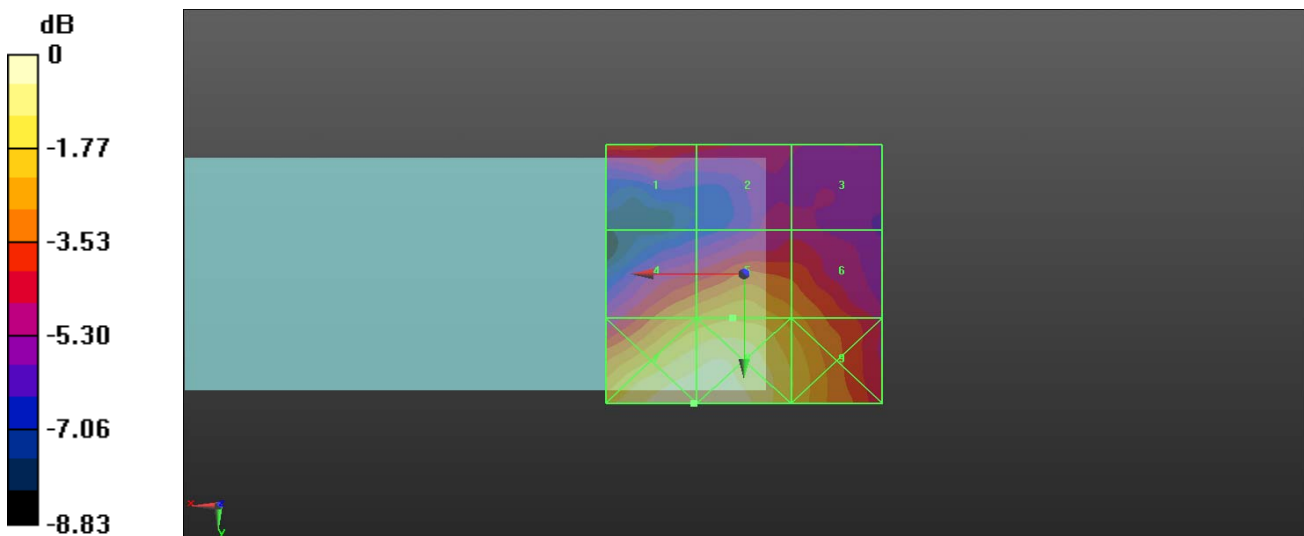

0 dB = 40.11 V/m = 32.07 dBV/m

Test Laboratory: QuieTek

Date/Time: 7/2/2013

PCS 1900 CH661

DUT: Smartphone; Type: 9788

Communication System: GSM-FDD (TDMA, GMSK); Frequency: 1880

MHz; Communication System PAR: 9.39 dB

Medium parameters used: $\sigma = 0$ S/m, $\epsilon_r = 1$; $\rho = 1000$ kg/m³

Phantom section: RF Section

Measurement Standard: DASYS (IEEE/IEC/ANSI C63.19-2011)

DASY5 Configuration:

- Probe: ER3DV6 - SN2466; ConvF(1, 1, 1); Calibrated: 5/29/2013;
- Sensor-Surface: (Fix Surface)
- Electronics: DAE4 Sn1207; Calibrated: 5/22/2013
- Phantom: HAC Test Arch with AMCC; Type: SD HAC P01 BA;
- Measurement SW: DASY52, Version 52.8 (5); SEMCAD X Version 14.6.8 (7028)

CH661/Hearing Aid Compatibility Test (101x101x1): Interpolated grid: dx=0.5000 mm, dy=0.5000 mm

Device Reference Point: 0, 0, -6.3 mm

Reference Value = 21.94 V/m; Power Drift = 0.10 dB

Applied MIF = 3.63 dB

RF audio interference level = 30.50 dBV/m

Emission category: M3

MIF scaled E-field

Grid 1 M4 29.01 dBV/m	Grid 2 M4 28.24 dBV/m	Grid 3 M4 27.63 dBV/m
Grid 4 M4 29.9 dBV/m	Grid 5 M3 30.5 dBV/m	Grid 6 M4 29.74 dBV/m
Grid 7 M3 32.27 dBV/m	Grid 8 M3 32.25 dBV/m	Grid 9 M3 30.6 dBV/m

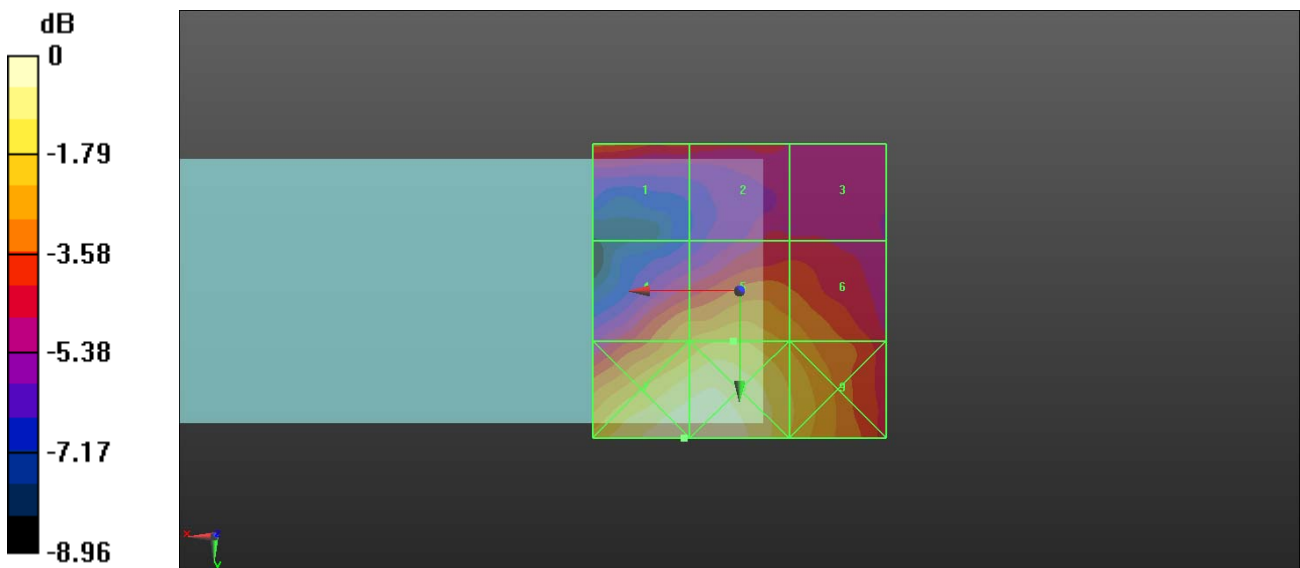

0 dB = 41.05 V/m = 32.27 dBV/m

Test Laboratory: QuieTek

Date/Time: 7/3/2013

PCS 1900 CH810

DUT: Smartphone; Type: 9788

Communication System: GSM-FDD (TDMA, GMSK); Frequency: 1909.8

MHz; Communication System PAR: 9.39 dB

Medium parameters used: $\sigma = 0$ S/m, $\epsilon_r = 1$; $\rho = 1000$ kg/m³

Phantom section: RF Section

Measurement Standard: DASYS (IEEE/IEC/ANSI C63.19-2011)

DASY5 Configuration:

- Probe: ER3DV6 - SN2466; ConvF(1, 1, 1); Calibrated: 5/29/2013;
- Sensor-Surface: (Fix Surface)
- Electronics: DAE4 Sn1207; Calibrated: 5/22/2013
- Phantom: HAC Test Arch with AMCC; Type: SD HAC P01 BA;
- Measurement SW: DASYS2, Version 52.8 (5); SEMCAD X Version 14.6.8 (7028)

CH810/Hearing Aid Compatibility Test (101x101x1): Interpolated grid: dx=0.5000 mm, dy=0.5000 mm

Device Reference Point: 0, 0, -6.3 mm

Reference Value = 24.26 V/m; Power Drift = 0.01 dB

Applied MIF = 3.63 dB

RF audio interference level = 31.08 dBV/m

Emission category: M3

MIF scaled E-field

Grid 1 M3 30.28 dBV/m	Grid 2 M4 29.7 dBV/m	Grid 3 M4 28.9 dBV/m
Grid 4 M3 30.35 dBV/m	Grid 5 M3 31.08 dBV/m	Grid 6 M3 30.84 dBV/m
Grid 7 M3 32.95 dBV/m	Grid 8 M3 32.95 dBV/m	Grid 9 M3 31.8 dBV/m

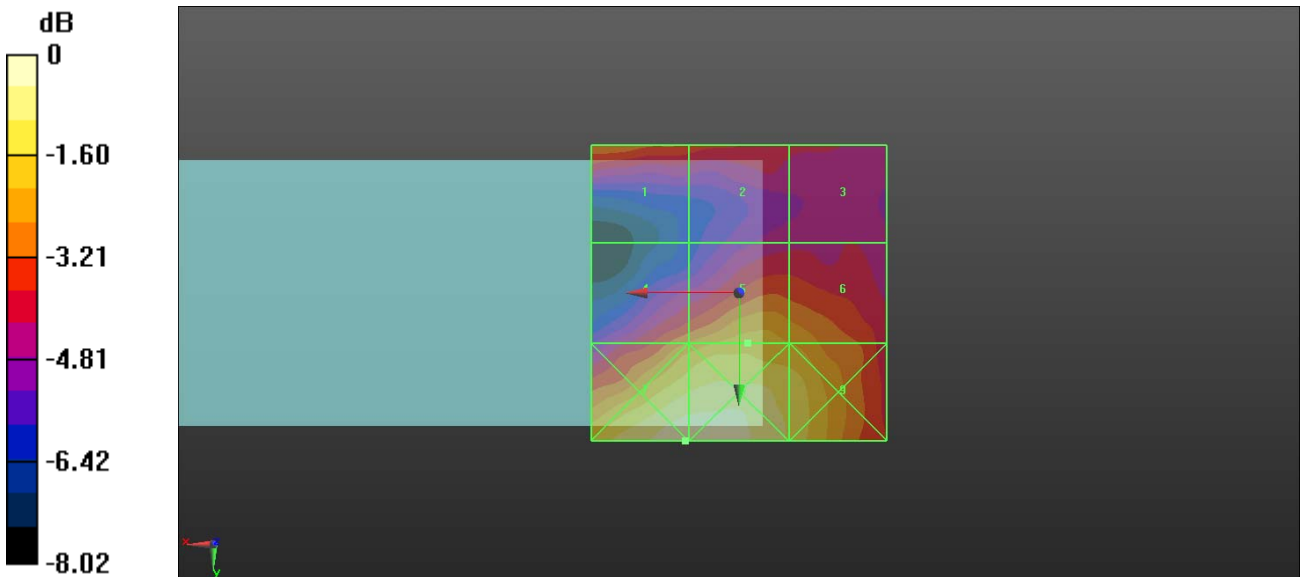

0 dB = 44.39 V/m = 32.95 dBV/m

Test Laboratory: QuieTek

Date/Time: 7/3/2013

Band II CH9262

DUT: Smartphone; Type: 9788

Communication System: UMTS-FDD (WCDMA); Frequency: 1852.4 MHz; Communication System PAR: 2.91 dB

Medium parameters used: $\sigma = 0$ S/m, $\epsilon_r = 1$; $\rho = 1000$ kg/m³

Phantom section: RF Section

Measurement Standard: DASYS (IEEE/IEC/ANSI C63.19-2011)

DASY5 Configuration:

- Probe: ER3DV6 - SN2466; ConvF(1, 1, 1); Calibrated: 5/29/2013;
- Sensor-Surface: (Fix Surface)
- Electronics: DAE4 Sn1207; Calibrated: 5/22/2013
- Phantom: HAC Test Arch with AMCC; Type: SD HAC P01 BA;
- Measurement SW: DASYS2, Version 52.8 (5); SEMCAD X Version 14.6.8 (7028)

CH9262/Hearing Aid Compatibility Test (101x101x1): Interpolated grid:

dx=0.5000 mm, dy=0.5000 mm

Device Reference Point: 0, 0, -6.3 mm

Reference Value = 28.26 V/m; Power Drift = -0.02 dB

Applied MIF = -27.23 dB

RF audio interference level = 1.53 dBV/m

Emission category: M4

MIF scaled E-field

Grid 1 M4 0.33 dBV/m	Grid 2 M4 0.02 dBV/m	Grid 3 M4 -1 dBV/m
Grid 4 M4 1.11 dBV/m	Grid 5 M4 1.53 dBV/m	Grid 6 M4 1.13 dBV/m
Grid 7 M4 3.4 dBV/m	Grid 8 M4 3.36 dBV/m	Grid 9 M4 1.84 dBV/m

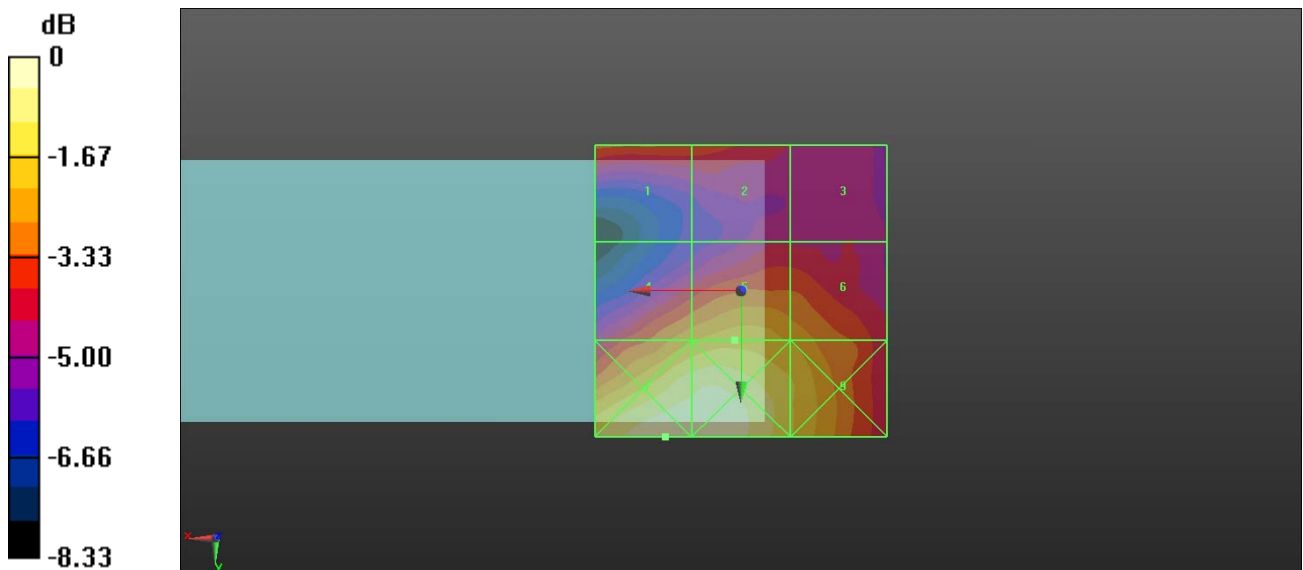

0 dB = 1.479 V/m = 3.40 dBV/m

Test Laboratory: QuieTek

Date/Time: 7/3/2013

Band II CH9400

DUT: Smartphone; Type: 9788

Communication System: UMTS-FDD (WCDMA); Frequency: 1880 MHz; Communication System PAR: 2.91 dB

Medium parameters used: $\sigma = 0$ S/m, $\epsilon_r = 1$; $\rho = 1000$ kg/m³

Phantom section: RF Section

Measurement Standard: DASYS (IEEE/IEC/ANSI C63.19-2011)

DASY5 Configuration:

- Probe: ER3DV6 - SN2466; ConvF(1, 1, 1); Calibrated: 5/29/2013;
- Sensor-Surface: (Fix Surface)
- Electronics: DAE4 Sn1207; Calibrated: 5/22/2013
- Phantom: HAC Test Arch with AMCC; Type: SD HAC P01 BA;
- Measurement SW: DASYS2, Version 52.8 (5); SEMCAD X Version 14.6.8 (7028)

CH9400/Hearing Aid Compatibility Test (101x101x1): Interpolated grid:

dx=0.5000 mm, dy=0.5000 mm

Device Reference Point: 0, 0, -6.3 mm

Reference Value = 28.72 V/m; Power Drift = -0.14 dB

Applied MIF = -27.23 dB

RF audio interference level = 1.50 dBV/m

Emission category: M4

MIF scaled E-field

Grid 1 M4 0.32 dBV/m	Grid 2 M4 -0.69 dBV/m	Grid 3 M4 -1.44 dBV/m
Grid 4 M4 0.93 dBV/m	Grid 5 M4 1.5 dBV/m	Grid 6 M4 0.85 dBV/m
Grid 7 M4 3.57 dBV/m	Grid 8 M4 3.57 dBV/m	Grid 9 M4 1.86 dBV/m

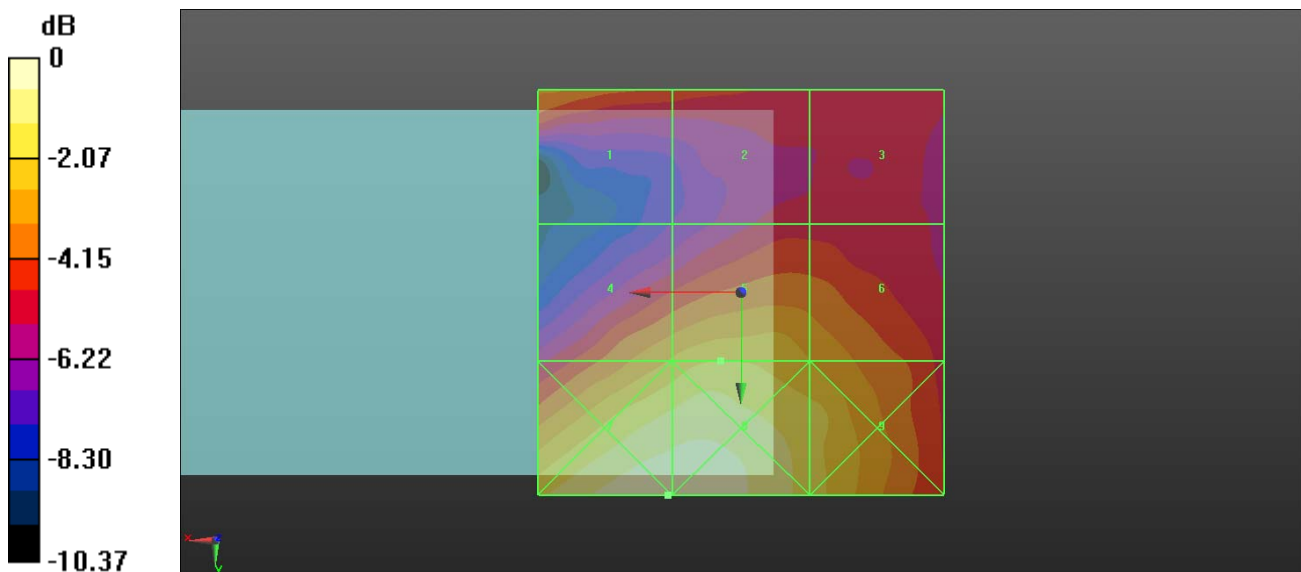

0 dB = 1.509 V/m = 3.57 dBV/m

Test Laboratory: QuieTek

Date/Time: 7/3/2013

Band II CH9538

DUT: Smartphone; Type: 9788

Communication System: UMTS-FDD (WCDMA); Frequency: 1907.6 MHz; Communication System PAR: 2.91 dB

Medium parameters used: $\sigma = 0$ S/m, $\epsilon_r = 1$; $\rho = 1000$ kg/m³

Phantom section: RF Section

Measurement Standard: DASYS5 (IEEE/IEC/ANSI C63.19-2011)

DASY5 Configuration:

- Probe: ER3DV6 - SN2466; ConvF(1, 1, 1); Calibrated: 5/29/2013;
- Sensor-Surface: (Fix Surface)
- Electronics: DAE4 Sn1207; Calibrated: 5/22/2013
- Phantom: HAC Test Arch with AMCC; Type: SD HAC P01 BA;
- Measurement SW: DASYS52, Version 52.8 (5); SEMCAD X Version 14.6.8 (7028)

CH9538/Hearing Aid Compatibility Test (101x101x1): Interpolated grid:

dx=0.5000 mm, dy=0.5000 mm

Device Reference Point: 0, 0, -6.3 mm

Reference Value = 27.25 V/m; Power Drift = 0.10 dB

Applied MIF = -27.23 dB

RF audio interference level = 1.69 dBV/m

Emission category: M4

MIF scaled E-field

Grid 1 M4 0.53 dBV/m	Grid 2 M4 0.02 dBV/m	Grid 3 M4 -0.95 dBV/m
Grid 4 M4 1.16 dBV/m	Grid 5 M4 1.69 dBV/m	Grid 6 M4 1.14 dBV/m
Grid 7 M4 3.48 dBV/m	Grid 8 M4 3.48 dBV/m	Grid 9 M4 1.93 dBV/m

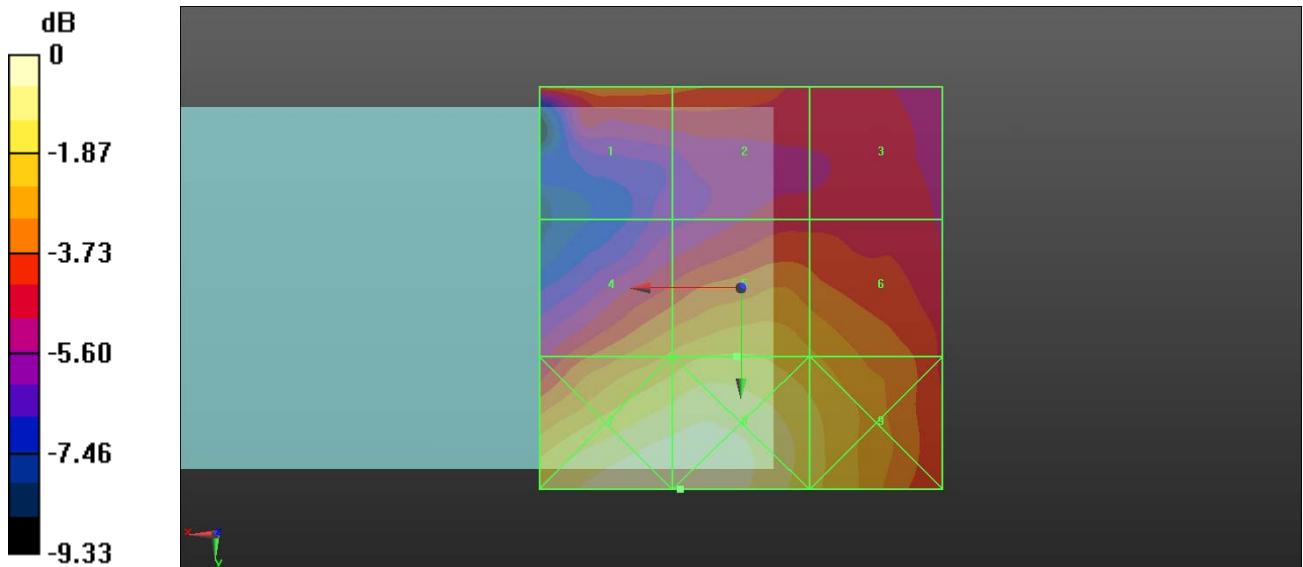

0 dB = 1.494 V/m = 3.49 dBV/m

Test Laboratory: QuieTek

Date/Time: 7/3/2013

Band IV CH1312

DUT: Smartphone; Type: 9788

Communication System: UMTS-FDD (WCDMA); Frequency: 1712.4 MHz; Communication System PAR: 2.91 dB

Medium parameters used: $\sigma = 0$ S/m, $\epsilon_r = 1$; $\rho = 1000$ kg/m³

Phantom section: RF Section

Measurement Standard: DASYS (IEEE/IEC/ANSI C63.19-2011)

DASY5 Configuration:

- Probe: ER3DV6 - SN2466; ConvF(1, 1, 1); Calibrated: 5/29/2013;
- Sensor-Surface: (Fix Surface)
- Electronics: DAE4 Sn1207; Calibrated: 5/22/2013
- Phantom: HAC Test Arch with AMCC; Type: SD HAC P01 BA;
- Measurement SW: DASYS2, Version 52.8 (5); SEMCAD X Version 14.6.8 (7028)

CH1312/Hearing Aid Compatibility Test (101x101x1): Interpolated grid:

dx=0.5000 mm, dy=0.5000 mm

Device Reference Point: 0, 0, -6.3 mm

Reference Value = 23.30 V/m; Power Drift = 0.12 dB

Applied MIF = -27.23 dB

RF audio interference level = 1.07 dBV/m

Emission category: M4

MIF scaled E-field

Grid 1 M4 1.07 dBV/m	Grid 2 M4 0.81 dBV/m	Grid 3 M4 -1.8 dBV/m
Grid 4 M4 0.35 dBV/m	Grid 5 M4 0.81 dBV/m	Grid 6 M4 0.43 dBV/m
Grid 7 M4 3.21 dBV/m	Grid 8 M4 3.25 dBV/m	Grid 9 M4 2.39 dBV/m

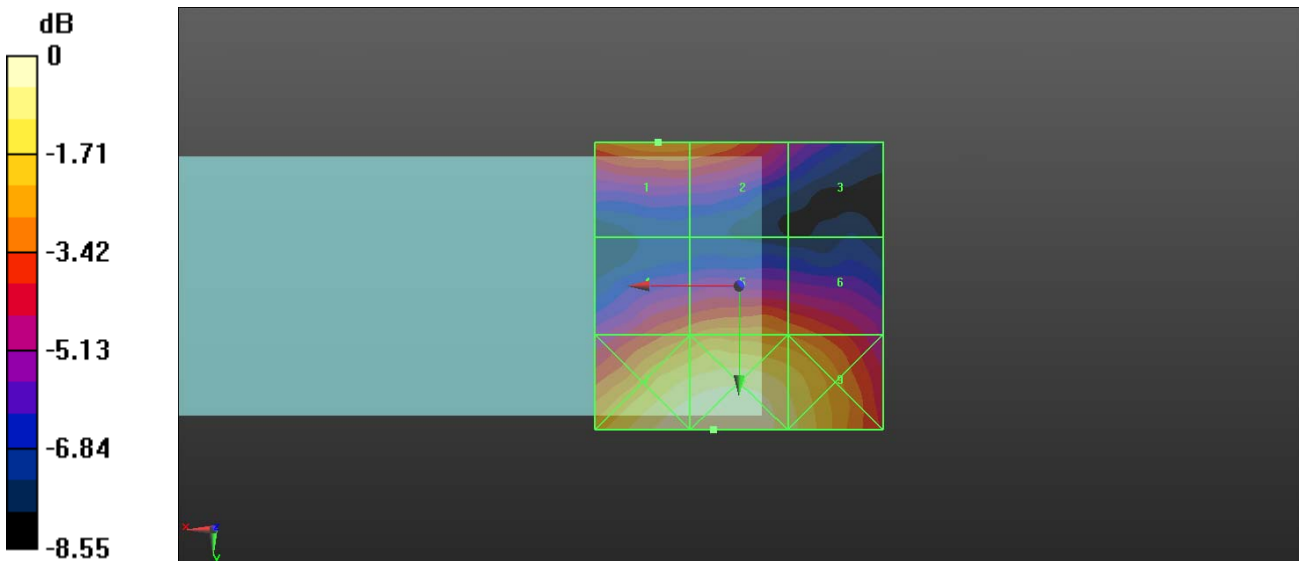

0 dB = 1.454 V/m = 3.25 dBV/m

Test Laboratory: QuieTek

Date/Time: 7/3/2013

Band IV CH1413

DUT: Smartphone; Type: 9788

Communication System: UMTS-FDD (WCDMA); Frequency: 1732.6 MHz; Communication System PAR: 2.91 dB

Medium parameters used: $\sigma = 0$ S/m, $\epsilon_r = 1$; $\rho = 1000$ kg/m³

Phantom section: RF Section

Measurement Standard: DASYS (IEEE/IEC/ANSI C63.19-2011)

DASY5 Configuration:

- Probe: ER3DV6 - SN2466; ConvF(1, 1, 1); Calibrated: 5/29/2013;
- Sensor-Surface: (Fix Surface)
- Electronics: DAE4 Sn1207; Calibrated: 5/22/2013
- Phantom: HAC Test Arch with AMCC; Type: SD HAC P01 BA;
- Measurement SW: DASY52, Version 52.8 (5); SEMCAD X Version 14.6.8 (7028)

CH1413/Hearing Aid Compatibility Test (101x101x1): Interpolated grid:

dx=0.5000 mm, dy=0.5000 mm

Device Reference Point: 0, 0, -6.3 mm

Reference Value = 26.49 V/m; Power Drift = 0.19 dB

Applied MIF = -27.23 dB

RF audio interference level = 1.06 dBV/m

Emission category: M4

MIF scaled E-field

Grid 1 M4 0.05 dBV/m	Grid 2 M4 0.03 dBV/m	Grid 3 M4 -1.68 dBV/m
Grid 4 M4 0.86 dBV/m	Grid 5 M4 1.06 dBV/m	Grid 6 M4 0.47 dBV/m
Grid 7 M4 2.91 dBV/m	Grid 8 M4 2.92 dBV/m	Grid 9 M4 1.77 dBV/m

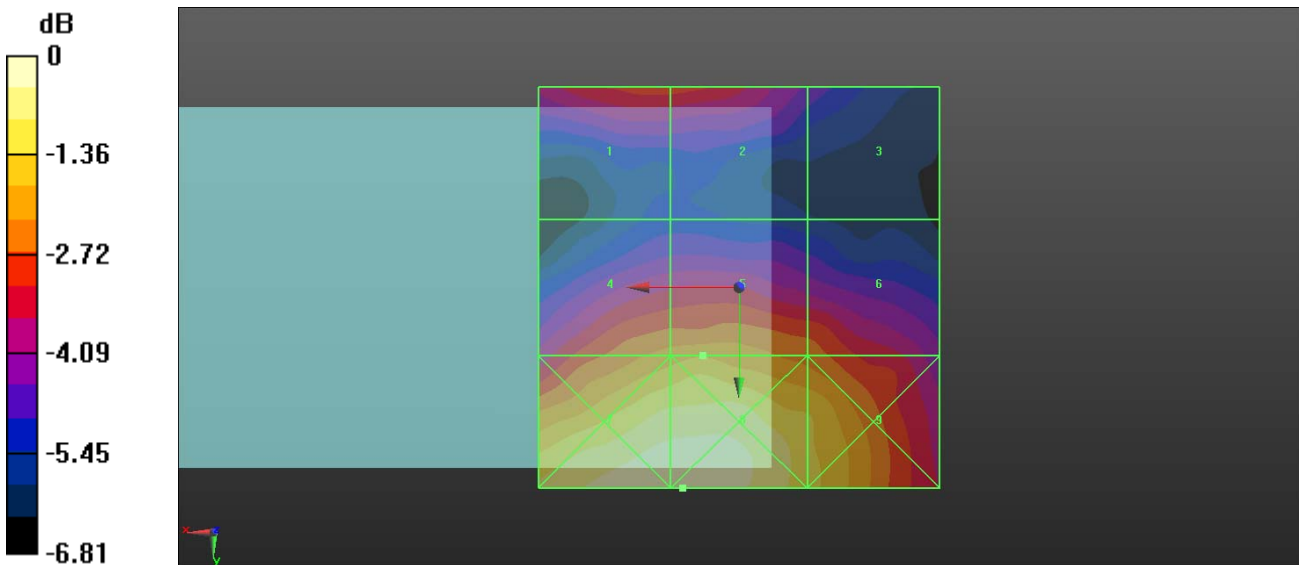

0 dB = 1.399 V/m = 2.92 dBV/m

Test Laboratory: QuieTek

Date/Time: 7/3/2013

Band IV CH1513

DUT: Smartphone; Type: 9788

Communication System: UMTS-FDD (WCDMA); Frequency: 1752.6 MHz; Communication System PAR: 2.91 dB

Medium parameters used: $\sigma = 0$ S/m, $\epsilon_r = 1$; $\rho = 1000$ kg/m³

Phantom section: RF Section

Measurement Standard: DASYS (IEEE/IEC/ANSI C63.19-2011)

DASY5 Configuration:

- Probe: ER3DV6 - SN2466; ConvF(1, 1, 1); Calibrated: 5/29/2013;
- Sensor-Surface: (Fix Surface)
- Electronics: DAE4 Sn1207; Calibrated: 5/22/2013
- Phantom: HAC Test Arch with AMCC; Type: SD HAC P01 BA;
- Measurement SW: DASYS2, Version 52.8 (5); SEMCAD X Version 14.6.8 (7028)

CH1513/Hearing Aid Compatibility Test (101x101x1): Interpolated grid:

dx=0.5000 mm, dy=0.5000 mm

Device Reference Point: 0, 0, -6.3 mm

Reference Value = 26.56 V/m; Power Drift = 0.15 dB

Applied MIF = -27.23 dB

RF audio interference level = 1.68 dBV/m

Emission category: M4

MIF scaled E-field

Grid 1 M4 0.51 dBV/m	Grid 2 M4 -0.83 dBV/m	Grid 3 M4 -1.96 dBV/m
Grid 4 M4 1.43 dBV/m	Grid 5 M4 1.68 dBV/m	Grid 6 M4 0.75 dBV/m
Grid 7 M4 3.33 dBV/m	Grid 8 M4 3.35 dBV/m	Grid 9 M4 1.81 dBV/m

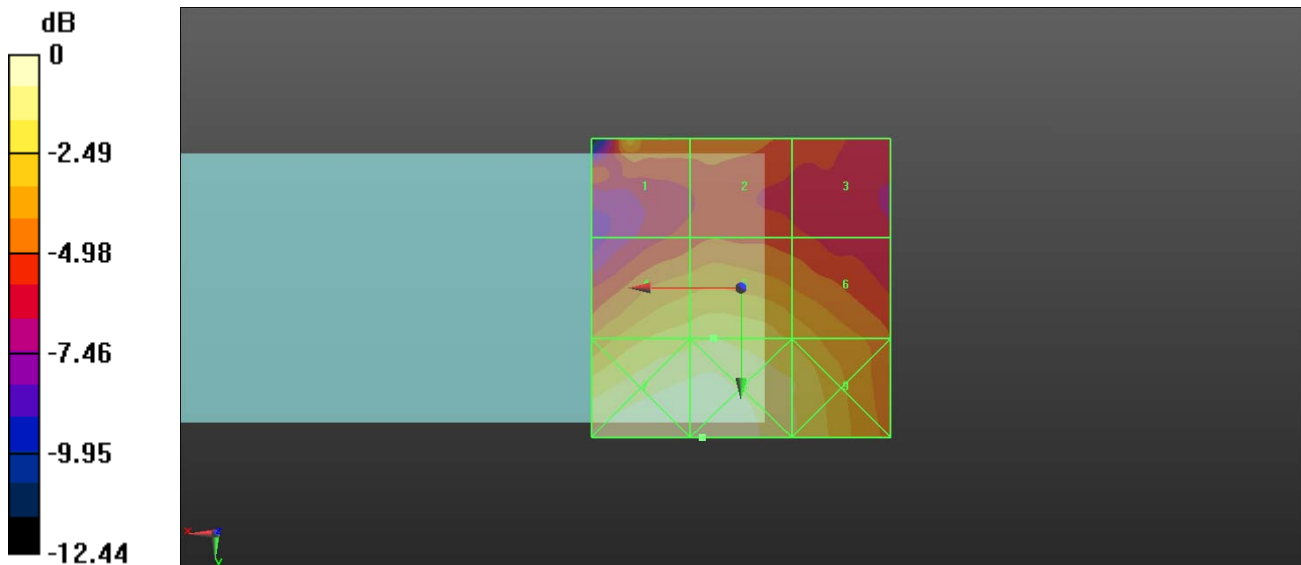

0 dB = 1.471 V/m = 3.35 dBV/m

Test Laboratory: QuieTek

Date/Time: 7/3/2013

Band V CH4132

DUT: Smartphone; Type: 9788

Communication System: UMTS-FDD (WCDMA); Frequency: 826.4 MHz; Communication System PAR: 2.91 dB

Medium parameters used: $\sigma = 0$ S/m, $\epsilon_r = 1$; $\rho = 1000$ kg/m³

Phantom section: RF Section

Measurement Standard: DASYS (IEEE/IEC/ANSI C63.19-2011)

DASY5 Configuration:

- Probe: ER3DV6 - SN2466; ConvF(1, 1, 1); Calibrated: 5/29/2013;
- Sensor-Surface: (Fix Surface)
- Electronics: DAE4 Sn1207; Calibrated: 5/22/2013
- Phantom: HAC Test Arch with AMCC; Type: SD HAC P01 BA;
- Measurement SW: DASYS2, Version 52.8 (5); SEMCAD X Version 14.6.8 (7028)

CH4132/Hearing Aid Compatibility Test (101x101x1): Interpolated grid:

dx=0.5000 mm, dy=0.5000 mm

Device Reference Point: 0, 0, -6.3 mm

Reference Value = 80.72 V/m; Power Drift = -0.07 dB

Applied MIF = -27.23 dB

RF audio interference level = 8.45 dBV/m

Emission category: M4

MIF scaled E-field

Grid 1 M4 7.46 dBV/m	Grid 2 M4 8.25 dBV/m	Grid 3 M4 8.02 dBV/m
Grid 4 M4 7.83 dBV/m	Grid 5 M4 8.45 dBV/m	Grid 6 M4 8.15 dBV/m
Grid 7 M4 7.94 dBV/m	Grid 8 M4 8.22 dBV/m	Grid 9 M4 7.88 dBV/m

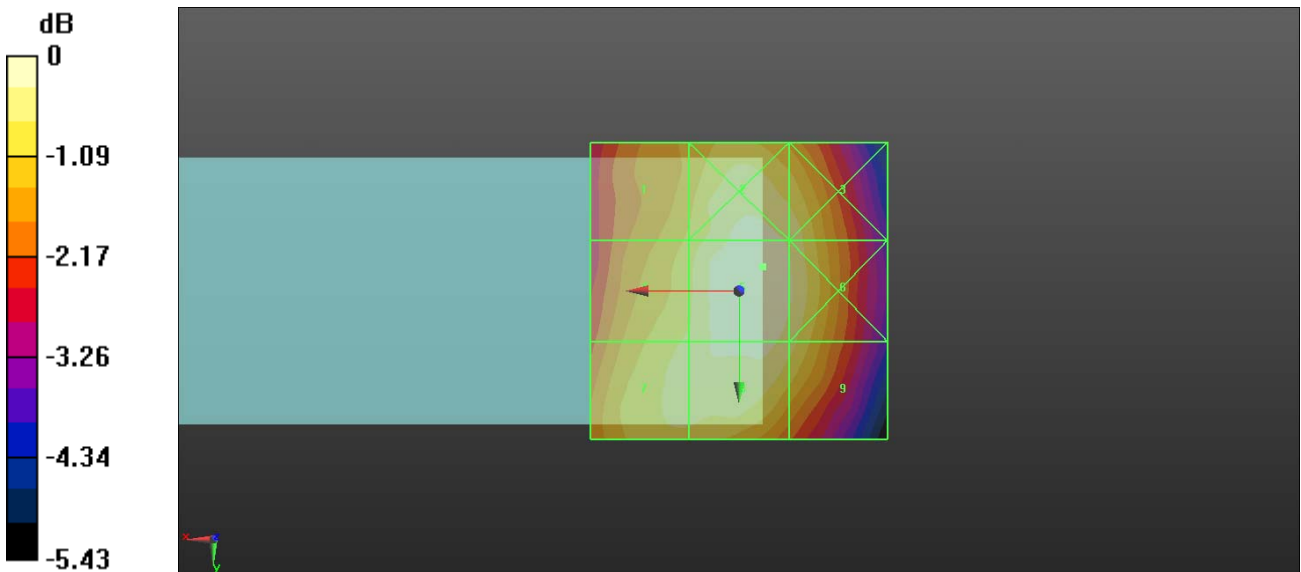

0 dB = 2.645 V/m = 8.45 dBV/m

Test Laboratory: QuieTek

Date/Time: 7/3/2013

Band V CH4183

DUT: Smartphone; Type: 9788

Communication System: UMTS-FDD (WCDMA); Frequency: 836.6 MHz; Communication System PAR: 2.91 dB

Medium parameters used: $\sigma = 0$ S/m, $\epsilon_r = 1$; $\rho = 1000$ kg/m³

Phantom section: RF Section

Measurement Standard: DASYS5 (IEEE/IEC/ANSI C63.19-2011)

DASY5 Configuration:

- Probe: ER3DV6 - SN2466; ConvF(1, 1, 1); Calibrated: 5/29/2013;
- Sensor-Surface: (Fix Surface)
- Electronics: DAE4 Sn1207; Calibrated: 5/22/2013
- Phantom: HAC Test Arch with AMCC; Type: SD HAC P01 BA;
- Measurement SW: DASYS52, Version 52.8 (5); SEMCAD X Version 14.6.8 (7028)

CH4183/Hearing Aid Compatibility Test (101x101x1): Interpolated grid:

dx=0.5000 mm, dy=0.5000 mm

Device Reference Point: 0, 0, -6.3 mm

Reference Value = 83.81 V/m; Power Drift = -0.06 dB

Applied MIF = -27.23 dB

RF audio interference level = 8.88 dBV/m

Emission category: M4

MIF scaled E-field

Grid 1 M4 7.65 dBV/m	Grid 2 M4 8.67 dBV/m	Grid 3 M4 8.44 dBV/m
Grid 4 M4 8.14 dBV/m	Grid 5 M4 8.88 dBV/m	Grid 6 M4 8.61 dBV/m
Grid 7 M4 8.27 dBV/m	Grid 8 M4 8.69 dBV/m	Grid 9 M4 8.31 dBV/m

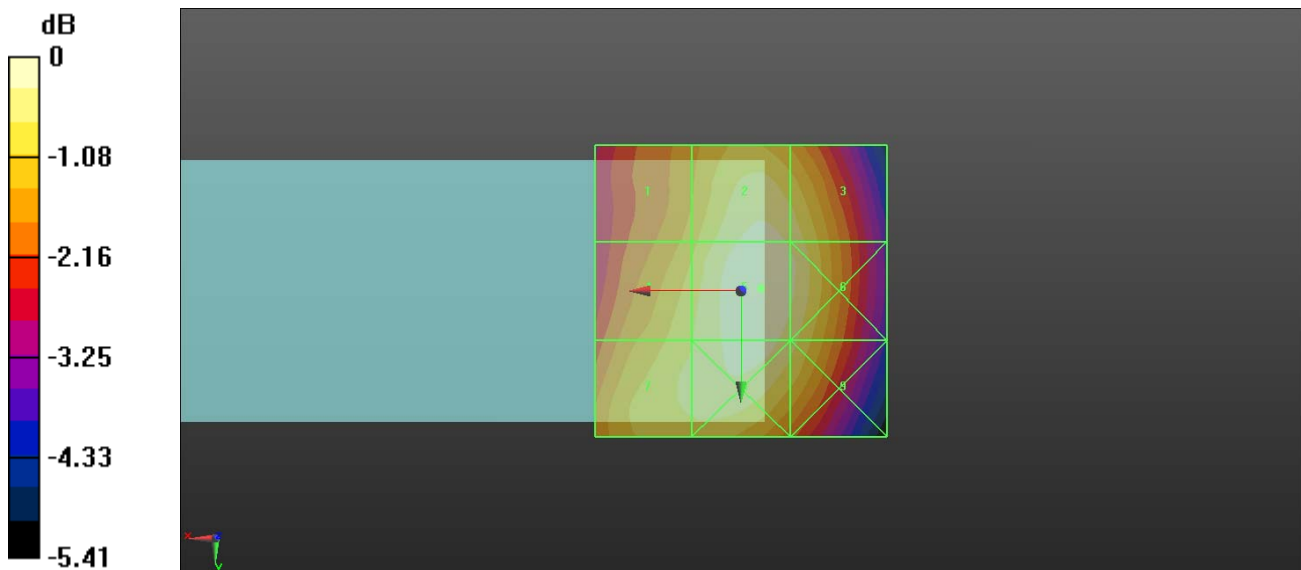

0 dB = 2.778 V/m = 8.87 dBV/m

Test Laboratory: QuieTek

Date/Time: 7/3/2013

Band V CH4233

DUT: Smartphone; Type: 9788

Communication System: UMTS-FDD (WCDMA); Frequency: 846.6 MHz; Communication System PAR: 2.91 dB

Medium parameters used: $\sigma = 0$ S/m, $\epsilon_r = 1$; $\rho = 1000$ kg/m³

Phantom section: RF Section

Measurement Standard: DASYS5 (IEEE/IEC/ANSI C63.19-2011)

DASY5 Configuration:

- Probe: ER3DV6 - SN2466; ConvF(1, 1, 1); Calibrated: 5/29/2013;
- Sensor-Surface: (Fix Surface)
- Electronics: DAE4 Sn1207; Calibrated: 5/22/2013
- Phantom: HAC Test Arch with AMCC; Type: SD HAC P01 BA;
- Measurement SW: DASYS52, Version 52.8 (5); SEMCAD X Version 14.6.8 (7028)

CH4233/Hearing Aid Compatibility Test (101x101x1): Interpolated grid:

dx=0.5000 mm, dy=0.5000 mm

Device Reference Point: 0, 0, -6.3 mm

Reference Value = 82.82 V/m; Power Drift = -0.11 dB

Applied MIF = -27.23 dB

RF audio interference level = 8.71 dBV/m

Emission category: M4

MIF scaled E-field

Grid 1 M4 7.39 dBV/m	Grid 2 M4 8.52 dBV/m	Grid 3 M4 8.32 dBV/m
Grid 4 M4 7.93 dBV/m	Grid 5 M4 8.71 dBV/m	Grid 6 M4 8.48 dBV/m
Grid 7 M4 8.09 dBV/m	Grid 8 M4 8.52 dBV/m	Grid 9 M4 8.2 dBV/m

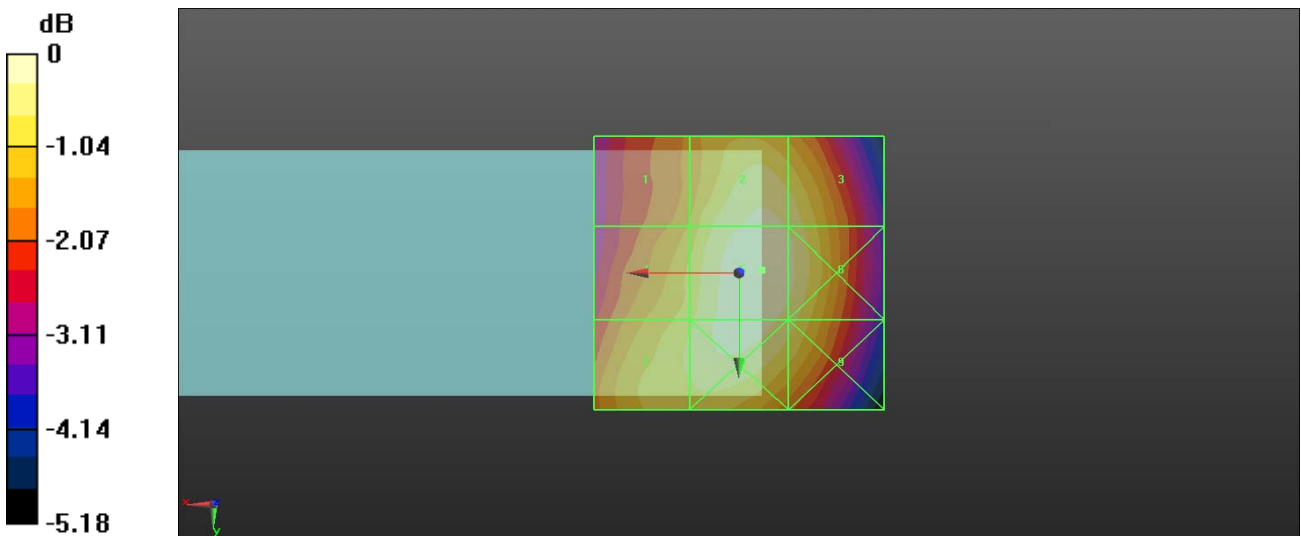

0 dB = 2.726 V/m = 8.71 dBV/m

Appendix C. Test Setup Photographs & EUT Photographs
Test Setup Photographs

HAC Front View



HAC Side View

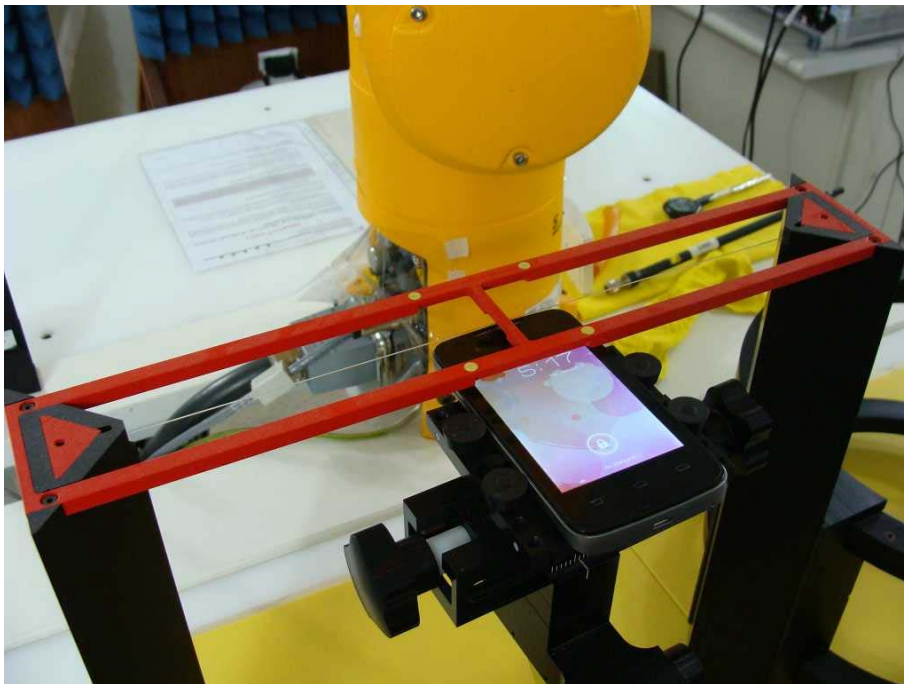

EUT Photographs





Appendix D. HAC Probe Calibration Data

Object: ER3DV6- SN: 2466

**Calibration Laboratory of
Schmid & Partner
Engineering AG**
Zeughausstrasse 43, 8004 Zurich, Switzerland



S Schweizerischer Kalibrierdienst
S Service suisse d'étalonnage
S Servizio svizzero di taratura
S Swiss Calibration Service

Accredited by the Swiss Accreditation Service (SAS)
The Swiss Accreditation Service is one of the signatories to the EA
Multilateral Agreement for the recognition of calibration certificates

Accreditation No.: **SCS 108**

Client **Quietek-TW (Auden)**

Certificate No: **ER3-2466_May13**

CALIBRATION CERTIFICATE

Object **ER3DV6 - SN:2466**

Calibration procedure(s) **QA CAL-02.v6, QA CAL-25.v4
Calibration procedure for E-field probes optimized for close near field
evaluations in air**

Calibration date: **May 29, 2013**

This calibration certificate documents the traceability to national standards, which realize the physical units of measurements (SI).
The measurements and the uncertainties with confidence probability are given on the following pages and are part of the certificate.

All calibrations have been conducted in the closed laboratory facility: environment temperature (22 ± 3)°C and humidity < 70%.

Calibration Equipment used (M&TE critical for calibration)

Primary Standards	ID	Cal Date (Certificate No.)	Scheduled Calibration
Power meter E4419B	GB41293874	04-Apr-13 (No. 217-01733)	Apr-14
Power sensor E4412A	MY41498087	04-Apr-13 (No. 217-01733)	Apr-14
Reference 3 dB Attenuator	SN: S5054 (3c)	04-Apr-13 (No. 217-01737)	Apr-14
Reference 20 dB Attenuator	SN: S5277 (20x)	04-Apr-13 (No. 217-01735)	Apr-14
Reference 30 dB Attenuator	SN: S5129 (30b)	04-Apr-13 (No. 217-01738)	Apr-14
Reference Probe ER3DV6	SN: 2328	12-Oct-12 (No. ER3-2328_Oct12)	Oct-13
DAE4	SN: 789	15-May-13 (No. DAE4-789_May13)	May-14
Secondary Standards	ID	Check Date (in house)	Scheduled Check
RF generator HP 8648C	US3642U01700	4-Aug-99 (in house check Apr-13)	In house check: Apr-15
Network Analyzer HP 8753E	US37390585	18-Oct-01 (in house check Oct-12)	In house check: Oct-13

Calibrated by: **Name: Jeton Kastrati, Function: Laboratory Technician, Signature: [Signature]**

Approved by: **Name: Katja Pokovic, Function: Technical Manager, Signature: [Signature]**

Issued: May 29, 2013

This calibration certificate shall not be reproduced except in full without written approval of the laboratory.



Accredited by the Swiss Accreditation Service (SAS)

Accreditation No.: **SCS 108**

The Swiss Accreditation Service is one of the signatories to the EA
Multilateral Agreement for the recognition of calibration certificates

Glossary:

NORM _{x,y,z}	sensitivity in free space
DCP	diode compression point
CF	crest factor (1/duty_cycle) of the RF signal
A, B, C, D	modulation dependent linearization parameters
Polarization φ	φ rotation around probe axis
Polarization ϑ	ϑ rotation around an axis that is in the plane normal to probe axis (at measurement center), i.e., $\vartheta = 0$ is normal to probe axis
Connector Angle	information used in DASY system to align probe sensor X to the robot coordinate system

Calibration is Performed According to the Following Standards:

- IEEE Std 1309-2005, "IEEE Standard for calibration of electromagnetic field sensors and probes, excluding antennas, from 9 kHz to 40 GHz", December 2005
- CTIA Test Plan for Hearing Aid Compatibility, April 2010.

Methods Applied and Interpretation of Parameters:

- NORM_{x,y,z}*: Assessed for E-field polarization $\vartheta = 0$ for XY sensors and $\vartheta = 90$ for Z sensor ($f \leq 900$ MHz in TEM-cell; $f > 1800$ MHz: R22 waveguide).
- NORM(f)_{x,y,z}* = *NORM_{x,y,z}* * *frequency_response* (see Frequency Response Chart).
- DCP_{x,y,z}*: DCP are numerical linearization parameters assessed based on the data of power sweep with CW signal (no uncertainty required). DCP does not depend on frequency nor media.
- PAR*: PAR is the Peak to Average Ratio that is not calibrated but determined based on the signal characteristics
- A_{x,y,z}*; *B_{x,y,z}*; *C_{x,y,z}*; *D_{x,y,z}*; *VR_{x,y,z}*: *A, B, C, D* are numerical linearization parameters assessed based on the data of power sweep for specific modulation signal. The parameters do not depend on frequency nor media. *VR* is the maximum calibration range expressed in RMS voltage across the diode.
- Spherical isotropy (3D deviation from isotropy)*: in a locally homogeneous field realized using an open waveguide setup.
- Sensor Offset*: The sensor offset corresponds to the offset of virtual measurement center from the probe tip (on probe axis). No tolerance required.
- Connector Angle*: The angle is assessed using the information gained by determining the *NORM_x* (no uncertainty required).

Probe ER3DV6

SN:2466

Manufactured: March 31, 2009
Calibrated: May 29, 2013

Calibrated for DASY/EASY Systems
(Note: non-compatible with DASY2 system!)

DASY/EASY - Parameters of Probe: ER3DV6 - SN:2466

Basic Calibration Parameters

	Sensor X	Sensor Y	Sensor Z	Unc (k=2)
Norm ($\mu\text{V}/(\text{V}/\text{m})^2$)	1.76	1.67	1.61	$\pm 10.1 \%$
DCP (mV) ^B	99.8	100.2	101.7	

Modulation Calibration Parameters

UID	Communication System Name		A dB	B dB $\sqrt{\mu\text{V}}$	C	D dB	VR mV	Unc ^E (k=2)
0	CW	X	0.0	0.0	1.0	0.00	175.0	$\pm 3.0 \%$
		Y	0.0	0.0	1.0		155.9	
		Z	0.0	0.0	1.0		180.5	
10011- CAA	UMTS-FDD (WCDMA)	X	3.29	67.1	18.7	2.91	141.8	$\pm 0.7 \%$
		Y	3.19	66.4	18.3		124.6	
		Z	3.13	65.9	17.3		144.1	
10021- DAA	GSM-FDD (TDMA, GMSK)	X	20.95	99.8	28.6	9.39	104.6	$\pm 1.4 \%$
		Y	19.60	99.7	28.4		125.5	
		Z	8.30	81.8	21.0		105.1	

The reported uncertainty of measurement is stated as the standard uncertainty of measurement multiplied by the coverage factor k=2, which for a normal distribution corresponds to a coverage probability of approximately 95%.

^B Numerical linearization parameter: uncertainty not required.

^E Uncertainty is determined using the max. deviation from linear response applying rectangular distribution and is expressed for the square of the field value.

Frequency Response of E-Field

(TEM-Cell:ifi110 EXX, Waveguide: R22)

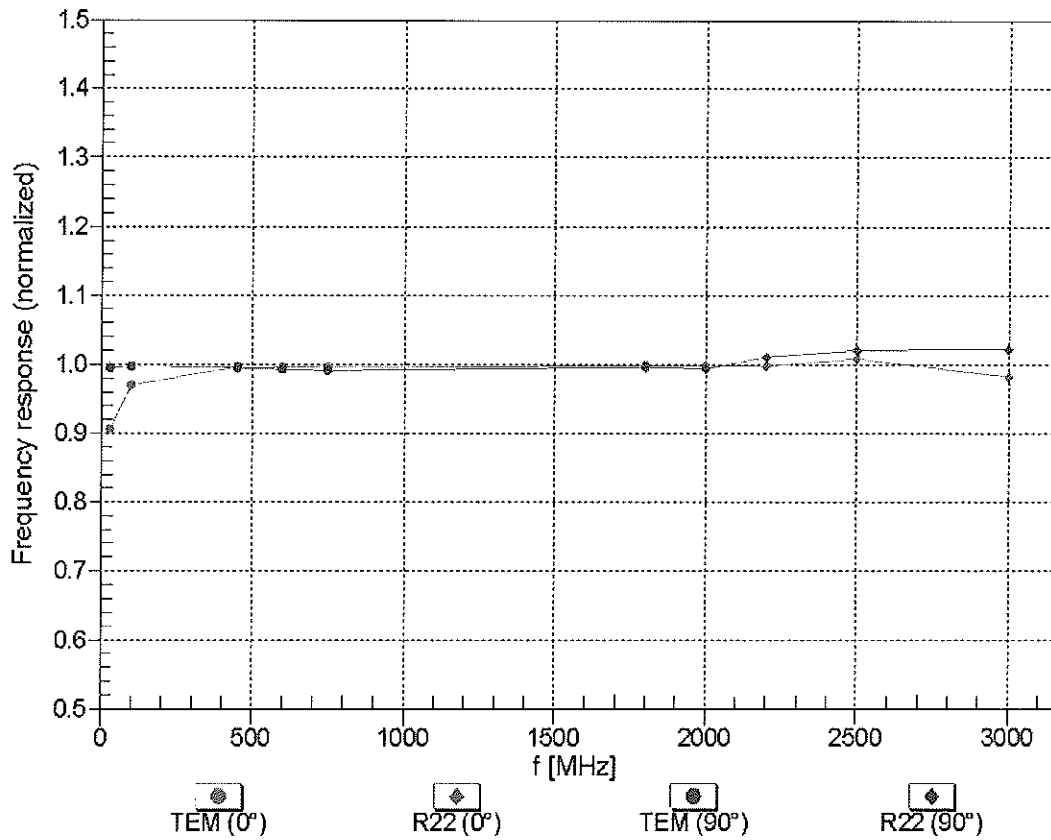

Uncertainty of Frequency Response of E-field: $\pm 6.3\%$ (k=2)

Receiving Pattern (ϕ), $\vartheta = 0^\circ$

f=600 MHz, TEM, 0°

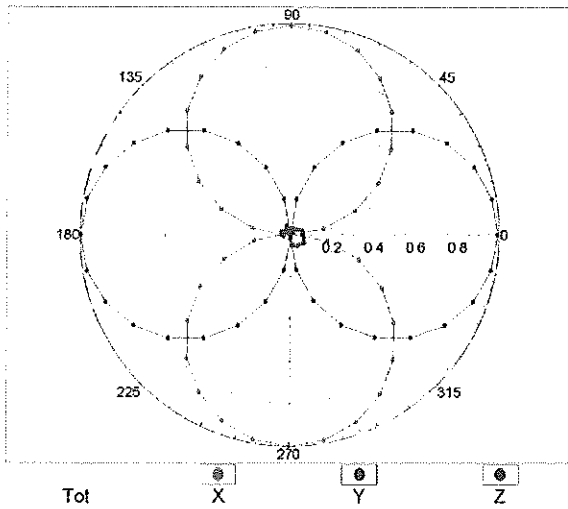

f=2500 MHz, R22, 0°

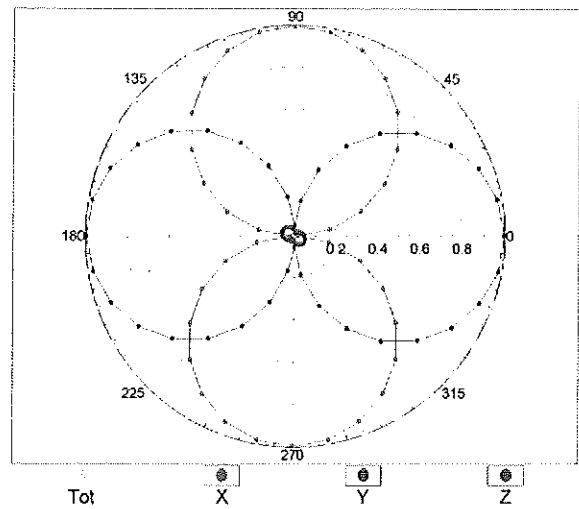

Receiving Pattern (ϕ), $\vartheta = 90^\circ$

f=600 MHz, TEM, 90°

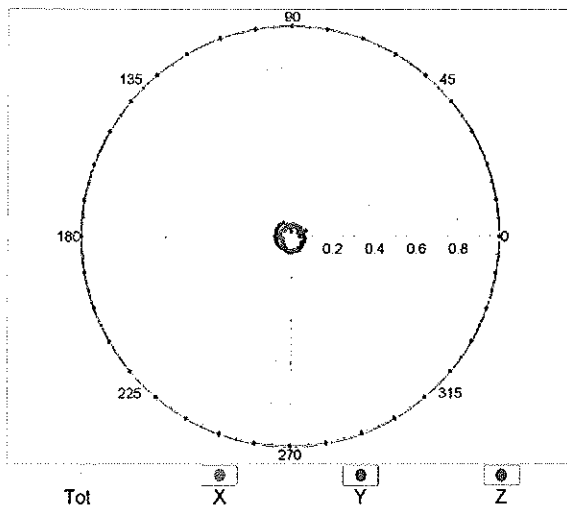

f=2500 MHz, R22, 90°

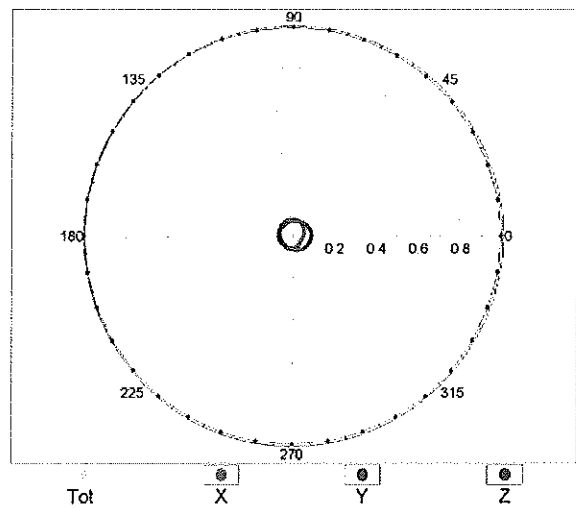

Receiving Pattern (ϕ), $\vartheta = 0^\circ$

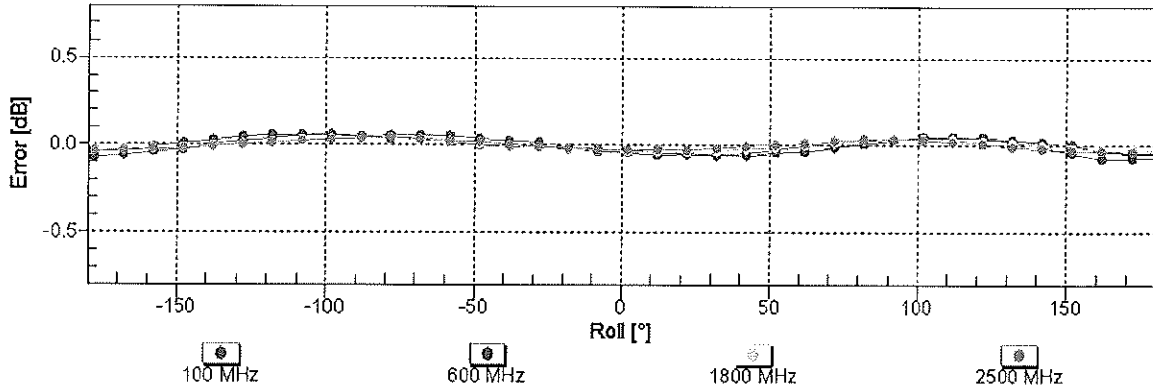

Uncertainty of Axial Isotropy Assessment: $\pm 0.5\%$ ($k=2$)

Receiving Pattern (ϕ), $\vartheta = 90^\circ$

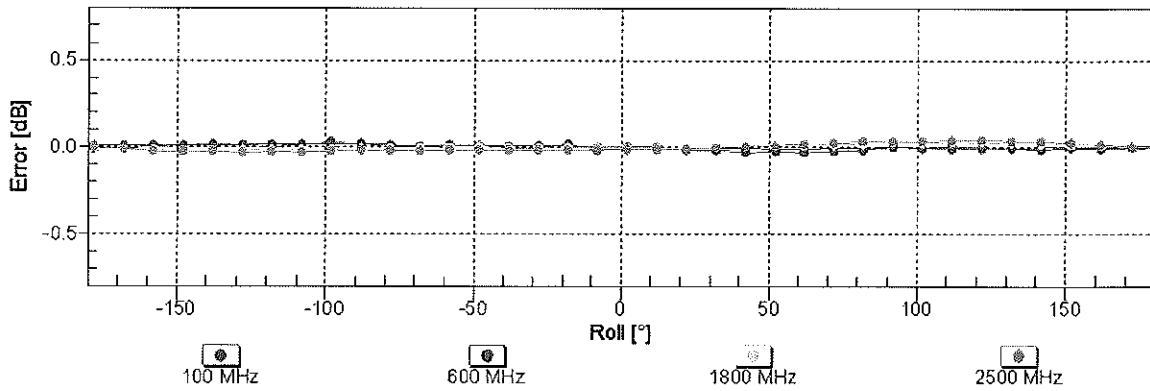

Uncertainty of Axial Isotropy Assessment: $\pm 0.5\%$ ($k=2$)

Dynamic Range f(E-field) (TEM cell , f = 900 MHz)

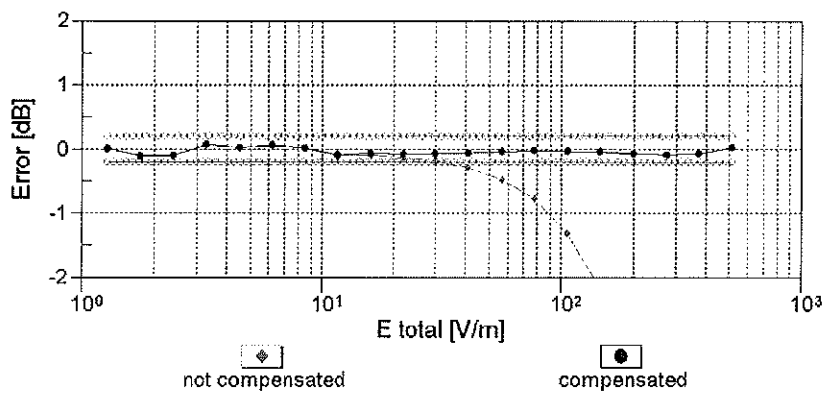
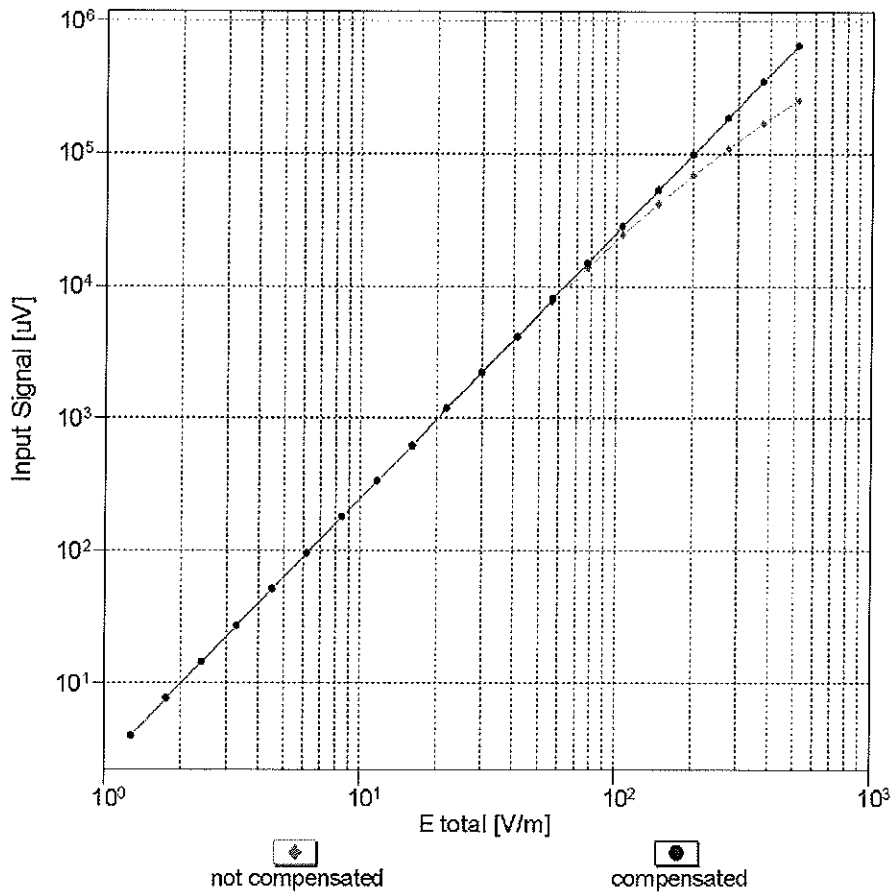

Uncertainty of Linearity Assessment: ± 0.6% (k=2)

Deviation from Isotropy in Air

Error (ϕ, θ), $f = 900$ MHz

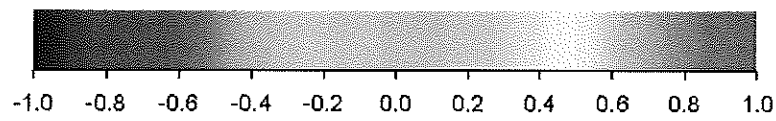
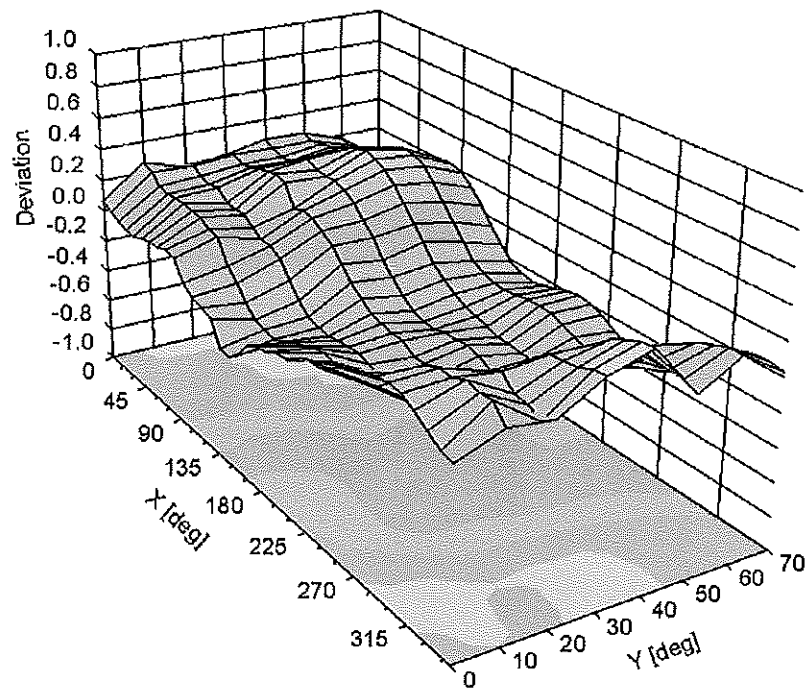

Uncertainty of Spherical Isotropy Assessment: $\pm 2.6\%$ ($k=2$)

DASY/EASY - Parameters of Probe: ER3DV6 - SN:2466**Other Probe Parameters**

Sensor Arrangement	Rectangular
Connector Angle (°)	-38.1
Mechanical Surface Detection Mode	enabled
Optical Surface Detection Mode	disabled
Probe Overall Length	337 mm
Probe Body Diameter	10 mm
Tip Length	10 mm
Tip Diameter	8 mm
Probe Tip to Sensor X Calibration Point	2.5 mm
Probe Tip to Sensor Y Calibration Point	2.5 mm
Probe Tip to Sensor Z Calibration Point	2.5 mm



Appendix E. HAC Dipole Calibration

Validation Dipole 835MHz

M/N: CD835V3

S/N: 1135

Validation Dipole 1900MHz

M/N: CD1880V3

S/N: 1117

**Calibration Laboratory of
Schmid & Partner
Engineering AG**
Zeughausstrasse 43, 8004 Zurich, Switzerland



**S
C
S** Schweizerischer Kalibrierdienst
Service suisse d'étalonnage
Servizio svizzero di taratura
Swiss Calibration Service

Accredited by the Swiss Accreditation Service (SAS)
The Swiss Accreditation Service is one of the signatories to the EA
Multilateral Agreement for the recognition of calibration certificates

Accreditation No.: **SCS 108**

Client **Quietek-TW (Auden)**

Certificate No: **CD835V3-1135_May13**

CALIBRATION CERTIFICATE

Object **CD835V3 - SN: 1135**

Calibration procedure(s) **QA CAL-20.v6
Calibration procedure for dipoles in air**

Calibration date: **May 29, 2013**

This calibration certificate documents the traceability to national standards, which realize the physical units of measurements (SI).
The measurements and the uncertainties with confidence probability are given on the following pages and are part of the certificate.

All calibrations have been conducted in the closed laboratory facility: environment temperature (22 ± 3)°C and humidity < 70%.

Calibration Equipment used (M&TE critical for calibration)

Primary Standards	ID #	Cal Date (Certificate No.)	Scheduled Calibration
Power meter EPM-442A	GB37480704	01-Nov-12 (No. 217-01640)	Oct-13
Power sensor HP 8481A	US37292783	01-Nov-12 (No. 217-01640)	Oct-13
Reference 10 dB Attenuator	SN: 5047.2 (10q)	04-Apr-13 (No. 217-01731)	Apr-14
Probe ER3DV6	SN: 2336	28-Dec-12 (No. ER3-2336_Dec12)	Dec-13
Probe H3DV6	SN: 6065	28-Dec-12 (No. H3-6065_Dec12)	Dec-13
DAE4	SN: 901	05-Jun-12 (No. DAE4-901_Jun12)	Jun-13
Secondary Standards	ID #	Check Date (in house)	Scheduled Check
Power meter Agilent 4419B	SN: GB42420191	09-Oct-09 (in house check Oct-12)	In house check: Oct-13
Power sensor HP E4412A	SN: MY41495277	01-Apr-08 (in house check Oct-12)	In house check: Oct-13
Power sensor HP 8482A	SN: US37295597	09-Oct-09 (in house check Oct-12)	In house check: Oct-13
Network Analyzer HP 8753E	US37390585	18-Oct-01 (in house check Oct-12)	In house check: Oct-13
RF generator R&S SMT-06	SN: 832283/011	27-Aug-12 (in house check Oct-12)	In house check: Oct-14

Calibrated by: **Claudio Leubler** Name: Claudio Leubler Function: Laboratory Technician

Approved by: **Fin Bomholt** Name: Fin Bomholt Function: Deputy Technical Manager

Signature

Issued: May 29, 2013

This calibration certificate shall not be reproduced except in full without written approval of the laboratory.



Accredited by the Swiss Accreditation Service (SAS)

The Swiss Accreditation Service is one of the signatories to the EA
Multilateral Agreement for the recognition of calibration certificates

Accreditation No.: **SCS 108**

References

- [1] ANSI-C63.19-2007
American National Standard for Methods of Measurement of Compatibility between Wireless Communications Devices and Hearing Aids.
- [2] ANSI-C63.19-2011
American National Standard, Methods of Measurement of Compatibility between Wireless Communications Devices and Hearing Aids.

Methods Applied and Interpretation of Parameters:

- *Coordinate System:* y-axis is in the direction of the dipole arms. z-axis is from the basis of the antenna (mounted on the table) towards its feed point between the two dipole arms. x-axis is normal to the other axes. In coincidence with the standards [1], the measurement planes (probe sensor center) are selected to be at a distance of 10 mm (15 mm for [2]) above the top metal edge of the dipole arms.
- *Measurement Conditions:* Further details are available from the hardcopies at the end of the certificate. All figures stated in the certificate are valid at the frequency indicated. The forward power to the dipole connector is set with a calibrated power meter connected and monitored with an auxiliary power meter connected to a directional coupler. While the dipole under test is connected, the forward power is adjusted to the same level.
- *Antenna Positioning:* The dipole is mounted on a HAC Test Arch phantom using the matching dipole positioner with the arms horizontal and the feeding cable coming from the floor. The measurements are performed in a shielded room with absorbers around the setup to reduce the reflections. It is verified before the mounting of the dipole under the Test Arch phantom, that its arms are perfectly in a line. It is installed on the HAC dipole positioner with its arms parallel below the dielectric reference wire and able to move elastically in vertical direction without changing its relative position to the top center of the Test Arch phantom. The vertical distance to the probe is adjusted after dipole mounting with a DASY5 Surface Check job. Before the measurement, the distance between phantom surface and probe tip is verified. The proper measurement distance is selected by choosing the matching section of the HAC Test Arch phantom with the proper device reference point (upper surface of the dipole) and the matching grid reference point (tip of the probe) considering the probe sensor offset. The vertical distance to the probe is essential for the accuracy.
- *Feed Point Impedance and Return Loss:* These parameters are measured using a HP 8753E Vector Network Analyzer. The impedance is specified at the SMA connector of the dipole. The influence of reflections was eliminated by applying the averaging function while moving the dipole in the air, at least 70cm away from any obstacles.
- *E-field distribution:* E field is measured in the x-y-plane with an isotropic ER3D-field probe with 100 mW forward power to the antenna feed point. In accordance with [1] and [2], the scan area is 20mm wide, its length exceeds the dipole arm length (180 or 90mm). The sensor center is 10 mm (15 mm for [2]) (in z) above the metal top of the dipole arms. Two 3D maxima are available near the end of the dipole arms. Assuming the dipole arms are perfectly in one line, the average of these two maxima (in subgrid 2 and subgrid 8) is determined to compensate for any non-parallelity to the measurement plane as well as the sensor displacement. The E-field value stated as calibration value represents the maximum of the interpolated 3D-E-field, in the plane above the dipole surface.
- *H-field distribution:* H-field is measured with an isotropic H-field probe with 100mW forward power to the antenna feed point, in the x-y-plane. The scan area and sensor distance is equivalent to the E-field scan. The maximum of the field is available at the center (subgrid 5) above the feed point. The H-field value stated as calibration value represents the maximum of the interpolated H-field, 10mm above the dipole surface at the feed point.

The reported uncertainty of measurement is stated as the standard uncertainty of measurement multiplied by the coverage factor $k=2$, which for a normal distribution corresponds to a coverage probability of approximately 95%.

Measurement Conditions

DASY system configuration, as far as not given on page 1.

DASY Version	DASY5	V52.8.6
Extrapolation	Advanced Extrapolation	
Phantom	HAC Test Arch	
Distance Dipole Top - Probe Center	15mm	
Scan resolution	dx, dy = 5 mm	
Frequency	835 MHz \pm 1 MHz	
Input power drift	< 0.05 dB	

Maximum Field values at 835 MHz

E-field 15 mm above dipole surface	condition	Interpolated maximum
Maximum measured above high end	100 mW input power	109.4 V / m
Maximum measured above low end	100 mW input power	108.8 V / m
Averaged maximum above arm	100 mW input power	109.1 V / m \pm 12.8 % (k=2)

Appendix

Antenna Parameters

Frequency	Return Loss	Impedance
800 MHz	16.3 dB	43.1 Ω - 12.5 j Ω
835 MHz	28.3 dB	51.4 Ω + 3.6 j Ω
900 MHz	16.4 dB	55.0 Ω - 15.3 j Ω
950 MHz	19.5 dB	45.2 Ω + 9.0 j Ω
960 MHz	15.2 dB	53.6 Ω + 17.8 j Ω

3.2 Antenna Design and Handling

The calibration dipole has a symmetric geometry with a built-in two stub matching network, which leads to the enhanced bandwidth.

The dipole is built of standard semirigid coaxial cable. The internal matching line is open ended. The antenna is therefore open for DC signals.

Do not apply force to dipole arms, as they are liable to bend. The soldered connections near the feedpoint may be damaged. After excessive mechanical stress or overheating, check the impedance characteristics to ensure that the internal matching network is not affected.

After long term use with 40W radiated power, only a slight warming of the dipole near the feedpoint can be measured.

Impedance Measurement Plot

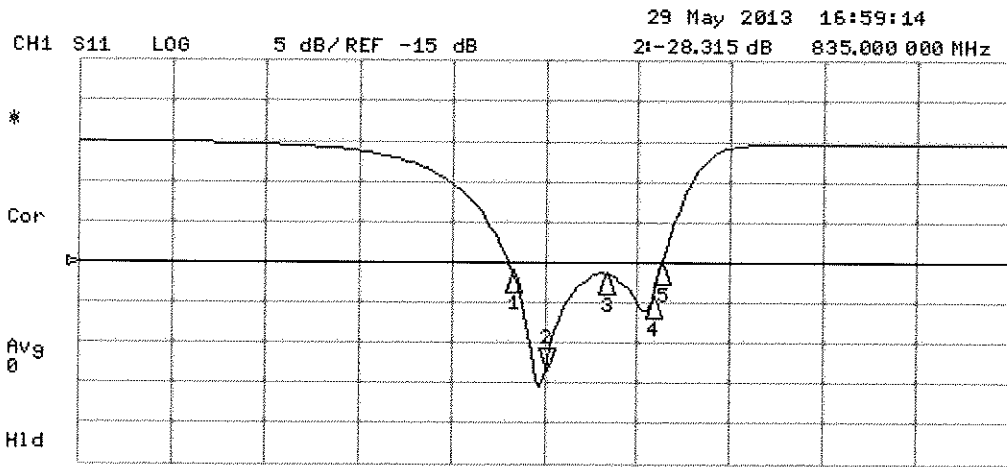

CH2 S11 1 U FS 2: 51.385 Ω 3: 6387 Ω 693.55 pF 835.000 000 MHz

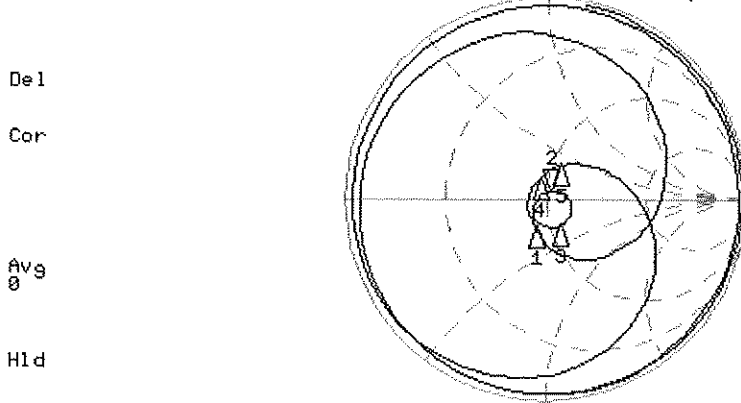

START 335.000 000 MHz

STOP 1 335.000 000 MHz

DASY5 E-field Result

Date: 29.05.2013

Test Laboratory: SPEAG Lab2

DUT: HAC-Dipole 835 MHz; Type: CD835V3; Serial: CD835V3 - SN: 1135

Communication System: UID 0 - CW; Frequency: 835 MHz
 Medium parameters used: $\sigma = 0 \text{ S/m}$, $\epsilon_r = 1$; $\rho = 1000 \text{ kg/m}^3$
 Phantom section: RF Section
 Measurement Standard: DASY5 (IEEE/IEC/ANSI C63.19-2007)

DASY52 Configuration:

- Probe: ER3DV6 - SN2336; ConvF(1, 1, 1); Calibrated: 28.12.2012;
- Sensor-Surface: (Fix Surface)
- Electronics: DAE4 Sn901; Calibrated: 05.06.2012
- Phantom: HAC Test Arch with AMCC; Type: SD HAC P01 BA; Serial: 1070
- DASY52 52.8.6(1115); SEMCAD X 14.6.9(7117)

Dipole E-Field measurement @ 835MHz/E-Scan - 835MHz d=15mm/Hearing Aid Compatibility Test (41x361x1):

Interpolated grid: dx=0.5000 mm, dy=0.5000 mm

Device Reference Point: 0, 0, -6.3 mm

Reference Value = 109.3 V/m; Power Drift = -0.02 dB

PMR not calibrated. PMF = 1.000 is applied.

E-field emissions = 109.4 V/m

Near-field category: M4 (AWF 0 dB)

PMF scaled E-field

Grid 1 M4	Grid 2 M4	Grid 3 M4
107.0 V/m	108.8 V/m	107.1 V/m
Grid 4 M4	Grid 5 M4	Grid 6 M4
63.99 V/m	64.90 V/m	63.68 V/m
Grid 7 M4	Grid 8 M4	Grid 9 M4
107.9 V/m	109.4 V/m	106.9 V/m

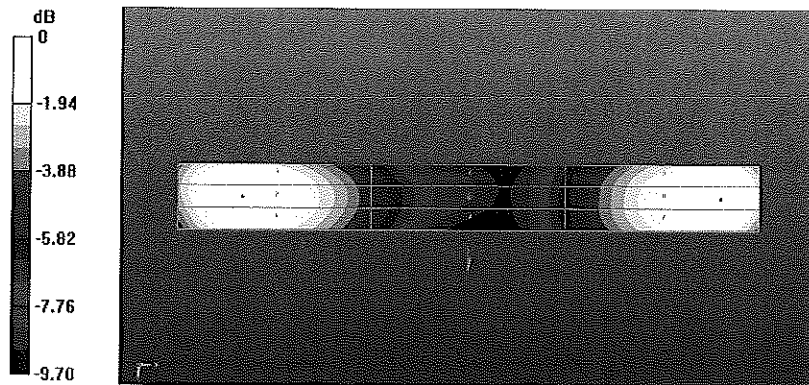

0 dB = 109.4 V/m = 40.78 dBV/m

**Calibration Laboratory of
Schmid & Partner
Engineering AG**
Zeughausstrasse 43, 8004 Zurich, Switzerland



SCS Schweizerischer Kalibrierdienst
Service suisse d'étalonnage
Servizio svizzero di taratura
Swiss Calibration Service

Accredited by the Swiss Accreditation Service (SAS)
The Swiss Accreditation Service is one of the signatories to the EA
Multilateral Agreement for the recognition of calibration certificates

Accreditation No.: **SCS 108**

Client **Quietek-TW (Auden)**

Certificate No: **CD1880V3-1117_May13**

CALIBRATION CERTIFICATE

Object **CD1880V3 - SN: 1117**

Calibration procedure(s) **QA CAL-20.v6
Calibration procedure for dipoles in air**

Calibration date: **May 29, 2013**

This calibration certificate documents the traceability to national standards, which realize the physical units of measurements (SI).
The measurements and the uncertainties with confidence probability are given on the following pages and are part of the certificate.

All calibrations have been conducted in the closed laboratory facility: environment temperature (22 ± 3)°C and humidity < 70%.

Calibration Equipment used (M&TE critical for calibration)

Primary Standards	ID #	Cal Date (Certificate No.)	Scheduled Calibration
Power meter EPM-442A	GB37480704	01-Nov-12 (No. 217-01640)	Oct-13
Power sensor HP 8481A	US37292783	01-Nov-12 (No. 217-01640)	Oct-13
Reference 10 dB Attenuator	SN: 5047.2 (10q)	04-Apr-13 (No. 217-01731)	Apr-14
Probe ER3DV6	SN: 2336	28-Dec-12 (No. ER3-2336_Dec12)	Dec-13
Probe H3DV6	SN: 6065	28-Dec-12 (No. H3-6065_Dec12)	Dec-13
DAE4	SN: 901	05-Jun-12 (No. DAE4-901_Jun12)	Jun-13

Secondary Standards	ID #	Check Date (in house)	Scheduled Check
Power meter Agilent 4419B	SN: GB42420191	09-Oct-09 (in house check Oct-12)	In house check: Oct-13
Power sensor HP E4412A	SN: MY41495277	01-Apr-08 (in house check Oct-12)	In house check: Oct-13
Power sensor HP 8482A	SN: US37295597	09-Oct-09 (in house check Oct-12)	In house check: Oct-13
Network Analyzer HP 8753E	US37390585	18-Oct-01 (in house check Oct-12)	In house check: Oct-13
RF generator R&S SMT-06	SN: 832283/011	27-Aug-12 (in house check Oct-12)	In house check: Oct-14

Calibrated by: **Claudio Leubler** Name: Claudio Leubler Function: Laboratory Technician Signature:

Approved by: **Fin Bomholt** Name: Fin Bomholt Function: Deputy Technical Manager Signature:

Issued: May 29, 2013

This calibration certificate shall not be reproduced except in full without written approval of the laboratory.



Accredited by the Swiss Accreditation Service (SAS)

The Swiss Accreditation Service is one of the signatories to the EA Multilateral Agreement for the recognition of calibration certificates

Accreditation No.: **SCS 108**

References

- [1] ANSI-C63.19-2007
American National Standard for Methods of Measurement of Compatibility between Wireless Communications Devices and Hearing Aids.
- [2] ANSI-C63.19-2011
American National Standard, Methods of Measurement of Compatibility between Wireless Communications Devices and Hearing Aids.

Methods Applied and Interpretation of Parameters:

- *Coordinate System:* y-axis is in the direction of the dipole arms. z-axis is from the basis of the antenna (mounted on the table) towards its feed point between the two dipole arms. x-axis is normal to the other axes. In coincidence with the standards [1], the measurement planes (probe sensor center) are selected to be at a distance of 10 mm (15 mm for [2]) above the top metal edge of the dipole arms.
- *Measurement Conditions:* Further details are available from the hardcopies at the end of the certificate. All figures stated in the certificate are valid at the frequency indicated. The forward power to the dipole connector is set with a calibrated power meter connected and monitored with an auxiliary power meter connected to a directional coupler. While the dipole under test is connected, the forward power is adjusted to the same level.
- *Antenna Positioning:* The dipole is mounted on a HAC Test Arch phantom using the matching dipole positioner with the arms horizontal and the feeding cable coming from the floor. The measurements are performed in a shielded room with absorbers around the setup to reduce the reflections. It is verified before the mounting of the dipole under the Test Arch phantom, that its arms are perfectly in a line. It is installed on the HAC dipole positioner with its arms parallel below the dielectric reference wire and able to move elastically in vertical direction without changing its relative position to the top center of the Test Arch phantom. The vertical distance to the probe is adjusted after dipole mounting with a DASY5 Surface Check job. Before the measurement, the distance between phantom surface and probe tip is verified. The proper measurement distance is selected by choosing the matching section of the HAC Test Arch phantom with the proper device reference point (upper surface of the dipole) and the matching grid reference point (tip of the probe) considering the probe sensor offset. The vertical distance to the probe is essential for the accuracy.
- *Feed Point Impedance and Return Loss:* These parameters are measured using a HP 8753E Vector Network Analyzer. The impedance is specified at the SMA connector of the dipole. The influence of reflections was eliminated by applying the averaging function while moving the dipole in the air, at least 70cm away from any obstacles.
- *E-field distribution:* E field is measured in the x-y-plane with an isotropic ER3D-field probe with 100 mW forward power to the antenna feed point. In accordance with [1] and [2], the scan area is 20mm wide, its length exceeds the dipole arm length (180 or 90mm). The sensor center is 10 mm (15 mm for [2]) (in z) above the metal top of the dipole arms. Two 3D maxima are available near the end of the dipole arms. Assuming the dipole arms are perfectly in one line, the average of these two maxima (in subgrid 2 and subgrid 8) is determined to compensate for any non-parallelity to the measurement plane as well as the sensor displacement. The E-field value stated as calibration value represents the maximum of the interpolated 3D-E-field, in the plane above the dipole surface.
- *H-field distribution:* H-field is measured with an isotropic H-field probe with 100mW forward power to the antenna feed point, in the x-y-plane. The scan area and sensor distance is equivalent to the E-field scan. The maximum of the field is available at the center (subgrid 5) above the feed point. The H-field value stated as calibration value represents the maximum of the interpolated H-field, 10mm above the dipole surface at the feed point.

The reported uncertainty of measurement is stated as the standard uncertainty of measurement multiplied by the coverage factor $k=2$, which for a normal distribution corresponds to a coverage probability of approximately 95%.

Measurement Conditions

DASY system configuration, as far as not given on page 1.

DASY Version	DASY5	V52.8.6
Extrapolation	Advanced Extrapolation	
Phantom	HAC Test Arch	
Distance Dipole Top - Probe Center	15mm	
Scan resolution	dx, dy = 5 mm	
Frequency	1880 MHz \pm 1 MHz	
Input power drift	< 0.05 dB	

Maximum Field values at 1880 MHz

E-field 15 mm above dipole surface	condition	Interpolated maximum
Maximum measured above high end	100 mW input power	91.8 V / m
Maximum measured above low end	100 mW input power	90.5 V / m
Averaged maximum above arm	100 mW input power	91.2 V / m \pm 12.8 % (k=2)

Appendix

Antenna Parameters

Frequency	Return Loss	Impedance
1730 MHz	32.2 dB	52.4 Ω + 0.8 j Ω
1880 MHz	19.2 dB	45.4 Ω + 9.4 j Ω
1900 MHz	19.8 dB	48.3 Ω + 10.0 j Ω
1950 MHz	24.0 dB	52.5 Ω + 5.9 j Ω
2000 MHz	21.0 dB	43.3 Ω + 4.9 j Ω

3.2 Antenna Design and Handling

The calibration dipole has a symmetric geometry with a built-in two stub matching network, which leads to the enhanced bandwidth.

The dipole is built of standard semirigid coaxial cable. The internal matching line is open ended. The antenna is therefore open for DC signals.

Do not apply force to dipole arms, as they are liable to bend. The soldered connections near the feedpoint may be damaged. After excessive mechanical stress or overheating, check the impedance characteristics to ensure that the internal matching network is not affected.

After long term use with 40W radiated power, only a slight warming of the dipole near the feedpoint can be measured.

Impedance Measurement Plot

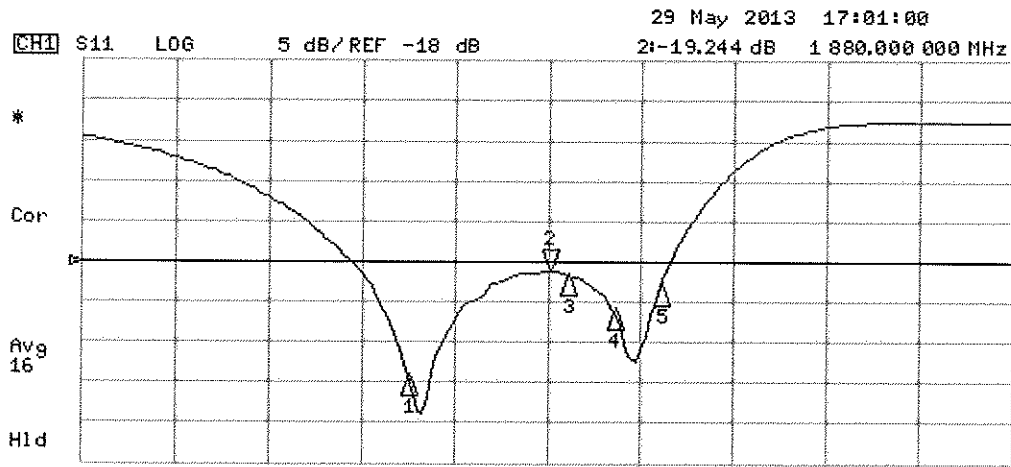

CH1 Markers

1:	-32.217 dB	1.73000 GHz
2:	-19.776 dB	1.90000 GHz
3:	-23.974 dB	1.95000 GHz
4:	-20.956 dB	2.00000 GHz

CH2 S11 1 U FS 2: 45.414 Ω 3: 4004 Ω 795.81 pF 1 880.000 000 MHz

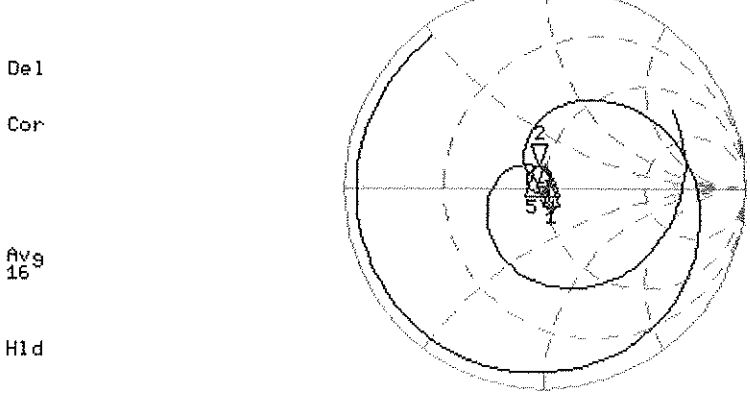

CH2 Markers

1:	52.389 Ω	0.7637 Ω	1.73000 GHz
3:	45.334 Ω	10.000 Ω	1.90000 GHz
4:	52.527 Ω	5.9092 Ω	1.95000 GHz
5:	43.271 Ω	4.8945 Ω	2.00000 GHz

CENTER 1 880.000 000 MHz

SPAN 1 000.000 000 MHz

DASY5 E-field Result

Date: 29.05.2013

Test Laboratory: SPEAG Lab2

DUT: HAC Dipole 1880 MHz; Type: CD1880V3; Serial: CD1880V3 - SN: 1117

Communication System: UID 0 - CW; Frequency: 1880 MHz
Medium parameters used: $\sigma = 0$ S/m, $\epsilon_r = 1$; $\rho = 1000$ kg/m³
Phantom section: RF Section
Measurement Standard: DASY5 (IEBE/IEC/ANSI C63.19-2007)

DASY52 Configuration:

- Probe: ER3DV6 - SN2336; ConvF(1, 1, 1); Calibrated: 28.12.2012;
- Sensor-Surface: (Fix Surface)
- Electronics: DAE4 Sn901; Calibrated: 05.06.2012
- Phantom: HAC Test Arch with AMCC; Type: SD HAC P01 BA; Serial: 1070
- DASY52 52.8.6(1115); SEMCAD X 14.6.9(7117)

Dipole E-Field measurement @ 1880MHz/E-Scan - 1880MHz d=15mm/Hearing Aid Compatibility Test (41x181x1):

Interpolated grid: dx=0.5000 mm, dy=0.5000 mm

Device Reference Point: 0, 0, -6.3 mm

Reference Value = 165.4 V/m; Power Drift = -0.01 dB

PMR not calibrated. PMF = 1.000 is applied.

E-field emissions = 91.76 V/m

Near-field category: M3 (AWF 0 dB)

PMF scaled E-field

Grid 1 M3	Grid 2 M3	Grid 3 M3
90.08 V/m	91.76 V/m	90.03 V/m
Grid 4 M3	Grid 5 M3	Grid 6 M3
70.97 V/m	71.67 V/m	70.28 V/m
Grid 7 M3	Grid 8 M3	Grid 9 M3
88.02 V/m	90.54 V/m	89.74 V/m

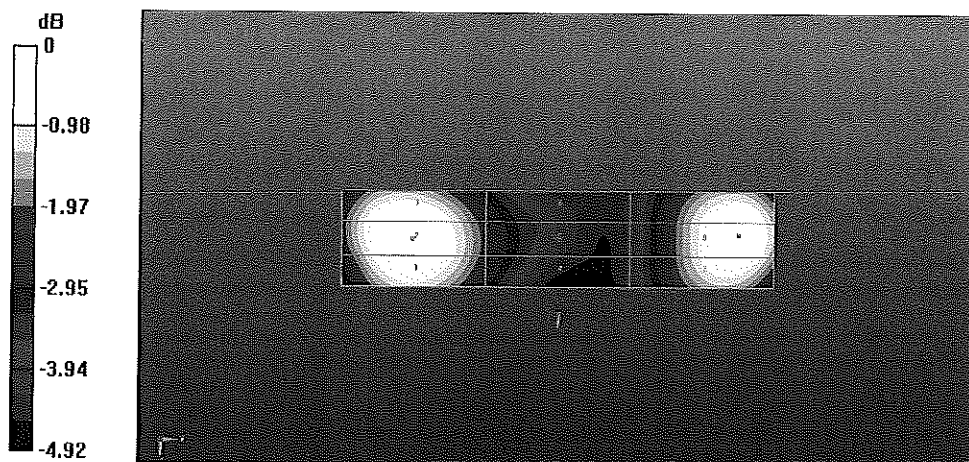

0 dB = 91.76 V/m = 39.25 dBV/m