



## SAR Test Report

Product Name : Smartphone

Model No. : 9788

FCC ID : Z5JREACH-9788

Applicant : REACH Tech (Xiamen) Co., Ltd.

Address : RM.303, #18, Guanri Road, Software Park II, Xiamen, 361008  
China

Date of Receipt : 31/05/2013

Date of Test : 05/06/2013

Issued Date : 25/06/2013

Report No. : 135S066R-HP-US-P03V01

Report Version : V2.1

The test results relate only to the samples tested.

The test report shall not be reproduced except in full without the written approval of Quietek Corporation.

# Test Report Certification

Issued Date: 25/06/2013

Report No.: 135S066R-HP-US-P03V01



Product Name : Smartphone

Applicant : REACH Tech (Xiamen) Co., Ltd.

Address : RM.303, #18, Guanri Road, Software Park II, Xiamen, 361008  
China

Manufacturer : REACH Tech (Xiamen) Co., Ltd.

Address : RM.303, #18, Guanri Road, Software Park II, Xiamen, 361008  
China

Model No. : 9788

FCC ID : Z5JREACH-9788

EUT Voltage : DC 3.7V

Applicable Standard : FCC Oet65 Supplement C June 2001  
IEEE Std. 1528-2003,47CFR § 2.1093

Test Result : Max. SAR Measurement (1g)  
Head: 1.284 W/kg  
Body: 1.454 W/kg

Performed Location : Suzhou EMC Laboratory  
No.99 Hongye Rd., Suzhou Industrial Park Loufeng Hi-Tech  
Development Zone., Suzhou, China  
TEL: +86-512-6251-5088 / FAX: +86-512-6251-5098  
FCC Registration Number: 800392

Documented By : Alice Ni  
( Alice Ni)

Reviewed By : Jame Yuan  
(Jame Yuan)

Approved By : Robin Wu  
(Robin Wu)

## Laboratory Information

We, **Quietek Corporation**, are an independent EMC and safety consultancy that was established the whole facility in our laboratories. The test facility has been accredited/accepted(audited or listed) by the following related bodies in compliance with ISO 17025, EN 45001 and specified testing scope:

<b>Taiwan R.O.C.</b>	<b>:</b>	<b>BSMI, NCC, TAF</b>
<b>Germany</b>	<b>:</b>	<b>TUV Rheinland</b>
<b>Norway</b>	<b>:</b>	<b>Nemko, DNV</b>
<b>USA</b>	<b>:</b>	<b>FCC</b>
<b>Japan</b>	<b>:</b>	<b>VCCI</b>
<b>China</b>	<b>:</b>	<b>CNAS</b>

The related certificate for our laboratories about the test site and management system can be downloaded from Quietek Corporation's Web Site :<http://www.quietek.com/tw/ctg/cts/accreditations.htm>

The address and introduction of Quietek Corporation's laboratories can be founded in our Web site :  
<http://www.quietek.com/>

If you have any comments, Please don't hesitate to contact us. Our contact information is as below:

### **HsinChu Testing Laboratory :**

No.75-2, 3<sup>rd</sup> Lin, Wangye Keng, Yonghxing Tsuen, Qionglin Shiang, Hsinchu County 307, Taiwan, R.O.C.  
TEL:+886-3-592-8858 / FAX:+886-3-592-8859 E-Mail : [service@quietek.com](mailto:service@quietek.com)

### **LinKou Testing Laboratory :**

No.5-22, Ruishukeng, Linkou Dist., New Taipei City 24451, Taiwan, R.O.C.  
TEL : 886-2-8601-3788 / FAX : 886-2-8601-3789 E-Mail : [service@quietek.com](mailto:service@quietek.com)

### **Suzhou Testing Laboratory :**

No.99 Hongye Rd., Suzhou Industrial Park Loufeng Hi-Tech Development Zone., SuZhou, China  
TEL : +86-512-6251-5088 / FAX : 86-512-6251-5098 E-Mail : [service@quietek.com](mailto:service@quietek.com)

## TABLE OF CONTENTS

<b>Description</b>	<b>Page</b>
1. General Information .....	6
1.1. EUT Description .....	6
1.2. Test Environment.....	8
1.3. EUT Antenna Locations.....	8
1.4. Simultaneous Transmission Configurations.....	9
1.5. SAR Test Exclusions Applied.....	10
1.6. Power Reduction for SAR.....	10
1.7. Guidance Documents .....	10
2. SAR Measurement System .....	11
2.1. DASY5 System Description.....	11
2.1.1. Applications .....	12
2.1.2. Area Scans .....	12
2.1.3. Zoom Scan (Cube Scan Averaging).....	12
2.1.4. Uncertainty of Inter-/Extrapolation and Averaging.....	12
2.2. DASY5 E-Field Probe.....	13
2.2.1. Isotropic E-Field Probe Specification .....	13
2.3. Boundary Detection Unit and Probe Mounting Device .....	14
2.4. DATA Acquisition Electronics (DAE) and Measurement Server.....	14
2.5. Robot.....	15
2.6. Light Beam Unit.....	15
2.7. Device Holder.....	16
2.8. SAM Twin Phantom .....	16
3. Tissue Simulating Liquid .....	17
3.1. The composition of the tissue simulating liquid .....	17
3.2. Tissue Calibration Result.....	18
3.3. Tissue Dielectric Parameters for Head and Body Phantoms.....	19
4. SAR Measurement Procedure.....	20
4.1. SAR System Validation.....	20
4.1.1. Validation Dipoles .....	20
4.1.2. Validation Result .....	21
4.2. SAR Measurement Procedure.....	23
4.3. Body-Worn Accessory Configurations .....	24

---

4.4.	Wireless Router Configurations .....	25
4.5.	SAR Measurement Conditions for UMTS .....	26
4.5.1.	Output Power Verification .....	26
4.5.2.	Head SAR Measurements for Handsets .....	26
4.5.3.	Body SAR Measurements.....	26
4.5.4.	SAR Measurements for Handsets with Rel 5 HSDPA .....	26
4.5.5.	SAR Measurements for Handsets with Rel 6 HSUPA .....	27
5.	SAR Exposure Limits.....	28
6.	Test Equipment List .....	29
7.	Measurement Uncertainty.....	38
8.	Conducted Power Measurement .....	39
9.	Test Results .....	44
9.1.	SAR Test Results Summary .....	44
9.2.	SAR Test Notes .....	56
Appendix A.	SAR System Validation Data .....	60
Appendix B.	SAR measurement Data.....	68
Appendix C.	Test Setup Photographs & EUT Photographs .....	149
Appendix D.	Probe Calibration Data .....	158
Appendix E.	Dipole Calibration Data.....	169
Appendix F.	DAE Calibration Data .....	202

## 1. General Information

### 1.1. EUT Description

Product Name	Smartphone
Model No.	9788
IMEI	356002031005000
Hardware Version	SR701_V3.0
Software Version	E9788C_1.1.2332.0021_20130516_SHIP_TM35_HX8357C_FT6X06_ASD_QCN
Device Category	Portable
RF Exposure Environment	Uncontrolled
Antenna Type	Internal
<b>GPS</b>	
Operate Frequency	1575.42MHz
Type of modulation	BPSK
<b>2G</b>	
Support Band	GSM850/PCS1900
GPRS Type	Class B
GPRS Class	Class 12
Uplink	GSM 850: 824~849MHz PCS 1900: 1850~1910MHz
Downlink	GSM 850: 869~894MHz PCS 1900: 1930~1990MHz
Release Version	R99
Type of modulation	GMSK for GSM/GPRS/EDGE
Antenna Gain	GSM 850: -1.5dBi PCS1900: -0.5dBi
Max. Output Power (Conducted)	GSM850: 32.06dBm PCS1900: 29.20dBm
Max. Output Power (Radiated)	GSM850: 30.08dBm- ERP PCS1900: 28.49dBm- EIRP
<b>3G</b>	
Support Band	WCDMA Band II/WCDMA Band IV/WCDMA Band V
Uplink	WCDMA Band II: 1850~1910MHz WCDMA Band IV: 1710~1755MHz WCDMA Band V: 824~849MHz

Downlink	WCDMA Band II: 1930~1990MHz WCDMA Band IV: 2110~2155MHz WCDMA Band V: 869~894MHz
Release Version	Rel-6
Type of modulation	QPSK
Antenna Gain	WCDMA Band II: -0.5dBi WCDMA Band IV: 0.5dBi WCDMA Band V: -1.5dBi
Max. Output Power (Conducted)	WCDMA Band II: 22.81dBm WCDMA Band IV: 22.51dBm WCDMA Band V: 23.19dBm
Max. Output Power (Radiated)	WCDMA Band II: 22.10dBm – EIRP WCDMA Band IV: 22.87dBm - EIRP WCDMA Band V: 21.23dBm - ERP
<b>Bluetooth</b>	
Bluetooth Frequency	2402~2480MHz
Bluetooth Version	V3.0
Type of modulation	FHSS
Data Rate	1Mbps(GFSK), 2Mbps(Pi/4 DQPSK), 3Mbps (8DPSK)
Antenna Gain	-2.5dBi
<b>Wi-Fi</b>	
Hotspots Function	YES
Wi-Fi Frequency	802.11b/g/n(20MHz): 2412 ~ 2462 MHz
Type of modulation	802.11b: DSSS; 802.11g/n: OFDM
Data Rate	802.11b: 1/2/5.5/11 Mbps
	802.11g: 6/9/12/18/24/36/48/54 Mbps
	802.11n: up to 65 Mbps
Antenna Gain	-2.5dBi

1.2. Test Environment

Ambient conditions in the laboratory:

Items	Required	Actual
Temperature (°C)	18-25	21.5± 2
Humidity (%RH)	30-70	52

1.3. EUT Antenna Locations

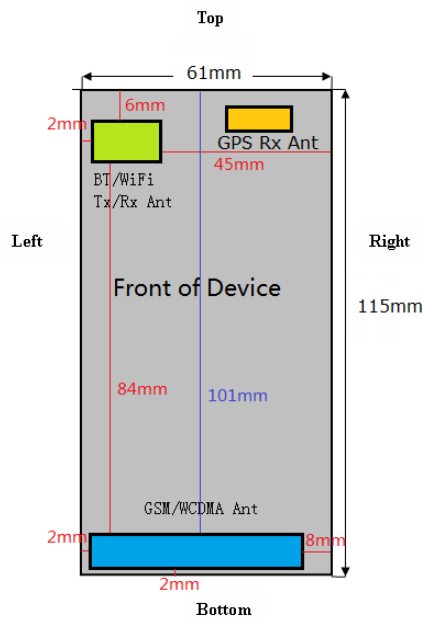

Note: Specific antenna dimensions and separation distances are shown in the EUT Photo.

Mobile Hotspot Sides for SAR Testing

Mode	Back	Front	Top	Bottom	Right	Left
GPRS850	Yes	Yes	No	Yes	Yes	Yes
GPRS1900	Yes	Yes	No	Yes	Yes	Yes
UMTS850	Yes	Yes	No	Yes	Yes	Yes
UMTS1700	Yes	Yes	No	Yes	Yes	Yes
UMTS1900	Yes	Yes	No	Yes	Yes	Yes
2.4GHz WLAN	Yes	Yes	Yes	No	No	Yes

Note: Particular DUT edges were not required to be evaluated for Wireless Router SAR if the edges were greater than 2.5 cm from the transmitting antenna according to FCC KDB Publication 941225 D06v01 guidance, page 2. The antenna photo shows the distances between the transmit antennas and the edges of the device.



**1.4. Simultaneous Transmission Configurations**

According to FCC KDB Publication 447498 D05v01, transmitter are considered to be transmitting simultaneously when there is overlapping transmission, with the exception of transmissions during network hand-offs with maximum hand-off duration less than 30 seconds. This device contains multiple transmitters that may operate simultaneously, and therefore requires a simultaneously transmission analysis according to FCC KDB Publication 447498 D01v05 3) procedures.

**Table 1-1  
Simultaneous Transmission Scenarios**

Ref.	Simultaneous Transmit Configurations	Head	Body-Worn Accessory	Hotspot	Note
		IEEE1528 Supp C	Supplement C	FCC KDB941225 D06	
1	GSM850 Voice + 2.4GHz Bluetooth	No	Yes	No	
2	GSM1900 Voice + 2.4GHz Bluetooth	No	Yes	No	
3	UMTS850 Voice + 2.4GHz Bluetooth	No	Yes	No	
4	UMTS1700 Voice + 2.4GHz Bluetooth	No	Yes	No	
5	UMTS1900 Voice + 2.4GHz Bluetooth	No	Yes	No	
6	GSM850 Voice + 2.4GHz Wi-Fi	Yes	Yes	No	
7	GSM1900 Voice + 2.4GHz Wi-Fi	Yes	Yes	No	
8	UMTS850 Voice + 2.4GHz Wi-Fi	Yes	Yes	No	
9	UMTS1700 Voice + 2.4GHz Wi-Fi	Yes	Yes	No	
10	UMTS1900 Voice + 2.4GHz Wi-Fi	Yes	Yes	No	
11	GPRS850 Data + 2.4GHz Wi-Fi	No	No	Yes	GPRS + Wi-Fi Hotspot
12	GPRS1900 Data + 2.4GHz Wi-Fi	No	No	Yes	GPRS + Wi-Fi Hotspot
13	UMTS850 Data + 2.4GHz Wi-Fi	Yes	Yes	Yes	UMTS + Wi-Fi Hotspot
14	UMTS1700 Data + 2.4GHz Wi-Fi	Yes	Yes	Yes	UMTS + Wi-Fi Hotspot
15	UMTS190 Data + 2.4GHz Wi-Fi	Yes	Yes	Yes	UMTS + Wi-Fi Hotspot

Note: Bluetooth and WIFI share the same antenna and cannot transmit simultaneously.

## 1.5. SAR Test Exclusions Applied

### (A) Wi-Fi/Bluetooth

Per FCC KDB 447498 D01v05, the SAR exclusion threshold for distances < 50mm is defined by the following equation:

$$\frac{\text{Max Power of Channel (mW)}}{\text{Test Separation Dist (mm)}} * \sqrt{\text{Frequency (GHz)}} \leq 3.0$$

Based on the maximum conducted power of Bluetooth and the antenna to use separation distance, Bluetooth SAR was not required;  $[(3.47\text{mW}/10) * \sqrt{2.480}] = 0.55 < 3.0$ .

IEEE 802.11g/n were not evaluated for SAR since the average output power was not more than 0.25 dB higher than the average output power of IEEE 802.11b.

### (B) Licensed Transmitter(s)

GSM/GPRS/EDGE DTM is not supported for US bands. Therefore, the GSM Voice modes in this report do not transmit simultaneously with GPRS/EDGE Data.

This device is only capable of QPSK HSUPA in the uplink. Therefore, no additional SAR tests are required beyond that described for devices with HSUPA in KDB 941225 D01v02.

When the user utilizes multiple services in UMTS 3G mode it uses multi-Radio Access Bearer or multi-RAB. The power control is based on a physical control channel (Dedicated Physical Control Channel [DPCCH]) and power control will be adjusted to meet the needs of both services. Therefore, the UMTS+WLAN scenario also represents the UMTS Voice/DATA + WLAN Hotspot scenario.

## 1.6. Power Reduction for SAR

There is no power reduction used for any band/mode implemented in this device for SAR purposes.

## 1.7. Guidance Documents

- 1) FCC KDB Publication 941225 D01-D06 (2G/3G and Hotspot)
- 2) FCC KDB Publication 447498 D01v05 (General SAR Guidance)
- 3) FCC KDB Publication 865664 D01v01 (SAR measurement 100 MHz to 6 GHz)
- 4) FCC KDB Publication 248227 D01v01r02 (SAR Considerations for 802.11 Devices)

## 2. SAR Measurement System

### 2.1. DASY5 System Description

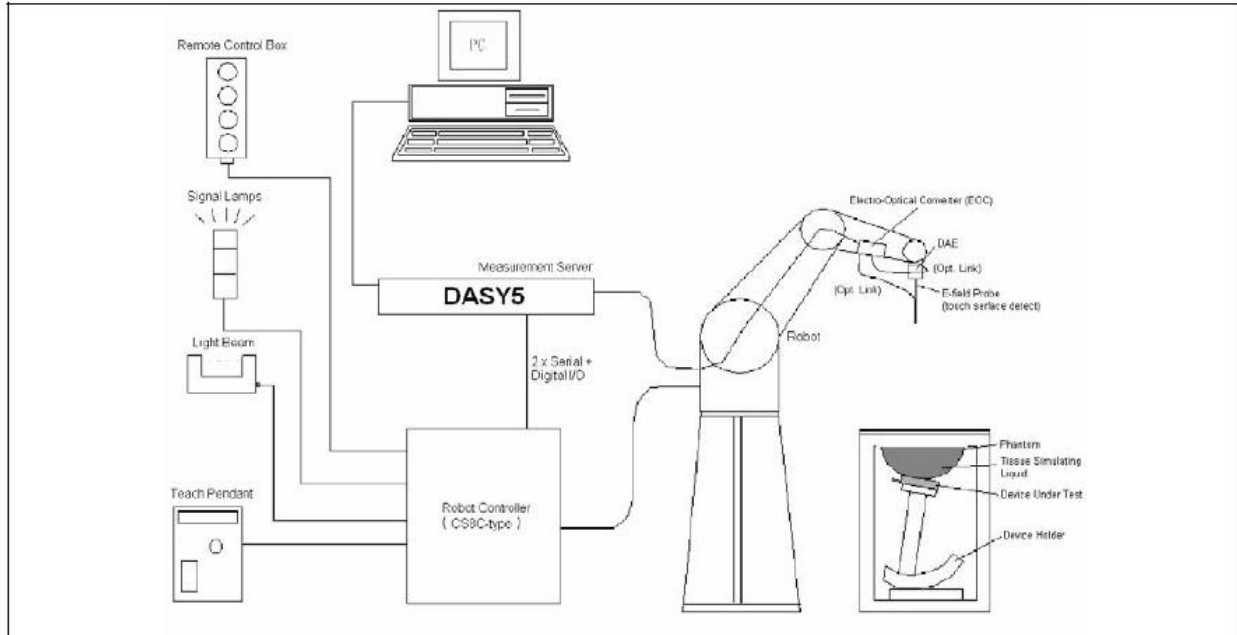

The DASY5 system for performing compliance tests consists of the following items:

- A standard high precision 6-axis robot with controller, teach pendant and software. An arm extension for accommodating the data acquisition electronics (DAE).
- A data acquisition electronics (DAE) which performs the signal amplification, signal multiplexing, AD-conversion, offset measurements, mechanical surface detection, collision detection, etc. The unit is battery powered with standard or rechargeable batteries. The signal is optically transmitted to the EOC.
- The Electro-optical converter (EOC) performs the conversion from optical to electrical signals for the digital communication to the DAE. To use optical surface detection, a special version of the EOC is required. The EOC signal is transmitted to the measurement server.
- The Light Beam used is for probe alignment. This improves the (absolute) accuracy of the probe positioning.
- A computer running WinXP and the DASY5 software.
- Remote control and teach pendant as well as additional circuitry for robot safety such as warning lamps, etc.
- The phantom, the device holder and other accessories according to the targeted measurement.

### **2.1.1. Applications**

Predefined procedures and evaluations for automated compliance testing with all worldwide standards, e.g., IEEE 1528, OET 65, IEC 62209-1, IEC 62209-2, EN 50360, EN 50383 and others.

### **2.1.2. Area Scans**

Area scans are defined prior to the measurement process being executed with a user defined variable spacing between each measurement point (integral) allowing low uncertainty measurements to be conducted. Scans defined for FCC applications utilize a 10mm<sup>2</sup> step integral, with 1mm interpolation used to locate the peak SAR area used for zoom scan assessments.

When an Area Scan has measured all reachable points, it computes the field maxima found in the scanned area, within a range of the global maximum. The range (in dB) is specified in the standards for compliance testing. For example, a 2 dB range is required in IEEE 1528-2003 and IEC 62209 standards, whereby 3 dB is a requirement when compliance is assessed in accordance with the ARIB standard (Japan).

### **2.1.3. Zoom Scan (Cube Scan Averaging)**

Zoom Scans are used to assess the peak spatial SAR values within a cubic averaging volume containing 1 g and 10 g of simulated tissue. A density of 1000 kg/m<sup>3</sup> is used to represent the head and body tissue density and not the phantom liquid density, in order to be consistent with the definition of the liquid dielectric properties, i.e. the side length of the 1 g cube is 10mm, with the side length of the 10 g cube 21,5mm.

The zoom scan integer steps can be user defined so as to reduce uncertainty, but normal practice for typical test applications utilize a physical step of 7x7x7 (5mmx5mmx5mm) providing a volume of 30mm in the X & Y axis, and 30mm in the Z axis.

### **2.1.4. Uncertainty of Inter-/Extrapolation and Averaging**

In order to evaluate the uncertainty of the interpolation, extrapolation and averaged SAR calculation algorithms of the Postprocessor, DASY5 allows the generation of measurement grids which are artificially predefined by analytically based test functions. Therefore, the grids of area scans and zoom scans can be filled with uncertainty test data, according to the SAR benchmark functions of IEEE 1528. The three analytical functions shown in equations as below are used to describe the possible range of the expected SAR distributions for the tested handsets. The field gradients are covered by the spatially flat distribution f1, the spatially steep distribution f3 and f2 accounts for H-field cancellation on the phantom/tissue surface.

$$f_1(x, y, z) = Ae^{-\frac{z}{2a}} \cos^2 \left( \frac{\pi \sqrt{x'^2 + y'^2}}{2 \cdot 5a} \right)$$

$$f_2(x, y, z) = Ae^{-\frac{z}{a}} \frac{a^2}{a^2 + x'^2} \left( 3 - e^{-\frac{2z}{a}} \right) \cos^2 \left( \frac{\pi y'}{2 \cdot 3a} \right)$$

$$f_3(x, y, z) = A \frac{a^2}{\frac{a^2}{4} + x'^2 + y'^2} \left( e^{-\frac{2z}{a}} + \frac{a^2}{2(a + 2z)^2} \right)$$

**2.2. DASY5 E-Field Probe**

The SAR measurement is conducted with the dosimetric probe manufactured by SPEAG. The probe is specially designed and calibrated for use in liquid with high permittivity. The dosimetric probe has special calibration in liquid at different frequency. SPEAG conducts the probe calibration in compliance with international and national standards (e.g. IEEE 1528, EN 62209-1, IEC 62209, etc.) under ISO 17025. The calibration data are in Appendix D.

**2.2.1. Isotropic E-Field Probe Specification**

<b>Model</b>	EX3DV4	
<b>Construction</b>	Symmetrical design with triangular core Built-in shielding against static charges PEEK enclosure material (resistant to organic solvents, e.g., DGBE)	
<b>Frequency</b>	10 MHz to 6 GHz Linearity: ± 0.2 dB (30 MHz to 6 GHz)	
<b>Directivity</b>	± 0.3 dB in HSL (rotation around probe axis) ± 0.5 dB in tissue material (rotation normal to probe axis)	
<b>Dynamic Range</b>	10 µW/g to 100 mW/g Linearity: ± 0.2 dB (noise: typically < 1 µW/g)	
<b>Dimensions</b>	Overall length: 330 mm (Tip: 20 mm) Tip diameter: 2.5 mm (Body: 12 mm) Typical distance from probe tip to dipole centers: 1 mm	
<b>Application</b>	High precision dosimetric measurements in any exposure scenario (e.g., very strong gradient fields). Only probe which enables compliance testing for frequencies up to 6 GHz with precision of better 30%.	

**2.3. Boundary Detection Unit and Probe Mounting Device**

The DASY5 probes use a precise connector and an additional holder for the probe, consisting of a plastic tube and a flexible silicon ring to center the probe. The connector at the DAE is flexibly mounted and held in the default position with magnets and springs. Two switching systems in the connector mount detect frontal and lateral probe collisions and trigger the necessary software response.

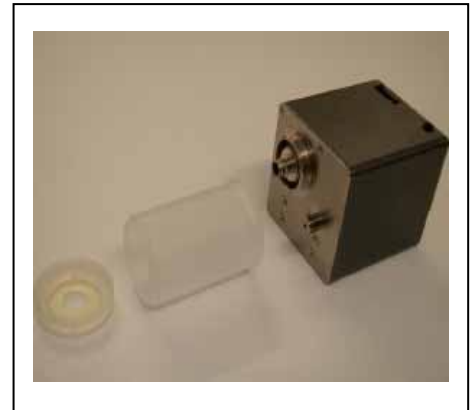

**2.4. DATA Acquisition Electronics (DAE) and Measurement Server**

The data acquisition electronics (DAE) consists of a highly sensitive electrometer-grade preamplifier with auto-zeroing, a channel and gain-switching multiplexer, a fast 16 bit AD-converter and a command decoder and control logic unit.



Transmission to the measurement server is accomplished through an optical downlink for data and status information as well as an optical uplink for commands and the clock.

The input impedance of the DAE4 is 200M Ohm; the inputs are symmetrical and floating. Common mode rejection is above 80dB.

The DASY5 measurement server is based on a PC/104 CPU board with a 400MHz intel ULV Celeron, 128MB chipdisk and 128MB RAM. The necessary circuits for communication with the DAE electronics box, as well as the 16 bit AD converter system for optical detection and digital I/O interface are contained on the DASY5 I/O board, which is directly connected to the PC/104 bus of the CPU board.



**2.5. Robot**

The DASY5 system uses the high precision robots TX90 XL type out of the newer series from Stäubli SA (France). For the 6-axis controller DASY5 system, the CS8C robot controller version from Stäubli is used.

The XL robot series have many features that are important for our application:

- High precision (repeatability 0.02 mm)
- High reliability (industrial design)
- Jerk-free straight movements
- Low ELF interference (the closed metallic construction shields against motor control fields)
- 6-axis controller



**2.6. Light Beam Unit**

The light beam switch allows automatic "tooling" of the probe. During the process, the actual position of the probe tip with respect to the robot arm is measured, as well as the probe length and the horizontal probe offset. The software then corrects all movements, such that the robot coordinates are valid for the probe tip.

The repeatability of this process is better than 0.1 mm. If a position has been taught with an aligned probe, the same position will be reached with another aligned probe within 0.1 mm, even if the other probe has different dimensions. During probe rotations, the probe tip will keep its actual position.





## 2.7. Device Holder

The DASY5 device holder is designed to cope with different positions given in the standard. It has two scales for the device rotation (with respect to the body axis) and the device inclination (with respect to the line between the ear reference points). The rotation center for both scales is the ear reference point (EPR).

Thus the device needs no repositioning when changing the angles.

The DASY5 device holder has been made out of low-loss POM material having the following dielectric parameters: relative permittivity  $\epsilon_r = 3$  and loss tangent  $\delta = 0.02$ . The amount of dielectric material has been reduced in the closest vicinity of the device, since measurements have suggested that the influence of the clamp on the test results could thus be lowered.



## 2.8. SAM Twin Phantom

The SAM twin phantom is a fiberglass shell phantom with 2mm shell thickness (except the ear region where shell thickness increases to 6mm). It has three measurement areas:

- Left head
- Right head
- Flat phantom



The bottom plate contains three pair of bolts for locking the device holder. The device holder positions are adjusted to the standard measurement positions in the three sections. A white cover is provided to tap the phantom during off-periods to prevent water evaporation and changes in the liquid parameters. On the phantom top, three reference markers are provided to identify the phantom position with respect to the robot.



### 3. Tissue Simulating Liquid

#### 3.1. The composition of the tissue simulating liquid

INGREDIENT (% Weight)	835MHz Head	835MHz Body	1800MHz Head	1800MHz Body
<b>Water</b>	40.45	52.4	52.64	40.5
<b>Salt</b>	1.45	1.40	0.36	0.5
<b>Sugar</b>	57.6	45.0	0.00	58
<b>HEC</b>	0.40	1.00	0.00	0.5
<b>Preventol</b>	0.10	0.20	0.00	0.5
<b>DGBE</b>	0.00	0.00	47.0	0.00

INGREDIENT (% Weight)	1900MHz Head	1900MHz Body	2450MHz Head	2450MHz Body
<b>Water</b>	54.90	40.5	46.7	73.2
<b>Salt</b>	0.18	0.50	0.00	0.04
<b>Sugar</b>	0.00	58.0	0.00	0.00
<b>HEC</b>	0.00	0.50	0.00	0.00
<b>Preventol</b>	0.00	0.50	0.00	0.00
<b>DGBE</b>	44.92	0.00	53.3	26.7

**3.2. Tissue Calibration Result**

The dielectric parameters of the liquids were verified prior to the SAR evaluation using DASY5 Dielectric Probe Kit and Agilent Vector Network Analyzer E5071C

<b>Head Tissue Simulant Measurement</b>				
Frequency [MHz]	Description	Dielectric Parameters		Tissue Temp. [°C]
		$\epsilon_r$	$\sigma$ [s/m]	
835 MHz	Reference result ± 5% window	41.50 39.43 to 43.58	0.90 0.86 to 0.95	N/A
	07-06-2013	41.13	0.87	21.0
1800 MHz	Reference result ± 5% window	40.00 38.00 to 42.00	1.40 1.33 to 1.47	N/A
	07-06-2013	39.32	1.40	21.0
1900 MHz	Reference result ± 5% window	40.00 38.00 to 42.00	1.40 1.33 to 1.47	N/A
	07-06-2013	38.88	1.45	21.0
2450MHz	Reference result ± 5% window	39.20 37.24to 41.16	1.80 1.62 to 1.98	N/A
	07-06-2013	39.81	1.83	21.0

<b>Body Tissue Simulant Measurement</b>				
Frequency [MHz]	Description	Dielectric Parameters		Tissue Temp. [°C]
		$\epsilon_r$	$\sigma$ [s/m]	
835 MHz	Reference result ± 5% window	55.2 52.44 to 57.96	0.97 0.92 to 1.02	N/A
	07-06-2013	52.89	0.97	21.0
1800 MHz	Reference result ± 5% window	53.3 50.64 to 55.97	1.52 1.44 to 1.60	N/A
	07-06-2013	53.26	1.44	21.0
1900 MHz	Reference result ± 5% window	53.3 50.64 to 55.97	1.52 1.44 to 1.60	N/A
	07-06-2013	52.93	1.53	21.0
2450MHz	Reference result ± 5% window	52.7 50.07 to 55.34	1.95 1.85 to 2.05	N/A
	07-06-2013	52.25	1.99	21.0

**3.3. Tissue Dielectric Parameters for Head and Body Phantoms**

The head tissue dielectric parameters recommended by the IEEE SCC-34/SC-2 in P1528 have been incorporated in the following table. These head parameters are derived from planar layer models simulating the highest expected SAR for the dielectric properties and tissue thickness variations in a human head. Other head and body tissue parameters that have not been specified in P1528 are derived from the tissue dielectric parameters computed from the 4-Cole-Cole equations described in Reference [12] and extrapolated according to the head parameters specified in P1528.

Target Frequency (MHz)	Head		Body	
	$\epsilon_r$	$\sigma$ (S/m)	$\epsilon_r$	$\sigma$ (S/m)
150	52.3	0.76	61.9	0.80
300	45.3	0.87	58.2	0.92
450	43.5	0.87	56.7	0.94
<b>835</b>	<b>41.5</b>	<b>0.90</b>	<b>55.2</b>	<b>0.97</b>
900	41.5	0.97	55.0	1.05
915	41.5	0.98	55.0	1.06
1450	40.5	1.20	54.0	1.30
1610	40.3	1.29	53.8	1.40
<b>1800 – 2000</b>	<b>40.0</b>	<b>1.40</b>	<b>53.3</b>	<b>1.52</b>
<b>2450</b>	<b>39.2</b>	<b>1.80</b>	<b>52.7</b>	<b>1.95</b>
3000	38.5	2.40	52.0	2.73
5800	35.3	5.27	48.2	6.00

( $\epsilon_r$  = relative permittivity,  $\sigma$  = conductivity and  $\rho = 1000 \text{ kg/m}^3$ )

## 4. SAR Measurement Procedure

### 4.1. SAR System Validation

#### 4.1.1. Validation Dipoles

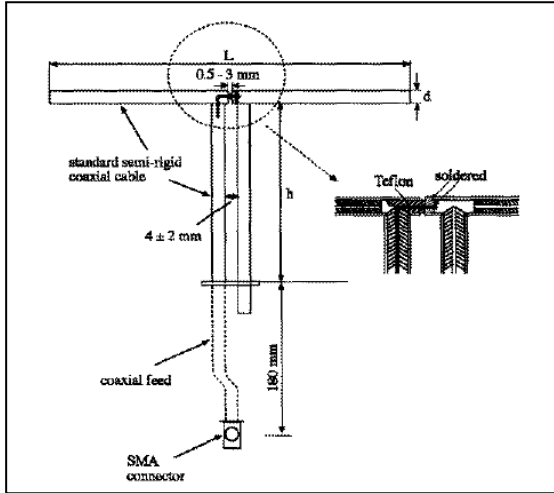

The dipoles used is based on the IEEE-1528 standard, and is complied with mechanical and electrical specifications in line with the requirements of both IEEE and FCC Supplement C. the table below provides details for the mechanical and electrical specifications for the dipoles.

Frequency	L (mm)	h (mm)	d (mm)
835MHz	161.0	89.8	3.6
1800MHz	72.0	41.7	3.6
1900MHz	68.0	39.5	3.6
2450MHz	51.5	30.4	3.6

**4.1.2. Validation Result**

<b>System Performance Check at 835MHz, 1800MHz, 1900MHz, 2450MHz for Head</b>				
<b>Validation Kit: D835V2-SN 4d120</b>				
Frequency [MHz]	Description	SAR [w/kg] 1g	SAR [w/kg] 10g	Tissue Temp. [°C]
835 MHz	Reference result ± 10% window	9.41 8.47 to 10.35	6.15 5.54 to 6.77	N/A
	07-06-2013	8.88	5.80	21.0
<b>Validation Kit: D1800V2-SN: 2d179</b>				
Frequency [MHz]	Description	SAR [w/kg] 1g	SAR [w/kg] 10g	Tissue Temp. [°C]
1800 MHz	Reference result ± 10% window	37.8 34.02 to 41.58	20.0 18.00 to 22.00	N/A
	07-06-2013	37.92	19.68	21.0
<b>Validation Kit: D1900V2-SN 5d142</b>				
Frequency [MHz]	Description	SAR [w/kg] 1g	SAR [w/kg] 10g	Tissue Temp. [°C]
1900 MHz	Reference result ± 10% window	39.4 35.46 to 43.34	20.8 18.72 to 22.88	N/A
	07-06-2013	41.60	21.08	21.0
<b>Validation Dipole: D2450V2, SN: 839</b>				
Frequency [MHz]	Frequency [MHz]	Frequency [MHz]	Frequency [MHz]	Frequency [MHz]
2450 MHz	Reference result ± 10% window	51.9 46.71 to 57.09	24.1 21.69 to 26.51	N/A
	07-06-2013	52.80	23.44	21.0
Note: All SAR values are normalized to 1W forward power.				

**System Performance Check at 835MHz, 1800MHz, 1900MHz, 2450MHz for Body**
**Validation Kit: D835V2-SN 4d120**

Frequency [MHz]	Description	SAR [w/kg] 1g	SAR [w/kg] 10g	Tissue Temp. [°C]
835 MHz	Reference result ± 10% window	9.57 8.61 to 10.53	6.33 5.70 to 6.96	N/A
	07-06-2013	9.68	6.32	21.0

**Validation Kit: D1800V2-SN: 2d179**

Frequency [MHz]	Description	SAR [w/kg] 1g	SAR [w/kg] 10g	Tissue Temp. [°C]
1800 MHz	Reference result ± 10% window	37.5 33.75 to 41.25	19.8 17.82 to 21.78	N/A
	07-06-2013	35.08	18.36	21.0

**Validation Kit: D1900V2-SN 5d142**

Frequency [MHz]	Description	SAR [w/kg] 1g	SAR [w/kg] 10g	Tissue Temp. [°C]
1900 MHz	Reference result ± 10% window	38.7 34.83 to 42.57	20.4 18.36 to 22.44	N/A
	07-06-2013	40.40	20.72	21.0

**Validation Dipole: D2450V2, SN: 839**

Frequency [MHz]	Description	SAR [w/kg] 1g	SAR [w/kg] 10g	Tissue Temp. [°C]
2450 MHz	Reference result ± 10% window	48.7 43.83 to 53.57	22.8 20.52 to 25.08	N/A
	07-06-2013	48.00	21.80	21.0

Note: All SAR values are normalized to 1W forward power.

#### 4.2. SAR Measurement Procedure

The DASY5 calculates SAR using the following equation,

$$SAR = \frac{\sigma |E|^2}{\rho}$$

$\sigma$ : represents the simulated tissue conductivity

$\rho$ : represents the tissue density

The EUT is set to transmit at the required power in line with product specification, at each frequency relating to the LOW, MID, and HIGH channel settings.

Pre-scans are made on the device to establish the location for the transmitting antenna, using a large area scan in either air or tissue simulation fluid.

The EUT is placed against the Universal Phantom where the maximum area scan dimensions are larger than the physical size of the resonating antenna. When the scan size is not large enough to cover the peak SAR distribution, it is modified by either extending the area scan size in both the X and Y directions, or the device is shifted within the predefined area.

The area scan is then run to establish the peak SAR location (interpolated resolution set at 1mm<sup>2</sup>) which is then used to orient the center of the zoom scan. The zoom scan is then executed and the 1g and 10g averages are derived from the zoom scan volume (interpolated resolution set at 1mm<sup>3</sup>).

### 4.3. Body-Worn Accessory Configurations

Body-worn operating configurations are tested with the belt-clips and holsters attached to the device and positioned against a flat phantom in a normal use configuration. Per FCC KDB Publication 648474 D04\_v01, Body-worn accessory exposure is typically related to voice mode operations when handsets are carried in body-worn accessories. The body-worn accessory procedures in FCC KDB Publication 447498 D01\_v05 should be used to test for body-worn accessory SAR compliance, without a headset connected to it. This enables the test results for such configuration to be compatible with that required for hotspot mode when the body-worn accessory test separation distance is greater than or equal to that required for hotspot mode, when applicable. When the reported SAR for a body-worn accessory, measured without a headset connected to the handset, is  $> 1.2$  W/kg, the highest reported SAR configuration for that wireless mode and frequency band should be repeated for that body-worn accessory with a headset attached to the handset.

Accessories for Body-worn operation configurations are divided into two categories: those that do not contain metallic components and those that do contain metallic components. When multiple accessories that do not contain metallic components are supplied with the device, the device is tested with only the accessory that dictates the closest spacing to the body. Then multiple accessories that contain metallic components are tested with the device with each accessory. If multiple accessories share an identical metallic component (i.e. the same metallic belt-clip used with different holsters with no other metallic components) only the accessory that dictates the closest spacing to the body is tested.

Body-worn accessories may not always be supplied or available as options for some devices intended to be authorized for body-worn use. In this case, a test configuration with a separation distance between the back of the device and the flat phantom is used. Test position spacing was documented. Transmitters that are designed to operate in front of a person's face, as in push-to-talk configurations, are tested for SAR compliance with the front of the device positioned to face the flat phantom in head fluid. For devices that are carried next to the body such as a shoulder, waist or chest-worn transmitters, SAR compliance is tested with the accessories, including headsets and microphones, attached to the device and positioned against a flat phantom in a normal use configuration.



#### 4.4. Wireless Router Configurations

Some battery-operated handsets have the capability to transmit and receive user data through simultaneous transmission of WIFI simultaneously with a separate licensed transmitter. The FCC has provided guidance in FCC KDB Publication 941225 D06 v01 where SAR test considerations for handsets ( $L \times W \geq 9 \text{ cm} \times 5 \text{ cm}$ ) are based on a composite test separation distance of 10 mm from the front, back and edges of the device containing transmitting antennas within 2.5 cm of their edges, determined from general mixed use conditions for this type of devices. Since the hotspot SAR results may overlap with the body-worn accessory SAR requirements, the more conservative configurations can be considered, thus excluding some body-worn accessory SAR tests.

When the user enables the personal wireless router functions for the handset, actual operations include simultaneous transmission of both the WIFI transmitter and another licensed transmitter. Both transmitters often do not transmit at the same transmitting frequency and thus cannot be evaluated for SAR under actual use conditions due to the limitations of the SAR assessment probes. Therefore, SAR must be evaluated for each frequency transmission and mode separately and spatially summed with the WIFI transmitter according to FCC KDB Publication 447498 D01v05 publication procedures. The "Portable Hotspot" feature on the handset was NOT activated during SAR assessments, to ensure the SAR measurements were evaluated for a single transmission frequency RF signal at a time.

## **4.5. SAR Measurement Conditions for UMTS**

### **4.5.1. Output Power Verification**

Maximum output power is measured on the High, Middle and Low channels for each applicable transmission band according to the general descriptions in section 5.2 of 3GPP TS 34.121, using the appropriate RMC or AMR with TPC (transmit power control) set to all “1s”.

Maximum output power is verified on the High, Middle and Low channels according to the general descriptions in section 5.2 of 3GPP TS 34.121 (release 5), using the appropriate RMC with TPC (transmit power control) set to all “1s” or applying the required inner loop power control procedures to maintain maximum output power while HSUPA is active. Results for all applicable physical channel configurations (DPCCH, DPDCHn and spreading codes, HS-DPCCH etc) are tabulated in this test report. All configurations that are not supported by the DUT or cannot be measured due to technical or equipment limitations are identified.

### **4.5.2. Head SAR Measurements for Handsets**

SAR for head exposure configurations is measured using the 12.2 kbps RMC with TPC bits configured to all “1s”. SAR in AMR configurations is not required when the maximum average output of each RF channel for 12.2 kbps AMR is less than 0.25 dB higher than that measured in 12.2 kbps RMC. Otherwise, SAR is measured on the maximum output channel in 12.2 AMR with a 3.4 kbps SRB (signaling radio bearer) using the exposure configuration that resulted in the highest SAR for that RF channel in the 12.2 kbps RMC mode.

### **4.5.3. Body SAR Measurements**

SAR for body exposure configurations is measured using the 12.2 kbps RMC with the TPC bits all “1s”.

### **4.5.4. SAR Measurements for Handsets with Rel 5 HSDPA**

Body SAR for HSDPA is not required for handsets with HSDPA capabilities when the maximum average output power of each RF channel with HSDPA active is less than 0.25 dB higher than that measured without HSDPA using 12.2 kbps RMC and the maximum SAR for 12.2 kbps RMC is  $\leq 75\%$  of the SAR limit. Otherwise, SAR is measured for HSDPA, using an FRC with H-Set 1 in Sub-test 1 and a 12.2 kbps RMC configured in Test Loop Mode 1, using the highest body SAR configuration measured in 12.2 kbps RMC without HSDPA, on the maximum output channel with the body exposure configuration that resulted in the highest SAR in 12.2 kbps RMC mode for that RF channel.

The H-set used in FRC for HSDPA should be configured according to the UE category of a test device. The number of HS-DSCH/HSPDSCHs, HARQ processes, minimum inter-TTI interval, transport block sizes and RV coding sequence are defined by the applicable H-set. To maintain a consistent test configuration and stable transmission conditions, QPSK is used in the FRC for SAR testing. HS-DPCCH should be configured with a CQI feedback cycle of 2 ms to maintain a constant rate of active CQI slots. DPCCH and DPDCH gain factors of  $\beta_c=9$  and  $\beta_d=15$ , and power offset parameters of  $\Delta_{ACK}=\Delta_{NACK}=5$  and  $\Delta_{CQI}=2$  is used. The CQI value is determined by the UE category, transport block size, number of HS-PDSCHs and modulation used in the FRC.

**4.5.5. SAR Measurements for Handsets with Rel 6 HSUPA**

Body SAR for HSUPA is not required when the maximum average output of each RF channel with HSUPA/HSDPA active is less than 0.25 dB higher than as measured without HSUPA/HSDPA using 12.2 kbps RMC and maximum SAR for 12.2 kbps RMC is  $\leq 75\%$  of the SAR limit. Otherwise SAR is measured on the maximum output channel for the body exposure configuration produced highest SAR in 12.2 kbps RMC for that RF channel, using the additional procedures under “Release 6 HSPA data devices”

Head SAR for VOIP operations under HSPA is not required when maximum average output of each RF channel with HSPA is less than 0.25 dB higher than as measured using 12.2 kbps RMC. Otherwise SAR is measured using same HSPA configuration as used for body SAR.

Sub-test	$\beta_c$	$\beta_d$	$\beta_d$ (SF)	$\beta_c/\beta_d$	$\beta_{1w}^{(1)}$	$\beta_{ec}$	$\beta_{ed}$	$\beta_{ed}$ (SF)	$\beta_{ed}$ (codes)	CM <sup>(2)</sup> (dB)	MPR (dB)	AG <sup>(4)</sup> Index	E-TFCI
1	11/15 <sup>(3)</sup>	15/15 <sup>(3)</sup>	64	11/15 <sup>(3)</sup>	22/15	209/225	1039/225	4	1	1.0	0.0	20	75
2	6/15	15/15	64	6/15	12/15	12/15	94/75	4	1	3.0	2.0	12	67
3	15/15	9/15	64	15/9	30/15	30/15	$\beta_{ed1}: 47/15$ $\beta_{ed2}: 47/15$	4	2	2.0	1.0	15	92
4	2/15	15/15	64	2/15	4/15	2/15	56/75	4	1	3.0	2.0	17	71
5	15/15 <sup>(4)</sup>	15/15 <sup>(4)</sup>	64	15/15 <sup>(4)</sup>	30/15	24/15	134/15	4	1	1.0	0.0	21	81

Note 1:  $\Delta_{ACK}, \Delta_{NACK}$  and  $\Delta_{CQI} = 8 \Leftrightarrow A_{1w} = \beta_{1w}/\beta_c = 30/15 \Leftrightarrow \beta_{1w} = 30/15 * \beta_c$ .

Note 2: CM = 1 for  $\beta_c/\beta_d = 12/15, \beta_{1w}/\beta_c = 24/15$ . For all other combinations of DPDCH, DPCCH, HS-DPCCH, E-DPDCH and E-DPCCH the MPR is based on the relative CM difference.

Note 3: For subtest 1 the  $\beta_c/\beta_d$  ratio of 11/15 for the TFC during the measurement period (TF1, TF0) is achieved by setting the signaled gain factors for the reference TFC (TF1, TF1) to  $\beta_c = 10/15$  and  $\beta_d = 15/15$ .

Note 4: For subtest 5 the  $\beta_c/\beta_d$  ratio of 15/15 for the TFC during the measurement period (TF1, TF0) is achieved by setting the signaled gain factors for the reference TFC (TF1, TF1) to  $\beta_c = 14/15$  and  $\beta_d = 15/15$ .

Note 5: Testing UE using E-DPDCH Physical Layer category 1 Sub-test 3 is not required according to TS 25.306 Table 5.1g.

Note 6:  $\beta_{ed}$  can not be set directly; it is set by Absolute Grant Value.

## 5. SAR Exposure Limits

SAR assessments have been made in line with the requirements of IEEE-1528, FCC Supplement C, and comply with ANSI/IEEE C95.1-1992 “Uncontrolled Environments” limits. These limits apply to a location which is deemed as “Uncontrolled Environment” which can be described as a situation where the general public may be exposed to an RF source with no prior knowledge or control over their exposure.

### Limits for General Population/Uncontrolled Exposure (W/kg)

Type Exposure	Uncontrolled Environment Limit
Spatial Peak SAR (1g cube tissue for brain or body)	1.60 W/kg
Spatial Average SAR (whole body)	0.08 W/kg
Spatial Peak SAR (10g for hands, feet, ankles and wrist)	4.00 W/kg

## 6. Test Equipment List

Instrument	Manufacturer	Model No.	Serial No.	Cali. Due Date
Stäubli Robot TX60L	Stäubli	TX60L	F10/5C90A1/A/01	only once
Controller	Stäubli	SP1	S-0034	only once
Dipole Validation Kits	Speag	D835V2	4d094	2014.02.17
Dipole Validation Kits	Speag	D1800V2	2d179	2014.02.22
Dipole Validation Kits	Speag	D1900V2	5d121	2014.02.22
Dipole Validation Kits	Speag	D2450V2	839	2014.02.23
SAM Twin Phantom	Speag	SAM	TP-1561/1562	N/A
Device Holder	Speag	SD 000 H01 HA	N/A	N/A
Data Acquisition Electronic	Speag	DAE4	1220	2014.01.24
E-Field Probe	Speag	EX3DV4	3710	2013.12.10
SAR Software	Speag	DASY5	V5.2 Build 162	N/A
Power Amplifier	Mini-Circuit	ZVA-183-S+	N657400950	N/A
Directional Coupler	Agilent	778D	20160	N/A
Universal Radio Communication Tester	R&S	CMU 200	117088	2014.04.18
Vector Network	Agilent	E5071C	MY48367267	2014.04.10
Signal Generator	Agilent	E4438C	MY49070163	2014.04.18
Power Meter	Anritsu	ML2495A	0905006	2013.11.10
Wide Bandwidth Sensor	Anritsu	MA2411B	0846014	2013.11.10

Note: Per KDB 450824 D02 requirements for dipole calibration, QuieTek Lab has adopted two years calibration intervals. On annual basis, every measurement dipole has been evaluated and is in compliance with the following criteria:

1. There is no physical damage on the dipole;
2. System validation with specific dipole is within 10% of calibrated value;
3. Return-loss is within 20% of calibrated measurement (Show below);
4. Impedance is within 5Ω of calibrated measurement (Show below).

Impedance Plot for D835V2

835 Head

Calibrated impedance: 53.5 Ω; Measured impedance: 50.322 Ω (within 5Ω)

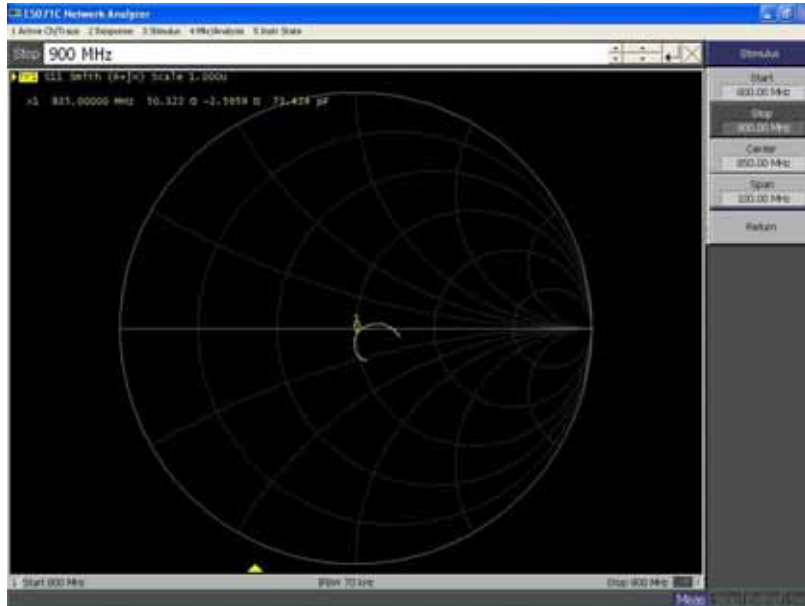

Calibrated return loss: -28.1 dB; Measured impedance: -28.246 dB (within 20%)

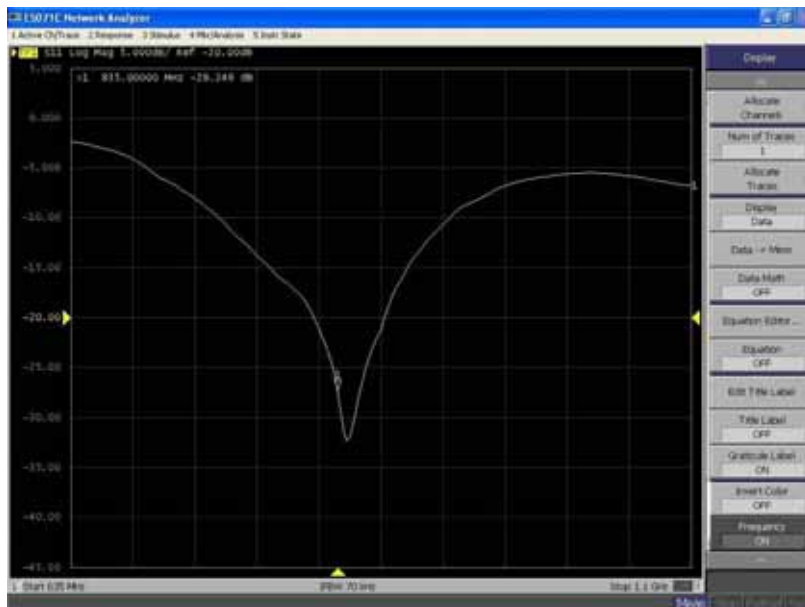

835 Body

Calibrated impedance: 47.7 Ω; Measured impedance: 48.611 Ω (within 5Ω)

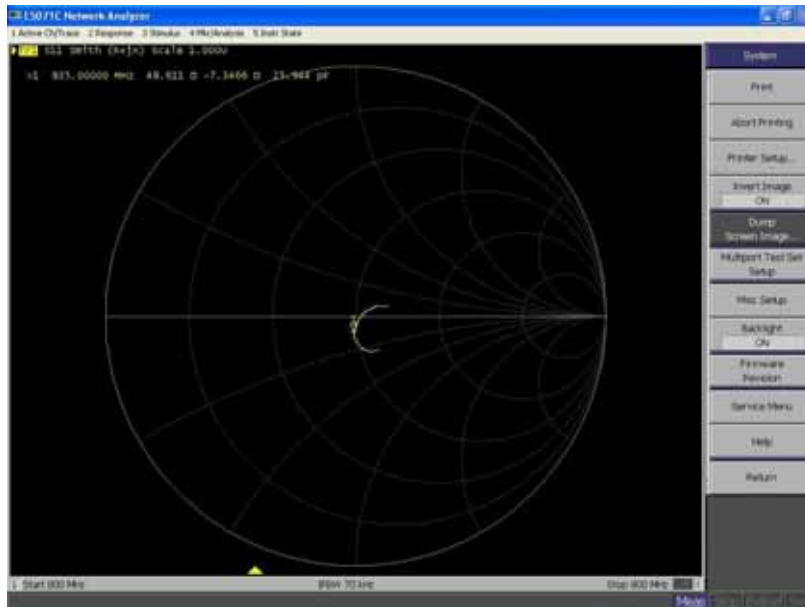

Calibrated return loss: -24.5 dB; Measured impedance: -25.333 dB (within 20%)

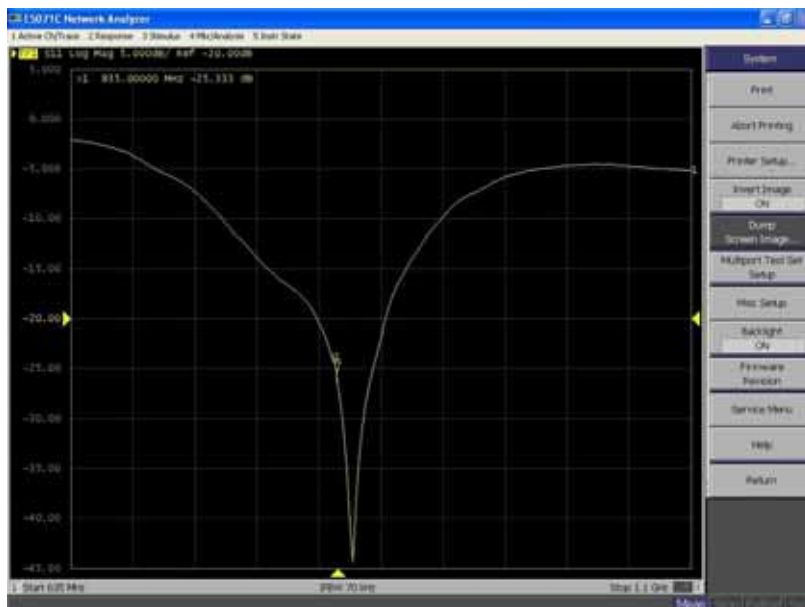

Impedance Plot for D1800V2

1800 Head

Calibrated impedance: 50.2 Ω; Measured impedance: 48.886 Ω (within 5Ω)

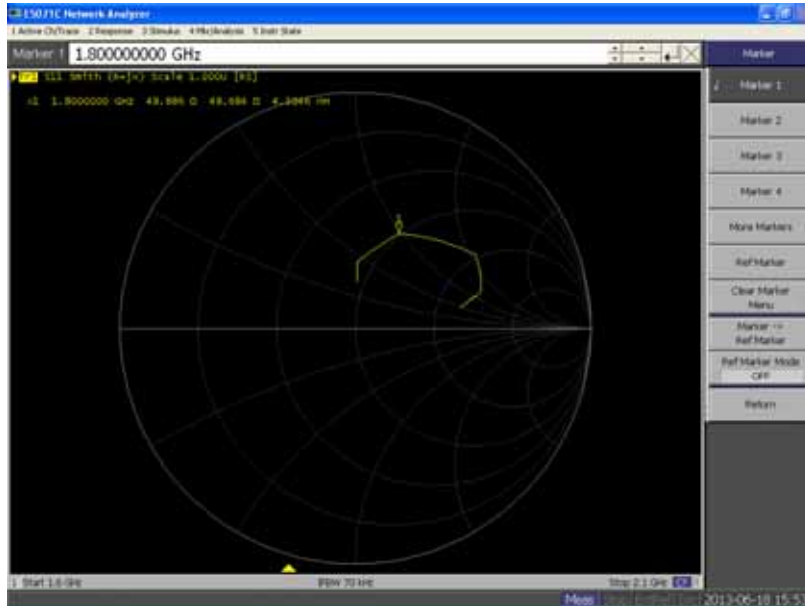

Calibrated return loss: -30.7 dB; Measured impedance: -28.569 dB (within 20%)

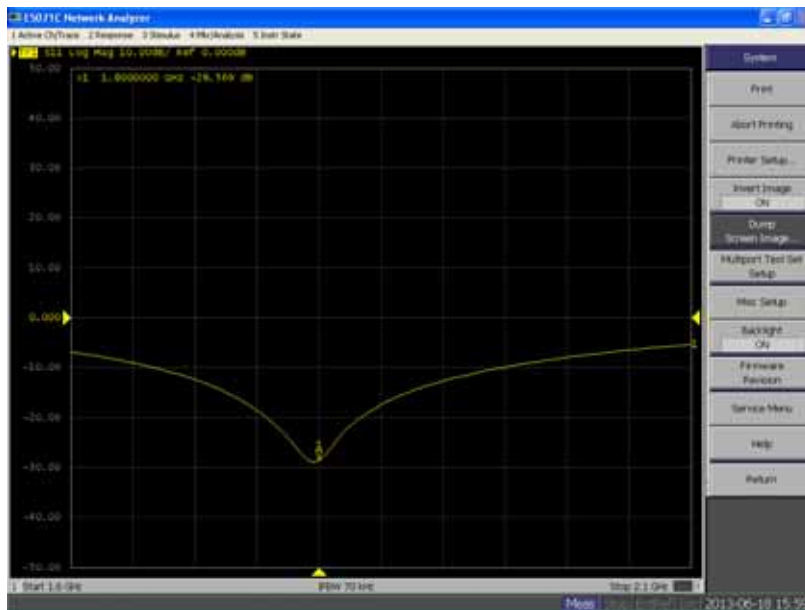



1800 Body

Calibrated impedance: 46.1  $\Omega$ ; Measured impedance: 46.570  $\Omega$  (within 5 $\Omega$ )

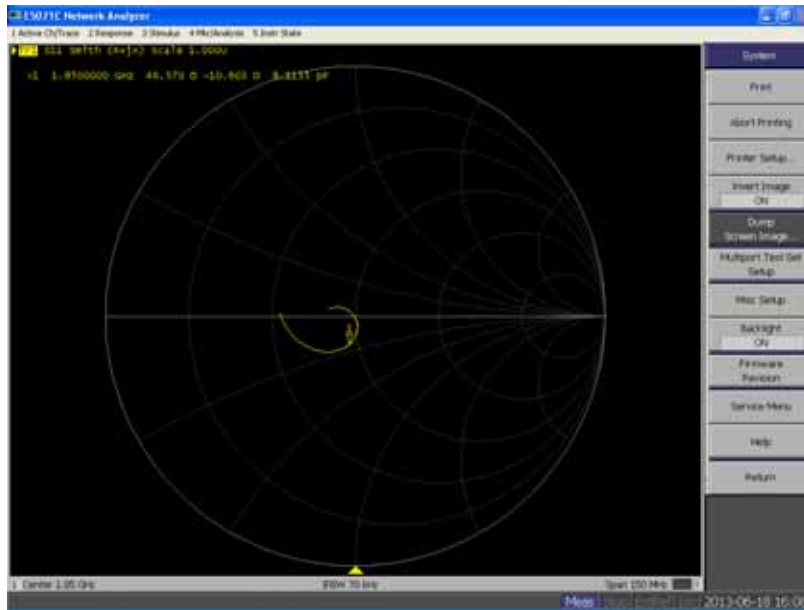

Calibrated return loss: -26 dB; Measured impedance: -26.798 dB (within 20%)

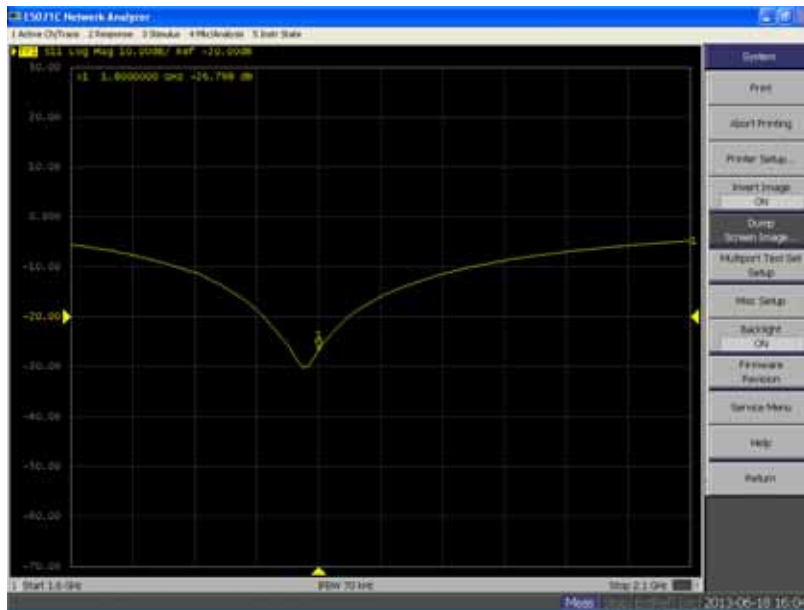

Impedance Plot for D1900V2

1900 Head

Calibrated impedance: 51.6 Ω; Measured impedance: 51.610 Ω (within 5Ω)

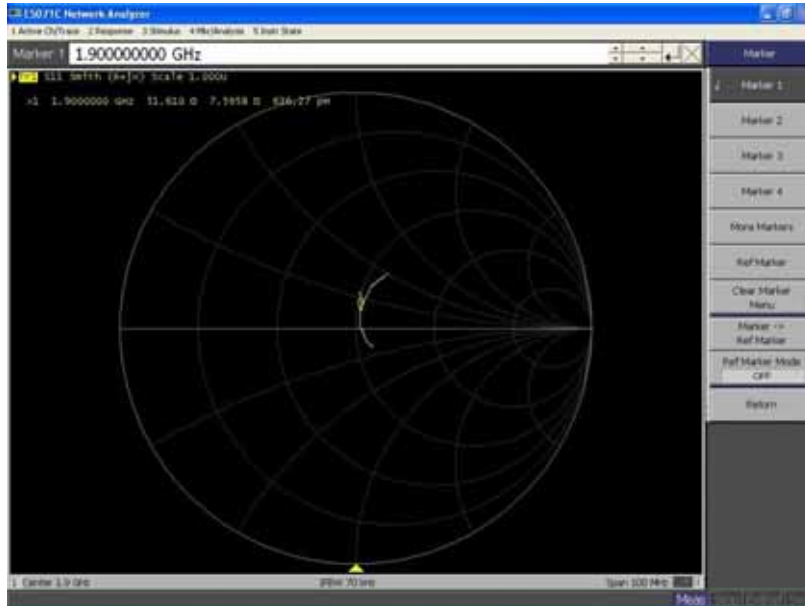

Calibrated return loss: -22.8 dB; Measured impedance: -23.651 dB (within 20%)

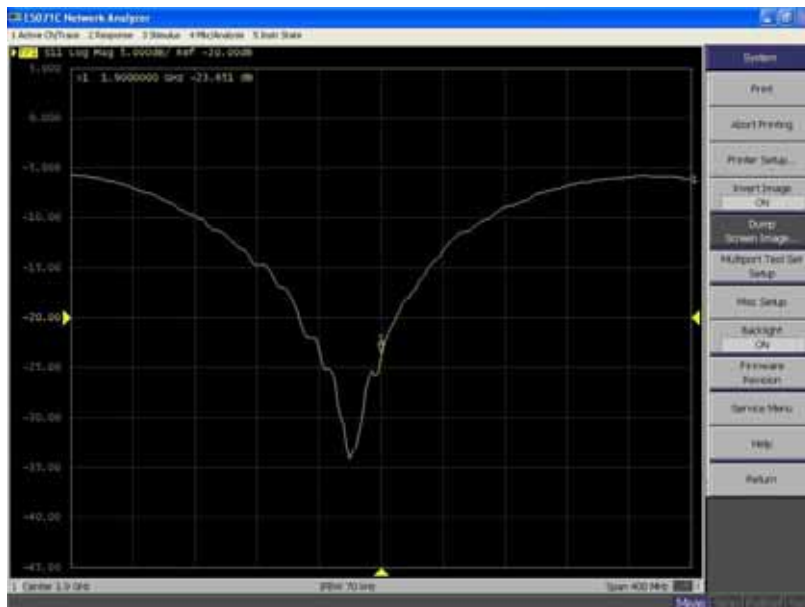

1900 Body

Calibrated impedance: 47.4 Ω; Measured impedance: 45.692 Ω (within 5Ω)

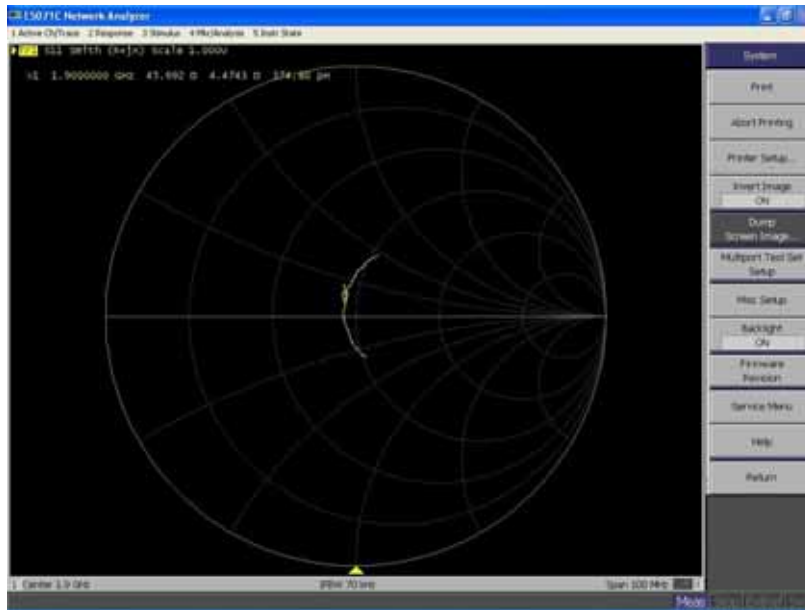

Calibrated return loss: -21.9 dB; Measured impedance: -21.900 dB (within 20%)

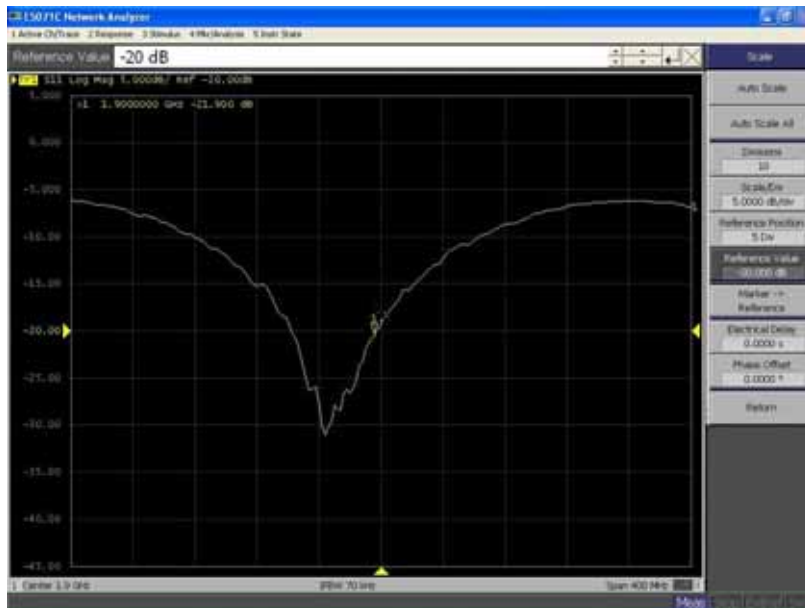

Impedance Plot for D2450V2

2450 Head

Calibrated impedance: 55.7  $\Omega$ ; Measured impedance: 52.6  $\Omega$  (within 5 $\Omega$ )

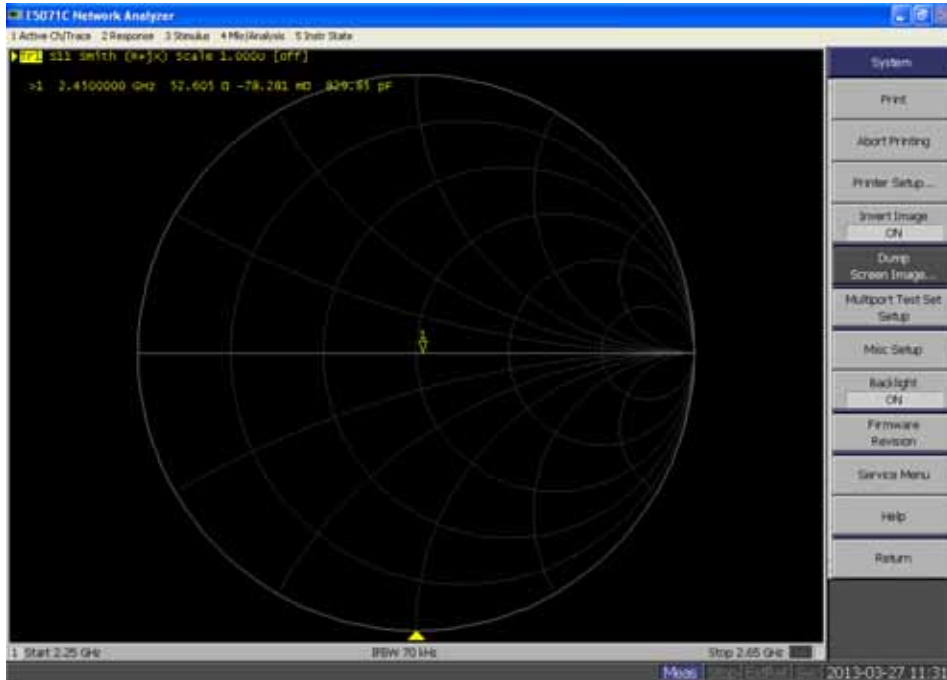

Calibrated return loss: -25.2 dB; Measured impedance: -23.9 dB (within 20%)

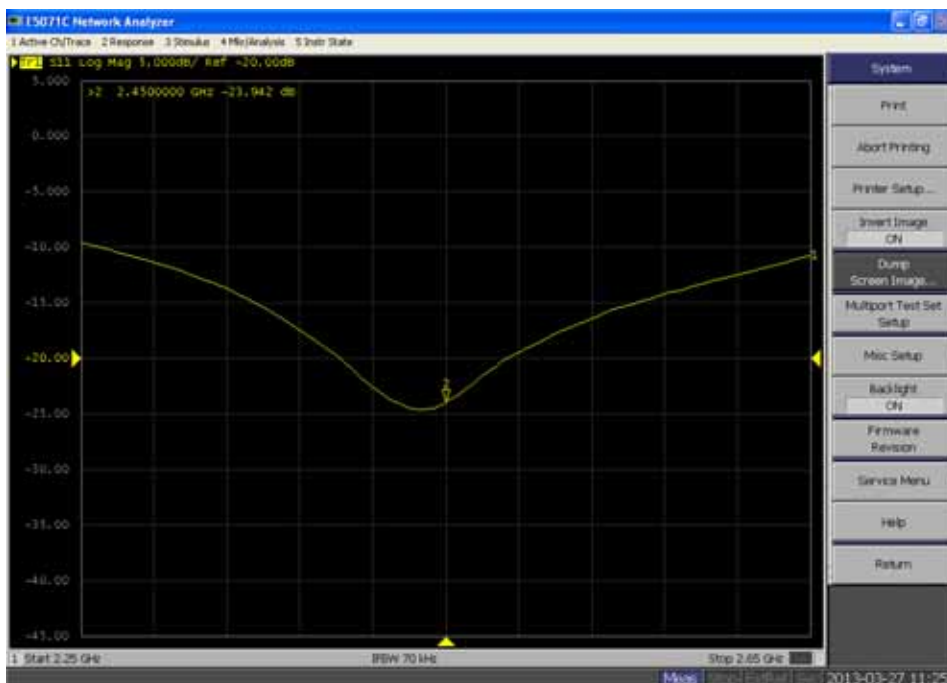

2450 Body

Calibrated impedance: 52.1 Ω; Measured impedance: 53.4 Ω (within 5Ω)

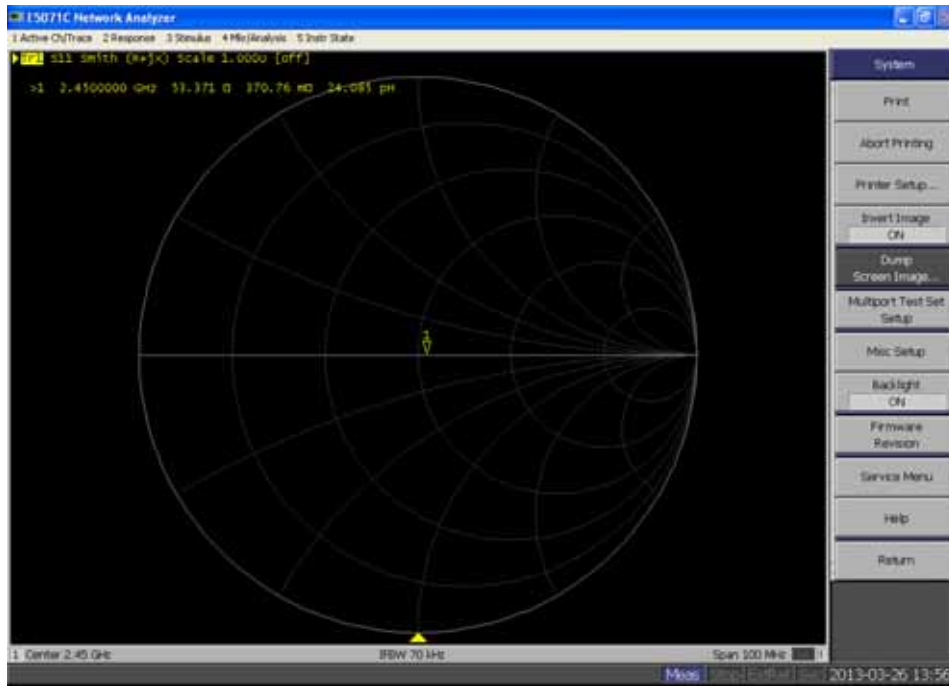

Calibrated return loss: -32.9 dB; Measured impedance: -28.4 dB (within 20%)

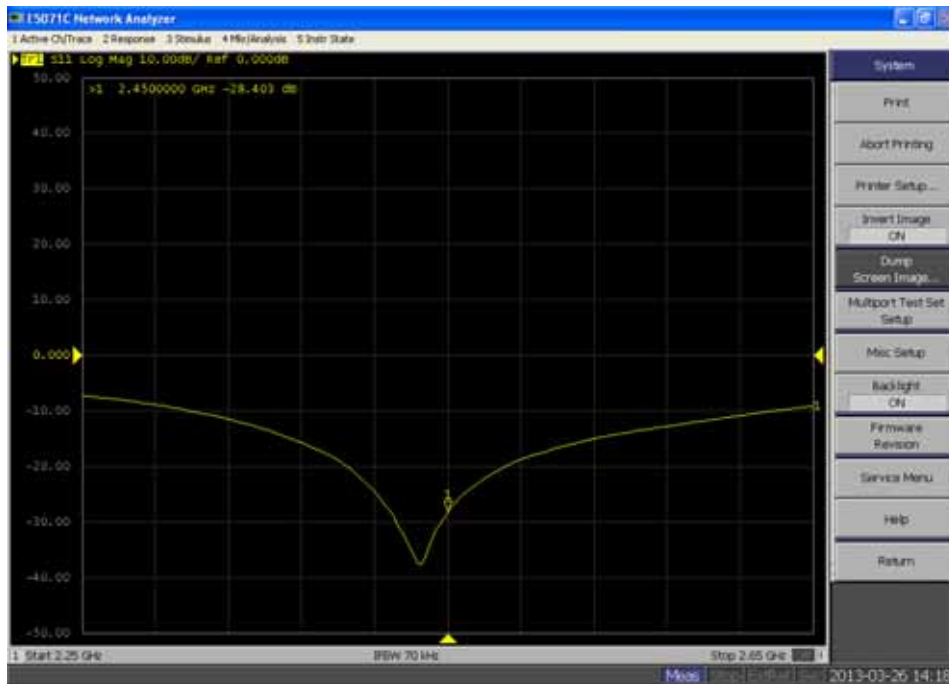

7. Measurement Uncertainty

DASY5 Uncertainty								
Measurement uncertainty for 300 MHz to 3 GHz averaged over 1 gram / 10 gram.								
Error Description	Uncert. value	Prob. Dist.	Div.	(ci) 1g	(ci) 10g	Std. Unc. (1g)	Std. Unc. (10g)	(vi) V <sub>eff</sub>
<b>Measurement System</b>								
Probe Calibration	±6.0%	N	1	1	1	±6.0%	±6.0%	∞
Axial Isotropy	±4.7%	R	√3	0.7	0.7	±1.9%	±1.9%	∞
Hemispherical Isotropy	±9.6%	R	√3	0.7	0.7	±3.9%	±3.9%	∞
Boundary Effects	±1.0%	R	√3	1	1	±0.6%	±0.6%	∞
Linearity	±4.7%	R	√3	1	1	±2.7%	±2.7%	∞
System Detection Limits	±1.0%	R	√3	1	1	±0.6%	±0.6%	∞
Readout Electronics	±0.3%	N	1	1	1	±0.3%	±0.3%	∞
Response Time	±0.8%	R	√3	1	1	±0.5%	±0.5%	∞
Integration Time	±2.6%	R	√3	1	1	±1.5%	±1.5%	∞
RF Ambient Noise	±3.0%	R	√3	1	1	±1.7%	±1.7%	∞
RF Ambient Reflections	±3.0%	R	√3	1	1	±1.7%	±1.7%	∞
Probe Positioner	±0.4%	R	√3	1	1	±0.2%	±0.2%	∞
Probe Positioning	±2.9%	R	√3	1	1	±1.7%	±1.7%	∞
Max. SAR Eval.	±1.0%	R	√3	1	1	±0.6%	±0.6%	∞
<b>Test Sample Related</b>								
Device Positioning	±2.9%	N	1	1	1	±2.9%	±2.9%	145
Device Holder	±3.6%	N	1	1	1	±3.6%	±3.6%	5
Power Drift	±5.0%	R	√3	1	1	±2.9%	±2.9%	∞
<b>Phantom and Setup</b>								
Phantom Uncertainty	±4.0%	R	√3	1	1	±2.3%	±2.3%	∞
Liquid Conductivity (target)	±5.0%	R	√3	0.64	0.43	±1.8%	±1.2%	∞
Liquid Conductivity (meas.)	±2.5%	N	1	0.64	0.43	±1.6%	±1.1%	∞
Liquid Permittivity (target)	±5.0%	R	√3	0.6	0.49	±1.7%	±1.4%	∞
Liquid Permittivity (meas.)	±2.5%	N	1	0.6	0.49	±1.5%	±1.2%	∞
<b>Combined Std. Uncertainty</b>						±11.0%	±10.8%	387
<b>Expanded STD Uncertainty</b>						±22.0%	±21.5%	

## 8. Conducted Power Measurement

Mode	Frequency (MHz)	Avg. Burst Power (dBm)	Duty Cycle Factor (dB)	Frame Power (dBm)	Max. Power (dBm)	Scaling Factor
GSM850	824.2	31.88	-9	22.88	32.5	1.15
	836.4	31.98	-9	22.98	32.5	1.13
	848.8	32.06	-9	23.06	32.5	1.11
GPRS850 (1 Slot)	824.2	31.88	-9	22.88	32.5	1.15
	836.4	31.95	-9	22.95	32.5	1.14
	848.8	32.05	-9	23.05	32.5	1.11
GPRS850 (2 Slot)	824.2	30.75	-6	24.75	31.0	1.06
	836.4	30.85	-6	24.85	31.0	1.04
	848.8	30.98	-6	24.98	31.0	1.00
<b>GPRS850 (3 Slot)</b>	<b>824.2</b>	<b>29.05</b>	<b>-4.25</b>	<b>24.80</b>	<b>29.5</b>	<b>1.11</b>
	<b>836.4</b>	<b>29.12</b>	<b>-4.25</b>	<b>24.87</b>	<b>29.5</b>	<b>1.09</b>
	<b>848.8</b>	<b>29.26</b>	<b>-4.25</b>	<b>25.01</b>	<b>29.5</b>	<b>1.06</b>
GPRS850 (4 Slot)	824.2	27.54	-3	24.54	28.0	1.11
	836.4	27.61	-3	24.61	28.0	1.09
	848.8	27.74	-3	24.74	28.0	1.06
PCS1900	1850.2	29.07	-9	20.07	29.5	1.10
	1880.0	29.16	-9	20.16	29.5	1.08
	1909.8	29.20	-9	20.20	29.5	1.07
GPRS1900 (1 Slot)	1850.2	29.04	-9	20.04	29.5	1.11
	1880.0	29.10	-9	20.10	29.5	1.10
	1909.8	29.16	-9	20.16	29.5	1.08
GPRS1900 (2 Slot)	1850.2	27.36	-6	21.36	28.0	1.16
	1880.0	27.48	-6	21.48	28.0	1.13
	1909.8	27.54	-6	21.54	28.0	1.11
<b>GPRS1900 (3 Slot)</b>	<b>1850.2</b>	<b>25.70</b>	<b>-4.25</b>	<b>21.45</b>	<b>26.0</b>	<b>1.07</b>
	<b>1880.0</b>	<b>25.82</b>	<b>-4.25</b>	<b>21.57</b>	<b>26.0</b>	<b>1.04</b>
	<b>1909.8</b>	<b>25.84</b>	<b>-4.25</b>	<b>21.59</b>	<b>26.0</b>	<b>1.04</b>
GPRS1900 (4 Slot)	1850.2	23.99	-3	20.99	24.5	1.12
	1880.0	24.12	-3	21.12	24.5	1.09
	1909.8	24.27	-3	21.27	24.5	1.05

Note 1: Scaling Factor = Max. Power(mW) / Avg. Burst Power(mW)

2: This device operates using the following maximum and nominal output power specifications. SAR values were scaled to the maximum allowed power to determine compliance per KDB Publication

447498 D01v05.

3: Both burst-averaged and calculated frame-averaged powers are included. Frame-averaged powers were calculated from the measured burst-averaged power by converting the slot powers into linear units and calculating the energy over 8 timeslots.

4: The bolded GPRS modes were selected for SAR testing according to the highest frame-averaged output power table per KDB 941225 D03v01.

5: GPRS/EDGE(GMSK) output powers were measured with coding scheme setting of 1 (CS1) on the base station simulator. CS1 was configured to measure GPRS output power measurements and SAR to ensure GMSK modulation in the signal. Our Investigation has shown that CS1 - CS4 settings do not have any impact on the output levels or modulation in the GPRS modes.



WCDMA/HSDPA/HSUPA

Mode	3GPP Subtest	Band II (1900MHz)			Band IV (1700MHz)			Band V (850MHz)			MPR
		Conducted Power (dBm)			Conducted Power (dBm)			Conducted Power (dBm)			
		9262	9400	9538	1312	1413	1513	4132	4182	4233	
WCDMA R99	1	22.48	22.74	22.81	22.51	22.20	22.47	23.03	23.11	23.19	N/A
Rel5 HSDPA	1	22.18	22.44	22.63	22.12	21.95	22.06	22.88	22.98	23.00	0
	2	22.15	22.43	22.61	22.11	21.94	22.04	22.86	22.93	22.96	0
	3	21.74	21.97	22.15	21.59	21.44	21.58	22.47	22.45	22.60	0.5
	4	21.71	21.94	22.12	21.69	21.39	21.53	22.44	22.43	22.58	0.5
Rel6 HSUPA	1	22.07	22.31	22.38	22.21	22.01	22.13	22.79	22.87	22.84	0.0
	2	20.10	20.34	20.37	20.11	20.07	20.09	20.77	20.86	20.83	2.0
	3	21.05	21.28	21.35	21.22	21.09	21.17	21.81	21.91	21.81	1.0
	4	20.08	20.32	20.33	20.12	20.08	20.11	20.75	20.83	20.82	2.0
	5	22.05	22.26	22.36	22.20	21.97	22.11	22.76	22.83	22.80	0.0

Note: UMTS SAR was tested under RMC 12.2 kbps with HSPA Inactive per KDB Publication 941225 D01v02. HSPA SAR was not required since the average output power of the HSPA subtests was not more than 0.25 dB higher than the RMC level and SAR was less than 1.2 W/kg.

Mode	Band II (1900MHz) Channel	Normal Power (dBm)	Max. Power (dBm)	Scaling Factor
WCDMA R99	9262	22.48	23.0	1.13
	9400	22.74	23.0	1.06
	9538	22.81	23.0	1.04
Rel5 HSDPA	9262	22.18	23.0	1.21
	9400	22.44	23.0	1.14
	9538	22.63	23.0	1.09
Rel6 HSUPA	9262	22.07	23.0	1.24
	9400	22.31	23.0	1.17
	9538	22.38	23.0	1.15
Mode	Band IV (1700MHz) Channel	Normal Power (dBm)	Max. Power (dBm)	Scaling Factor
WCDMA R99	1312	22.51	23.0	1.12
	1413	22.20	23.0	1.20
	1513	22.47	23.0	1.13

Rel5 HSDPA	1312	22.12	23.0	1.22
	1413	21.95	23.0	1.27
	1513	22.06	23.0	1.24
Rel6 HSUPA	1312	22.21	23.0	1.20
	1413	22.01	23.0	1.26
	1513	22.13	23.0	1.22
Mode	Band V (850MHz) Channel	Normal Power (dBm)	Max. Power (dBm)	Scaling Factor
WCDMA R99	4132	23.03	23.5	1.11
	4182	23.11	23.5	1.09
	4233	23.19	23.5	1.07
Rel5 HSDPA	4132	22.88	23.5	1.15
	4182	22.98	23.5	1.13
	4233	23.00	23.5	1.12
Rel6 HSUPA	4132	22.79	23.5	1.18
	4182	22.87	23.5	1.16
	4233	22.84	23.5	1.16

**WLAN output power**

Test Mode	Channel No.	Frequency (MHz)	Average Power (dBm)	Max. Power (dBm)	Scaling Factor
802.11b	01	2412	15.38	16.0	1.15
	<b>06</b>	<b>2437</b>	<b>15.69</b>	<b>16.0</b>	<b>1.07</b>
	11	2462	15.28	16.0	1.18
802.11g	01	2412	14.80	15.0	1.05
	06	2437	14.88	15.0	1.03
	11	2462	14.60	15.0	1.10
802.11n (20MHz)	01	2412	14.40	15.0	1.15
	06	2437	14.63	15.0	1.09
	11	2462	14.28	15.0	1.18

Note: Justification for reduced test configurations for WIFI channels per KDB Publication 248227 D01v01r02.

For 2.4 GHz, highest average RF output power channel for the lowest data rate for IEEE 802.11b were selected for SAR evaluation. Other IEEE 802.11 modes (including 802.11g/n) were not investigated since the average output powers over all channels and data rates were not more than 0.25 dB higher than the tested channel in the lowest data rate of IEEE 802.11b mode.

When the maximum extrapolated peak SAR of the zoom scan for the maximum output channel is  $<1.6$  W/kg and the reported 1g averaged SAR is  $<0.8$  W/kg, SAR testing on other channels is not required. Otherwise, the other default (or corresponding required) test channels were additionally tested using the lowest data rate.

The bolded channel above was tested for SAR.

**9. Test Results**

**9.1. SAR Test Results Summary**

<b>SAR MEASUREMENT</b>									
Ambient Temperature (°C) : 21.5 ±2					Relative Humidity (%) : 52				
Liquid Temperature (°C) : 21.0 ±2					Depth of Liquid (cm):>15				
Product: Smartphone									
Test Mode: GSM850									
Test Position Head	Antenna Position	Frequency		Frame Power (dBm)	Power Drift (<±0.2)	SAR 1g (W/kg)	Scaling Factor	Scaled SAR 1g (W/kg)	Limit (W/kg)
		Channel	MHz						
Left-Cheek	Fixed	128	824.2	22.88	--	--	1.15	--	1.6
Left-Cheek	Fixed	189	836.4	22.98	-0.06	0.534	1.13	0.603	1.6
Left-Cheek	Fixed	251	848.8	23.06	--	--	1.11	--	1.6
Left-Tilted	Fixed	189	836.4	22.98	-0.03	0.372	1.13	0.420	1.6
Right-Cheek	Fixed	128	824.2	22.88	--	--	1.15	--	1.6
Right-Cheek	Fixed	189	836.4	22.98	-0.16	0.304	1.13	0.344	1.6
Right-Cheek	Fixed	251	848.8	23.06	--	--	1.11	--	1.6
Right-Tilted	Fixed	189	836.4	22.98	0.15	0.227	1.13	0.257	1.6
Note: when the 1-g SAR is ≤ 0.8 W/kg, testing for low and high channel is optional, refer to KDB 447498.									

SAR MEASUREMENT									
Ambient Temperature (°C): 21.5 ±2					Relative Humidity (%): 52				
Liquid Temperature (°C): 21.0 ±2					Depth of Liquid (cm):>15				
Product: Smartphone									
Body-worn Accessory SAR Configurations									
Test Mode: GSM850									
Test Position Body (10mm gap)	Antenna Position	Frequency		Frame Power (dBm)	Power Drift (<±0.2)	SAR 1g (W/kg)	Scaling Factor	Scaled SAR 1g (W/kg)	Limit (W/kg)
		Channel	MHz						
Body-worn	Fixed	128	824.2	22.88	--	--	1.15	--	1.6
Body-worn	Fixed	189	836.4	22.98	0.03	0.701	1.13	0.792	1.6
Body-worn	Fixed	251	848.8	23.06	--	--	1.11	--	1.6
Hotspot SAR Configurations									
Test Mode: GPRS850-3slot									
Body-worn*	Fixed	128	824.2	24.80	-0.14	1.31	1.11	1.454	1.6
Body-worn	Fixed	128	824.2	24.80	0.01	1.3	1.11	1.443	1.6
Body-worn	Fixed	189	836.4	24.87	0.06	1.3	1.09	1.417	1.6
Body-worn	Fixed	251	848.8	25.01	-0.11	1.16	1.06	1.230	1.6
Body-front	Fixed	189	836.4	24.87	-0.05	0.745	1.09	0.812	1.6
Body-bottom	Fixed	189	836.4	24.87	0.08	0.148	1.09	0.161	1.6
Body-left side	Fixed	189	836.4	24.87	-0.17	0.281	1.09	0.306	1.6
Body-right side	Fixed	189	836.4	24.87	0.02	0.691	1.09	0.753	1.6
Note 1: when the 1-g SAR is ≤ 0.8 W/kg, testing for low and high channel is optional, refer to KDB 447498.									
2: * - repeated at the highest SAR measurement according to the FCC KDB 865664									

SAR MEASUREMENT									
Ambient Temperature (°C) : 21.5 ±2					Relative Humidity (%): 52				
Liquid Temperature (°C) : 21.0 ±2					Depth of Liquid (cm):>15				
Product: Smartphone									
Test Mode: PCS1900									
Test Position Head	Antenna Position	Frequency		Frame Power (dBm)	Power Drift (<±0.2)	SAR 1g (W/kg)	Scaling Factor	Scaled SAR 1g (W/kg)	Limit (W/kg)
		Channel	MHz						
Left-Cheek	Fixed	512	1850.2	20.07	--	--	1.10	--	1.6
Left-Cheek	Fixed	661	1880.0	20.16	-0.10	0.611	1.08	0.660	1.6
Left-Cheek	Fixed	810	1909.8	20.20	--	--	1.07	--	1.6
Left-Tilted	Fixed	661	1880.0	20.16	-0.01	0.145	1.08	0.157	1.6
Right-Cheek	Fixed	512	1850.2	20.07	--	--	1.10	--	1.6
Right-Cheek	Fixed	661	1880.0	20.16	0.05	0.361	1.08	0.390	1.6
Right-Cheek	Fixed	810	1909.8	20.20	--	--	1.07	--	1.6
Right-Tilted	Fixed	661	1880.0	20.16	0.06	0.164	1.08	0.177	1.6

Note: when the 1-g SAR is ≤ 0.8 W/kg, testing for low and high channel is optional, refer to KDB 447498.

<b>SAR MEASUREMENT</b>									
Ambient Temperature (°C) : 21.5 ±2					Relative Humidity (%): 52				
Liquid Temperature (°C) : 21.0 ±2					Depth of Liquid (cm):>15				
Product: Smartphone									
<b>Body-worn Accessory SAR Configurations</b>									
Test Mode: PCS1900									
Test Position Body (10mm gap)	Antenna Position	Frequency		Frame Power (dBm)	Power Drift (<±0.2)	SAR 1g (W/kg)	Scaling Factor	Scaled SAR 1g (W/kg)	Limit (W/kg)
		Channel	MHz						
Body-worn	Fixed	512	1850.2	20.07	--	--	1.10	--	1.6
Body-worn	Fixed	661	1880.0	20.16	0.08	0.561	1.08	0.606	1.6
Body-worn	Fixed	810	1909.8	20.20	--	--	1.07	--	1.6
<b>Hotspot SAR Configurations</b>									
Test Mode: GPRS1900-3slot									
Body-worn	Fixed	512	1850.2	21.45	-0.04	0.768	1.07	0.822	1.6
Body-worn	Fixed	661	1880.0	21.57	-0.10	0.871	1.04	0.906	1.6
Body-worn	Fixed	810	1909.8	21.59	-0.07	0.976	1.04	1.015	1.6
Body-worn*	Fixed	810	1909.8	21.59	-0.01	0.965	1.04	1.004	1.6
Body-front	Fixed	661	1880.0	21.57	-0.01	0.709	1.04	0.737	1.6
Body-bottom	Fixed	661	1880.0	21.57	0.04	0.673	1.04	0.700	1.6
Body-left side	Fixed	661	1880.0	21.57	-0.11	0.274	1.04	0.285	1.6
Body-right side	Fixed	661	1880.0	21.57	0.06	0.149	1.04	0.155	1.6
Note 1: when the 1-g SAR is ≤ 0.8 W/kg, testing for low and high channel is optional, refer to KDB 447498.									
2: * - repeated at the highest SAR measurement according to the FCC KDB 865664									

SAR MEASUREMENT									
Ambient Temperature (°C) : 21.5 ±2					Relative Humidity (%): 52				
Liquid Temperature (°C) : 21.0 ±2					Depth of Liquid (cm):>15				
Product: Smartphone									
Test Mode: WCDMA Band II									
Test Position Head	Antenna Position	Frequency		Conducted Power (dBm)	Power Drift (<±0.2)	SAR 1g (W/kg)	Scaling Factor	Scaled SAR 1g (W/kg)	Limit (W/kg)
		Channel	MHz						
Left-Cheek	Fixed	9262	1852.4	22.48	0.02	1.06	1.13	1.198	1.6
Left-Cheek*	Fixed	9262	1852.4	22.48	-0.09	0.951	1.13	1.075	1.6
Left-Cheek	Fixed	9400	1880.0	22.74	-0.02	1.04	1.06	1.102	1.6
Left-Cheek	Fixed	9538	1907.6	22.81	0.06	0.924	1.04	0.961	1.6
Left-Tilt	Fixed	9400	1880.0	22.74	-0.01	0.255	1.06	0.270	1.6
Right-Cheek	Fixed	9262	1852.4	22.48	--	--	1.13	--	1.6
Right-Cheek	Fixed	9400	1880.0	22.74	0.11	0.752	1.06	0.797	1.6
Right-Cheek	Fixed	9538	1907.6	22.81	--	--	1.04	--	1.6
Right-Tilt	Fixed	9400	1880.0	22.74	-0.06	0.285	1.06	0.302	1.6

Note 1: when the 1-g SAR is ≤ 0.8 W/kg, testing for low and high channel is optional, refer to KDB 447498.  
 2: \* - repeated at the highest SAR measurement according to the FCC KDB 865664



SAR MEASUREMENT									
Ambient Temperature (°C): 21.5 ±2					Relative Humidity (%): 52				
Liquid Temperature (°C): 21.0 ±2					Depth of Liquid (cm):>15				
Product: Smartphone									
Body-worn Accessory SAR Configurations									
Test Mode: WCDMA Band II									
Test Position Body (10mm gap)	Antenna Position	Frequency		Conducted Power (dBm)	Power Drift (<±0.2)	SAR 1g (W/kg)	Scaling Factor	Scaled SAR 1g (W/kg)	Limit (W/kg)
		Channel	MHz						
Body-worn	Fixed	9262	1852.4	22.48	-0.01	0.795	1.13	0.898	1.6
Body-worn	Fixed	9400	1880.0	22.74	-0.03	0.865	1.06	0.898	1.6
Body-worn	Fixed	9538	1907.6	22.81	-0.02	0.822	1.04	0.855	1.6
Hotspot SAR Configurations									
Test Mode: WCDMA Band II									
Body-worn	Fixed	9262	1852.4	22.48	-0.01	0.795	1.13	0.898	1.6
Body-worn	Fixed	9400	1880.0	22.74	-0.03	0.865	1.06	0.917	1.6
Body-worn*	Fixed	9400	1880.0	22.74	-0.03	0.863	1.06	0.915	1.6
Body-worn	Fixed	9538	1907.6	22.81	-0.02	0.822	1.04	0.855	1.6
Body-front	Fixed	9400	1880.0	22.74	-0.03	0.742	1.06	0.787	1.6
Body-bottom	Fixed	9400	1880.0	22.74	0.03	0.677	1.06	0.718	1.6
Body-left side	Fixed	9400	1880.0	22.74	-0.08	0.277	1.06	0.294	1.6
Body-right side	Fixed	9400	1880.0	22.74	0.08	0.164	1.06	0.174	1.6
Note 1: when the 1-g SAR is ≤ 0.8 W/kg, testing for low and high channel is optional, refer to KDB 447498.									
2: * - repeated at the highest SAR measurement according to the FCC KDB 865664									

SAR MEASUREMENT									
Ambient Temperature (°C) : 21.5 ±2					Relative Humidity (%): 52				
Liquid Temperature (°C) : 21.0 ±2					Depth of Liquid (cm):>15				
Product: Smartphone									
Test Mode: WCDMA Band IV									
Test Position Head	Antenna Position	Frequency		Conducted Power (dBm)	Power Drift (<±0.2)	SAR 1g (W/kg)	Scaling Factor	Scaled SAR 1g (W/kg)	Limit (W/kg)
		Channel	MHz						
Left-Cheek	Fixed	1312	1712.4	22.51	-0.01	0.880	1.12	0.986	1.6
Left-Cheek	Fixed	1413	1732.6	22.20	-0.07	1.07	1.20	1.284	1.6
Left-Cheek	Fixed	1513	1752.6	22.47	-0.10	1.11	1.13	1.254	1.6
Left-Cheek*	Fixed	1513	1752.6	22.47	-0.09	0.972	1.13	1.098	1.6
Left-Tilt	Fixed	1413	1732.6	22.20	-0.11	0.220	1.20	0.264	1.6
Right-Cheek	Fixed	1312	1712.4	22.51	--	--	1.12	--	1.6
Right-Cheek	Fixed	1413	1732.6	22.20	-0.05	0.722	1.20	0.866	1.6
Right-Cheek	Fixed	1513	1752.6	22.47	--	--	1.13	--	1.6
Right-Tilt	Fixed	1413	1732.6	22.20	0.19	0.177	1.20	0.212	1.6

Note 1: when the 1-g SAR is ≤ 0.8 W/kg, testing for low and high channel is optional, refer to KDB 447498.  
 2: \* - repeated at the highest SAR measurement according to the FCC KDB 865664

SAR MEASUREMENT									
Ambient Temperature (°C): 21.5 ±2					Relative Humidity (%): 52				
Liquid Temperature (°C): 21.0 ±2					Depth of Liquid (cm):>15				
Product: Smartphone									
Body-worn Accessory SAR Configurations									
Test Mode: WCDMA Band IV									
Test Position Body (10mm gap)	Antenna Position	Frequency		Conducted Power (dBm)	Power Drift (<±0.2)	SAR 1g (W/kg)	Scaling Factor	Scaled SAR 1g (W/kg)	Limit (W/kg)
		Channel	MHz						
Body-worn	Fixed	1312	1712.4	22.51	-0.01	0.794	1.12	0.889	1.6
Body-worn	Fixed	1413	1732.6	22.20	-0.15	0.773	1.20	0.919	1.6
Body-worn	Fixed	1513	1752.6	22.47	0.01	0.742	1.13	0.838	1.6
Hotspot SAR Configurations									
Test Mode: WCDMA Band IV									
Body-worn	Fixed	1312	1712.4	22.51	-0.01	0.794	1.12	0.889	1.6
Body-worn	Fixed	1413	1732.6	22.20	-0.15	0.766	1.20	0.919	1.6
Body-worn	Fixed	1513	1752.6	22.47	0.01	0.742	1.13	0.838	1.6
Body-front	Fixed	1413	1732.6	22.20	-0.11	0.674	1.20	0.809	1.6
Body-bottom	Fixed	1413	1732.6	22.20	-0.14	0.542	1.20	0.650	1.6
Body-left side	Fixed	1413	1732.6	22.20	-0.18	0.237	1.20	0.284	1.6
Body-right side	Fixed	1413	1732.6	22.20	0.01	0.177	1.20	0.212	1.6
Note 1: when the 1-g SAR is ≤ 0.8 W/kg, testing for low and high channel is optional, refer to KDB 447498.									
2: * - repeated at the highest SAR measurement according to the FCC KDB 865664									

SAR MEASUREMENT									
Ambient Temperature (°C) : 21.5 ±2					Relative Humidity (%): 52				
Liquid Temperature (°C) : 21.0 ±2					Depth of Liquid (cm):>15				
Product: Smartphone									
Test Mode: WCDMA Band V									
Test Position Head	Antenna Position	Frequency		Conducted Power (dBm)	Power Drift (<±0.2)	SAR 1g (W/kg)	Scaling Factor	Scaled SAR 1g (W/kg)	Limit (W/kg)
		Channel	MHz						
Left-Cheek	Fixed	4132	826.4	23.03	--	--	1.11	--	1.6
Left-Cheek	Fixed	4182	836.4	23.11	0.02	0.333	1.09	0.363	1.6
Left-Cheek	Fixed	4233	846.6	23.19	--	--	1.07	--	1.6
Left-Tilt	Fixed	4182	836.4	23.11	-0.01	0.215	1.09	0.234	1.6
Right-Cheek	Fixed	4132	826.4	23.03	--	--	1.11	--	1.6
Right-Cheek	Fixed	4182	836.4	23.11	-0.07	0.342	1.09	0.373	1.6
Right-Cheek	Fixed	4233	846.6	23.19	--	--	1.07	--	1.6
Right-Tilt	Fixed	4182	836.4	23.11	-0.04	0.233	1.09	0.254	1.6

Note: when the 1-g SAR is ≤ 0.8 W/kg, testing for low and high channel is optional, refer to KDB 447498.

SAR MEASUREMENT									
Ambient Temperature (°C): 21.5 ±2					Relative Humidity (%): 52				
Liquid Temperature (°C): 21.0 ±2					Depth of Liquid (cm):>15				
Product: Smartphone									
Body-worn Accessory SAR Configurations									
Test Mode: WCDMA Band V									
Test Position Body (10mm gap)	Antenna Position	Frequency		Conducted Power (dBm)	Power Drift (<±0.2)	SAR 1g (W/kg)	Scaling Factor	Scaled SAR 1g (W/kg)	Limit (W/kg)
		Channel	MHz						
Body-worn	Fixed	4132	826.4	23.03	-0.13	0.768	1.11	0.852	1.6
Body-worn	Fixed	4182	836.4	23.11	0.01	0.923	1.09	1.006	1.6
Body-worn	Fixed	4233	846.6	23.19	0.07	0.922	1.07	0.987	1.6
Hotspot SAR Configurations									
Test Mode: WCDMA Band V									
Body-worn	Fixed	4132	826.4	23.03	-0.13	0.768	1.11	0.852	1.6
Body-worn	Fixed	4182	836.4	23.11	0.01	0.923	1.09	1.006	1.6
Body-worn*	Fixed	4182	836.4	23.11	0.02	0.858	1.09	0.935	1.6
Body-worn	Fixed	4233	846.6	23.19	0.07	0.922	1.07	0.987	1.6
Body-front	Fixed	4182	836.4	23.11	0.01	0.414	1.09	0.451	1.6
Body-bottom	Fixed	4182	836.4	23.11	0.10	0.088	1.09	0.096	1.6
Body-left side	Fixed	4182	836.4	23.11	-0.10	0.130	1.09	0.142	1.6
Body-right side	Fixed	4182	836.4	23.11	0.15	0.396	1.09	0.432	1.6
Note 1: when the 1-g SAR is ≤ 0.8 W/kg, testing for low and high channel is optional, refer to KDB 447498.									
2: * - repeated at the highest SAR measurement according to the FCC KDB 865664									

SAR MEASUREMENT									
Ambient Temperature (°C) : 21.5 ±2					Relative Humidity (%): 52				
Liquid Temperature (°C) : 21.0 ±2					Depth of Liquid (cm):>15				
Product: Smartphone									
Test Mode: 802.11b									
Test Position Head	Antenna Position	Frequency		Average Power (dBm)	Power Drift (<±0.2)	SAR 1g (W/kg)	Scaling Factor	Scaled SAR 1g (W/kg)	Limit (W/kg)
		Channel	MHz						
Left-Cheek	Fixed	1	2412	15.38	--	--	1.15	--	1.6
Left-Cheek	Fixed	6	2437	15.69	-0.12	0.00348	1.07	0.00372	1.6
Left-Cheek	Fixed	11	2462	15.28	--	--	1.18	--	1.6
Left-Tilt	Fixed	6	2437	15.69	0.09	0.000131	1.07	0.00014	1.6
Right-Cheek	Fixed	1	2412	15.38	--	--	1.15	--	1.6
Right-Cheek	Fixed	6	2437	15.69	0.12	0.00473	1.07	0.00506	1.6
Right-Cheek	Fixed	11	2462	15.28	--	--	1.18	--	1.6
Right-Tilt	Fixed	6	2437	15.69	0.18	0.00236	1.07	0.00253	1.6

SAR MEASUREMENT									
Ambient Temperature (°C): 21.5 ±2					Relative Humidity (%): 52				
Liquid Temperature (°C): 21.0 ±2					Depth of Liquid (cm):>15				
Product: Smartphone									
Body-worn Accessory SAR Configurations									
Test Mode: 802.11b									
Test Position Body (10mm gap)	Antenna Position	Frequency		Average Power (dBm)	Power Drift (<±0.2)	SAR 1g (W/kg)	Scaling Factor	Scaled SAR 1g (W/kg)	Limit (W/kg)
		Channel	MHz						
Body-worn	Fixed	1	2412	15.38	--	--	1.15	--	1.6
Body-worn	Fixed	6	2437	15.69	-0.16	0.015	1.07	0.0161	1.6
Body-worn	Fixed	11	2462	15.28	--	--	1.18	--	1.6
Hotspot SAR Configurations									
Test Mode: 802.11b									
Body-worn	Fixed	6	2437	15.69	-0.16	0.015	1.07	0.0161	1.6
Body-front	Fixed	6	2437	15.69	0.16	0.000607	1.07	0.00065	1.6
Body-Top	Fixed	6	2437	15.69	-0.04	0.00471	1.07	0.00504	1.6
Body-left side	Fixed	6	2437	15.69	0.15	0.00401	1.07	0.00421	1.6

**9.2. SAR Test Notes**

**9.2.1. Test position and configuration**

Head SAR was performed with the device configured in the positions according to IEEE1528. Device was tested using a fixed spacing for body-worn accessory testing. A separation distance of 10 mm was considered because the manufacturer has determined that there will be body-worn accessories available in the marketplace for users to support this separation distance.

**9.2.2. Body SAR with Headset**

Per FCC KDB Publication 648474 D04v01, SAR was evaluated without a headset connected to the device. Since the standalone reported SAR was ≤ 1.2 W/kg, no additional SAR evaluations using a headset cable were required.

**9.2.3. Hotspot Operation Mode**

During SAR Testing for the Wireless Router conditions per FCC KDB Publication 941225 D06v01, the actual Portable Hotspot operation (with actual simultaneous transmission of a transmitter with WIFI) was not activated.

**9.2.4. Simultaneous Transmission Procedures**

This device contains transmitters that may operate simultaneously. Therefore simultaneous transmission analysis is required. Per FCC KDB 447498 D01v05, simultaneous transmission SAR test exclusion may be applied when the sum of the 1-g SAR for all the simultaneous transmitting antennas in a specific a physical test configuration is ≤ 1.6W/kg. When standalone SAR is not required to be measured, per FCC KDB 447498 D01v05 4.3.2 2, the following equation must be used to estimate the standalone 1g SAR for simultaneous transmission assessment involving that transmitter.

$$\text{Estimated SAR} = \frac{\sqrt{f(\text{GHz})}}{7.5} * \frac{(\text{Max Power of channel, mW})}{\text{Min. Separation Distance, mm}}$$

**Estimated SAR for Bluetooth**

Mode	Frequency	Maximum Allowed Power	Estimated SAR (Held-to-Ear)	Separation Distance (Body)	Estimated SAR (Body)
	[MHz]	[dBm]	[W/kg]	[mm]	[W/kg]
Bluetooth	2480	5.4	N/A	10	0.073

Note: Held-to ear configurations are not applicable to Bluetooth operations and therefore were not considered for simultaneous transmission.



**9.2.5. Simultaneous Transmission Analysis**

Simultaneous Transmission Scenario with Wi-Fi

Configuration	Mode	Max. Scaled SAR (W/kg)	Wi-Fi SAR (W/kg)	$\Sigma$ SAR (W/kg)
Head	GSM850	0.603	0.00506	0.608
Head	PCS1900	0.660	0.00506	0.665
Head	UMTS 850	0.363	0.00506	0.368
Head	UMTS 1700	1.284	0.00506	1.289
Head	UMTS 1900	1.198	0.00506	1.203
Body-Worn	GSM850	0.792	0.0161	0.808
Body-Worn	PCS1900	0.606	0.0161	0.622
Body-Worn	UMTS 850	1.006	0.0161	1.022
Body-Worn	UMTS 1700	0.919	0.0161	0.935
Body-Worn	UMTS 1900	0.917	0.0161	0.933

Note: Body worn at 10mm.

Simultaneous Transmission Scenario with Bluetooth

Configuration	Mode	Max. Scaled SAR (W/kg)	Bluetooth SAR (W/kg)	$\Sigma$ SAR (W/kg)
Body-Worn	GSM850	0.792	0.073	0.865
Body-Worn	PCS1900	0.606	0.073	0.679
Body-Worn	UMTS 850	1.006	0.073	1.079
Body-Worn	UMTS 1700	0.919	0.073	0.992
Body-Worn	UMTS 1900	0.917	0.073	0.990

Note 1: Bluetooth SAR was not required to be measured per FCC KDB 447498. Estimated SAR results were used in the above table to determine simultaneous transmission SAR test exclusion.

2: Body worn at 10mm.

Simultaneous Transmission Scenario (Hotspot)

Simult Tx	Configuration	GPRS850 SAR (W/kg)	Wi-Fi SAR (W/kg)	$\Sigma$ SAR (W/kg)
Body	Back	1.454	0.0161	1.470
	Front	0.812	0.00065	0.813
	Top	--	0.00504	0.005
	Bottom	0.161	--	0.161
	Left	0.306	0.00421	0.310
	Right	0.753	--	0.753
Simult Tx	Configuration	GPRS1900 SAR (W/kg)	Wi-Fi SAR (W/kg)	$\Sigma$ SAR (W/kg)
Body	Back	1.015	0.0161	1.031
	Front	0.737	0.00065	0.738
	Top	--	0.00504	0.005
	Bottom	0.700	--	0.700
	Left	0.285	0.00421	0.289
	Right	0.155	--	0.155
Simult Tx	Configuration	UMTS850 SAR (W/kg)	Wi-Fi SAR (W/kg)	$\Sigma$ SAR (W/kg)
Body	Back	1.006	0.0161	1.022
	Front	0.451	0.00065	0.452
	Top	--	0.00504	0.005
	Bottom	0.096	--	0.096
	Left	0.142	0.00421	0.146
	Right	0.432	--	0.432
Simult Tx	Configuration	UMTS1700 SAR (W/kg)	Wi-Fi SAR (W/kg)	$\Sigma$ SAR (W/kg)
Body	Back	0.919	0.0161	0.935
	Front	0.809	0.00065	0.810
	Top	--	0.00504	0.005
	Bottom	0.650	--	0.650
	Left	0.284	0.00421	0.288
	Right	0.212	--	0.212
Simult Tx	Configuration	UMTS1900 SAR (W/kg)	Wi-Fi SAR (W/kg)	$\Sigma$ SAR (W/kg)
Body	Back	0.917	0.0161	0.933
	Front	0.787	0.00065	0.788
	Top	--	0.00504	0.005

	Bottom	0.718	--	0.718
	Left	0.294	0.00421	0.298
	Right	0.174	--	0.174

**9.2.6. Simultaneous Transmission Conclusion**

The above numerical summed SAR results for all the worst-case simultaneous transmission conditions were below the SAR limit. Therefore, the above analysis is sufficient to determine that simultaneous transmission cases will not exceed the SAR limit and therefore no measured volumetric simultaneous SAR summation is required per FCC KDB Publication 447498 D01v05.

**Appendix A. SAR System Validation Data**

**Date/Time: 05-06-2013**

Test Laboratory: QuieTek Lab

System Check Head 835MHz

**DUT: Dipole 835 MHz D835V2; Type: D835V2**

Communication System: CW; Communication System Band: D835 (835.0 MHz); Duty Cycle: 1:1;

Frequency: 835 MHz; Medium parameters used:  $f = 835 \text{ MHz}$ ;  $\sigma = 0.87 \text{ mho/m}$ ;  $\epsilon_r = 41.13$ ;  $\rho = 1000 \text{ kg/m}^3$  ;

Phantom section: Flat Section ; Input Power=250mW

Ambient temperature (°C): 21.5, Liquid temperature (°C): 21.0

DASY5 Configuration:

- Probe: EX3DV4 - SN3710; ConvF(9.52, 9.52, 9.52); Calibrated: 27/03/2013;
- Sensor-Surface: 4mm (Mechanical Surface Detection)
- Electronics: DAE4 Sn1220; Calibrated: 24/01/2013
- Phantom: SAM2; Type: SAM; Serial: TP1562
- Measurement SW: DASY52, Version 52.8 (1); SEMCAD X Version 14.6.5 (6469)

**Configuration/System Check Head 835MHz/Area Scan (6x19x1):** Measurement grid: dx=10mm, dy=10mm, Maximum value of SAR (measured) = 2.36 mW/g

**Configuration/System Check Head 835MHz/Zoom Scan (7x7x7)/Cube 0:** Measurement grid: dx=5mm, dy=5mm, dz=5mm, Reference Value = 51.151 V/m; Power Drift = 0.05 dB

Peak SAR (extrapolated) = 3.358 mW/g

**SAR(1 g) = 2.22 mW/g; SAR(10 g) = 1.45 mW/g** Maximum value of SAR (measured) = 2.39 mW/g

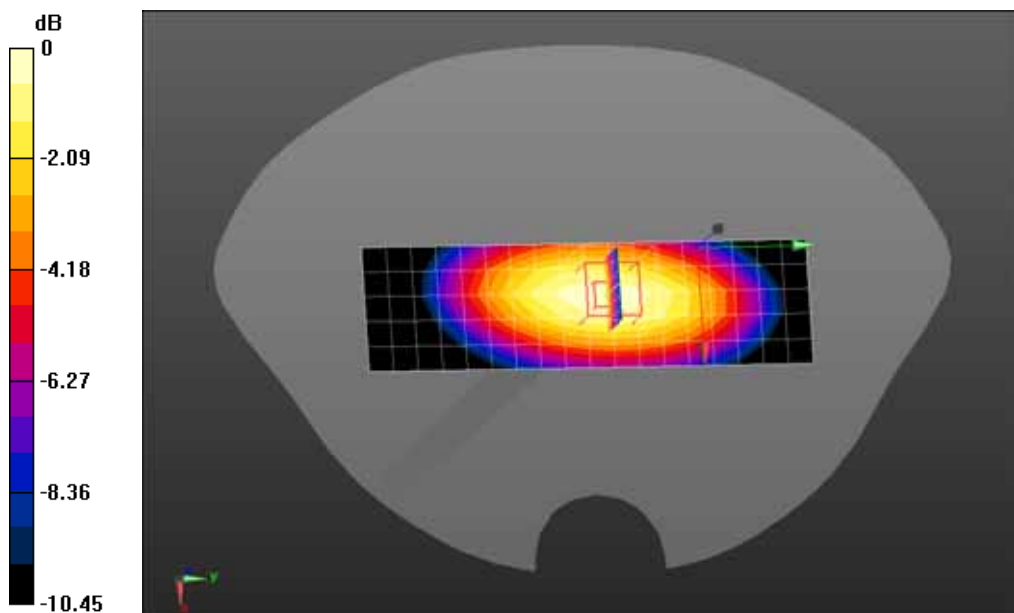

0 dB = 2.39 mW/g = 7.57 dB mW/g

Date/Time: 05-06-2013

Test Laboratory: QuieTek Lab

System Check Body 835MHz

**DUT: Dipole 835 MHz D835V2; Type: D835V2**

Communication System: CW; Communication System Band: D835 (835.0 MHz); Duty Cycle: 1:1;

Frequency: 835 MHz; Medium parameters used:  $f = 835 \text{ MHz}$ ;  $\sigma = 0.97 \text{ mho/m}$ ;  $\epsilon_r = 52.89$ ;  $\rho = 1000 \text{ kg/m}^3$  ;

Phantom section: Flat Section ; Input Power=250mW

Ambient temperature (°C): 21.5, Liquid temperature (°C): 21.0

DASY5 Configuration:

- Probe: EX3DV4 - SN3710; ConvF(9.41, 9.41, 9.41); Calibrated: 27/03/2013;
- Sensor-Surface: 4mm (Mechanical Surface Detection)
- Electronics: DAE4 Sn1220; Calibrated: 24/01/2013
- Phantom: SAM1; Type: SAM; Serial: TP1561
- Measurement SW: DASY52, Version 52.8 (1); SEMCAD X Version 14.6.5 (6469)

**Configuration/System Check Body 835MHz/Area Scan (8x17x1):** Measurement grid: dx=10mm, dy=10mm, Maximum value of SAR (measured) = 2.51 mW/g

**Configuration/System Check Body 835MHz/Zoom Scan (7x7x7)/Cube 0:** Measurement grid: dx=5mm, dy=5mm, dz=5mm, Reference Value = 51.529 V/m; Power Drift = 0.03 dB

Peak SAR (extrapolated) = 3.654 mW/g

**SAR(1 g) = 2.42 mW/g; SAR(10 g) = 1.58 mW/g** Maximum value of SAR (measured) = 2.62 mW/g

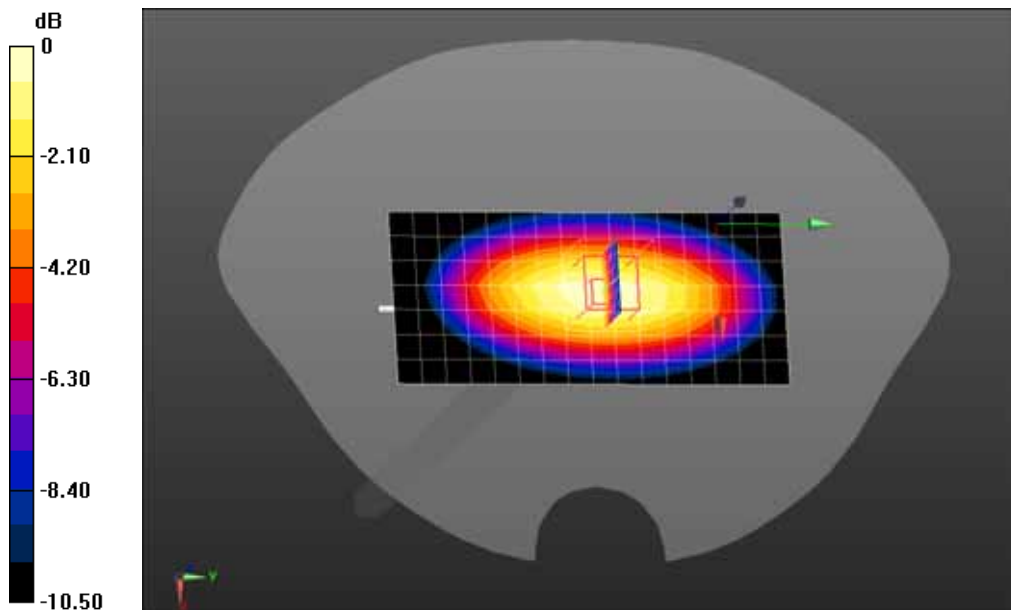

0 dB = 2.62 mW/g = 8.37 dB mW/g

Date/Time: 05-06-2013

Test Laboratory: QuieTek Lab

System Check Head 1800MHz

**DUT: Dipole 1800 MHz D1800V2; Type: D1800V2**

Communication System: CW; Communication System Band: D1800 (1800.0 MHz); Duty Cycle: 1:1;

Frequency: 1800 MHz; Medium parameters used:  $f = 1800 \text{ MHz}$ ;  $\sigma = 1.4 \text{ mho/m}$ ;  $\epsilon_r = 39.32$ ;  $\rho = 1000 \text{ kg/m}^3$  ;

Phantom section: Flat Section ; Input Power=250mW

Ambient temperature (°C): 21.5, Liquid temperature (°C): 21.0

DASY5 Configuration:

- Probe: EX3DV4 - SN3710; ConvF(7.75, 7.75, 7.75); Calibrated: 27/03/2013;
- Sensor-Surface: 4mm (Mechanical Surface Detection)
- Electronics: DAE4 Sn1220; Calibrated: 24/01/2013
- Phantom: SAM1; Type: SAM; Serial: TP1561
- Measurement SW: DASY52, Version 52.8 (1); SEMCAD X Version 14.6.5 (6469)

**Configuration/System Check Head 1800MHz/Area Scan (6x11x1):** Measurement grid: dx=10mm, dy=10mm, Maximum value of SAR (measured) = 9.67 mW/g

**Configuration/System Check Head 1800MHz/Zoom Scan (7x7x7)/Cube 0:** Measurement grid: dx=5mm, dy=5mm, dz=5mm, Reference Value = 86.568 V/m; Power Drift = 0.01 dB

Peak SAR (extrapolated) = 17.828 mW/g

**SAR(1 g) = 9.48 mW/g; SAR(10 g) = 4.92 mW/g** Maximum value of SAR (measured) = 10.7 mW/g

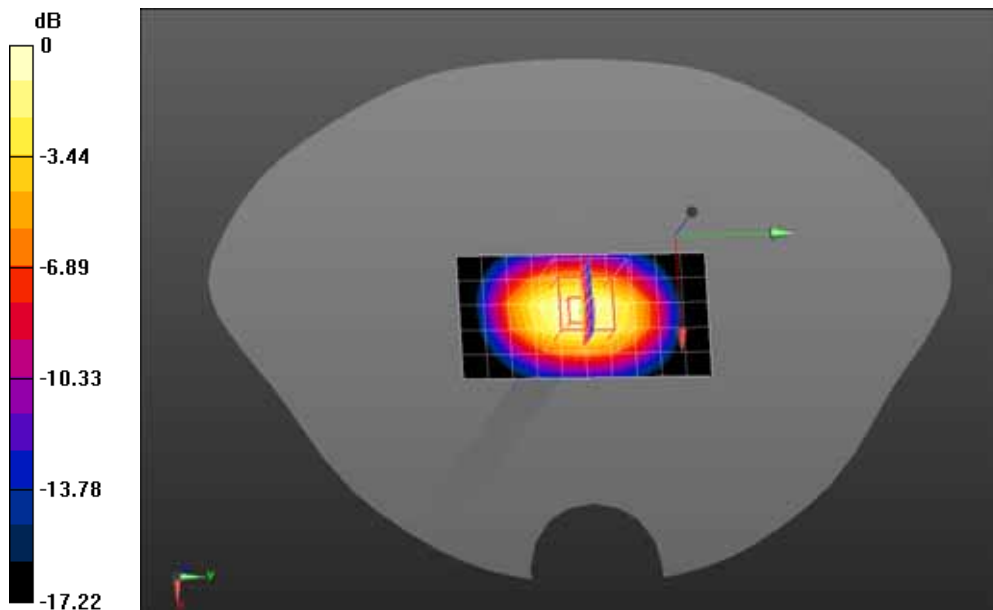

0 dB = 10.7 mW/g = 20.59 dB mW/g

Date/Time: 05-06-2013

Test Laboratory: QuieTek Lab

System Check Body 1800MHz

**DUT: Dipole 1800 MHz D1800V2; Type: D1800V2**

Communication System: CW; Communication System Band: D1800 (1800.0 MHz); Duty Cycle: 1:1;  
 Frequency: 1800 MHz; Medium parameters used:  $f = 1800$  MHz;  $\sigma = 1.44$  mho/m;  $\epsilon_r = 53.26$ ;  $\rho = 1000$  kg/m<sup>3</sup>; Phantom section: Flat Section ; Input Power=250mW

Ambient temperature (°C): 21.5, Liquid temperature (°C): 21.0

DASY5 Configuration:

- Probe: EX3DV4 - SN3710; ConvF(7.6, 7.6, 7.6); Calibrated: 27/03/2013;
- Sensor-Surface: 4mm (Mechanical Surface Detection)
- Electronics: DAE4 Sn1220; Calibrated: 24/01/2013
- Phantom: SAM2; Type: SAM; Serial: TP1562
- Measurement SW: DASY52, Version 52.8 (1); SEMCAD X Version 14.6.5 (6469)

**Configuration/System Check Body 1800MHz/Area Scan (6x11x1):** Measurement grid: dx=10mm, dy=10mm, Maximum value of SAR (measured) = 8.57 mW/g

**Configuration/System Check Body 1800MHz/Zoom Scan (7x7x7)/Cube 0:** Measurement grid: dx=5mm, dy=5mm, dz=5mm, Reference Value = 82.755 V/m; Power Drift = 0.07 dB

Peak SAR (extrapolated) = 15.999 mW/g

**SAR(1 g) = 8.77 mW/g; SAR(10 g) = 4.59 mW/g** Maximum value of SAR (measured) = 9.90 mW/g

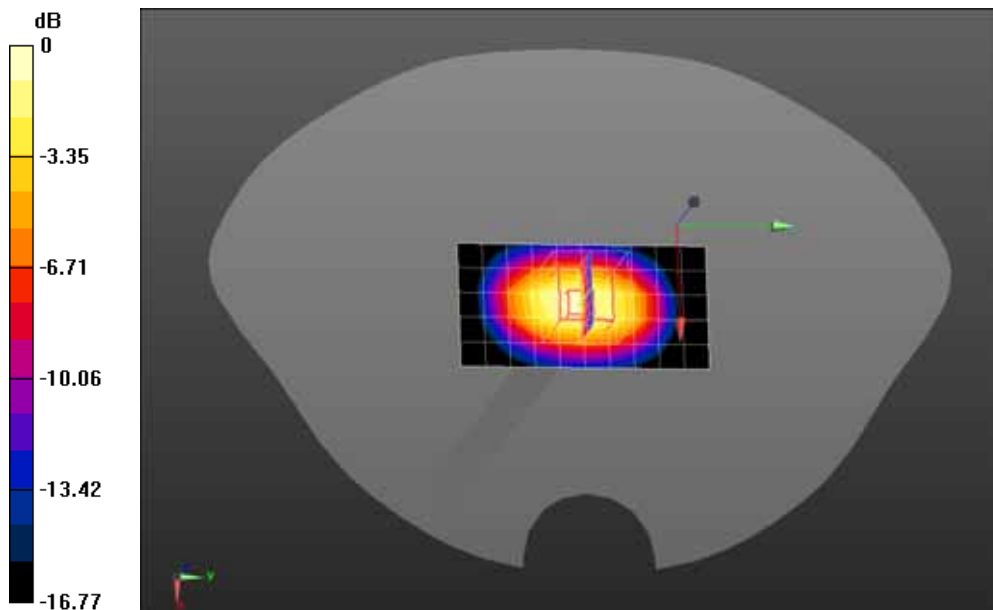

0 dB = 9.90 mW/g = 19.91 dB mW/g

Date/Time: 05-06-2013

Test Laboratory: QuieTek Lab

System Check Head 1900MHz

**DUT: Dipole 1900 MHz D1900V2; Type: D1900V2**

Communication System: CW; Communication System Band: D1900 (1900.0 MHz); Duty Cycle: 1:1;  
 Frequency: 1900 MHz; Medium parameters used:  $f = 1900$  MHz;  $\sigma = 1.45$  mho/m;  $\epsilon_r = 38.88$ ;  $\rho = 1000$  kg/m<sup>3</sup> ; Phantom section: Flat Section ; Input Power=250mW  
 Ambient temperature (°C): 21.5, Liquid temperature (°C): 21.0  
 DASY5 Configuration:

- Probe: EX3DV4 - SN3710; ConvF(7.75, 7.75, 7.75); Calibrated: 27/03/2013;
- Sensor-Surface: 4mm (Mechanical Surface Detection)
- Electronics: DAE4 Sn1220; Calibrated: 24/01/2013
- Phantom: SAM1; Type: SAM; Serial: TP1561
- Measurement SW: DASY52, Version 52.8 (1); SEMCAD X Version 14.6.5 (6469)

**Configuration/System Check Head 1900MHz/Area Scan (6x11x1):** Measurement grid: dx=10mm, dy=10mm, Maximum value of SAR (measured) = 10.8 mW/g

**Configuration/System Check Head 1900MHz/Zoom Scan (7x7x7)/Cube 0:** Measurement grid: dx=5mm, dy=5mm, dz=5mm, Reference Value = 88.756 V/m; Power Drift = 0.00 dB

Peak SAR (extrapolated) = 20.074 mW/g

**SAR(1 g) = 10.4 mW/g; SAR(10 g) = 5.27 mW/g** Maximum value of SAR (measured) = 11.7 mW/g

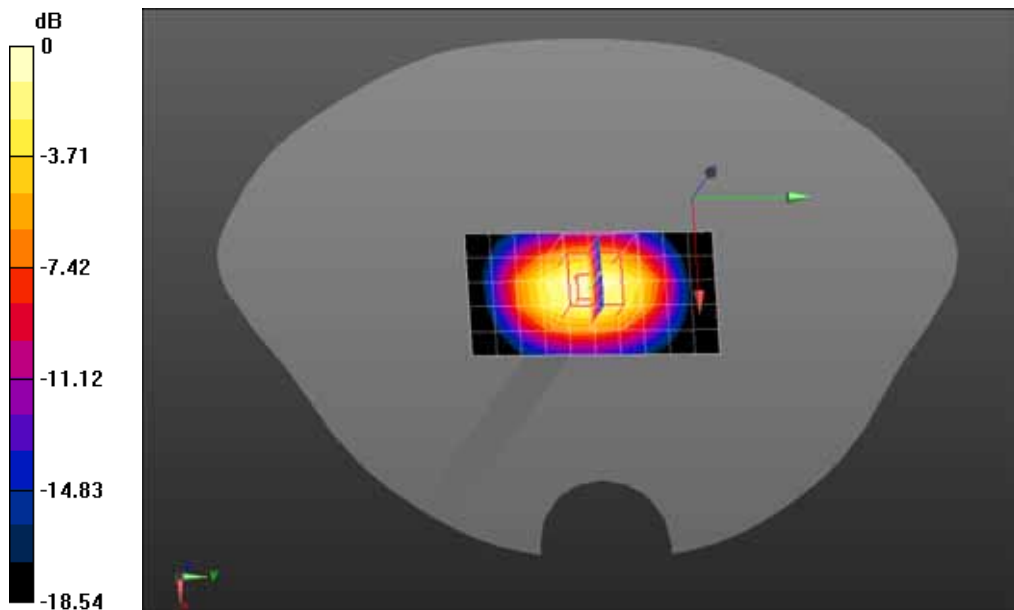

0 dB = 11.7 mW/g = 21.36 dB mW/g



Date/Time: 05-06-2013

Test Laboratory: QuieTek Lab

System Check Body 1900MHz

**DUT: Dipole 1900 MHz D1900V2; Type: D1900V2**

Communication System: CW; Communication System Band: D1900 (1900.0 MHz); Duty Cycle: 1:1;

Frequency: 1900 MHz; Medium parameters used:  $f = 1900$  MHz;  $\sigma = 1.53$  mho/m;  $\epsilon_r = 52.93$ ;  $\rho = 1000$  kg/m<sup>3</sup>; Phantom section: Flat Section ; Input Power=250mW

Ambient temperature (°C): 21.5, Liquid temperature (°C): 21.0

DASY5 Configuration:

- Probe: EX3DV4 - SN3710; ConvF(7.6, 7.6, 7.6); Calibrated: 27/03/2013;
- Sensor-Surface: 4mm (Mechanical Surface Detection)
- Electronics: DAE4 Sn1220; Calibrated: 24/01/2013
- Phantom: SAM1; Type: SAM; Serial: TP1561
- Measurement SW: DASY52, Version 52.8 (1); SEMCAD X Version 14.6.5 (6469)

**Configuration/System Check Body 1900MHz/Area Scan (7x11x1):** Measurement grid: dx=10mm, dy=10mm, Maximum value of SAR (measured) = 10.9 mW/g

**Configuration/System Check Body 1900MHz/Zoom Scan (7x7x7)/Cube 0:** Measurement grid: dx=5mm, dy=5mm, dz=5mm, Reference Value = 84.553 V/m; Power Drift = 0.05 dB

Peak SAR (extrapolated) = 18.880 mW/g

**SAR(1 g) = 10.1 mW/g; SAR(10 g) = 5.18 mW/g** Maximum value of SAR (measured) = 11.4 mW/g

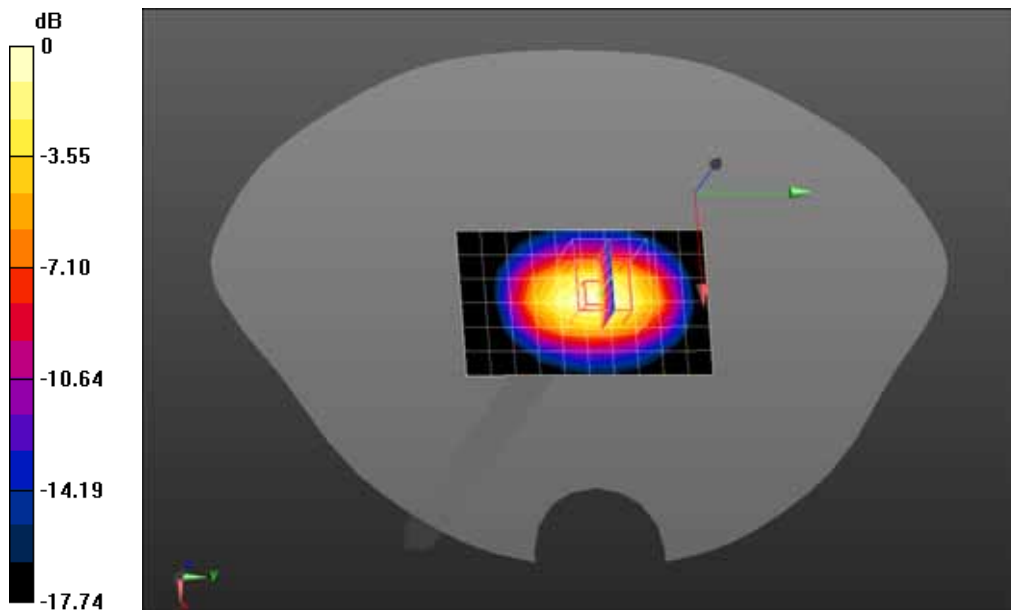

0 dB = 11.4 mW/g = 21.14 dB mW/g

Date/Time: 05-06-2013

Test Laboratory: QuieTek Lab

System Check Head 2450MHz

**DUT: Dipole 2450 MHz D2450V2; Type: D2450V2**

Communication System: CW; Communication System Band: D2450(2450MHz); Duty Cycle: 1:1; Frequency: 2450 MHz; Medium parameters used:  $f = 2450$  MHz;  $\sigma = 1.83$  mho/m;  $\epsilon_r = 39.81$ ;  $\rho = 1000$  kg/m<sup>3</sup>; Phantom section: Flat Section ; Input Power=250mW

Ambient temperature (°C): 21.5, Liquid temperature (°C): 21.0

DASY5 Configuration:

- Probe: EX3DV4 - SN3710; ConvF(7.03, 7.03, 7.03); Calibrated: 27/03/2013;
- Sensor-Surface: 4mm (Mechanical Surface Detection)
- Electronics: DAE4 Sn1220; Calibrated: 24/01/2013
- Phantom: SAM1; Type: SAM; Serial: TP1561
- Measurement SW: DASY52, Version 52.8 (1); SEMCAD X Version 14.6.5 (6469)

**Configuration/System Check Head 2450MHz/Area Scan (6x10x1):** Measurement grid: dx=10mm, dy=10mm, Maximum value of SAR (measured) = 13.7 mW/g

**Configuration/System Check Head 2450MHz/Zoom Scan (7x7x7)/Cube 0:** Measurement grid: dx=5mm, dy=5mm, dz=5mm, Reference Value = 86.605 V/m; Power Drift = 0.12 dB

Peak SAR (extrapolated) = 29.780 mW/g

**SAR(1 g) = 13.2 mW/g; SAR(10 g) = 5.86 mW/g** Maximum value of SAR (measured) = 14.9 mW/g

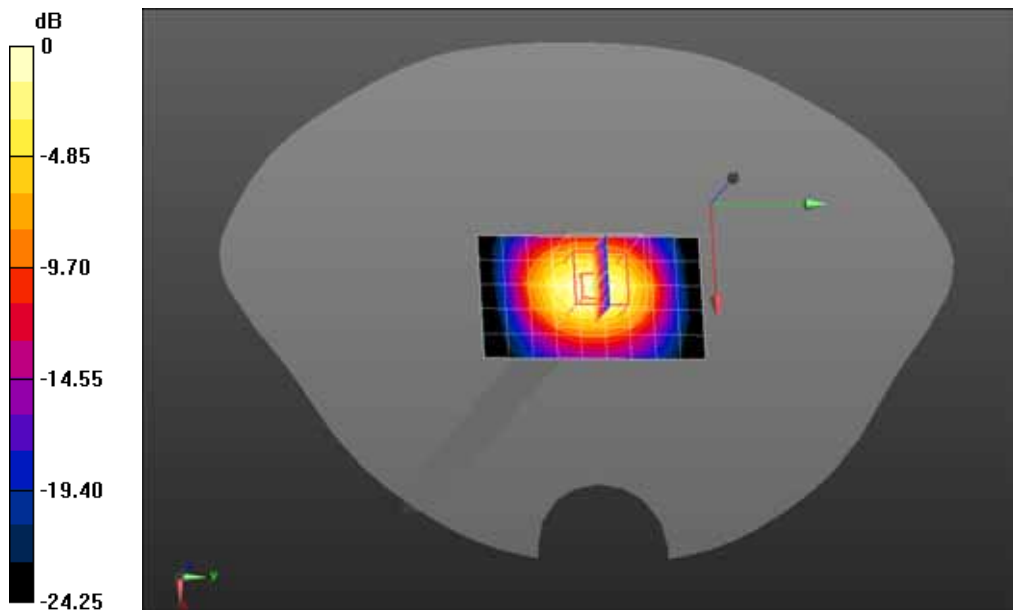

0 dB = 14.9 mW/g = 23.46 dB mW/g

Date/Time: 05-06-2013

Test Laboratory: QuieTek Lab

System Check Body 2450MHz

**DUT: Dipole 2450 MHz D2450V2; Type: D2450V2**

Communication System: CW; Communication System Band: D2450(2450MHz); Duty Cycle: 1:1; Frequency: 2450 MHz; Medium parameters used:  $f = 2450$  MHz;  $\sigma = 1.99$  mho/m;  $\epsilon_r = 52.25$ ;  $\rho = 1000$  kg/m<sup>3</sup>; Phantom section: Flat Section ; Input Power=250mW

Ambient temperature (°C): 21.5, Liquid temperature (°C): 21.0

DASY5 Configuration:

- Probe: EX3DV4 - SN3710; ConvF(7.08, 7.08, 7.08); Calibrated: 27/03/2013;
- Sensor-Surface: 4mm (Mechanical Surface Detection)
- Electronics: DAE4 Sn1220; Calibrated: 24/01/2013
- Phantom: SAM2; Type: SAM; Serial: TP1562
- Measurement SW: DASY52, Version 52.8 (1); SEMCAD X Version 14.6.5 (6469)

**Configuration/System Check Body 2450MHz/Area Scan (7x11x1):** Measurement grid: dx=10mm, dy=10mm, Maximum value of SAR (measured) = 12.9 mW/g

**Configuration/System Check Body 2450MHz/Zoom Scan (7x7x7)/Cube 0:** Measurement grid: dx=5mm, dy=5mm, dz=5mm, Reference Value = 80.669 V/m; Power Drift = 0.04 dB

Peak SAR (extrapolated) = 25.360 mW/g

**SAR(1 g) = 12 mW/g; SAR(10 g) = 5.45 mW/g** Maximum value of SAR (measured) = 13.8 mW/g

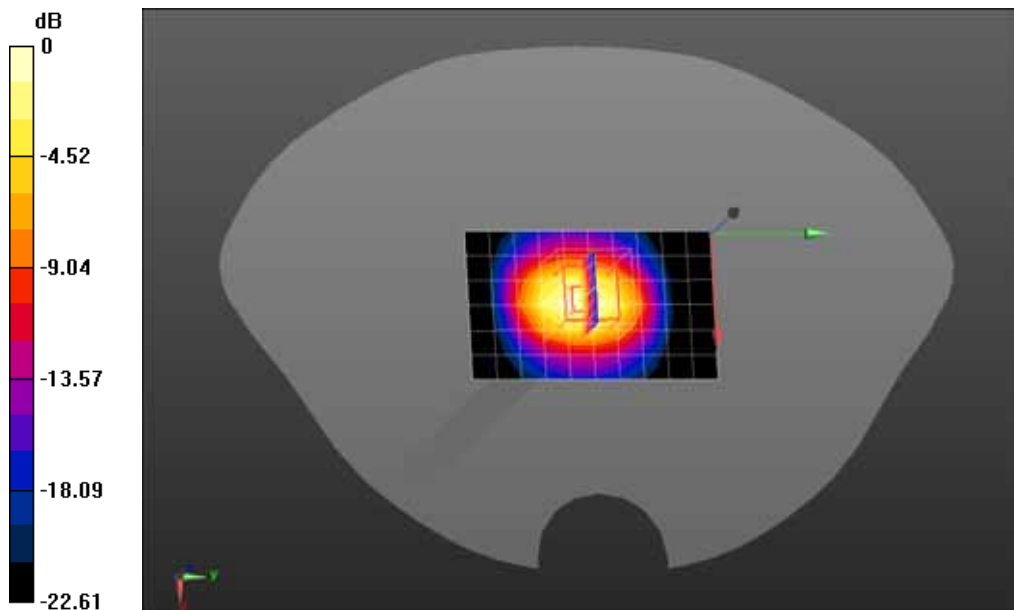

0 dB = 13.8 mW/g = 22.80 dB mW/g

## Appendix B. SAR measurement Data

Date/Time: 05-06-2013

Test Laboratory: QuieTek Lab

GSM850 Mid Touch-Left

**DUT: Smartphone ; Type: 9788**

Communication System: Generic GSM; Communication System Band: GSM850; Duty Cycle: 1:8.3;

Frequency: 836.4 MHz; Medium parameters used:  $f = 836.4$  MHz;  $\sigma = 0.87$  mho/m;  $\epsilon_r = 41.11$ ;  $\rho = 1000$  kg/m<sup>3</sup> ; Phantom section: Left Section

Ambient temperature (°C): 21.5, Liquid temperature (°C): 21.0

DASY5 Configuration:

- Probe: EX3DV4 - SN3710; ConvF(9.52, 9.52, 9.52); Calibrated: 27/03/2013;
- Sensor-Surface: 4mm (Mechanical Surface Detection)
- Electronics: DAE4 Sn1220; Calibrated: 24/01/2013
- Phantom: SAM2; Type: SAM; Serial: TP1562
- Measurement SW: DASY52, Version 52.8 (1); SEMCAD X Version 14.6.5 (6469)

**Configuration/GSM850 Mid Touch-Left/Area Scan (7x11x1):** Measurement grid: dx=15mm, dy=15mm

Maximum value of SAR (measured) = 0.551 mW/g

**Configuration/GSM850 Mid Touch-Left/Zoom Scan (5x5x7)/Cube 0:** Measurement grid: dx=8mm,

dy=8mm, dz=5mm, Reference Value = 7.019 V/m; Power Drift = -0.06 dB

Peak SAR (extrapolated) = 0.714 mW/g

**SAR(1 g) = 0.534 mW/g; SAR(10 g) = 0.388 mW/g** Maximum value of SAR (measured) = 0.567 mW/g

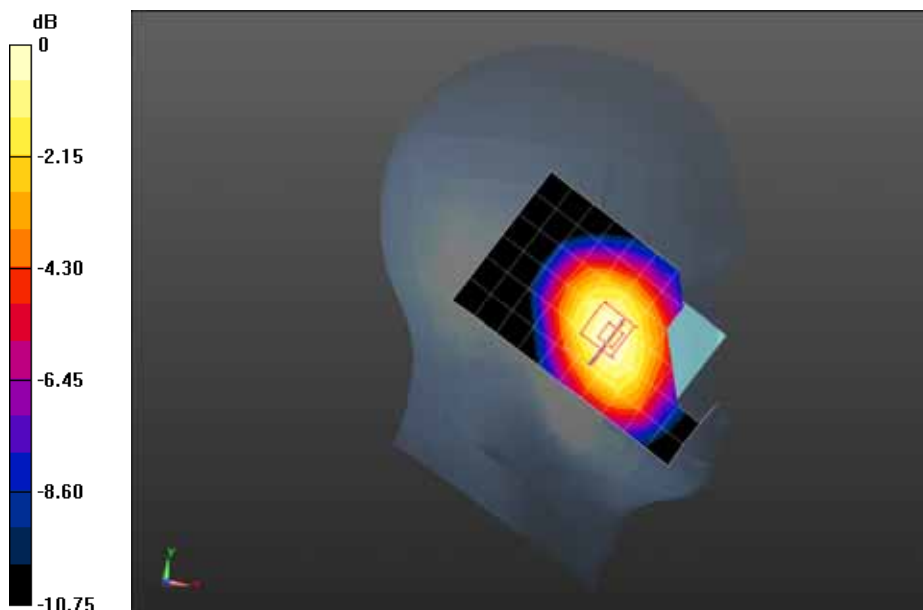

0 dB = 0.567 mW/g = -4.93 dB mW/g

Date/Time: 05-06-2013

Test Laboratory: QuieTek Lab

GSM850 Mid Tilt-Left

**DUT: Smartphone ; Type: 9788**

Communication System: Generic GSM; Communication System Band: GSM850; Duty Cycle: 1:8.3;  
 Frequency: 836.4 MHz; Medium parameters used:  $f = 836.4$  MHz;  $\sigma = 0.87$  mho/m;  $\epsilon_r = 41.11$ ;  $\rho = 1000$  kg/m<sup>3</sup> ; Phantom section: Left Section

Ambient temperature (°C): 21.5, Liquid temperature (°C): 21.0

DASY5 Configuration:

- Probe: EX3DV4 - SN3710; ConvF(9.52, 9.52, 9.52); Calibrated: 27/03/2013;
- Sensor-Surface: 4mm (Mechanical Surface Detection)
- Electronics: DAE4 Sn1220; Calibrated: 24/01/2013
- Phantom: SAM2; Type: SAM; Serial: TP1562
- Measurement SW: DASY52, Version 52.8 (1); SEMCAD X Version 14.6.5 (6469)

**Configuration/GSM850 Mid Tilt-Left/Area Scan (7x11x1):** Measurement grid: dx=15mm, dy=15mm

Maximum value of SAR (measured) = 0.380 mW/g

**Configuration/GSM850 Mid Tilt-Left/Zoom Scan (5x5x7)/Cube 0:** Measurement grid: dx=8mm, dy=8mm, dz=5mm, Reference Value = 11.185 V/m; Power Drift = -0.03 dB

Peak SAR (extrapolated) = 0.482 mW/g

**SAR(1 g) = 0.372 mW/g; SAR(10 g) = 0.273 mW/g** Maximum value of SAR (measured) = 0.392 mW/g

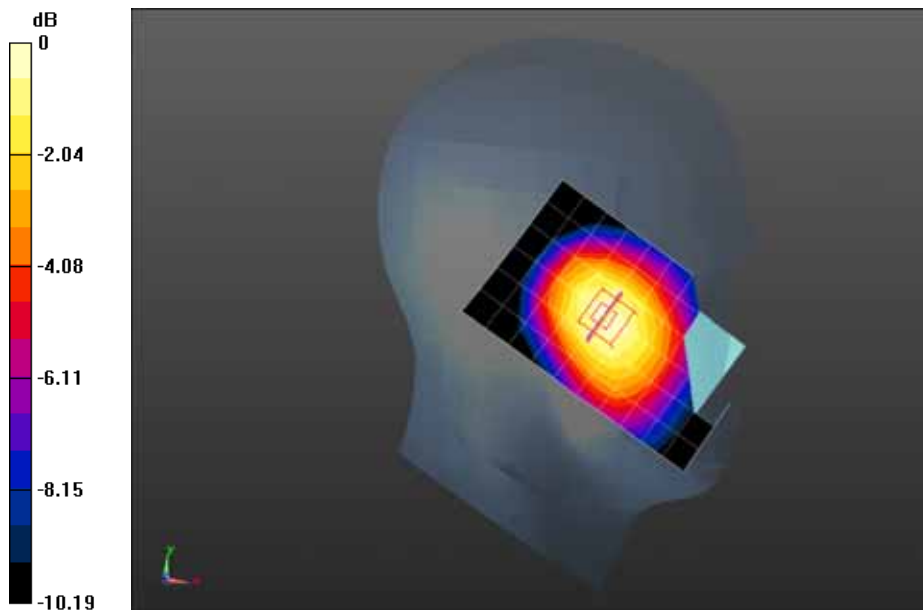

0 dB = 0.392 mW/g = -8.13 dB mW/g

Date/Time: 05-06-2013

Test Laboratory: QuieTek Lab

GSM850 Mid Touch-Right

**DUT: Smartphone ; Type: 9788**

Communication System: Generic GSM; Communication System Band: GSM850; Duty Cycle: 1:8.3;

Frequency: 836.4 MHz; Medium parameters used:  $f = 836.4$  MHz;  $\sigma = 0.87$  mho/m;  $\epsilon_r = 41.11$ ;  $\rho = 1000$  kg/m<sup>3</sup> ; Phantom section: Right Section

Ambient temperature (°C): 21.5, Liquid temperature (°C): 21.0

DASY5 Configuration:

- Probe: EX3DV4 - SN3710; ConvF(9.52, 9.52, 9.52); Calibrated: 27/03/2013;
- Sensor-Surface: 4mm (Mechanical Surface Detection)
- Electronics: DAE4 Sn1220; Calibrated: 24/01/2013
- Phantom: SAM2; Type: SAM; Serial: TP1562
- Measurement SW: DASY52, Version 52.8 (1); SEMCAD X Version 14.6.5 (6469)

**Configuration/GSM850 Mid Touch-Right/Area Scan (7x11x1):** Measurement grid: dx=15mm, dy=15mm

Maximum value of SAR (measured) = 0.304 mW/g

**Configuration/GSM850 Mid Touch-Right/Zoom Scan (5x5x7)/Cube 0:** Measurement grid: dx=8mm, dy=8mm, dz=5mm, Reference Value = 6.894 V/m; Power Drift = -0.16 dB

Peak SAR (extrapolated) = 0.422 mW/g

**SAR(1 g) = 0.304 mW/g; SAR(10 g) = 0.223 mW/g** Maximum value of SAR (measured) = 0.320 mW/g

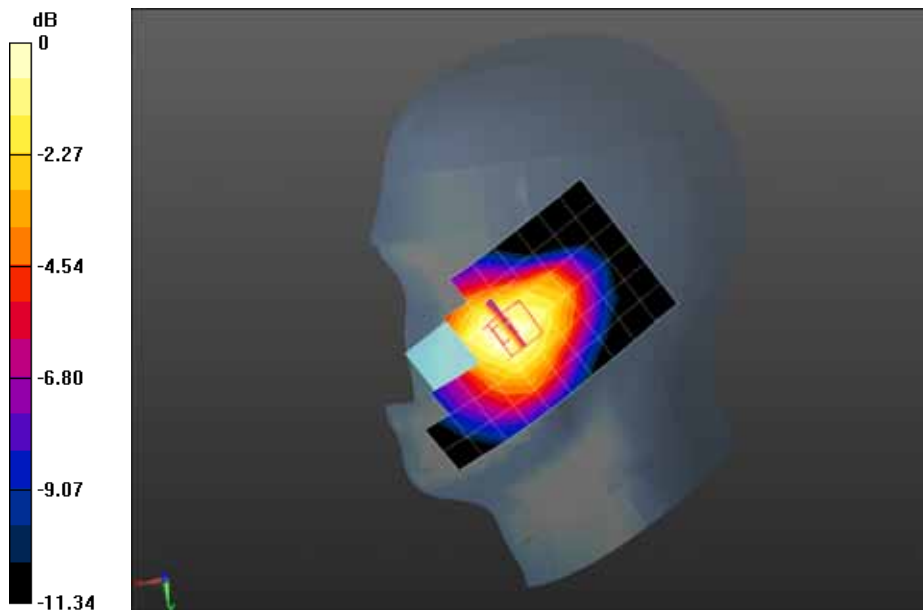

0 dB = 0.320 mW/g = -9.90 dB mW/g

Date/Time: 05-06-2013

Test Laboratory: QuieTek Lab

GSM850 Mid Tilt-Right

**DUT: Smartphone ; Type: 9788**

Communication System: Generic GSM; Communication System Band: GSM850; Duty Cycle: 1:8.3;  
 Frequency: 836.4 MHz; Medium parameters used:  $f = 836.4$  MHz;  $\sigma = 0.87$  mho/m;  $\epsilon_r = 41.11$ ;  $\rho = 1000$  kg/m<sup>3</sup> ; Phantom section: Right Section

Ambient temperature (°C): 21.5, Liquid temperature (°C): 21.0

DASY5 Configuration:

- Probe: EX3DV4 - SN3710; ConvF(9.52, 9.52, 9.52); Calibrated: 27/03/2013;
- Sensor-Surface: 4mm (Mechanical Surface Detection)
- Electronics: DAE4 Sn1220; Calibrated: 24/01/2013
- Phantom: SAM2; Type: SAM; Serial: TP1562
- Measurement SW: DASY52, Version 52.8 (1); SEMCAD X Version 14.6.5 (6469)

**Configuration/GSM850 Mid Tilt-Right/Area Scan (7x11x1):** Measurement grid: dx=15mm, dy=15mm

Maximum value of SAR (measured) = 0.225 mW/g

**Configuration/GSM850 Mid Tilt-Right/Zoom Scan (5x5x7)/Cube 0:** Measurement grid: dx=8mm, dy=8mm, dz=5mm, Reference Value = 10.135 V/m; Power Drift = 0.15 dB

Peak SAR (extrapolated) = 0.302 mW/g

**SAR(1 g) = 0.227 mW/g; SAR(10 g) = 0.163 mW/g** Maximum value of SAR (measured) = 0.237 mW/g

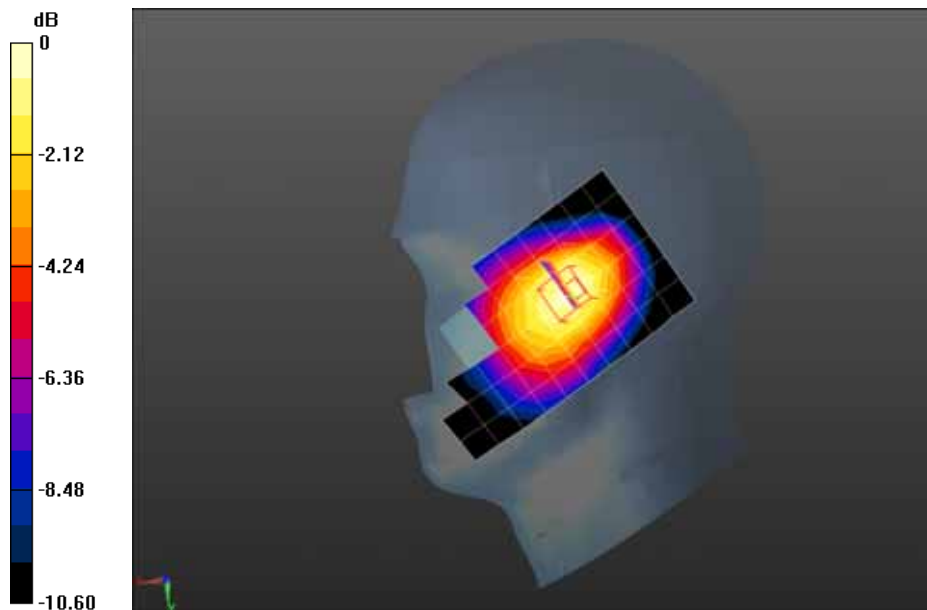

0 dB = 0.237 mW/g = -12.51 dB mW/g

Date/Time: 05-06-2013

Test Laboratory: QuieTek Lab

GSM850 Mid Body-Back

**DUT: Smartphone ; Type: 9788**

Communication System: Generic GSM; Communication System Band: GSM850; Duty Cycle: 1:8.3;  
 Frequency: 836.4 MHz; Medium parameters used:  $f = 836.4$  MHz;  $\sigma = 0.97$  mho/m;  $\epsilon_r = 52.88$ ;  $\rho = 1000$  kg/m<sup>3</sup> ; Phantom section: Flat Section

Ambient temperature (°C): 21.5, Liquid temperature (°C): 21.0

DASY5 Configuration:

- Probe: EX3DV4 - SN3710; ConvF(9.41, 9.41, 9.41); Calibrated: 27/03/2013;
- Sensor-Surface: 4mm (Mechanical Surface Detection)
- Electronics: DAE4 Sn1220; Calibrated: 24/01/2013
- Phantom: SAM1; Type: SAM; Serial: TP1561
- Measurement SW: DASY52, Version 52.8 (1); SEMCAD X Version 14.6.5 (6469)

**Configuration/GSM850 Mid Body-Back/Area Scan (7x11x1):** Measurement grid: dx=15mm, dy=15mm

Maximum value of SAR (measured) = 0.715 mW/g

**Configuration/GSM850 Mid Body-Back/Zoom Scan (5x5x7)/Cube 1:** Measurement grid: dx=8mm, dy=8mm, dz=5mm, Reference Value = 17.072 V/m; Power Drift = 0.03 dB

Peak SAR (extrapolated) = 0.928 mW/g

**SAR(1 g) = 0.646 mW/g; SAR(10 g) = 0.451 mW/g** Maximum value of SAR (measured) = 0.730 mW/g

**Configuration/GSM850 Mid Body-Back/Zoom Scan (5x5x7)/Cube 0:** Measurement grid: dx=8mm, dy=8mm, dz=5mm, Reference Value = 17.072 V/m; Power Drift = 0.03 dB

Peak SAR (extrapolated) = 0.916 mW/g

**SAR(1 g) = 0.701 mW/g; SAR(10 g) = 0.512 mW/g** Maximum value of SAR (measured) = 0.743 mW/g

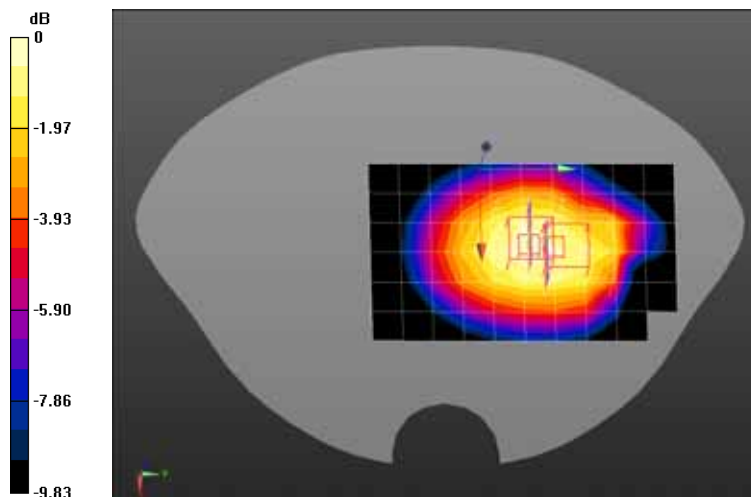

0 dB = 0.743 mW/g = -2.58 dB mW/g



Date/Time: 05-06-2013

Test Laboratory: QuieTek Lab

GPRS850 Low Body-Back(3up)

**DUT: Smartphone ; Type: 9788**

Communication System: GPRS/EGPRS-3 Slot; Communication System Band: GSM850; Duty Cycle: 1:2.8 ;  
 Frequency: 824.2 MHz; Medium parameters used:  $f = 824.2$  MHz;  $\sigma = 0.96$  mho/m;  $\epsilon_r = 52.97$ ;  $\rho = 1000$  kg/m<sup>3</sup> ; Phantom section: Flat Section

Ambient temperature (°C): 21.5, Liquid temperature (°C): 21.0

DASY5 Configuration:

- Probe: EX3DV4 - SN3710; ConvF(9.41, 9.41, 9.41); Calibrated: 27/03/2013;
- Sensor-Surface: 4mm (Mechanical Surface Detection)
- Electronics: DAE4 Sn1220; Calibrated: 24/01/2013
- Phantom: SAM1; Type: SAM; Serial: TP1561
- Measurement SW: DASY52, Version 52.8 (1); SEMCAD X Version 14.6.5 (6469)

**Configuration/GPRS850 Low Body-Back/Area Scan (7x11x1):** Measurement grid: dx=15mm, dy=15mm

Maximum value of SAR (measured) = 1.37 mW/g

**Configuration/GPRS850 Low Body-Back/Zoom Scan (5x5x7)/Cube 1:** Measurement grid: dx=8mm, dy=8mm, dz=5mm, Reference Value = 11.601 V/m; Power Drift = -0.14 dB

Peak SAR (extrapolated) = 1.622 mW/g

**SAR(1 g) = 1.18 mW/g; SAR(10 g) = 0.809 mW/g** Maximum value of SAR (measured) = 1.32 mW/g

**Configuration/GPRS850 Low Body-Back/Zoom Scan (5x5x7)/Cube 0:** Measurement grid: dx=8mm, dy=8mm, dz=5mm, Reference Value = 11.601 V/m; Power Drift = -0.14 dB

Peak SAR (extrapolated) = 1.678 mW/g

**SAR(1 g) = 1.31 mW/g; SAR(10 g) = 0.962 mW/g** Maximum value of SAR (measured) = 1.38 mW/g

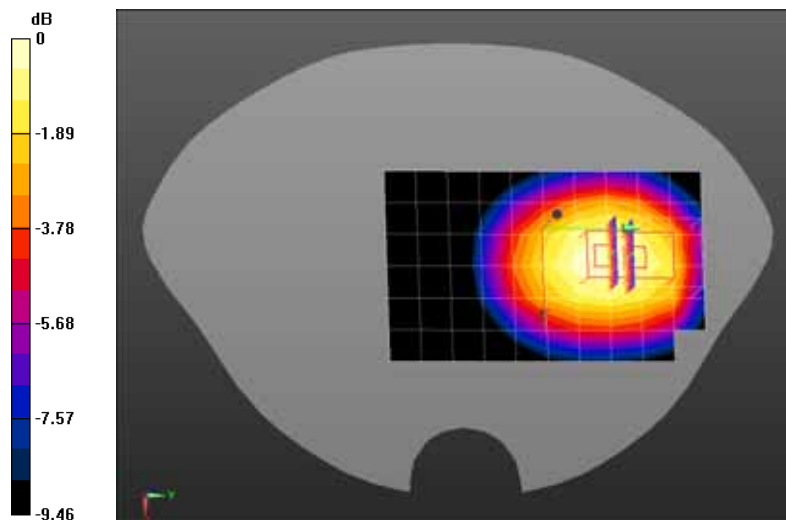

0 dB = 1.38 mW/g = 2.80 dB mW/g

Z-Axis Plot

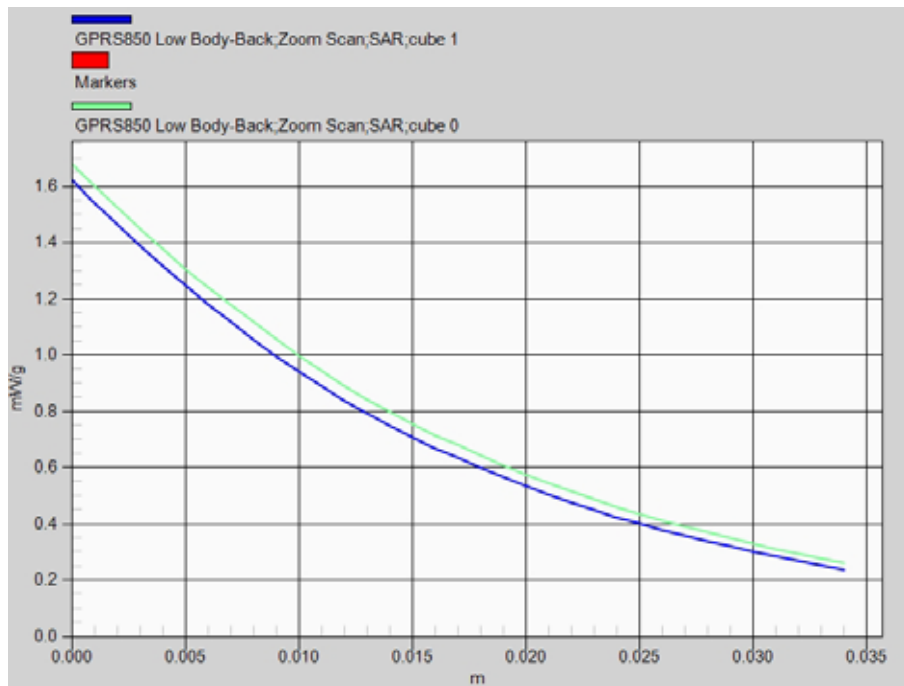

Date/Time: 05-06-2013

Test Laboratory: QuieTek Lab

GPRS850 Low Body-Back(3up)-1

**DUT: Smartphone ; Type: 9788**

Communication System: GPRS/EGPRS-3 Slot; Communication System Band: GSM850; Duty Cycle: 1:2.8 ; Frequency: 824.2 MHz; Medium parameters used:  $f = 824.2$  MHz;  $\sigma = 0.96$  mho/m;  $\epsilon_r = 52.97$ ;  $\rho = 1000$  kg/m<sup>3</sup> ; Phantom section: Flat Section

Ambient temperature (°C): 21.5, Liquid temperature (°C): 21.0

DASY5 Configuration:

- Probe: EX3DV4 - SN3710; ConvF(9.41, 9.41, 9.41); Calibrated: 27/03/2013;
- Sensor-Surface: 4mm (Mechanical Surface Detection)
- Electronics: DAE4 Sn1220; Calibrated: 24/01/2013
- Phantom: SAM1; Type: SAM; Serial: TP1561
- Measurement SW: DASY52, Version 52.8 (1); SEMCAD X Version 14.6.5 (6469)

**Configuration/GPRS850 Low Body-Back/Area Scan (7x11x1):** Measurement grid: dx=15mm, dy=15mm

Maximum value of SAR (measured) = 1.35 mW/g

**Configuration/GPRS850 Low Body-Back/Zoom Scan (5x5x7)/Cube 1:** Measurement grid: dx=8mm, dy=8mm, dz=5mm, Reference Value = 11.126 V/m; Power Drift = 0.01 dB

Peak SAR (extrapolated) = 1.672 mW/g

**SAR(1 g) = 1.17 mW/g; SAR(10 g) = 0.794 mW/g** Maximum value of SAR (measured) = 1.32 mW/g

**Configuration/GPRS850 Low Body-Back/Zoom Scan (5x5x7)/Cube 0:** Measurement grid: dx=8mm, dy=8mm, dz=5mm, Reference Value = 11.126 V/m; Power Drift = 0.01 dB

Peak SAR (extrapolated) = 1.690 mW/g

**SAR(1 g) = 1.3 mW/g; SAR(10 g) = 0.951 mW/g** Maximum value of SAR (measured) = 1.37 mW/g

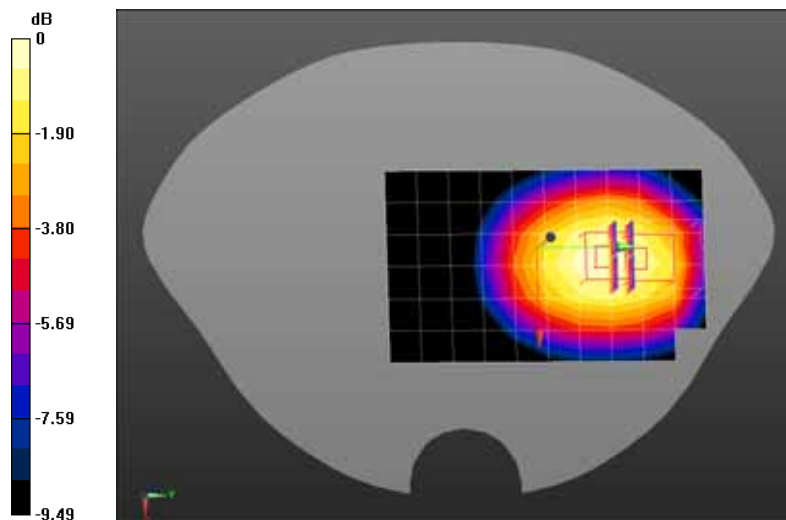

0 dB = 1.37 mW/g = 2.73 dB mW/g

Date/Time: 05-06-2013

Test Laboratory: QuieTek Lab

GPRS850 Mid Body-Back(3up)

**DUT: Smartphone ; Type: 9788**

Communication System: GPRS/EGPRS-3 Slot; Communication System Band: GSM850; Duty Cycle: 1:2.8 ; Frequency: 836.4 MHz; Medium parameters used:  $f = 836.4$  MHz;  $\sigma = 0.97$  mho/m;  $\epsilon_r = 52.88$ ;  $\rho = 1000$  kg/m<sup>3</sup> ; Phantom section: Flat Section

Ambient temperature (°C): 21.5, Liquid temperature (°C): 21.0

DASY5 Configuration:

- Probe: EX3DV4 - SN3710; ConvF(9.41, 9.41, 9.41); Calibrated: 27/03/2013;
- Sensor-Surface: 4mm (Mechanical Surface Detection)
- Electronics: DAE4 Sn1220; Calibrated: 24/01/2013
- Phantom: SAM1; Type: SAM; Serial: TP1561
- Measurement SW: DASY52, Version 52.8 (1); SEMCAD X Version 14.6.5 (6469)

**Configuration/GPRS850 Mid Body-Back/Area Scan (7x11x1):** Measurement grid: dx=15mm, dy=15mm

Maximum value of SAR (measured) = 1.34 mW/g

**Configuration/GPRS850 Mid Body-Back/Zoom Scan (5x5x7)/Cube 1:** Measurement grid: dx=8mm, dy=8mm, dz=5mm, Reference Value = 11.298 V/m; Power Drift = 0.06 dB

Peak SAR (extrapolated) = 1.604 mW/g

**SAR(1 g) = 1.15 mW/g; SAR(10 g) = 0.783 mW/g** Maximum value of SAR (measured) = 1.30 mW/g

**Configuration/GPRS850 Mid Body-Back/Zoom Scan (5x5x7)/Cube 0:** Measurement grid: dx=8mm, dy=8mm, dz=5mm, Reference Value = 11.298 V/m; Power Drift = 0.06 dB

Peak SAR (extrapolated) = 1.706 mW/g

**SAR(1 g) = 1.3 mW/g; SAR(10 g) = 0.955 mW/g** Maximum value of SAR (measured) = 1.38 mW/g

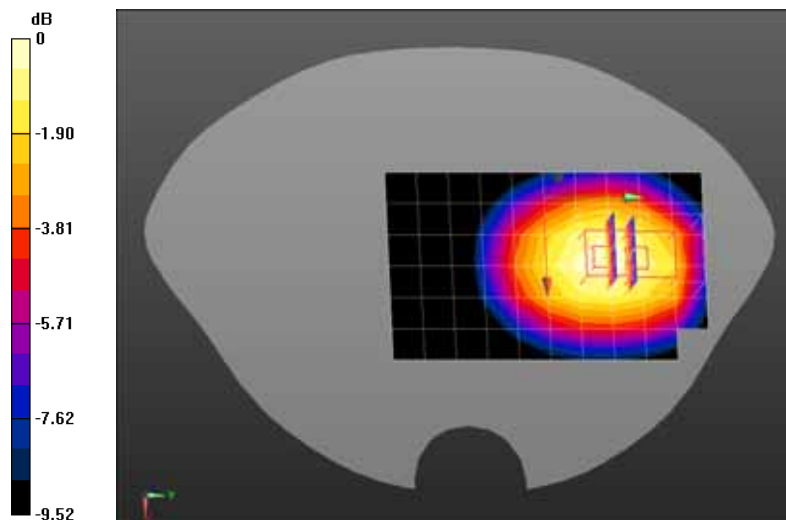

0 dB = 1.38 mW/g = 2.80 dB mW/g

Date/Time: 05-06-2013

Test Laboratory: QuieTek Lab

GPRS850 High Body-Back(3up)

**DUT: Smartphone ; Type: 9788**

Communication System: GPRS/EGPRS-3 Slot; Communication System Band: GSM850; Duty Cycle: 1:2.8 ; Frequency: 848.8 MHz; Medium parameters used:  $f = 848.8$  MHz;  $\sigma = 0.98$  mho/m;  $\epsilon_r = 52.68$ ;  $\rho = 1000$  kg/m<sup>3</sup> ; Phantom section: Flat Section

Ambient temperature (°C): 21.5, Liquid temperature (°C): 21.0

DASY5 Configuration:

- Probe: EX3DV4 - SN3710; ConvF(9.41, 9.41, 9.41); Calibrated: 27/03/2013;
- Sensor-Surface: 4mm (Mechanical Surface Detection)
- Electronics: DAE4 Sn1220; Calibrated: 24/01/2013
- Phantom: SAM1; Type: SAM; Serial: TP1561
- Measurement SW: DASY52, Version 52.8 (1); SEMCAD X Version 14.6.5 (6469)

**Configuration/GPRS850 High Body-Back/Area Scan (7x11x1):** Measurement grid: dx=15mm, dy=15mm

Maximum value of SAR (measured) = 1.22 mW/g

**Configuration/GPRS850 High Body-Back/Zoom Scan (5x5x7)/Cube 1:** Measurement grid: dx=8mm, dy=8mm, dz=5mm, Reference Value = 10.682 V/m; Power Drift = -0.11 dB

Peak SAR (extrapolated) = 1.391 mW/g

**SAR(1 g) = 1.01 mW/g; SAR(10 g) = 0.688 mW/g** Maximum value of SAR (measured) = 1.15 mW/g

**Configuration/GPRS850 High Body-Back/Zoom Scan (5x5x7)/Cube 0:** Measurement grid: dx=8mm, dy=8mm, dz=5mm, Reference Value = 10.682 V/m; Power Drift = -0.11 dB

Peak SAR (extrapolated) = 1.525 mW/g

**SAR(1 g) = 1.16 mW/g; SAR(10 g) = 0.850 mW/g** Maximum value of SAR (measured) = 1.22 mW/g

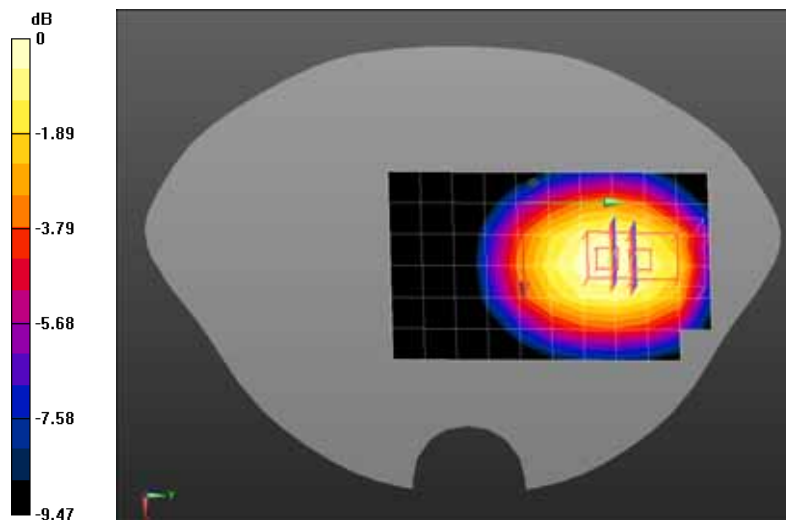

0 dB = 1.22 mW/g = 1.73 dB mW/g

Date/Time: 05-06-2013

Test Laboratory: QuieTek Lab

GPRS850 Mid Body-Front(3up)

**DUT: Smartphone ; Type: 9788**

Communication System: GPRS/EGPRS-3 Slot; Communication System Band: GSM850; Duty Cycle: 1:2.8 ; Frequency: 836.4 MHz; Medium parameters used:  $f = 836.4$  MHz;  $\sigma = 0.97$  mho/m;  $\epsilon_r = 52.88$ ;  $\rho = 1000$  kg/m<sup>3</sup> ; Phantom section: Flat Section

Ambient temperature (°C): 21.5, Liquid temperature (°C): 21.0

DASY5 Configuration:

- Probe: EX3DV4 - SN3710; ConvF(9.41, 9.41, 9.41); Calibrated: 27/03/2013;
- Sensor-Surface: 4mm (Mechanical Surface Detection)
- Electronics: DAE4 Sn1220; Calibrated: 24/01/2013
- Phantom: SAM1; Type: SAM; Serial: TP1561
- Measurement SW: DASY52, Version 52.8 (1); SEMCAD X Version 14.6.5 (6469)

**Configuration/GPRS850 Mid Body-Front/Area Scan (7x11x1):** Measurement grid: dx=15mm, dy=15mm

Maximum value of SAR (measured) = 0.765 mW/g

**Configuration/GPRS850 Mid Body-Front/Zoom Scan (5x5x7)/Cube 0:** Measurement grid: dx=8mm, dy=8mm, dz=5mm, Reference Value = 8.472 V/m; Power Drift = -0.05 dB

Peak SAR (extrapolated) = 0.998 mW/g

**SAR(1 g) = 0.745 mW/g; SAR(10 g) = 0.550 mW/g** Maximum value of SAR (measured) = 0.779 mW/g

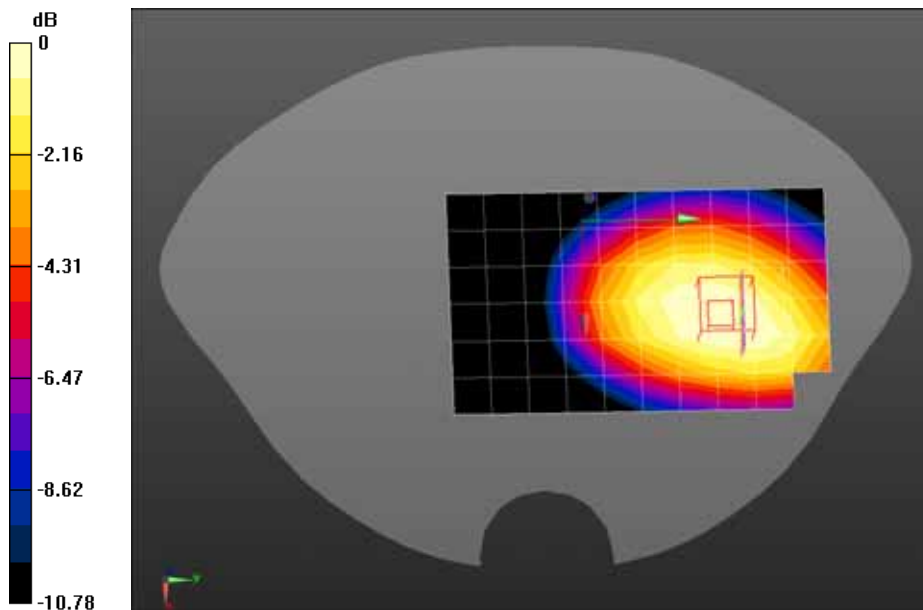

0 dB = 0.779 mW/g = -2.17 dB mW/g

Date/Time: 05-06-2013

Test Laboratory: QuieTek Lab

GPRS850 Mid Body-Bottom(3up)

**DUT: Smartphone ; Type: 9788**

Communication System: GPRS/EGPRS-3 Slot; Communication System Band: GSM850; Duty Cycle: 1:2.8 ;  
 Frequency: 836.4 MHz; Medium parameters used:  $f = 836.4$  MHz;  $\sigma = 0.97$  mho/m;  $\epsilon_r = 52.88$ ;  $\rho = 1000$  kg/m<sup>3</sup> ; Phantom section: Flat Section

Ambient temperature (°C): 21.5, Liquid temperature (°C): 21.0

DASY5 Configuration:

- Probe: EX3DV4 - SN3710; ConvF(9.41, 9.41, 9.41); Calibrated: 27/03/2013;
- Sensor-Surface: 4mm (Mechanical Surface Detection)
- Electronics: DAE4 Sn1220; Calibrated: 24/01/2013
- Phantom: SAM1; Type: SAM; Serial: TP1561
- Measurement SW: DASY52, Version 52.8 (1); SEMCAD X Version 14.6.5 (6469)

**Configuration/GPRS850 Mid Body-Bottom/Area Scan (7x7x1):** Measurement grid: dx=15mm, dy=15mm

Maximum value of SAR (measured) = 0.137 mW/g

**Configuration/GPRS850 Mid Body-Bottom/Zoom Scan (5x5x7)/Cube 0:** Measurement grid: dx=8mm, dy=8mm, dz=5mm, Reference Value = 8.973 V/m; Power Drift = 0.08 dB

Peak SAR (extrapolated) = 0.256 mW/g

**SAR(1 g) = 0.148 mW/g; SAR(10 g) = 0.088 mW/g** Maximum value of SAR (measured) = 0.157 mW/g

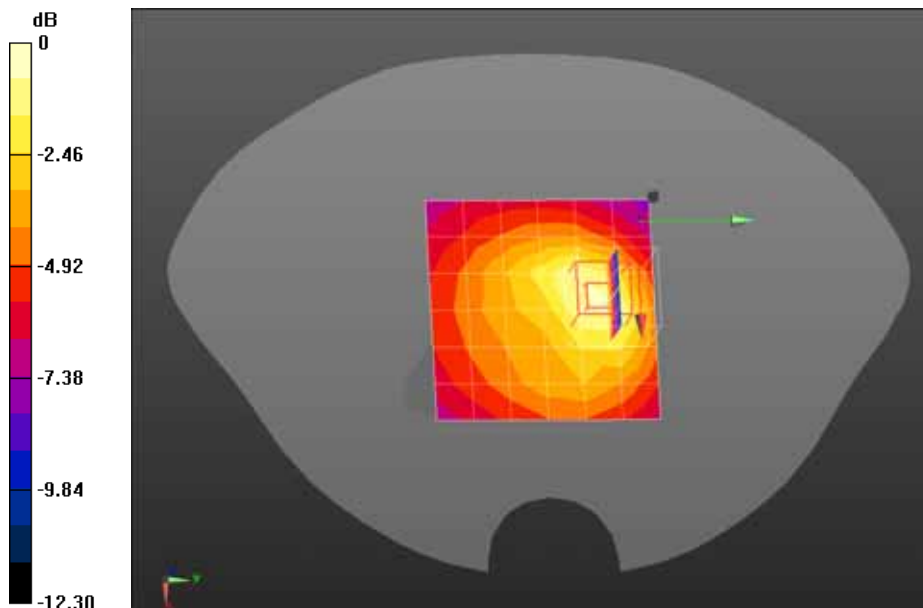

0 dB = 0.157 mW/g = -16.08 dB mW/g

Date/Time: 05-06-2013

Test Laboratory: QuieTek Lab

GPRS850 Mid Body-Left side(3up)

**DUT: Smartphone ; Type: 9788**

Communication System: GPRS/EGPRS-3 Slot; Communication System Band: GSM850; Duty Cycle: 1:2.8 ; Frequency: 836.4 MHz; Medium parameters used:  $f = 836.4$  MHz;  $\sigma = 0.97$  mho/m;  $\epsilon_r = 52.88$ ;  $\rho = 1000$  kg/m<sup>3</sup> ; Phantom section: Flat Section

Ambient temperature (°C): 21.5, Liquid temperature (°C): 21.0

DASY5 Configuration:

- Probe: EX3DV4 - SN3710; ConvF(9.41, 9.41, 9.41); Calibrated: 27/03/2013;
- Sensor-Surface: 4mm (Mechanical Surface Detection)
- Electronics: DAE4 Sn1220; Calibrated: 24/01/2013
- Phantom: SAM1; Type: SAM; Serial: TP1561
- Measurement SW: DASY52, Version 52.8 (1); SEMCAD X Version 14.6.5 (6469)

**Configuration/GPRS850 Mid Body-Left side/Area Scan (7x11x1):** Measurement grid: dx=15mm, dy=15mm, Maximum value of SAR (measured) = 0.282 mW/g

**Configuration/GPRS850 Mid Body-Left side/Zoom Scan (5x5x7)/Cube 0:** Measurement grid: dx=8mm, dy=8mm, dz=5mm, Reference Value = 7.929 V/m; Power Drift = -0.17 dB

Peak SAR (extrapolated) = 0.395 mW/g

**SAR(1 g) = 0.281 mW/g; SAR(10 g) = 0.190 mW/g** Maximum value of SAR (measured) = 0.303 mW/g

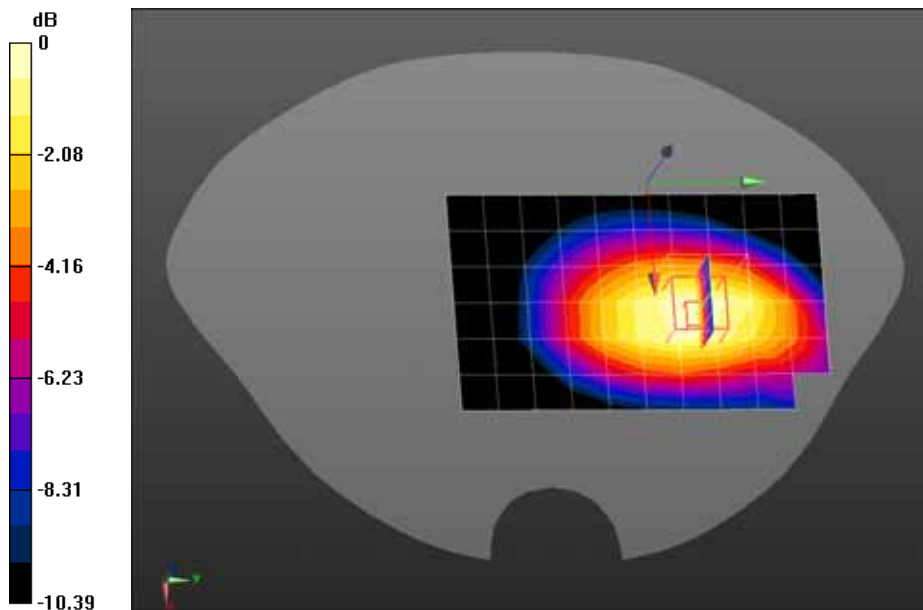

0 dB = 0.303 mW/g = -10.37 dB mW/g



Date/Time: 05-06-2013

Test Laboratory: QuieTek Lab

GPRS850 Mid Body-Right side(3up)

**DUT: Smartphone ; Type: 9788**

Communication System: GPRS/EGPRS-3 Slot; Communication System Band: GSM850; Duty Cycle: 1:2.8 ;  
 Frequency: 836.4 MHz; Medium parameters used:  $f = 836.4$  MHz;  $\sigma = 0.97$  mho/m;  $\epsilon_r = 52.88$ ;  $\rho = 1000$  kg/m<sup>3</sup> ; Phantom section: Flat Section

Ambient temperature (°C): 21.5, Liquid temperature (°C): 21.0

DASY5 Configuration:

- Probe: EX3DV4 - SN3710; ConvF(9.41, 9.41, 9.41); Calibrated: 27/03/2013;
- Sensor-Surface: 4mm (Mechanical Surface Detection)
- Electronics: DAE4 Sn1220; Calibrated: 24/01/2013
- Phantom: SAM1; Type: SAM; Serial: TP1561
- Measurement SW: DASY52, Version 52.8 (1); SEMCAD X Version 14.6.5 (6469)

**Configuration/GPRS850 Mid Body-Right side/Area Scan (7x11x1):** Measurement grid: dx=15mm, dy=15mm, Maximum value of SAR (measured) = 0.739 mW/g

**Configuration/GPRS850 Mid Body-Right side/Zoom Scan (5x5x7)/Cube 0:** Measurement grid: dx=8mm, dy=8mm, dz=5mm, Reference Value = 11.810 V/m; Power Drift = 0.02 dB

Peak SAR (extrapolated) = 0.952 mW/g

**SAR(1 g) = 0.691 mW/g; SAR(10 g) = 0.482 mW/g** Maximum value of SAR (measured) = 0.738 mW/g

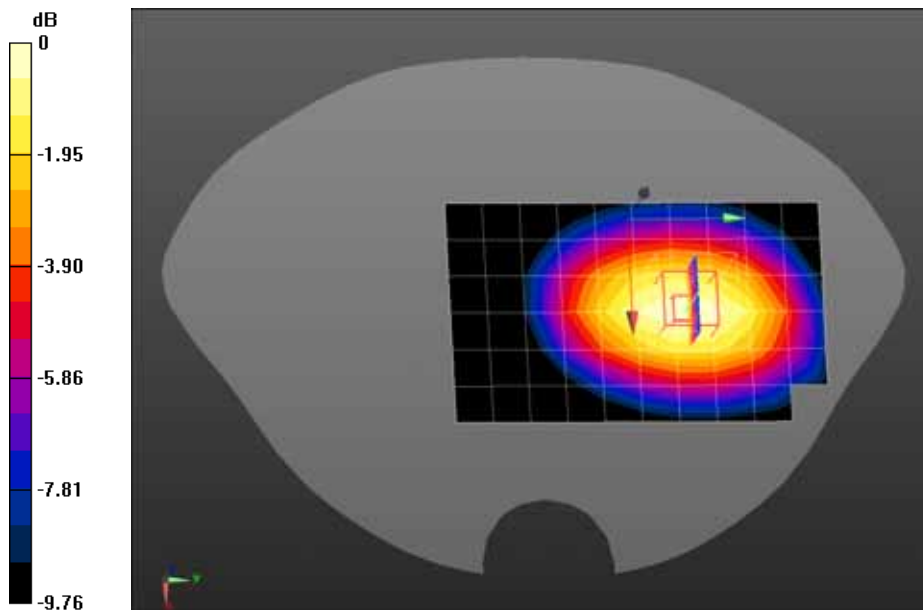

0 dB = 0.738 mW/g = -2.64 dB mW/g

Date/Time: 05-06-2013

Test Laboratory: QuieTek Lab

PCS1900 Mid Touch-Left

**DUT: Smartphone ; Type: 9788**

Communication System: Generic GSM; Communication System Band: PCS1900; Duty Cycle: 1:8.3;

Frequency: 1880 MHz; Medium parameters used:  $f = 1880$  MHz;  $\sigma = 1.44$  mho/m;  $\epsilon_r = 39$ ;  $\rho = 1000$  kg/m<sup>3</sup> ;

Phantom section: Left Section

Ambient temperature (°C): 21.5, Liquid temperature (°C): 21.0

DASY5 Configuration:

- Probe: EX3DV4 - SN3710; ConvF(7.75, 7.75, 7.75); Calibrated: 27/03/2013;
- Sensor-Surface: 4mm (Mechanical Surface Detection)
- Electronics: DAE4 Sn1220; Calibrated: 24/01/2013
- Phantom: SAM1; Type: SAM; Serial: TP1561
- Measurement SW: DASY52, Version 52.8 (1); SEMCAD X Version 14.6.5 (6469)

**Configuration/PCS1900 Mid Touch-Left/Area Scan (7x11x1):** Measurement grid: dx=15mm, dy=15mm

Maximum value of SAR (measured) = 0.616 mW/g

**Configuration/PCS1900 Mid Touch-Left/Zoom Scan (5x5x7)/Cube 0:** Measurement grid: dx=8mm, dy=8mm, dz=5mm, Reference Value = 7.232 V/m; Power Drift = -0.10 dB

Peak SAR (extrapolated) = 1.056 mW/g

**SAR(1 g) = 0.611 mW/g; SAR(10 g) = 0.332 mW/g** Maximum value of SAR (measured) = 0.689 mW/g

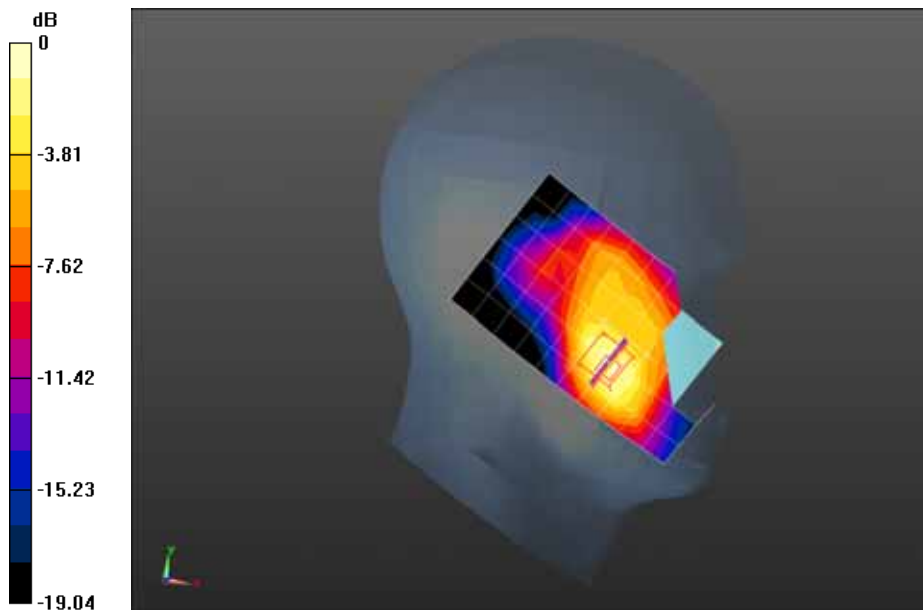

0 dB = 0.689 mW/g = -3.24 dB mW/g

Date/Time: 05-06-2013

Test Laboratory: QuieTek Lab

PCS1900 Mid Tilt-Left

**DUT: Smartphone ; Type: 9788**

Communication System: Generic GSM; Communication System Band: PCS1900; Duty Cycle: 1:8.3;

Frequency: 1880 MHz; Medium parameters used:  $f = 1880$  MHz;  $\sigma = 1.44$  mho/m;  $\epsilon_r = 39$ ;  $\rho = 1000$  kg/m<sup>3</sup> ;

Phantom section: Left Section

Ambient temperature (°C): 21.5, Liquid temperature (°C): 21.0

DASY5 Configuration:

- Probe: EX3DV4 - SN3710; ConvF(7.75, 7.75, 7.75); Calibrated: 27/03/2013;
- Sensor-Surface: 4mm (Mechanical Surface Detection)
- Electronics: DAE4 Sn1220; Calibrated: 24/01/2013
- Phantom: SAM1; Type: SAM; Serial: TP1561
- Measurement SW: DASY52, Version 52.8 (1); SEMCAD X Version 14.6.5 (6469)

**Configuration/PCS1900 Mid Tilt-Left/Area Scan (7x11x1):** Measurement grid: dx=15mm, dy=15mm

Maximum value of SAR (measured) = 0.158 mW/g

**Configuration/PCS1900 Mid Tilt-Left/Zoom Scan (5x5x7)/Cube 0:** Measurement grid: dx=8mm, dy=8mm, dz=5mm, Reference Value = 9.626 V/m; Power Drift = -0.01 dB

Peak SAR (extrapolated) = 0.235 mW/g

**SAR(1 g) = 0.145 mW/g; SAR(10 g) = 0.085 mW/g** Maximum value of SAR (measured) = 0.157 mW/g

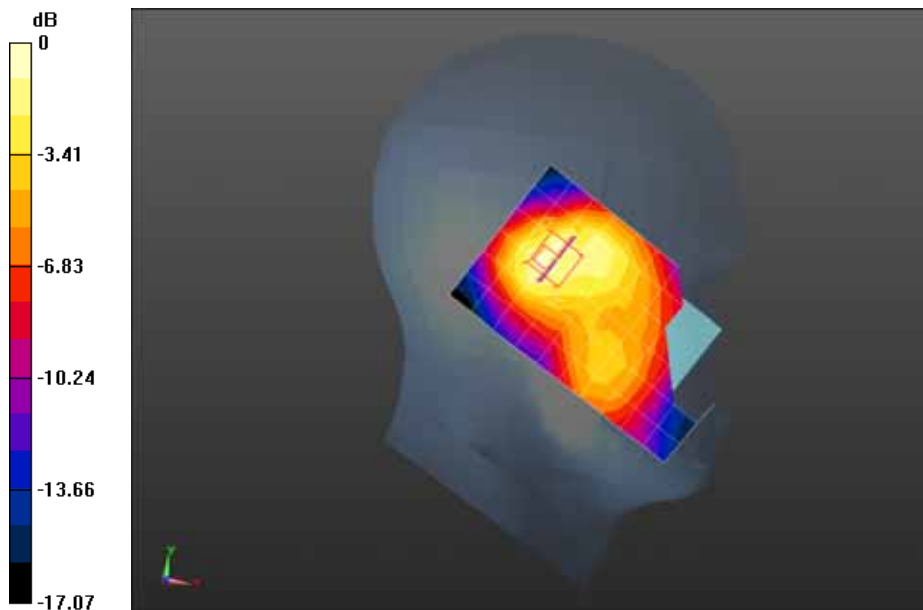

0 dB = 0.157 mW/g = -16.08 dB mW/g

Date/Time: 05-06-2013

Test Laboratory: QuieTek Lab

PCS1900 Mid Touch-Right

**DUT: Smartphone ; Type: 9788**

Communication System: Generic GSM; Communication System Band: PCS1900; Duty Cycle: 1:8.3;

Frequency: 1880 MHz; Medium parameters used:  $f = 1880$  MHz;  $\sigma = 1.44$  mho/m;  $\epsilon_r = 39$ ;  $\rho = 1000$  kg/m<sup>3</sup> ;

Phantom section: Right Section

Ambient temperature (°C): 21.5, Liquid temperature (°C): 21.0

DASY5 Configuration:

- Probe: EX3DV4 - SN3710; ConvF(7.75, 7.75, 7.75); Calibrated: 27/03/2013;
- Sensor-Surface: 4mm (Mechanical Surface Detection)
- Electronics: DAE4 Sn1220; Calibrated: 24/01/2013
- Phantom: SAM1; Type: SAM; Serial: TP1561
- Measurement SW: DASY52, Version 52.8 (1); SEMCAD X Version 14.6.5 (6469)

**Configuration/PCS1900 Mid Touch-Right/Area Scan (7x11x1):** Measurement grid: dx=15mm, dy=15mm

Maximum value of SAR (measured) = 0.339 mW/g

**Configuration/PCS1900 Mid Touch-Right/Zoom Scan (5x5x7)/Cube 0:** Measurement grid: dx=8mm,

dy=8mm, dz=5mm, Reference Value = 6.180 V/m; Power Drift = 0.05 dB

Peak SAR (extrapolated) = 0.565 mW/g

**SAR(1 g) = 0.361 mW/g; SAR(10 g) = 0.216 mW/g** Maximum value of SAR (measured) = 0.395 mW/g

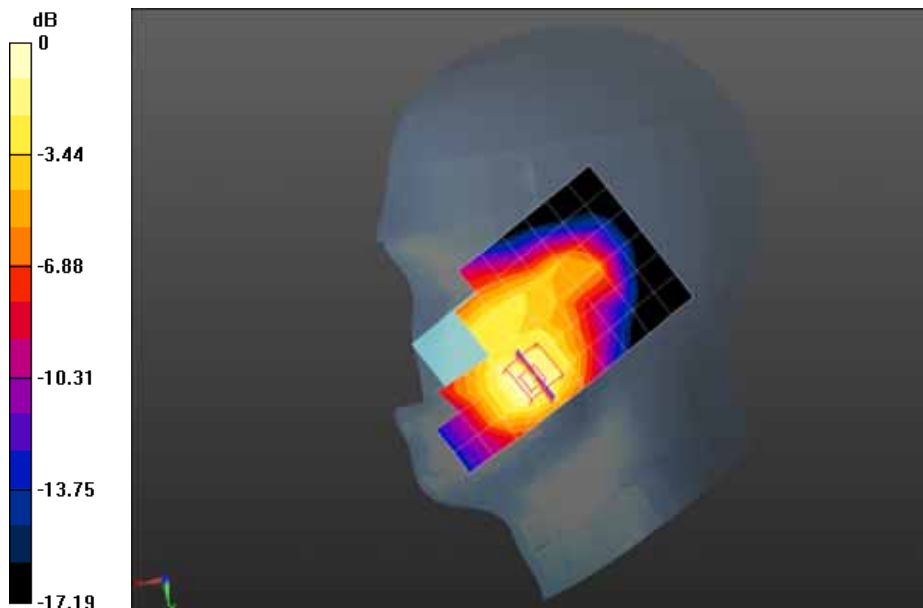

0 dB = 0.395 mW/g = -8.07 dB mW/g

Date/Time: 05-06-2013

Test Laboratory: QuieTek Lab

PCS1900 Mid Tilt-Right

**DUT: Smartphone ; Type: 9788**

Communication System: Generic GSM; Communication System Band: PCS1900; Duty Cycle: 1:8.3;

Frequency: 1880 MHz; Medium parameters used:  $f = 1880$  MHz;  $\sigma = 1.44$  mho/m;  $\epsilon_r = 39$ ;  $\rho = 1000$  kg/m<sup>3</sup> ;

Phantom section: Right Section

Ambient temperature (°C): 21.5, Liquid temperature (°C): 21.0

DASY5 Configuration:

- Probe: EX3DV4 - SN3710; ConvF(7.75, 7.75, 7.75); Calibrated: 27/03/2013;
- Sensor-Surface: 4mm (Mechanical Surface Detection)
- Electronics: DAE4 Sn1220; Calibrated: 24/01/2013
- Phantom: SAM1; Type: SAM; Serial: TP1561
- Measurement SW: DASY52, Version 52.8 (1); SEMCAD X Version 14.6.5 (6469)

**Configuration/PCS1900 Mid Tilt-Right/Area Scan (7x11x1):** Measurement grid: dx=15mm, dy=15mm

Maximum value of SAR (measured) = 0.184 mW/g

**Configuration/PCS1900 Mid Tilt-Right/Zoom Scan (5x5x7)/Cube 0:** Measurement grid: dx=8mm,

dy=8mm, dz=5mm, Reference Value = 8.326 V/m; Power Drift = 0.06 dB

Peak SAR (extrapolated) = 0.280 mW/g

**SAR(1 g) = 0.164 mW/g; SAR(10 g) = 0.092 mW/g** Maximum value of SAR (measured) = 0.176 mW/g

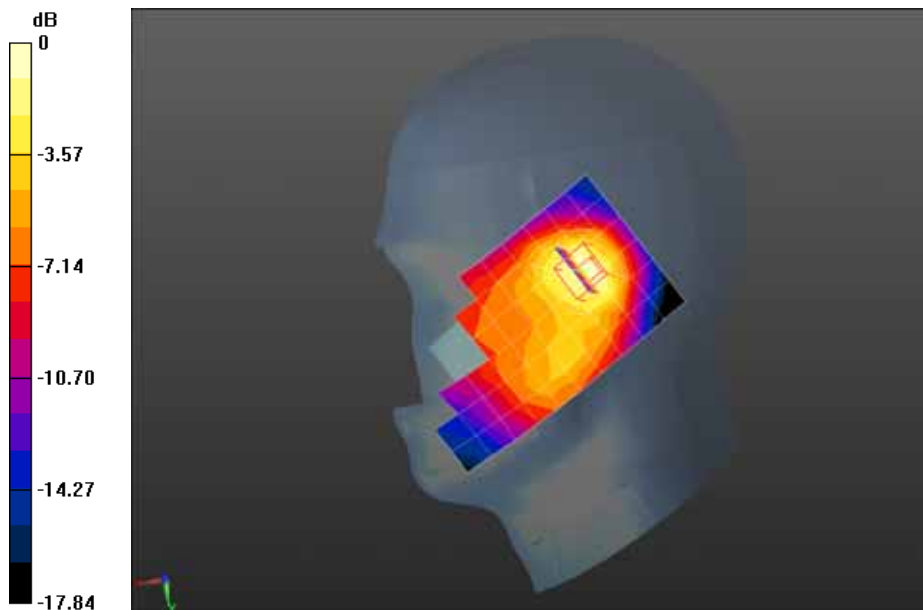

0 dB = 0.176 mW/g = -15.09 dB mW/g

Date/Time: 05-06-2013

Test Laboratory: QuieTek Lab

PCS1900 Mid Body-Back

**DUT: Smartphone ; Type: 9788**

Communication System: Generic GSM; Communication System Band: PCS1900; Duty Cycle: 1:8.3;

Frequency: 1880 MHz; Medium parameters used:  $f = 1880$  MHz;  $\sigma = 1.51$  mho/m;  $\epsilon_r = 53.01$ ;  $\rho = 1000$  kg/m<sup>3</sup> ; Phantom section: Flat Section

Ambient temperature (°C): 21.5, Liquid temperature (°C): 21.0

DASY5 Configuration:

- Probe: EX3DV4 - SN3710; ConvF(7.6, 7.6, 7.6); Calibrated: 27/03/2013;
- Sensor-Surface: 4mm (Mechanical Surface Detection)
- Electronics: DAE4 Sn1220; Calibrated: 24/01/2013
- Phantom: SAM1; Type: SAM; Serial: TP1561
- Measurement SW: DASY52, Version 52.8 (1); SEMCAD X Version 14.6.5 (6469)

**Configuration/PCS1900 Mid Body-Back/Area Scan (7x11x1):** Measurement grid: dx=15mm, dy=15mm

Maximum value of SAR (measured) = 0.548 mW/g

**Configuration/PCS1900 Mid Body-Back/Zoom Scan (5x5x7)/Cube 0:** Measurement grid: dx=8mm, dy=8mm, dz=5mm, Reference Value = 7.100 V/m; Power Drift = 0.08 dB

Peak SAR (extrapolated) = 0.907 mW/g

**SAR(1 g) = 0.561 mW/g; SAR(10 g) = 0.332 mW/g** Maximum value of SAR (measured) = 0.602 mW/g

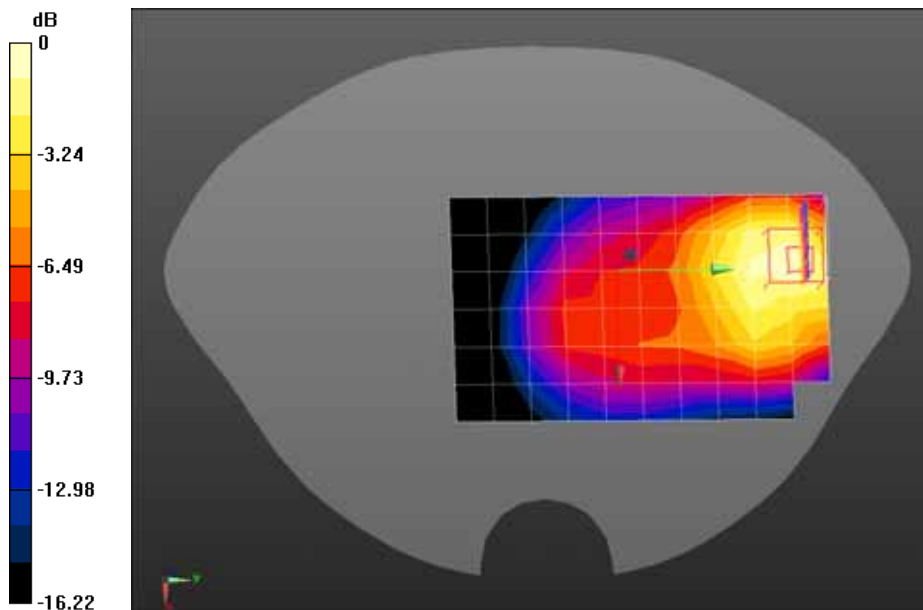

0 dB = 0.602 mW/g = -4.41 dB mW/g

Date/Time: 05-06-2013

Test Laboratory: QuieTek Lab

GPRS1900 Low Body-Back(3up)

**DUT: Smartphone ; Type: 9788**

Communication System: GPRS/EGPRS-3 Slot; Communication System Band: PCS1900; Duty Cycle: 1:2.8 ; Frequency: 1850.2 MHz; Medium parameters used:  $f = 1850.2$  MHz;  $\sigma = 1.47$  mho/m;  $\epsilon_r = 53.16$ ;  $\rho = 1000$  kg/m<sup>3</sup> ; Phantom section: Flat Section

Ambient temperature (°C): 21.5, Liquid temperature (°C): 21.0

DASY5 Configuration:

- Probe: EX3DV4 - SN3710; ConvF(7.6, 7.6, 7.6); Calibrated: 27/03/2013;
- Sensor-Surface: 4mm (Mechanical Surface Detection)
- Electronics: DAE4 Sn1220; Calibrated: 24/01/2013
- Phantom: SAM1; Type: SAM; Serial: TP1561
- Measurement SW: DASY52, Version 52.8 (1); SEMCAD X Version 14.6.5 (6469)

**Configuration/GPRS1900 Low Body-Back/Area Scan (7x11x1):** Measurement grid: dx=15mm, dy=15mm, Maximum value of SAR (measured) = 0.735 mW/g

**Configuration/GPRS1900 Low Body-Back/Zoom Scan (5x5x7)/Cube 0:** Measurement grid: dx=8mm, dy=8mm, dz=5mm, Reference Value = 8.362 V/m; Power Drift = -0.04 dB

Peak SAR (extrapolated) = 1.240 mW/g

**SAR(1 g) = 0.768 mW/g; SAR(10 g) = 0.456 mW/g** Maximum value of SAR (measured) = 0.826 mW/g

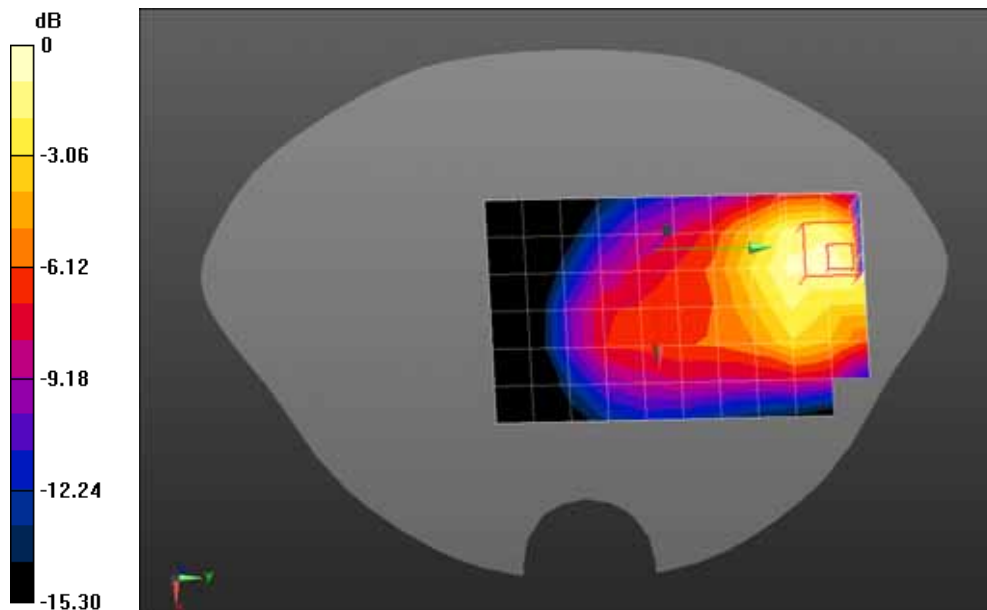

0 dB = 0.826 mW/g = -1.66 dB mW/g

Date/Time: 05-06-2013

Test Laboratory: QuieTek Lab

GPRS1900 Mid Body-Back(3up)

**DUT: Smartphone ; Type: 9788**

Communication System: GPRS/EGPRS-3 Slot; Communication System Band: PCS1900; Duty Cycle: 1:2.8 ;  
 Frequency: 1880 MHz; Medium parameters used:  $f = 1880$  MHz;  $\sigma = 1.51$  mho/m;  $\epsilon_r = 53.01$ ;  $\rho = 1000$  kg/m<sup>3</sup> ; Phantom section: Flat Section

Ambient temperature (°C): 21.5, Liquid temperature (°C): 21.0

DASY5 Configuration:

- Probe: EX3DV4 - SN3710; ConvF(7.6, 7.6, 7.6); Calibrated: 27/03/2013;
- Sensor-Surface: 4mm (Mechanical Surface Detection)
- Electronics: DAE4 Sn1220; Calibrated: 24/01/2013
- Phantom: SAM1; Type: SAM; Serial: TP1561
- Measurement SW: DASY52, Version 52.8 (1); SEMCAD X Version 14.6.5 (6469)

**Configuration/GPRS1900 Mid Body-Back/Area Scan (7x11x1):** Measurement grid: dx=15mm, dy=15mm

Maximum value of SAR (measured) = 0.862 mW/g

**Configuration/GPRS1900 Mid Body-Back/Zoom Scan (5x5x7)/Cube 0:** Measurement grid: dx=8mm, dy=8mm, dz=5mm, Reference Value = 9.129 V/m; Power Drift = -0.10 dB

Peak SAR (extrapolated) = 1.382 mW/g

**SAR(1 g) = 0.871 mW/g; SAR(10 g) = 0.516 mW/g** Maximum value of SAR (measured) = 0.942 mW/g

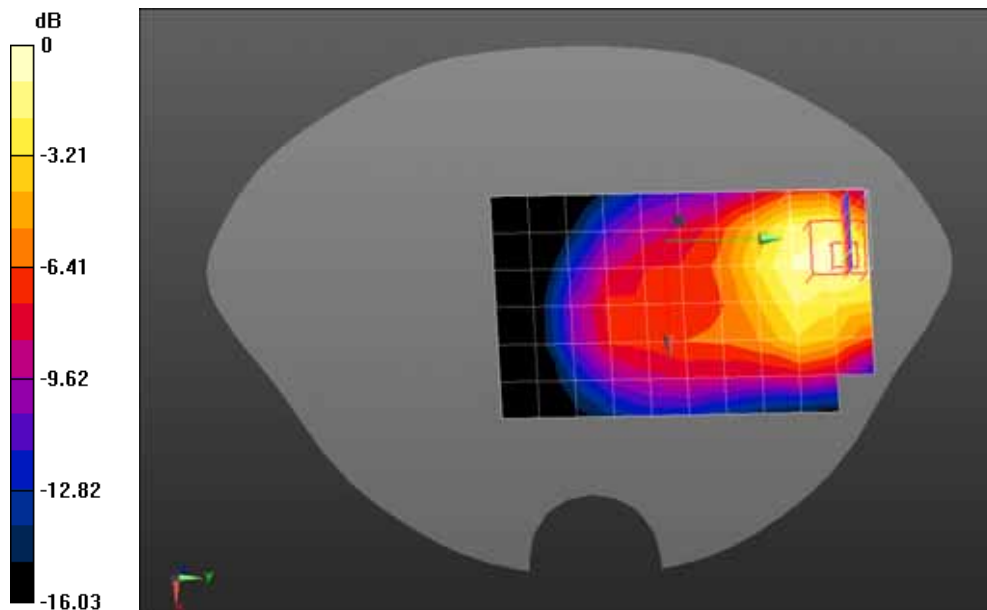

0 dB = 0.942 mW/g = -0.52 dB mW/g



Date/Time: 05-06-2013

Test Laboratory: QuieTek Lab

GPRS1900 High Body-Back(3up)

**DUT: Smartphone ; Type: 9788**

Communication System: GPRS/EGPRS-3 Slot; Communication System Band: PCS1900; Duty Cycle: 1:2.8 ;  
 Frequency: 1909.8 MHz; Medium parameters used:  $f = 1909.8 \text{ MHz}$ ;  $\sigma = 1.55 \text{ mho/m}$ ;  $\epsilon_r = 52.9$ ;  $\rho = 1000 \text{ kg/m}^3$  ; Phantom section: Flat Section

Ambient temperature (°C): 21.5, Liquid temperature (°C): 21.0

DASY5 Configuration:

- Probe: EX3DV4 - SN3710; ConvF(7.6, 7.6, 7.6); Calibrated: 27/03/2013;
- Sensor-Surface: 4mm (Mechanical Surface Detection)
- Electronics: DAE4 Sn1220; Calibrated: 24/01/2013
- Phantom: SAM1; Type: SAM; Serial: TP1561
- Measurement SW: DASY52, Version 52.8 (1); SEMCAD X Version 14.6.5 (6469)

**Configuration/GPRS1900 High Body-Back/Area Scan (7x11x1):** Measurement grid: dx=15mm, dy=15mm, Maximum value of SAR (measured) = 0.989 mW/g

**Configuration/GPRS1900 High Body-Back/Zoom Scan (5x5x7)/Cube 0:** Measurement grid: dx=8mm, dy=8mm, dz=5mm, Reference Value = 9.001 V/m; Power Drift = -0.07 dB

Peak SAR (extrapolated) = 1.570 mW/g

**SAR(1 g) = 0.976 mW/g; SAR(10 g) = 0.572 mW/g** Maximum value of SAR (measured) = 1.08 mW/g

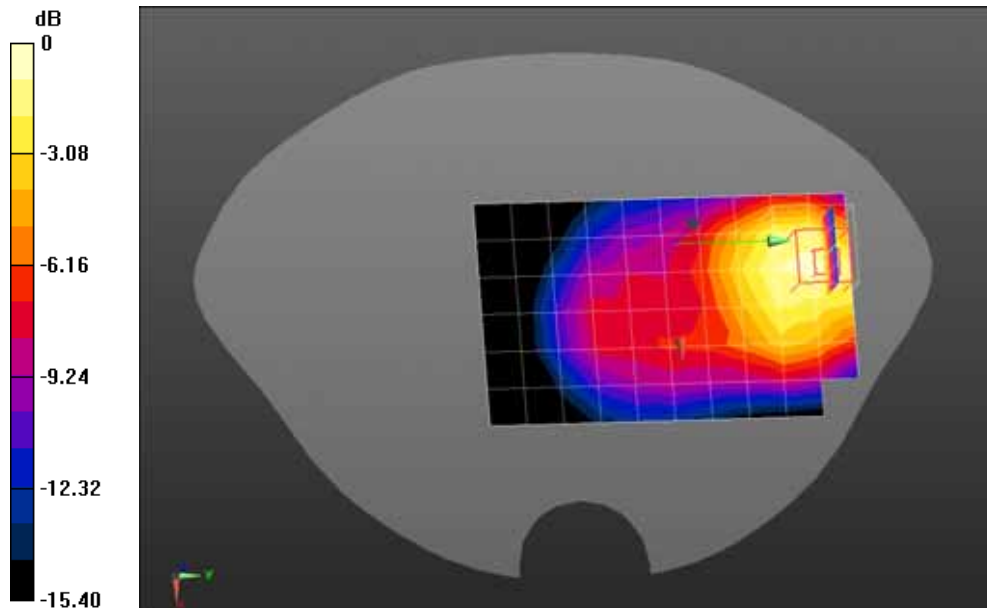

0 dB = 1.08 mW/g = 0.67 dB mW/g

Z-Axis Plot

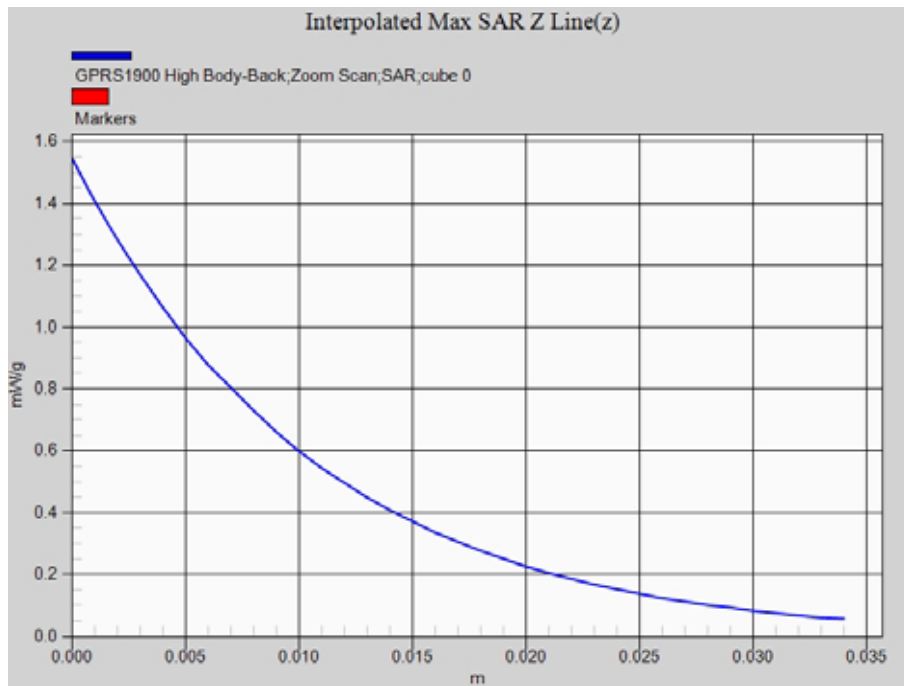

Date/Time: 05-06-2013

Test Laboratory: QuieTek Lab

GPRS1900 High Body-Back(3up)-1

**DUT: Smartphone ; Type: 9788**

Communication System: GPRS/EGPRS-3 Slot; Communication System Band: PCS1900; Duty Cycle: 1:2.8 ;  
 Frequency: 1909.8 MHz; Medium parameters used:  $f = 1909.8 \text{ MHz}$ ;  $\sigma = 1.55 \text{ mho/m}$ ;  $\epsilon_r = 52.9$ ;  $\rho = 1000 \text{ kg/m}^3$  ; Phantom section: Flat Section

Ambient temperature (°C): 21.5, Liquid temperature (°C): 21.0

DASY5 Configuration:

- Probe: EX3DV4 - SN3710; ConvF(7.6, 7.6, 7.6); Calibrated: 27/03/2013;
- Sensor-Surface: 4mm (Mechanical Surface Detection)
- Electronics: DAE4 Sn1220; Calibrated: 24/01/2013
- Phantom: SAM1; Type: SAM; Serial: TP1561
- Measurement SW: DASY52, Version 52.8 (1); SEMCAD X Version 14.6.5 (6469)

**Configuration/GPRS1900 High Body-Back/Area Scan (7x11x1):** Measurement grid: dx=15mm, dy=15mm, Maximum value of SAR (measured) = 0.972 mW/g

**Configuration/GPRS1900 High Body-Back/Zoom Scan (5x5x7)/Cube 0:** Measurement grid: dx=8mm, dy=8mm, dz=5mm, Reference Value = 8.902 V/m; Power Drift = -0.01 dB

Peak SAR (extrapolated) = 1.548 mW/g

**SAR(1 g) = 0.965 mW/g; SAR(10 g) = 0.567 mW/g** Maximum value of SAR (measured) = 1.06 mW/g

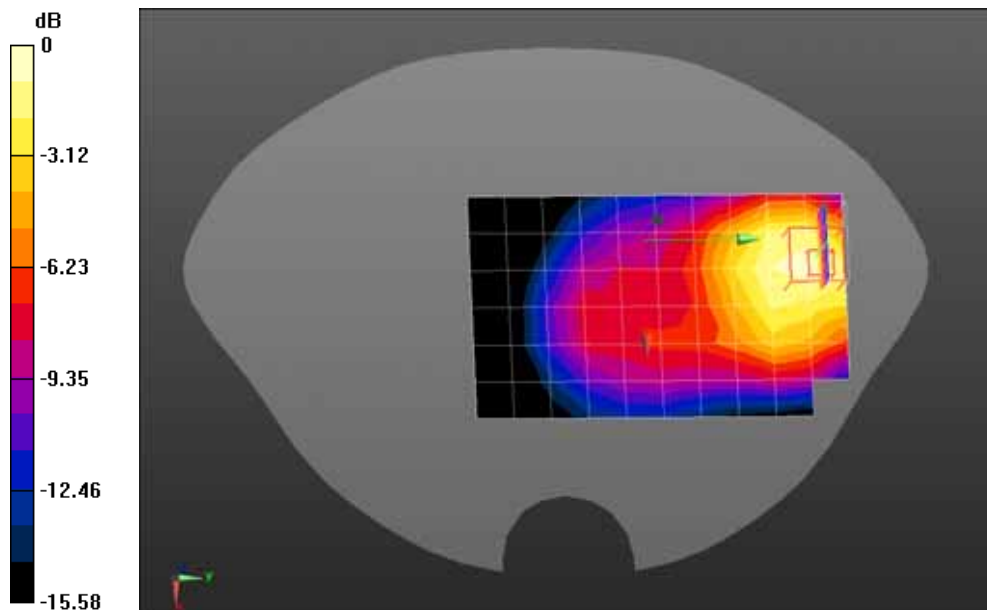

0 dB = 1.06 mW/g = 0.51 dB mW/g

Date/Time: 05-06-2013

Test Laboratory: QuieTek Lab

GPRS1900 Mid Body-Front(3up)

**DUT: Smartphone ; Type: 9788**

Communication System: GPRS/EGPRS-3 Slot; Communication System Band: PCS1900; Duty Cycle: 1:2.8 ;  
 Frequency: 1880 MHz; Medium parameters used:  $f = 1880$  MHz;  $\sigma = 1.51$  mho/m;  $\epsilon_r = 53.01$ ;  $\rho = 1000$  kg/m<sup>3</sup> ; Phantom section: Flat Section

Ambient temperature (°C): 21.5, Liquid temperature (°C): 21.0

DASY5 Configuration:

- Probe: EX3DV4 - SN3710; ConvF(7.6, 7.6, 7.6); Calibrated: 27/03/2013;
- Sensor-Surface: 4mm (Mechanical Surface Detection)
- Electronics: DAE4 Sn1220; Calibrated: 24/01/2013
- Phantom: SAM1; Type: SAM; Serial: TP1561
- Measurement SW: DASY52, Version 52.8 (1); SEMCAD X Version 14.6.5 (6469)

**Configuration/GPRS1900 Mid Body-Front/Area Scan (7x11x1):** Measurement grid: dx=15mm, dy=15mm

Maximum value of SAR (measured) = 0.711 mW/g

**Configuration/GPRS1900 Mid Body-Front/Zoom Scan (5x5x7)/Cube 0:** Measurement grid: dx=8mm, dy=8mm, dz=5mm, Reference Value = 9.068 V/m; Power Drift = -0.01 dB

Peak SAR (extrapolated) = 1.248 mW/g

**SAR(1 g) = 0.709 mW/g; SAR(10 g) = 0.410 mW/g** Maximum value of SAR (measured) = 0.789 mW/g

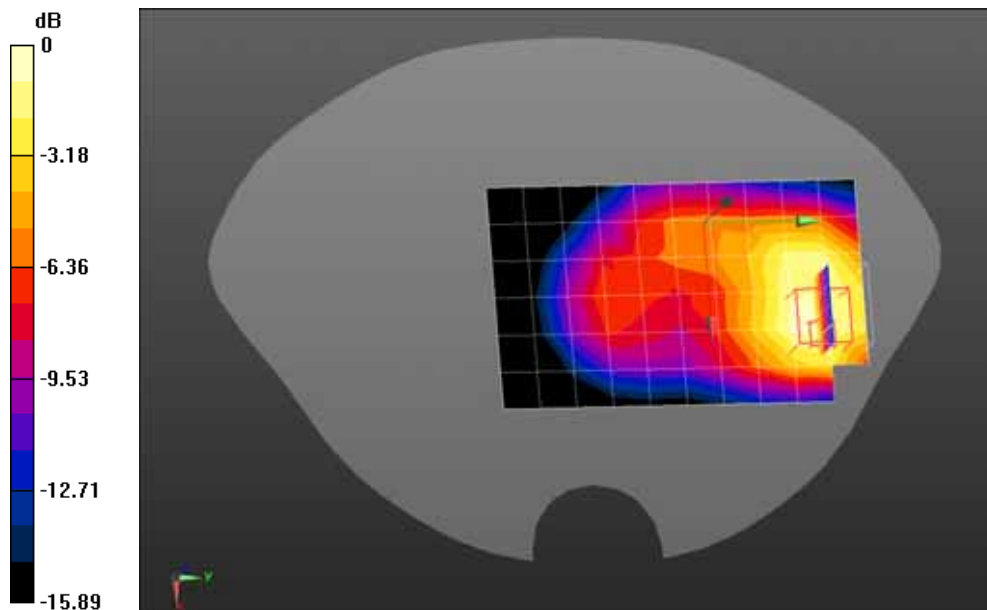

0 dB = 0.789 mW/g = -2.06 dB mW/g

Date/Time: 05-06-2013

Test Laboratory: QuieTek Lab

GPRS1900 Mid Body-Bottom(3up)

**DUT: Smartphone ; Type: 9788**

Communication System: GPRS/EGPRS-3 Slot; Communication System Band: PCS1900; Duty Cycle: 1:2.8 ; Frequency: 1880 MHz; Medium parameters used:  $f = 1880$  MHz;  $\sigma = 1.51$  mho/m;  $\epsilon_r = 53.01$ ;  $\rho = 1000$  kg/m<sup>3</sup> ; Phantom section: Flat Section

Ambient temperature (°C): 21.5, Liquid temperature (°C): 21.0

DASY5 Configuration:

- Probe: EX3DV4 - SN3710; ConvF(7.6, 7.6, 7.6); Calibrated: 27/03/2013;
- Sensor-Surface: 4mm (Mechanical Surface Detection)
- Electronics: DAE4 Sn1220; Calibrated: 24/01/2013
- Phantom: SAM1; Type: SAM; Serial: TP1561
- Measurement SW: DASY52, Version 52.8 (1); SEMCAD X Version 14.6.5 (6469)

**Configuration/GPRS1900 Mid Body-Bottom/Area Scan (7x7x1):** Measurement grid: dx=15mm, dy=15mm, Maximum value of SAR (measured) = 0.673 mW/g

**Configuration/GPRS1900 Mid Body-Bottom/Zoom Scan (5x5x7)/Cube 0:** Measurement grid: dx=8mm, dy=8mm, dz=5mm, Reference Value = 18.745 V/m; Power Drift = 0.04 dB

Peak SAR (extrapolated) = 1.122 mW/g

**SAR(1 g) = 0.673 mW/g; SAR(10 g) = 0.385 mW/g** Maximum value of SAR (measured) = 0.739 mW/g

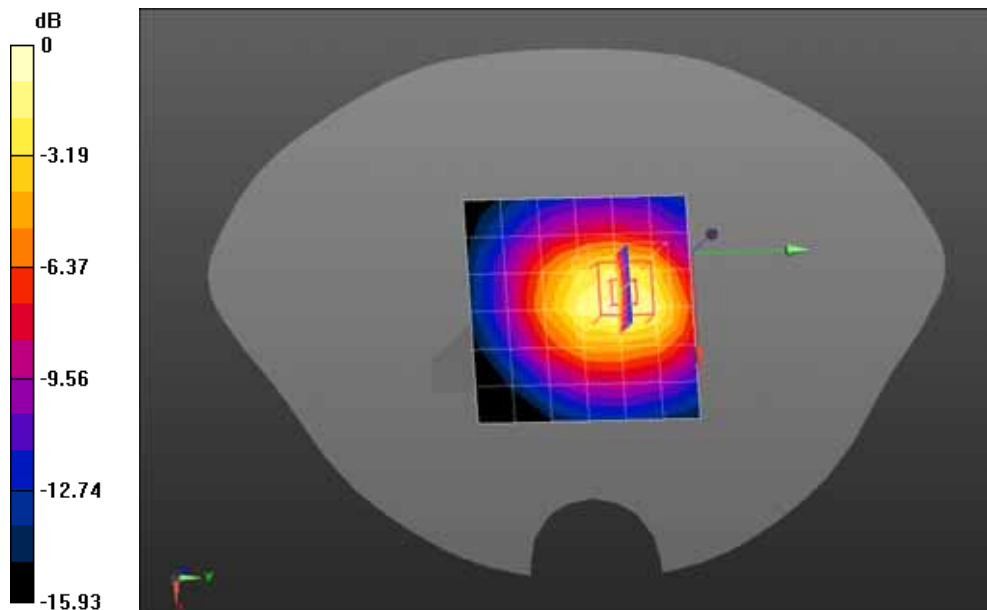

0 dB = 0.739 mW/g = -2.63 dB mW/g

Date/Time: 05-06-2013

Test Laboratory: QuieTek Lab

GPRS1900 Mid Body-Left side(3up)

**DUT: Smartphone ; Type: 9788**

Communication System: GPRS/EGPRS-3 Slot; Communication System Band: PCS1900; Duty Cycle: 1:2.8 ;  
 Frequency: 1880 MHz; Medium parameters used:  $f = 1880$  MHz;  $\sigma = 1.51$  mho/m;  $\epsilon_r = 53.01$ ;  $\rho = 1000$  kg/m<sup>3</sup> ; Phantom section: Flat Section

Ambient temperature (°C): 21.5, Liquid temperature (°C): 21.0

DASY5 Configuration:

- Probe: EX3DV4 - SN3710; ConvF(7.6, 7.6, 7.6); Calibrated: 27/03/2013;
- Sensor-Surface: 4mm (Mechanical Surface Detection)
- Electronics: DAE4 Sn1220; Calibrated: 24/01/2013
- Phantom: SAM1; Type: SAM; Serial: TP1561
- Measurement SW: DASY52, Version 52.8 (1); SEMCAD X Version 14.6.5 (6469)

**Configuration/GPRS1900 Mid Body-Left side/Area Scan (7x11x1):** Measurement grid: dx=15mm, dy=15mm, Maximum value of SAR (measured) = 0.311 mW/g

**Configuration/GPRS1900 Mid Body-Left side/Zoom Scan (5x5x7)/Cube 0:** Measurement grid: dx=8mm, dy=8mm, dz=5mm, Reference Value = 7.300 V/m; Power Drift = -0.11 dB

Peak SAR (extrapolated) = 0.449 mW/g

**SAR(1 g) = 0.274 mW/g; SAR(10 g) = 0.159 mW/g** Maximum value of SAR (measured) = 0.302 mW/g

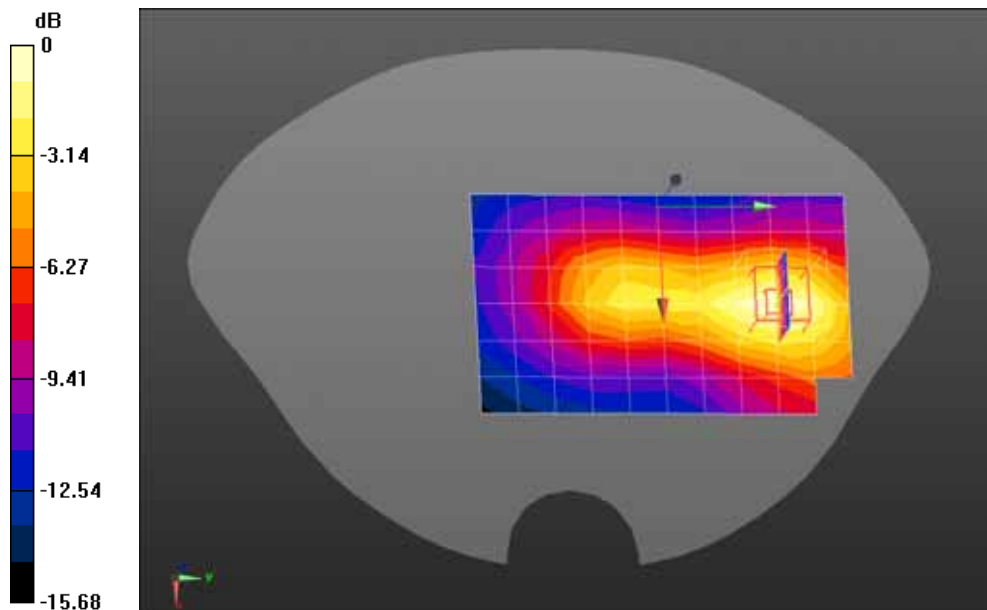

0 dB = 0.302 mW/g = -10.40 dB mW/g

Date/Time: 05-06-2013

Test Laboratory: QuieTek Lab

GPRS1900 Mid Body-Right side(3up)

**DUT: Smartphone ; Type: 9788**

Communication System: GPRS/EGPRS-3 Slot; Communication System Band: PCS1900; Duty Cycle: 1:2.8 ;  
 Frequency: 1880 MHz; Medium parameters used:  $f = 1880$  MHz;  $\sigma = 1.51$  mho/m;  $\epsilon_r = 53.01$ ;  $\rho = 1000$  kg/m<sup>3</sup> ; Phantom section: Flat Section

Ambient temperature (°C): 21.5, Liquid temperature (°C): 21.0

DASY5 Configuration:

- Probe: EX3DV4 - SN3710; ConvF(7.6, 7.6, 7.6); Calibrated: 27/03/2013;
- Sensor-Surface: 4mm (Mechanical Surface Detection)
- Electronics: DAE4 Sn1220; Calibrated: 24/01/2013
- Phantom: SAM1; Type: SAM; Serial: TP1561
- Measurement SW: DASY52, Version 52.8 (1); SEMCAD X Version 14.6.5 (6469)

**Configuration/GPRS1900 Mid Body-Right side/Area Scan (7x11x1):** Measurement grid: dx=15mm, dy=15mm, Maximum value of SAR (measured) = 0.158 mW/g

**Configuration/GPRS1900 Mid Body-Right side/Zoom Scan (5x5x7)/Cube 0:** Measurement grid: dx=8mm, dy=8mm, dz=5mm, Reference Value = 4.250 V/m; Power Drift = 0.06 dB  
 Peak SAR (extrapolated) = 0.247 mW/g

**SAR(1 g) = 0.149 mW/g; SAR(10 g) = 0.091 mW/g** Maximum value of SAR (measured) = 0.161 mW/g

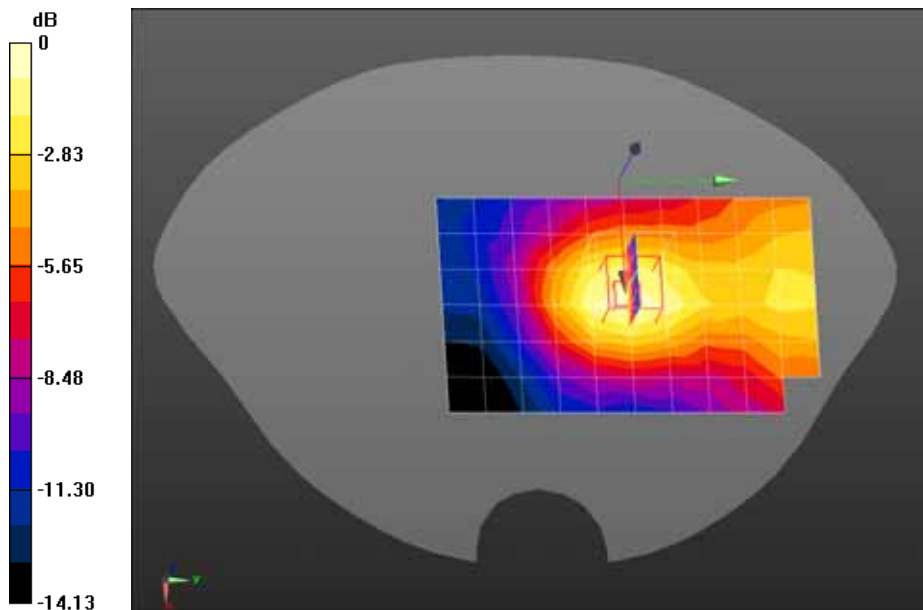

Date/Time: 05-06-2013

Test Laboratory: QuieTek Lab

WCDMA Band II Low Touch-Left

**DUT: Smartphone ; Type: 9788**

Communication System: UMTS; Communication System Band: Band II UTRA/FDD; Duty Cycle: 1:1;

Frequency: 1852.4 MHz; Medium parameters used:  $f = 1852.4$  MHz;  $\sigma = 1.42$  mho/m;  $\epsilon_r = 39.07$ ;  $\rho = 1000$  kg/m<sup>3</sup>; Phantom section: Left Section

Ambient temperature (°C): 21.5, Liquid temperature (°C): 21.0

DASY5 Configuration:

- Probe: EX3DV4 - SN3710; ConvF(7.75, 7.75, 7.75); Calibrated: 27/03/2013;
- Sensor-Surface: 4mm (Mechanical Surface Detection)
- Electronics: DAE4 Sn1220; Calibrated: 24/01/2013
- Phantom: SAM1; Type: SAM; Serial: TP1561
- Measurement SW: DASY52, Version 52.8 (1); SEMCAD X Version 14.6.5 (6469)

**Configuration/WCDMA Band II Low Touch-Left/Area Scan (7x11x1):** Measurement grid: dx=15mm, dy=15mm, Maximum value of SAR (measured) = 1.14 mW/g

**Configuration/WCDMA Band II Low Touch-Left/Zoom Scan (5x5x7)/Cube 0:** Measurement grid: dx=8mm, dy=8mm, dz=5mm, Reference Value = 9.773 V/m; Power Drift = 0.02 dB  
Peak SAR (extrapolated) = 1.873 mW/g

**SAR(1 g) = 1.06 mW/g; SAR(10 g) = 0.569 mW/g** Maximum value of SAR (measured) = 1.20 mW/g

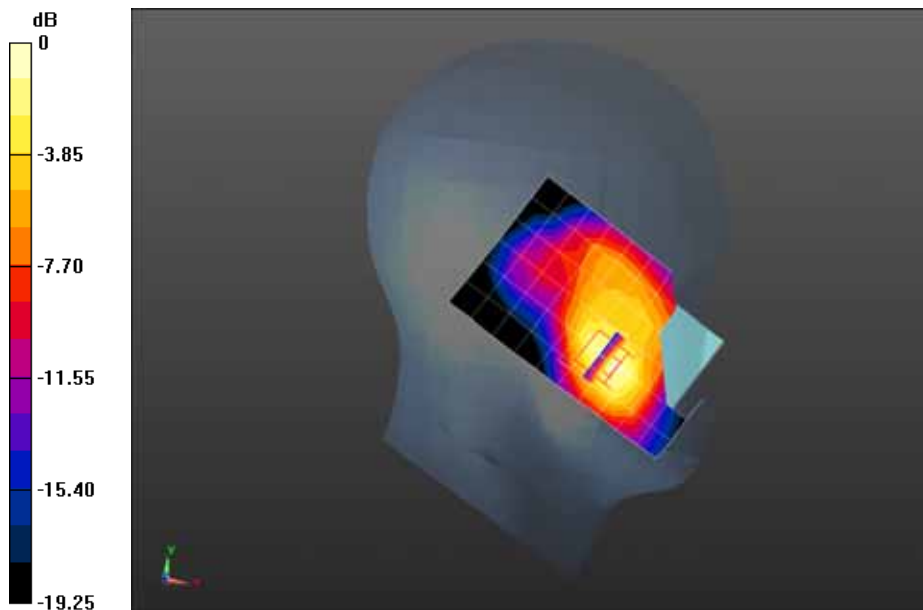

0 dB = 1.20 mW/g = 1.58 dB mW/g



Z-Axis Plot

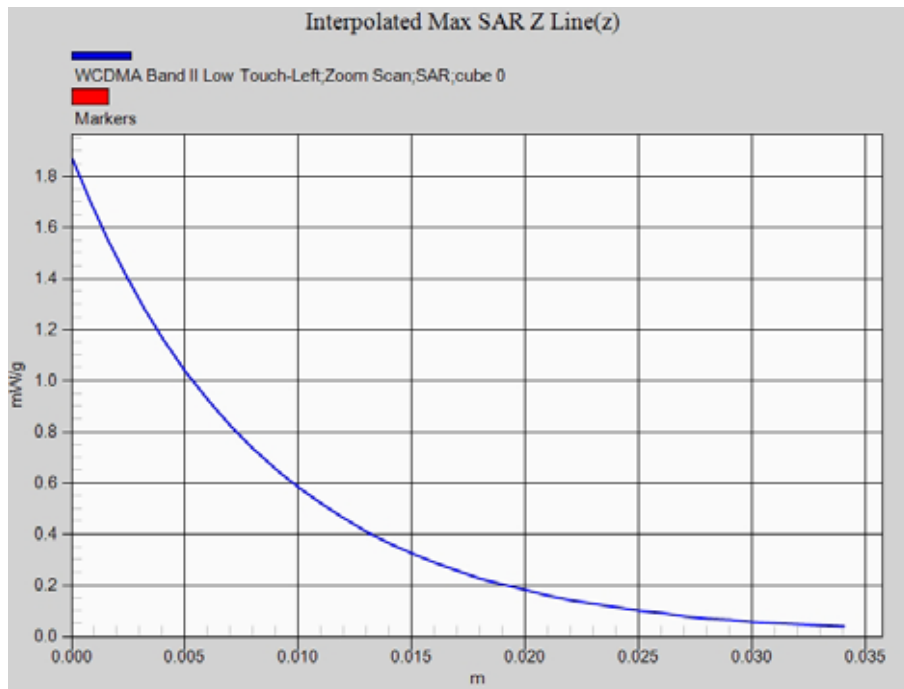

Date/Time: 05-06-2013

Test Laboratory: QuieTek Lab

WCDMA Band II Low Touch-Left-1

**DUT: Smartphone ; Type: 9788**

Communication System: UMTS; Communication System Band: Band II UTRA/FDD; Duty Cycle: 1:1;

Frequency: 1852.4 MHz; Medium parameters used:  $f = 1852.4$  MHz;  $\sigma = 1.42$  mho/m;  $\epsilon_r = 39.07$ ;  $\rho = 1000$  kg/m<sup>3</sup> ; Phantom section: Left Section

Ambient temperature (°C): 21.5, Liquid temperature (°C): 21.0

DASY5 Configuration:

- Probe: EX3DV4 - SN3710; ConvF(7.75, 7.75, 7.75); Calibrated: 27/03/2013;
- Sensor-Surface: 4mm (Mechanical Surface Detection)
- Electronics: DAE4 Sn1220; Calibrated: 24/01/2013
- Phantom: SAM1; Type: SAM; Serial: TP1561
- Measurement SW: DASY52, Version 52.8 (1); SEMCAD X Version 14.6.5 (6469)

**Configuration/WCDMA Band II Low Touch-Left/Area Scan (7x11x1):** Measurement grid: dx=15mm, dy=15mm, Maximum value of SAR (measured) = 1.00 mW/g

**Configuration/WCDMA Band II Low Touch-Left/Zoom Scan (5x5x7)/Cube 0:** Measurement grid: dx=8mm, dy=8mm, dz=5mm, Reference Value = 8.422 V/m; Power Drift = -0.09 dB  
Peak SAR (extrapolated) = 1.646 mW/g

**SAR(1 g) = 0.951 mW/g; SAR(10 g) = 0.520 mW/g** Maximum value of SAR (measured) = 1.07 mW/g

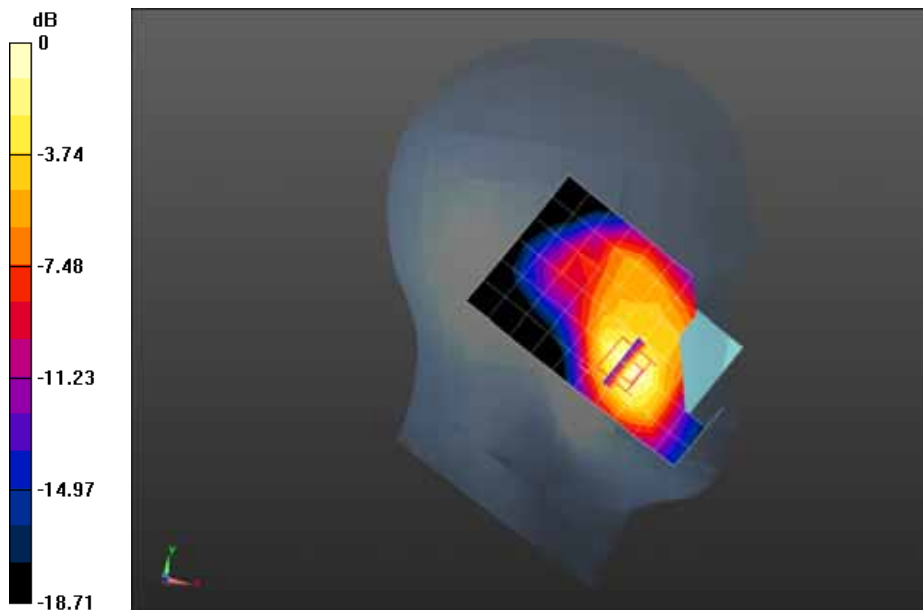

0 dB = 1.07 mW/g = 0.59 dB mW/g

Date/Time: 05-06-2013

Test Laboratory: QuieTek Lab

WCDMA Band II Mid Touch-Left

**DUT: Smartphone ; Type: 9788**

Communication System: UMTS; Communication System Band: Band II UTRA/FDD; Duty Cycle: 1:1;

Frequency: 1880 MHz; Medium parameters used:  $f = 1880$  MHz;  $\sigma = 1.44$  mho/m;  $\epsilon_r = 39$ ;  $\rho = 1000$  kg/m<sup>3</sup> ;

Phantom section: Left Section

Ambient temperature (°C): 21.5, Liquid temperature (°C): 21.0

DASY5 Configuration:

- Probe: EX3DV4 - SN3710; ConvF(7.75, 7.75, 7.75); Calibrated: 27/03/2013;
- Sensor-Surface: 4mm (Mechanical Surface Detection)
- Electronics: DAE4 Sn1220; Calibrated: 24/01/2013
- Phantom: SAM1; Type: SAM; Serial: TP1561
- Measurement SW: DASY52, Version 52.8 (1); SEMCAD X Version 14.6.5 (6469)

**Configuration/WCDMA Band II Mid Touch-Left/Area Scan (7x11x1):** Measurement grid: dx=15mm, dy=15mm, Maximum value of SAR (measured) = 1.12 mW/g

**Configuration/WCDMA Band II Mid Touch-Left/Zoom Scan (5x5x7)/Cube 0:** Measurement grid: dx=8mm, dy=8mm, dz=5mm, Reference Value = 9.818 V/m; Power Drift = -0.02 dB  
Peak SAR (extrapolated) = 1.861 mW/g

**SAR(1 g) = 1.04 mW/g; SAR(10 g) = 0.555 mW/g** Maximum value of SAR (measured) = 1.17 mW/g

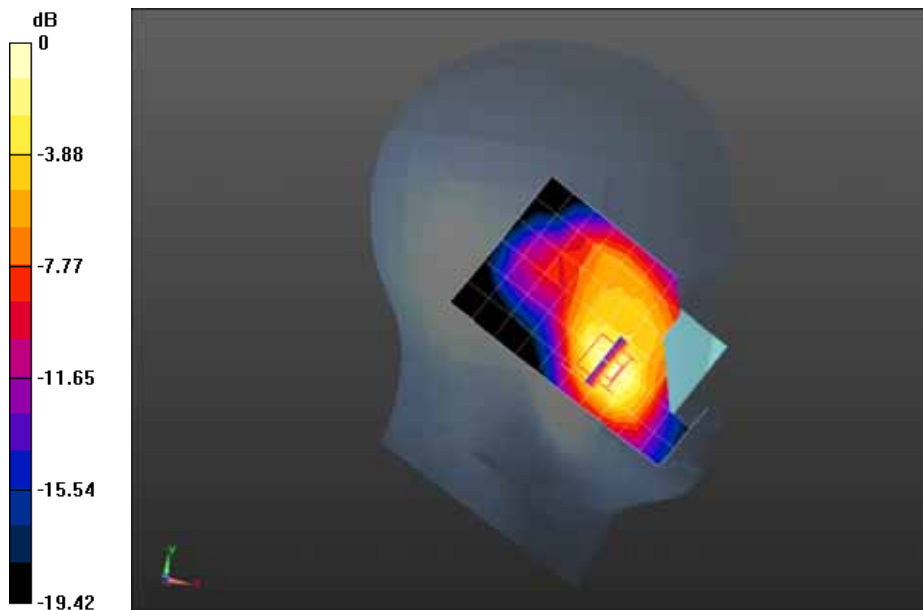

0 dB = 1.17 mW/g = 1.36 dB mW/g

Date/Time: 05-06-2013

Test Laboratory: QuieTek Lab

WCDMA Band II High Touch-Left

**DUT: Smartphone ; Type: 9788**

Communication System: UMTS; Communication System Band: Band II UTRA/FDD; Duty Cycle: 1:1;

Frequency: 1907.6 MHz; Medium parameters used:  $f = 1907.6$  MHz;  $\sigma = 1.45$  mho/m;  $\epsilon_r = 38.86$ ;  $\rho = 1000$  kg/m<sup>3</sup> ; Phantom section: Left Section

Ambient temperature (°C): 21.5, Liquid temperature (°C): 21.0

DASY5 Configuration:

- Probe: EX3DV4 - SN3710; ConvF(7.75, 7.75, 7.75); Calibrated: 27/03/2013;
- Sensor-Surface: 4mm (Mechanical Surface Detection)
- Electronics: DAE4 Sn1220; Calibrated: 24/01/2013
- Phantom: SAM1; Type: SAM; Serial: TP1561
- Measurement SW: DASY52, Version 52.8 (1); SEMCAD X Version 14.6.5 (6469)

**Configuration/WCDMA Band II High Touch-Left/Area Scan (7x11x1):** Measurement grid: dx=15mm, dy=15mm, Maximum value of SAR (measured) = 0.977 mW/g

**Configuration/WCDMA Band II High Touch-Left/Zoom Scan (5x5x7)/Cube 0:** Measurement grid: dx=8mm, dy=8mm, dz=5mm, Reference Value = 9.659 V/m; Power Drift = 0.06 dB  
Peak SAR (extrapolated) = 1.665 mW/g

**SAR(1 g) = 0.924 mW/g; SAR(10 g) = 0.491 mW/g** Maximum value of SAR (measured) = 1.04 mW/g

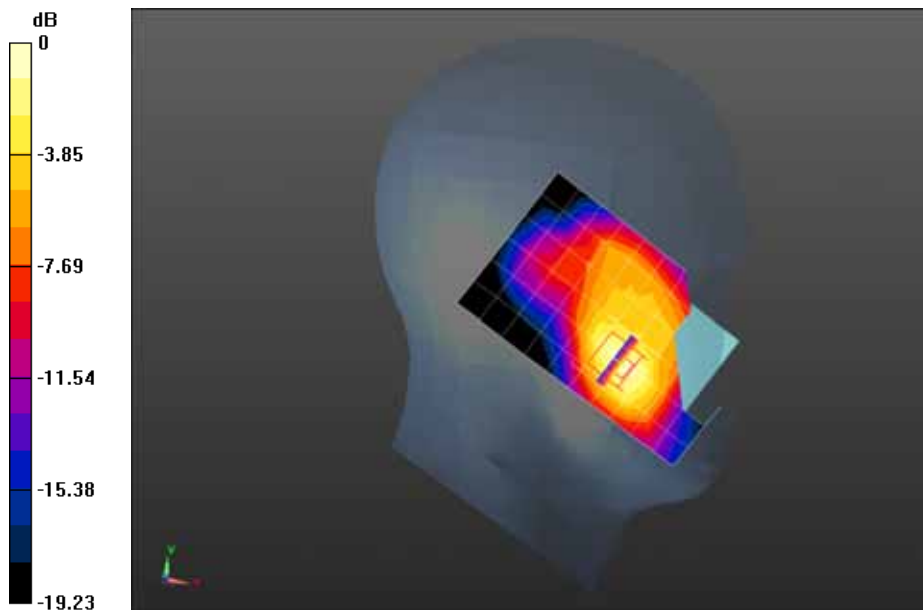

0 dB = 1.04 mW/g = 0.34 dB mW/g

Date/Time: 05-06-2013

Test Laboratory: QuieTek Lab

WCDMA Band II Mid Tilt-Left

**DUT: Smartphone ; Type: 9788**

Communication System: UMTS; Communication System Band: Band II UTRA/FDD; Duty Cycle: 1:1;

Frequency: 1880 MHz; Medium parameters used:  $f = 1880$  MHz;  $\sigma = 1.44$  mho/m;  $\epsilon_r = 39$ ;  $\rho = 1000$  kg/m<sup>3</sup> ;

Phantom section: Left Section

Ambient temperature (°C): 21.5, Liquid temperature (°C): 21.0

DASY5 Configuration:

- Probe: EX3DV4 - SN3710; ConvF(7.75, 7.75, 7.75); Calibrated: 27/03/2013;
- Sensor-Surface: 4mm (Mechanical Surface Detection)
- Electronics: DAE4 Sn1220; Calibrated: 24/01/2013
- Phantom: SAM1; Type: SAM; Serial: TP1561
- Measurement SW: DASY52, Version 52.8 (1); SEMCAD X Version 14.6.5 (6469)

**Configuration/WCDMA Band II Mid Tilt-Left/Area Scan (7x11x1):** Measurement grid: dx=15mm, dy=15mm, Maximum value of SAR (measured) = 0.243 mW/g

**Configuration/WCDMA Band II Mid Tilt-Left/Zoom Scan (5x5x7)/Cube 0:** Measurement grid: dx=8mm, dy=8mm, dz=5mm, Reference Value = 14.068 V/m; Power Drift = -0.01 dB

Peak SAR (extrapolated) = 0.425 mW/g

**SAR(1 g) = 0.255 mW/g; SAR(10 g) = 0.146 mW/g** Maximum value of SAR (measured) = 0.280 mW/g

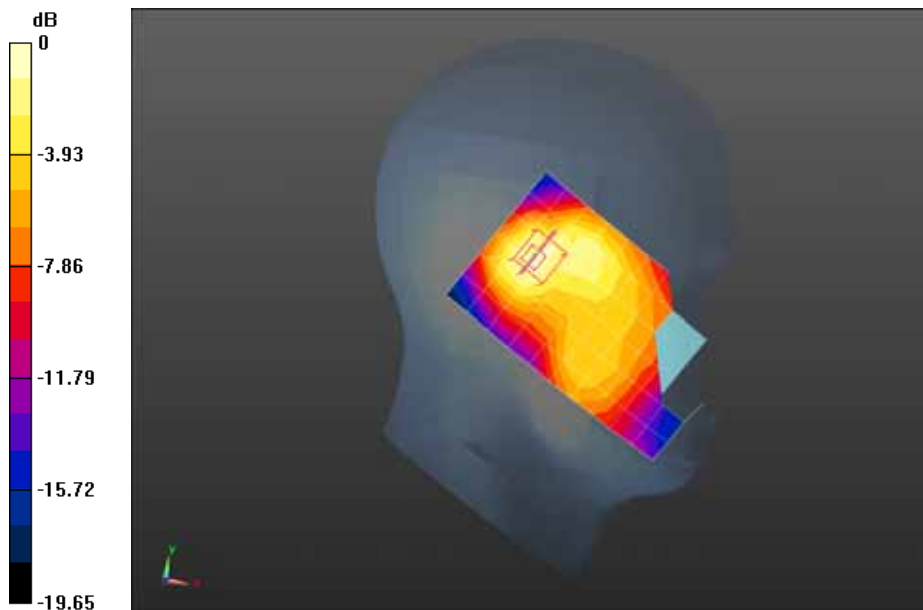

0 dB = 0.280 mW/g = -11.06 dB mW/g

Date/Time: 05-06-2013

Test Laboratory: QuieTek Lab

WCDMA Band II Mid Touch-Right

**DUT: Smartphone ; Type: 9788**

Communication System: UMTS; Communication System Band: Band II UTRA/FDD; Duty Cycle: 1:1;

Frequency: 1880 MHz; Medium parameters used:  $f = 1880$  MHz;  $\sigma = 1.44$  mho/m;  $\epsilon_r = 39$ ;  $\rho = 1000$  kg/m<sup>3</sup> ;

Phantom section: Right Section

Ambient temperature (°C): 21.5, Liquid temperature (°C): 21.0

DASY5 Configuration:

- Probe: EX3DV4 - SN3710; ConvF(7.75, 7.75, 7.75); Calibrated: 27/03/2013;
- Sensor-Surface: 4mm (Mechanical Surface Detection)
- Electronics: DAE4 Sn1220; Calibrated: 24/01/2013
- Phantom: SAM1; Type: SAM; Serial: TP1561
- Measurement SW: DASY52, Version 52.8 (1); SEMCAD X Version 14.6.5 (6469)

**Configuration/WCDMA Band II Mid Touch-Right/Area Scan (7x11x1):** Measurement grid: dx=15mm, dy=15mm, Maximum value of SAR (measured) = 0.716 mW/g

**Configuration/WCDMA Band II Mid Touch-Right/Zoom Scan (5x5x7)/Cube 0:** Measurement grid: dx=8mm, dy=8mm, dz=5mm, Reference Value = 8.214 V/m; Power Drift = 0.11 dB  
Peak SAR (extrapolated) = 1.244 mW/g

**SAR(1 g) = 0.752 mW/g; SAR(10 g) = 0.433 mW/g** Maximum value of SAR (measured) = 0.827 mW/g

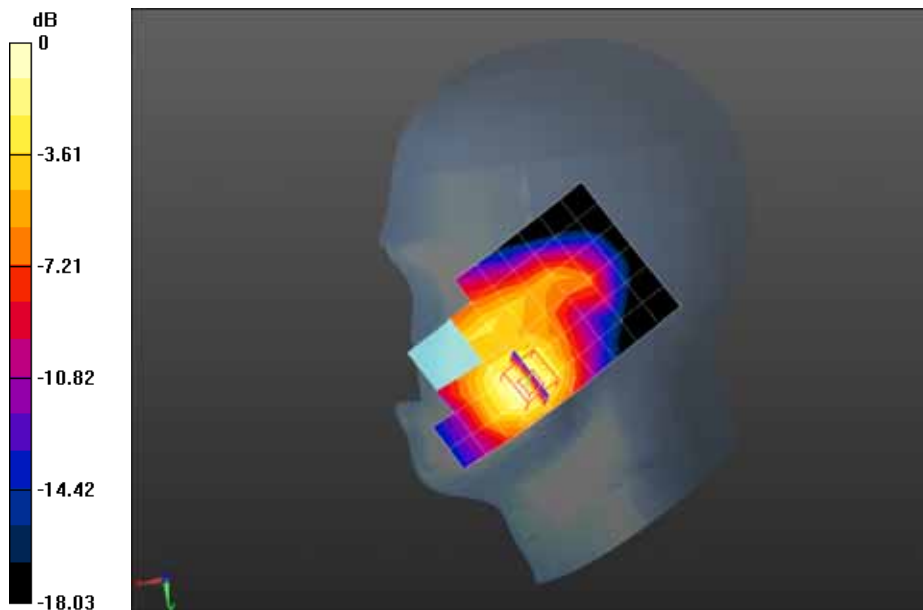

0 dB = 0.827 mW/g = -1.65 dB mW/g

Date/Time: 05-06-2013

Test Laboratory: QuieTek Lab

WCDMA Band II Mid Tilt-Right

**DUT: Smartphone ; Type: 9788**

Communication System: UMTS; Communication System Band: Band II UTRA/FDD; Duty Cycle: 1:1;

Frequency: 1880 MHz; Medium parameters used:  $f = 1880$  MHz;  $\sigma = 1.44$  mho/m;  $\epsilon_r = 39$ ;  $\rho = 1000$  kg/m<sup>3</sup> ;

Phantom section: Right Section

Ambient temperature (°C): 21.5, Liquid temperature (°C): 21.0

DASY5 Configuration:

- Probe: EX3DV4 - SN3710; ConvF(7.75, 7.75, 7.75); Calibrated: 27/03/2013;
- Sensor-Surface: 4mm (Mechanical Surface Detection)
- Electronics: DAE4 Sn1220; Calibrated: 24/01/2013
- Phantom: SAM1; Type: SAM; Serial: TP1561
- Measurement SW: DASY52, Version 52.8 (1); SEMCAD X Version 14.6.5 (6469)

**Configuration/WCDMA Band II Mid Tilt-Right/Area Scan (7x11x1):** Measurement grid: dx=15mm, dy=15mm, Maximum value of SAR (measured) = 0.291 mW/g

**Configuration/WCDMA Band II Mid Tilt-Right/Zoom Scan (5x5x7)/Cube 0:** Measurement grid: dx=8mm, dy=8mm, dz=5mm, Reference Value = 13.836 V/m; Power Drift = -0.06 dB

Peak SAR (extrapolated) = 0.491 mW/g

**SAR(1 g) = 0.285 mW/g; SAR(10 g) = 0.156 mW/g** Maximum value of SAR (measured) = 0.315 mW/g

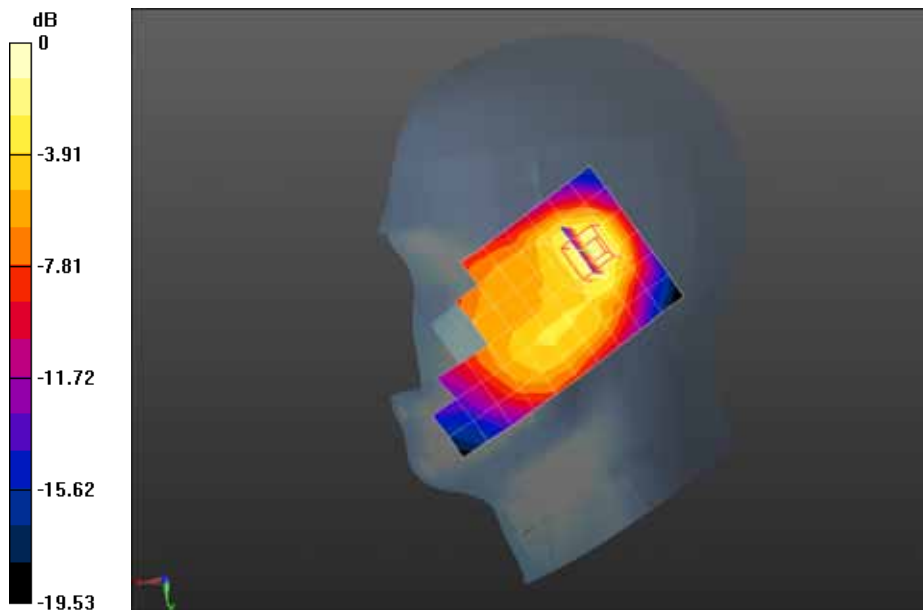

0 dB = 0.315 mW/g = -10.03 dB mW/g

Date/Time: 05-06-2013

Test Laboratory: QuieTek Lab

WCDMA Band II Low Body-Back

**DUT: Smartphone ; Type: 9788**

Communication System: UMTS; Communication System Band: Band II UTRA/FDD; Duty Cycle: 1:1;

Frequency: 1852.4 MHz; Medium parameters used:  $f = 1852.4$  MHz;  $\sigma = 1.47$  mho/m;  $\epsilon_r = 53.14$ ;  $\rho = 1000$  kg/m<sup>3</sup>; Phantom section: Flat Section

Ambient temperature (°C): 21.5, Liquid temperature (°C): 21.0

DASY5 Configuration:

- Probe: EX3DV4 - SN3710; ConvF(7.6, 7.6, 7.6); Calibrated: 27/03/2013;
- Sensor-Surface: 4mm (Mechanical Surface Detection)
- Electronics: DAE4 Sn1220; Calibrated: 24/01/2013
- Phantom: SAM1; Type: SAM; Serial: TP1561
- Measurement SW: DASY52, Version 52.8 (1); SEMCAD X Version 14.6.5 (6469)

**Configuration/WCDMA Band II Low Body-Back/Area Scan (7x11x1):** Measurement grid: dx=15mm, dy=15mm, Maximum value of SAR (measured) = 0.808 mW/g

**Configuration/WCDMA Band II Low Body-Back/Zoom Scan (5x5x7)/Cube 0:** Measurement grid: dx=8mm, dy=8mm, dz=5mm, Reference Value = 9.980 V/m; Power Drift = -0.01 dB  
Peak SAR (extrapolated) = 1.353 mW/g

**SAR(1 g) = 0.795 mW/g; SAR(10 g) = 0.452 mW/g** Maximum value of SAR (measured) = 0.906 mW/g

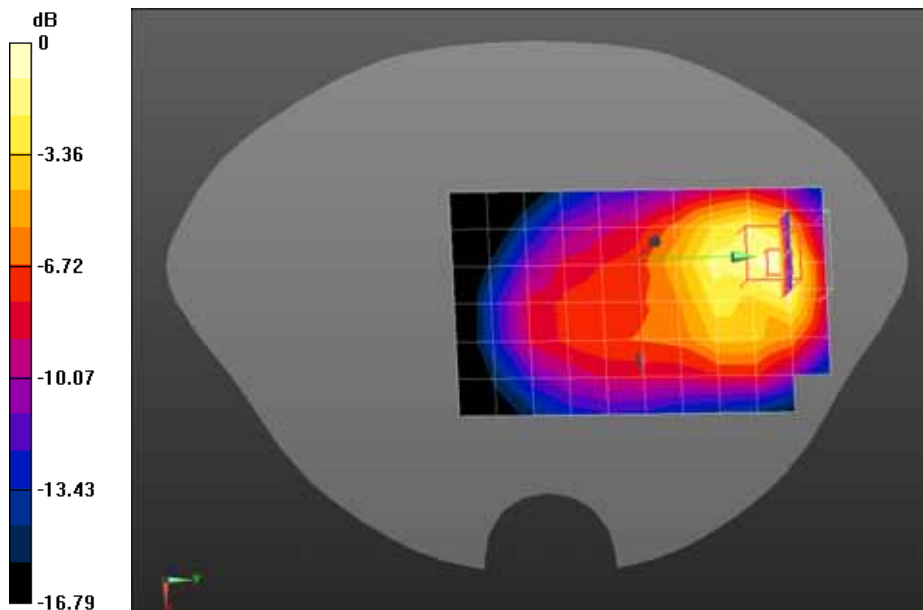

0 dB = 0.906 mW/g = -0.86 dB mW/g



Date/Time: 05-06-2013

Test Laboratory: QuieTek Lab

WCDMA Band II Mid Body-Back

**DUT: Smartphone ; Type: 9788**

Communication System: UMTS; Communication System Band: Band II UTRA/FDD; Duty Cycle: 1:1; Frequency: 1880 MHz; Medium parameters used:  $f = 1880$  MHz;  $\sigma = 1.51$  mho/m;  $\epsilon_r = 53.01$ ;  $\rho = 1000$  kg/m<sup>3</sup>; Phantom section: Flat Section

Ambient temperature (°C): 21.5, Liquid temperature (°C): 21.0

DASY5 Configuration:

- Probe: EX3DV4 - SN3710; ConvF(7.6, 7.6, 7.6); Calibrated: 27/03/2013;
- Sensor-Surface: 4mm (Mechanical Surface Detection)
- Electronics: DAE4 Sn1220; Calibrated: 24/01/2013
- Phantom: SAM1; Type: SAM; Serial: TP1561
- Measurement SW: DASY52, Version 52.8 (1); SEMCAD X Version 14.6.5 (6469)

**Configuration/WCDMA Band II Mid Body-Back/Area Scan (7x11x1):** Measurement grid: dx=15mm, dy=15mm, Maximum value of SAR (measured) = 0.852 mW/g

**Configuration/WCDMA Band II Mid Body-Back/Zoom Scan (5x5x7)/Cube 0:** Measurement grid: dx=8mm, dy=8mm, dz=5mm, Reference Value = 10.477 V/m; Power Drift = -0.03 dB  
Peak SAR (extrapolated) = 1.475 mW/g

**SAR(1 g) = 0.865 mW/g; SAR(10 g) = 0.495 mW/g** Maximum value of SAR (measured) = 0.985 mW/g

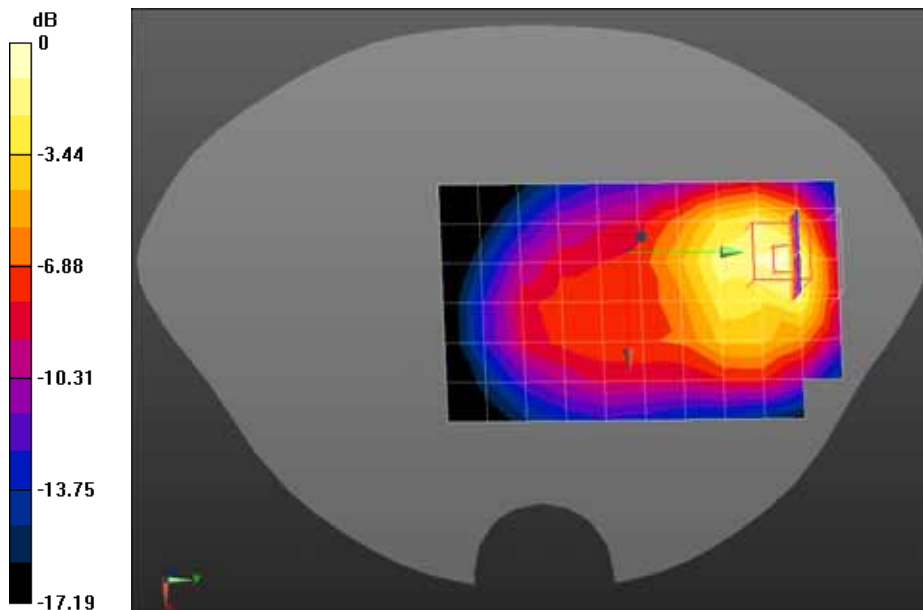

0 dB = 0.985 mW/g = -0.13 dB mW/g

Date/Time: 05-06-2013

Test Laboratory: QuieTek Lab

WCDMA Band II Mid Body-Back-1

**DUT: Smartphone ; Type: 9788**

Communication System: UMTS; Communication System Band: Band II UTRA/FDD; Duty Cycle: 1:1;  
 Frequency: 1880 MHz; Medium parameters used:  $f = 1880$  MHz;  $\sigma = 1.51$  mho/m;  $\epsilon_r = 53.01$ ;  $\rho = 1000$  kg/m<sup>3</sup> ; Phantom section: Flat Section

Ambient temperature (°C): 21.5, Liquid temperature (°C): 21.0

DASY5 Configuration:

- Probe: EX3DV4 - SN3710; ConvF(7.6, 7.6, 7.6); Calibrated: 27/03/2013;
- Sensor-Surface: 4mm (Mechanical Surface Detection)
- Electronics: DAE4 Sn1220; Calibrated: 24/01/2013
- Phantom: SAM1; Type: SAM; Serial: TP1561
- Measurement SW: DASY52, Version 52.8 (1); SEMCAD X Version 14.6.5 (6469)

**Configuration/WCDMA Band II Mid Body-Back/Area Scan (7x11x1):** Measurement grid: dx=15mm, dy=15mm, Maximum value of SAR (measured) = 0.843 mW/g

**Configuration/WCDMA Band II Mid Body-Back/Zoom Scan (5x5x7)/Cube 0:** Measurement grid: dx=8mm, dy=8mm, dz=5mm, Reference Value = 8.922 V/m; Power Drift = -0.03 dB  
 Peak SAR (extrapolated) = 1.397 mW/g

**SAR(1 g) = 0.863 mW/g; SAR(10 g) = 0.508 mW/g** Maximum value of SAR (measured) = 0.935 mW/g

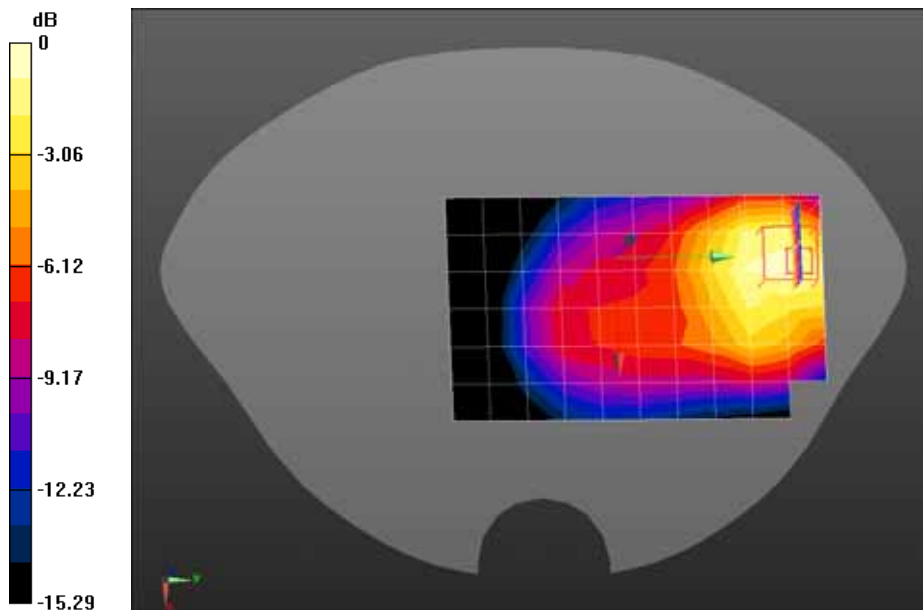

0 dB = 0.935 mW/g = -0.58 dB mW/g

Date/Time: 05-06-2013

Test Laboratory: QuieTek Lab

WCDMA Band II High Body-Back

**DUT: Smartphone ; Type: 9788**

Communication System: UMTS; Communication System Band: Band II UTRA/FDD; Duty Cycle: 1:1; Frequency: 1907.6 MHz; Medium parameters used (interpolated):  $f = 1907.6$  MHz;  $\sigma = 1.53$  mho/m;  $\epsilon_r = 52.96$ ;  $\rho = 1000$  kg/m<sup>3</sup> ; Phantom section: Flat Section

Ambient temperature (°C): 21.5, Liquid temperature (°C): 21.0

DASY5 Configuration:

- Probe: EX3DV4 - SN3710; ConvF(7.6, 7.6, 7.6); Calibrated: 27/03/2013;
- Sensor-Surface: 4mm (Mechanical Surface Detection)
- Electronics: DAE4 Sn1220; Calibrated: 24/01/2013
- Phantom: SAM1; Type: SAM; Serial: TP1561
- Measurement SW: DASY52, Version 52.8 (1); SEMCAD X Version 14.6.5 (6469)

**Configuration/WCDMA Band II High Body-Back/Area Scan (7x11x1):** Measurement grid: dx=15mm, dy=15mm, Maximum value of SAR (measured) = 0.796 mW/g

**Configuration/WCDMA Band II High Body-Back/Zoom Scan (5x5x7)/Cube 0:** Measurement grid: dx=8mm, dy=8mm, dz=5mm, Reference Value = 9.797 V/m; Power Drift = -0.02 dB  
Peak SAR (extrapolated) = 1.405 mW/g

**SAR(1 g) = 0.822 mW/g; SAR(10 g) = 0.469 mW/g** Maximum value of SAR (measured) = 0.932 mW/g

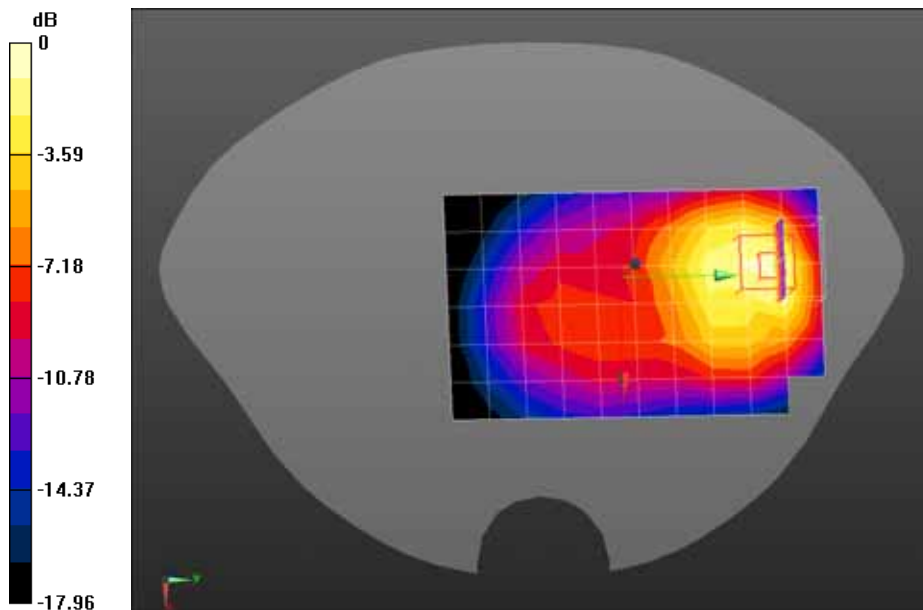

0 dB = 0.932 mW/g = -0.61 dB mW/g

Date/Time: 05-06-2013

Test Laboratory: QuieTek Lab

WCDMA Band II Mid Body-Front

**DUT: Smartphone ; Type: 9788**

Communication System: UMTS; Communication System Band: Band II UTRA/FDD; Duty Cycle: 1:1; Frequency: 1880 MHz; Medium parameters used:  $f = 1880$  MHz;  $\sigma = 1.51$  mho/m;  $\epsilon_r = 53.01$ ;  $\rho = 1000$  kg/m<sup>3</sup>; Phantom section: Flat Section

Ambient temperature (°C): 21.5, Liquid temperature (°C): 21.0

DASY5 Configuration:

- Probe: EX3DV4 - SN3710; ConvF(7.6, 7.6, 7.6); Calibrated: 27/03/2013;
- Sensor-Surface: 4mm (Mechanical Surface Detection)
- Electronics: DAE4 Sn1220; Calibrated: 24/01/2013
- Phantom: SAM1; Type: SAM; Serial: TP1561
- Measurement SW: DASY52, Version 52.8 (1); SEMCAD X Version 14.6.5 (6469)

**Configuration/WCDMA Band II Mid Body-Front/Area Scan (7x11x1):** Measurement grid: dx=15mm, dy=15mm, Maximum value of SAR (measured) = 0.743 mW/g

**Configuration/WCDMA Band II Mid Body-Front/Zoom Scan (5x5x7)/Cube 0:** Measurement grid: dx=8mm, dy=8mm, dz=5mm, Reference Value = 9.177 V/m; Power Drift = -0.03 dB  
Peak SAR (extrapolated) = 1.329 mW/g

**SAR(1 g) = 0.742 mW/g; SAR(10 g) = 0.427 mW/g** Maximum value of SAR (measured) = 0.834 mW/g

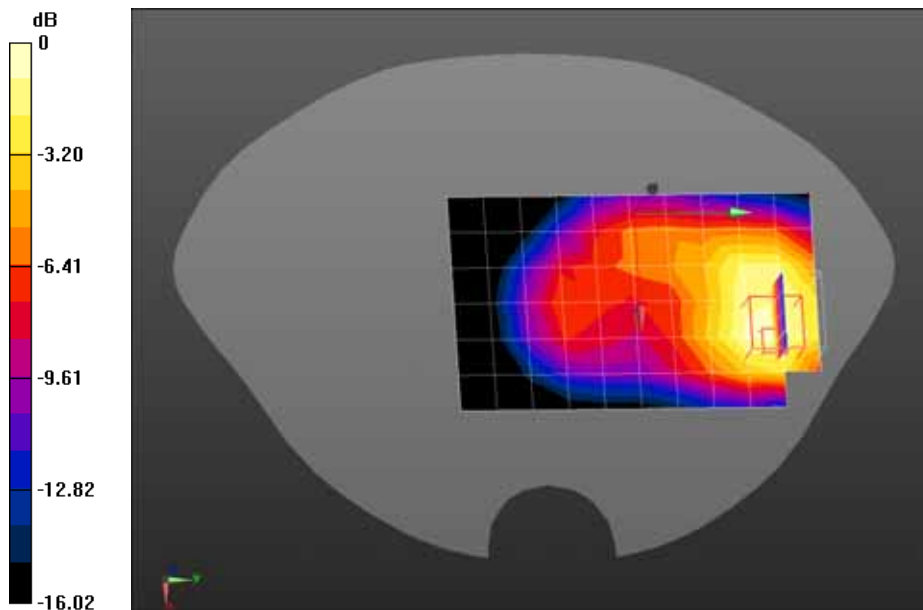

0 dB = 0.834 mW/g = -1.58 dB mW/g

Date/Time: 05-06-2013

Test Laboratory: QuieTek Lab

WCDMA Band II Mid Body-Bottom

**DUT: Smartphone ; Type: 9788**

Communication System: UMTS; Communication System Band: Band II UTRA/FDD; Duty Cycle: 1:1; Frequency: 1880 MHz; Medium parameters used:  $f = 1880$  MHz;  $\sigma = 1.51$  mho/m;  $\epsilon_r = 53.01$ ;  $\rho = 1000$  kg/m<sup>3</sup>; Phantom section: Flat Section

Ambient temperature (°C): 21.5, Liquid temperature (°C): 21.0

DASY5 Configuration:

- Probe: EX3DV4 - SN3710; ConvF(7.6, 7.6, 7.6); Calibrated: 27/03/2013;
- Sensor-Surface: 4mm (Mechanical Surface Detection)
- Electronics: DAE4 Sn1220; Calibrated: 24/01/2013
- Phantom: SAM1; Type: SAM; Serial: TP1561
- Measurement SW: DASY52, Version 52.8 (1); SEMCAD X Version 14.6.5 (6469)

**Configuration/WCDMA Band II Mid Body-Bottom/Area Scan (7x7x1):** Measurement grid: dx=15mm, dy=15mm, Maximum value of SAR (measured) = 0.700 mW/g

**Configuration/WCDMA Band II Mid Body-Bottom/Zoom Scan (5x5x7)/Cube 0:** Measurement grid: dx=8mm, dy=8mm, dz=5mm, Reference Value = 20.321 V/m; Power Drift = 0.03 dB  
Peak SAR (extrapolated) = 1.117 mW/g

**SAR(1 g) = 0.677 mW/g; SAR(10 g) = 0.387 mW/g** Maximum value of SAR (measured) = 0.747 mW/g

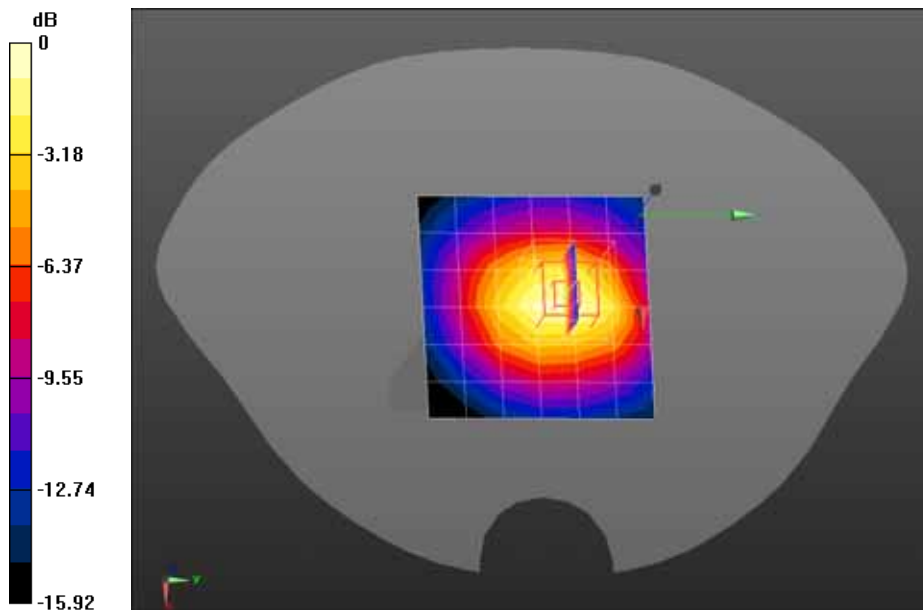

0 dB = 0.747 mW/g = -2.53 dB mW/g

Date/Time: 05-06-2013

Test Laboratory: QuieTek Lab

WCDMA Band II Mid Body-Left side

**DUT: Smartphone ; Type: 9788**

Communication System: UMTS; Communication System Band: Band II UTRA/FDD; Duty Cycle: 1:1; Frequency: 1880 MHz; Medium parameters used:  $f = 1880$  MHz;  $\sigma = 1.51$  mho/m;  $\epsilon_r = 53.01$ ;  $\rho = 1000$  kg/m<sup>3</sup>; Phantom section: Flat Section

Ambient temperature (°C): 21.5, Liquid temperature (°C): 21.0

DASY5 Configuration:

- Probe: EX3DV4 - SN3710; ConvF(7.6, 7.6, 7.6); Calibrated: 27/03/2013;
- Sensor-Surface: 4mm (Mechanical Surface Detection)
- Electronics: DAE4 Sn1220; Calibrated: 24/01/2013
- Phantom: SAM1; Type: SAM; Serial: TP1561
- Measurement SW: DASY52, Version 52.8 (1); SEMCAD X Version 14.6.5 (6469)

**Configuration/WCDMA Band II Mid Body-Left side/Area Scan (7x11x1):** Measurement grid: dx=15mm, dy=15mm, Maximum value of SAR (measured) = 0.306 mW/g

**Configuration/WCDMA Band II Mid Body-Left side/Zoom Scan (5x5x7)/Cube 0:** Measurement grid: dx=8mm, dy=8mm, dz=5mm, Reference Value = 7.362 V/m; Power Drift = -0.08 dB  
Peak SAR (extrapolated) = 0.453 mW/g

**SAR(1 g) = 0.277 mW/g; SAR(10 g) = 0.161 mW/g** Maximum value of SAR (measured) = 0.305 mW/g

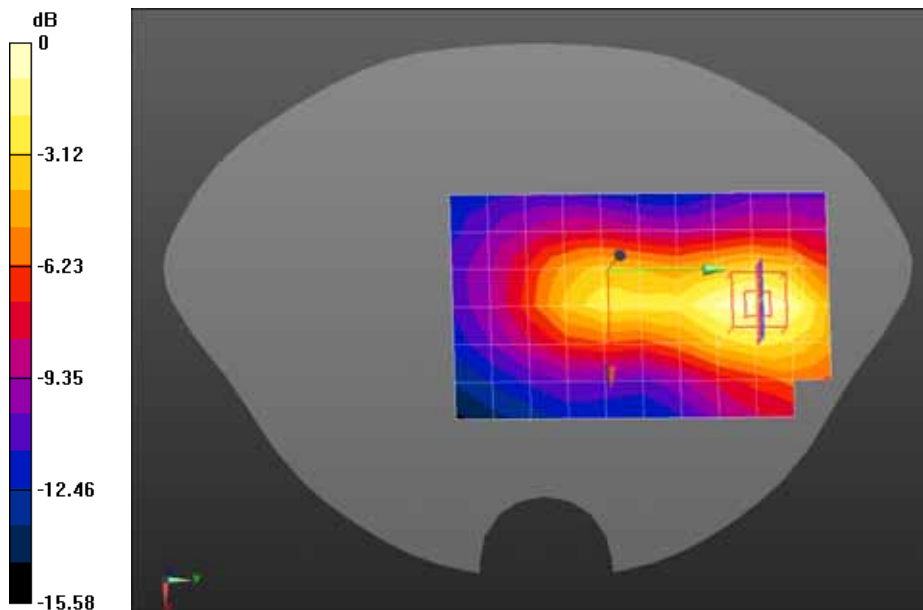

0 dB = 0.305 mW/g = -10.31 dB mW/g

Date/Time: 05-06-2013

Test Laboratory: QuieTek Lab

WCDMA Band II Mid Body-Right side

**DUT: Smartphone ; Type: 9788**

Communication System: UMTS; Communication System Band: Band II UTRA/FDD; Duty Cycle: 1:1; Frequency: 1880 MHz; Medium parameters used:  $f = 1880$  MHz;  $\sigma = 1.51$  mho/m;  $\epsilon_r = 53.01$ ;  $\rho = 1000$  kg/m<sup>3</sup>; Phantom section: Flat Section

Ambient temperature (°C): 21.5, Liquid temperature (°C): 21.0

DASY5 Configuration:

- Probe: EX3DV4 - SN3710; ConvF(7.6, 7.6, 7.6); Calibrated: 27/03/2013;
- Sensor-Surface: 4mm (Mechanical Surface Detection)
- Electronics: DAE4 Sn1220; Calibrated: 24/01/2013
- Phantom: SAM1; Type: SAM; Serial: TP1561
- Measurement SW: DASY52, Version 52.8 (1); SEMCAD X Version 14.6.5 (6469)

**Configuration/WCDMA Band II Mid Body-Right side/Area Scan (7x11x1):** Measurement grid: dx=15mm, dy=15mm, Maximum value of SAR (measured) = 0.169 mW/g

**Configuration/WCDMA Band II Mid Body-Right side/Zoom Scan (5x5x7)/Cube 0:** Measurement grid: dx=8mm, dy=8mm, dz=5mm, Reference Value = 4.338 V/m; Power Drift = 0.08 dB  
Peak SAR (extrapolated) = 0.261 mW/g

**SAR(1 g) = 0.164 mW/g; SAR(10 g) = 0.100 mW/g** Maximum value of SAR (measured) = 0.177 mW/g

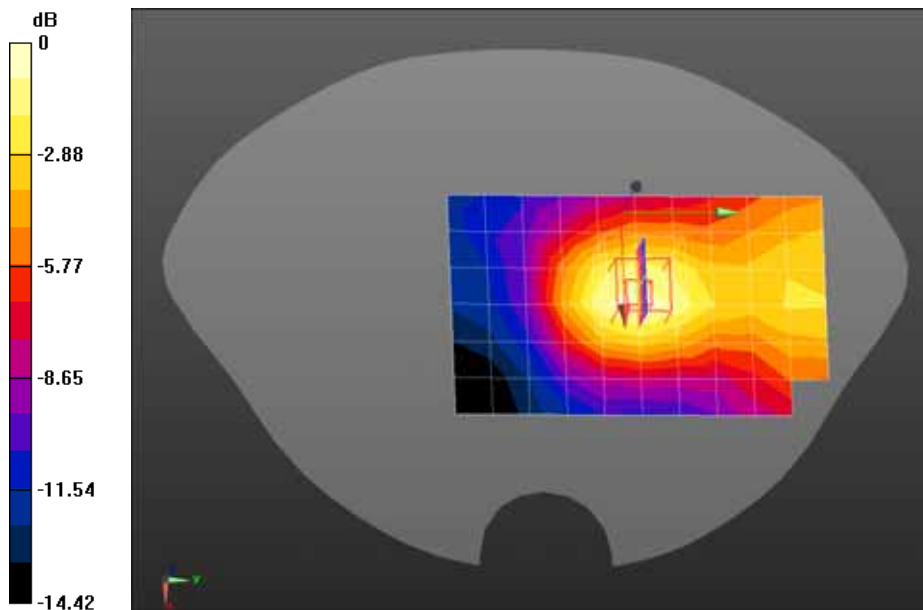

0 dB = 0.177 mW/g = -15.04 dB mW/g

Date/Time: 05-06-2013

Test Laboratory: QuieTek Lab

WCDMA Band IV Low Touch-Left

**DUT: Mobile Phone ; Type: 9788**

Communication System: UMTS; Communication System Band: Band IV UTRA/FDD; Duty Cycle: 1:1;

Frequency: 1712.4 MHz; Medium parameters used:  $f = 1712.4$  MHz;  $\sigma = 1.35$  mho/m;  $\epsilon_r = 39.65$ ;  $\rho = 1000$  kg/m<sup>3</sup> ; Phantom section: Left Section

Ambient temperature (°C): 21.5, Liquid temperature (°C): 21.0

DASY5 Configuration:

- Probe: EX3DV4 - SN3710; ConvF(7.75, 7.75, 7.75); Calibrated: 27/03/2013;
- Sensor-Surface: 4mm (Mechanical Surface Detection)
- Electronics: DAE4 Sn1220; Calibrated: 24/01/2013
- Phantom: SAM1; Type: SAM; Serial: TP1561
- Measurement SW: DASY52, Version 52.8 (1); SEMCAD X Version 14.6.5 (6469)

**Configuration/WCDMA Band IV Low Touch-Left/Area Scan (7x11x1):** Measurement grid: dx=15mm, dy=15mm, Maximum value of SAR (measured) = 0.938 mW/g

**Configuration/WCDMA Band IV Low Touch-Left/Zoom Scan (5x5x7)/Cube 0:** Measurement grid: dx=8mm, dy=8mm, dz=5mm, Reference Value = 7.548 V/m; Power Drift = -0.01 dB  
Peak SAR (extrapolated) = 1.424 mW/g

**SAR(1 g) = 0.880 mW/g; SAR(10 g) = 0.497 mW/g** Maximum value of SAR (measured) = 0.977 mW/g

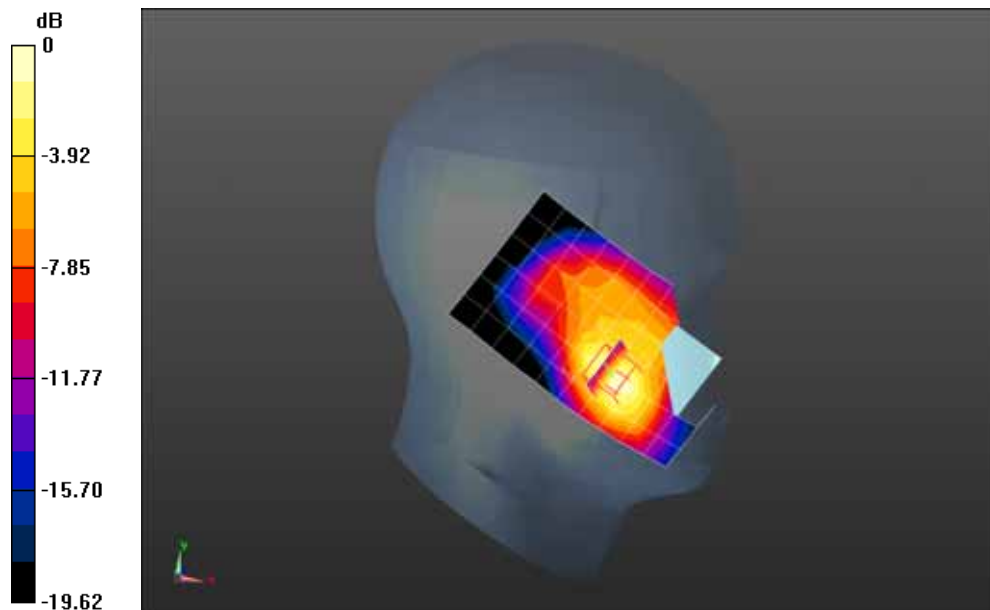

0 dB = 0.977 mW/g = -0.20 dB mW/g



Date/Time: 05-06-2013

Test Laboratory: QuieTek Lab

WCDMA Band IV Mid Touch-Left

**DUT: Mobile Phone ; Type: 9788**

Communication System: UMTS; Communication System Band: Band IV UTRA/FDD; Duty Cycle: 1:1;

Frequency: 1732.6 MHz; Medium parameters used:  $f = 1732.6$  MHz;  $\sigma = 1.36$  mho/m;  $\epsilon_r = 39.58$ ;  $\rho = 1000$  kg/m<sup>3</sup> ; Phantom section: Left Section

Ambient temperature (°C): 21.5, Liquid temperature (°C): 21.0

DASY5 Configuration:

- Probe: EX3DV4 - SN3710; ConvF(7.75, 7.75, 7.75); Calibrated: 27/03/2013;
- Sensor-Surface: 4mm (Mechanical Surface Detection)
- Electronics: DAE4 Sn1220; Calibrated: 24/01/2013
- Phantom: SAM1; Type: SAM; Serial: TP1561
- Measurement SW: DASY52, Version 52.8 (1); SEMCAD X Version 14.6.5 (6469)

**Configuration/WCDMA Band IV Mid Touch-Left/Area Scan (7x11x1):** Measurement grid: dx=15mm, dy=15mm, Maximum value of SAR (measured) = 1.14 mW/g

**Configuration/WCDMA Band IV Mid Touch-Left/Zoom Scan (5x5x7)/Cube 0:** Measurement grid: dx=8mm, dy=8mm, dz=5mm, Reference Value = 8.378 V/m; Power Drift = -0.07 dB  
Peak SAR (extrapolated) = 1.764 mW/g

**SAR(1 g) = 1.07 mW/g; SAR(10 g) = 0.601 mW/g** Maximum value of SAR (measured) = 1.21 mW/g

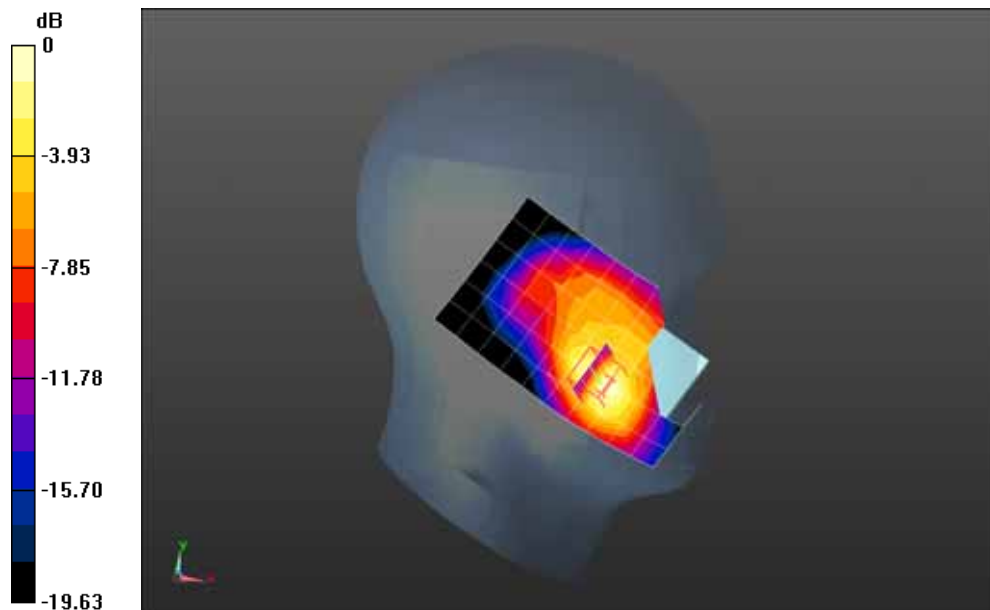

0 dB = 1.21 mW/g = 1.66 dB mW/g

Date/Time: 05-06-2013

Test Laboratory: QuieTek Lab

WCDMA Band IV High Touch-Left

**DUT: Mobile Phone ; Type: 9788**

Communication System: UMTS; Communication System Band: Band IV UTRA/FDD; Duty Cycle: 1:1;

Frequency: 1752.6 MHz; Medium parameters used:  $f = 1752.6$  MHz;  $\sigma = 1.37$  mho/m;  $\epsilon_r = 39.5$ ;  $\rho = 1000$  kg/m<sup>3</sup> ; Phantom section: Left Section

Ambient temperature (°C): 21.5, Liquid temperature (°C): 21.0

DASY5 Configuration:

- Probe: EX3DV4 - SN3710; ConvF(7.75, 7.75, 7.75); Calibrated: 27/03/2013;
- Sensor-Surface: 4mm (Mechanical Surface Detection)
- Electronics: DAE4 Sn1220; Calibrated: 24/01/2013
- Phantom: SAM1; Type: SAM; Serial: TP1561
- Measurement SW: DASY52, Version 52.8 (1); SEMCAD X Version 14.6.5 (6469)

**Configuration/WCDMA Band IV High Touch-Left/Area Scan (7x11x1):** Measurement grid: dx=15mm, dy=15mm, Maximum value of SAR (measured) = 1.14 mW/g

**Configuration/WCDMA Band IV High Touch-Left/Zoom Scan (5x5x7)/Cube 0:** Measurement grid: dx=8mm, dy=8mm, dz=5mm, Reference Value = 7.846 V/m; Power Drift = -0.10 dB  
Peak SAR (extrapolated) = 1.861 mW/g

**SAR(1 g) = 1.11 mW/g; SAR(10 g) = 0.617 mW/g** Maximum value of SAR (measured) = 1.25 mW/g

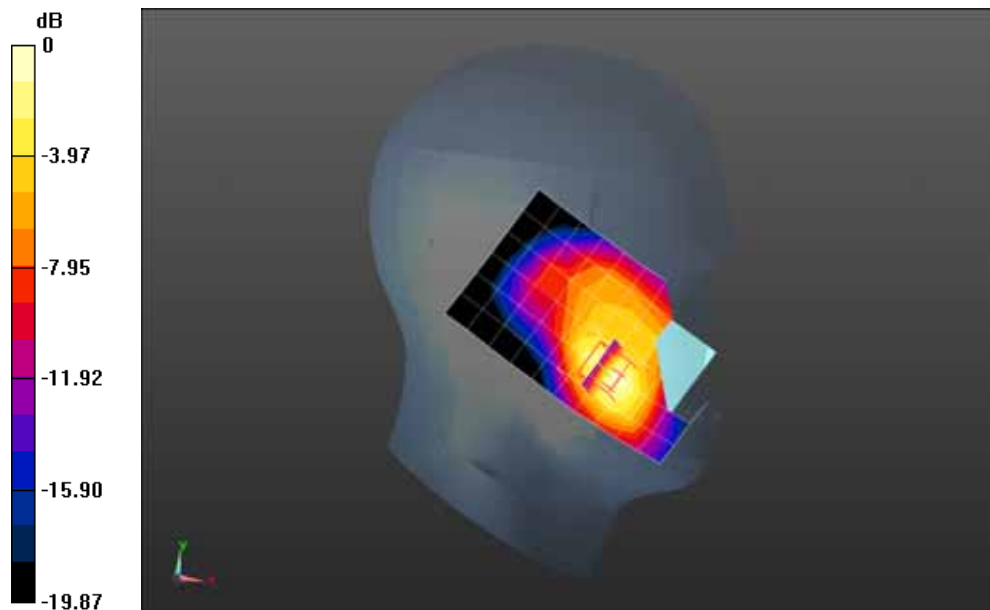

0 dB = 1.25 mW/g = 1.94 dB mW/g

Z-Axis Plot

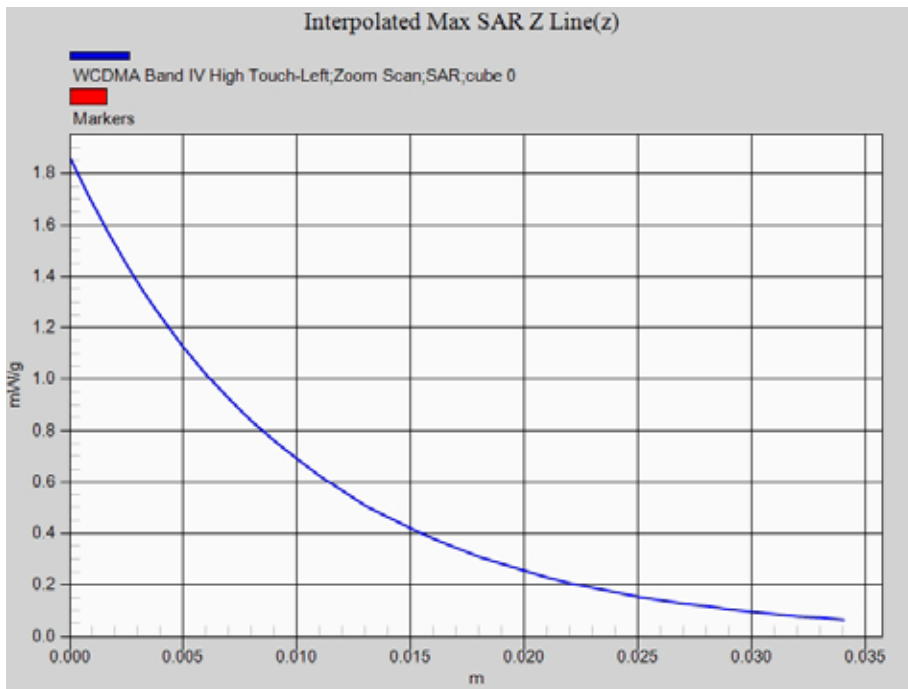

Date/Time: 05-06-2013

Test Laboratory: QuieTek Lab

WCDMA Band IV High Touch-Left-1

**DUT: Mobile Phone ; Type: 9788**

Communication System: UMTS; Communication System Band: Band IV UTRA/FDD; Duty Cycle: 1:1;

Frequency: 1752.6 MHz; Medium parameters used:  $f = 1752.6$  MHz;  $\sigma = 1.37$  mho/m;  $\epsilon_r = 39.5$ ;  $\rho = 1000$  kg/m<sup>3</sup> ; Phantom section: Left Section

Ambient temperature (°C): 21.5, Liquid temperature (°C): 21.0

DASY5 Configuration:

- Probe: EX3DV4 - SN3710; ConvF(7.75, 7.75, 7.75); Calibrated: 27/03/2013;
- Sensor-Surface: 4mm (Mechanical Surface Detection)
- Electronics: DAE4 Sn1220; Calibrated: 24/01/2013
- Phantom: SAM1; Type: SAM; Serial: TP1561
- Measurement SW: DASY52, Version 52.8 (1); SEMCAD X Version 14.6.5 (6469)

**Configuration/WCDMA Band IV High Touch-Left/Area Scan (7x11x1):** Measurement grid: dx=15mm, dy=15mm, Maximum value of SAR (measured) = 0.994 mW/g

**Configuration/WCDMA Band IV High Touch-Left/Zoom Scan (5x5x7)/Cube 0:** Measurement grid: dx=8mm, dy=8mm, dz=5mm, Reference Value = 9.256 V/m; Power Drift = -0.09 dB  
Peak SAR (extrapolated) = 1.595 mW/g

**SAR(1 g) = 0.972 mW/g; SAR(10 g) = 0.552 mW/g** Maximum value of SAR (measured) = 1.10 mW/g

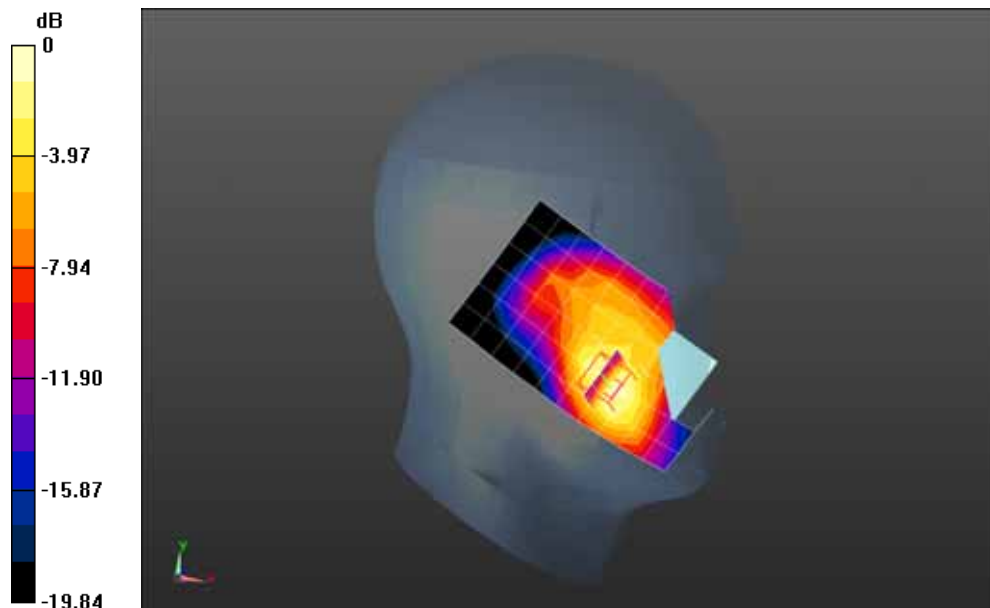

0 dB = 1.10 mW/g = 0.83 dB mW/g

Date/Time: 05-06-2013

Test Laboratory: QuieTek Lab

WCDMA Band IV Mid Tilt-Left

**DUT: Mobile Phone ; Type: 9788**

Communication System: UMTS; Communication System Band: Band IV UTRA/FDD; Duty Cycle: 1:1;

Frequency: 1732.6 MHz; Medium parameters used:  $f = 1732.6$  MHz;  $\sigma = 1.36$  mho/m;  $\epsilon_r = 39.58$ ;  $\rho = 1000$  kg/m<sup>3</sup> ; Phantom section: Left Section

Ambient temperature (°C): 21.5, Liquid temperature (°C): 21.0

DASY5 Configuration:

- Probe: EX3DV4 - SN3710; ConvF(7.75, 7.75, 7.75); Calibrated: 27/03/2013;
- Sensor-Surface: 4mm (Mechanical Surface Detection)
- Electronics: DAE4 Sn1220; Calibrated: 24/01/2013
- Phantom: SAM1; Type: SAM; Serial: TP1561
- Measurement SW: DASY52, Version 52.8 (1); SEMCAD X Version 14.6.5 (6469)

**Configuration/WCDMA Band IV Mid Tilt-Left/Area Scan (7x11x1):** Measurement grid: dx=15mm, dy=15mm, Maximum value of SAR (measured) = 0.243 mW/g

**Configuration/WCDMA Band IV Mid Tilt-Left/Zoom Scan (5x5x7)/Cube 0:** Measurement grid: dx=8mm, dy=8mm, dz=5mm, Reference Value = 10.367 V/m; Power Drift = -0.11 dB

Peak SAR (extrapolated) = 0.355 mW/g

**SAR(1 g) = 0.220 mW/g; SAR(10 g) = 0.131 mW/g** Maximum value of SAR (measured) = 0.237 mW/g

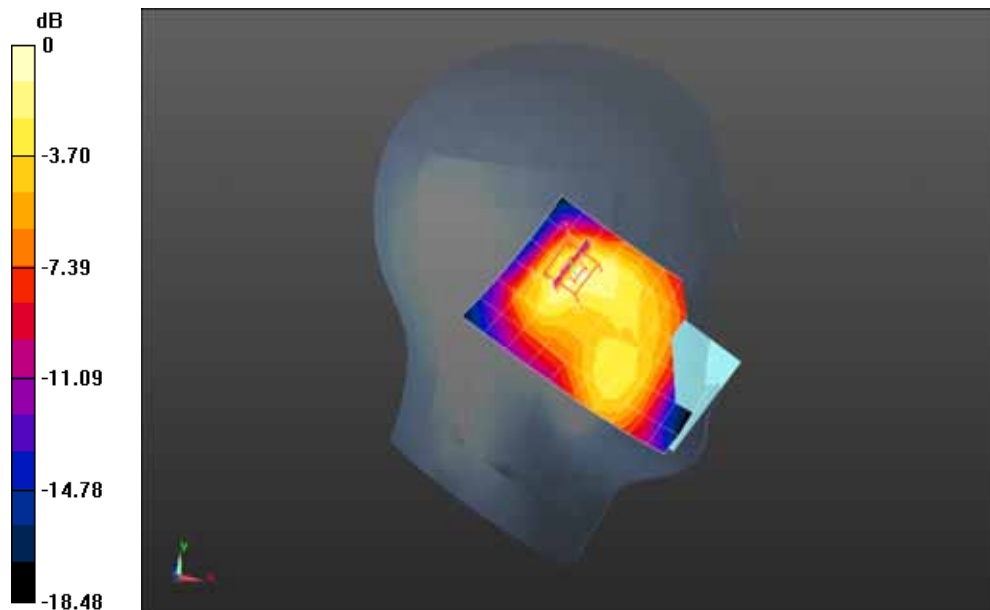

0 dB = 0.237 mW/g = -12.51 dB mW/g

Date/Time: 05-06-2013

Test Laboratory: QuieTek Lab

WCDMA Band IV Mid Touch-Right

**DUT: Mobile Phone ; Type: 9788**

Communication System: UMTS; Communication System Band: Band IV UTRA/FDD; Duty Cycle: 1:1;

Frequency: 1732.6 MHz; Medium parameters used:  $f = 1732.6$  MHz;  $\sigma = 1.36$  mho/m;  $\epsilon_r = 39.58$ ;  $\rho = 1000$  kg/m<sup>3</sup>; Phantom section: Right Section

Ambient temperature (°C): 21.5, Liquid temperature (°C): 21.0

DASY5 Configuration:

- Probe: EX3DV4 - SN3710; ConvF(7.75, 7.75, 7.75); Calibrated: 27/03/2013;
- Sensor-Surface: 4mm (Mechanical Surface Detection)
- Electronics: DAE4 Sn1220; Calibrated: 24/01/2013
- Phantom: SAM1; Type: SAM; Serial: TP1561
- Measurement SW: DASY52, Version 52.8 (1); SEMCAD X Version 14.6.5 (6469)

**Configuration/WCDMA Band IV Mid Touch-Left/Area Scan (7x11x1):** Measurement grid: dx=15mm, dy=15mm, Maximum value of SAR (measured) = 0.698 mW/g

**Configuration/WCDMA Band IV Mid Touch-Left/Zoom Scan (5x5x7)/Cube 0:** Measurement grid: dx=8mm, dy=8mm, dz=5mm, Reference Value = 6.973 V/m; Power Drift = -0.05 dB  
Peak SAR (extrapolated) = 1.070 mW/g

**SAR(1 g) = 0.722 mW/g; SAR(10 g) = 0.448 mW/g** Maximum value of SAR (measured) = 0.784 mW/g

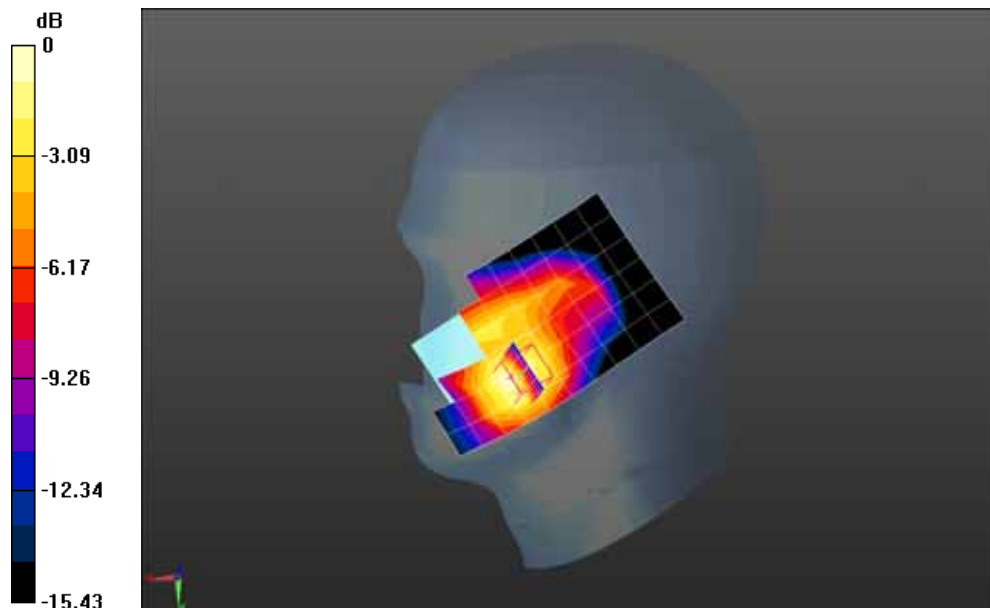

0 dB = 0.784 mW/g = -2.11 dB mW/g

Date/Time: 05-06-2013

Test Laboratory: QuieTek Lab

WCDMA Band IV Mid Tilt-Right

**DUT: Mobile Phone ; Type: 9788**

Communication System: UMTS; Communication System Band: Band IV UTRA/FDD; Duty Cycle: 1:1;

Frequency: 1732.6 MHz; Medium parameters used:  $f = 1732.6$  MHz;  $\sigma = 1.36$  mho/m;  $\epsilon_r = 39.58$ ;  $\rho = 1000$  kg/m<sup>3</sup>; Phantom section: Right Section

Ambient temperature (°C): 21.5, Liquid temperature (°C): 21.0

DASY5 Configuration:

- Probe: EX3DV4 - SN3710; ConvF(7.75, 7.75, 7.75); Calibrated: 27/03/2013;
- Sensor-Surface: 4mm (Mechanical Surface Detection)
- Electronics: DAE4 Sn1220; Calibrated: 24/01/2013
- Phantom: SAM1; Type: SAM; Serial: TP1561
- Measurement SW: DASY52, Version 52.8 (1); SEMCAD X Version 14.6.5 (6469)

**Configuration/WCDMA Band IV Mid Tilt-Left/Area Scan (7x11x1):** Measurement grid: dx=15mm, dy=15mm, Maximum value of SAR (measured) = 0.188 mW/g

**Configuration/WCDMA Band IV Mid Tilt-Left/Zoom Scan (5x5x7)/Cube 0:** Measurement grid: dx=8mm, dy=8mm, dz=5mm, Reference Value = 8.504 V/m; Power Drift = 0.19 dB

Peak SAR (extrapolated) = 0.279 mW/g

**SAR(1 g) = 0.177 mW/g; SAR(10 g) = 0.103 mW/g** Maximum value of SAR (measured) = 0.183 mW/g

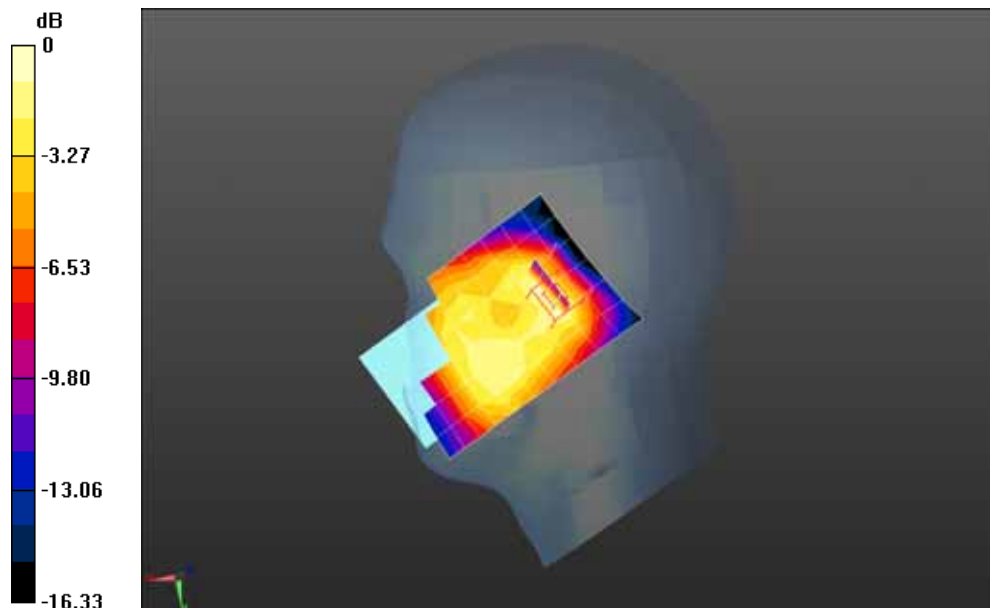

0 dB = 0.183 mW/g = -14.75 dB mW/g

Date/Time: 05-06-2013

Test Laboratory: QuieTek Lab

WCDMA Band IV Low Body-Back

**DUT: Mobile Phone ; Type: 9788**

Communication System: UMTS; Communication System Band: Band IV UTRA/FDD; Duty Cycle: 1:1;

Frequency: 1712.4 MHz; Medium parameters used:  $f = 1712.4$  MHz;  $\sigma = 1.44$  mho/m;  $\epsilon_r = 55.2$ ;  $\rho = 1000$  kg/m<sup>3</sup> ; Phantom section: Flat Section

Ambient temperature (°C): 21.5, Liquid temperature (°C): 21.0

DASY5 Configuration:

- Probe: EX3DV4 - SN3710; ConvF(7.6, 7.6, 7.6); Calibrated: 27/03/2013;
- Sensor-Surface: 4mm (Mechanical Surface Detection)
- Electronics: DAE4 Sn1220; Calibrated: 24/01/2013
- Phantom: SAM2; Type: SAM; Serial: TP1562
- Measurement SW: DASY52, Version 52.8 (1); SEMCAD X Version 14.6.5 (6469)

**Configuration/WCDMA Band IV Low Body-Back/Area Scan (7x11x1):** Measurement grid: dx=15mm, dy=15mm, Maximum value of SAR (measured) = 0.863 mW/g

**Configuration/WCDMA Band IV Low Body-Back/Zoom Scan (5x5x7)/Cube 0:** Measurement grid: dx=8mm, dy=8mm, dz=5mm, Reference Value = 10.005 V/m; Power Drift = -0.01 dB  
Peak SAR (extrapolated) = 1.340 mW/g

**SAR(1 g) = 0.794 mW/g; SAR(10 g) = 0.475 mW/g** Maximum value of SAR (measured) = 0.885 mW/g

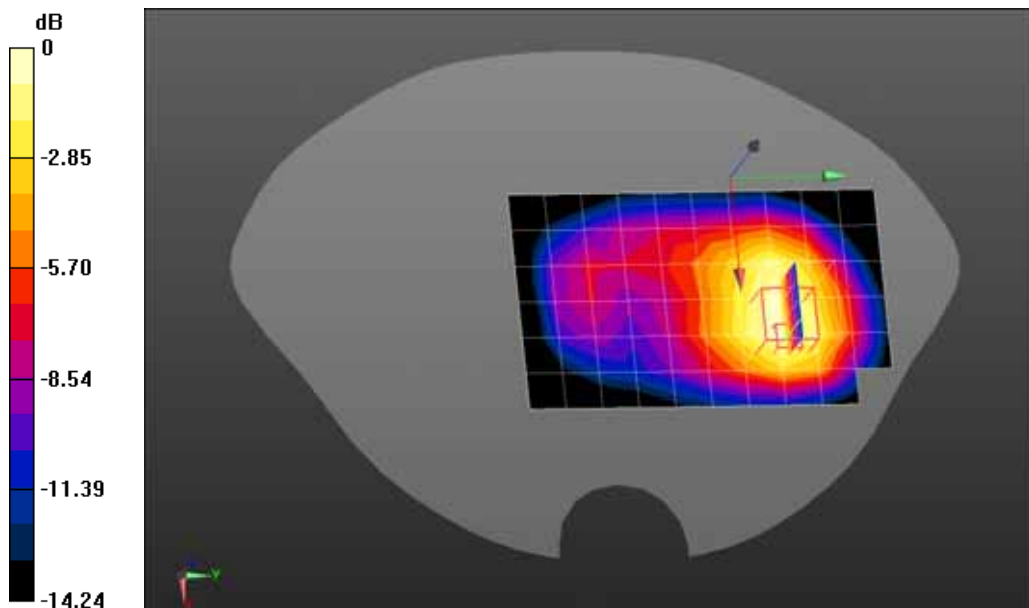

0 dB = 0.885 mW/g = -1.06 dB mW/g



Date/Time: 05-06-2013

Test Laboratory: QuieTek Lab

WCDMA Band IV Mid Body-Back

**DUT: Mobile Phone ; Type: 9788**

Communication System: UMTS; Communication System Band: Band IV UTRA/FDD; Duty Cycle: 1:1; Frequency: 1732.6 MHz; Medium parameters used:  $f = 1732.6$  MHz;  $\sigma = 1.45$  mho/m;  $\epsilon_r = 55$ ;  $\rho = 1000$  kg/m<sup>3</sup>; Phantom section: Flat Section

Ambient temperature (°C): 21.5, Liquid temperature (°C): 21.0

DASY5 Configuration:

- Probe: EX3DV4 - SN3710; ConvF(7.6, 7.6, 7.6); Calibrated: 27/03/2013;
- Sensor-Surface: 4mm (Mechanical Surface Detection)
- Electronics: DAE4 Sn1220; Calibrated: 24/01/2013
- Phantom: SAM2; Type: SAM; Serial: TP1562
- Measurement SW: DASY52, Version 52.8 (1); SEMCAD X Version 14.6.5 (6469)

**Configuration/WCDMA Band IV Mid Body-Back/Area Scan (7x11x1):** Measurement grid: dx=15mm, dy=15mm, Maximum value of SAR (measured) = 0.872 mW/g

**Configuration/WCDMA Band IV Mid Body-Back/Zoom Scan (5x5x7)/Cube 1:** Measurement grid: dx=8mm, dy=8mm, dz=5mm, Reference Value = 8.516 V/m; Power Drift = -0.15 dB  
Peak SAR (extrapolated) = 1.232 mW/g

**SAR(1 g) = 0.773 mW/g; SAR(10 g) = 0.480 mW/g** Maximum value of SAR (measured) = 0.839 mW/g

**Configuration/WCDMA Band IV Mid Body-Back/Zoom Scan (5x5x7)/Cube 0:** Measurement grid: dx=8mm, dy=8mm, dz=5mm, Reference Value = 8.516 V/m; Power Drift = -0.15 dB  
Peak SAR (extrapolated) = 1.249 mW/g

**SAR(1 g) = 0.766 mW/g; SAR(10 g) = 0.450 mW/g** Maximum value of SAR (measured) = 0.820 mW/g

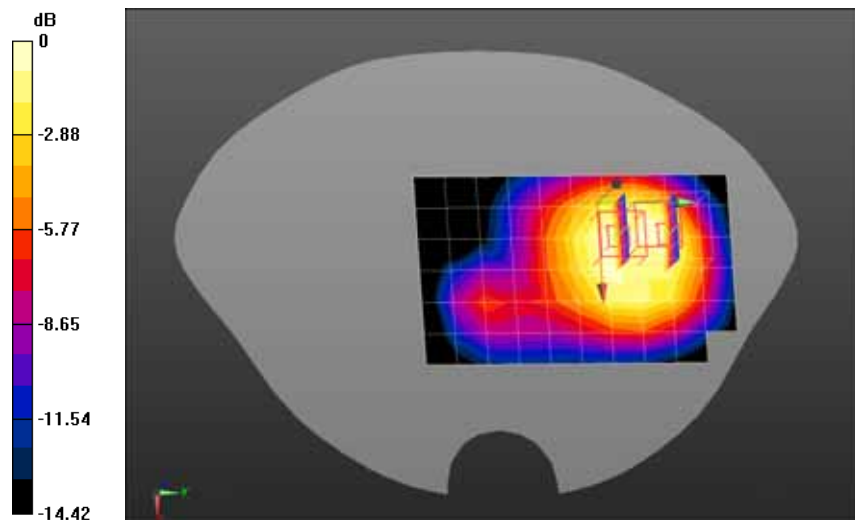

0 dB = 0.820 mW/g = -1.72 dB mW/g

Date/Time: 05-06-2013

Test Laboratory: QuieTek Lab

WCDMA Band IV High Body-Back

**DUT: Mobile Phone ; Type: 9788**

Communication System: UMTS; Communication System Band: Band IV UTRA/FDD; Duty Cycle: 1:1;

Frequency: 1752.6 MHz; Medium parameters used:  $f = 1752.6$  MHz;  $\sigma = 1.46$  mho/m;  $\epsilon_r = 54.6$ ;  $\rho = 1000$  kg/m<sup>3</sup> ; Phantom section: Flat Section

Ambient temperature (°C): 21.5, Liquid temperature (°C): 21.0

DASY5 Configuration:

- Probe: EX3DV4 - SN3710; ConvF(7.6, 7.6, 7.6); Calibrated: 27/03/2013;
- Sensor-Surface: 4mm (Mechanical Surface Detection)
- Electronics: DAE4 Sn1220; Calibrated: 24/01/2013
- Phantom: SAM2; Type: SAM; Serial: TP1562
- Measurement SW: DASY52, Version 52.8 (1); SEMCAD X Version 14.6.5 (6469)

**Configuration/WCDMA Band IV High Body-Back/Area Scan (7x11x1):** Measurement grid: dx=15mm, dy=15mm, Maximum value of SAR (measured) = 0.757 mW/g

**Configuration/WCDMA Band IV High Body-Back/Zoom Scan (5x5x7)/Cube 0:** Measurement grid: dx=8mm, dy=8mm, dz=5mm, Reference Value = 10.484 V/m; Power Drift = 0.01 dB  
Peak SAR (extrapolated) = 1.228 mW/g

**SAR(1 g) = 0.742 mW/g; SAR(10 g) = 0.461 mW/g** Maximum value of SAR (measured) = 0.819 mW/g

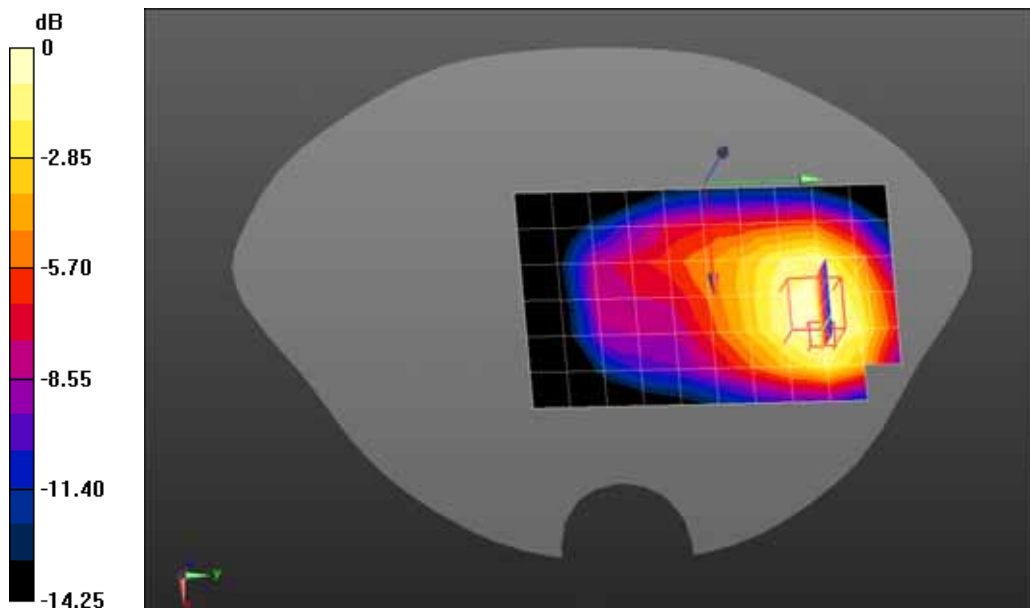

0 dB = 0.819 mW/g = -1.73 dB mW/g

Date/Time: 05-06-2013

Test Laboratory: QuieTek Lab

WCDMA Band IV Mid Body-Front

**DUT: Mobile Phone ; Type: 9788**

Communication System: UMTS; Communication System Band: Band IV UTRA/FDD; Duty Cycle: 1:1; Frequency: 1732.6 MHz; Medium parameters used:  $f = 1732.6$  MHz;  $\sigma = 1.45$  mho/m;  $\epsilon_r = 55$ ;  $\rho = 1000$  kg/m<sup>3</sup>; Phantom section: Flat Section

Ambient temperature (°C): 21.5, Liquid temperature (°C): 21.0

DASY5 Configuration:

- Probe: EX3DV4 - SN3710; ConvF(7.6, 7.6, 7.6); Calibrated: 27/03/2013;
- Sensor-Surface: 4mm (Mechanical Surface Detection)
- Electronics: DAE4 Sn1220; Calibrated: 24/01/2013
- Phantom: SAM2; Type: SAM; Serial: TP1562
- Measurement SW: DASY52, Version 52.8 (1); SEMCAD X Version 14.6.5 (6469)

**Configuration/WCDMA Band IV Mid Body-Front/Area Scan (7x11x1):** Measurement grid: dx=15mm, dy=15mm, Maximum value of SAR (measured) = 0.735 mW/g

**Configuration/WCDMA Band IV Mid Body-Front/Zoom Scan (5x5x7)/Cube 0:** Measurement grid: dx=8mm, dy=8mm, dz=5mm, Reference Value = 9.517 V/m; Power Drift = -0.11 dB  
Peak SAR (extrapolated) = 1.106 mW/g

**SAR(1 g) = 0.674 mW/g; SAR(10 g) = 0.427 mW/g** Maximum value of SAR (measured) = 0.739 mW/g

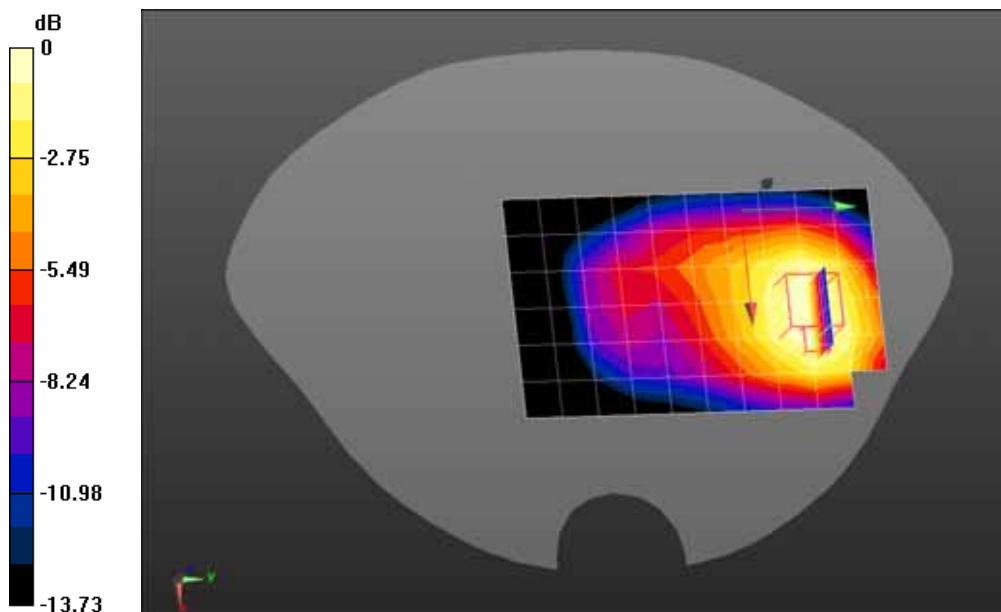

0 dB = 0.739 mW/g = -2.63 dB mW/g

Date/Time: 05-06-2013

Test Laboratory: QuieTek Lab

WCDMA Band IV Mid Body-Bottom

**DUT: Mobile Phone ; Type: 9788**

Communication System: UMTS; Communication System Band: Band IV UTRA/FDD; Duty Cycle: 1:1;

Frequency: 1732.6 MHz; Medium parameters used:  $f = 1732.6$  MHz;  $\sigma = 1.45$  mho/m;  $\epsilon_r = 55$ ;  $\rho = 1000$  kg/m<sup>3</sup>; Phantom section: Flat Section

Ambient temperature (°C): 21.5, Liquid temperature (°C): 21.0

DASY5 Configuration:

- Probe: EX3DV4 - SN3710; ConvF(7.6, 7.6, 7.6); Calibrated: 27/03/2013;
- Sensor-Surface: 4mm (Mechanical Surface Detection)
- Electronics: DAE4 Sn1220; Calibrated: 24/01/2013
- Phantom: SAM2; Type: SAM; Serial: TP1562
- Measurement SW: DASY52, Version 52.8 (1); SEMCAD X Version 14.6.5 (6469)

**Configuration/WCDMA Band IV Mid Body-Bottom/Area Scan (7x7x1):** Measurement grid: dx=15mm, dy=15mm, Maximum value of SAR (measured) = 0.542 mW/g

**Configuration/WCDMA Band IV Mid Body-Bottom/Zoom Scan (5x5x7)/Cube 0:** Measurement grid: dx=8mm, dy=8mm, dz=5mm, Reference Value = 18.583 V/m; Power Drift = -0.14 dB  
Peak SAR (extrapolated) = 0.862 mW/g

**SAR(1 g) = 0.542 mW/g; SAR(10 g) = 0.324 mW/g** Maximum value of SAR (measured) = 0.593 mW/g

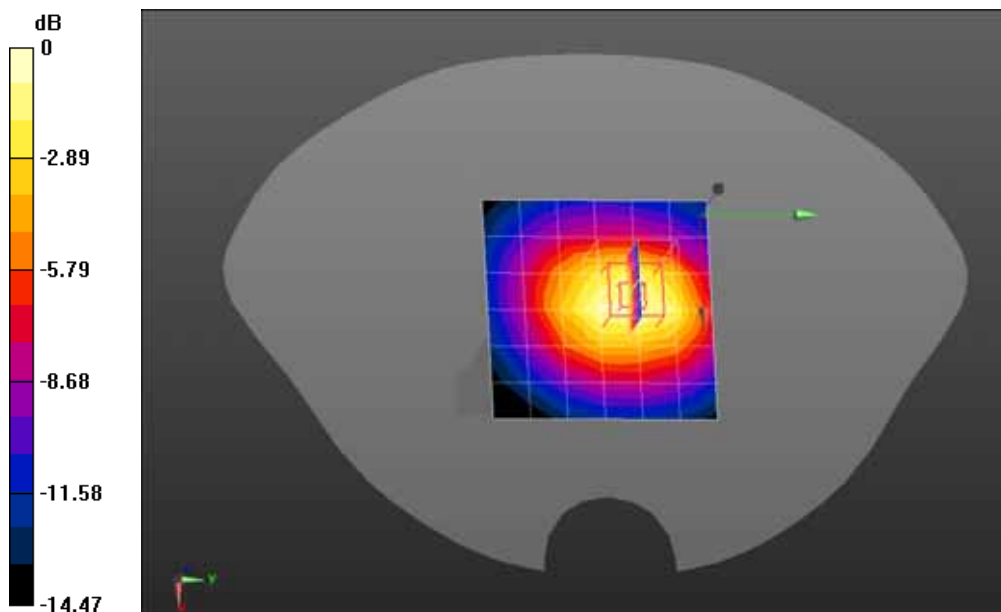

0 dB = 0.593 mW/g = -4.54 dB mW/g

Date/Time: 05-06-2013

Test Laboratory: QuieTek Lab

WCDMA Band IV Mid Body-Left side

**DUT: Mobile Phone ; Type: 9788**

Communication System: UMTS; Communication System Band: Band IV UTRA/FDD; Duty Cycle: 1:1;  
 Frequency: 1732.6 MHz; Medium parameters used:  $f = 1732.6$  MHz;  $\sigma = 1.45$  mho/m;  $\epsilon_r = 55$ ;  $\rho = 1000$  kg/m<sup>3</sup> ; Phantom section: Flat Section

Ambient temperature (°C): 21.5, Liquid temperature (°C): 21.0

DASY5 Configuration:

- Probe: EX3DV4 - SN3710; ConvF(7.6, 7.6, 7.6); Calibrated: 27/03/2013;
- Sensor-Surface: 4mm (Mechanical Surface Detection)
- Electronics: DAE4 Sn1220; Calibrated: 24/01/2013
- Phantom: SAM2; Type: SAM; Serial: TP1562
- Measurement SW: DASY52, Version 52.8 (1); SEMCAD X Version 14.6.5 (6469)

**Configuration/WCDMA Band IV Mid Body-Left side/Area Scan (7x11x1):** Measurement grid: dx=15mm, dy=15mm, Maximum value of SAR (measured) = 0.246 mW/g

**Configuration/WCDMA Band IV Mid Body-Left side/Zoom Scan (5x5x7)/Cube 0:** Measurement grid: dx=8mm, dy=8mm, dz=5mm, Reference Value = 7.398 V/m; Power Drift = -0.18 dB  
 Peak SAR (extrapolated) = 0.371 mW/g

**SAR(1 g) = 0.237 mW/g; SAR(10 g) = 0.144 mW/g** Maximum value of SAR (measured) = 0.262 mW/g

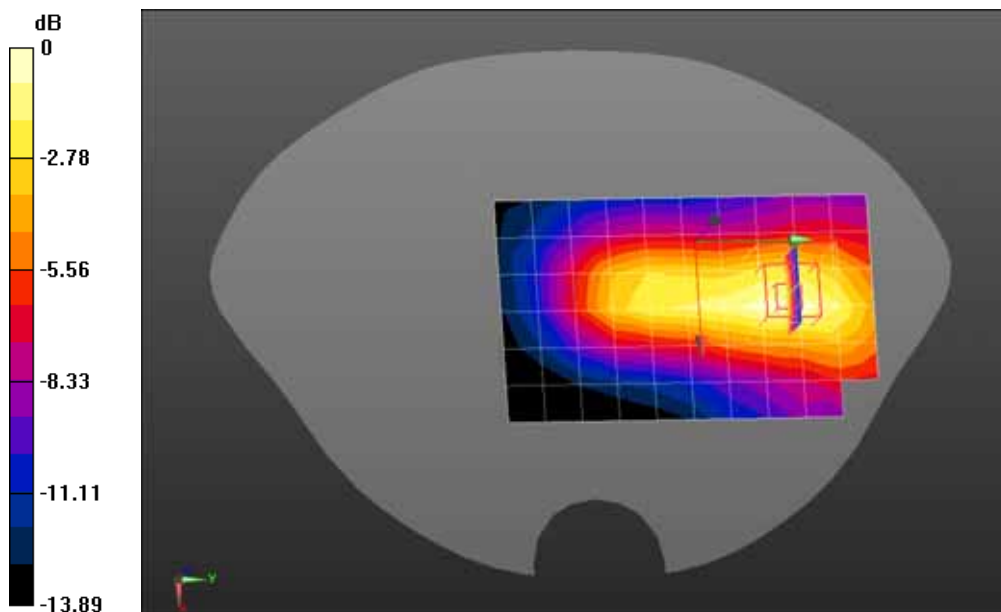

0 dB = 0.262 mW/g = -11.63 dB mW/g

Date/Time: 05-06-2013

Test Laboratory: QuieTek Lab

WCDMA Band IV Mid Body-Right side

**DUT: Mobile Phone ; Type: 9788**

Communication System: UMTS; Communication System Band: Band IV UTRA/FDD; Duty Cycle: 1:1;  
 Frequency: 1732.6 MHz; Medium parameters used:  $f = 1732.6$  MHz;  $\sigma = 1.45$  mho/m;  $\epsilon_r = 55$ ;  $\rho = 1000$  kg/m<sup>3</sup> ; Phantom section: Flat Section

Ambient temperature (°C): 21.5, Liquid temperature (°C): 21.0

DASY5 Configuration:

- Probe: EX3DV4 - SN3710; ConvF(7.6, 7.6, 7.6); Calibrated: 27/03/2013;
- Sensor-Surface: 4mm (Mechanical Surface Detection)
- Electronics: DAE4 Sn1220; Calibrated: 24/01/2013
- Phantom: SAM2; Type: SAM; Serial: TP1562
- Measurement SW: DASY52, Version 52.8 (1); SEMCAD X Version 14.6.5 (6469)

**Configuration/WCDMA Band IV Mid Body-Right side/Area Scan (7x11x1):** Measurement grid:

dx=15mm, dy=15mm, Maximum value of SAR (measured) = 0.170 mW/g

**Configuration/WCDMA Band IV Mid Body-Right side/Zoom Scan (5x5x7)/Cube 0:** Measurement grid:

dx=8mm, dy=8mm, dz=5mm, Reference Value = 6.609 V/m; Power Drift = 0.01 dB

Peak SAR (extrapolated) = 0.271 mW/g

**SAR(1 g) = 0.177 mW/g; SAR(10 g) = 0.112 mW/g** Maximum value of SAR (measured) = 0.192 mW/g

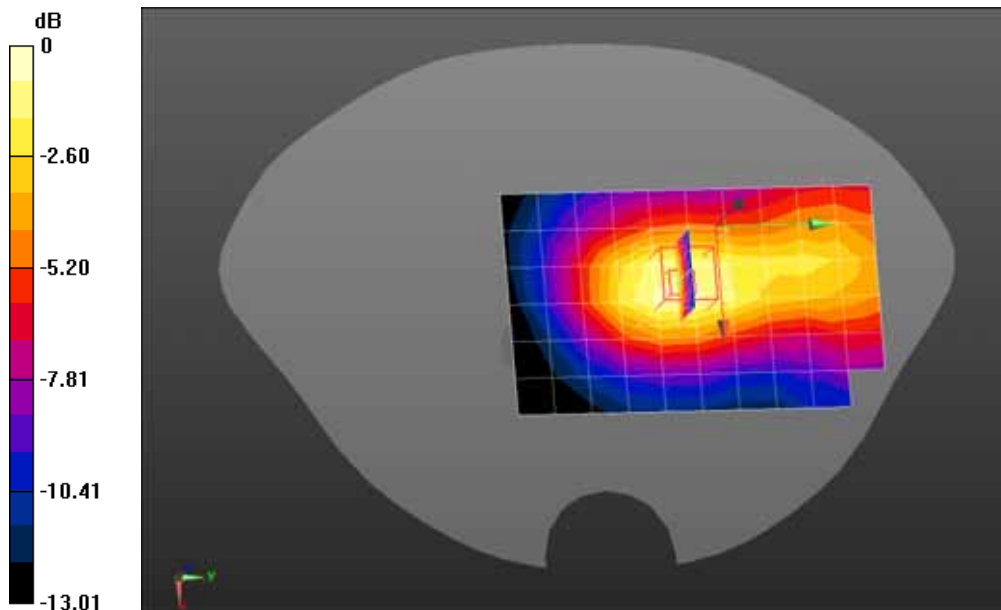

0 dB = 0.192 mW/g = -14.33 dB mW/g

Date/Time: 05-06-2013

Test Laboratory: QuieTek Lab

WCDMA Band V Mid Touch-Left

**DUT: Smartphone ; Type: 9788**

Communication System: UMTS; Communication System Band: Band V UTRA/FDD; Duty Cycle: 1:1;  
 Frequency: 836.4 MHz; Medium parameters used:  $f = 836.4$  MHz;  $\sigma = 0.87$  mho/m;  $\epsilon_r = 41.11$ ;  $\rho = 1000$  kg/m<sup>3</sup> ; Phantom section: Left Section

Ambient temperature (°C): 21.5, Liquid temperature (°C): 21.0

DASY5 Configuration:

- Probe: EX3DV4 - SN3710; ConvF(9.52, 9.52, 9.52); Calibrated: 27/03/2013;
- Sensor-Surface: 4mm (Mechanical Surface Detection)
- Electronics: DAE4 Sn1220; Calibrated: 24/01/2013
- Phantom: SAM2; Type: SAM; Serial: TP1562
- Measurement SW: DASY52, Version 52.8 (1); SEMCAD X Version 14.6.5 (6469)

**Configuration/WCDMA Band V Mid Touch-Left/Area Scan (7x11x1):** Measurement grid: dx=15mm, dy=15mm, Maximum value of SAR (measured) = 0.352 mW/g

**Configuration/WCDMA Band V Mid Touch-Left/Zoom Scan (5x5x7)/Cube 0:** Measurement grid: dx=8mm, dy=8mm, dz=5mm, Reference Value = 3.770 V/m; Power Drift = 0.02 dB  
 Peak SAR (extrapolated) = 0.453 mW/g

**SAR(1 g) = 0.333 mW/g; SAR(10 g) = 0.245 mW/g** Maximum value of SAR (measured) = 0.353 mW/g

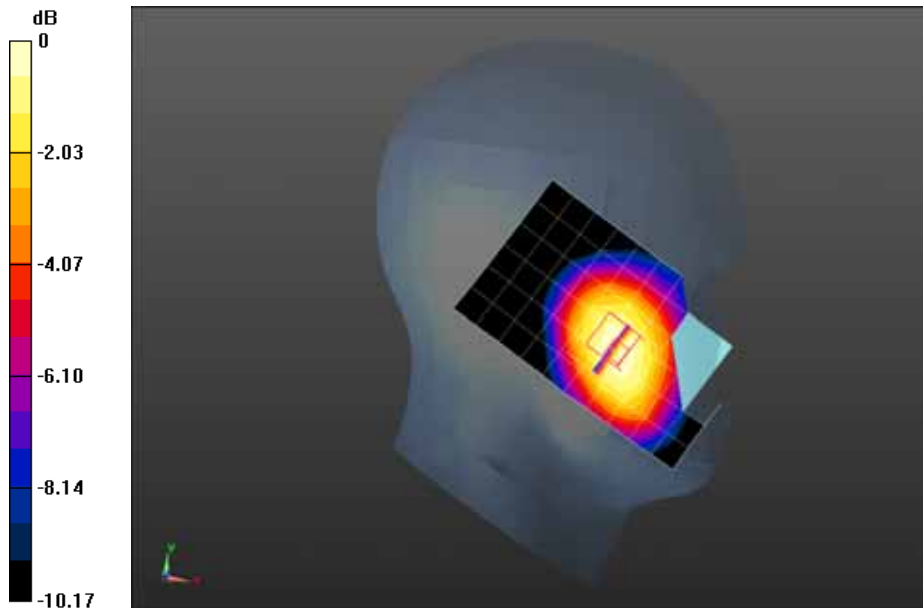

0 dB = 0.353 mW/g = -9.04 dB mW/g



Date/Time: 05-06-2013

Test Laboratory: QuieTek Lab

WCDMA Band V Mid Tilt-Left

**DUT: Smartphone ; Type: 9788**

Communication System: UMTS; Communication System Band: Band V UTRA/FDD; Duty Cycle: 1:1;  
 Frequency: 836.4 MHz; Medium parameters used:  $f = 836.4$  MHz;  $\sigma = 0.87$  mho/m;  $\epsilon_r = 41.11$ ;  $\rho = 1000$  kg/m<sup>3</sup> ; Phantom section: Left Section

Ambient temperature (°C): 21.5, Liquid temperature (°C): 21.0

DASY5 Configuration:

- Probe: EX3DV4 - SN3710; ConvF(9.52, 9.52, 9.52); Calibrated: 27/03/2013;
- Sensor-Surface: 4mm (Mechanical Surface Detection)
- Electronics: DAE4 Sn1220; Calibrated: 24/01/2013
- Phantom: SAM2; Type: SAM; Serial: TP1562
- Measurement SW: DASY52, Version 52.8 (1); SEMCAD X Version 14.6.5 (6469)

**Configuration/WCDMA Band V Mid Tilt-Left/Area Scan (7x11x1):** Measurement grid: dx=15mm, dy=15mm, Maximum value of SAR (measured) = 0.224 mW/g

**Configuration/WCDMA Band V Mid Tilt-Left/Zoom Scan (5x5x7)/Cube 0:** Measurement grid: dx=8mm, dy=8mm, dz=5mm, Reference Value = 7.475 V/m; Power Drift = -0.01 dB

Peak SAR (extrapolated) = 0.272 mW/g

**SAR(1 g) = 0.215 mW/g; SAR(10 g) = 0.160 mW/g** Maximum value of SAR (measured) = 0.225 mW/g

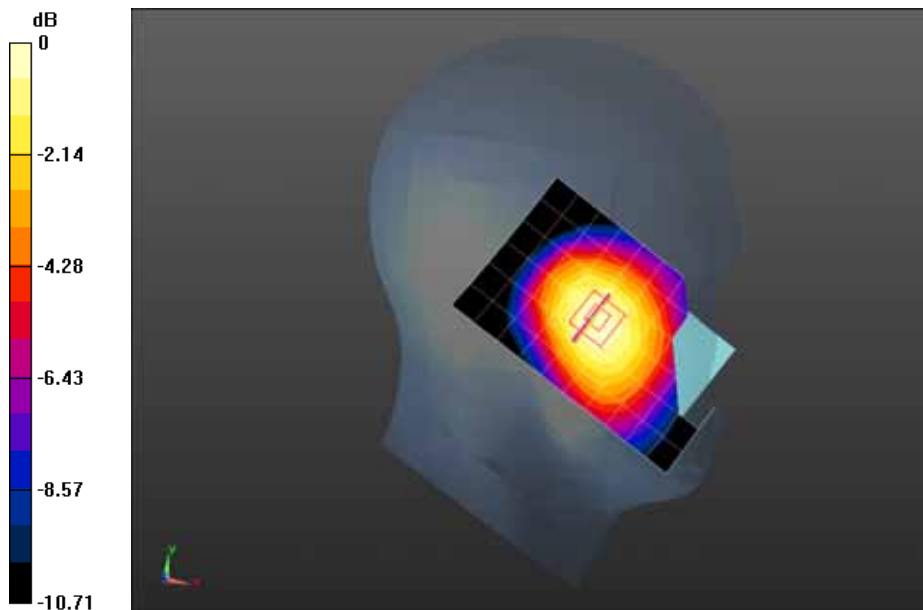

0 dB = 0.225 mW/g = -12.96 dB mW/g



Date/Time: 05-06-2013

Test Laboratory: QuieTek Lab

WCDMA Band V Mid Touch-Right

**DUT: Smartphone ; Type: 9788**

Communication System: UMTS; Communication System Band: Band V UTRA/FDD; Duty Cycle: 1:1;  
 Frequency: 836.4 MHz; Medium parameters used:  $f = 836.4$  MHz;  $\sigma = 0.87$  mho/m;  $\epsilon_r = 41.11$ ;  $\rho = 1000$  kg/m<sup>3</sup> ; Phantom section: Right Section

Ambient temperature (°C): 21.5, Liquid temperature (°C): 21.0

DASY5 Configuration:

- Probe: EX3DV4 - SN3710; ConvF(9.52, 9.52, 9.52); Calibrated: 27/03/2013;
- Sensor-Surface: 4mm (Mechanical Surface Detection)
- Electronics: DAE4 Sn1220; Calibrated: 24/01/2013
- Phantom: SAM2; Type: SAM; Serial: TP1562
- Measurement SW: DASY52, Version 52.8 (1); SEMCAD X Version 14.6.5 (6469)

**Configuration/WCDMA Band V Mid Touch-Right/Area Scan (7x11x1):** Measurement grid: dx=15mm, dy=15mm, Maximum value of SAR (measured) = 0.359 mW/g

**Configuration/WCDMA Band V Mid Touch-Right/Zoom Scan (5x5x7)/Cube 0:** Measurement grid: dx=8mm, dy=8mm, dz=5mm, Reference Value = 4.812 V/m; Power Drift = -0.07 dB  
 Peak SAR (extrapolated) = 0.417 mW/g

**SAR(1 g) = 0.342 mW/g; SAR(10 g) = 0.259 mW/g** Maximum value of SAR (measured) = 0.358 mW/g

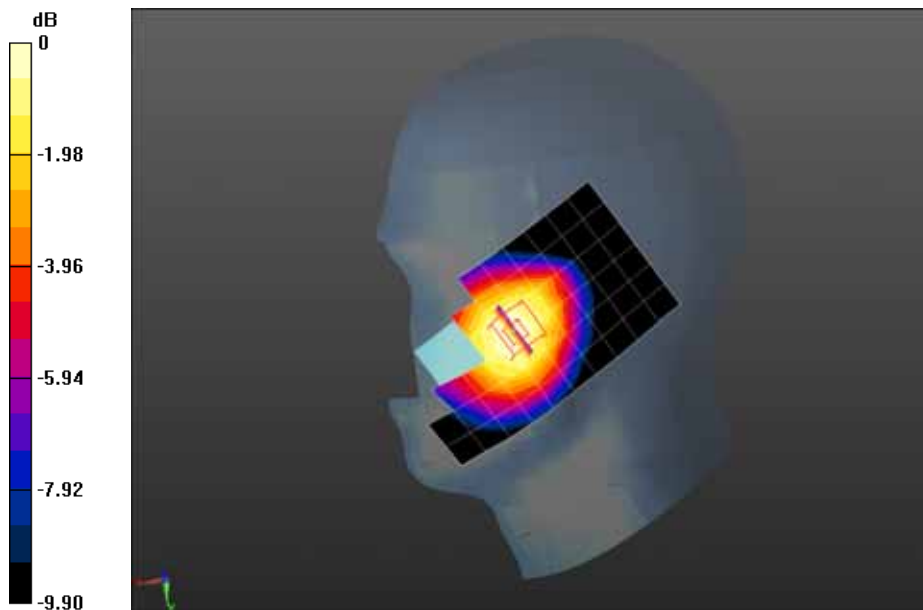

0 dB = 0.358 mW/g = -8.92 dB mW/g

Date/Time: 05-06-2013

Test Laboratory: QuieTek Lab

WCDMA Band V Mid Tilt-Right

**DUT: Smartphone ; Type: 9788**

Communication System: UMTS; Communication System Band: Band V UTRA/FDD; Duty Cycle: 1:1;  
 Frequency: 836.4 MHz; Medium parameters used:  $f = 836.4$  MHz;  $\sigma = 0.87$  mho/m;  $\epsilon_r = 41.11$ ;  $\rho = 1000$  kg/m<sup>3</sup> ; Phantom section: Right Section

Ambient temperature (°C): 21.5, Liquid temperature (°C): 21.0

DASY5 Configuration:

- Probe: EX3DV4 - SN3710; ConvF(9.52, 9.52, 9.52); Calibrated: 27/03/2013;
- Sensor-Surface: 4mm (Mechanical Surface Detection)
- Electronics: DAE4 Sn1220; Calibrated: 24/01/2013
- Phantom: SAM2; Type: SAM; Serial: TP1562
- Measurement SW: DASY52, Version 52.8 (1); SEMCAD X Version 14.6.5 (6469)

**Configuration/WCDMA Band V Mid Tilt-Right/Area Scan (7x11x1):** Measurement grid: dx=15mm, dy=15mm, Maximum value of SAR (measured) = 0.243 mW/g

**Configuration/WCDMA Band V Mid Tilt-Right/Zoom Scan (5x5x7)/Cube 0:** Measurement grid: dx=8mm, dy=8mm, dz=5mm, Reference Value = 8.527 V/m; Power Drift = -0.04 dB

Peak SAR (extrapolated) = 0.297 mW/g

**SAR(1 g) = 0.233 mW/g; SAR(10 g) = 0.174 mW/g** Maximum value of SAR (measured) = 0.244 mW/g

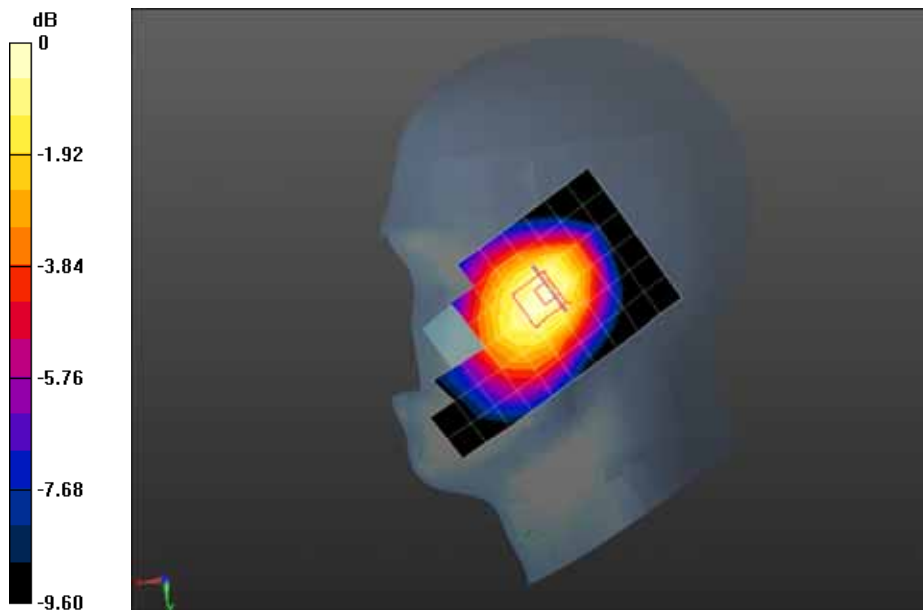

0 dB = 0.244 mW/g = -12.25 dB mW/g

Date/Time: 05-06-2013

Test Laboratory: QuieTek Lab

WCDMA Band V Low Body-Back

**DUT: Smartphone ; Type: 9788**

Communication System: UMTS; Communication System Band: Band V UTRA/FDD; Duty Cycle: 1:1;  
 Frequency: 826.4 MHz; Medium parameters used:  $f = 826.4$  MHz;  $\sigma = 0.97$  mho/m;  $\epsilon_r = 52.93$ ;  $\rho = 1000$  kg/m<sup>3</sup> ; Phantom section: Flat Section

Ambient temperature (°C): 21.5, Liquid temperature (°C): 21.0

DASY5 Configuration:

- Probe: EX3DV4 - SN3710; ConvF(9.41, 9.41, 9.41); Calibrated: 27/03/2013;
- Sensor-Surface: 4mm (Mechanical Surface Detection)
- Electronics: DAE4 Sn1220; Calibrated: 24/01/2013
- Phantom: SAM1; Type: SAM; Serial: TP1561
- Measurement SW: DASY52, Version 52.8 (1); SEMCAD X Version 14.6.5 (6469)

**Configuration/WCDMA Band V Low Body-Back/Area Scan (7x11x1):** Measurement grid: dx=15mm, dy=15mm, Maximum value of SAR (measured) = 0.808 mW/g

**Configuration/WCDMA Band V Low Body-Back/Zoom Scan (5x5x7)/Cube 1:** Measurement grid: dx=8mm, dy=8mm, dz=5mm, Reference Value = 9.599 V/m; Power Drift = -0.13 dB  
 Peak SAR (extrapolated) = 0.922 mW/g

**SAR(1 g) = 0.660 mW/g; SAR(10 g) = 0.451 mW/g** Maximum value of SAR (measured) = 0.742 mW/g

**Configuration/WCDMA Band V Low Body-Back/Zoom Scan (5x5x7)/Cube 0:** Measurement grid: dx=8mm, dy=8mm, dz=5mm, Reference Value = 9.599 V/m; Power Drift = -0.13 dB  
 Peak SAR (extrapolated) = 0.994 mW/g

**SAR(1 g) = 0.768 mW/g; SAR(10 g) = 0.564 mW/g** Maximum value of SAR (measured) = 0.812 mW/g

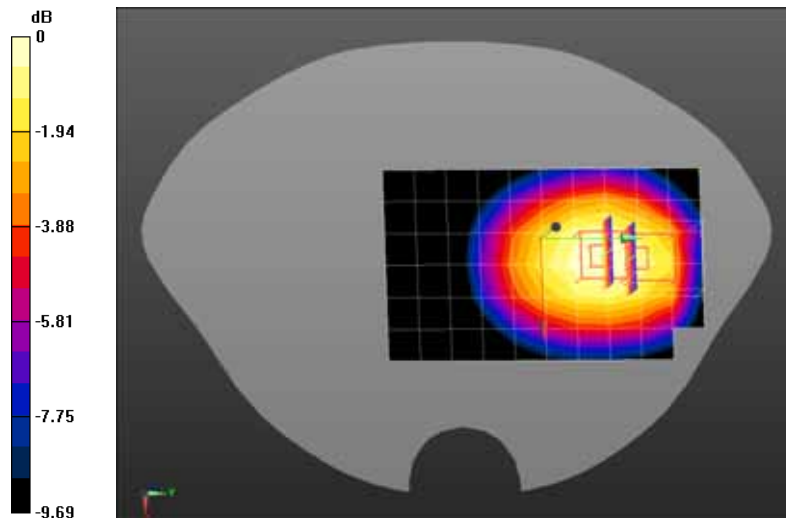

0 dB = 0.812 mW/g = -1.81 dB mW/g

Date/Time: 05-06-2013

Test Laboratory: QuieTek Lab

WCDMA Band V Mid Body-Back

**DUT: Smartphone ; Type: 9788**

Communication System: UMTS; Communication System Band: Band V UTRA/FDD; Duty Cycle: 1:1;  
 Frequency: 836.4 MHz; Medium parameters used:  $f = 836.4$  MHz;  $\sigma = 0.97$  mho/m;  $\epsilon_r = 52.88$ ;  $\rho = 1000$  kg/m<sup>3</sup> ; Phantom section: Flat Section

Ambient temperature (°C): 21.5, Liquid temperature (°C): 21.0

DASY5 Configuration:

- Probe: EX3DV4 - SN3710; ConvF(9.41, 9.41, 9.41); Calibrated: 27/03/2013;
- Sensor-Surface: 4mm (Mechanical Surface Detection)
- Electronics: DAE4 Sn1220; Calibrated: 24/01/2013
- Phantom: SAM1; Type: SAM; Serial: TP1561
- Measurement SW: DASY52, Version 52.8 (1); SEMCAD X Version 14.6.5 (6469)

**Configuration/WCDMA Band V Mid Body-Back/Area Scan (7x11x1):** Measurement grid: dx=15mm, dy=15mm, Maximum value of SAR (measured) = 0.955 mW/g

**Configuration/WCDMA Band V Mid Body-Back/Zoom Scan (5x5x7)/Cube 1:** Measurement grid: dx=8mm, dy=8mm, dz=5mm, Reference Value = 16.958 V/m; Power Drift = 0.01 dB  
 Peak SAR (extrapolated) = 1.099 mW/g

**SAR(1 g) = 0.793 mW/g; SAR(10 g) = 0.547 mW/g** Maximum value of SAR (measured) = 0.885 mW/g

**Configuration/WCDMA Band V Mid Body-Back/Zoom Scan (5x5x7)/Cube 0:** Measurement grid: dx=8mm, dy=8mm, dz=5mm, Reference Value = 16.958 V/m; Power Drift = 0.01 dB  
 Peak SAR (extrapolated) = 1.205 mW/g

**SAR(1 g) = 0.923 mW/g; SAR(10 g) = 0.675 mW/g** Maximum value of SAR (measured) = 0.980 mW/g

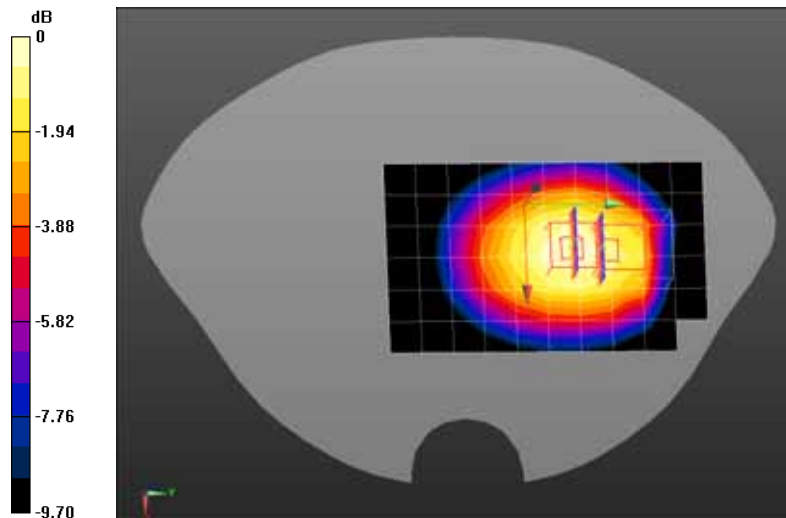

0 dB = 0.980 mW/g = -0.18 dB mW/g

Z-Axis Plot

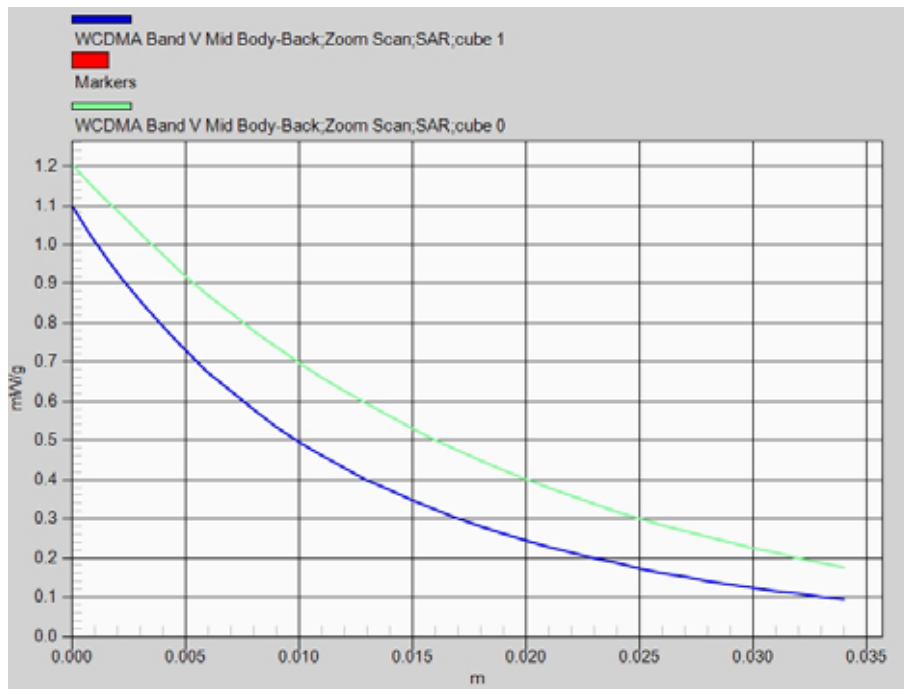

Date/Time: 05-06-2013

Test Laboratory: QuieTek Lab

WCDMA Band V Mid Body-Back-1

**DUT: Smartphone ; Type: 9788**

Communication System: UMTS; Communication System Band: Band V UTRA/FDD; Duty Cycle: 1:1; Frequency: 836.4 MHz; Medium parameters used:  $f = 836.4$  MHz;  $\sigma = 0.97$  mho/m;  $\epsilon_r = 52.88$ ;  $\rho = 1000$  kg/m<sup>3</sup>; Phantom section: Flat Section

Ambient temperature (°C): 21.5, Liquid temperature (°C): 21.0

DASY5 Configuration:

- Probe: EX3DV4 - SN3710; ConvF(9.41, 9.41, 9.41); Calibrated: 27/03/2013;
- Sensor-Surface: 4mm (Mechanical Surface Detection)
- Electronics: DAE4 Sn1220; Calibrated: 24/01/2013
- Phantom: SAM1; Type: SAM; Serial: TP1561
- Measurement SW: DASY52, Version 52.8 (1); SEMCAD X Version 14.6.5 (6469)

**Configuration/WCDMA Band V Mid Body-Back/Area Scan (7x11x1):** Measurement grid: dx=15mm, dy=15mm, Maximum value of SAR (measured) = 0.887 mW/g

**Configuration/WCDMA Band V Mid Body-Back/Zoom Scan (5x5x7)/Cube 1:** Measurement grid: dx=8mm, dy=8mm, dz=5mm, Reference Value = 10.112 V/m; Power Drift = 0.02 dB  
Peak SAR (extrapolated) = 1.014 mW/g

**SAR(1 g) = 0.726 mW/g; SAR(10 g) = 0.493 mW/g** Maximum value of SAR (measured) = 0.817 mW/g

**Configuration/WCDMA Band V Mid Body-Back/Zoom Scan (5x5x7)/Cube 0:** Measurement grid: dx=8mm, dy=8mm, dz=5mm, Reference Value = 10.112 V/m; Power Drift = 0.02 dB  
Peak SAR (extrapolated) = 1.115 mW/g

**SAR(1 g) = 0.858 mW/g; SAR(10 g) = 0.628 mW/g** Maximum value of SAR (measured) = 0.907 mW/g

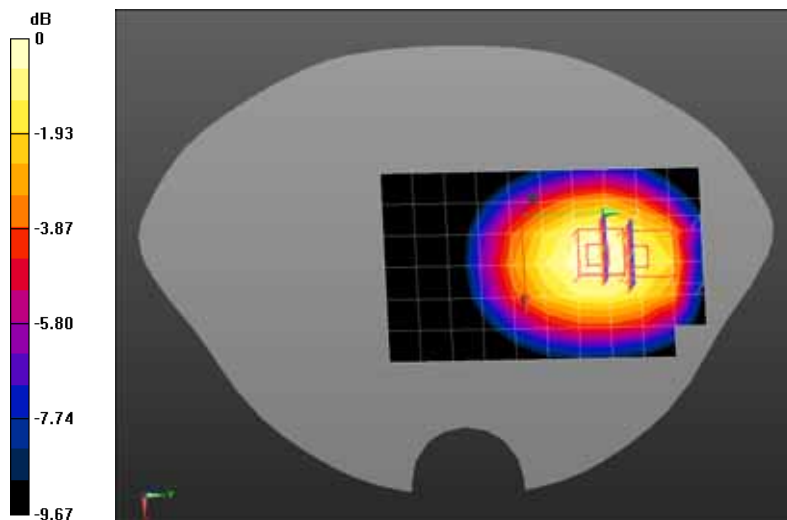

0 dB = 0.907 mW/g = -0.85 dB mW/g

Date/Time: 05-06-2013

Test Laboratory: QuieTek Lab

WCDMA Band V High Body-Back

**DUT: Smartphone ; Type: 9788**

Communication System: UMTS; Communication System Band: Band V UTRA/FDD; Duty Cycle: 1:1;  
 Frequency: 846.6 MHz; Medium parameters used:  $f = 846.6$  MHz;  $\sigma = 0.98$  mho/m;  $\epsilon_r = 52.71$ ;  $\rho = 1000$  kg/m<sup>3</sup> ; Phantom section: Flat Section

Ambient temperature (°C): 21.5, Liquid temperature (°C): 21.0

DASY5 Configuration:

- Probe: EX3DV4 - SN3710; ConvF(9.41, 9.41, 9.41); Calibrated: 27/03/2013;
- Sensor-Surface: 4mm (Mechanical Surface Detection)
- Electronics: DAE4 Sn1220; Calibrated: 24/01/2013
- Phantom: SAM1; Type: SAM; Serial: TP1561
- Measurement SW: DASY52, Version 52.8 (1); SEMCAD X Version 14.6.5 (6469)

**Configuration/WCDMA Band V High Body-Back/Area Scan (7x11x1):** Measurement grid: dx=15mm, dy=15mm, Maximum value of SAR (measured) = 0.953 mW/g

**Configuration/WCDMA Band V High Body-Back/Zoom Scan (5x5x7)/Cube 1:** Measurement grid: dx=8mm, dy=8mm, dz=5mm, Reference Value = 10.641 V/m; Power Drift = 0.07 dB  
 Peak SAR (extrapolated) = 1.082 mW/g

**SAR(1 g) = 0.774 mW/g; SAR(10 g) = 0.522 mW/g** Maximum value of SAR (measured) = 0.879 mW/g

**Configuration/WCDMA Band V High Body-Back/Zoom Scan (5x5x7)/Cube 0:** Measurement grid: dx=8mm, dy=8mm, dz=5mm, Reference Value = 10.641 V/m; Power Drift = 0.07 dB  
 Peak SAR (extrapolated) = 1.201 mW/g

**SAR(1 g) = 0.922 mW/g; SAR(10 g) = 0.674 mW/g** Maximum value of SAR (measured) = 0.974 mW/g

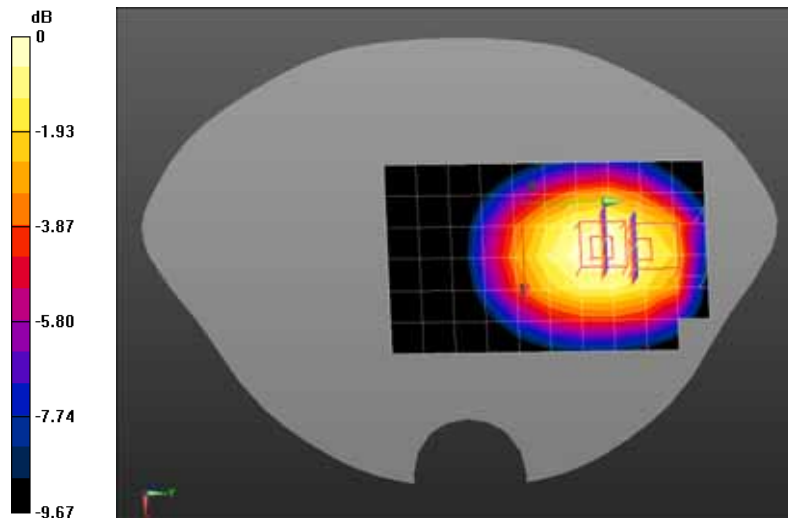

0 dB = 0.974 mW/g = -0.23 dB mW/g

Date/Time: 05-06-2013

Test Laboratory: QuieTek Lab

WCDMA Band V Mid Body-Front

**DUT: Smartphone ; Type: 9788**

Communication System: UMTS; Communication System Band: Band V UTRA/FDD; Duty Cycle: 1:1;  
 Frequency: 836.4 MHz; Medium parameters used:  $f = 836.4$  MHz;  $\sigma = 0.97$  mho/m;  $\epsilon_r = 52.88$ ;  $\rho = 1000$  kg/m<sup>3</sup> ; Phantom section: Flat Section

Ambient temperature (°C): 21.5, Liquid temperature (°C): 21.0

DASY5 Configuration:

- Probe: EX3DV4 - SN3710; ConvF(9.41, 9.41, 9.41); Calibrated: 27/03/2013;
- Sensor-Surface: 4mm (Mechanical Surface Detection)
- Electronics: DAE4 Sn1220; Calibrated: 24/01/2013
- Phantom: SAM1; Type: SAM; Serial: TP1561
- Measurement SW: DASY52, Version 52.8 (1); SEMCAD X Version 14.6.5 (6469)

**Configuration/WCDMA Band V Mid Body-Front/Area Scan (7x11x1):** Measurement grid: dx=15mm, dy=15mm, Maximum value of SAR (measured) = 0.429 mW/g

**Configuration/WCDMA Band V Mid Body-Front/Zoom Scan (6x6x7)/Cube 0:** Measurement grid: dx=8mm, dy=8mm, dz=5mm, Reference Value = 11.759 V/m; Power Drift = 0.01 dB  
 Peak SAR (extrapolated) = 0.605 mW/g

**SAR(1 g) = 0.414 mW/g; SAR(10 g) = 0.301 mW/g** Maximum value of SAR (measured) = 0.437 mW/g

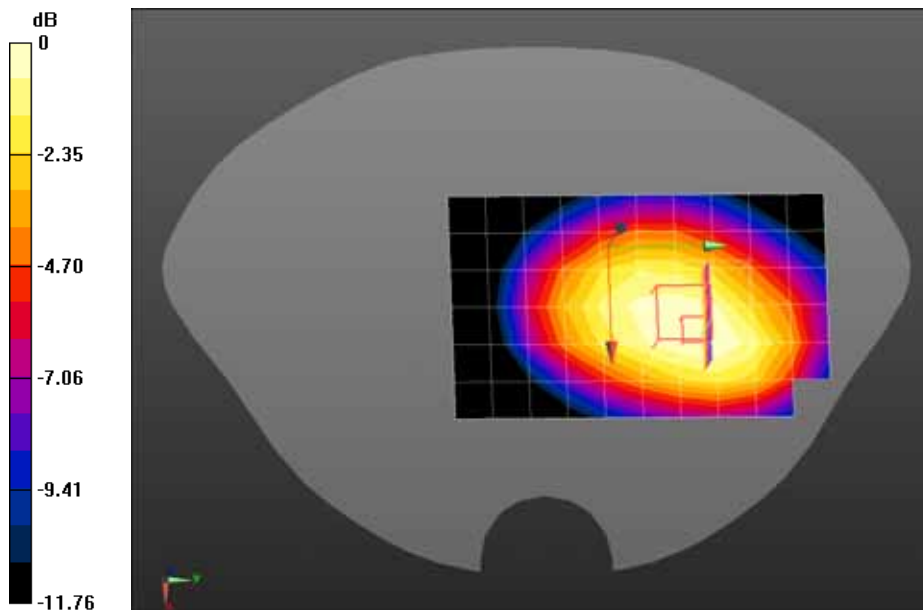

0 dB = 0.437 mW/g = -7.19 dB mW/g



Date/Time: 05-06-2013

Test Laboratory: QuieTek Lab

WCDMA Band V Mid Body-Bottom

**DUT: Smartphone ; Type: 9788**

Communication System: UMTS; Communication System Band: Band V UTRA/FDD; Duty Cycle: 1:1;  
 Frequency: 836.4 MHz; Medium parameters used:  $f = 836.4$  MHz;  $\sigma = 0.97$  mho/m;  $\epsilon_r = 52.88$ ;  $\rho = 1000$  kg/m<sup>3</sup> ; Phantom section: Flat Section

Ambient temperature (°C): 21.5, Liquid temperature (°C): 21.0

DASY5 Configuration:

- Probe: EX3DV4 - SN3710; ConvF(9.41, 9.41, 9.41); Calibrated: 27/03/2013;
- Sensor-Surface: 4mm (Mechanical Surface Detection)
- Electronics: DAE4 Sn1220; Calibrated: 24/01/2013
- Phantom: SAM1; Type: SAM; Serial: TP1561
- Measurement SW: DASY52, Version 52.8 (1); SEMCAD X Version 14.6.5 (6469)

**Configuration/WCDMA Band V Mid Body-Right side/Area Scan (7x7x1):** Measurement grid: dx=15mm, dy=15mm, Maximum value of SAR (measured) = 0.0815 mW/g

**Configuration/WCDMA Band V Mid Body-Right side/Zoom Scan (5x5x7)/Cube 0:** Measurement grid: dx=8mm, dy=8mm, dz=5mm, Reference Value = 6.873 V/m; Power Drift = 0.20 dB

Peak SAR (extrapolated) = 0.150 mW/g

**SAR(1 g) = 0.088 mW/g; SAR(10 g) = 0.052 mW/g** Maximum value of SAR (measured) = 0.0935 mW/g

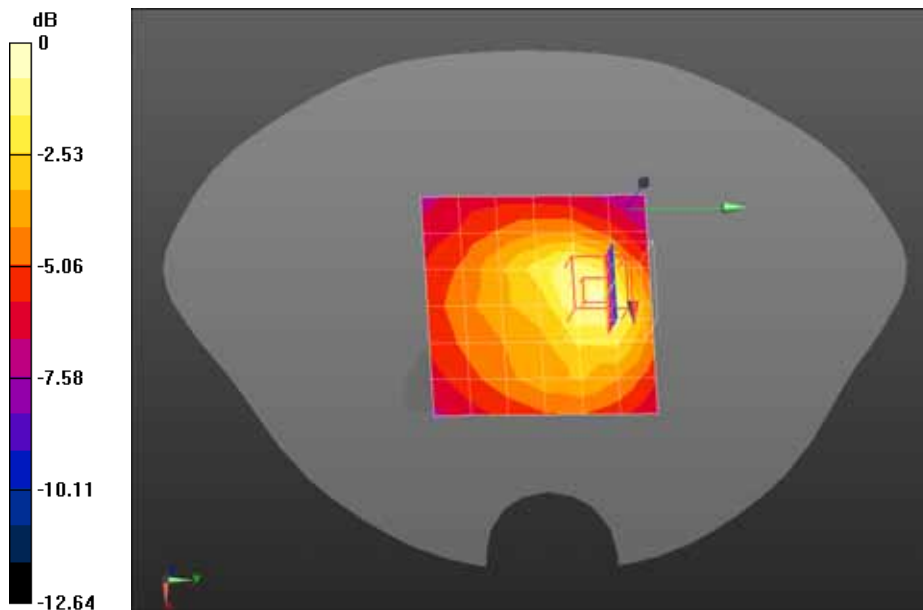

0 dB = 0.0935 mW/g = -20.58 dB mW/g

Date/Time: 05-06-2013

Test Laboratory: QuieTek Lab

WCDMA Band V Mid Body-Left side

**DUT: Smartphone ; Type: 9788**

Communication System: UMTS; Communication System Band: Band V UTRA/FDD; Duty Cycle: 1:1;  
 Frequency: 836.4 MHz; Medium parameters used:  $f = 836.4$  MHz;  $\sigma = 0.97$  mho/m;  $\epsilon_r = 52.88$ ;  $\rho = 1000$  kg/m<sup>3</sup> ; Phantom section: Flat Section

Ambient temperature (°C): 21.5, Liquid temperature (°C): 21.0

DASY5 Configuration:

- Probe: EX3DV4 - SN3710; ConvF(9.41, 9.41, 9.41); Calibrated: 27/03/2013;
- Sensor-Surface: 4mm (Mechanical Surface Detection)
- Electronics: DAE4 Sn1220; Calibrated: 24/01/2013
- Phantom: SAM1; Type: SAM; Serial: TP1561
- Measurement SW: DASY52, Version 52.8 (1); SEMCAD X Version 14.6.5 (6469)

**Configuration/WCDMA Band V Mid Body-Left side/Area Scan (7x11x1):** Measurement grid: dx=15mm, dy=15mm, Maximum value of SAR (measured) = 0.126 mW/g

**Configuration/WCDMA Band V Mid Body-Left side/Zoom Scan (5x5x7)/Cube 0:** Measurement grid: dx=8mm, dy=8mm, dz=5mm, Reference Value = 5.412 V/m; Power Drift = -0.20 dB  
 Peak SAR (extrapolated) = 0.189 mW/g

**SAR(1 g) = 0.130 mW/g; SAR(10 g) = 0.088 mW/g** Maximum value of SAR (measured) = 0.138 mW/g

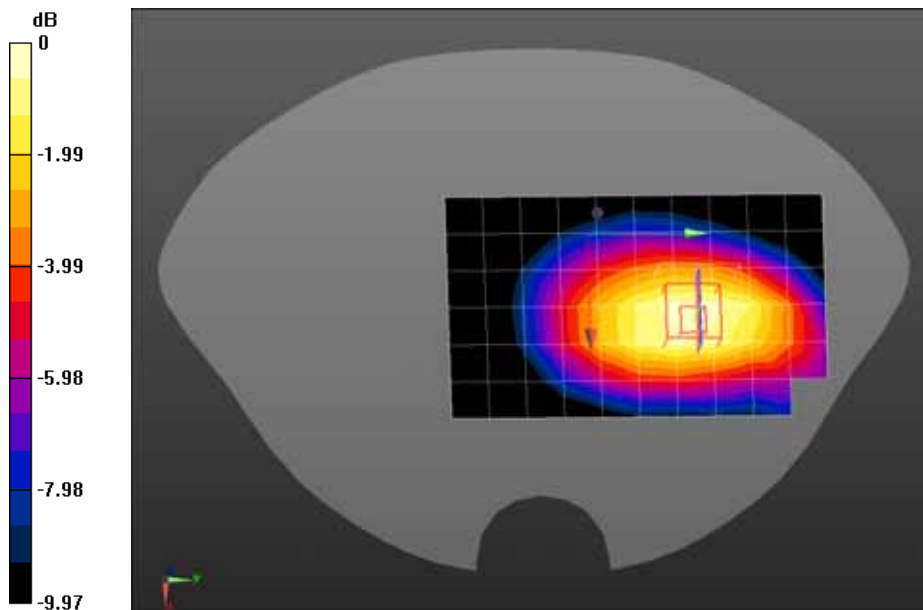

0 dB = 0.138 mW/g = -17.20 dB mW/g

Date/Time: 05-06-2013

Test Laboratory: QuieTek Lab

WCDMA Band V Mid Body-Right side

**DUT: Smartphone ; Type: 9788**

Communication System: UMTS; Communication System Band: Band V UTRA/FDD; Duty Cycle: 1:1;  
 Frequency: 836.4 MHz; Medium parameters used:  $f = 836.4$  MHz;  $\sigma = 0.97$  mho/m;  $\epsilon_r = 52.88$ ;  $\rho = 1000$  kg/m<sup>3</sup>; Phantom section: Flat Section

Ambient temperature (°C): 21.5, Liquid temperature (°C): 21.0

DASY5 Configuration:

- Probe: EX3DV4 - SN3710; ConvF(9.41, 9.41, 9.41); Calibrated: 27/03/2013;
- Sensor-Surface: 4mm (Mechanical Surface Detection)
- Electronics: DAE4 Sn1220; Calibrated: 24/01/2013
- Phantom: SAM1; Type: SAM; Serial: TP1561
- Measurement SW: DASY52, Version 52.8 (1); SEMCAD X Version 14.6.5 (6469)

**Configuration/WCDMA Band V Mid Body-Right side/Area Scan (7x11x1):** Measurement grid: dx=15mm, dy=15mm, Maximum value of SAR (measured) = 0.411 mW/g

**Configuration/WCDMA Band V Mid Body-Right side/Zoom Scan (5x5x7)/Cube 0:** Measurement grid: dx=8mm, dy=8mm, dz=5mm, Reference Value = 8.651 V/m; Power Drift = 0.15 dB  
 Peak SAR (extrapolated) = 0.557 mW/g

**SAR(1 g) = 0.396 mW/g; SAR(10 g) = 0.274 mW/g** Maximum value of SAR (measured) = 0.423 mW/g

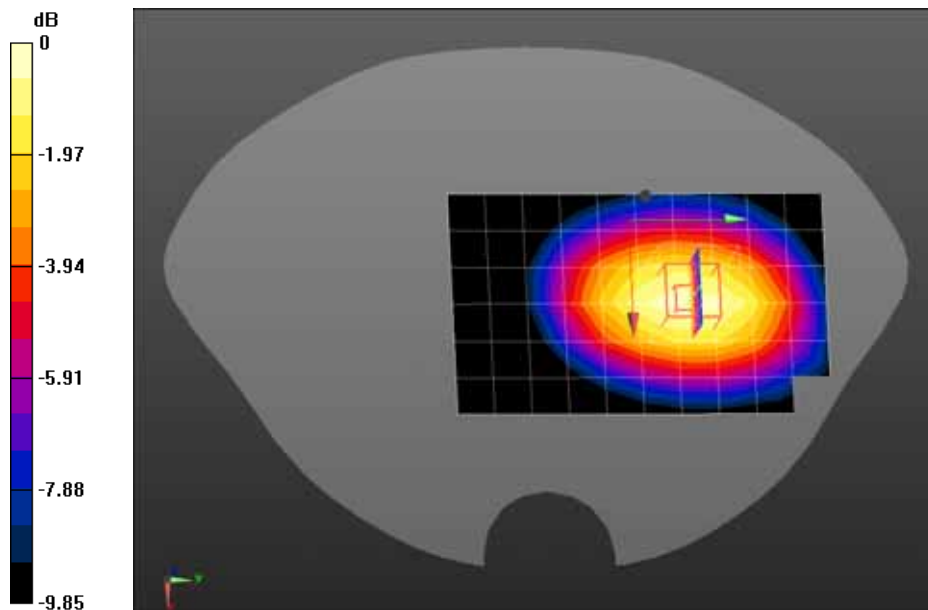

0 dB = 0.423 mW/g = -7.47 dB mW/g

Date/Time: 05-06-2013

Test Laboratory: QuieTek Lab

802.11b 2437MHz Touch-Left

**DUT: Smartphone ; Type: 9788**

Communication System: Wi-Fi; Communication System Band: 802.11b; Duty Cycle: 1:1; Frequency: 2437 MHz; Medium parameters used:  $f = 2437$  MHz;  $\sigma = 1.84$  mho/m;  $\epsilon_r = 38.11$ ;  $\rho = 1000$  kg/m<sup>3</sup>; Phantom section: Left Section

Ambient temperature (°C): 21.5, Liquid temperature (°C): 21.0

DASY5 Configuration:

- Probe: EX3DV4 - SN3710; ConvF(7.03, 7.03, 7.03); Calibrated: 27/03/2013;
- Sensor-Surface: 4mm (Mechanical Surface Detection)
- Electronics: DAE4 Sn1220; Calibrated: 24/01/2013
- Phantom: SAM1; Type: SAM; Serial: TP1561
- Measurement SW: DASY52, Version 52.8 (1); SEMCAD X Version 14.6.5 (6469)

**Configuration/802.11b 2437MHz Touch-Left/Area Scan (7x11x1):** Measurement grid: dx=15mm, dy=15mm, Maximum value of SAR (measured) = 0.00331 mW/g

**Configuration/802.11b 2437MHz Touch-Left/Zoom Scan (5x5x7)/Cube 0:** Measurement grid: dx=8mm, dy=8mm, dz=5mm, Reference Value = 1.532 V/m; Power Drift = -0.12 dB

Peak SAR (extrapolated) = 0.012 mW/g

**SAR(1 g) = 0.00348 mW/g; SAR(10 g) = 0.00102 mW/g** Maximum value of SAR (measured) = 0.00343 mW/g

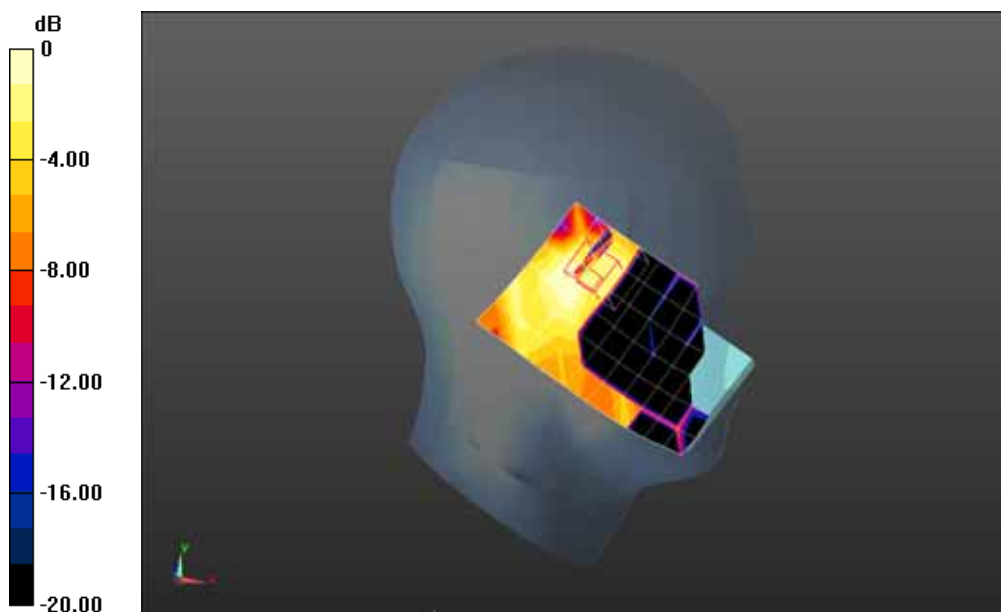

0 dB = 0.00343 mW/g = -49.29 dB mW/g

Date/Time: 05-06-2013

Test Laboratory: QuieTek Lab

802.11b 2437MHz Tilt-Left

**DUT: Smartphone ; Type: 9788**

Communication System: Wi-Fi; Communication System Band: 802.11b; Duty Cycle: 1:1; Frequency: 2437 MHz; Medium parameters used:  $f = 2437$  MHz;  $\sigma = 1.84$  mho/m;  $\epsilon_r = 38.11$ ;  $\rho = 1000$  kg/m<sup>3</sup>; Phantom section: Left Section

Ambient temperature (°C): 21.5, Liquid temperature (°C): 21.0

DASY5 Configuration:

- Probe: EX3DV4 - SN3710; ConvF(7.03, 7.03, 7.03); Calibrated: 27/03/2013;
- Sensor-Surface: 4mm (Mechanical Surface Detection)
- Electronics: DAE4 Sn1220; Calibrated: 24/01/2013
- Phantom: SAM1; Type: SAM; Serial: TP1561
- Measurement SW: DASY52, Version 52.8 (1); SEMCAD X Version 14.6.5 (6469)

**Configuration/802.11b 2437MHz Tilt-Left/Area Scan (7x11x1):** Measurement grid: dx=15mm, dy=15mm

Maximum value of SAR (measured) = 0.00424 mW/g

**Configuration/802.11b 2437MHz Tilt-Left/Zoom Scan (5x5x7)/Cube 0:** Measurement grid: dx=8mm,

dy=8mm, dz=5mm, Reference Value = 1.082 V/m; Power Drift = 0.09 dB

Peak SAR (extrapolated) = 0.00384 mW/g

**SAR(1 g) = 0.000131 mW/g; SAR(10 g) = 1.39e-005 mW/g** Maximum value of SAR (measured) = 0.00526 mW/g

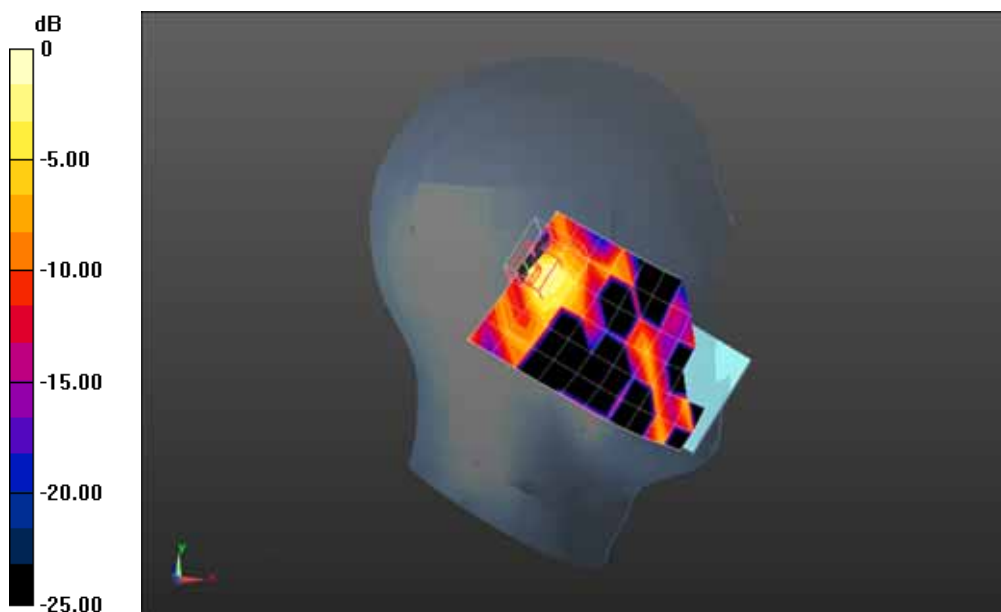

0 dB = 0.00526 mW/g = -45.58 dB mW/g

Date/Time: 05-06-2013

Test Laboratory: QuieTek Lab

802.11b 2437MHz Touch-Right

**DUT: Smartphone ; Type: 9788**

Communication System: Wi-Fi; Communication System Band: 802.11b; Duty Cycle: 1:1; Frequency: 2437 MHz; Medium parameters used:  $f = 2437$  MHz;  $\sigma = 1.84$  mho/m;  $\epsilon_r = 38.11$ ;  $\rho = 1000$  kg/m<sup>3</sup>; Phantom section: Right Section

Ambient temperature (°C): 21.5, Liquid temperature (°C): 21.0

DASY5 Configuration:

- Probe: EX3DV4 - SN3710; ConvF(7.03, 7.03, 7.03); Calibrated: 27/03/2013;
- Sensor-Surface: 4mm (Mechanical Surface Detection)
- Electronics: DAE4 Sn1220; Calibrated: 24/01/2013
- Phantom: SAM1; Type: SAM; Serial: TP1561
- Measurement SW: DASY52, Version 52.8 (1); SEMCAD X Version 14.6.5 (6469)

**Configuration/802.11b 2437MHz Touch-Right/Area Scan (7x11x1):** Measurement grid: dx=15mm, dy=15mm, Maximum value of SAR (measured) = 0.00571 mW/g

**Configuration/802.11b 2437MHz Touch-Right/Zoom Scan (5x5x7)/Cube 0:** Measurement grid: dx=8mm, dy=8mm, dz=5mm, Reference Value = 0.866 V/m; Power Drift = 0.12 dB

Peak SAR (extrapolated) = 0.011 mW/g

**SAR(1 g) = 0.00473 mW/g; SAR(10 g) = 0.00163 mW/g** Maximum value of SAR (measured) = 0.00569 mW/g

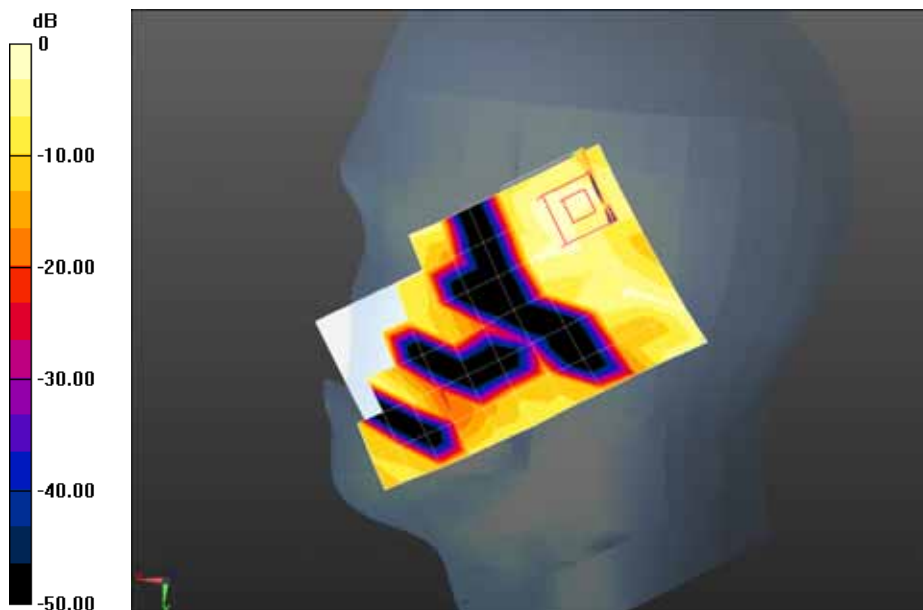

0 dB = 0.00569 mW/g = -44.90 dB mW/g

Date/Time: 05-06-2013

Test Laboratory: QuieTek Lab

802.11b 2437MHz Tilt-Right

**DUT: Smartphone ; Type: 9788**

Communication System: Wi-Fi; Communication System Band: 802.11b; Duty Cycle: 1:1; Frequency: 2437 MHz; Medium parameters used:  $f = 2437$  MHz;  $\sigma = 1.84$  mho/m;  $\epsilon_r = 38.11$ ;  $\rho = 1000$  kg/m<sup>3</sup> ; Phantom section: Right Section

Ambient temperature (°C): 21.5, Liquid temperature (°C): 21.0

DASY5 Configuration:

- Probe: EX3DV4 - SN3710; ConvF(7.03, 7.03, 7.03); Calibrated: 27/03/2013;
- Sensor-Surface: 4mm (Mechanical Surface Detection)
- Electronics: DAE4 Sn1220; Calibrated: 24/01/2013
- Phantom: SAM1; Type: SAM; Serial: TP1561
- Measurement SW: DASY52, Version 52.8 (1); SEMCAD X Version 14.6.5 (6469)

**Configuration/802.11b 2437MHz Tilt-Right/Area Scan (7x11x1):** Measurement grid: dx=15mm, dy=15mm, Maximum value of SAR (measured) = 0.00527 mW/g

**Configuration/802.11b 2437MHz Tilt-Right/Zoom Scan (5x5x7)/Cube 0:** Measurement grid: dx=8mm, dy=8mm, dz=5mm, Reference Value = 0.919 V/m; Power Drift = 0.18 dB

Peak SAR (extrapolated) = 0.011 mW/g

**SAR(1 g) = 0.00236 mW/g; SAR(10 g) = 0.000367 mW/g** Maximum value of SAR (measured) = 0.00602 mW/g

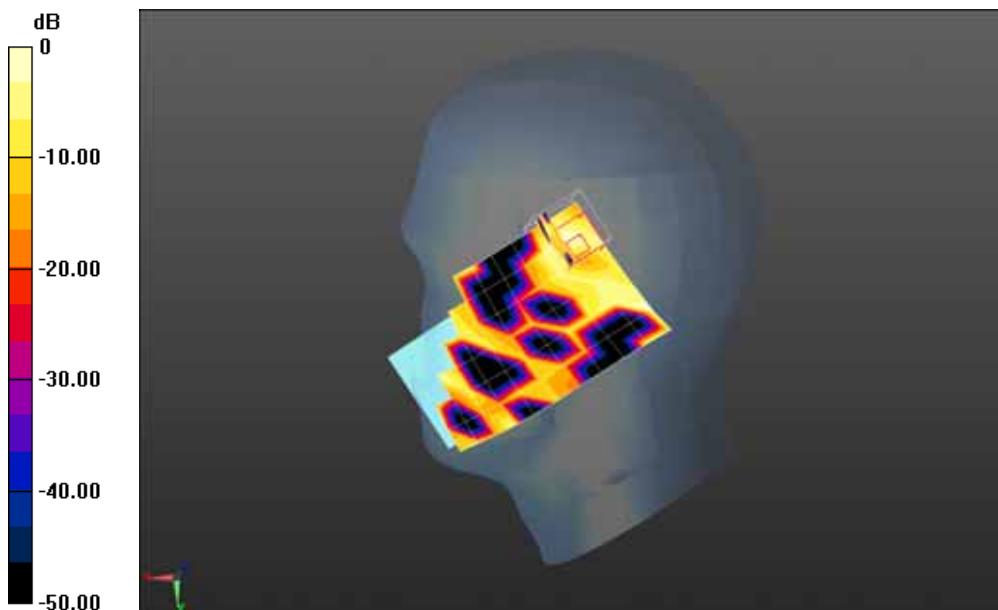

0 dB = 0.00602 mW/g = -44.41 dB mW/g

Date/Time: 05-06-2013

Test Laboratory: QuieTek Lab

802.11b 2437MHz Body-Back

**DUT: Smartphone ; Type: 9788**

Communication System: Wi-Fi; Communication System Band: 802.11b; Duty Cycle: 1:1; Frequency: 2437 MHz; Medium parameters used:  $f = 2437$  MHz;  $\sigma = 1.89$  mho/m;  $\epsilon_r = 53.36$ ;  $\rho = 1000$  kg/m<sup>3</sup>; Phantom section: Flat Section

Ambient temperature (°C): 21.5, Liquid temperature (°C): 21.0

DASY5 Configuration:

- Probe: EX3DV4 - SN3710; ConvF(7.08, 7.08, 7.08); Calibrated: 27/03/2013;
- Sensor-Surface: 4mm (Mechanical Surface Detection)
- Electronics: DAE4 Sn1220; Calibrated: 24/01/2013
- Phantom: SAM2; Type: SAM; Serial: TP1562
- Measurement SW: DASY52, Version 52.8 (1); SEMCAD X Version 14.6.5 (6469)

**Configuration/802.11b 2437MHz Body-Back/Area Scan (7x11x1):** Measurement grid: dx=15mm, dy=15mm, Maximum value of SAR (measured) = 0.0133 mW/g

**Configuration/802.11b 2437MHz Body-Back/Zoom Scan (5x5x7)/Cube 0:** Measurement grid: dx=8mm, dy=8mm, dz=5mm, Reference Value = 1.490 V/m; Power Drift = -0.16 dB

Peak SAR (extrapolated) = 0.024 mW/g

**SAR(1 g) = 0.015 mW/g; SAR(10 g) = 0.00628 mW/g** Maximum value of SAR (measured) = 0.0195 mW/g

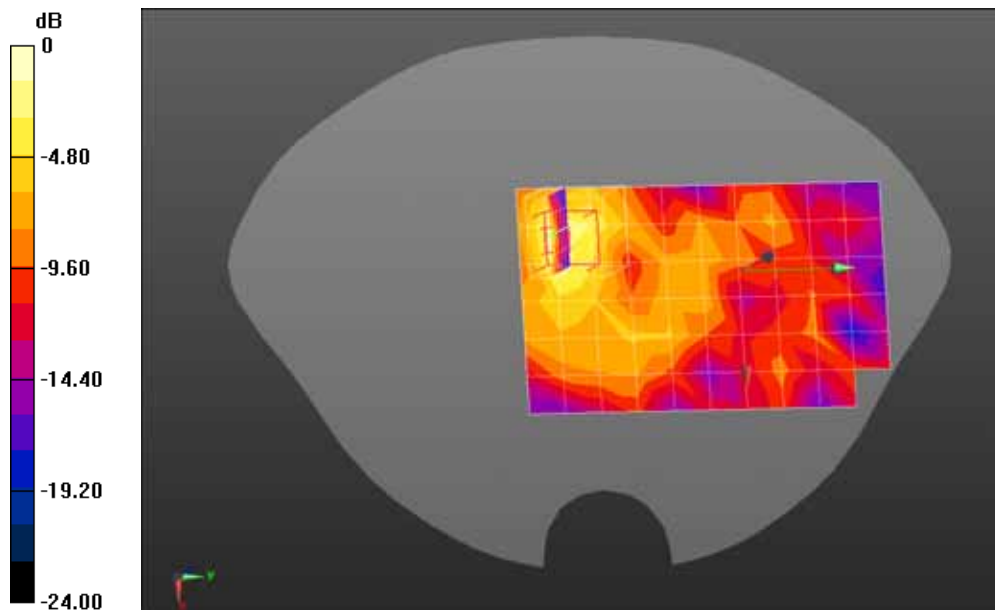

0 dB = 0.0195 mW/g = -34.20 dB mW/g



Z-Axis Plot

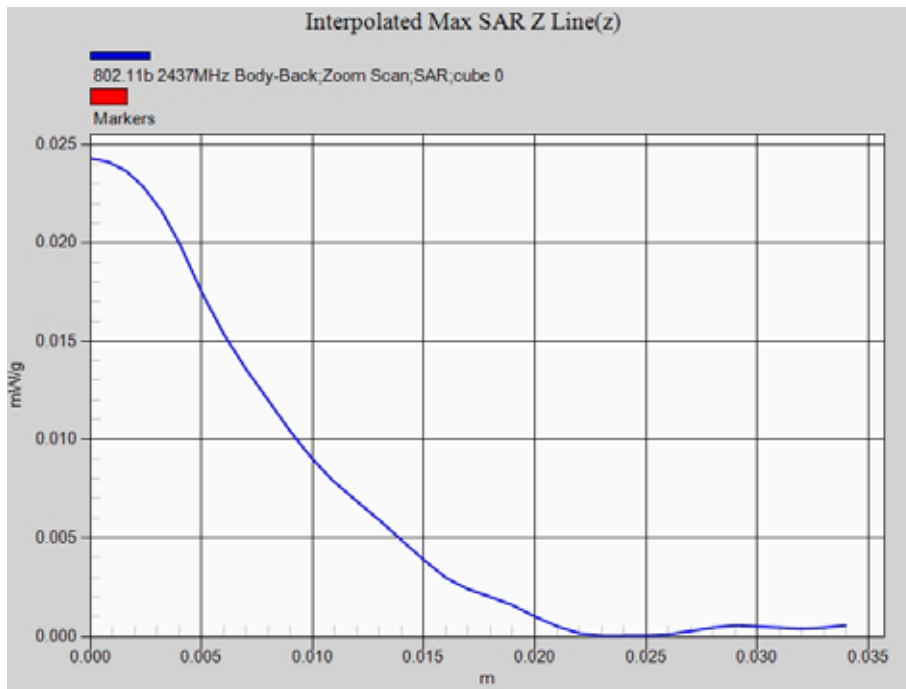

Date/Time: 05-06-2013

Test Laboratory: QuieTek Lab

802.11b 2437MHz Body-Front

**DUT: Smartphone ; Type: 9788**

Communication System: Wi-Fi; Communication System Band: 802.11b; Duty Cycle: 1:1; Frequency: 2437 MHz; Medium parameters used:  $f = 2437$  MHz;  $\sigma = 1.89$  mho/m;  $\epsilon_r = 53.36$ ;  $\rho = 1000$  kg/m<sup>3</sup>; Phantom section: Flat Section

Ambient temperature (°C): 21.5, Liquid temperature (°C): 21.0

DASY5 Configuration:

- Probe: EX3DV4 - SN3710; ConvF(7.08, 7.08, 7.08); Calibrated: 27/03/2013;
- Sensor-Surface: 4mm (Mechanical Surface Detection)
- Electronics: DAE4 Sn1220; Calibrated: 24/01/2013
- Phantom: SAM2; Type: SAM; Serial: TP1562
- Measurement SW: DASY52, Version 52.8 (1); SEMCAD X Version 14.6.5 (6469)

**Configuration/802.11b 2437MHz Body-Front/Area Scan (7x11x1):** Measurement grid: dx=15mm, dy=15mm, Maximum value of SAR (measured) = 0.00188 mW/g

**Configuration/802.11b 2437MHz Body-Front/Zoom Scan (5x5x7)/Cube 0:** Measurement grid: dx=8mm, dy=8mm, dz=5mm, Reference Value = 0.352 V/m; Power Drift = 0.16 dB

Peak SAR (extrapolated) = 0.00393 mW/g

**SAR(1 g) = 0.000607 mW/g; SAR(10 g) = 9.05e-005 mW/g** Maximum value of SAR (measured) = 0.00233 mW/g

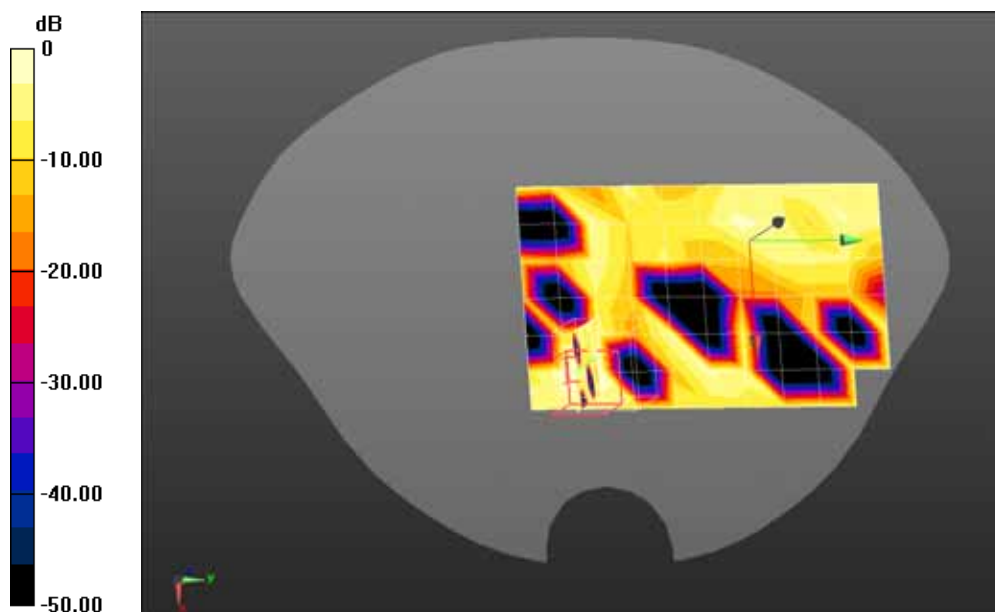

0 dB = 0.00233 mW/g = -52.65 dB mW/g

Date/Time: 05-06-2013

Test Laboratory: QuieTek Lab

802.11b 2437MHz Body-Top

**DUT: Smartphone ; Type: 9788**

Communication System: Wi-Fi; Communication System Band: 802.11b; Duty Cycle: 1:1; Frequency: 2437 MHz; Medium parameters used:  $f = 2437$  MHz;  $\sigma = 1.89$  mho/m;  $\epsilon_r = 53.36$ ;  $\rho = 1000$  kg/m<sup>3</sup>; Phantom section: Flat Section

Ambient temperature (°C): 21.5, Liquid temperature (°C): 21.0

DASY5 Configuration:

- Probe: EX3DV4 - SN3710; ConvF(7.08, 7.08, 7.08); Calibrated: 27/03/2013;
- Sensor-Surface: 4mm (Mechanical Surface Detection)
- Electronics: DAE4 Sn1220; Calibrated: 24/01/2013
- Phantom: SAM2; Type: SAM; Serial: TP1562
- Measurement SW: DASY52, Version 52.8 (1); SEMCAD X Version 14.6.5 (6469)

**Configuration/802.11b 2437MHz Body-Top/Area Scan (5x11x1):** Measurement grid: dx=15mm, dy=15mm, Maximum value of SAR (measured) = 0.00347 mW/g

**Configuration/802.11b 2437MHz Body-Top/Zoom Scan (5x5x7)/Cube 0:** Measurement grid: dx=8mm, dy=8mm, dz=5mm, Reference Value = 1.349 V/m; Power Drift = 0.15 dB

Peak SAR (extrapolated) = 0.012 mW/g

**SAR(1 g) = 0.00401 mW/g; SAR(10 g) = 0.00148 mW/g** Maximum value of SAR (measured) = 0.00438 mW/g

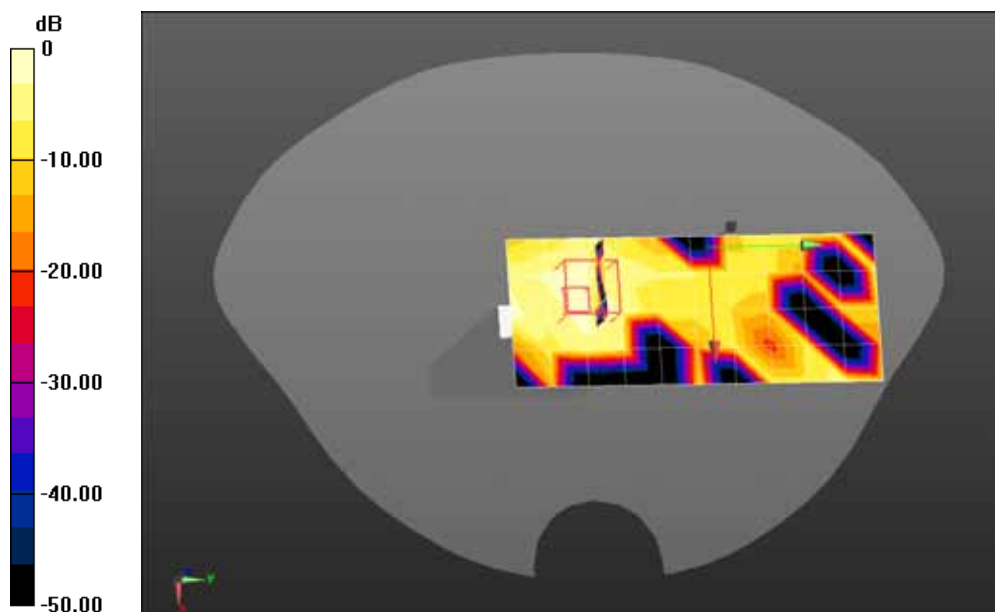

0 dB = 0.00438 mW/g = -47.17 dB mW/g

Date/Time: 05-06-2013

Test Laboratory: QuieTek Lab

802.11b 2437MHz Body-Left side

**DUT: Smartphone ; Type: 9788**

Communication System: Wi-Fi; Communication System Band: 802.11b; Duty Cycle: 1:1; Frequency: 2437 MHz; Medium parameters used:  $f = 2437$  MHz;  $\sigma = 1.89$  mho/m;  $\epsilon_r = 53.36$ ;  $\rho = 1000$  kg/m<sup>3</sup> ; Phantom section: Flat Section

Ambient temperature (°C): 21.5, Liquid temperature (°C): 21.0

DASY5 Configuration:

- Probe: EX3DV4 - SN3710; ConvF(7.08, 7.08, 7.08); Calibrated: 27/03/2013;
- Sensor-Surface: 4mm (Mechanical Surface Detection)
- Electronics: DAE4 Sn1220; Calibrated: 24/01/2013
- Phantom: SAM2; Type: SAM; Serial: TP1562
- Measurement SW: DASY52, Version 52.8 (1); SEMCAD X Version 14.6.5 (6469)

**Configuration/802.11b 2437MHz Body-Left side/Area Scan (5x11x1):** Measurement grid: dx=15mm, dy=15mm, Maximum value of SAR (measured) = 0.00365 mW/g

**Configuration/802.11b 2437MHz Body-Left side/Zoom Scan (5x5x7)/Cube 0:** Measurement grid: dx=8mm, dy=8mm, dz=5mm, Reference Value = 1.256 V/m; Power Drift = -0.04 dB  
Peak SAR (extrapolated) = 0.020 mW/g

**SAR(1 g) = 0.00471 mW/g; SAR(10 g) = 0.00146 mW/g** Maximum value of SAR (measured) = 0.00515 mW/g

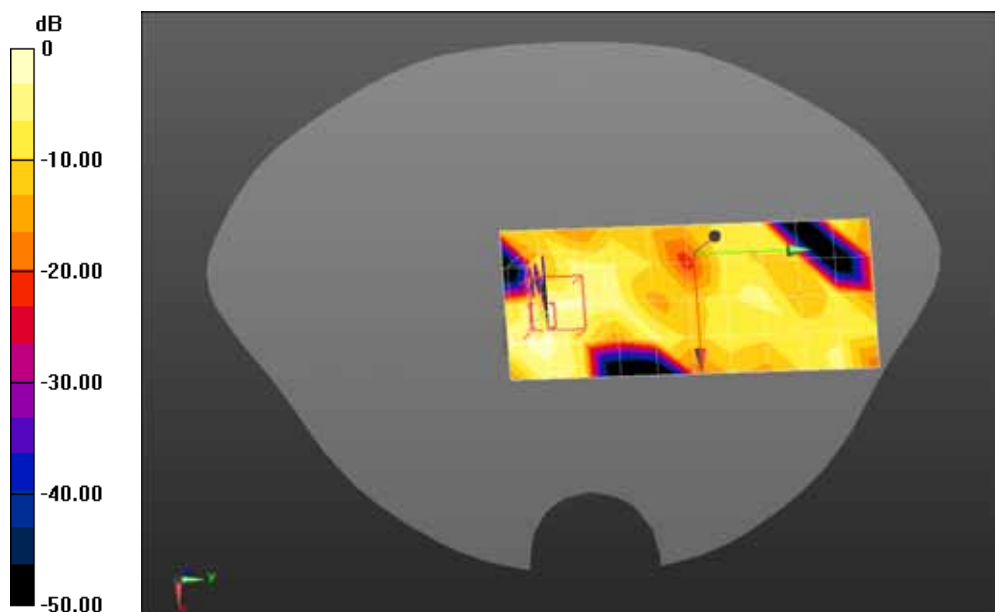

0 dB = 0.00515 mW/g = -45.76 dB mW/g

Appendix C. Test Setup Photographs & EUT Photographs

Test Setup Photographs



Left-Cheek Touch



Left-Tilt 15 °



Right-Cheek Touch



Right-Tilt 15 °



Body SAR Back 10mm



Body SAR Front 10mm

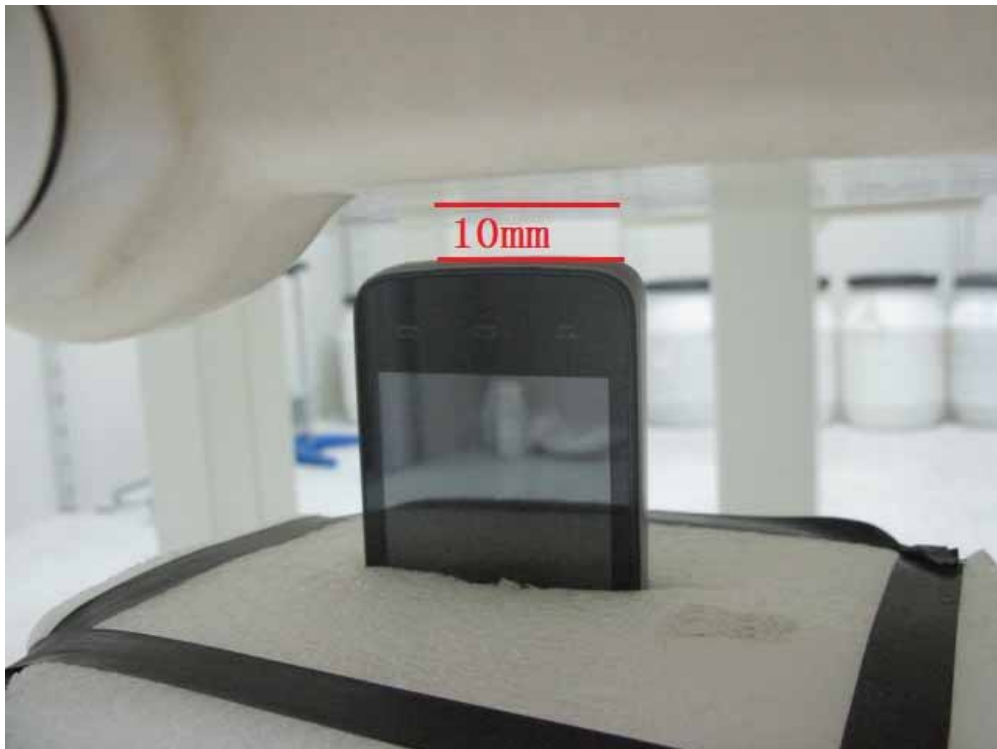

Body SAR Bottom 10mm for GSM/UMTS



Body SAR Right Side 10mm for GSM/UMTS





Body SAR Left Side 10mm for GSM/UMTS

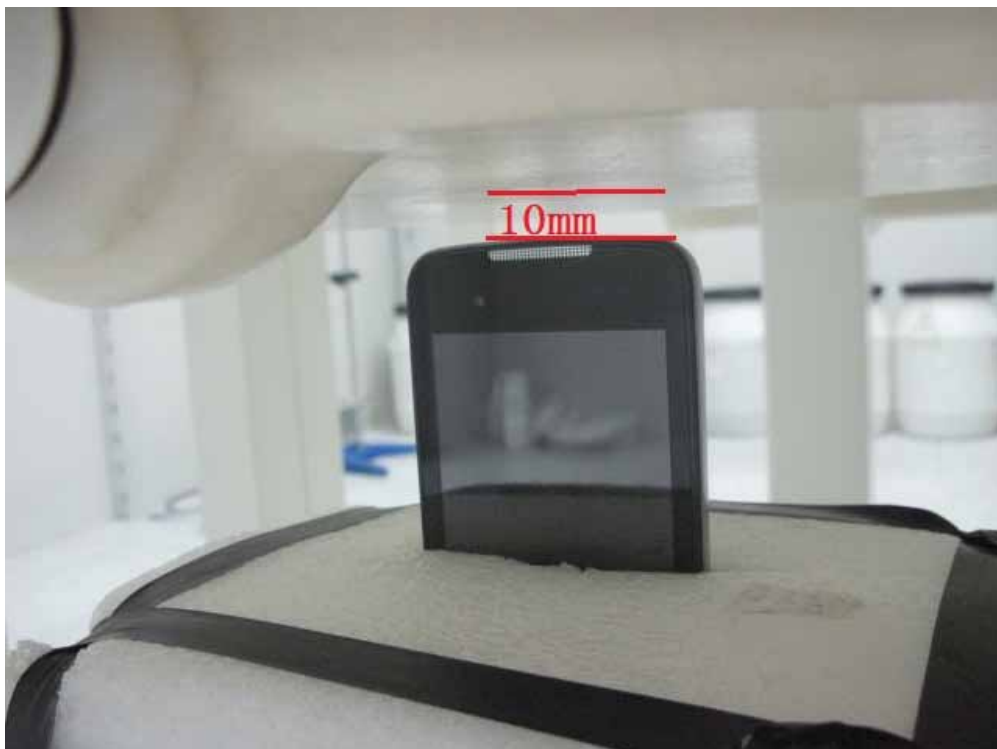

Body SAR Top 10mm for Wi-Fi



Body SAR Left Side 10mm for Wi-Fi

**Depth of the liquid in the phantom – Zoom in**

Note: The position used in the measurements were according to IEEE 1528 - 2003

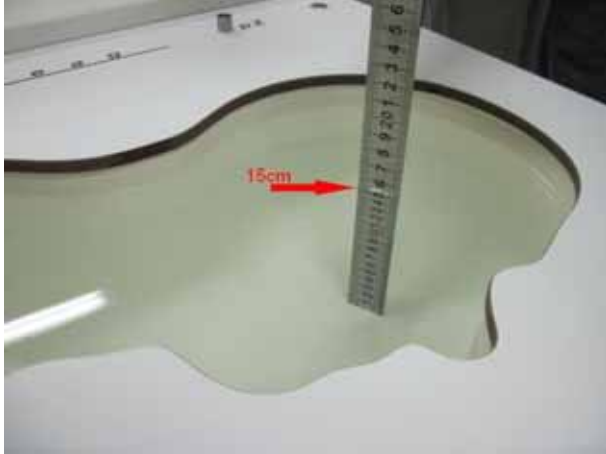

EUT Photographs

(1) EUT Photo



(2) EUT Photo



(3) EUT Photo

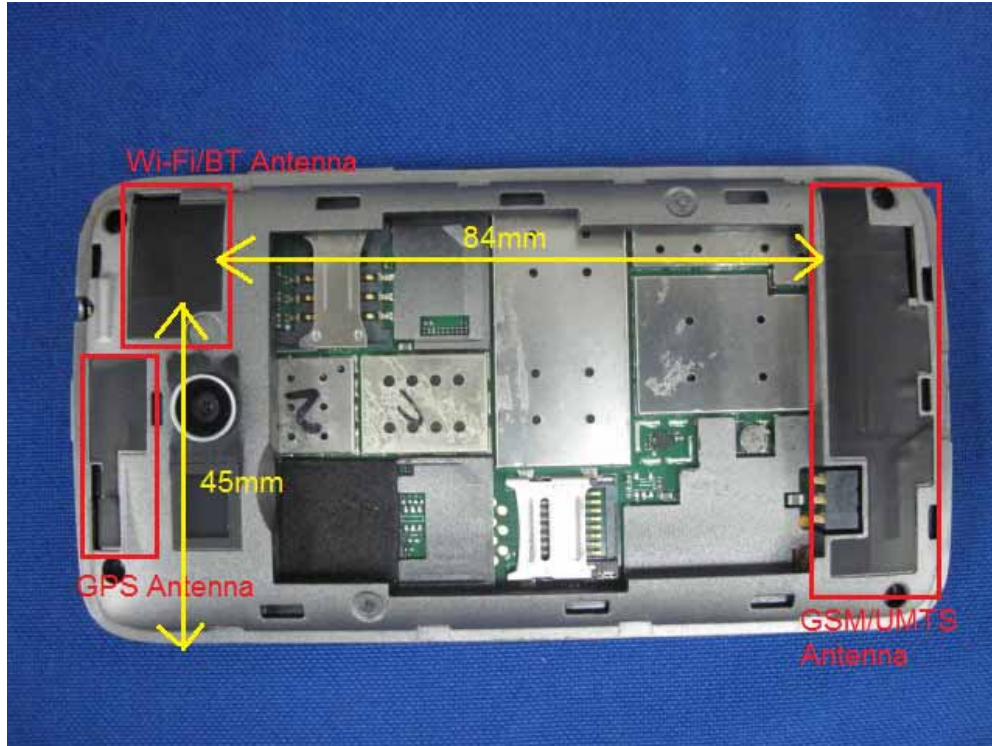



**Appendix D. Probe Calibration Data**

**Calibration Laboratory of  
Schmid & Partner  
Engineering AG**  
Zeughausstrasse 43, 8004 Zurich, Switzerland



**S** Schweizerischer Kalibrierdienst  
**C** Service suisse d'étalonnage  
**S** Servizio svizzero di taratura  
**S** Swiss Calibration Service

Accredited by the Swiss Accreditation Service (SAS)  
The Swiss Accreditation Service is one of the signatories to the EA  
Multilateral Agreement for the recognition of calibration certificates

Accreditation No.: **SCS 108**

Client **Quietek-CN (Auden)**

Certificate No. **EX3-3710\_Mar13**

<b>CALIBRATION CERTIFICATE</b>	
Object	EX3DV4 - SN:3710
Calibration procedure(s)	QA CAL-01.v8, QA CAL-12.v7, QA CAL-14.v3, QA CAL-25.v4, QA CAL-25.v4 Calibration procedure for dosimetric E-field probes
Calibration date:	March 27, 2013
This calibration certificate documents the traceability to national standards, which realize the physical units of measurements (SI). The measurements and the uncertainties with confidence probability are given on the following pages and are part of the certificate.	
All calibrations have been conducted in the closed laboratory facility, environment temperature (22 ± 3)°C and humidity < 70%.	
Calibration Equipment used (M&TE critical for calibration)	

Primary Standards	ID	Cal Date (Certificate No.)	Scheduled Calibration
Power meter E4419B	GB41293874	29-Mar-12 (No. 217-01508)	Apr-13
Power sensor E4412A	MY41498087	29-Mar-12 (No. 217-01508)	Apr-13
Reference 3 dB Attenuator	SN: S5054 (3c)	27-Mar-12 (No. 217-01531)	Apr-13
Reference 20 dB Attenuator	SN: S5086 (20c)	27-Mar-12 (No. 217-01528)	Apr-13
Reference 30 dB Attenuator	SN: S5128 (30c)	27-Mar-12 (No. 217-01532)	Apr-13
Reference Probe ES3DV2	SN: 3013	28-Dec-12 (No. ES1-3013_Dec12)	Dec-13
DAE4	SN: 660	31-Jan-13 (No. DAE4-660_Jan13)	Jan-14
Secondary Standards	ID	Check Date (in house)	Scheduled Check
RF generator HP 8648C	US3842U01700	4-Aug-99 (in house check Apr-11)	In house check: Apr-13
Network Analyzer HP 8753E	US37390585	18-Oct-01 (in house check Oct-12)	In house check: Oct-13

Calibrated by:	Name Claudio Leubler	Function Laboratory Technician	Signature 
Approved by:	Name Katja Pokovic	Function Technical Manager	Signature 
			Issued: April 2, 2013
This calibration certificate shall not be reproduced except in full without written approval of the laboratory.			

**Calibration Laboratory of  
Schmid & Partner  
Engineering AG**  
Zeughausstrasse 43, 8004 Zurich, Switzerland



**S** Schweizerischer Kalibrierdienst  
**C** Service suisse d'étalonnage  
**S** Servizio svizzero di taratura  
**S** Swiss Calibration Service

Accredited by the Swiss Accreditation Service (SAS)  
The Swiss Accreditation Service is one of the signatories to the EA  
Multilateral Agreement for the recognition of calibration certificates

Accreditation No.: **SCS 108**

### Glossary:

TSL	tissue simulating liquid
NORM <sub>x,y,z</sub>	sensitivity in free space
ConvF	sensitivity in TSL / NORM <sub>x,y,z</sub>
DCP	diode compression point
CF	crest factor (1/duty_cycle) of the RF signal
A, B, C, D	modulation dependent linearization parameters
Polarization $\varphi$	$\varphi$ rotation around probe axis
Polarization $\theta$	$\theta$ rotation around an axis that is in the plane normal to probe axis (at measurement center), i.e., $\theta = 0$ is normal to probe axis

### Calibration is Performed According to the Following Standards:

- IEEE Std 1528-2003, "IEEE Recommended Practice for Determining the Peak Spatial-Averaged Specific Absorption Rate (SAR) in the Human Head from Wireless Communications Devices: Measurement Techniques", December 2003
- IEC 62209-1, "Procedure to measure the Specific Absorption Rate (SAR) for hand-held devices used in close proximity to the ear (frequency range of 300 MHz to 3 GHz)", February 2005

### Methods Applied and Interpretation of Parameters:

- NORM<sub>x,y,z</sub>:** Assessed for E-field polarization  $\theta = 0$  ( $f \leq 900$  MHz in TEM-cell;  $f > 1800$  MHz: R22 waveguide). NORM<sub>x,y,z</sub> are only intermediate values, i.e., the uncertainties of NORM<sub>x,y,z</sub> does not affect the E<sup>2</sup>-field uncertainty inside TSL (see below ConvF).
- NORM(f)<sub>x,y,z</sub> = NORM<sub>x,y,z</sub> \* frequency\_response** (see Frequency Response Chart). This linearization is implemented in DASY4 software versions later than 4.2. The uncertainty of the frequency response is included in the stated uncertainty of ConvF.
- DCP<sub>x,y,z</sub>:** DCP are numerical linearization parameters assessed based on the data of power sweep with CW signal (no uncertainty required). DCP does not depend on frequency nor media.
- PAR:** PAR is the Peak to Average Ratio that is not calibrated but determined based on the signal characteristics
- A<sub>x,y,z</sub>; B<sub>x,y,z</sub>; C<sub>x,y,z</sub>; D<sub>x,y,z</sub>; VR<sub>x,y,z</sub>; A, B, C, D** are numerical linearization parameters assessed based on the data of power sweep for specific modulation signal. The parameters do not depend on frequency nor media. VR is the maximum calibration range expressed in RMS voltage across the diode.
- ConvF and Boundary Effect Parameters:** Assessed in flat phantom using E-field (or Temperature Transfer Standard for  $f \leq 800$  MHz) and inside waveguide using analytical field distributions based on power measurements for  $f > 800$  MHz. The same setups are used for assessment of the parameters applied for boundary compensation (alpha, depth) of which typical uncertainty values are given. These parameters are used in DASY4 software to improve probe accuracy close to the boundary. The sensitivity in TSL corresponds to NORM<sub>x,y,z</sub> \* ConvF whereby the uncertainty corresponds to that given for ConvF. A frequency dependent ConvF is used in DASY version 4.4 and higher which allows extending the validity from  $\pm 50$  MHz to  $\pm 100$  MHz.
- Spherical isotropy (3D deviation from isotropy):** in a field of low gradients realized using a flat phantom exposed by a patch antenna.
- Sensor Offset:** The sensor offset corresponds to the offset of virtual measurement center from the probe tip (on probe axis). No tolerance required.

EX3DV4 – SN:3710

March 27, 2013

# Probe EX3DV4

## SN:3710

Manufactured: July 21, 2009  
Calibrated: March 27, 2013

Calibrated for DASY/EASY Systems  
(Note: non-compatible with DASY2 system!)



EX3DV4- SN:3710

March 27, 2013

## DASY/EASY - Parameters of Probe: EX3DV4 - SN:3710

### Basic Calibration Parameters

	Sensor X	Sensor Y	Sensor Z	Unc (k=2)
Norm ( $\mu\text{V}/(\text{V}/\text{m})^2$ ) <sup>A</sup>	0.51	0.56	0.45	$\pm 10.1\%$
DCP (mV) <sup>B</sup>	101.3	99.6	96.6	

### Modulation Calibration Parameters

UID	Communication System Name		A dB	B dB $\sqrt{\mu\text{V}}$	C	D dB	VR mV	Unc <sup>C</sup> (k=2)
0	CW	X	0.0	0.0	1.0	0.00	159.5	$\pm 2.7\%$
		Y	0.0	0.0	1.0		182.9	
		Z	0.0	0.0	1.0		159.4	

The reported uncertainty of measurement is stated as the standard uncertainty of measurement multiplied by the coverage factor k=2, which for a normal distribution corresponds to a coverage probability of approximately 95%.

<sup>A</sup> The uncertainties of NormX,Y,Z do not affect the E<sup>2</sup>-field uncertainty inside TSL (see Pages 5 and 6).

<sup>B</sup> Numerical linearization parameter: uncertainty not required.

<sup>C</sup> Uncertainty is determined using the max. deviation from linear response applying rectangular distribution and is expressed for the square of the field value.

EX3DV4- SN:3710

March 27, 2013

## DASY/EASY - Parameters of Probe: EX3DV4 - SN:3710

### Calibration Parameter Determined in Head Tissue Simulating Media

f (MHz) <sup>c</sup>	Relative Permittivity <sup>f</sup>	Conductivity (Sim) <sup>f</sup>	ConvF X	ConvF Y	ConvF Z	Alpha	Depth (mm)	Unct. (k=2)
450	43.5	0.87	9.87	9.87	9.87	0.14	1.30	± 13.4 %
750	41.9	0.89	9.94	9.94	9.94	0.29	0.99	± 12.0 %
835	41.5	0.90	9.52	9.52	9.52	0.39	0.83	± 12.0 %
900	41.5	0.97	9.50	9.50	9.50	0.70	0.63	± 12.0 %
1810	40.0	1.40	7.75	7.75	7.75	0.66	0.63	± 12.0 %
1950	40.0	1.40	7.47	7.47	7.47	0.75	0.59	± 12.0 %
2450	39.2	1.80	7.03	7.03	7.03	0.63	0.64	± 12.0 %
2600	39.0	1.96	6.83	6.83	6.83	0.50	0.74	± 12.0 %
3500	37.9	2.91	6.81	6.81	6.81	0.82	0.73	± 13.1 %
5200	36.0	4.66	4.86	4.86	4.86	0.45	1.80	± 13.1 %
5300	35.9	4.76	4.74	4.74	4.74	0.45	1.80	± 13.1 %
5500	35.6	4.96	4.50	4.50	4.50	0.50	1.80	± 13.1 %
5600	35.5	5.07	4.42	4.42	4.42	0.45	1.80	± 13.1 %
5800	35.3	5.27	4.43	4.43	4.43	0.50	1.80	± 13.1 %

<sup>c</sup> Frequency validity of ± 100 MHz only applies for DASY v4.4 and higher (see Page 2), else it is restricted to ± 50 MHz. The uncertainty is the RSS of the ConvF uncertainty at calibration frequency and the uncertainty for the indicated frequency band.

<sup>f</sup> At frequencies below 3 GHz, the validity of tissue parameters ( $\epsilon$  and  $\sigma$ ) can be relaxed to ± 10% if liquid compensation formula is applied to measured SAR values. At frequencies above 3 GHz, the validity of tissue parameters ( $\epsilon$  and  $\sigma$ ) is restricted to ± 5%. The uncertainty is the RSS of the ConvF uncertainty for indicated target tissue parameters.

EX3DV4- SN:3710

March 27, 2013

## DASY/EASY - Parameters of Probe: EX3DV4 - SN:3710

### Calibration Parameter Determined in Body Tissue Simulating Media

f (MHz) <sup>c</sup>	Relative Permittivity <sup>f</sup>	Conductivity (S/m) <sup>f</sup>	ConvF X	ConvF Y	ConvF Z	Alpha	Depth (mm)	Unct. (k=2)
450	56.7	0.94	10.89	10.89	10.89	0.05	1.20	± 13.4 %
750	55.5	0.96	9.60	9.60	9.60	0.48	0.83	± 12.0 %
835	55.2	0.97	9.41	9.41	9.41	0.38	0.90	± 12.0 %
900	55.0	1.05	9.30	9.30	9.30	0.80	0.63	± 12.0 %
1810	53.3	1.52	7.60	7.60	7.60	0.42	0.81	± 12.0 %
1950	53.3	1.52	7.62	7.62	7.62	0.34	0.98	± 12.0 %
2450	52.7	1.95	7.08	7.08	7.08	0.76	0.56	± 12.0 %
2600	52.5	2.16	6.88	6.88	6.88	0.80	0.50	± 12.0 %
3500	51.3	3.31	6.38	6.38	6.38	1.00	0.57	± 13.1 %
5200	49.0	5.30	4.32	4.32	4.32	0.45	1.90	± 13.1 %
5300	48.9	5.42	4.16	4.16	4.16	0.45	1.90	± 13.1 %
5500	48.6	5.65	3.87	3.87	3.87	0.50	1.90	± 13.1 %
5600	48.5	5.77	3.89	3.89	3.89	0.40	1.90	± 13.1 %
5800	48.2	6.00	4.05	4.05	4.05	0.50	1.90	± 13.1 %

<sup>c</sup> Frequency validity of ± 100 MHz only applies for DASY v4.4 and higher (see Page 2), else it is restricted to ± 50 MHz. The uncertainty is the RSS of the ConvF uncertainty at calibration frequency and the uncertainty for the indicated frequency band.

<sup>f</sup> At frequencies below 3 GHz, the validity of tissue parameters ( $\epsilon$  and  $\sigma$ ) can be relaxed to ± 10% if liquid compensation formula is applied to measured SAR values. At frequencies above 3 GHz, the validity of tissue parameters ( $\epsilon$  and  $\sigma$ ) is restricted to ± 5%. The uncertainty is the RSS of the ConvF uncertainty for indicated target tissue parameters.

EX30V4-SN:3710

March 27, 2013

### Frequency Response of E-Field (TEM-Cell: if1110 EXX, Waveguide: R22)

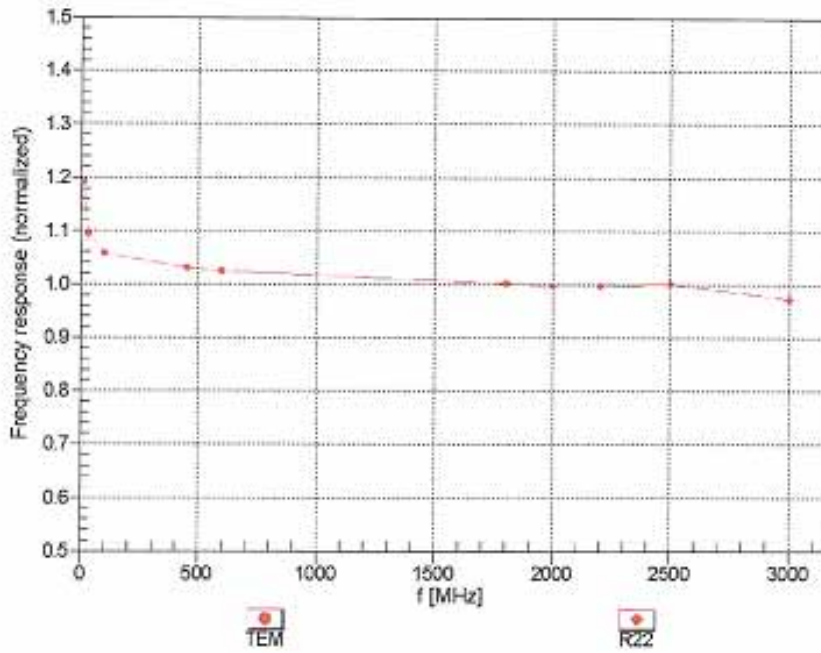

Uncertainty of Frequency Response of E-field:  $\pm 6.3\%$  (k=2)

EX3DV4-SN:3710

March 27, 2013

Receiving Pattern ( $\phi$ ),  $\theta = 0^\circ$

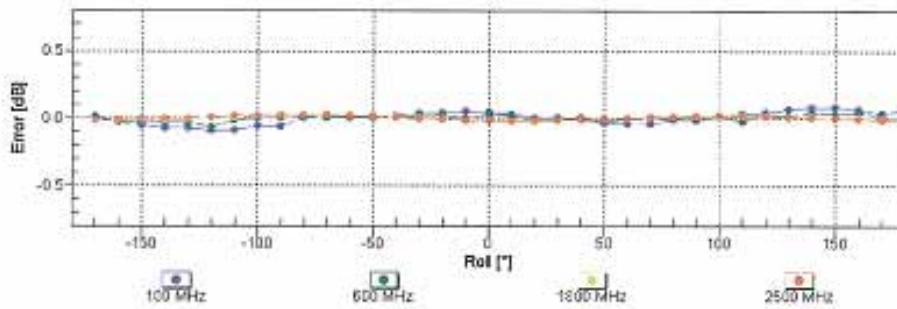
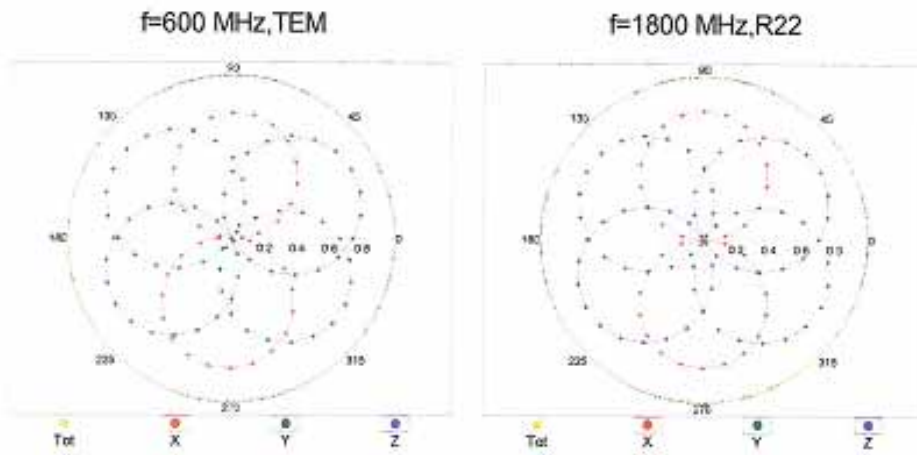

Uncertainty of Axial Isotropy Assessment:  $\pm 0.5\%$  (k=2)

EX3DV4- SN:3710

March 27, 2013

**Dynamic Range f(SAR<sub>head</sub>)**  
(TEM cell , f = 900 MHz)

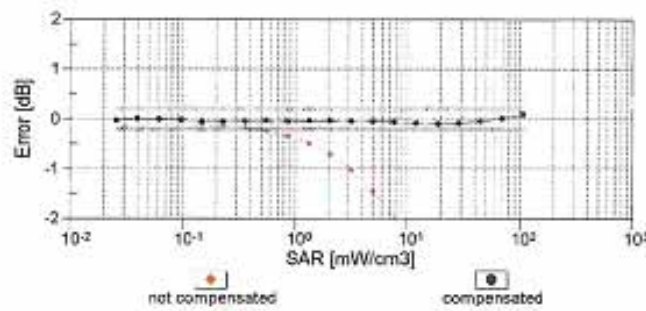
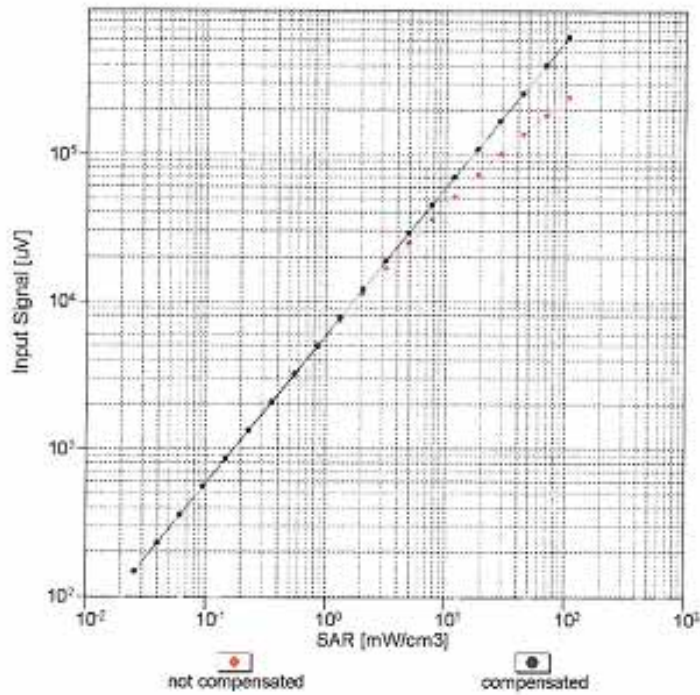

Uncertainty of Linearity Assessment: ± 0.6% (k=2)



EX3DV4- SN:3710

March 27, 2013

### Conversion Factor Assessment

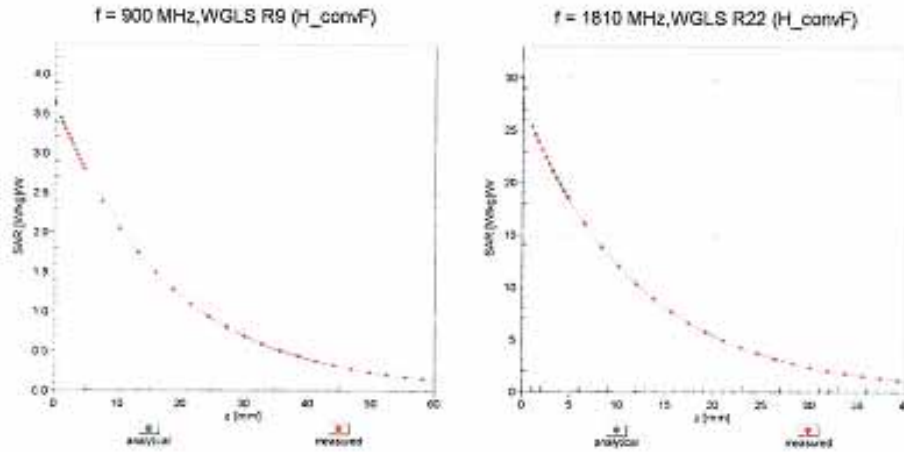

### Deviation from Isotropy in Liquid

Error ( $\phi, \theta$ ),  $f = 900 \text{ MHz}$

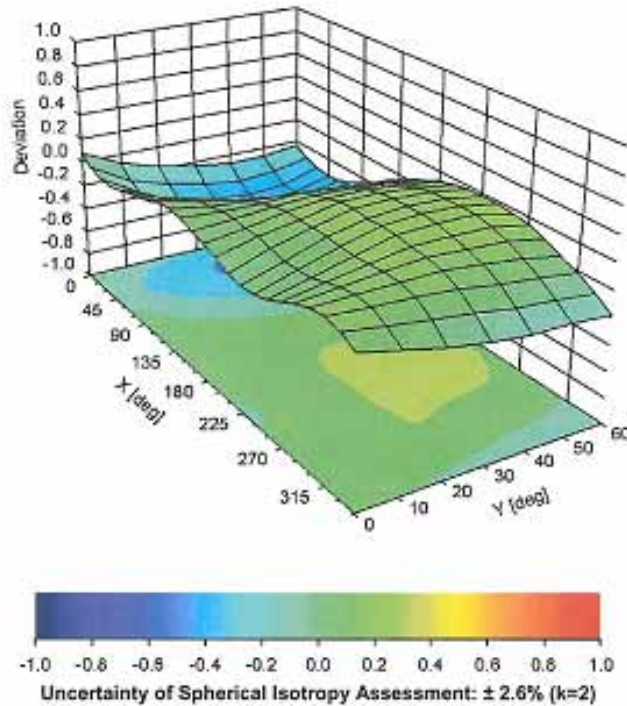

EX3DV4- SN:3710

March 27, 2013

**DASY/EASY - Parameters of Probe: EX3DV4 - SN:3710**

**Other Probe Parameters**

Sensor Arrangement	Triangular
Connector Angle (°)	-20.2
Mechanical Surface Detection Mode	enabled
Optical Surface Detection Mode	disabled
Probe Overall Length	337 mm
Probe Body Diameter	10 mm
Tip Length	9 mm
Tip Diameter	2.5 mm
Probe Tip to Sensor X Calibration Point	1 mm
Probe Tip to Sensor Y Calibration Point	1 mm
Probe Tip to Sensor Z Calibration Point	1 mm
Recommended Measurement Distance from Surface	2 mm



**Appendix E. Dipole Calibration Data**

**Calibration Laboratory of  
Schmid & Partner  
Engineering AG**  
Zeughausstrasse 43, 8004 Zurich, Switzerland



**S** Schweizerischer Kalibrierdienst  
**S** Service suisse d'étalonnage  
**C** Servizio svizzero di taratura  
**S** Swiss Calibration Service

Accredited by the Swiss Accreditation Service (SAS)  
The Swiss Accreditation Service is one of the signatories to the EA  
Multilateral Agreement for the recognition of calibration certificates

Accreditation No.: **SCS 108**

Client: **Quietek-CN (Auden)**

Certificate No: **D835V2-4d094\_Feb12**

CALIBRATION CERTIFICATE																																															
Objekt	D835V2 - SN: 4d094																																														
Calibration procedure(s)	QA CAL-05.v8 Calibration procedure for dipole validation kits above 700 MHz																																														
Calibration date:	February 17, 2012																																														
<p>This calibration certificate documents the traceability to national standards, which realize the physical units of measurements (SI). The measurements and the uncertainties with confidence probability are given on the following pages and are part of the certificate.</p> <p>All calibrations have been conducted in the closed laboratory facility; environment temperature (22 ± 3)°C and humidity &lt; 70%.</p> <p>Calibration Equipment used (M&amp;TE critical for calibration)</p> <table border="1"> <thead> <tr> <th>Primary Standards</th> <th>ID #</th> <th>Cal Date (Certificate No.)</th> <th>Scheduled Calibration</th> </tr> </thead> <tbody> <tr> <td>Power meter EPM-442A</td> <td>GB37480704</td> <td>05-Oct-11 (No. 217-01451)</td> <td>Oct-12</td> </tr> <tr> <td>Power sensor HP 8481A</td> <td>US37292783</td> <td>05-Oct-11 (No. 217-01451)</td> <td>Oct-12</td> </tr> <tr> <td>Reference 20 dB Attenuator</td> <td>SN: 5086 (20g)</td> <td>29-Mar-11 (No. 217-01368)</td> <td>Apr-12</td> </tr> <tr> <td>Type-N mismatch combination</td> <td>SN: 5047.2 / 06327</td> <td>29-Mar-11 (No. 217-01371)</td> <td>Apr-12</td> </tr> <tr> <td>Reference Probe ES3DV3</td> <td>SN: 3205</td> <td>30-Dec-11 (No. ES3-3205_Dec11)</td> <td>Dec-12</td> </tr> <tr> <td>DAE4</td> <td>SN: 601</td> <td>04-Jul-11 (No. DAE4-601_Jul11)</td> <td>Jul-12</td> </tr> </tbody> </table> <table border="1"> <thead> <tr> <th>Secondary Standards</th> <th>ID #</th> <th>Check Date (in house)</th> <th>Scheduled Check</th> </tr> </thead> <tbody> <tr> <td>Power sensor HP 8481A</td> <td>MY41092317</td> <td>18-Oct-02 (in house check Oct-11)</td> <td>In house check: Oct-13</td> </tr> <tr> <td>RF generator R&amp;S SMT-06</td> <td>100005</td> <td>04-Aug-99 (in house check Oct-11)</td> <td>In house check: Oct-13</td> </tr> <tr> <td>Network Analyzer HP 8753E</td> <td>US37390585 S4206</td> <td>18-Oct-01 (in house check Oct-11)</td> <td>In house check: Oct-12</td> </tr> </tbody> </table>				Primary Standards	ID #	Cal Date (Certificate No.)	Scheduled Calibration	Power meter EPM-442A	GB37480704	05-Oct-11 (No. 217-01451)	Oct-12	Power sensor HP 8481A	US37292783	05-Oct-11 (No. 217-01451)	Oct-12	Reference 20 dB Attenuator	SN: 5086 (20g)	29-Mar-11 (No. 217-01368)	Apr-12	Type-N mismatch combination	SN: 5047.2 / 06327	29-Mar-11 (No. 217-01371)	Apr-12	Reference Probe ES3DV3	SN: 3205	30-Dec-11 (No. ES3-3205_Dec11)	Dec-12	DAE4	SN: 601	04-Jul-11 (No. DAE4-601_Jul11)	Jul-12	Secondary Standards	ID #	Check Date (in house)	Scheduled Check	Power sensor HP 8481A	MY41092317	18-Oct-02 (in house check Oct-11)	In house check: Oct-13	RF generator R&S SMT-06	100005	04-Aug-99 (in house check Oct-11)	In house check: Oct-13	Network Analyzer HP 8753E	US37390585 S4206	18-Oct-01 (in house check Oct-11)	In house check: Oct-12
Primary Standards	ID #	Cal Date (Certificate No.)	Scheduled Calibration																																												
Power meter EPM-442A	GB37480704	05-Oct-11 (No. 217-01451)	Oct-12																																												
Power sensor HP 8481A	US37292783	05-Oct-11 (No. 217-01451)	Oct-12																																												
Reference 20 dB Attenuator	SN: 5086 (20g)	29-Mar-11 (No. 217-01368)	Apr-12																																												
Type-N mismatch combination	SN: 5047.2 / 06327	29-Mar-11 (No. 217-01371)	Apr-12																																												
Reference Probe ES3DV3	SN: 3205	30-Dec-11 (No. ES3-3205_Dec11)	Dec-12																																												
DAE4	SN: 601	04-Jul-11 (No. DAE4-601_Jul11)	Jul-12																																												
Secondary Standards	ID #	Check Date (in house)	Scheduled Check																																												
Power sensor HP 8481A	MY41092317	18-Oct-02 (in house check Oct-11)	In house check: Oct-13																																												
RF generator R&S SMT-06	100005	04-Aug-99 (in house check Oct-11)	In house check: Oct-13																																												
Network Analyzer HP 8753E	US37390585 S4206	18-Oct-01 (in house check Oct-11)	In house check: Oct-12																																												
Calibrated by:	Name Israe El-Naouq	Function Laboratory Technician	Signature 																																												
Approved by:	Katja Pokovic	Technical Manager																																													
Issued: February 17, 2012																																															
This calibration certificate shall not be reproduced except in full without written approval of the laboratory.																																															

**Calibration Laboratory of  
Schmid & Partner  
Engineering AG**  
Zeughausstrasse 43, 8004 Zurich, Switzerland



**S** Schweizerischer Kalibrierdienst  
**C** Service suisse d'étalonnage  
**S** Servizio svizzero di taratura  
**S** Swiss Calibration Service

Accredited by the Swiss Accreditation Service (SAS)  
The Swiss Accreditation Service is one of the signatories to the EA  
Multilateral Agreement for the recognition of calibration certificates

Accreditation No.: **SCS 108**

**Glossary:**

TSL	tissue simulating liquid
ConvF	sensitivity in TSL / NORM x,y,z
N/A	not applicable or not measured

**Calibration is Performed According to the Following Standards:**

- a) IEEE Std 1528-2003, "IEEE Recommended Practice for Determining the Peak Spatial-Averaged Specific Absorption Rate (SAR) in the Human Head from Wireless Communications Devices: Measurement Techniques", December 2003
- b) IEC 62209-1, "Procedure to measure the Specific Absorption Rate (SAR) for hand-held devices used in close proximity to the ear (frequency range of 300 MHz to 3 GHz)", February 2005
- c) Federal Communications Commission Office of Engineering & Technology (FCC OET), "Evaluating Compliance with FCC Guidelines for Human Exposure to Radiofrequency Electromagnetic Fields; Additional Information for Evaluating Compliance of Mobile and Portable Devices with FCC Limits for Human Exposure to Radiofrequency Emissions", Supplement C (Edition 01-01) to Bulletin 65

**Additional Documentation:**

- d) DASY4/5 System Handbook

**Methods Applied and Interpretation of Parameters:**

- *Measurement Conditions:* Further details are available from the Validation Report at the end of the certificate. All figures stated in the certificate are valid at the frequency indicated.
- *Antenna Parameters with TSL:* The dipole is mounted with the spacer to position its feed point exactly below the center marking of the flat phantom section, with the arms oriented parallel to the body axis.
- *Feed Point Impedance and Return Loss:* These parameters are measured with the dipole positioned under the liquid filled phantom. The impedance stated is transformed from the measurement at the SMA connector to the feed point. The Return Loss ensures low reflected power. No uncertainty required.
- *Electrical Delay:* One-way delay between the SMA connector and the antenna feed point. No uncertainty required.
- *SAR measured:* SAR measured at the stated antenna input power.
- *SAR normalized:* SAR as measured, normalized to an input power of 1 W at the antenna connector.
- *SAR for nominal TSL parameters:* The measured TSL parameters are used to calculate the nominal SAR result.

**Measurement Conditions**

DASY system configuration, as far as not given on page 1.

DASY Version	DASY5	V52.8.0
Extrapolation	Advanced Extrapolation	
Phantom	Modular Flat Phantom	
Distance Dipole Center - TSL	15 mm	with Spacer
Zoom Scan Resolution	dx, dy, dz = 5 mm	
Frequency	835 MHz ± 1 MHz	

**Head TSL parameters**

The following parameters and calculations were applied.

	Temperature	Permittivity	Conductivity
Nominal Head TSL parameters	22.0 °C	41.5	0.90 mho/m
Measured Head TSL parameters	(22.0 ± 0.2) °C	41.0 ± 6 %	0.89 mho/m ± 6 %
Head TSL temperature change during test	< 0.5 °C	----	----

**SAR result with Head TSL**

SAR averaged over 1 cm <sup>3</sup> (1 g) of Head TSL	Condition	
SAR measured	250 mW input power	2.34 mW / g
SAR for nominal Head TSL parameters	normalized to 1W	9.41 mW /g ± 17.0 % (k=2)

SAR averaged over 10 cm <sup>3</sup> (10 g) of Head TSL	condition	
SAR measured	250 mW input power	1.53 mW / g
SAR for nominal Head TSL parameters	normalized to 1W	6.15 mW /g ± 16.5 % (k=2)

**Body TSL parameters**

The following parameters and calculations were applied.

	Temperature	Permittivity	Conductivity
Nominal Body TSL parameters	22.0 °C	55.2	0.97 mho/m
Measured Body TSL parameters	(22.0 ± 0.2) °C	55.7 ± 6 %	1.01 mho/m ± 6 %
Body TSL temperature change during test	< 0.5 °C	----	----

**SAR result with Body TSL**

SAR averaged over 1 cm <sup>3</sup> (1 g) of Body TSL	Condition	
SAR measured	250 mW input power	2.46 mW / g
SAR for nominal Body TSL parameters	normalized to 1W	9.57 mW / g ± 17.0 % (k=2)

SAR averaged over 10 cm <sup>3</sup> (10 g) of Body TSL	condition	
SAR measured	250 mW input power	1.62 mW / g
SAR for nominal Body TSL parameters	normalized to 1W	6.33 mW / g ± 16.5 % (k=2)

**Appendix**

**Antenna Parameters with Head TSL**

Impedance, transformed to feed point	53.5 $\Omega$ - 2.0 j $\Omega$
Return Loss	- 28.1 dB

**Antenna Parameters with Body TSL**

Impedance, transformed to feed point	47.7 $\Omega$ - 5.3 j $\Omega$
Return Loss	- 24.5 dB

**General Antenna Parameters and Design**

Electrical Delay (one direction)	1.387 ns
----------------------------------	----------

After long term use with 100W radiated power, only a slight warming of the dipole near the feedpoint can be measured.

The dipole is made of standard semirigid coaxial cable. The center conductor of the feeding line is directly connected to the second arm of the dipole. The antenna is therefore short-circuited for DC-signals. On some of the dipoles, small end caps are added to the dipole arms in order to improve matching when loaded according to the position as explained in the "Measurement Conditions" paragraph. The SAR data are not affected by this change. The overall dipole length is still according to the Standard.

No excessive force must be applied to the dipole arms, because they might bend or the soldered connections near the feedpoint may be damaged.

**Additional EUT Data**

Manufactured by	SPEAG
Manufactured on	September 15, 2009



## DASY5 Validation Report for Head TSL

Date: 17.02.2012

Test Laboratory: SPEAG, Zurich, Switzerland

**DUT: Dipole 835 MHz; Type: D835V2; Serial: D835V2 - SN: 4d094**

Communication System: CW; Frequency: 835 MHz

Medium parameters used:  $f = 835$  MHz;  $\sigma = 0.89$  mho/m;  $\epsilon_r = 41$ ;  $\rho = 1000$  kg/m<sup>3</sup>

Phantom section: Flat Section

Measurement Standard: DASY5 (IEEE/IEC/ANSI C63.19-2007)

DASY52 Configuration:

- Probe: ES3DV3 - SN3205; ConvF(6.07, 6.07, 6.07); Calibrated: 30.12.2011
- Sensor-Surface: 3mm (Mechanical Surface Detection)
- Electronics: DAE4 Sn601; Calibrated: 04.07.2011
- Phantom: Flat Phantom 4.9L; Type: QD000P49AA; Serial: 1001
- DASY52 52.8.0(692); SEMCAD X 14.6.4(4989)

### Dipole Calibration for Head Tissue/Pin=250 mW, d=15mm/Zoom Scan (7x7x7)/Cube 0:

Measurement grid: dx=5mm, dy=5mm, dz=5mm

Reference Value = 57.027 V/m; Power Drift = 0.02 dB

Peak SAR (extrapolated) = 3.4380

**SAR(1 g) = 2.34 mW/g; SAR(10 g) = 1.53 mW/g**

Maximum value of SAR (measured) = 2.712 mW/g

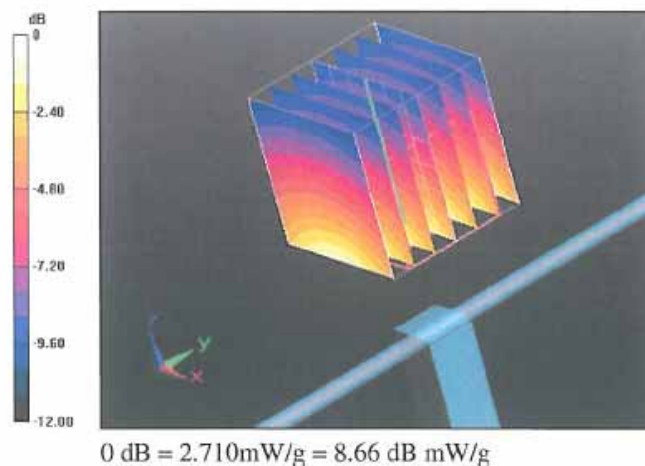

Impedance Measurement Plot for Head TSL

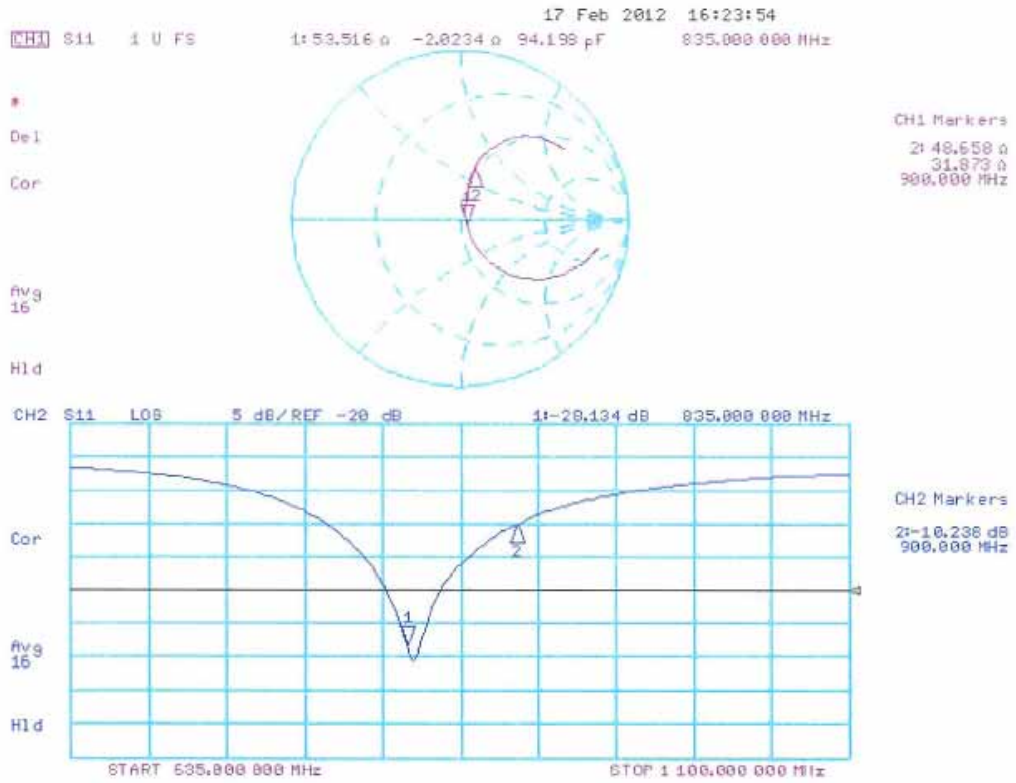

## DASY5 Validation Report for Body TSL

Date: 17.02.2012

Test Laboratory: SPEAG, Zurich, Switzerland

**DUT: Dipole 835 MHz; Type: D835V2; Serial: D835V2 - SN: 4d094**

Communication System: CW; Frequency: 835 MHz

Medium parameters used:  $f = 835$  MHz;  $\sigma = 1.01$  mho/m;  $\epsilon_r = 55.7$ ;  $\rho = 1000$  kg/m<sup>3</sup>

Phantom section: Flat Section

Measurement Standard: DASY5 (IEEE/IEC/ANSI C63.19-2007)

DASY52 Configuration:

- Probe: ES3DV3 - SN3205; ConvF(6.02, 6.02, 6.02); Calibrated: 30.12.2011
- Sensor-Surface: 3mm (Mechanical Surface Detection)
- Electronics: DAE4 Sn601; Calibrated: 04.07.2011
- Phantom: Flat Phantom 4.9L; Type: QD000P49AA; Serial: 1001
- DASY52 52.8.0(692); SEMCAD X 14.6.4(4989)

### Dipole Calibration for Body Tissue/Pin=250 mW, d=15mm/Zoom Scan (7x7x7)/Cube 0:

Measurement grid: dx=5mm, dy=5mm, dz=5mm

Reference Value = 55.114 V/m; Power Drift = 0.0041 dB

Peak SAR (extrapolated) = 3.5590

**SAR(1 g) = 2.46 mW/g; SAR(10 g) = 1.62 mW/g**

Maximum value of SAR (measured) = 2.861 mW/g

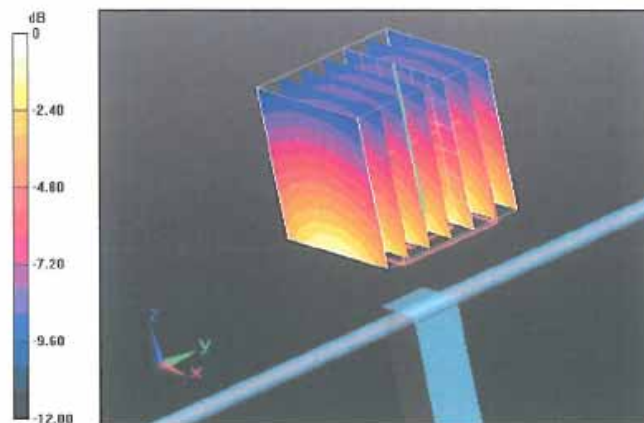

0 dB = 2.860mW/g = 9.13 dB mW/g

Impedance Measurement Plot for Body TSL

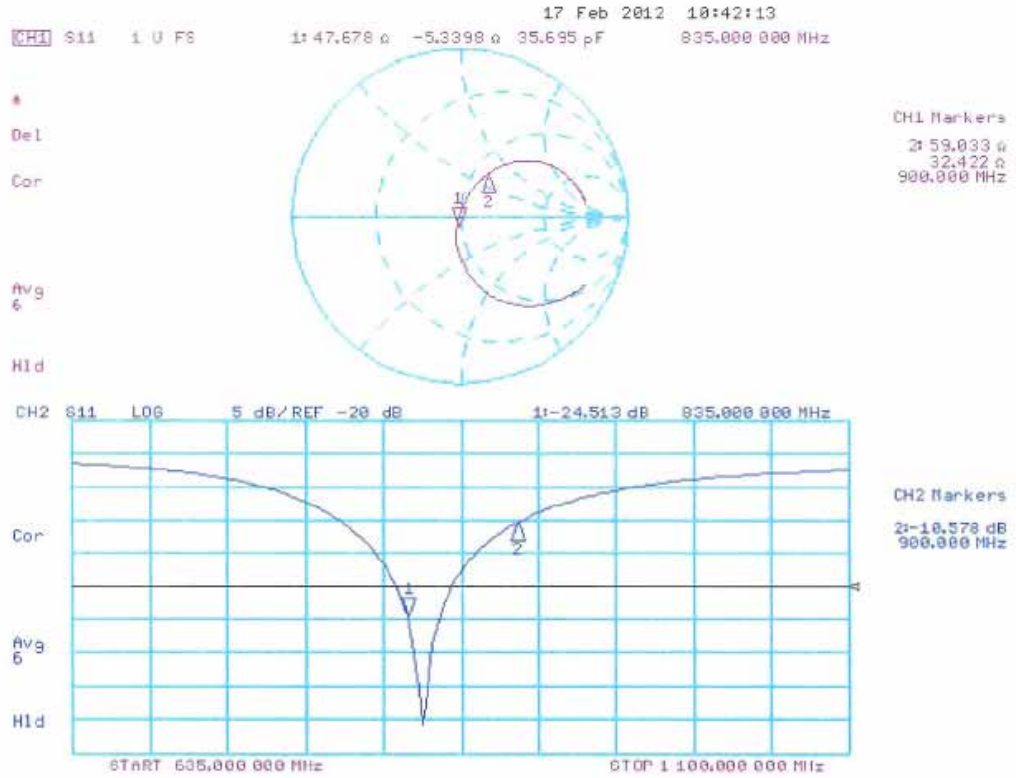



**Calibration Laboratory of  
Schmid & Partner  
Engineering AG**  
Zeughausstrasse 43, 8004 Zurich, Switzerland



**S** Schweizerischer Kalibrierdienst  
**C** Service suisse d'étalonnage  
**S** Servizio svizzero di taratura  
**S** Swiss Calibration Service

Accredited by the Swiss Accreditation Service (SAS)  
The Swiss Accreditation Service is one of the signatories to the EA  
Multilateral Agreement for the recognition of calibration certificates

Accreditation No.: **SCS 108**

Client **Quietek-CN (Auden)**

Certificate No: **D1800V2-2d179\_Feb12**

## CALIBRATION CERTIFICATE

Object: **D1800V2 - SN: 2d179**

Calibration procedure(s): **QA CAL-05.v8  
Calibration procedure for dipole validation kits above 700 MHz**

Calibration date: **February 22, 2012**

This calibration certificate documents the traceability to national standards, which realize the physical units of measurements (SI).  
The measurements and the uncertainties with confidence probability are given on the following pages and are part of the certificate.

All calibrations have been conducted in the closed laboratory facility: environment temperature (22 ± 3)°C and humidity < 70%.

Calibration Equipment used (M&TE critical for calibration)

Primary Standards	ID #	Cal Date (Certificate No.)	Scheduled Calibration
Power meter EPM-442A	GB37480704	05-Oct-11 (No. 217-01451)	Oct-12
Power sensor HP 8481A	US37292783	05-Oct-11 (No. 217-01451)	Oct-12
Reference 20 dB Attenuator	SN: 5086 (20g)	29-Mar-11 (No. 217-01368)	Apr-12
Type-N mismatch combination	SN: 5047.2 / 06327	29-Mar-11 (No. 217-01371)	Apr-12
Reference Probe ES3DV3	SN: 3205	30-Dec-11 (No. ES3-3205_Dec11)	Dec-12
DAE4	SN: 601	04-Jul-11 (No. DAE4-601_Jul11)	Jul-12
Secondary Standards	ID #	Check Date (in house)	Scheduled Check
Power sensor HP 8481A	MY41092317	18-Oct-02 (in house check Oct-11)	In house check: Oct-13
RF generator R&S SMT-06	100005	04-Aug-99 (in house check Oct-11)	In house check: Oct-13
Network Analyzer HP 8753E	US37390585 S4206	18-Oct-01 (in house check Oct-11)	In house check: Oct-12

	Name	Function	Signature
Calibrated by:	Israe El-Naouq	Laboratory Technician	
Approved by:	Katja Pokovic	Technical Manager	

Issued: February 22, 2012

This calibration certificate shall not be reproduced except in full without written approval of the laboratory.

**Calibration Laboratory of  
Schmid & Partner  
Engineering AG**  
Zeughausstrasse 43, 8004 Zurich, Switzerland



**S** Schweizerischer Kalibrierdienst  
**C** Service suisse d'étalonnage  
**S** Servizio svizzero di taratura  
**S** Swiss Calibration Service

Accredited by the Swiss Accreditation Service (SAS)  
The Swiss Accreditation Service is one of the signatories to the EA  
Multilateral Agreement for the recognition of calibration certificates

Accreditation No.: **SCS 108**

**Glossary:**

TSL	tissue simulating liquid
ConvF	sensitivity in TSL / NORM x,y,z
N/A	not applicable or not measured

**Calibration is Performed According to the Following Standards:**

- a) IEEE Std 1528-2003, "IEEE Recommended Practice for Determining the Peak Spatial-Averaged Specific Absorption Rate (SAR) in the Human Head from Wireless Communications Devices: Measurement Techniques", December 2003
- b) IEC 62209-1, "Procedure to measure the Specific Absorption Rate (SAR) for hand-held devices used in close proximity to the ear (frequency range of 300 MHz to 3 GHz)", February 2005
- c) Federal Communications Commission Office of Engineering & Technology (FCC OET), "Evaluating Compliance with FCC Guidelines for Human Exposure to Radiofrequency Electromagnetic Fields; Additional Information for Evaluating Compliance of Mobile and Portable Devices with FCC Limits for Human Exposure to Radiofrequency Emissions", Supplement C (Edition 01-01) to Bulletin 65

**Additional Documentation:**

- d) DASY4/5 System Handbook

**Methods Applied and Interpretation of Parameters:**

- *Measurement Conditions:* Further details are available from the Validation Report at the end of the certificate. All figures stated in the certificate are valid at the frequency indicated.
- *Antenna Parameters with TSL:* The dipole is mounted with the spacer to position its feed point exactly below the center marking of the flat phantom section, with the arms oriented parallel to the body axis.
- *Feed Point Impedance and Return Loss:* These parameters are measured with the dipole positioned under the liquid filled phantom. The impedance stated is transformed from the measurement at the SMA connector to the feed point. The Return Loss ensures low reflected power. No uncertainty required.
- *Electrical Delay:* One-way delay between the SMA connector and the antenna feed point. No uncertainty required.
- *SAR measured:* SAR measured at the stated antenna input power.
- *SAR normalized:* SAR as measured, normalized to an input power of 1 W at the antenna connector.
- *SAR for nominal TSL parameters:* The measured TSL parameters are used to calculate the nominal SAR result.

**Measurement Conditions**

DASY system configuration, as far as not given on page 1.

DASY Version	DASY5	V52.8.0
Extrapolation	Advanced Extrapolation	
Phantom	Modular Flat Phantom	
Distance Dipole Center - TSL	10 mm	with Spacer
Zoom Scan Resolution	dx, dy, dz = 5 mm	
Frequency	1800 MHz ± 1 MHz	

**Head TSL parameters**

The following parameters and calculations were applied.

	Temperature	Permittivity	Conductivity
Nominal Head TSL parameters	22.0 °C	40.0	1.40 mho/m
Measured Head TSL parameters	(22.0 ± 0.2) °C	40.5 ± 6 %	1.34 mho/m ± 6 %
Head TSL temperature change during test	< 0.5 °C	----	----

**SAR result with Head TSL**

SAR averaged over 1 cm <sup>3</sup> (1 g) of Head TSL	Condition	
SAR measured	250 mW input power	9.17 mW / g
SAR for nominal Head TSL parameters	normalized to 1W	<b>37.8 mW / g ± 17.0 % (k=2)</b>

SAR averaged over 10 cm <sup>3</sup> (10 g) of Head TSL	condition	
SAR measured	250 mW input power	4.91 mW / g
SAR for nominal Head TSL parameters	normalized to 1W	<b>20.0 mW / g ± 16.5 % (k=2)</b>

**Body TSL parameters**

The following parameters and calculations were applied.

	Temperature	Permittivity	Conductivity
Nominal Body TSL parameters	22.0 °C	53.3	1.52 mho/m
Measured Body TSL parameters	(22.0 ± 0.2) °C	53.1 ± 6 %	1.49 mho/m ± 6 %
Body TSL temperature change during test	< 0.5 °C	----	----

**SAR result with Body TSL**

SAR averaged over 1 cm <sup>3</sup> (1 g) of Body TSL	Condition	
SAR measured	250 mW input power	9.27 mW / g
SAR for nominal Body TSL parameters	normalized to 1W	<b>37.5 mW / g ± 17.0 % (k=2)</b>

SAR averaged over 10 cm <sup>3</sup> (10 g) of Body TSL	condition	
SAR measured	250 mW input power	4.92 mW / g
SAR for nominal Body TSL parameters	normalized to 1W	<b>19.8 mW / g ± 16.5 % (k=2)</b>

**Appendix**

**Antenna Parameters with Head TSL**

Impedance, transformed to feed point	50.2 $\Omega$ - 2.9 j $\Omega$
Return Loss	- 30.7 dB

**Antenna Parameters with Body TSL**

Impedance, transformed to feed point	46.1 $\Omega$ - 2.8 j $\Omega$
Return Loss	- 26.0 dB

**General Antenna Parameters and Design**

Electrical Delay (one direction)	1.214 ns
----------------------------------	----------

After long term use with 100W radiated power, only a slight warming of the dipole near the feedpoint can be measured.

The dipole is made of standard semirigid coaxial cable. The center conductor of the feeding line is directly connected to the second arm of the dipole. The antenna is therefore short-circuited for DC-signals. On some of the dipoles, small end caps are added to the dipole arms in order to improve matching when loaded according to the position as explained in the "Measurement Conditions" paragraph. The SAR data are not affected by this change. The overall dipole length is still according to the Standard.

No excessive force must be applied to the dipole arms, because they might bend or the soldered connections near the feedpoint may be damaged.

**Additional EUT Data**

Manufactured by	SPEAG
Manufactured on	September 05, 2008



## DASY5 Validation Report for Head TSL

Date: 22.02.2012

Test Laboratory: SPEAG, Zurich, Switzerland

**DUT: Dipole 1800 MHz; Type: D1800V2; Serial: D1800V2 - SN: 2d179**

Communication System: CW; Frequency: 1800 MHz

Medium parameters used:  $f = 1800$  MHz;  $\sigma = 1.34$  mho/m;  $\epsilon_r = 40.5$ ;  $\rho = 1000$  kg/m<sup>3</sup>

Phantom section: Flat Section

Measurement Standard: DASY5 (IEEE/IEC/ANSI C63.19-2007)

DASY52 Configuration:

- Probe: ES3DV3 - SN3205; ConvF(5.07, 5.07, 5.07); Calibrated: 30.12.2011
- Sensor-Surface: 3mm (Mechanical Surface Detection)
- Electronics: DAE4 Sn601; Calibrated: 04.07.2011
- Phantom: Flat Phantom 5.0 (front); Type: QD000P50AA; Serial: 1001
- DASY52 52.8.0(692); SEMCAD X 14.6.4(4989)

### Dipole Calibration for Head Tissue/Pin=250 mW, d=10mm/Zoom Scan (7x7x7)/Cube 0:

Measurement grid: dx=5mm, dy=5mm, dz=5mm

Reference Value = 95.908 V/m; Power Drift = 0.04 dB

Peak SAR (extrapolated) = 16.0120

**SAR(1 g) = 9.17 mW/g; SAR(10 g) = 4.91 mW/g**

Maximum value of SAR (measured) = 11.315 mW/g

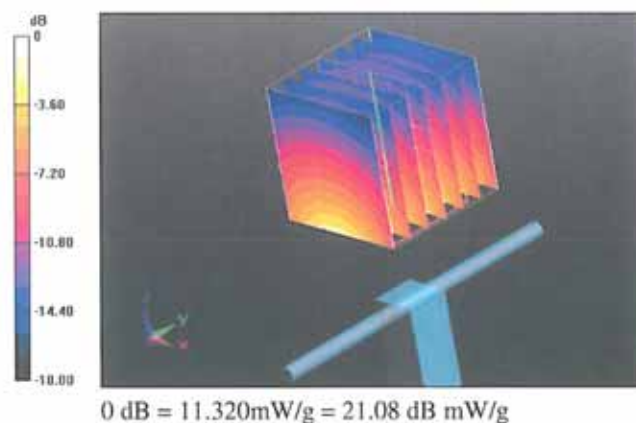

Impedance Measurement Plot for Head TSL

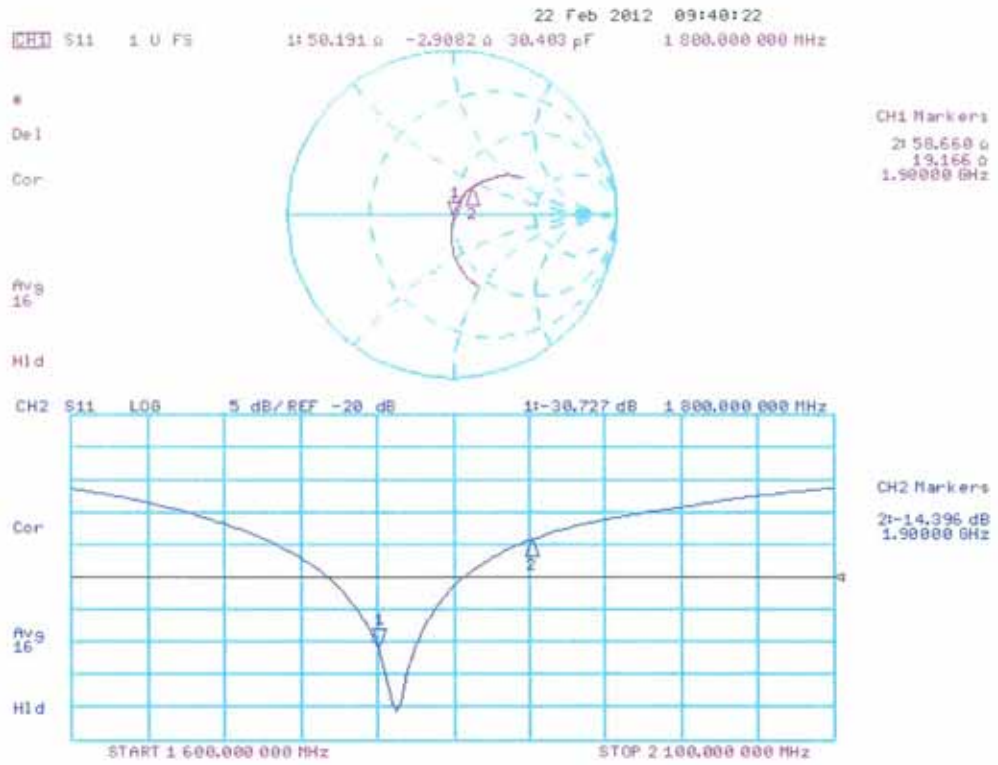

## DASY5 Validation Report for Body TSL

Date: 22.02.2012

Test Laboratory: SPEAG, Zurich, Switzerland

**DUT: Dipole 1800 MHz; Type: D1800V2; Serial: D1800V2 - SN: 2d179**

Communication System: CW; Frequency: 1800 MHz

Medium parameters used:  $f = 1800$  MHz;  $\sigma = 1.49$  mho/m;  $\epsilon_r = 53.1$ ;  $\rho = 1000$  kg/m<sup>3</sup>

Phantom section: Flat Section

Measurement Standard: DASY5 (IEEE/IEC/ANSI C63.19-2007)

DASY52 Configuration:

- Probe: ES3DV3 - SN3205; ConvF(4.74, 4.74, 4.74); Calibrated: 30.12.2011
- Sensor-Surface: 3mm (Mechanical Surface Detection)
- Electronics: DAE4 Sn601; Calibrated: 04.07.2011
- Phantom: Flat Phantom 5.0 (back); Type: QD000P50AA; Serial: 1002
- DASY52 52.8.0(692); SEMCAD X 14.6.4(4989)

### Dipole Calibration for Body Tissue/Pin=250 mW, d=10mm/Zoom Scan (7x7x7)/Cube 0:

Measurement grid: dx=5mm, dy=5mm, dz=5mm

Reference Value = 92.820 V/m; Power Drift = 0.0038 dB

Peak SAR (extrapolated) = 16.0810

**SAR(1 g) = 9.27 mW/g; SAR(10 g) = 4.92 mW/g**

Maximum value of SAR (measured) = 11.751 mW/g

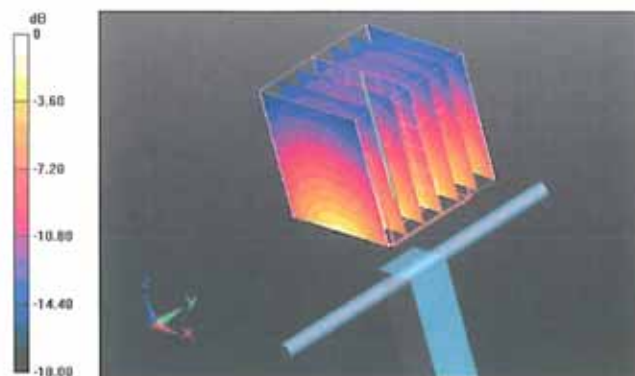

0 dB = 11.750mW/g = 21.40 dB mW/g

Impedance Measurement Plot for Body TSL

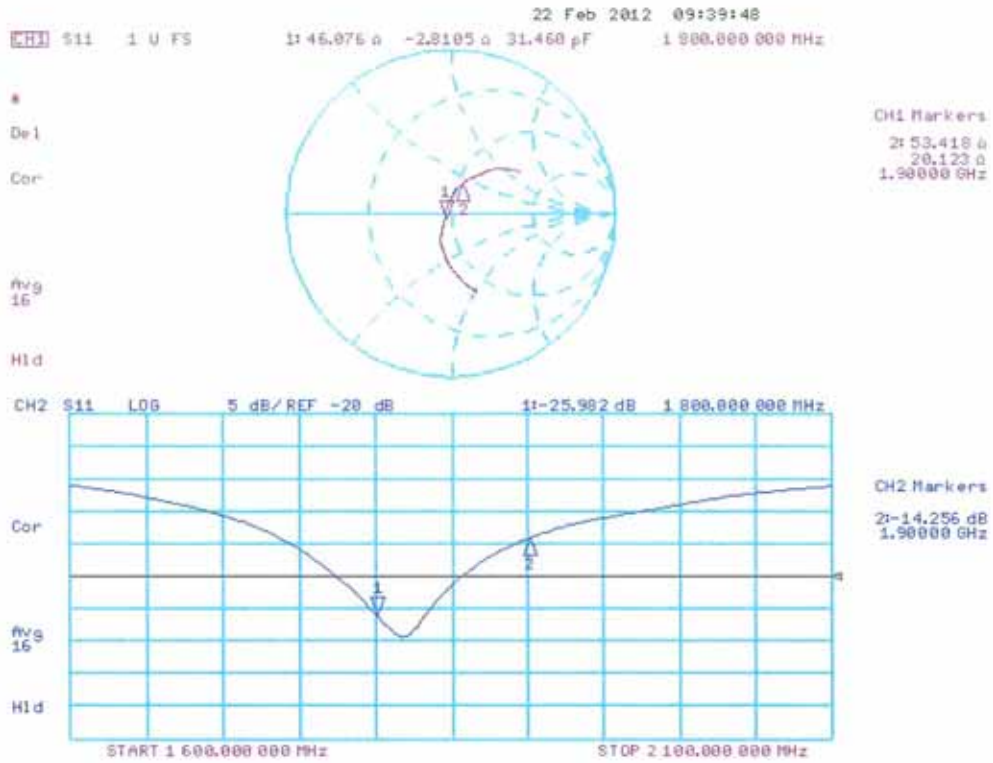



**Calibration Laboratory of**  
**Schmid & Partner**  
**Engineering AG**  
 Zeughausstrasse 43, 8004 Zurich, Switzerland



**S** Schweizerischer Kalibrierdienst  
**C** Service suisse d'étalonnage  
**S** Servizio svizzero di taratura  
**S** Swiss Calibration Service

Accredited by the Swiss Accreditation Service (SAS)  
 The Swiss Accreditation Service is one of the signatories to the EA  
 Multilateral Agreement for the recognition of calibration certificates

Accreditation No.: **SCS 108**

Client **Quietek-CN (Auden)**

Certificate No: **D1900V2-5d121\_Feb12**

## CALIBRATION CERTIFICATE

Object **D1900V2 - SN: 5d121**

Calibration procedure(s) **QA CAL-05.v8  
 Calibration procedure for dipole validation kits above 700 MHz**

Calibration date: **February 22, 2012**

This calibration certificate documents the traceability to national standards, which realize the physical units of measurements (SI).  
 The measurements and the uncertainties with confidence probability are given on the following pages and are part of the certificate.

All calibrations have been conducted in the closed laboratory facility: environment temperature (22 ± 3)°C and humidity < 70%.

Calibration Equipment used (M&TE critical for calibration)

Primary Standards	ID #	Cal Date (Certificate No.)	Scheduled Calibration
Power meter EPM-442A	GB37480704	05-Oct-11 (No. 217-01451)	Oct-12
Power sensor HP 8481A	US37292783	05-Oct-11 (No. 217-01451)	Oct-12
Reference 20 dB Attenuator	SN: 5086 (20g)	29-Mar-11 (No. 217-01368)	Apr-12
Type-N mismatch combination	SN: 6047.2 / 06327	29-Mar-11 (No. 217-01371)	Apr-12
Reference Probe ES3DV3	SN: 3205	30-Dec-11 (No. ES3-3205_Dec11)	Dec-12
DAE4	SN: 601	04-Jul-11 (No. DAE4-601_Jul11)	Jul-12
Secondary Standards	ID #	Check Date (in house)	Scheduled Check
Power sensor HP 8481A	MY41092317	18-Oct-02 (in house check Oct-11)	In house check: Oct-13
RF generator R&S SMT-06	100005	04-Aug-99 (in house check Oct-11)	In house check: Oct-13
Network Analyzer HP 8753E	US37390585 S4206	18-Oct-01 (in house check Oct-11)	In house check: Oct-12

Calibrated by:	Name	Function	Signature
	Israe El-Nacouq	Laboratory Technician	
Approved by:	Katja Pokovic	Technical Manager	

Issued: February 22, 2012

This calibration certificate shall not be reproduced except in full without written approval of the laboratory.

**Calibration Laboratory of  
Schmid & Partner  
Engineering AG**  
Zeughausstrasse 43, 8004 Zurich, Switzerland



**S** Schweizerischer Kalibrierdienst  
**C** Service suisse d'étalonnage  
**S** Servizio svizzero di taratura  
**S** Swiss Calibration Service

Accredited by the Swiss Accreditation Service (SAS)  
The Swiss Accreditation Service is one of the signatories to the EA  
Multilateral Agreement for the recognition of calibration certificates

Accreditation No.: **SCS 108**

**Glossary:**

TSL	tissue simulating liquid
ConvF	sensitivity in TSL / NORM x,y,z
N/A	not applicable or not measured

**Calibration is Performed According to the Following Standards:**

- a) IEEE Std 1528-2003, "IEEE Recommended Practice for Determining the Peak Spatial-Averaged Specific Absorption Rate (SAR) in the Human Head from Wireless Communications Devices: Measurement Techniques", December 2003
- b) IEC 62209-1, "Procedure to measure the Specific Absorption Rate (SAR) for hand-held devices used in close proximity to the ear (frequency range of 300 MHz to 3 GHz)", February 2005
- c) Federal Communications Commission Office of Engineering & Technology (FCC OET), "Evaluating Compliance with FCC Guidelines for Human Exposure to Radiofrequency Electromagnetic Fields; Additional Information for Evaluating Compliance of Mobile and Portable Devices with FCC Limits for Human Exposure to Radiofrequency Emissions", Supplement C (Edition 01-01) to Bulletin 65

**Additional Documentation:**

- d) DASY4/5 System Handbook

**Methods Applied and Interpretation of Parameters:**

- *Measurement Conditions:* Further details are available from the Validation Report at the end of the certificate. All figures stated in the certificate are valid at the frequency indicated.
- *Antenna Parameters with TSL:* The dipole is mounted with the spacer to position its feed point exactly below the center marking of the flat phantom section, with the arms oriented parallel to the body axis.
- *Feed Point Impedance and Return Loss:* These parameters are measured with the dipole positioned under the liquid filled phantom. The impedance stated is transformed from the measurement at the SMA connector to the feed point. The Return Loss ensures low reflected power. No uncertainty required.
- *Electrical Delay:* One-way delay between the SMA connector and the antenna feed point. No uncertainty required.
- *SAR measured:* SAR measured at the stated antenna input power.
- *SAR normalized:* SAR as measured, normalized to an input power of 1 W at the antenna connector.
- *SAR for nominal TSL parameters:* The measured TSL parameters are used to calculate the nominal SAR result.

## Measurement Conditions

DASY system configuration, as far as not given on page 1.

DASY Version	DASY5	V52.8.0
Extrapolation	Advanced Extrapolation	
Phantom	Modular Flat Phantom	
Distance Dipole Center - TSL	10 mm	with Spacer
Zoom Scan Resolution	dx, dy, dz = 5 mm	
Frequency	1900 MHz ± 1 MHz	

## Head TSL parameters

The following parameters and calculations were applied.

	Temperature	Permittivity	Conductivity
Nominal Head TSL parameters	22.0 °C	40.0	1.40 mho/m
Measured Head TSL parameters	(22.0 ± 0.2) °C	40.4 ± 6 %	1.40 mho/m ± 6 %
Head TSL temperature change during test	< 0.5 °C	----	----

## SAR result with Head TSL

SAR averaged over 1 cm <sup>3</sup> (1 g) of Head TSL	Condition	
SAR measured	250 mW input power	9.84 mW / g
SAR for nominal Head TSL parameters	normalized to 1W	<b>39.4 mW / g ± 17.0 % (k=2)</b>

SAR averaged over 10 cm <sup>3</sup> (10 g) of Head TSL	condition	
SAR measured	250 mW input power	5.19 mW / g
SAR for nominal Head TSL parameters	normalized to 1W	<b>20.8 mW / g ± 16.5 % (k=2)</b>

## Body TSL parameters

The following parameters and calculations were applied.

	Temperature	Permittivity	Conductivity
Nominal Body TSL parameters	22.0 °C	53.3	1.52 mho/m
Measured Body TSL parameters	(22.0 ± 0.2) °C	53.0 ± 6 %	1.56 mho/m ± 6 %
Body TSL temperature change during test	< 0.5 °C	----	----

## SAR result with Body TSL

SAR averaged over 1 cm <sup>3</sup> (1 g) of Body TSL	Condition	
SAR measured	250 mW input power	9.84 mW / g
SAR for nominal Body TSL parameters	normalized to 1W	<b>38.7 mW / g ± 17.0 % (k=2)</b>

SAR averaged over 10 cm <sup>3</sup> (10 g) of Body TSL	condition	
SAR measured	250 mW input power	5.15 mW / g
SAR for nominal Body TSL parameters	normalized to 1W	<b>20.4 mW / g ± 16.5 % (k=2)</b>

**Appendix**

**Antenna Parameters with Head TSL**

Impedance, transformed to feed point	51.6 $\Omega$ + 7.2 j $\Omega$
Return Loss	- 22.8 dB

**Antenna Parameters with Body TSL**

Impedance, transformed to feed point	47.4 $\Omega$ + 7.4 j $\Omega$
Return Loss	- 21.9 dB

**General Antenna Parameters and Design**

Electrical Delay (one direction)	1.205 ns
----------------------------------	----------

After long term use with 100W radiated power, only a slight warming of the dipole near the feedpoint can be measured.

The dipole is made of standard semirigid coaxial cable. The center conductor of the feeding line is directly connected to the second arm of the dipole. The antenna is therefore short-circuited for DC-signals. On some of the dipoles, small end caps are added to the dipole arms in order to improve matching when loaded according to the position as explained in the "Measurement Conditions" paragraph. The SAR data are not affected by this change. The overall dipole length is still according to the Standard.

No excessive force must be applied to the dipole arms, because they might bend or the soldered connections near the feedpoint may be damaged.

**Additional EUT Data**

Manufactured by	SPEAG
Manufactured on	August 25, 2009



**DASY5 Validation Report for Head TSL**

Date: 22.02.2012

Test Laboratory: SPEAG, Zurich, Switzerland

**DUT: Dipole 1900 MHz; Type: D1900V2; Serial: D1900V2 - SN: 5d121**

Communication System: CW; Frequency: 1900 MHz

Medium parameters used:  $f = 1900$  MHz;  $\sigma = 1.4$  mho/m;  $\epsilon_r = 40.4$ ;  $\rho = 1000$  kg/m<sup>3</sup>

Phantom section: Flat Section

Measurement Standard: DASY5 (IEEE/IEC/ANSI C63.19-2007)

DASY52 Configuration:

- Probe: ES3DV3 - SN3205; ConvF(5.01, 5.01, 5.01); Calibrated: 30.12.2011
- Sensor-Surface: 3mm (Mechanical Surface Detection)
- Electronics: DAE4 Sn601; Calibrated: 04.07.2011
- Phantom: Flat Phantom 5.0 (front); Type: QD000P50AA; Serial: 1001
- DASY52 52.8.0(692); SEMCAD X 14.6.4(4989)

**Dipole Calibration for Head Tissue/Pin=250 mW, d=10mm/Zoom Scan (7x7x7)/Cube 0:**

Measurement grid: dx=5mm, dy=5mm, dz=5mm

Reference Value = 96.900 V/m; Power Drift = 0.04 dB

Peak SAR (extrapolated) = 17.5160

**SAR(1 g) = 9.84 mW/g; SAR(10 g) = 5.19 mW/g**

Maximum value of SAR (measured) = 12.195 mW/g

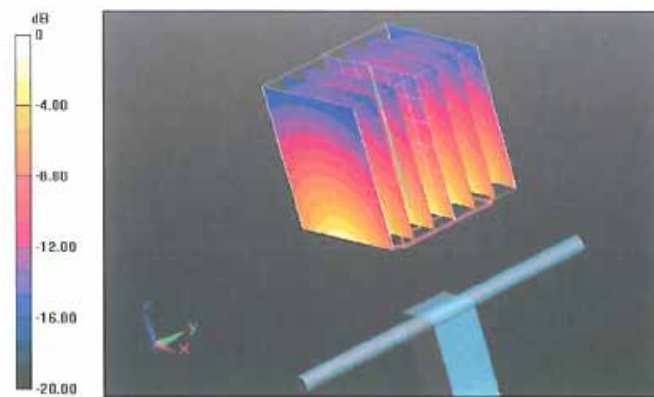

0 dB = 12.200mW/g = 21.73 dB mW/g

Impedance Measurement Plot for Head TSL

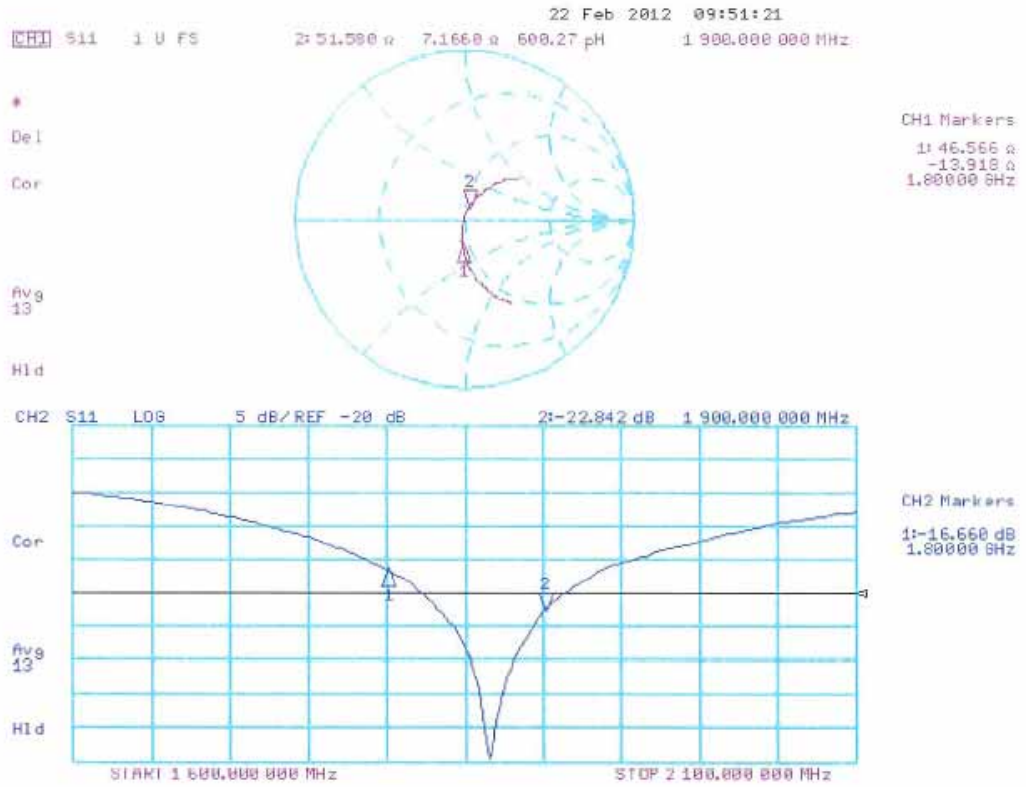

## DASY5 Validation Report for Body TSL

Date: 22.02.2012

Test Laboratory: SPEAG, Zurich, Switzerland

**DUT: Dipole 1900 MHz; Type: D1900V2; Serial: D1900V2 - SN: 5d121**

Communication System: CW; Frequency: 1900 MHz

Medium parameters used:  $f = 1900$  MHz;  $\sigma = 1.56$  mho/m;  $\epsilon_r = 53$ ;  $\rho = 1000$  kg/m<sup>3</sup>

Phantom section: Flat Section

Measurement Standard: DASY5 (IEEE/IEC/ANSI C63.19-2007)

DASY52 Configuration:

- Probe: ES3DV3 - SN3205; ConvF(4.62, 4.62, 4.62); Calibrated: 30.12.2011
- Sensor-Surface: 3mm (Mechanical Surface Detection)
- Electronics: DAE4 Sn601; Calibrated: 04.07.2011
- Phantom: Flat Phantom 5.0 (back); Type: QD000P50AA; Serial: 1002
- DASY52 52.8.0(692); SEMCAD X 14.6.4(4989)

### Dipole Calibration for Body Tissue/Pin=250 mW, d=10mm/Zoom Scan (7x7x7)/Cube 0:

Measurement grid: dx=5mm, dy=5mm, dz=5mm

Reference Value = 93.537 V/m; Power Drift = 0.0039 dB

Peak SAR (extrapolated) = 17.3450

**SAR(1 g) = 9.84 mW/g; SAR(10 g) = 5.15 mW/g**

Maximum value of SAR (measured) = 12.473 mW/g

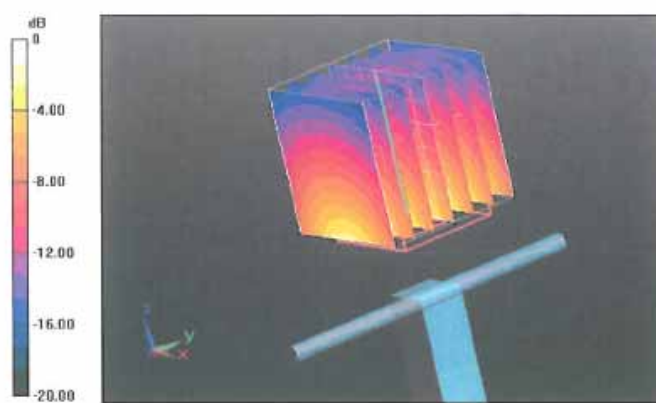

0 dB = 12.470mW/g = 21.92 dB mW/g

Impedance Measurement Plot for Body TSL

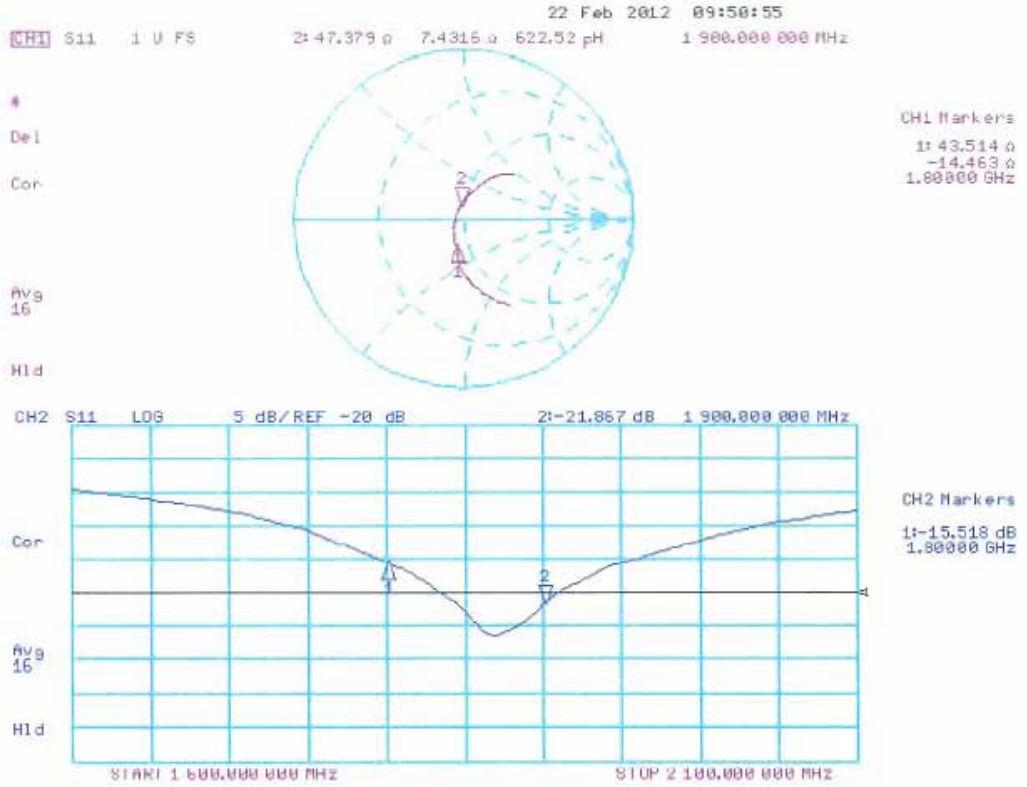



Impedance Measurement Plot for Body TSL

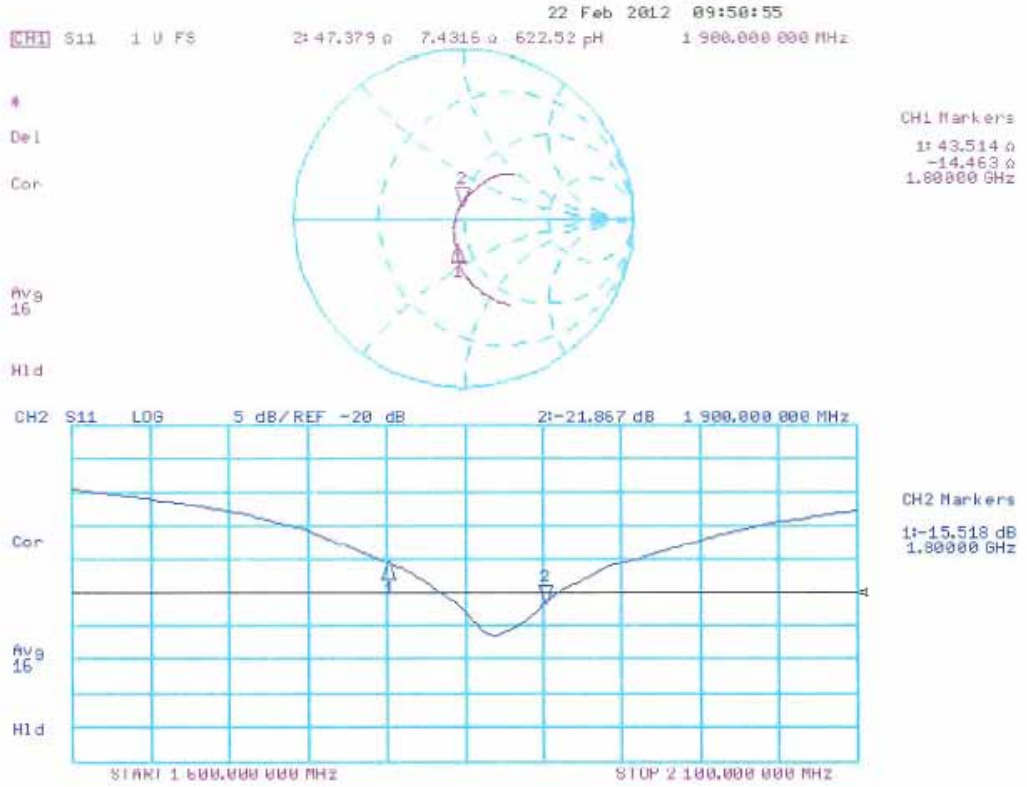

**Calibration Laboratory of  
Schmid & Partner  
Engineering AG**  
Zeughausstrasse 43, 8004 Zurich, Switzerland



**S** Schweizerischer Kalibrierdienst  
**C** Service suisse d'étalonnage  
**S** Servizio svizzero di taratura  
**S** Swiss Calibration Service

Accredited by the Swiss Accreditation Service (SAS)  
The Swiss Accreditation Service is one of the signatories to the EA  
Multilateral Agreement for the recognition of calibration certificates

Accreditation No.: **SCS 108**

Client **Quietek-CN (Auden)**

Certificate No: **D2450V2-839\_Feb12**

## CALIBRATION CERTIFICATE

Object: **D2450V2 - SN: 839**

Calibration procedure(s): **QA CAL-05.v8  
Calibration procedure for dipole validation kits above 700 MHz**

Calibration date: **February 23, 2012**

This calibration certificate documents the traceability to national standards, which realize the physical units of measurements (SI).  
The measurements and the uncertainties with confidence probability are given on the following pages and are part of the certificate.

All calibrations have been conducted in the closed laboratory facility: environment temperature (22 ± 3)°C and humidity < 70%.

Calibration Equipment used (M&TE critical for calibration)

Primary Standards	ID #	Cal Date (Certificate No.)	Scheduled Calibration
Power meter EPM-442A	GB37480704	05-Oct-11 (No. 217-01451)	Oct-12
Power sensor HP 8481A	US37292783	05-Oct-11 (No. 217-01451)	Oct-12
Reference 20 dB Attenuator	SN: 5086 (20g)	29-Mar-11 (No. 217-01368)	Apr-12
Type N mismatch combination	SN: 5017.2 / 06327	29-Mar-11 (No. 217-01371)	Apr-12
Reference Probe ES3DV3	SN: 3205	30-Dec-11 (No. ES3-3205_Dec11)	Dec-12
DAE4	SN: 601	04-Jul-11 (No. DAE4-601_Jul11)	Jul-12
Secondary Standards	ID #	Check Date (in house)	Scheduled Check
Power sensor HP 8481A	MY41092317	18-Oct-02 (in house check Oct-11)	In house check: Oct-13
RF generator R&S SMT-06	100005	04-Aug-99 (in house check Oct-11)	In house check: Oct-13
Network Analyzer HP 8753E	US37390585 S4206	18-Oct-01 (in house check Oct-11)	In house check: Oct-12

Calibrated by:	Name <b>Israe El-Naouq</b>	Function Laboratory Technician	Signature 
Approved by:	Name <b>Katja Pokovic</b>	Function Technical Manager	

Issued: February 23, 2012

This calibration certificate shall not be reproduced except in full without written approval of the laboratory.

**Calibration Laboratory of  
Schmid & Partner  
Engineering AG**  
Zeughausstrasse 43, 8004 Zurich, Switzerland



**S** Schweizerischer Kalibrierdienst  
**C** Service suisse d'étalonnage  
**S** Servizio svizzero di taratura  
**S** Swiss Calibration Service

Accredited by the Swiss Accreditation Service (SAS)  
The Swiss Accreditation Service is one of the signatories to the EA  
Multilateral Agreement for the recognition of calibration certificates

Accreditation No.: **SCS 108**

**Glossary:**

TSL	tissue simulating liquid
ConvF	sensitivity in TSL / NORM x,y,z
N/A	not applicable or not measured

**Calibration is Performed According to the Following Standards:**

- a) IEEE Std 1528-2003, "IEEE Recommended Practice for Determining the Peak Spatial-Averaged Specific Absorption Rate (SAR) in the Human Head from Wireless Communications Devices: Measurement Techniques", December 2003
- b) IEC 62209-1, "Procedure to measure the Specific Absorption Rate (SAR) for hand-held devices used in close proximity to the ear (frequency range of 300 MHz to 3 GHz)", February 2005
- c) Federal Communications Commission Office of Engineering & Technology (FCC OET), "Evaluating Compliance with FCC Guidelines for Human Exposure to Radiofrequency Electromagnetic Fields; Additional Information for Evaluating Compliance of Mobile and Portable Devices with FCC Limits for Human Exposure to Radiofrequency Emissions", Supplement C (Edition 01-01) to Bulletin 65

**Additional Documentation:**

- d) DASY4/5 System Handbook

**Methods Applied and Interpretation of Parameters:**

- *Measurement Conditions:* Further details are available from the Validation Report at the end of the certificate. All figures stated in the certificate are valid at the frequency indicated.
- *Antenna Parameters with TSL:* The dipole is mounted with the spacer to position its feed point exactly below the center marking of the flat phantom section, with the arms oriented parallel to the body axis.
- *Feed Point Impedance and Return Loss:* These parameters are measured with the dipole positioned under the liquid filled phantom. The impedance stated is transformed from the measurement at the SMA connector to the feed point. The Return Loss ensures low reflected power. No uncertainty required.
- *Electrical Delay:* One-way delay between the SMA connector and the antenna feed point. No uncertainty required.
- *SAR measured:* SAR measured at the stated antenna input power.
- *SAR normalized:* SAR as measured, normalized to an input power of 1 W at the antenna connector.
- *SAR for nominal TSL parameters:* The measured TSL parameters are used to calculate the nominal SAR result.

**Measurement Conditions**

DASY system configuration, as far as not given on page 1.

DASY Version	DASY5	V52.8.0
Extrapolation	Advanced Extrapolation	
Phantom	Modular Flat Phantom	
Distance Dipole Center - TSL	10 mm	with Spacer
Zoom Scan Resolution	dx, dy, dz = 5 mm	
Frequency	2450 MHz ± 1 MHz	

**Head TSL parameters**

The following parameters and calculations were applied.

	Temperature	Permittivity	Conductivity
Nominal Head TSL parameters	22.0 °C	39.2	1.80 mho/m
Measured Head TSL parameters	(22.0 ± 0.2) °C	38.9 ± 6 %	1.86 mho/m ± 6 %
Head TSL temperature change during test	< 0.5 °C	----	----

**SAR result with Head TSL**

SAR averaged over 1 cm <sup>3</sup> (1 g) of Head TSL	Condition	
SAR measured	250 mW input power	13.2 mW / g
SAR for nominal Head TSL parameters	normalized to 1W	<b>51.9 mW / g ± 17.0 % (k=2)</b>

SAR averaged over 10 cm <sup>3</sup> (10 g) of Head TSL	condition	
SAR measured	250 mW input power	6.09 mW / g
SAR for nominal Head TSL parameters	normalized to 1W	<b>24.1 mW / g ± 16.5 % (k=2)</b>

**Body TSL parameters**

The following parameters and calculations were applied.

	Temperature	Permittivity	Conductivity
Nominal Body TSL parameters	22.0 °C	52.7	1.95 mho/m
Measured Body TSL parameters	(22.0 ± 0.2) °C	52.3 ± 6 %	2.02 mho/m ± 6 %
Body TSL temperature change during test	< 0.5 °C	----	----

**SAR result with Body TSL**

SAR averaged over 1 cm <sup>3</sup> (1 g) of Body TSL	Condition	
SAR measured	250 mW input power	12.4 mW / g
SAR for nominal Body TSL parameters	normalized to 1W	<b>48.7 mW / g ± 17.0 % (k=2)</b>

SAR averaged over 10 cm <sup>3</sup> (10 g) of Body TSL	condition	
SAR measured	250 mW input power	5.76 mW / g
SAR for nominal Body TSL parameters	normalized to 1W	<b>22.8 mW / g ± 16.5 % (k=2)</b>

**Appendix**

**Antenna Parameters with Head TSL**

Impedance, transformed to feed point	55.7 $\Omega$ - 1.0 j $\Omega$
Return Loss	- 25.2 dB

**Antenna Parameters with Body TSL**

Impedance, transformed to feed point	52.1 $\Omega$ + 1.0 j $\Omega$
Return Loss	- 32.9 dB

**General Antenna Parameters and Design**

Electrical Delay (one direction)	1.160 ns
----------------------------------	----------

After long term use with 100W radiated power, only a slight warming of the dipole near the feedpoint can be measured.

The dipole is made of standard semirigid coaxial cable. The center conductor of the feeding line is directly connected to the second arm of the dipole. The antenna is therefore short-circuited for DC-signals. On some of the dipoles, small end caps are added to the dipole arms in order to improve matching when loaded according to the position as explained in the "Measurement Conditions" paragraph. The SAR data are not affected by this change. The overall dipole length is still according to the Standard.

No excessive force must be applied to the dipole arms, because they might bend or the soldered connections near the feedpoint may be damaged.

**Additional EUT Data**

Manufactured by	SPEAG
Manufactured on	July 20, 2009



## DASY5 Validation Report for Head TSL

Date: 23.02.2012

Test Laboratory: SPEAG, Zurich, Switzerland

**DUT: Dipole 2450 MHz; Type: D2450V2; Serial: D2450V2 - SN: 839**

Communication System: CW; Frequency: 2450 MHz

Medium parameters used:  $f = 2450$  MHz;  $\sigma = 1.86$  mho/m;  $\epsilon_r = 38.9$ ;  $\rho = 1000$  kg/m<sup>3</sup>

Phantom section: Flat Section

Measurement Standard: DASY5 (IEEE/IEC/ANSI C63.19-2007)

DASY52 Configuration:

- Probe: ES3DV3 - SN3205; ConvF(4.45, 4.45, 4.45); Calibrated: 30.12.2011
- Sensor-Surface: 3mm (Mechanical Surface Detection)
- Electronics: DAE4 Sn601; Calibrated: 04.07.2011
- Phantom: Flat Phantom 5.0 (front); Type: QD000P50AA; Serial: 1001
- DASY52 52.8.0(692); SEMCAD X 14.6.4(4989)

### Dipole Calibration for Head Tissue/Pin=250 mW, d=10mm/Zoom Scan (7x7x7)/Cube 0:

Measurement grid: dx=5mm, dy=5mm, dz=5mm

Reference Value = 98.155 V/m; Power Drift = 0.08 dB

Peak SAR (extrapolated) = 27.8700

**SAR(1 g) = 13.2 mW/g; SAR(10 g) = 6.09 mW/g**

Maximum value of SAR (measured) = 16.839 mW/g

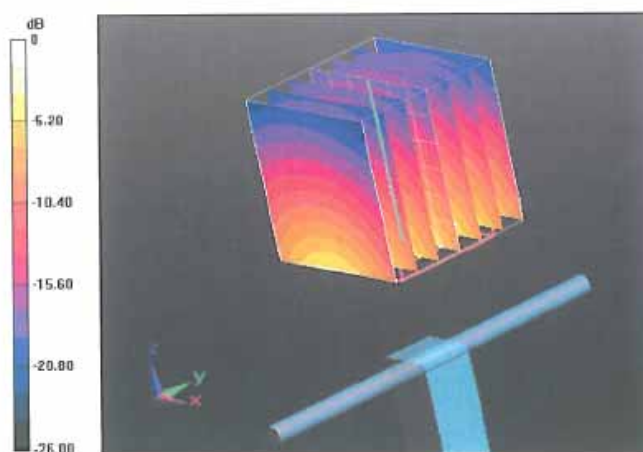

0 dB = 16.840mW/g = 24.53 dB mW/g

Impedance Measurement Plot for Head TSL

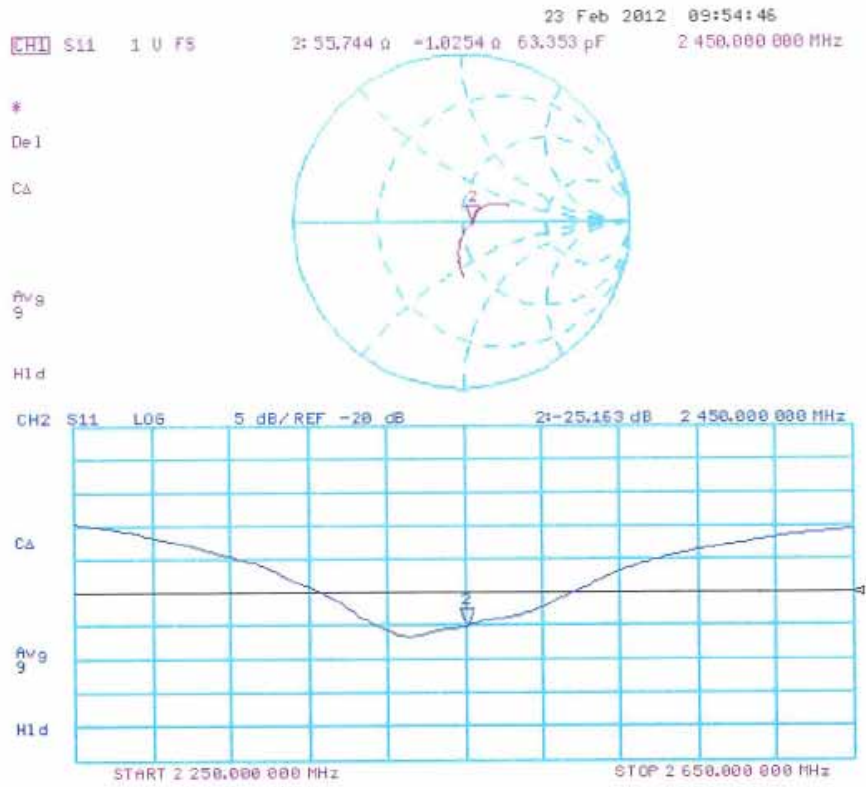

## DASY5 Validation Report for Body TSL

Date: 23.02.2012

Test Laboratory: SPEAG, Zurich, Switzerland

**DUT: Dipole 2450 MHz; Type: D2450V2; Serial: D2450V2 - SN: 839**

Communication System: CW; Frequency: 2450 MHz

Medium parameters used:  $f = 2450$  MHz;  $\sigma = 2.02$  mho/m;  $\epsilon_r = 52.3$ ;  $\rho = 1000$  kg/m<sup>3</sup>

Phantom section: Flat Section

Measurement Standard: DASY5 (IEEE/IEC/ANSI C63.19-2007)

DASY52 Configuration:

- Probe: ES3DV3 - SN3205; ConvF(4.26, 4.26, 4.26); Calibrated: 30.12.2011
- Sensor-Surface: 3mm (Mechanical Surface Detection)
- Electronics: DAE4 Sn601; Calibrated: 04.07.2011
- Phantom: Flat Phantom 5.0 (back); Type: QD000P50AA; Serial: 1002
- DASY52 52.8.0(692); SEMCAD X 14.6.4(4989)

### Dipole Calibration for Body Tissue/Pin=250 mW, d=10mm/Zoom Scan (7x7x7)/Cube 0:

Measurement grid: dx=5mm, dy=5mm, dz=5mm

Reference Value = 93.056 V/m; Power Drift = 0.0053 dB

Peak SAR (extrapolated) = 25.2250

**SAR(1 g) = 12.4 mW/g; SAR(10 g) = 5.76 mW/g**

Maximum value of SAR (measured) – 16.258 mW/g

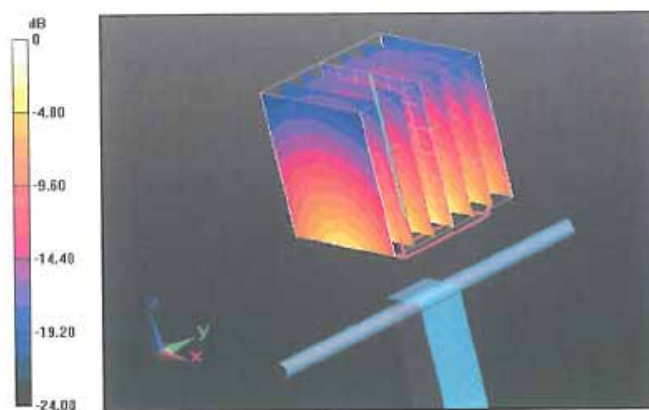

0 dB = 16.260mW/g = 24.22 dB mW/g



Impedance Measurement Plot for Body TSL

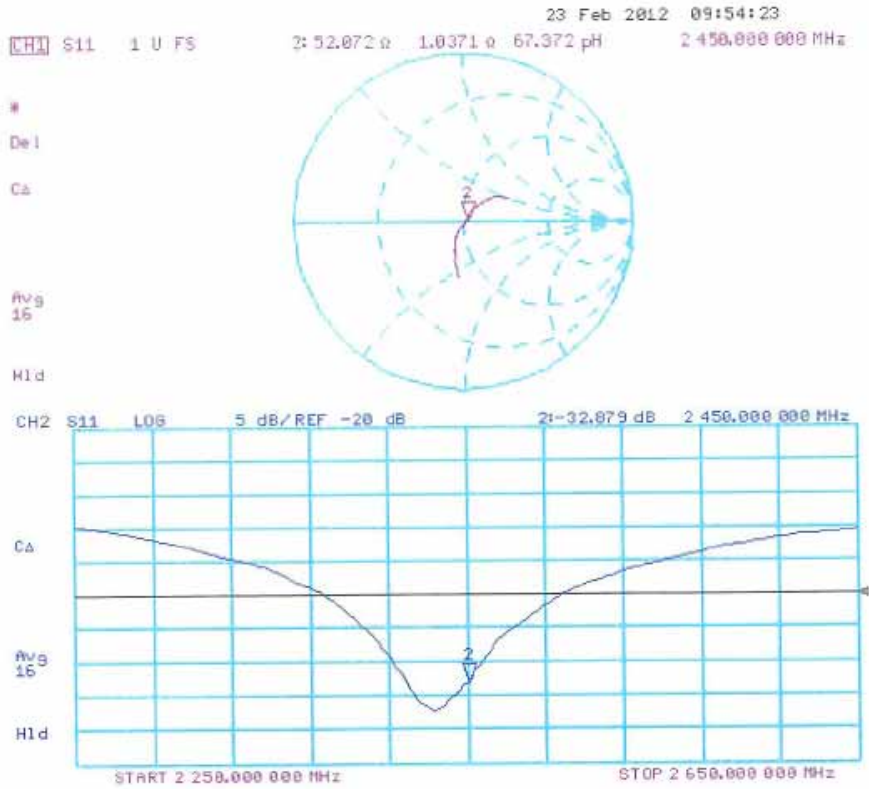

**Appendix F. DAE Calibration Data**

**Calibration Laboratory of  
Schmid & Partner  
Engineering AG**  
Zeughausstrasse 43, 8004 Zurich, Switzerland



**S** Schweizerischer Kalibrierdienst  
**C** Service suisse d'étalonnage  
**S** Servizio svizzero di taratura  
**S** Swiss Calibration Service

Accredited by the Swiss Accreditation Service (SAS)  
The Swiss Accreditation Service is one of the signatories to the EA  
Multilateral Agreement for the recognition of calibration certificates

Accreditation No.: **SCS 108**

Client **Quie Tek (Auden)**

Certificate No: **DAE4-1220\_Jan13**

**CALIBRATION CERTIFICATE**

Object	DAE4 - SD 000 D04 BJ - SN: 1220																						
Calibration procedure(s)	QA CAL-06.v25 Calibration procedure for the data acquisition electronics (DAE)																						
Calibration date:	January 24, 2013																						
<p>This calibration certificate documents the traceability to national standards, which realize the physical units of measurements (SI). The measurements and the uncertainties with confidence probability are given on the following pages and are part of the certificate.</p> <p>All calibrations have been conducted in the closed laboratory facility: environment temperature (22 ± 3)°C and humidity &lt; 70%.</p> <p>Calibration Equipment used (M&amp;TE critical for calibration)</p> <table border="1"> <thead> <tr> <th>Primary Standards</th> <th>ID #</th> <th>Cal Date (Certificate No.)</th> <th>Scheduled Calibration</th> </tr> </thead> <tbody> <tr> <td>Kelthley Multimeter Type 2001</td> <td>SN: 0810278</td> <td>02-Oct-12 (No:12728)</td> <td>Oct-13</td> </tr> <tr> <th>Secondary Standards</th> <th>ID #</th> <th>Check Date (in house)</th> <th>Scheduled Check</th> </tr> <tr> <td>Auto DAE Calibration Unit</td> <td>SE UWS 053 AA 1001</td> <td>07-Jan-13 (in house check)</td> <td>In house check: Jan-14</td> </tr> <tr> <td>Calibrator Box V2.1</td> <td>SE UMS 006 AA 1002</td> <td>07-Jan-13 (in house check)</td> <td>In house check: Jan-14</td> </tr> </tbody> </table>				Primary Standards	ID #	Cal Date (Certificate No.)	Scheduled Calibration	Kelthley Multimeter Type 2001	SN: 0810278	02-Oct-12 (No:12728)	Oct-13	Secondary Standards	ID #	Check Date (in house)	Scheduled Check	Auto DAE Calibration Unit	SE UWS 053 AA 1001	07-Jan-13 (in house check)	In house check: Jan-14	Calibrator Box V2.1	SE UMS 006 AA 1002	07-Jan-13 (in house check)	In house check: Jan-14
Primary Standards	ID #	Cal Date (Certificate No.)	Scheduled Calibration																				
Kelthley Multimeter Type 2001	SN: 0810278	02-Oct-12 (No:12728)	Oct-13																				
Secondary Standards	ID #	Check Date (in house)	Scheduled Check																				
Auto DAE Calibration Unit	SE UWS 053 AA 1001	07-Jan-13 (in house check)	In house check: Jan-14																				
Calibrator Box V2.1	SE UMS 006 AA 1002	07-Jan-13 (in house check)	In house check: Jan-14																				
Calibrated by:	Name R Mayoraz	Function Technician	Signature <i>R Mayoraz</i>																				
Approved by:	Fin Bornholt	Deputy Technical Manager	<i>F Bornholt</i>																				
			Issued: January 24, 2013																				
This calibration certificate shall not be reproduced except in full without written approval of the laboratory.																							

**Calibration Laboratory of  
Schmid & Partner  
Engineering AG**  
Zeughausstrasse 43, 8004 Zurich, Switzerland



**S** Schweizerischer Kalibrierdienst  
**S** Service suisse d'étalonnage  
**C** Servizio svizzero di taratura  
**S** Swiss Calibration Service

Accredited by the Swiss Accreditation Service (SAS)  
The Swiss Accreditation Service is one of the signatories to the EA  
Multilateral Agreement for the recognition of calibration certificates

Accreditation No.: **SCS 108**

## Glossary

**DAE** data acquisition electronics  
**Connector angle** information used in DASY system to align probe sensor X to the robot coordinate system.

## Methods Applied and Interpretation of Parameters

- *DC Voltage Measurement*: Calibration Factor assessed for use in DASY system by comparison with a calibrated instrument traceable to national standards. The figure given corresponds to the full scale range of the voltmeter in the respective range.
- *Connector angle*: The angle of the connector is assessed measuring the angle mechanically by a tool inserted. Uncertainty is not required.
- The following parameters as documented in the Appendix contain technical information as a result from the performance test and require no uncertainty.
  - *DC Voltage Measurement Linearity*: Verification of the Linearity at +10% and -10% of the nominal calibration voltage. Influence of offset voltage is included in this measurement.
  - *Common mode sensitivity*: Influence of a positive or negative common mode voltage on the differential measurement.
  - *Channel separation*: Influence of a voltage on the neighbor channels not subject to an input voltage.
  - *AD Converter Values with inputs shorted*: Values on the internal AD converter corresponding to zero input voltage
  - *Input Offset Measurement*: Output voltage and statistical results over a large number of zero voltage measurements.
  - *Input Offset Current*: Typical value for information; Maximum channel input offset current, not considering the input resistance.
  - *Input resistance*: Typical value for information: DAE input resistance at the connector, during internal auto-zeroing and during measurement.
  - *Low Battery Alarm Voltage*: Typical value for information. Below this voltage, a battery alarm signal is generated.
  - *Power consumption*: Typical value for information. Supply currents in various operating modes.

**DC Voltage Measurement**

A/D - Converter Resolution nominal

High Range: 1LSB = 6.1 $\mu$ V, full range = -100...+300 mV

Low Range: 1LSB = 61nV, full range = -1.....+3mV

DASY measurement parameters: Auto Zero Time: 3 sec; Measuring time: 3 sec

Calibration Factors	X	Y	Z
High Range	405.203 $\pm$ 0.02% (k=2)	404.925 $\pm$ 0.02% (k=2)	404.155 $\pm$ 0.02% (k=2)
Low Range	3.97823 $\pm$ 1.55% (k=2)	3.99494 $\pm$ 1.55% (k=2)	3.98678 $\pm$ 1.55% (k=2)

**Connector Angle**

Connector Angle to be used in DASY system	176.5 $^{\circ}$ $\pm$ 1 $^{\circ}$
---	-------------------------------------

## Appendix

### 1. DC Voltage Linearity

High Range	Reading ( $\mu\text{V}$ )	Difference ( $\mu\text{V}$ )	Error (%)
Channel X + Input	199994.51	-0.20	-0.00
Channel X + Input	20002.32	2.74	0.01
Channel X - Input	-19999.37	2.24	-0.01
Channel Y + Input	199995.12	0.58	0.00
Channel Y + Input	19999.79	0.15	0.00
Channel Y - Input	-20001.15	0.37	-0.00
Channel Z + Input	199993.80	-0.47	-0.00
Channel Z + Input	19998.06	-1.59	-0.01
Channel Z - Input	-20003.12	-1.65	0.01

Low Range	Reading ( $\mu\text{V}$ )	Difference ( $\mu\text{V}$ )	Error (%)
Channel X + Input	2000.11	0.30	0.02
Channel X + Input	199.89	-0.29	-0.15
Channel X - Input	-199.74	-0.14	0.07
Channel Y + Input	2000.30	0.54	0.03
Channel Y + Input	200.19	0.06	0.03
Channel Y - Input	-199.81	-0.14	0.07
Channel Z + Input	1999.40	-0.47	-0.02
Channel Z + Input	199.41	-0.98	-0.49
Channel Z - Input	-200.25	-0.72	0.36

### 2. Common mode sensitivity

DASY measurement parameters: Auto Zero Time: 3 sec; Measuring time: 3 sec

	Common mode Input Voltage (mV)	High Range Average Reading ( $\mu\text{V}$ )	Low Range Average Reading ( $\mu\text{V}$ )
Channel X	200	9.11	7.73
	- 200	-8.18	-9.59
Channel Y	200	-9.61	-9.37
	- 200	8.21	8.45
Channel Z	200	12.18	11.90
	- 200	-15.16	-14.84

### 3. Channel separation

DASY measurement parameters: Auto Zero Time: 3 sec; Measuring time: 3 sec

	Input Voltage (mV)	Channel X ( $\mu\text{V}$ )	Channel Y ( $\mu\text{V}$ )	Channel Z ( $\mu\text{V}$ )
Channel X	200	-	2.08	-4.00
Channel Y	200	7.59	-	2.69
Channel Z	200	9.59	6.24	-



#### 4. AD-Converter Values with inputs shorted

DASY measurement parameters: Auto Zero Time: 3 sec; Measuring time: 3 sec

	High Range (LSB)	Low Range (LSB)
Channel X	15892	15975
Channel Y	16014	16213
Channel Z	15705	16067

#### 5. Input Offset Measurement

DASY measurement parameters: Auto Zero Time: 3 sec; Measuring time: 3 sec

Input 10M $\Omega$

	Average ( $\mu$ V)	min. Offset ( $\mu$ V)	max. Offset ( $\mu$ V)	Std. Deviation ( $\mu$ V)
Channel X	1.05	-0.80	2.18	0.45
Channel Y	-0.16	-1.22	0.92	0.45
Channel Z	-0.69	-2.22	0.60	0.48

#### 6. Input Offset Current

Nominal Input circuitry offset current on all channels: <25fA

#### 7. Input Resistance (Typical values for information)

	Zeroing (kOhm)	Measuring (MOhm)
Channel X	200	200
Channel Y	200	200
Channel Z	200	200

#### 8. Low Battery Alarm Voltage (Typical values for information)

Typical values	Alarm Level (VDC)
Supply (+ Vcc)	+7.9
Supply (- Vcc)	-7.6

#### 9. Power Consumption (Typical values for information)

Typical values	Switched off (mA)	Stand by (mA)	Transmitting (mA)
Supply (+ Vcc)	+0.01	+6	+14
Supply (- Vcc)	-0.01	-8	-9