

Join us at  
[seeed.cc/rephone](http://seeed.cc/rephone)  
seeed studio

# RePhone Kit

*rephone*



## Preface

### About RePhone

RePhone Kit is an open source modular phone kit that changes the way we put our phone into use. It provides a new form of phone customization, and the easiest solution to wearable/IoT development.

With RePhone you can create your own phone in minutes by using the slim MODULES, accessible SOFTWARE, and customizable PHONE CASE. You can also hack things around you, giving inanimate objects the power of cellular communication, having conversations with your pets, plants, toys, motorcycle helmets, robots, or drones through cellular connectivity.

### About 'Re'

'Re' means 'Renaissance'. A phone does not necessarily to be a bulky rectangular block that can only be used by human, it ought to have different shapes and sizes for different applications. The Renaissance of Phones encourages people to 'rethink' what a phone could be, 'redesign' how it should look like, and 'remix' the modules to 'remake' a unique phone for their very own.

Now it is time for us to start the Renaissance of Phones.

### About Us

For the past 8 years in Shenzhen, Seeed has been a hardware innovation platform for makers to grow inspirations into differentiating products. By working closely with technology providers of all scale, Seeed provides accessible technologies with quality, speed and supply chain knowledge. When prototypes are ready to iterate, Seeed helps productize 1 to 1,000 pcs using in-house engineering, supply chain management and agile manufacture forces. Seeed also team up with incubators, Chinese tech ecosystem, investors and distribution channels to portal Maker startups beyond.

### About You

RePhone will keep growing with YOU and the COMMUNITY - that means there will be increasingly add-on modules with even more powerful features and functionalities, all kinds of customizable phone cases sharing online and free to download, and most importantly, blooming innovative ideas inspiring you and others.

As a big family of various modules, RePhone also acts like a 'Hardware Development Kit'. With the open-source modular design, easy pluggable interfaces, and rich-featured modules, RePhone actually provides a perfect way to prototype your ideas of wearables or Internet of Things (IoT). Embedding the RePhone modules into your finished product to add various features or act like a control unit, whether you are building a smart control communication device for your dog, or DJ gesture-controlling device, the RePhone modules could be your personal starting line.

Now realize your ideas with Seeed's RePhone Kit, build up your prototype, then we can provide manufacturing services to help you complete small batch production from up to 10K pieces. What's more, our strong supply chain management can also turn your RePhone project into a mass manufactured phenomenon. For more information visit <http://www.seeedstudio.com/propagate/>.

## Contents

Preface	1
About RePhone	1
About 're'	1
About Us	1
About You	1
RePhone Family	3
RePhone Modules	3
RePhone Kit Create	3
RePhone Strap Kit for Pebble Time	4
RePhone Geo Kit	4
RePhone Lumi Kit	5
RePhone Kit Create 3G Version	5
Development Environment	5
Xadow GSM+BLE	6
Xadow 1.54" Touchscreen	8
Xadow Audio	9
Xadow GSM Breakout	10
Xadow LED 5x7	12
Xadow Basic Sensors	13
Xadow Duino	15
Xadow GPS v2	17
Xadow NFC v2	19
RePhone Kit Create	20
Phone Case Assembly	21
Operation Interface	27
RePhone Geo/Lumi Kit	29
RePhone Extension Pack	30
More Info & Appendix	31

# RePhone Family

## RePhone Modules

### Add-on Modules with 35 PIN Xadow Connectors

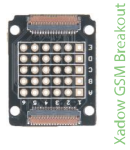
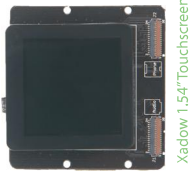

## Core Module

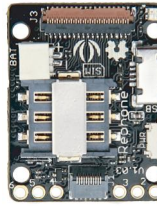

## Xadow GSM+BLE

### Add-on Modules with 11 PIN Xadow Connectors

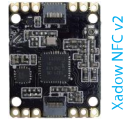
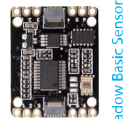

The core of the RePhone is provided by Xadow GSM+BLE or by RePhone Core 3G Module (coming soon), beyond these two core modules are 8 more chainable add-on modules to extend the features and functionalities – Xadow 1.54" Touchscreen, Xadow Audio, Xadow GSM Breakout, Xadow LED 5x7, Xadow Basic Sensors, Xadow Duino, Xadow GPS v2 and Xadow NFC v2.

# RePhone Family

## RePhone Kit Create

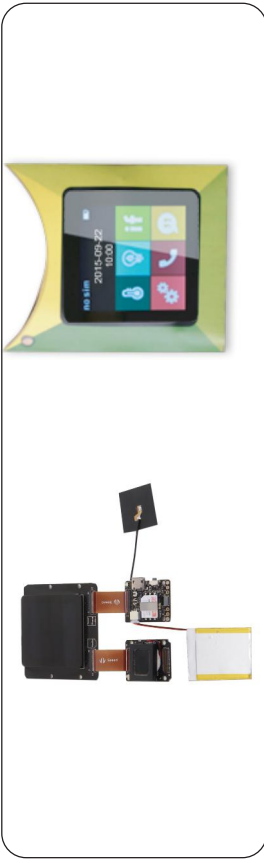

## RePhone Strap Kit for Pebble Time

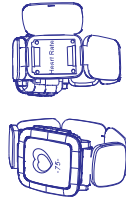

## RePhone Geo Kit

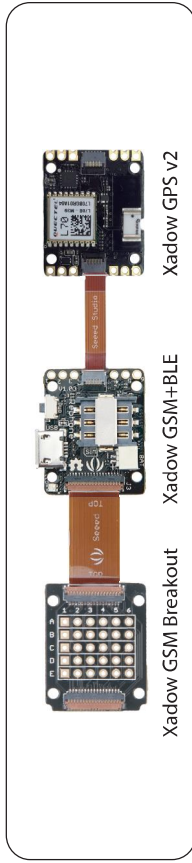

## RePhone Family

### RePhone Lumi Kit

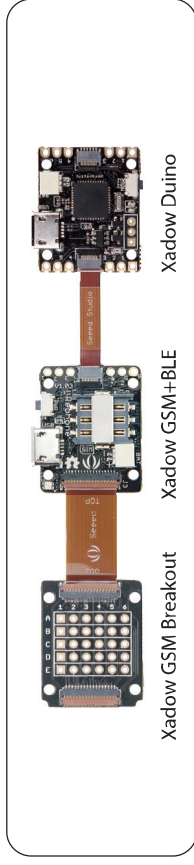

### RePhone Kit Create 3G Version (Coming Soon)

- 1. RePhone Core Module 3G x 1
- 2. Xadow Audio x 1
- 3. Xadow 1.54" Touchscreen x 1
- 4. 520mAh Lipo Battery x 1
- 5. FPC Cable 35 PIN x 5
- 6. Pre-cut Kraft Paper x 2

### Development Environment



We have developed rich libraries hooking into Arduino IDE, Lua and JavaScript, with detailed example sketches to help entry-level programmers develop with RePhone easily and quickly. We also provide a full power SDK based on Eclipse IDE for C/C++ developers to work with high level applications.

For the documentation please refer to the **More Info** section.

## Xadow GSM+BLE

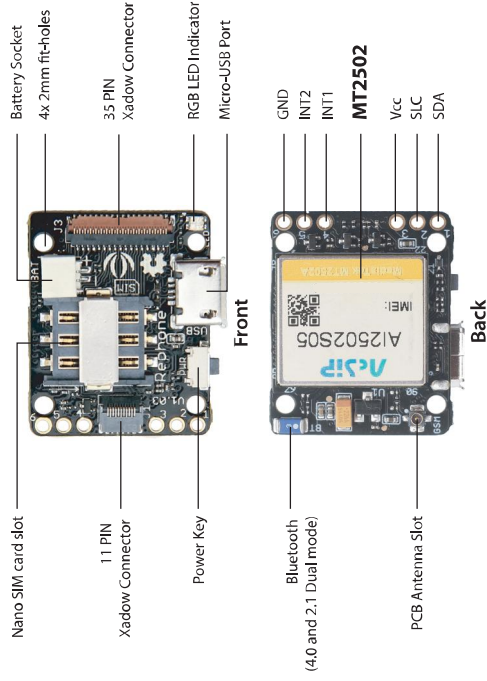

### Description

Whether making and receiving telephone calls over a radio link using external speakers and microphone, or exchanging data in short distances with Bluetooth, you can do it with Xadow GSM+BLE. As the heart of RePhone kit Create, the Xadow GSM+BLE is built around the powerful System-On-Chip (SOC) MT2502, offering a rich range of communication protocols - GSM, GPRS and Bluetooth (v4.0 and 2.1 dual mode). It supports quad-band 850/900/1800/1900MHz that covers any GSM network in the world. Simply insert a 2G Nano SIM card, then you are able to enchant things with cellular connectivity.

### Technical Details

Microcontroller:	MT2502
MCU Core:	32-bit ARM7EJ-STM RISC processor
RAM:	4 MB
Flash Memory:	16 MB
Power Supply:	3.3 - 4.2 V
Quad-band:	850/900/1800/1900 MHz
GPRS: Class	12 modem
Clock Speed:	260 MHz
Connector:	35 PIN Connector & 11 PIN Connector for Xadow
Interfaces:	LCD, Audio, I2C, SPI, UART, and GPIOs etc.
Dimensions:	25.37mm X 20.30mm / 1" X 0.8"

## Xadow GSM+BLE

### Mass Storage Mode

When the Xadow GSM+BLE is OFF, connect the board (with battery connected) to PC via Micro USB cable, you can access the SMB 'Mass Storage Mode' on PC. All the applications (vxp files) and system settings are stored in this SMB disk.

### Flash/Debug Mode

When the Xadow GSM+BLE is ON, connect the board (with battery connected) to PC via Micro USB cable, you can find two ports on your 'Device Manager', the 'MTK USB Debug Port' is for debugging while the 'MTK USB Modem Port' is for uploading/flashing software.

### Xadow Connectors

See the images below to use the 11 PIN or 35 PIN Xadow Connectors, do make sure the ribbon cables are **FLAT** and **ALIGNED** to the connectors. **Be notified** that the FPC Cable 35 PIN **CANNOT** be used up-side down, the FPC Cable 11 PIN is designed to have **much more flexibility** and do not have same concerns. Most importantly, please **turn off the power** before connecting any modules.

#### How to use 11 PIN Xadow Connector

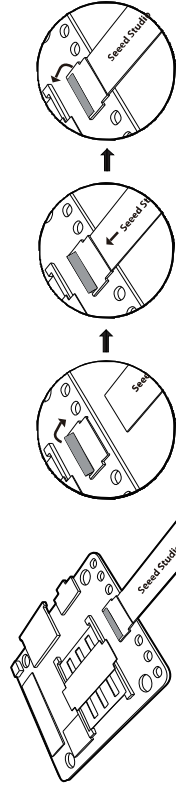

#### How to use 35 PIN Xadow Connector

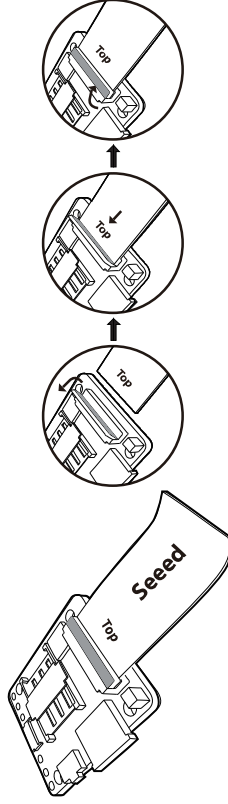

### More Info

Please visit our website for more technical details and tutorials:  
 Wiki: <http://www.seeedstudio.com/wiki/RePhone>  
 Demo: Topic 'RePhone' at <http://www.seeedstudio.com/recipe>

## Xadow 1.54" Touchscreen

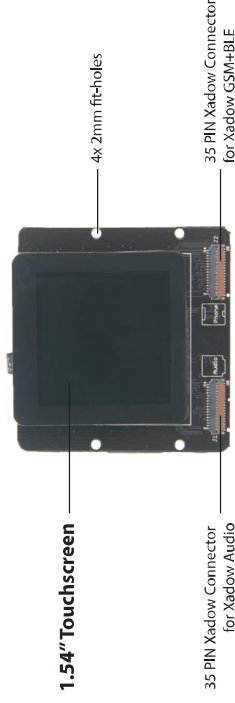

### Description

This TFT Display contains 240 x 240 pixels that can be controlled individually to display up to 262K colours. Above the display is a layer of capacitive touchscreen, offering 29.4mm x 29.4mm active area at the centre of the display. As a single touch screen, it can detect finger presses anywhere within the active area during normal operations. The TFT driver is based on the ST7789S IC Driver with 2 bit data and 4 bit control serial interface while the capacitive touchscreen controller uses I2C.

### Notice

- Try to use it in a steady environment as abrupt variation on temperature and humidity may cause malfunction of the panel.
- Try to keep the panel surface clean and avoid any kind of adhesive applied on the surface, you may use neutral detergent or isopropyl alcohol on a clean soft cloth to clean the panel surface.

### Technical Details

TFT Driver:	ST7789S
Touchscreen Type:	Capacitive
Backlight:	3 adjustable white LEDs
Current draw:	~ 100mA at full backlight
Resolution:	240 x 240 pixels
Connector:	2x 35 PIN Xadow Connectors for Xadow GSM+BLE & Xadow Audio
Interfaces:	4 line serial interface for TFT display, I2C for touchscreen
Dimensions:	Board – 50.22mm X 47.21mm / 1.98" X 1.86" Touchscreen – 38.1mm X 37.8mm / 1.51" X 1.51" Active Area – 27.72mm X 27.72mm / 1.09" X 1.09" 4x 2mm/0.9" fit-holes



## Xadow GSM Breakout

### Pinout Definitions for Arduino IDE

	1	2	3	4	5	6
<b>A</b>	D3 SPI_MISO	AU_HPL	AU_VINO_N	D14	D9 UART1_RX	D8 UART1_TX
<b>B</b>	D1 PWM	AU_HPR	AU_VIN1_P	D13	D7 I2C_SDA	D6 I2C_SCL
<b>C</b>	D2 SPI_SCLK	SPK_OUTP	AU_VIN1_N	D15	V2V8	VBAT
<b>D</b>	A2	SPK_OUTN	MICBIAS0	D12	D5	E_INT4 (1.8V)
<b>E</b>	A3	D4 SPI_MOSI	ACCDET	AU_VINO_P	GND	GND

Xadow 1.54" Touchscreen	
	Touch Screen (2.8V)
	TFT Display (1.8V)
	Backlight (2.8V)

Xadow Audio	
	Speaker & Microphone

External Devices	
	Headphone & Microphone

Others	
	VBAT: 3.3V - 4.2V
	2.8V
	Idle GPIOs (2.8V)
	GND

### Notice:

Some pinouts might be occupied if the corresponding module is operative in the system. Please check the availability of the pinouts of the Xadow GSM Breakout before using it. And also, do make sure you know exactly about the voltage level at each pinout (2.8V or 1.8V), irreversible damages might be caused if you mismatch it with a system working at higher voltage level.

### Specifications

Dimensions: 25.37mm X 20.30mm / 1" X 0.8"

### How to Use it

Connect the Xadow GSM Breakout to the Xadow GSM+BLE to draw out 30 pins from the 35 PIN Xadow connector.

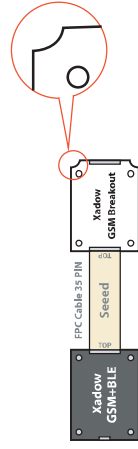

- If your project is based on Arduino IDE, please refer to the "Pin Definitions for Arduino IDE"
- If your project is based on Eclipse IDE, please refer to the "Pin Definitions for Eclipse IDE"

## Xadow LED 5x7

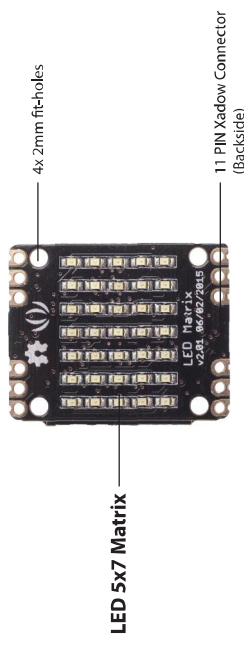

### Description

The Xadow LED 5x7 consists of a 5x7 monochrome LED matrix and a LED controller. You can send commands to the LED controller through I2C interface (address 0x21) to display numbers, letters or even pixel images this could come handy sometime in your project.

### Technical Details

Microcontroller: STM32F030F4  
 Core: ARM® 32-bit Cortex® -M0 CPU  
 Power Supply: 3.3 – 6 V (via breakout pins)  
 Flash: 16 KB  
 SRAM: 4 KB  
 Clock Speed: 48 MHz  
 Interfaces: Interface with Xadow GSM+BLE through I2C (7-bit address 0x21)  
 Dimension: 25.37mm X 20.30mm / 1" X 0.8"

### Use it with RePhone Kit Create

#### Display a characters:

Without any programming, you can connect it to the Core Module (Xadow GSM+BLE) of your 'RePhone Kit Create' to display numbers and letters using the Actuator Control'.

#### Set 'If This Then That':

You can also set conditions in the 'If This Then That' to trigger the Xadow LED 5x7 to display specific characters or pixel images.

## Xadow Basic Sensors

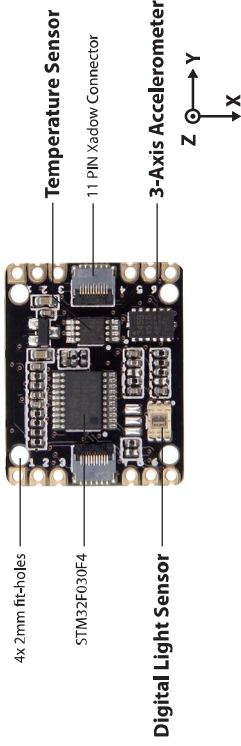

### Description

Xadow Basic Sensors integrates three different sensors on one single board:

- **3-Axis Accelerometer** for motion detection, activity monitoring and speed tracking
- Dual diode **Digital Light Sensor** that can separately measure infrared, full-spectrum or human-visible light
- **Temperature Sensor** for temperature monitoring

### Technical Details

Microcontroller:	STM32F030F4
Core:	ARM® 32-bit Cortex® -M0 CPU
Power Supply:	3.3 – 6V (via breakout pins)
Flash:	16 KB
SRAM:	4 KB
Clock Speed:	48 MHz
Operating Temperature Range:	-30°C to 70°C
Interfaces:	Interface with Xadow GSM+BLE through I2C (7-bit address 0x03)
Dimension:	25.37mm X 20.30mm / 1" X 0.8"
<u>3-Axis Accelerometer (ADXL345):</u>	
Test g Range:	±2g (default), ±4g, ±8g, or ±16g
Resolution:	Increase with g range, up to 13-bit resolution at ±16g

### Digital Light Sensor (TSL2561):

Approximates Human Eye Response  
 Dynamic Range (Lux): 0.1 to 40,000 Lux  
 Dual Photodiodes: Infrared and full spectrum

## Xadow Basic Sensors

### Temperature Sensor (LM75ADP):

Temperature Range: -55°C to 125°C  
 Accuracy: ± 2°C from -25°C to 100°C  
 ± 3°C from -55°C to 125°C

### *Use it with RePhone Kit Create*

#### Obtain the Sensor Data:

Without any programming, you can connect it to the Core Module (Xadow GSM+BLE) of your 'RePhone Kit Create' to read all the data from the sensors.

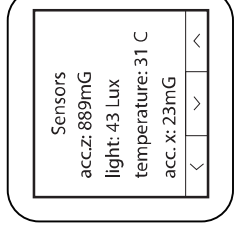

#### Set 'If This Then That':

You can also set the sensor data as a condition to trigger a series of actuators like audio, LED matrix and LED strip, or trigger actions like making a call and sending a message.

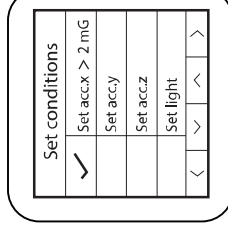



# Xadow Duino

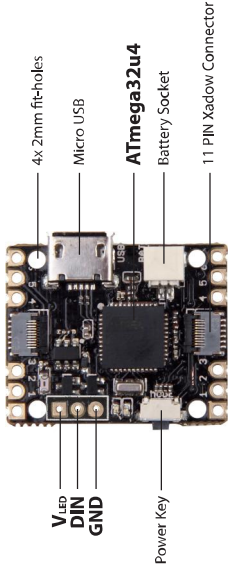

## Description

The Xadow Duino is specially designed for building up awesome Lighting Devices using the most popular RGB LED WS2812B. Based on the MCU ATmega32u4 and the built-in micro USB, Xadow Duino allows you to either control the RGB LEDs directly from the software in RePhone Kit Create, or program the board with Arduino IDE to make it work dependently.

Unlike any other add-on modules, this board also has its own battery socket (JST1.0 type), so you can power it in many ways:

- Via 5V USB (if the battery is connected, it would also charge the battery simultaneously)
- Via 3.7V Lipo battery
- Via breakout pins
- Via Xadow GSM+BLE

## Technical Details

<b>Microcontroller:</b>	ATmega32u4
<b>Power Supply:</b>	5 V via USB, current draw is 1.5 A at Max 3.3 – 4.2 V via battery socket, current draw is 1.5 A at Max 3.3 – 6 V via breakout pins, current draw is 500 mA at Max 3.3 – 4.2 V via Xadow GSM+BLE, current draw is 500 mA at Max 500 mA
<b>Charging Current:</b>	32 KB (ATmega32u4) of which 4 KB used by bootloader
<b>Flash Memory:</b>	2.5 KB (ATmega32u4)
<b>SRAM:</b>	1 KB (ATmega32u4)
<b>EEPROM:</b>	16 MHz
<b>Clock Speed:</b>	2x 11 PIN Connector for Xadow
<b>Connectors:</b>	Bonding pads for RGB LED WS2812B
<b>Interfaces:</b>	Interface with Xadow GSM+BLE through I2C (7-bit address 0x23)
<b>Dimension:</b>	25.37mm X 20.30mm / 1" X 0.8"

# Xadow Duino

## Light Things Up

Control the WS2812B with your 'RePhone Kit Create':

The easiest way to control the WS2812B is to use the built-in software in 'RePhone Kit Create', which provides an 'Actuator Control' application that allows you to light up the WS2812B in three different ways: 1. Monochrome, 2 Marquee, 3. Rainbow

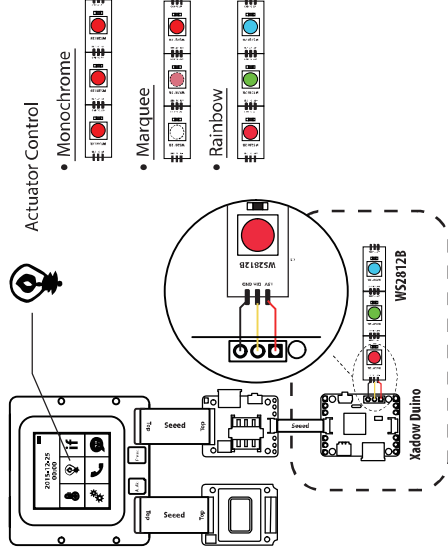

Set 'If This Then That':

In the 'If This Then That' you can set different conditions to trigger the Xadow Duino to light up the WS2812B in a specified mode.

Program it with Arduino IDE:

You can also do some coding with the Arduino IDE to customize your light sources.

There are many good projects on the internet, wondering how other people DIY cool lighting stuff? Check it out:

<http://www.seeedstudio.com/recipe/index.php?query=LED>

## About WS2812B

WS2812B is an intelligent control LED light source that can achieve 256 brightness display, completed 16777216 color full color display, and scan frequency not less than 400 Hz/s.

More info please refer to:

<http://www.seeedstudio.com/document/pdf/WS2812B%20Datasheet.pdf>

## Xadow GPS v2



### Description

Based on the GPS L70 module from Quectel®, the Xadow GPS v2 combines the advanced AGPS technology EASYTM (Embedded Assist System) and the AlwaysLocate™ technology to achieve high performance, ultra-low power consumption and fast positioning even at indoor signal levels. With an excellent high-sensitivity receiver (-163dBm tracking) and a built-in chip antenna, the module can track up to 22 satellites on 66 channels, making it a perfect choice for navigation projects. The board also adopts the new 11 PIN Xadow connector to improve the flexibility of module connections.

### Features

- EASY™, advanced AGPS technology without the need for external memory
- Ultra-low power consumption in tracking mode
- AlwaysLocate™, an intelligent controller of periodic mode
- LOCUS, innate logger solution with no need for host and external flash
- High sensitivity
- Support QZSS
- Support DGPS, SBAS(WAAS/EGNOS/MSAS/GAGAN)
- Anti-jamming, Multi-tone Active Interference Canceller
- Built-in chip antenna with efficiency up to 83%

### Technical Details

Microcontroller:	Kinetis KL02
Core:	ARM® 32-bit Cortex®-M0+CPU
Power Supply:	3.3 – 6 V (via breakout pins)
Flash:	32 KB
SRAM:	4 KB
Clock Speed:	48 MHz
Power Consumption:	max. 28 mA
Power Saving:	Typ. 3 mA @ AlwaysLocate™ 7 uA @ Backup Mode 180 uA @ Standby Mode
Channel:	22 (Tracking) / 66 (Acquisition)
Update Rate:	1 Hz(Default), up to 10 Hz
Horizontal Position Accuracy:	<2.5m CEP
Velocity Accuracy:	<0.1m/s
Maximum Velocity:	Max.515m/s
Cold/warm start with EASYTM:	15s/5s
Acquisition Sensitivity:	-145 dBm
Tracking Sensitivity:	-163 dBm
Operating Temperature:	-40℃ to 85℃
Protocols:	NMEA 0183/PMTK
Antenna Type:	Chip antenna
Interface:	Interface with Xadow GSM+BLE through I2C (7-bit address 0x05)
Dimensions:	25.37mm X 20.30mm / 1" X 0.8"

### Global Positioning System (GPS)

The Global Positioning System (GPS) is a space-based navigation system that provides real-time and all-weather geographic position, altitude, travelling speed and time information anywhere on or near the earth where there is an unobstructed line of sight to four or more GPS satellites. It was formerly used only by military projects, now it is freely accessible to anyone with a GPS receiver. The typical applications of GPS covers automobile navigation, time transfer, traffic signal timing, anti-theft and tracking devices etc.

## Xadow NFC v2

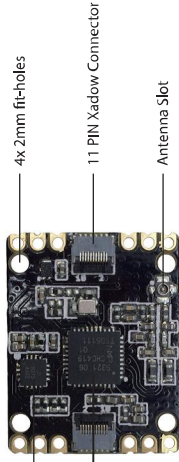

### Description

The Xadow NFC v2 features the most popular NFC chip-set on the market - a highly integrated transceiver module PN532. This chipset is very powerful and can be seen in most of smartphones and NFC devices. It can be used to read and write to tags and cards, acting like NFC tags. Currently we've developed Arduino libraries to support reading and writing to MIFARE Class and MIFARE Ultralight Card.

The board also adopts the new 11 PIN Xadow connector to improve the flexibility of module connections.

### Technical Details

Microcontroller:	Kinetis KL02
Core:	ARM® 32-bit Cortex® -M0+CPU
Power Supply:	3.3 – 6 V (via breakout pins)
Flash:	32 KB
SRAM:	4 KB
Working Current:	5 mA at standby; 55 mA when read/write
Radio Frequency:	13.56 MHz.
Supported protocols:	ISO/IEC 14443 Type A and ISO/IEC 14443 Type B
Max Operating Distance:	~28mm depending on the current antenna size.
Dimensions:	25.43mm x 20.35mm

### Near Field Communication (NFC)

Near Field Communication (NFC) is the set of protocols for the communication of electronic devices that are close proximity to each other (typically 10cm or less). Full NFC devices usually have three working mode:

- Card Emulation: typically used in entrance card, or in smartphones to let them acts like smart cards to perform payment process or ticketing
- Reader/Writer Mode: used to read the information stored in the NFC tags
- Peer-to-peer Mode : used for data exchanging between devices

## RePhone Kit Create

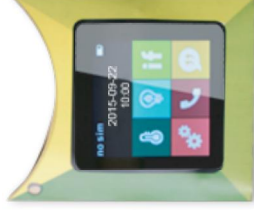

### Description

If you ever wished to make a phone in minute, then this RePhone Kit Create is your dream come true. Simply connect the modules with ribbon FPC cables, everyone can make a phone from scratch. The RePhone Kit Create also comes with paperboard that allows you to use paper craft to build and customise cases for the RePhone modules in a variety of styles and shapes.

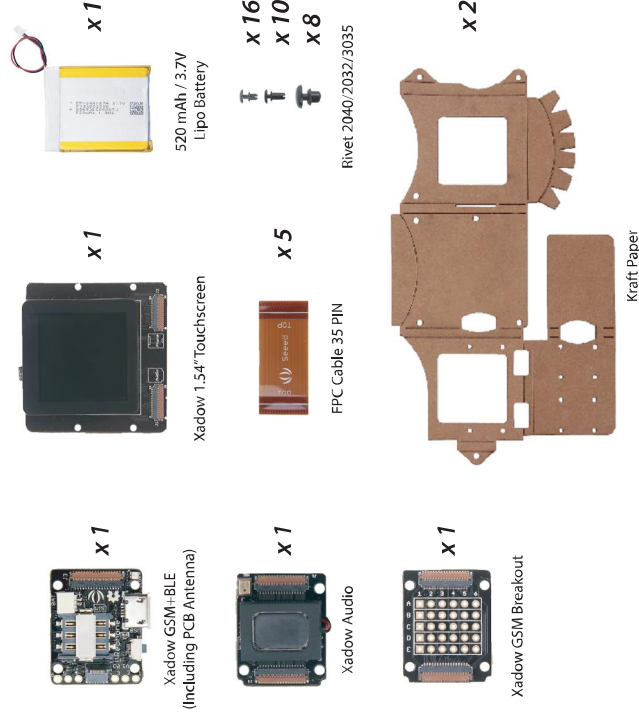

## RePhone Kit Create - Phone Case Assembly

### How to use Rivets

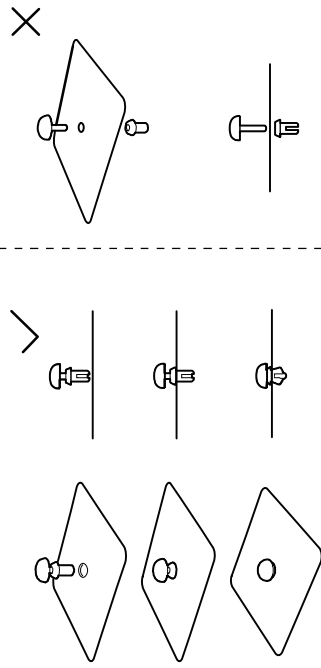

### Explosive View

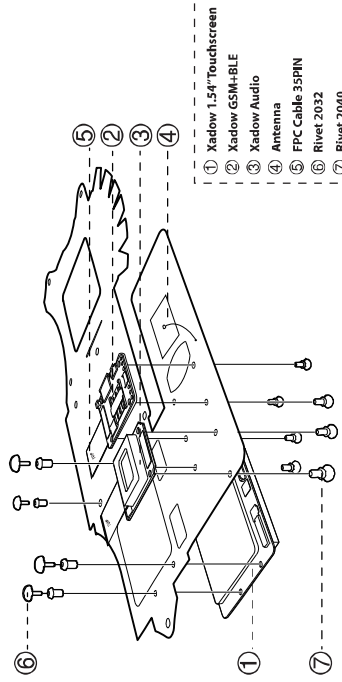

- ① Xadow 1.54" Touchscreen
- ② Xadow GSM+BLE
- ③ Xadow Audio
- ④ Antenna
- ⑤ FPC Cable 35PIN
- ⑥ Rivet 2032
- ⑦ Rivet 2040

### Phone case

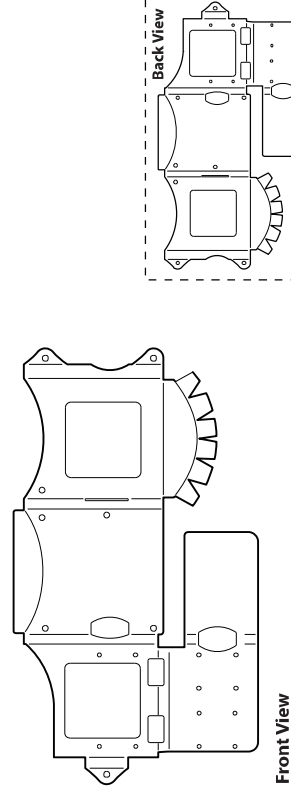

Front View

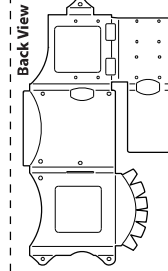

Back View

## RePhone Kit Create - Phone Case Assembly

### Module Connection

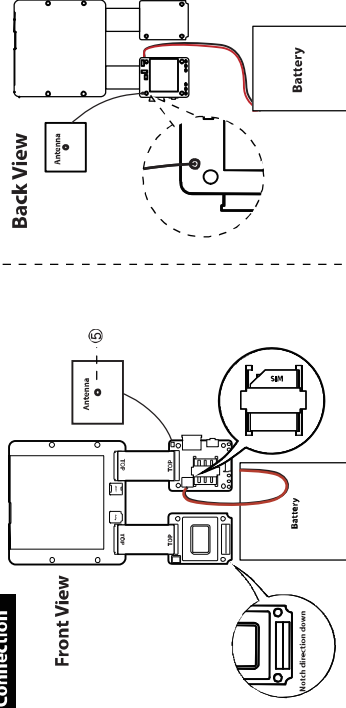

- ① Xadow 1.54" Touchscreen
- ② FPC Cable 35 PIN

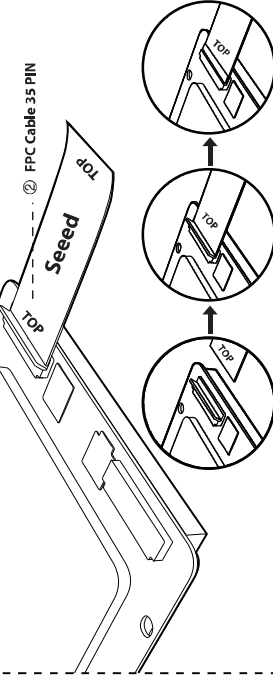

### STEP1: Pre-connect ② to the both connectors on ①

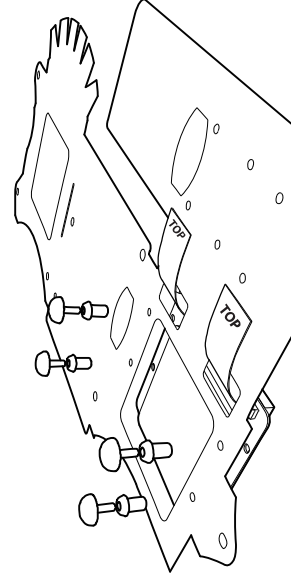

### STEP2: Fix the Xadow 1.54" Touchscreen with Rivet 2032

## RePhone Kit Create - Phone Case Assembly

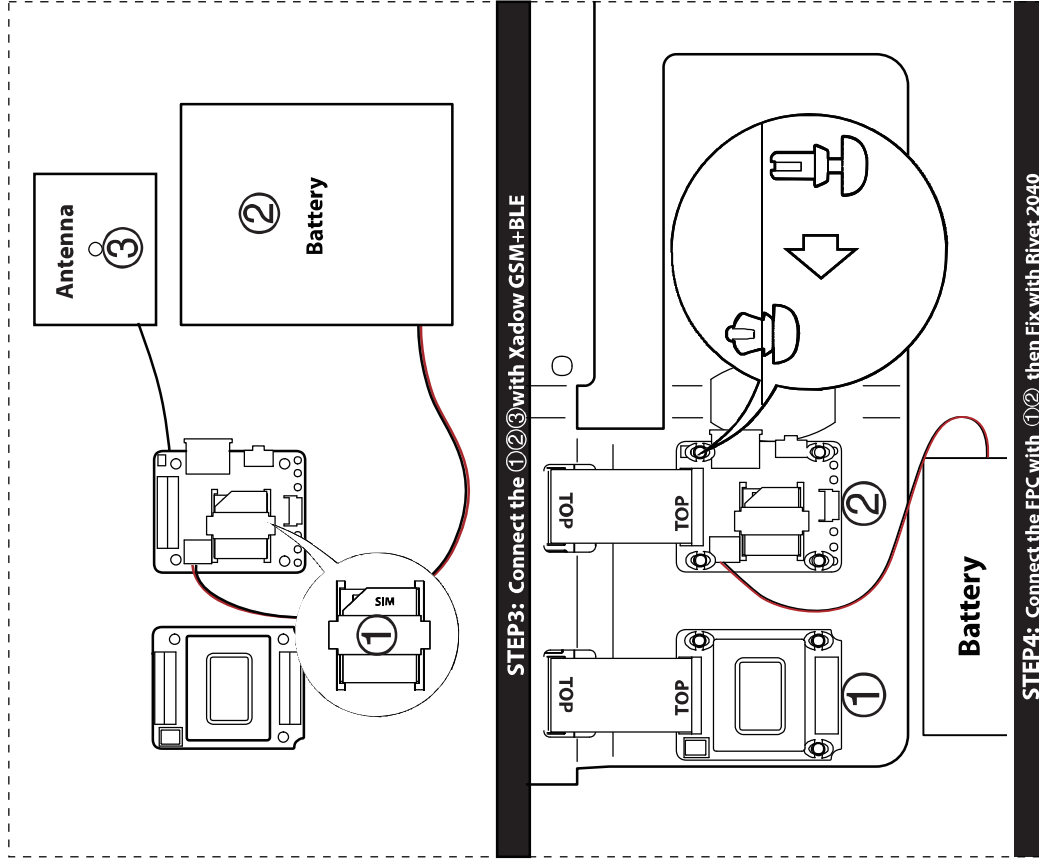

## RePhone Kit Create - Phone Case Assembly

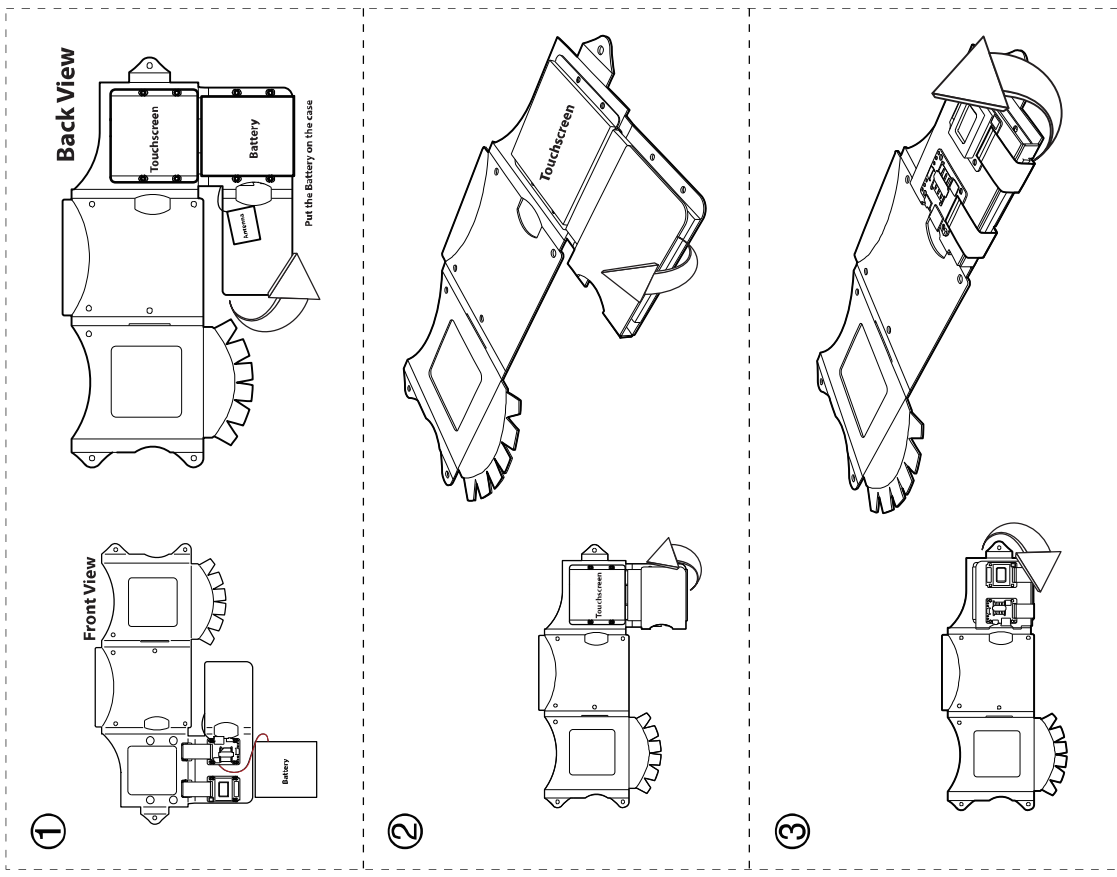

# RePhone Kit Create - Phone Case Assembly

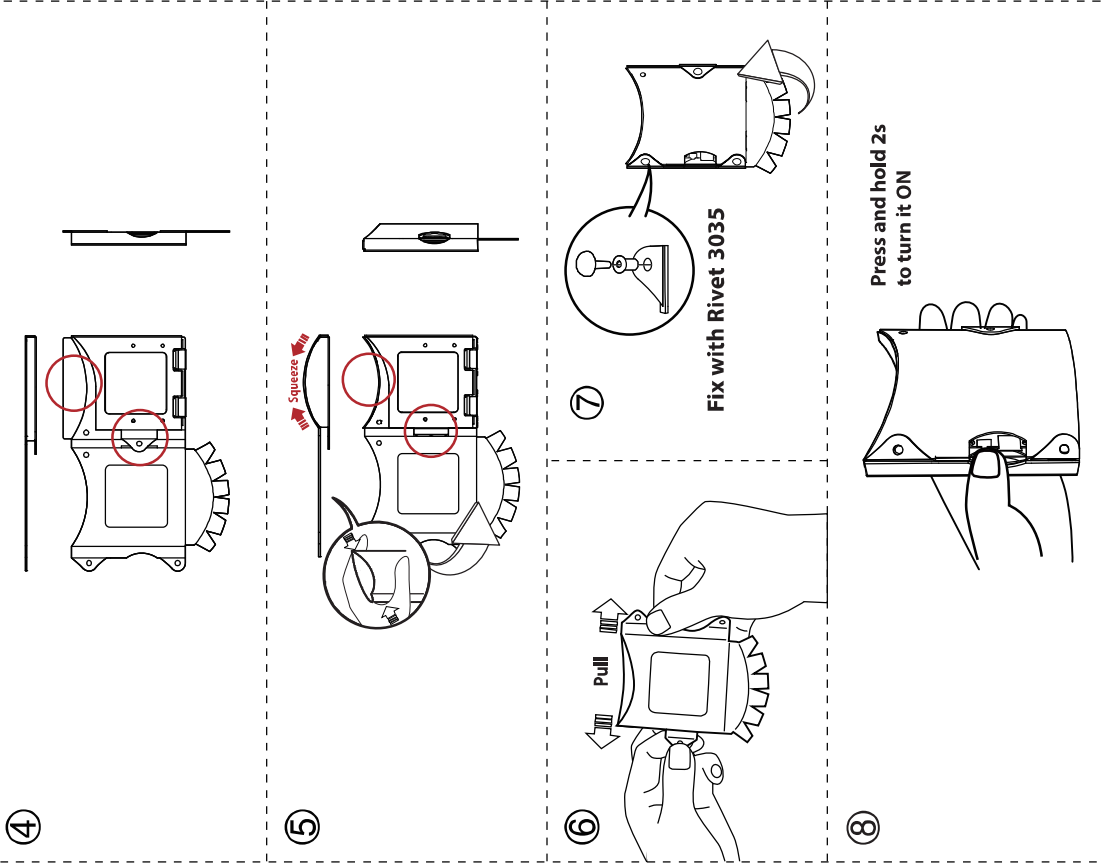

# RePhone Kit Create - Phone Case Assembly

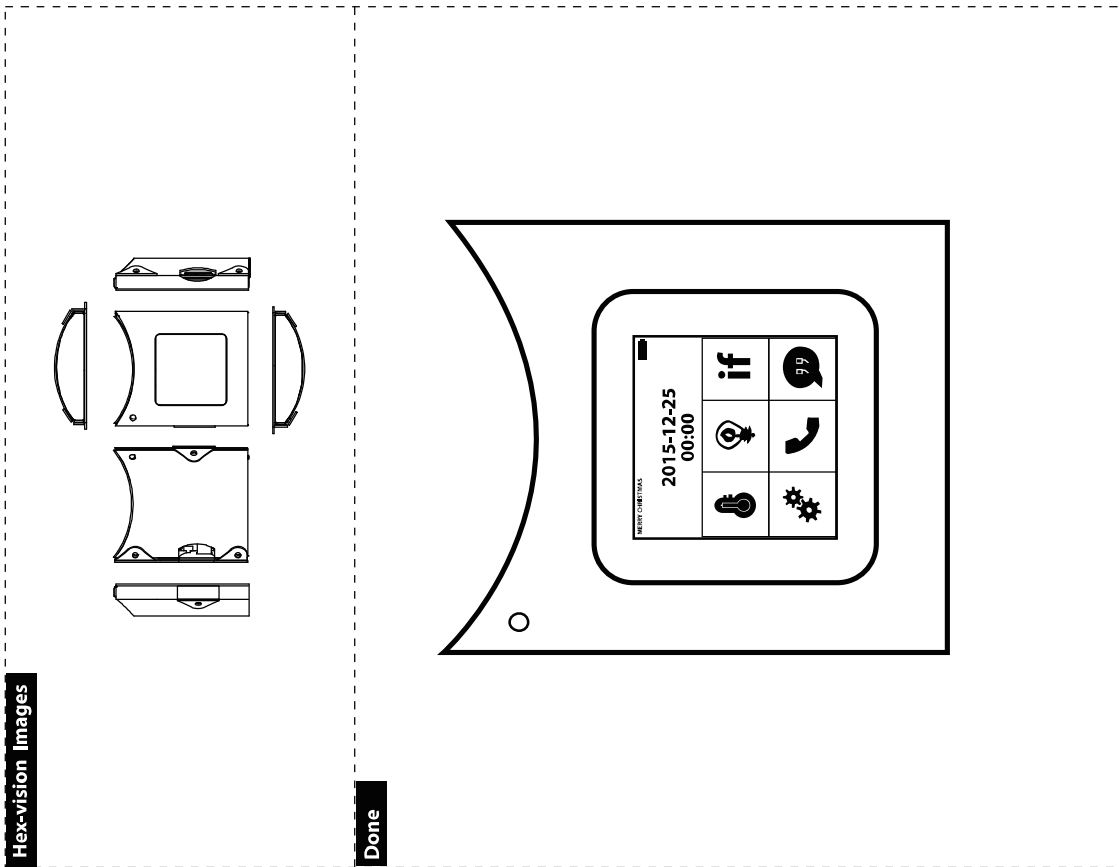

## RePhone Kit Create - Operation Interface



### Real-time Sensor Data Acquisition

RePhone has plug-and-play features, simply connect the add-on modules like Xadow Basic Sensors and Xadow GPS v2 to the Xadow GSM+BLE of your RePhone Kit Create, then you can easily access the real-time sensor values on the screen.



### Actuator Control

Without any programming, you are able to play with a series of actuators, eg. Lighting up RGB LED strip, displaying characters and pixel images on the LED matrix, or playing lovely music with the audio speaker etc.

### if If This Then That

We've added this distinguishing feature to RePhone to let your RePhone work for you. You can pre-set few conditional statements that trigger actions like automatically make a phone call, send out a message, or activate a series of actuators.

- **Back up or share your 'If This Then That' Configurations**

Access the 'Mass Storage Mode' by connecting your RePhone (with battery plugged in and phone turned off) to PC via Micro USB cable, back up or share the file 'ifttt\_book.txt' to back up or share your 'If This Then That' configurations.



### Setting

Here you can set the brightness of screen backlight from a range of 0 (dimmiest) to 6, and also tune the volume from 0 (mute) to 6. The volume refers to the sound volume when playing a music with Xadow Audio.

## RePhone Kit Create - Operation Interface



### Call

You will need a Nano SIM card to access the GSM network. If you see a 'No SIM' on the top left corner of your display, recheck the SIM card connection until the 'No SIM' disappears.

- **Add, delete or edit Contacts**

Access the 'Mass Storage Mode' by connecting your RePhone (with battery plugged in and phone turned off) to PC via Micro USB cable, open the file named 'address\_book.txt' to add, delete or edit your contacts in the following format:

```
Format: "Name, Phone Number".
Examples:
James,1234567890
Kyle,1233211230
Eric,8886668880
```

Do not miss the **comma** between the name and the phone number, **change line** to add new contacts.

You can preserve up to **20 contacts** in your RePhone.



### SMS

The RePhone only keeps the latest 8 messages, the newly received message will squeeze out the most previous one in the inbox.

As RePhone does not have any keyboard or input-method, you cannot directly type messages on your RePhone, instead you need to pre-set some short messages in your SMS book to send messages.

- **Add, delete or edit SMS**

Access the 'Mass Storage Mode' by connecting your RePhone (with battery plugged in and phone turned off) to PC via Micro USB cable, open the file named "sms\_book.txt" to add, delete or edit messages in the following format:

```
-----
Hello!
I am busy at the moment, will call back later.
See you!
This is RePhone.
```

Each message has a maximum length at **100 characters**, **change lines** to add new messages.

## RePhone Geo/Lumi Kit

### RePhone Geo Kit



**Xadow GSM Breakout**

**Xadow GSM+BLE**

**Xadow GPS v2**

#### Description:

The combination of GSM module and GPS module is what makes RePhone Geo Kit brilliant. The kit allows you to obtain the real-time geographic position, altitude, travelling speed and time information at any time, and all-weather conditions, through GSM network (SMS). Also as a bonus, the Xadow GSM Breakout can provides you more possibilities hacking electronics.

#### What's included:

- Xadow GSM+BLE x 1
- Xadow GPS v2 x 1
- Xadow GSM Breakout x 1
- 520mAh Lipo Battery x 1
- FPC Cable 35 PIN x 2
- FPC Cable 11 PIN x 2

### RePhone Lumi Kit



**Xadow GSM Breakout**

**Xadow GSM+BLE**

**Xadow Duino**

#### Description:

RePhone Lumi Kit is specially designed for LED lovers - embedding the Xadow GSM+BLE module into your awesome lighting device and control the light via SMS or Bluetooth!

#### What's included:

- Xadow GSM+BLE x 1
- Xadow Duino x 1
- Xadow GSM Breakout x 1
- 520mAh Lipo Battery x 1
- FPC Cable 35 PIN x 2
- FPC Cable 11 PIN x 2

## RePhone Extension Pack

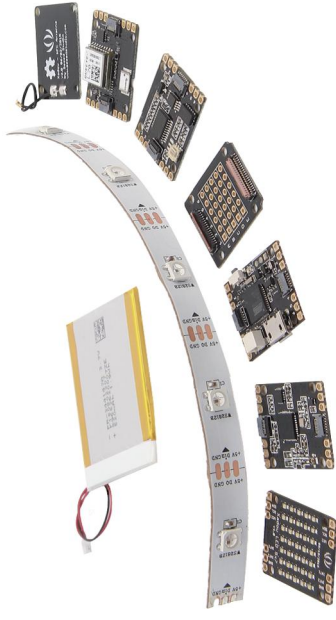

### Description

The RePhone Extension Pack includes 6 rich-featured add-on modules for you to extend the functionalities of your RePhone project. The pack includes Xadow LED 5x7, Xadow NFC v2, Xadow Duino, Xadow GSM Breakout, Xadow Basic Sensors and Xadow GPS v2. All the modules have the plug-and-play features if you connect them with the RePhone Kit Create. For more details please refer to the corresponding modules described in the previous sections.

### Item List

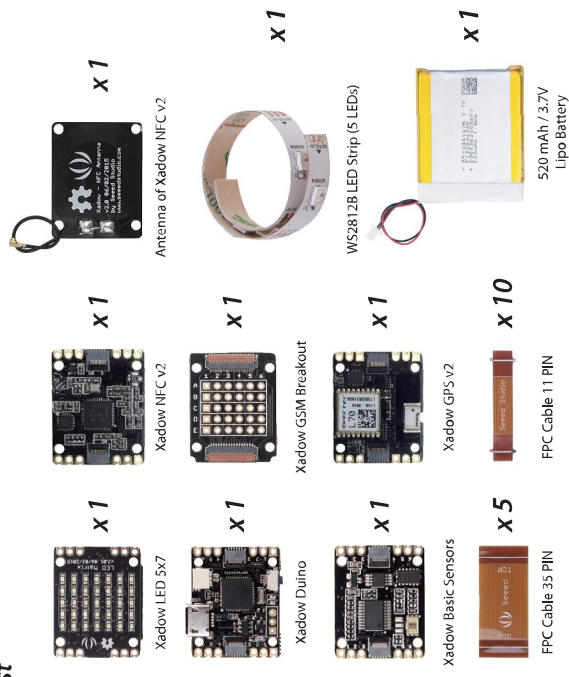



## More Info & Appendix

Please visit our website for more information about the Development Environment Installation tutorial, Software Development Kit (SDK), example sketches, and technical details of each module: Wiki: <http://www.seeedstudio.com/wiki/RePhone>

Also find interesting projects of RePhone at:

Recipe - under 'RePhone' topic: <http://www.seeedstudio.com/recipe/>

### Table of Xadow GSM Breakout Pinouts Definitions

Pin	Definition	Description
A1	GPIO29/SPL_MISO	General purpose I/O 29 (2.8V)
A2	AU_HPL	SPI bus Master Input/Slave Output
A3	AU_VINO_N	Audio headphone out (L channel)
A4	GPIO49	Microphone 0 input (negative)
A5	GPIO10/UART1_RX	General purpose I/O 49 (1.8V)
A6	GPIO11/UART1_TX	General purpose I/O 10 (2.8V)
B1	GPIO3/PWM	UART1 receive data
B2	AU_HPR	General purpose I/O 11 (2.8V)
B3	AU_VIN1_P	UART1 transmit data
B4	GPIO48	General purpose I/O 3 (2.8V)
B5	GPIO44/I2C_SDA	PWM
B6	GPIO43/I2C_SCL	Audio headphone out (R channel)
C1	GPIO27/SPL_SCLK	Microphone 1 input (positive)
C2	SPK_OUTP	General purpose I/O 48 (1.8V)
C3	AU_VIN1_N	General purpose I/O 44 (2.8V)
C4	GPIO50	I2C data
C5	2V8	General purpose I/O 43 (2.8V)
C6	VBAT	I2C clock
D1	GPIO1/A1	General purpose I/O 27 (2.8V)
D2	SPK_OUTN	SPI clock
		Speaker positive output
		Microphone 1 input (negative)
		General purpose I/O 50 (1.8V)
		2.8V power source
		3.3 - 4.2V
		General purpose I/O 1
		Analog input 1
		Speaker negative output

## More Info & Appendix

D3	MICBIAS0	Microphone bias source 0
D4	GPIO47	General purpose I/O 47 (1.8V)
D5	GPIO19	General purpose I/O 19 (2.8V)
D6	GPIO46	General purpose I/O 46 (1.8V)
E1	GPIO2/IA2	General purpose I/O 2 (2.8V)
		Analog input 2
E2	GPIO28/SPL_MOSI	General purpose I/O 28 (2.8V)
E3	ACCDDET	SPI Master Output/Slave Input
E4	AU_VIN0_P	Accessory detection
E5	GND	Microphone 0 input(positive)
E6	GND	Ground
		Ground

### Declaration of Conformity

This device complies with Part 15 of the FCC Rules. Operation is subject to the following two conditions: (1) this device may not cause harmful interference, and (2) this device must accept any interference received, including interference that may cause undesired operation. Changes or modifications not expressly approved by the party responsible for compliance could void the user's authority to operate the equipment.

Please notice that if the FCC identification number is not visible when the module is installed inside another device, then the outside of the device into which the module is installed must also display a label referring to the enclosed module. This exterior label can use wording such as the following: "Contains FCC ID:Z4TXADOW-GSMBTV10" any similar wording that expresses the same meaning may be used.

This equipment complies with FCC radiation exposure limits set forth for an uncontrolled environment. This equipment should be installed and operated with a minimum distance of 20cm between the radiator & your body. This transmitter must not be co-located or operating in conjunction with any other antenna or transmitter.

The module is limited to OEM installation ONLY.

The OEM integrator is responsible for ensuring that the end-user has no manual instruction to remove or install module.

The module is limited to installation in mobile application;

A separate approval is required for all other operating configurations, including portable configurations with respect to Part 2.1093 and difference antenna configurations.

There is requirement that the grantee provide guidance to the host manufacturer for compliance with Part 15B requirements.

