

FCC TEST REPORT

Client Name : Seed Technology Co., Ltd.
Address : 9F, G3 Building, TCL International E City,
Zhongshanyuan Road, Nanshan District, Shenzhen,
China 518055
Product Name : WM1302 LoRaWAN Gateway Module(USB) - US915
Date : Jul. 14, 2021



Shenzhen Anbotek Compliance Laboratory Limited

Contents

| | |
|---|----|
| 1. General Information..... | 4 |
| 1.1. Client Information..... | 4 |
| 1.2. Description of Device (EUT)..... | 4 |
| 1.3. Auxiliary Equipment Used During Test..... | 5 |
| 1.4. Description of Test Configuration..... | 5 |
| 1.5. Description Of Test Setup..... | 6 |
| 1.6. Test Equipment List..... | 7 |
| 1.7. Measurement Uncertainty..... | 8 |
| 1.8. Description of Test Facility..... | 8 |
| 2. Summary of Test Results..... | 9 |
| 3. Conducted Emission Test..... | 10 |
| 3.1. Test Standard and Limit..... | 10 |
| 3.2. Test Setup..... | 10 |
| 3.3. Test Procedure..... | 10 |
| 3.4. Test Data..... | 10 |
| 4. Radiation Spurious Emission and Band Edge..... | 13 |
| 4.1. Test Standard and Limit..... | 13 |
| 4.2. Test Setup..... | 13 |
| 4.3. Test Procedure..... | 14 |
| 4.4. Test Data..... | 15 |
| 5. Antenna Requirement..... | 21 |
| 5.1. Test Standard and Requirement..... | 21 |
| 5.2. Antenna Connected Construction..... | 21 |
| APPENDIX I -- TEST SETUP PHOTOGRAPH..... | 22 |
| APPENDIX II -- EXTERNAL PHOTOGRAPH..... | 24 |
| APPENDIX III -- INTERNAL PHOTOGRAPH..... | 27 |

TEST REPORT

Applicant : Seeed Technology Co., Ltd.
Manufacturer : Seeed Technology Co., Ltd.
Product Name : WM1302 LoRaWAN Gateway Module(USB) - US915
Model No. : WM1302-USB-US915
Trade Mark : Seeed Studio
Rating(s) : Input: DC 3.3V/430mA

Test Standard(s) : FCC Part15 Subpart, Section 15.247

Test Method(s) : ANSI C63.10: 2013, KDB558074 D01 DTS Meas Guidance v05r02

The device described above is tested by Shenzhen Anbotek Compliance Laboratory Limited to determine the maximum emission levels emanating from the device and the severe levels of the device can endure and its performance criterion. The measurement results are contained in this test report and Shenzhen Anbotek Compliance Laboratory Limited is assumed full of responsibility for the accuracy and completeness of these measurements. Also, this report shows that the EUT (Equipment Under Test) is technically compliant with the FCC Part 15 Subpart C requirements.

This report applies to above tested sample only and shall not be reproduced in part without written approval of Shenzhen Anbotek Compliance Laboratory Limited.

Date of receipt

Jul. 06, 2021

Date of Test

Jul. 06~13, 2021

Prepared By



(Engineer / Ella Liang)

Approved & Authorized Signer



(Manager / Kingkong Jin)

1. General Information

1.1. Client Information

| | | |
|--------------|---|---|
| Applicant | : | Seed Technology Co., Ltd. |
| Address | : | 9F, G3 Building, TCL International E City, Zhongshanyuan Road, Nanshan District, Shenzhen, China 518055 |
| Manufacturer | : | Seed Technology Co., Ltd. |
| Address | : | 9F, G3 Building, TCL International E City, Zhongshanyuan Road, Nanshan District, Shenzhen, China 518055 |
| Factory | : | Shenzhen Xinxian Technology Co; Limited |
| Address | : | F5, Building B17, Hengfeng Industrial City, No. 739 Zhoushi Rd, Baoan District, Shenzhen, Guangdong, P.R.C. |

1.2. Description of Device (EUT)

| | | | |
|--|---|---|----------------------------|
| Product Name | : | WM1302 LoRaWAN Gateway Module(USB) - US915 | |
| Model No. | : | WM1302-USB-US915 | |
| Trade Mark | : | Seed Studio | |
| Test Power Supply | : | DC 3.3V by Debug board | |
| Test Sample No. | : | 1-2-1(Normal Sample), 1-2-2(Engineering Sample) | |
| Product Description | : | Operation Frequency: | 902~928MHz |
| | | Number of Channel: | 8 Channels |
| | | Modulation Type: | LoRa Chirp Spread Spectrum |
| | | Antenna Type: | Cylindrical antenna |
| | | Antenna Gain(Peak): | 2.6 dBi |
| Remark: 1) For a more detailed features description, please refer to the manufacturer's specifications or the User's Manual. | | | |

1.3. Auxiliary Equipment Used During Test

| | | |
|---------|---|--|
| Adapter | : | M/N: SAW12-050-2100UB Input: 100-240V~ 50/60Hz, 0.3A Output: DC 5V, 2100mA |
|---------|---|--|

1.4. Description of Test Configuration

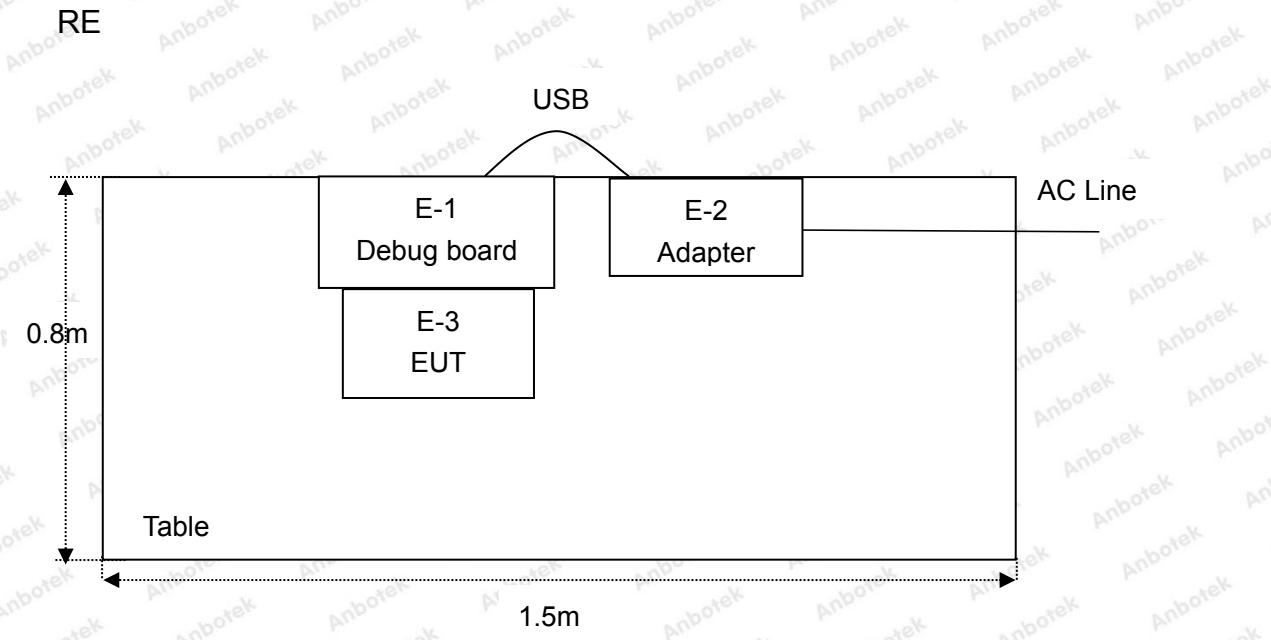
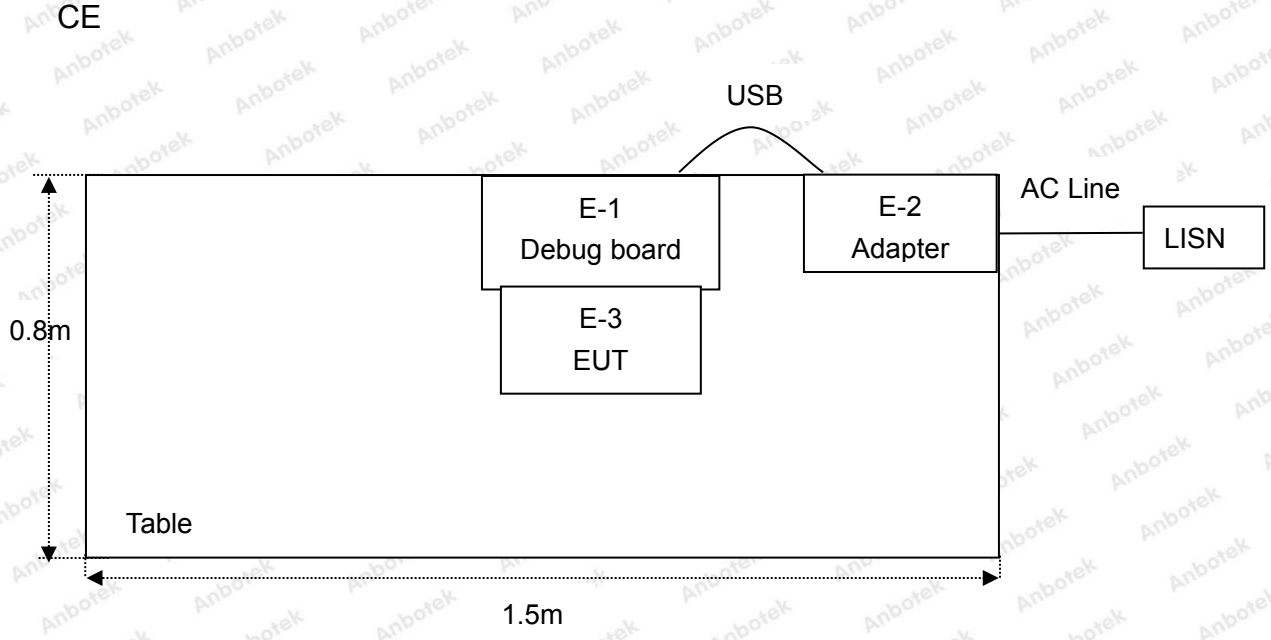
The system was configured for testing in testing mode, which was provided by manufacturer.

For LoRa mode, Detailed Frequency as below:

| Channel | Frequency (MHz) | Channel | Frequency (MHz) |
|---------|-----------------|---------|-----------------|
| 1 | 923.3 | 5 | 925.7 |
| 2 | 923.9 | 6 | 926.3 |
| 3 | 924.5 | 7 | 926.9 |
| 4 | 925.1 | 8 | 927.5 |

Note: EUT was tested with Channel 1 and 8.

1.5. Description Of Test Setup



1.6. Test Equipment List

| Item | Equipment | Manufacturer | Model No. | Serial No. | Last Cal. | Cal. Interval |
|------|---|----------------------------|------------------|---------------|---------------|---------------|
| 1. | L.I.S.N. Artificial Mains Network | Rohde & Schwarz | ENV216 | 100055 | Oct. 26, 2020 | 1 Year |
| 2. | EMI Test Receiver | Rohde & Schwarz | ESCI | 100627 | Oct. 26, 2020 | 1 Year |
| 3. | EMI Test Receiver | Rohde & Schwarz | ESR26 | 101481 | Oct. 26, 2020 | 1 Year |
| 4. | RF Switching Unit | Compliance Direction | RSU-M2 | 38303 | Oct. 26, 2020 | 1 Year |
| 5. | MAX Spectrum Analysis | Agilent | N9020A | MY51170037 | Oct. 26, 2020 | 1 Year |
| 6. | Preamplifier | SKET Electronic | BK1G18G30 D | KD17503 | Oct. 26, 2020 | 1 Year |
| 7. | Double Ridged Horn Antenna | Instruments corporation | GTH-0118 | 351600 | Nov. 02, 2020 | 2 Year |
| 8. | Bilog Broadband Antenna | Schwarzbeck | VULB9163 | VULB 9163-289 | Nov. 02, 2020 | 2 Year |
| 9. | Loop Antenna | Schwarzbeck | FMZB1519B | 00053 | Nov. 02, 2020 | 2 Year |
| 10. | Horn Antenna | A-INFO | LB-180400- KF | J211060628 | Nov. 02, 2020 | 2 Year |
| 11. | Pre-amplifier | SONOMA | 310N | 186860 | Oct. 26, 2020 | 1 Year |
| 12. | EMI Test Software EZ-EMC | SHURPLE | N/A | N/A | N/A | N/A |
| 13. | RF Test Control System | YIHENG | YH3000 | 2017430 | Oct. 26, 2020 | 1 Year |
| 14. | Power Sensor | DAER | RPR3006W | 15I00041SN045 | Oct. 26, 2020 | 1 Year |
| 15. | Power Sensor | DAER | RPR3006W | 15I00041SN046 | Oct. 26, 2020 | 1 Year |
| 16. | MXA Spectrum Analysis | Agilent | N9020A | MY51170037 | Oct. 26, 2020 | 1 Year |
| 17. | MXG RF Vector Signal Generator | Agilent | N5182A | MY48180656 | Oct. 26, 2020 | 1 Year |
| 18. | Signal Generator | Agilent | E4421B | MY41000743 | Oct. 26, 2020 | 1 Year |
| 19. | DC Power Supply | IVYTECH | IV3605 | 1804D360510 | Oct. 26, 2020 | 1 Year |
| 20. | Constant Temperature Humidity Chamber | ZHONGJIAN | ZJ-KHWS80 B | N/A | Oct. 26, 2020 | 1 Year |

1.7. Measurement Uncertainty

| | | |
|------------------------|---|--------------------------|
| Radiation Uncertainty | : | Ur = 3.9 dB (Horizontal) |
| | | Ur = 3.8 dB (Vertical) |
| Conduction Uncertainty | : | Uc = 3.4 dB |

1.8. Description of Test Facility

The test facility is recognized, certified, or accredited by the following organizations:

FCC-Registration No.: 184111

Shenzhen Anbotek Compliance Laboratory Limited, EMC Laboratory has been registered and fully described in a report filed with the (FCC) Federal Communications Commission. The acceptance letter from the FCC is maintained in our files. Registration No. 184111, September 30, 2020.

ISED-Registration No.: 8058A

Shenzhen Anbotek Compliance Laboratory Limited, EMC Laboratory has been registered and fully described in a report filed with the (ISED) Innovation, Science and Economic Development Canada. The acceptance letter from the ISED is maintained in our files. Registration 8058A, September 30, 2020.

Test Location

Shenzhen Anbotek Compliance Laboratory Limited.

1/F, Building D, Sogood Science and Technology Park, Sanwei community, Hangcheng Street, Bao'an District, Shenzhen, Guangdong, China.518102

2. Summary of Test Results

| Standard Section | Test Item | Result |
|---|---------------------|--------|
| 15.203/15.247(c) | Antenna Requirement | PASS |
| 15.207 | Conducted Emission | PASS |
| 15.205/15.209 | Spurious Emission | PASS |
| Remark: "N/A" is an abbreviation for Not Applicable. | | |

This is a Class II application of the device, the difference between the original device and current one described as following:

(1) Change the Antenna Gain to "2.6dBi".

Based on the change made to the device, the spurious emission test items were performed.

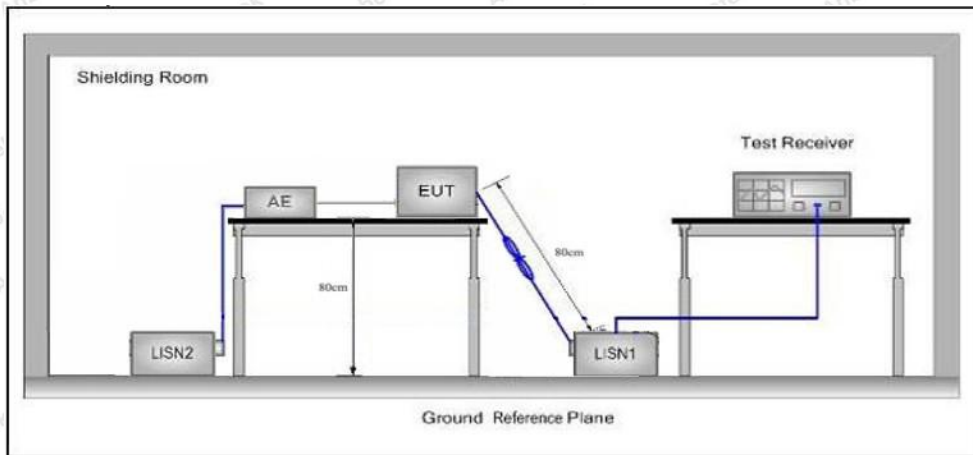
3. Conducted Emission Test

3.1. Test Standard and Limit

| Test Standard | FCC Part15 Section 15.207 | | |
|---------------|---------------------------|--------------------------------|---------------|
| Test Limit | Frequency | Maximum RF Line Voltage (dBuV) | |
| | | Quasi-peak Level | Average Level |
| | 150kHz~500kHz | 66 ~ 56 * | 56 ~ 46 * |
| | 500kHz~5MHz | 56 | 46 |
| 5MHz~30MHz | 60 | 50 | |

Remark: (1) *Decreasing linearly with logarithm of the frequency.
(2) The lower limit shall apply at the transition frequency.

3.2. Test Setup



3.3. Test Procedure

The EUT system is connected to the power mains through a line impedance stabilization network (L.I.S.N.). This provides a 50ohm coupling impedance for the EUT system. Please refer the block diagram of the test setup and photographs. Both sides of AC line are checked to find out the maximum conducted emission. In order to find the maximum emission levels, the relative positions of equipment and all of the interface cables shall be changed according to FCC ANSI C63.10-2013 on Conducted Emission Measurement.

The bandwidth of test receiver (ESCI) set at 9kHz.

The frequency range from 150kHz to 30MHz is checked.

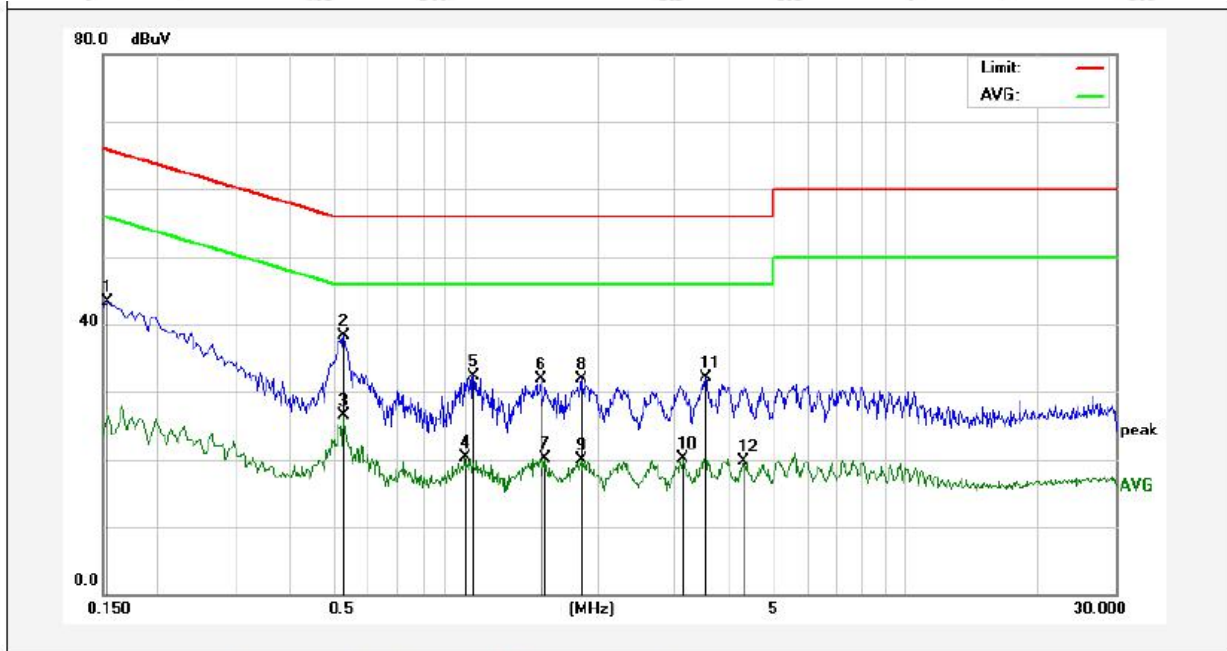
3.4. Test Data

During the test, pre-scan all the modes, and found CH08 (TX) which is the worst case, only the worst case is recorded in the report.

Please to see the following pages.

Conducted Emission Test Data

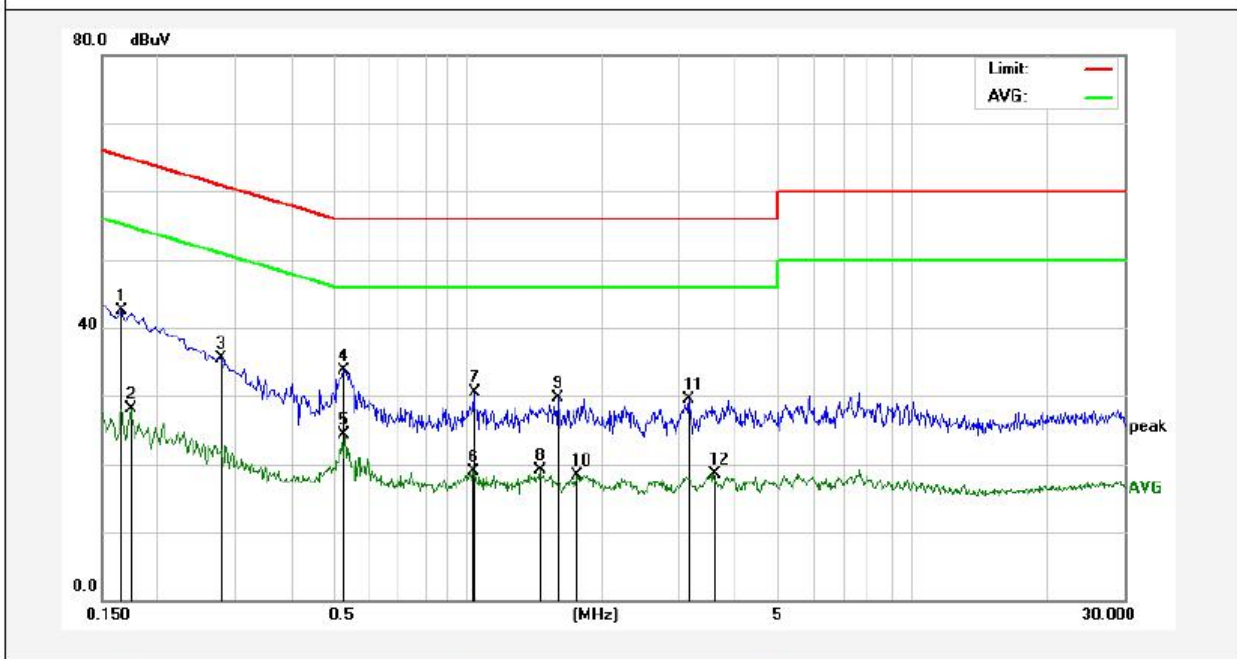
Test Site: 1# Shielded Room
 Operating Condition: CH08
 Test Specification: AC 120V, 60Hz
 Comment: Live Line
 Tem.: 22.4°C Hum.: 53%



| No. | Freq. (MHz) | Reading (dBuV) | Factor (dB) | Result (dBuV) | Limit (dBuV) | Over Limit (dB) | Detector | Remark |
|-----|-------------|----------------|-------------|---------------|--------------|-----------------|----------|--------|
| 1 | 0.1539 | 23.41 | 19.90 | 43.31 | 65.78 | -22.47 | QP | |
| 2 | 0.5299 | 18.34 | 19.99 | 38.33 | 56.00 | -17.67 | QP | |
| 3 | 0.5299 | 6.50 | 19.99 | 26.49 | 46.00 | -19.51 | AVG | |
| 4 | 0.9980 | 0.10 | 20.12 | 20.22 | 46.00 | -25.78 | AVG | |
| 5 | 1.0460 | 12.10 | 20.12 | 32.22 | 56.00 | -23.78 | QP | |
| 6 | 1.4819 | 11.86 | 20.13 | 31.99 | 56.00 | -24.01 | QP | |
| 7 | 1.5260 | 0.02 | 20.13 | 20.15 | 46.00 | -25.85 | AVG | |
| 8 | 1.8380 | 11.79 | 20.14 | 31.93 | 56.00 | -24.07 | QP | |
| 9 | 1.8380 | -0.31 | 20.14 | 19.83 | 46.00 | -26.17 | AVG | |
| 10 | 3.1380 | -0.02 | 20.16 | 20.14 | 46.00 | -25.86 | AVG | |
| 11 | 3.5100 | 12.02 | 20.17 | 32.19 | 56.00 | -23.81 | QP | |
| 12 | 4.2780 | -0.45 | 20.19 | 19.74 | 46.00 | -26.26 | AVG | |

Conducted Emission Test Data

Test Site: 1# Shielded Room
 Operating Condition: CH08
 Test Specification: AC 120V, 60Hz
 Comment: Neutral Line
 Tem.: 22.4°C Hum.: 53%



| No. | Freq. (MHz) | Reading (dBuV) | Factor (dB) | Result (dBuV) | Limit (dBuV) | Over Limit (dB) | Detector | Remark |
|-----|-------------|----------------|-------------|---------------|--------------|-----------------|----------|--------|
| 1 | 0.1660 | 22.67 | 19.90 | 42.57 | 65.15 | -22.58 | QP | |
| 2 | 0.1740 | 8.20 | 19.90 | 28.10 | 54.76 | -26.66 | AVG | |
| 3 | 0.2779 | 15.68 | 19.89 | 35.57 | 60.88 | -25.31 | QP | |
| 4 | 0.5260 | 13.80 | 19.99 | 33.79 | 56.00 | -22.21 | QP | |
| 5 | 0.5299 | 4.26 | 19.99 | 24.25 | 46.00 | -21.75 | AVG | |
| 6 | 1.0300 | -1.23 | 20.12 | 18.89 | 46.00 | -27.11 | AVG | |
| 7 | 1.0339 | 10.40 | 20.12 | 30.52 | 56.00 | -25.48 | QP | |
| 8 | 1.4500 | -0.95 | 20.13 | 19.18 | 46.00 | -26.82 | AVG | |
| 9 | 1.5940 | 9.51 | 20.13 | 29.64 | 56.00 | -26.36 | QP | |
| 10 | 1.7620 | -1.80 | 20.14 | 18.34 | 46.00 | -27.66 | AVG | |
| 11 | 3.1540 | 9.25 | 20.16 | 29.41 | 56.00 | -26.59 | QP | |
| 12 | 3.5820 | -1.64 | 20.17 | 18.53 | 46.00 | -27.47 | AVG | |

Note: The EUT received input Voltage DC 3.3V from Debug board, and the Debug board received AC 120V/60Hz from Adapter.

4. Radiation Spurious Emission and Band Edge

4.1. Test Standard and Limit

| Test Standard | FCC Part15 C Section 15.209 and 15.205 | | | | |
|---------------|--|----------------------------------|----------------|------------|--------------------------|
| Test Limit | Frequency (MHz) | Field strength (microvolt/meter) | Limit (dBuV/m) | Remark | Measurement distance (m) |
| | 0.009MHz~0.490MHz | 2400/F(kHz) | - | - | 300 |
| | 0.490MHz-1.705MHz | 24000/F(kHz) | - | - | 30 |
| | 1.705MHz-30MHz | 30 | - | - | 30 |
| | 30MHz~88MHz | 100 | 40.0 | Quasi-peak | 3 |
| | 88MHz~216MHz | 150 | 43.5 | Quasi-peak | 3 |
| | 216MHz~960MHz | 200 | 46.0 | Quasi-peak | 3 |
| | 960MHz~1000MHz | 500 | 54.0 | Quasi-peak | 3 |
| | Above 1000MHz | 500 | 54.0 | Average | 3 |
| - | | - | 74.0 | Peak | 3 |

Remark:

(1)The lower limit shall apply at the transition frequency.

(2) 15.35(b), Unless otherwise specified, the limit on peak radio frequency emissions is 20dB above the maximum permitted average emission limit applicable to the equipment under test. This peak limit applies to the total peak emission level radiated by the device.

4.2. Test Setup

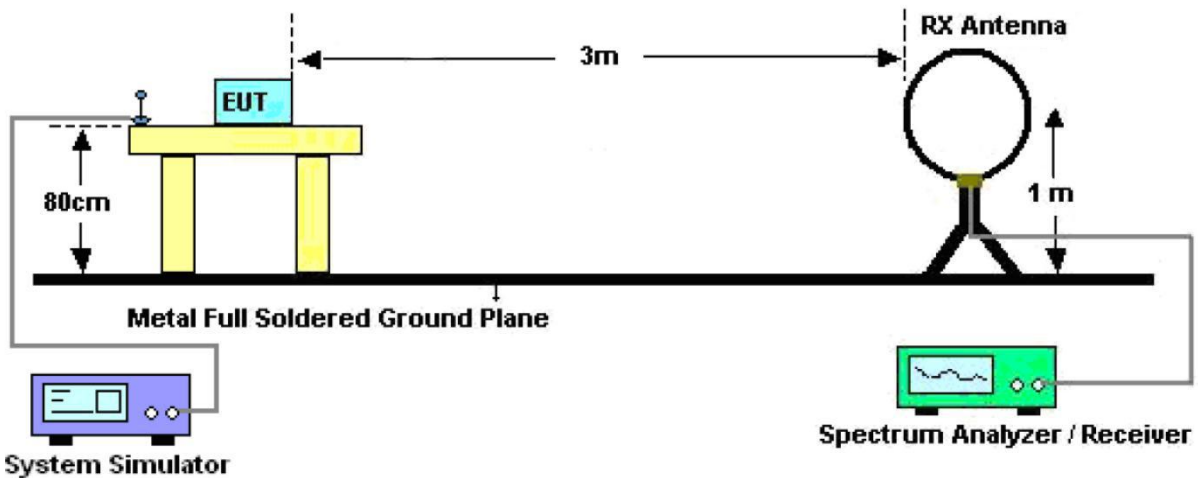


Figure 1. Below 30MHz

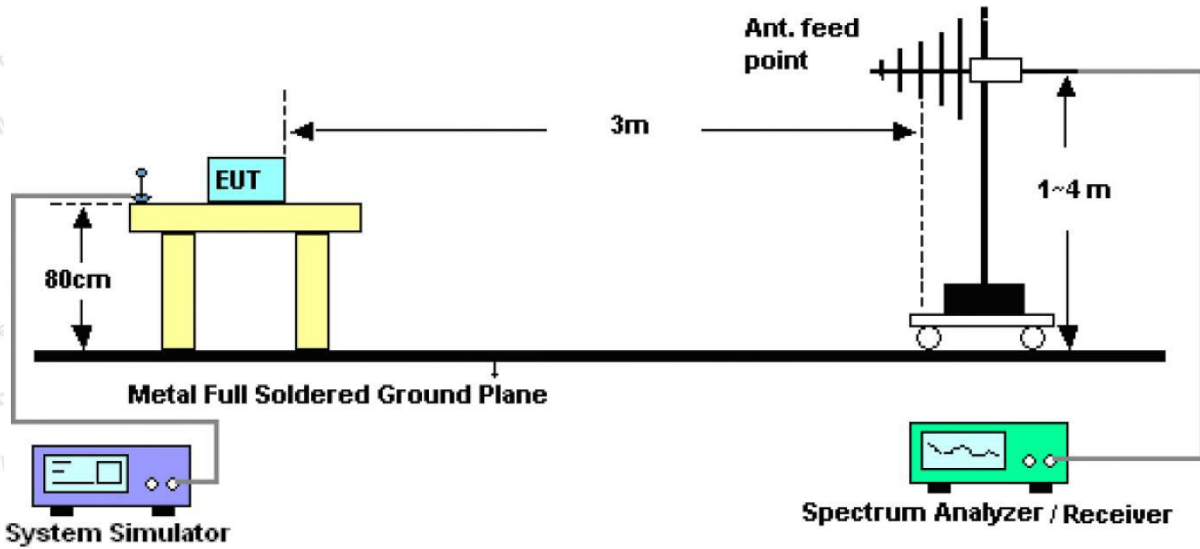


Figure 2. 30MHz to 1GHz

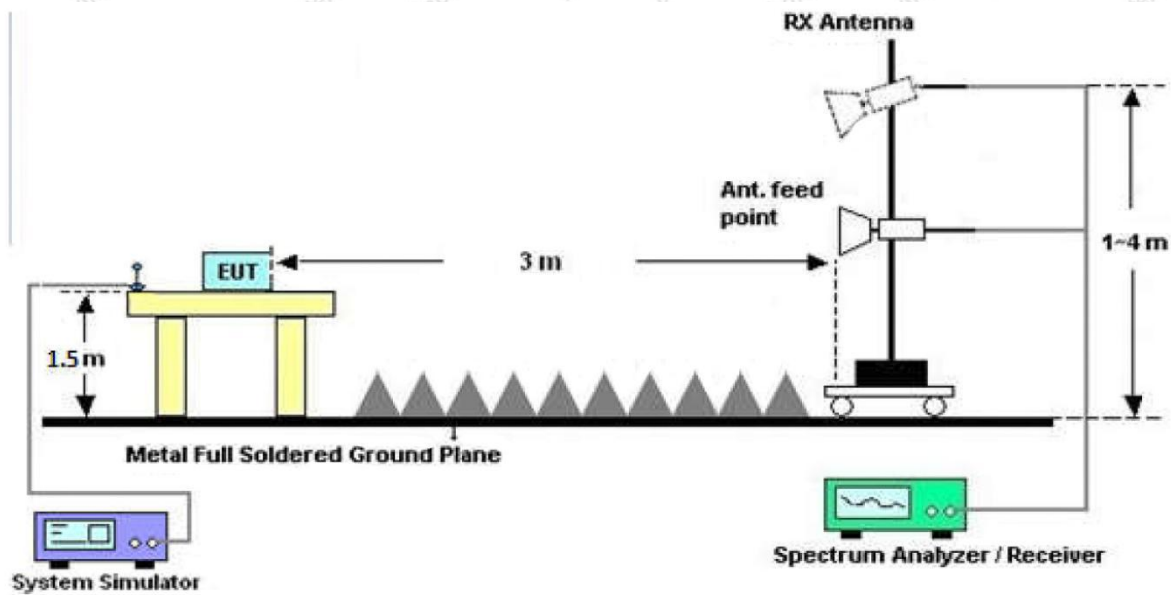


Figure 3. Above 1 GHz

4.3. Test Procedure

For below 1GHz: The EUT is placed on a turntable, which is 0.8m above the ground plane.

For above 1GHz: The EUT is placed on a turntable, which is 1.5m above the ground plane.

The turn table can rotate 360 degrees to determine the position of the maximum emission level. The EUT is set 3 meters away from the receiving antenna which is mounted on a antenna tower. The antenna can be moved up and down from 1 to 4 meters to find out the maximum emission level. Rotated the EUT through three orthogonal axes to determine the maximum emissions, both horizontal and vertical polarization of the antenna are set on test. The EUT is tested in 9*6*6 Chamber. The device is evaluated in xyz orientation.

For the radiated emission test above 1GHz:

Shenzhen Anbotek Compliance Laboratory Limited

Code:AB-RF-05-a

Address: 1/F., Building D, Sogood Science and Technology Park, Sanwei Community, Hangcheng Street, Bao'an District, Shenzhen, Guangdong, China.

Hotline
400-003-0500

Tel:(86) 755-26066440 Fax: (86) 755-26014772 Email: service@anbotek.com

www.anbotek.com

Place the measurement antenna away from each area of the EUT determined to be a source of emissions at the specified measurement distance, while keeping the measurement antenna aimed at the source of emissions at each frequency of significant emissions, with polarization oriented for maximum response. The measurement antenna may have to be higher or lower than the EUT, depending on the radiation pattern of the emission and staying aimed at the emission source for receiving the maximum signal. The final measurement antenna elevation shall be that which maximizes the emissions. The measurement antenna elevation for maximum emissions shall be restricted to a range of heights of from 1 m to 4 m above the ground or reference ground plane.

For 9kHz to 150kHz, Set the spectrum analyzer as:

RBW = 200Hz, VBW = 1kHz, Detector= Quasi-Peak, Trace mode= Max hold, Sweep- auto couple.

For 150kHz to 30MHz, Set the spectrum analyzer as:

RBW = 9kHz, VBW = 30kHz, Detector= Quasi-Peak, Trace mode= Max hold, Sweep- auto couple.

For 30MHz to 1000MHz, Set the spectrum analyzer as:

RBW = 100kHz, VBW = 300kHz, Detector= Quasi-Peak, Trace mode= Max hold, Sweep- auto couple.

For above 1GHz, Set the spectrum analyzer as:

RBW = 1MHz, VBW = 1MHz, Detector= Peak, Trace mode= Max hold, Sweep- auto couple.

RBW = 1MHz, VBW = 10Hz, Detector= Average, Trace mode= Max hold, Sweep- auto couple.

4.4. Test Data

PASS

During the test, pre-scan all the modes, and found the CH08 (TX) which is the worst case, only the worst case is recorded in the report.

The test results of 9kHz-30MHz was attenuated more than 20dB below the permissible limits, so the results don't record in the report.

Test Results (30~1000MHz)

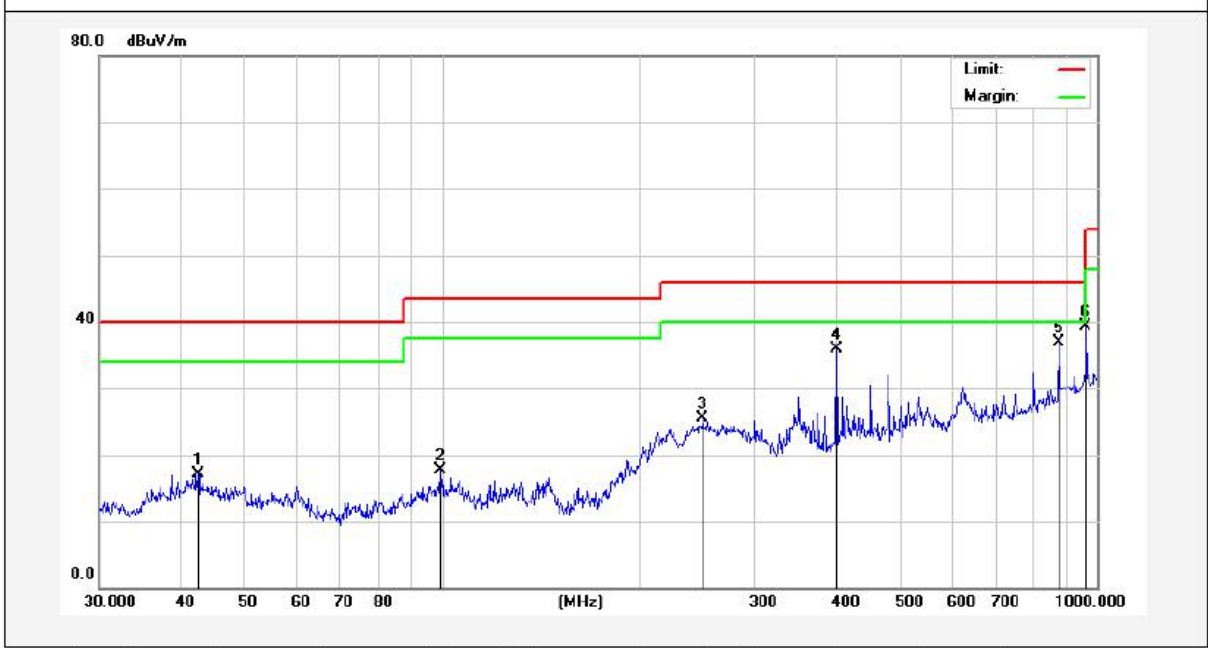
Test Mode: CH08
 Power Source: AC 120V, 60Hz
 Polarization: Vertical
 Temp.(°C)/Hum.(%RH): 22°C/50%RH



| No. | Freq. (MHz) | Reading (dBuV) | Factor (dB/m) | Result (dBuV/m) | Limit (dBuV/m) | Over Limit (dB) | Detector | Height (cm) | degree (deg) | Remark |
|-----|-------------|----------------|---------------|-----------------|----------------|-----------------|----------|-------------|--------------|--------|
| 1 | 36.3813 | 40.04 | -15.53 | 24.51 | 40.00 | -15.49 | peak | | | |
| 2 | 49.0144 | 35.14 | -14.70 | 20.44 | 40.00 | -19.56 | peak | | | |
| 3 | 146.3735 | 37.05 | -19.97 | 17.08 | 43.50 | -26.42 | peak | | | |
| 4 | 224.5192 | 37.30 | -16.25 | 21.05 | 46.00 | -24.95 | peak | | | |
| 5 | 550.9479 | 37.22 | -8.00 | 29.22 | 46.00 | -16.78 | peak | | | |
| 6 | 651.9416 | 37.91 | -6.79 | 31.12 | 46.00 | -14.88 | peak | | | |

Test Results (30~1000MHz)

Test Mode: CH08
 Power Source: AC 120V, 60Hz
 Polarization: Horizontal
 Temp.(°C)/Hum.(%RH): 22°C/50%RH



| No. | Freq. (MHz) | Reading (dBuV) | Factor (dB/m) | Result (dBuV/m) | Limit (dBuV/m) | Over Limit (dB) | Detector | Height (cm) | degree (deg) | Remark |
|-----|-------------|----------------|---------------|-----------------|----------------|-----------------|----------|-------------|--------------|--------|
| 1 | 42.4508 | 31.82 | -14.66 | 17.16 | 40.00 | -22.84 | peak | | | |
| 2 | 99.5281 | 37.04 | -19.42 | 17.62 | 43.50 | -25.88 | peak | | | |
| 3 | 250.3012 | 44.24 | -18.81 | 25.43 | 46.00 | -20.57 | peak | | | |
| 4 | 400.4319 | 48.89 | -12.98 | 35.91 | 46.00 | -10.09 | peak | | | |
| 5 | 875.2470 | 39.34 | -2.43 | 36.91 | 46.00 | -9.09 | peak | | | |
| 6 | 962.1623 | 39.95 | -0.56 | 39.39 | 54.00 | -14.61 | peak | | | |

Note: The EUT received input Voltage DC 3.3V from Debug board, and the Debug board received AC 120V/60Hz from Adapter.

Test Results (1GHz-25GHz)

| Test Mode: CH01 | | | | | Test channel: Lowest | | | | |
|-----------------|--------------|------------------|-----------------|-----------------|----------------------|----------------|-----------------|-------------|-----------|
| Frequency (MHz) | Antenna Pol. | Reading (dBUV/m) | Cable Loss (dB) | Ant Factor (dB) | Amplifier (dB) | Level (dBUV/m) | Limits (dBUV/m) | Margin (dB) | Det. Mode |
| 1846.6000 | H | 42.84 | 7.39 | 28.73 | 26.31 | 52.65 | 74 | -21.35 | PK |
| 1846.6000 | H | 34.26 | 7.39 | 28.73 | 26.31 | 44.07 | 54 | -9.93 | AV |
| 2769.9000 | H | 43.07 | 8.10 | 29.71 | 27.01 | 53.87 | 74 | -20.13 | PK |
| 2769.9000 | H | 33.99 | 8.10 | 29.71 | 27.01 | 44.79 | 54 | -9.21 | AV |
| 3693.2000 | H | -- | -- | -- | -- | -- | -- | -- | PK |
| 3693.2000 | H | -- | -- | -- | -- | -- | -- | -- | AV |
| 1846.6000 | V | 42.95 | 7.39 | 28.73 | 26.31 | 52.76 | 74 | -21.24 | PK |
| 1846.6000 | V | 34.44 | 7.39 | 28.73 | 26.31 | 44.25 | 54 | -9.75 | AV |
| 2769.9000 | V | 41.34 | 8.10 | 29.71 | 27.01 | 52.14 | 74 | -21.86 | PK |
| 2769.9000 | V | 33.54 | 8.10 | 29.71 | 27.01 | 44.34 | 54 | -9.66 | AV |
| 3693.2000 | V | -- | -- | -- | -- | -- | -- | -- | PK |
| 3693.2000 | V | -- | -- | -- | -- | -- | -- | -- | AV |

| Test Mode: CH08 | | | | Test channel: High | | | | | |
|-----------------|--------------|------------------|-----------------|--------------------|----------------|----------------|-----------------|-------------|-----------|
| Frequency (MHz) | Antenna Pol. | Reading (dBuV/m) | Cable Loss (dB) | Ant Factor (dB) | Amplifier (dB) | Level (dBuV/m) | Limits (dBuV/m) | Margin (dB) | Det. Mode |
| 1855.0000 | H | 47.60 | 7.43 | 28.69 | 26.31 | 57.41 | 74 | -16.59 | PK |
| 1855.0000 | H | 36.70 | 7.43 | 28.69 | 26.31 | 46.51 | 54 | -7.49 | AV |
| 2782.5000 | H | 46.12 | 8.15 | 29.84 | 27.01 | 57.10 | 74 | -16.90 | PK |
| 2782.5000 | H | 35.10 | 8.15 | 29.84 | 27.01 | 46.08 | 54 | -7.92 | AV |
| 3710.0000 | H | -- | -- | -- | -- | -- | -- | -- | PK |
| 3710.0000 | H | -- | -- | -- | -- | -- | -- | -- | AV |
| 1855.0000 | V | 47.02 | 7.43 | 28.69 | 26.31 | 56.83 | 74 | -17.17 | PK |
| 1855.0000 | V | 36.71 | 7.43 | 28.69 | 26.31 | 46.52 | 54 | -7.48 | AV |
| 2782.5000 | V | 45.68 | 8.15 | 29.84 | 27.01 | 56.66 | 74 | -17.34 | PK |
| 2782.5000 | V | 35.96 | 8.15 | 29.84 | 27.01 | 46.94 | 54 | -7.06 | AV |
| 3710.0000 | V | -- | -- | -- | -- | -- | -- | -- | PK |
| 3710.0000 | V | -- | -- | -- | -- | -- | -- | -- | AV |

Remark:

1. Level =Receiver Read level + Antenna Factor + Cable Loss – Preamplifier Factor
2. “**” means the test results were attenuated more than 20dB below the permissible limits, so the results don't record in the report.

Radiated Band Edge:

| Frequency (MHz) | Read Level (dBuV/m) | Antenna Factor (dB) | Cable Loss (dB) | Preamp Factor (dB) | Level (dBuV/m) | Limit (dBuV/m) | Over Limit (dB) | Pol. | Det. |
|-----------------|---------------------|---------------------|-----------------|--------------------|----------------|----------------|-----------------|------|------|
| 902.0000 | 43.14 | 22.45 | 4.48 | 31.33 | 38.74 | 46.00 | -7.26 | H | QP |
| 928.0000 | 39.42 | 22.59 | 4.54 | 31.35 | 35.20 | 46.00 | -10.80 | H | QP |
| 902.0000 | 42.81 | 22.45 | 4.48 | 31.33 | 38.41 | 46.00 | -7.59 | V | QP |
| 928.0000 | 40.64 | 22.59 | 4.54 | 31.35 | 36.42 | 46.00 | -9.58 | V | QP |

Remark:

1. Level = Receiver Read level + Antenna Factor + Cable Loss – Preamplifier Factor

5. Antenna Requirement

5.1. Test Standard and Requirement

| | |
|---------------|--|
| Test Standard | FCC Part15 Section 15.203 /247(c) |
| Requirement | <p>1) 15.203 requirement: An intentional radiator shall be designed to ensure that no antenna other than that furnished by the responsible party shall be used with the device. The use of a permanently attached antenna or of an antenna that uses a unique coupling to the intentional radiator, the manufacturer may design the unit so that a broken antenna can be replaced by the user, but the use of a standard antenna jack or electrical connector is prohibited.</p> <p>2) 15.247(c) (1)(i) requirement: Systems operating in the 2400-2483.5 MHz band that is used exclusively for fixed. Point-to-point operations may employ transmitting antennas with directional gain greater than 6dBi provided the maximum conducted output power of the intentional radiator is reduced by 1 dB for every 3 dB that the directional gain of the antenna</p> |

5.2. Antenna Connected Construction

The antenna is a Cylindrical antenna which permanently attached, and the best case gain of the antenna is 2.6 dBi. It complies with the standard requirement.

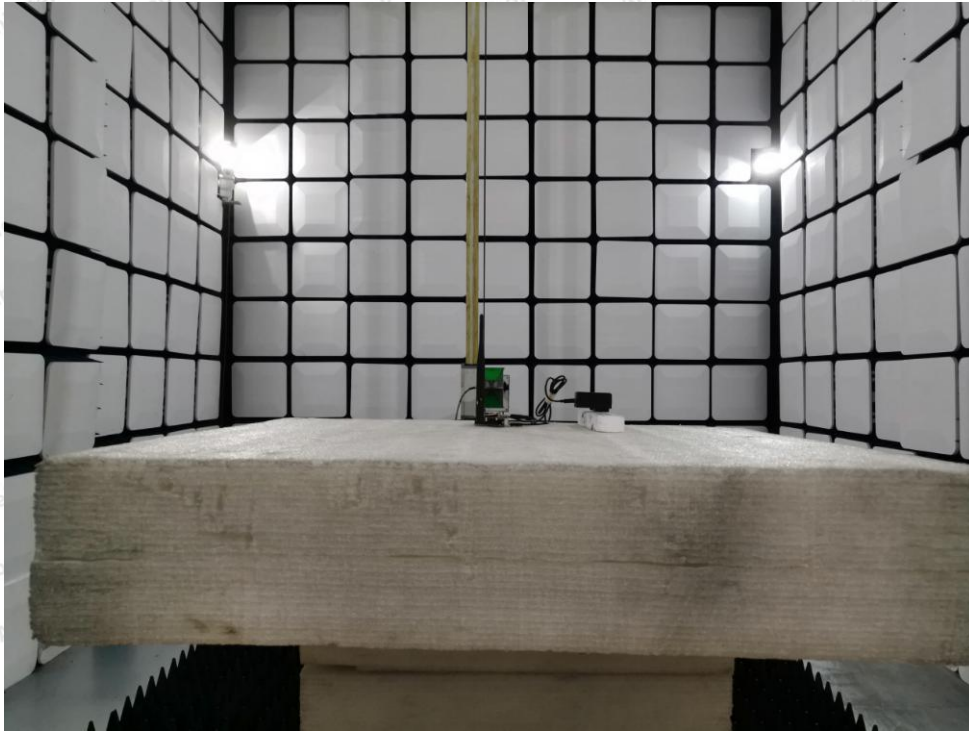
APPENDIX I -- TEST SETUP PHOTOGRAPH

Photo of Conducted Emission Measurement

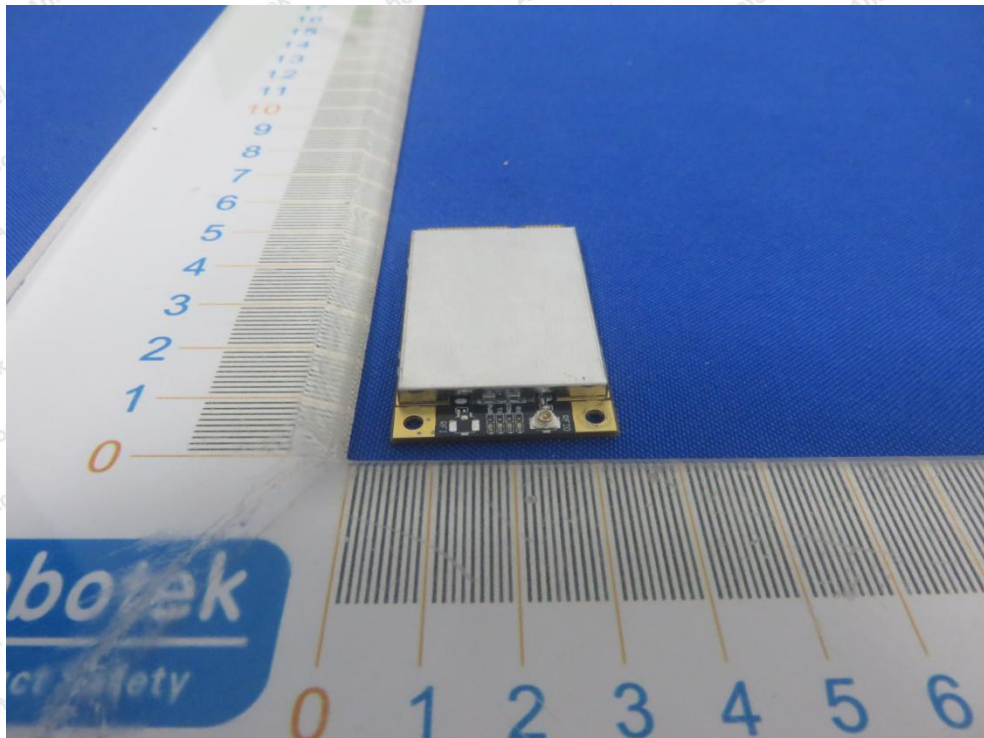
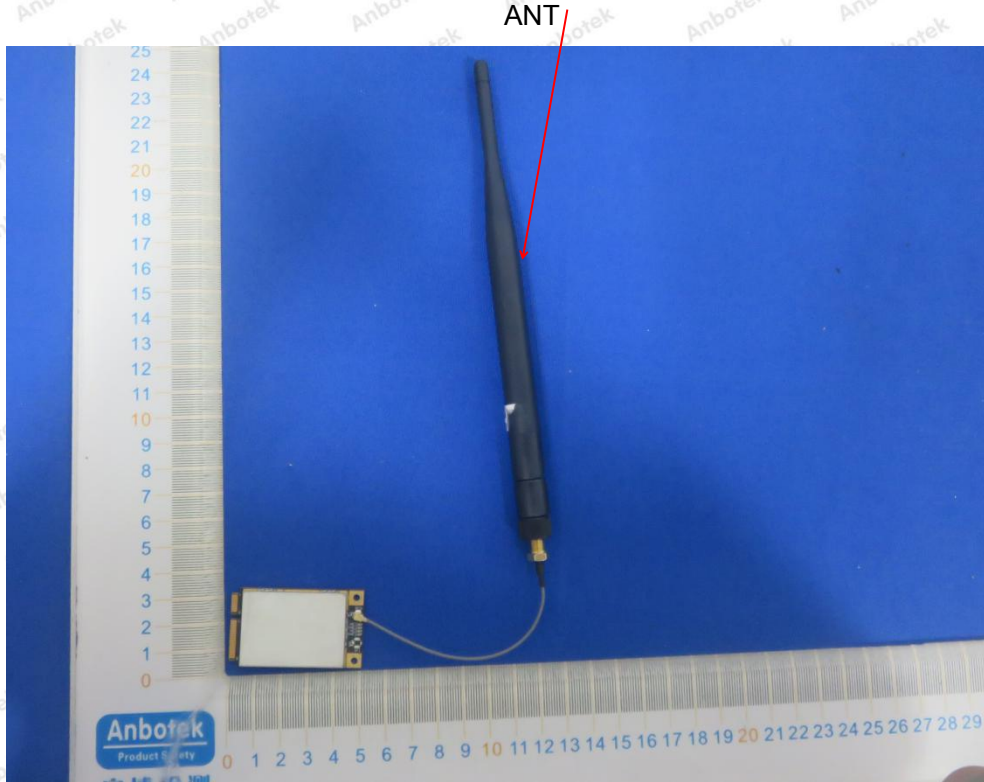


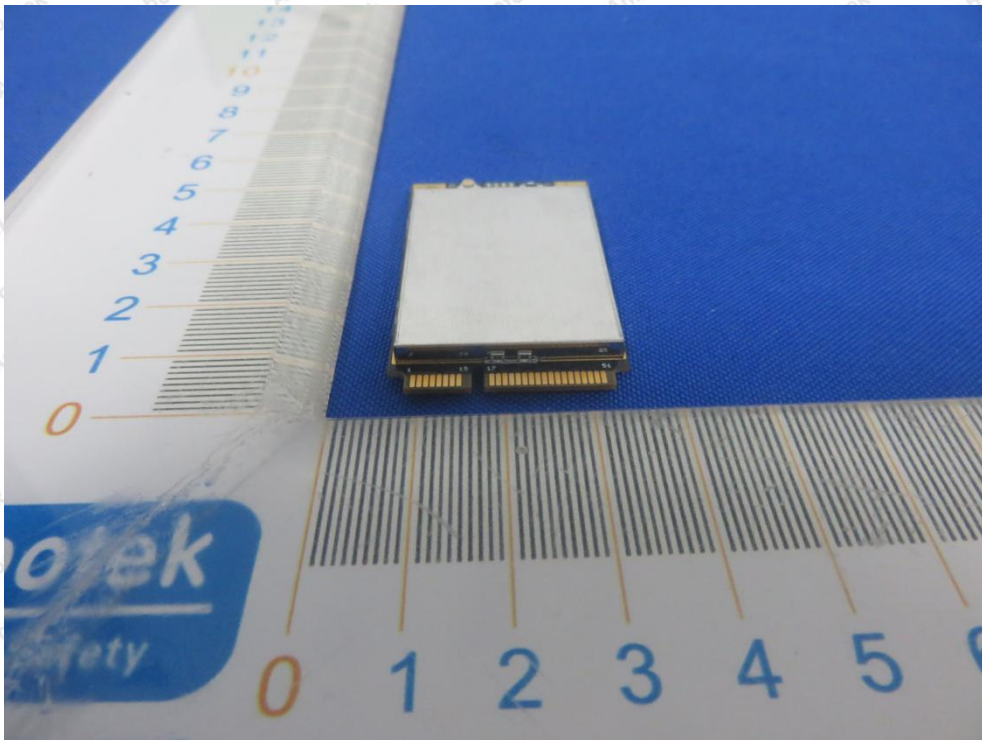
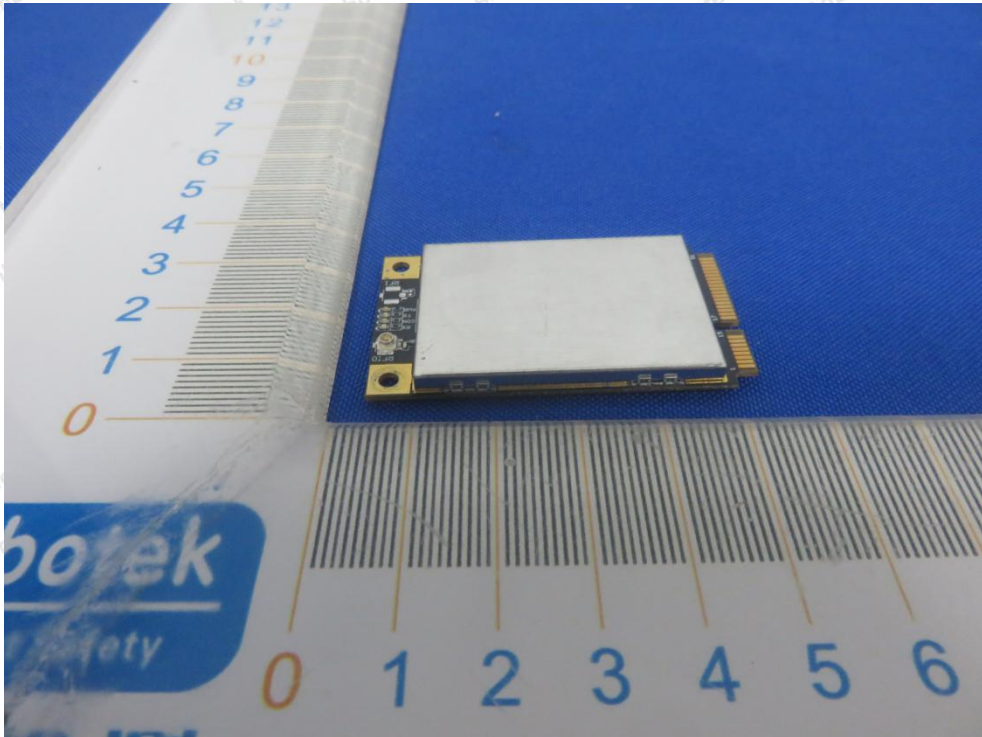
Photo of Radiation Emission Test

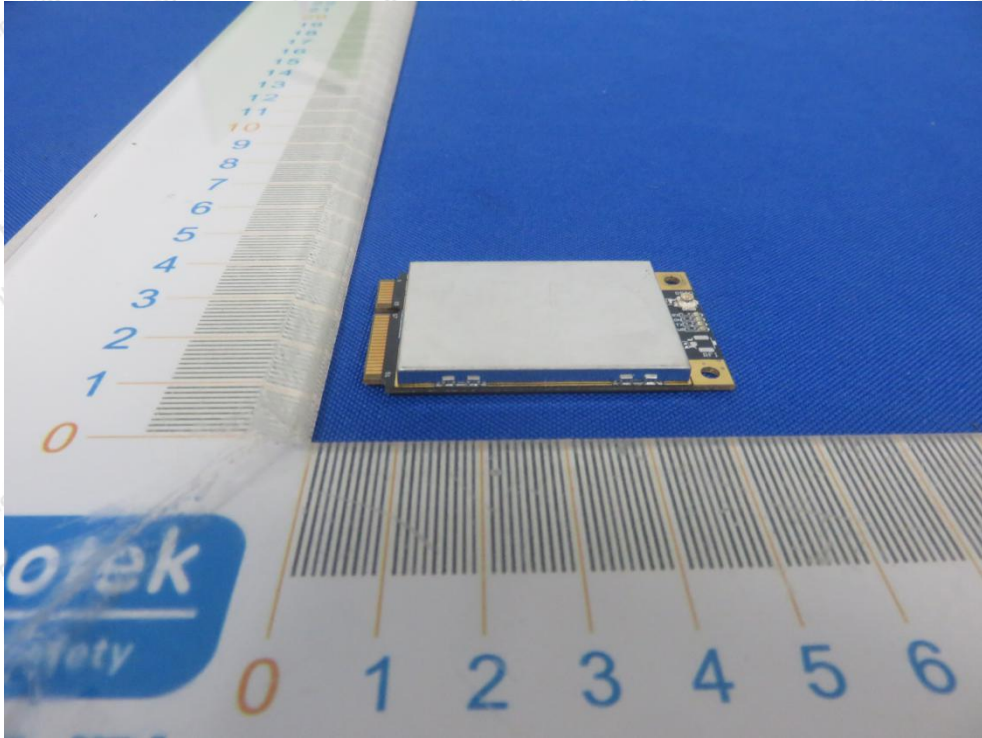




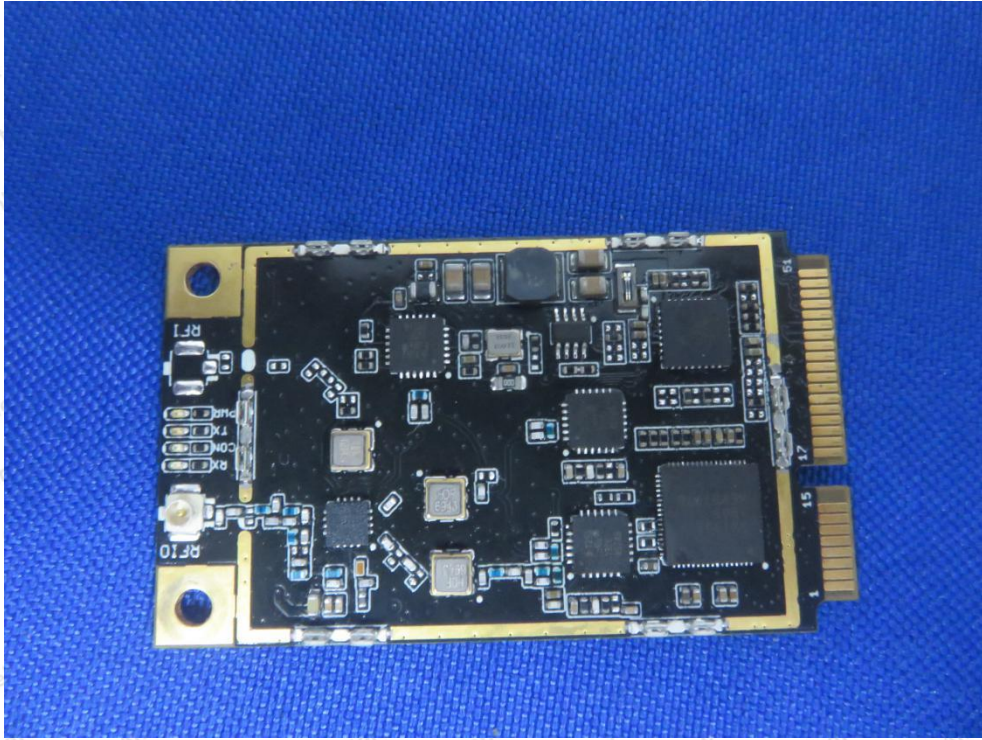
APPENDIX II -- EXTERNAL PHOTOGRAPH







APPENDIX III -- INTERNAL PHOTOGRAPH



----- End of Report -----