

# ODYSSEY – STM32MP157C

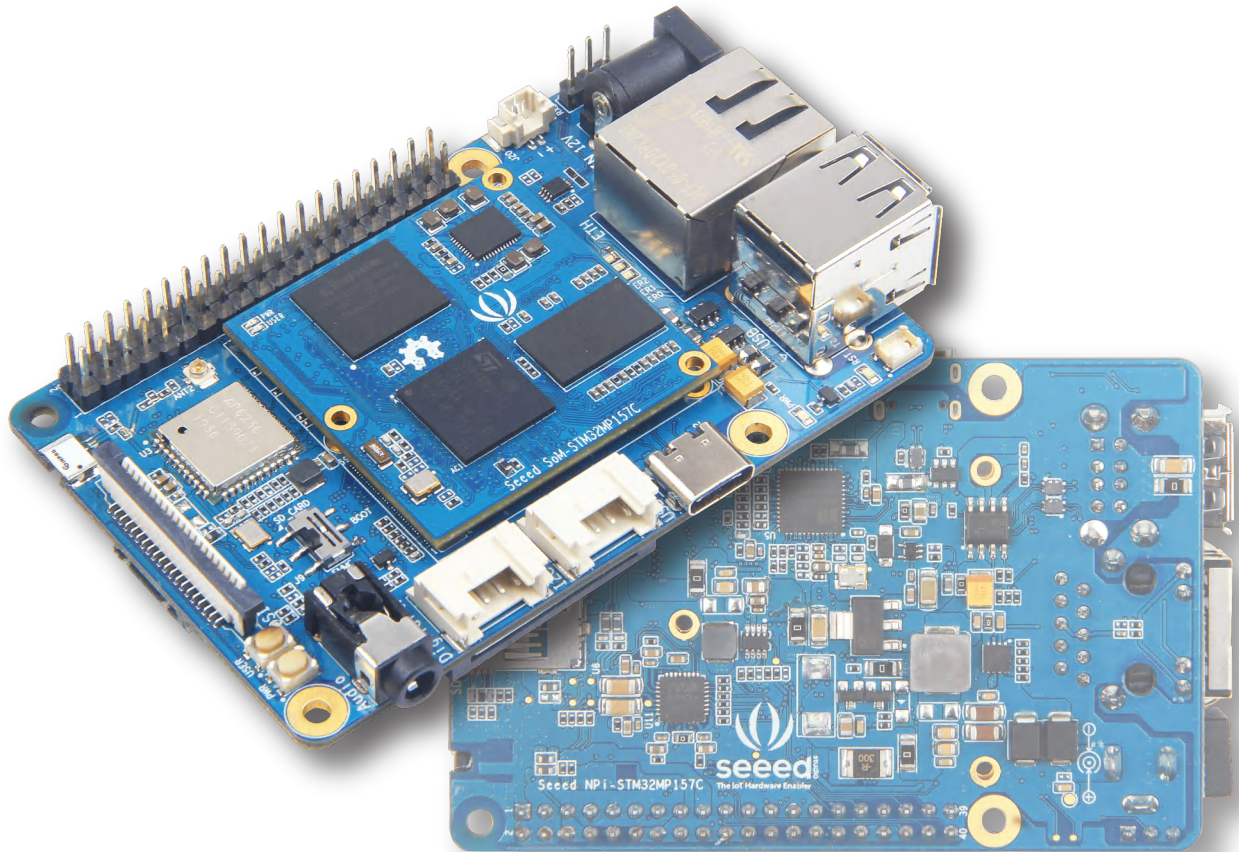

System-On-Module + Carrier Single Board Computer



## Reference Guide

Revision A  
March 27, 2020

---

## **Table of Contents**

### **Overview**

Description .....	3
Features .....	3
Applications .....	3

### **Specifications**

SoM-STM32MP157C .....	4
Carrier Board .....	4

### **Hardware Overview**

Carrier Board pinout diagram .....	5
SoM component details .....	5
Carrier Board component details .....	6

### **FCC Regulatory Compliance Information**

End Device Labelling .....	8
RF Exposure Compliance .....	8
Installation Notice .....	8

## Overview

### Description

The ODYSSEY – STM32MP157C is a single board computer that is based on STM32MP157C, a dual-core Arm® Cortex®-A7 processor operating at 650Mhz. The processor also integrates an Arm® Cortex®-M4 coprocessor, which makes it suitable for real-time tasks. The ODYSSEY – STM32MP157C is created in a form of SoM (System-On-Module) with a carrier board. The SoM consists of an MPU, PMIC, RAM and the carrier board is in Raspberry Pi form factor. The carrier board includes all the necessary peripherals including Gigabit Ethernet, Wi-Fi/BLE, DC Power, USB Hosts, USB-C, MIPI-DSI, DVP for camera, Audio, etc. With this board, customers can evaluate the SoM and deploy the SoM on their own carrier board quickly and easily.

### Features

- Dual-Core Arm® Cortex®-A7 Processor with Cortex®-M4 Integrated
- SoM (System-On-Module) includes MPU, PMIC, RAM
- Raspberry Pi 40-Pin Compatible Carrier Board
- Compact Size and Powerful
- Open-Source Hardware/SDK/API/BSP/OS

### Applications

- Industrial (CAN-Ethernet gateways)
- White goods (refrigerators, microwaves)
- Medical (data loggers)
- High-end wearables (VR devices)
- Smart Home Devices

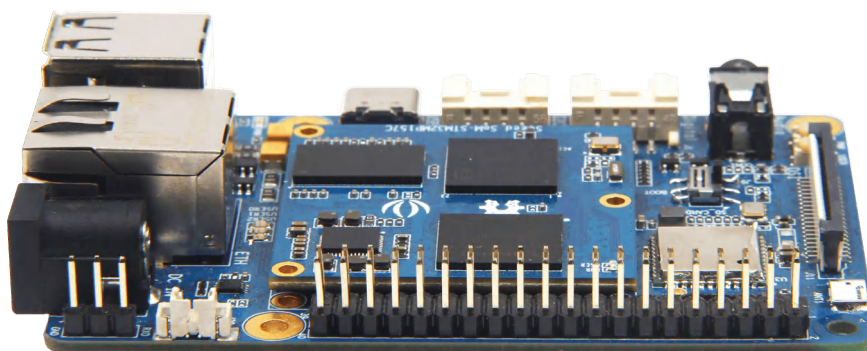
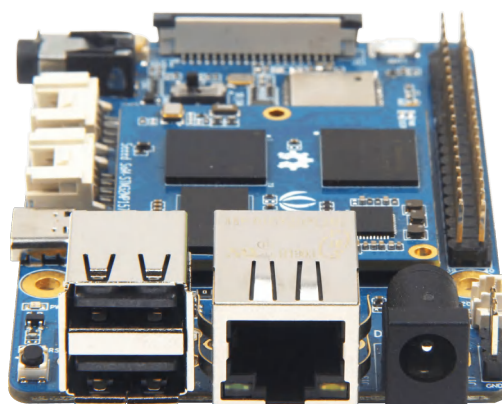

## Specifications

### ● SoM – STM32MP157C

- MPU: STM32MP157C
  - 32-bit Dual-Core Arm® Cortex®-A7
  - 32-bit Arm Cortex®-M4 with FPU/MPU
- PMU: ST PMIC STPMIC1A
- RAM: 512MB DDR3 RAM
- Flash: 4GB eMMC
- Peripherals: 3 x Board-to-Board 70-Pin Connectors
- Dimensions: 38mm x 38mm

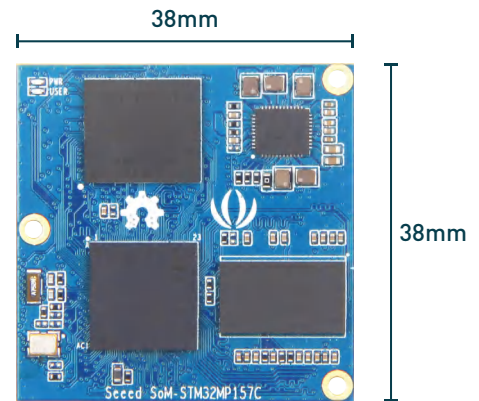

### ● Carrier Board

- Peripherals
  - 2 x USB Host
  - 1 x Gigabit Ethernet
  - 1 x 3.5mm Audio
  - 1 x MIPI DSI for Screen
  - 1 x DVP for Camera
  - 2 x Grove (GPIO & I2C)
  - 1 x SD Card Slot (on the back)
- WiFi/BLE
  - WiFi 802.11 b/g/n 2.4GHz
  - Bluetooth 4.1 with BLE
- On-Board LED: 1 x Reset, 3 x User, 1 x Power
- Power
  - 1 x DC Jack 12V~24V/2A (12V/2A power input is recommended)
  - 1 x USB Type-C
- Button
  - 1 x Reset
  - 1 x User
  - 1 x Switch
- Dimensions: 56mm x 85mm
- Operating Temperature: 0 ~ 75°C

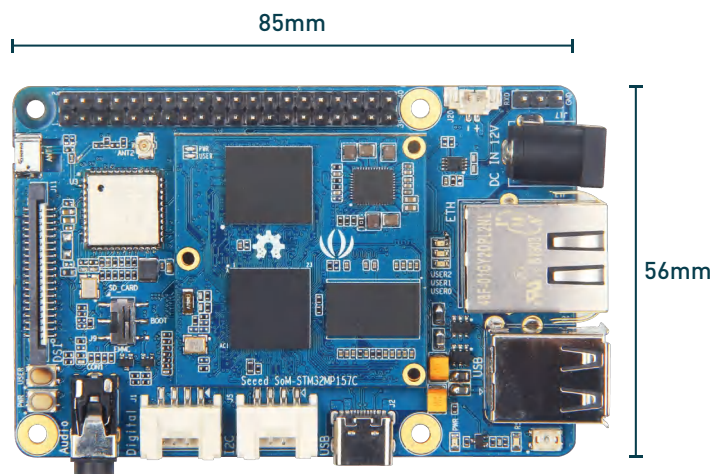



### Hardware Overview

#### Carrier Board Pinout Diagram

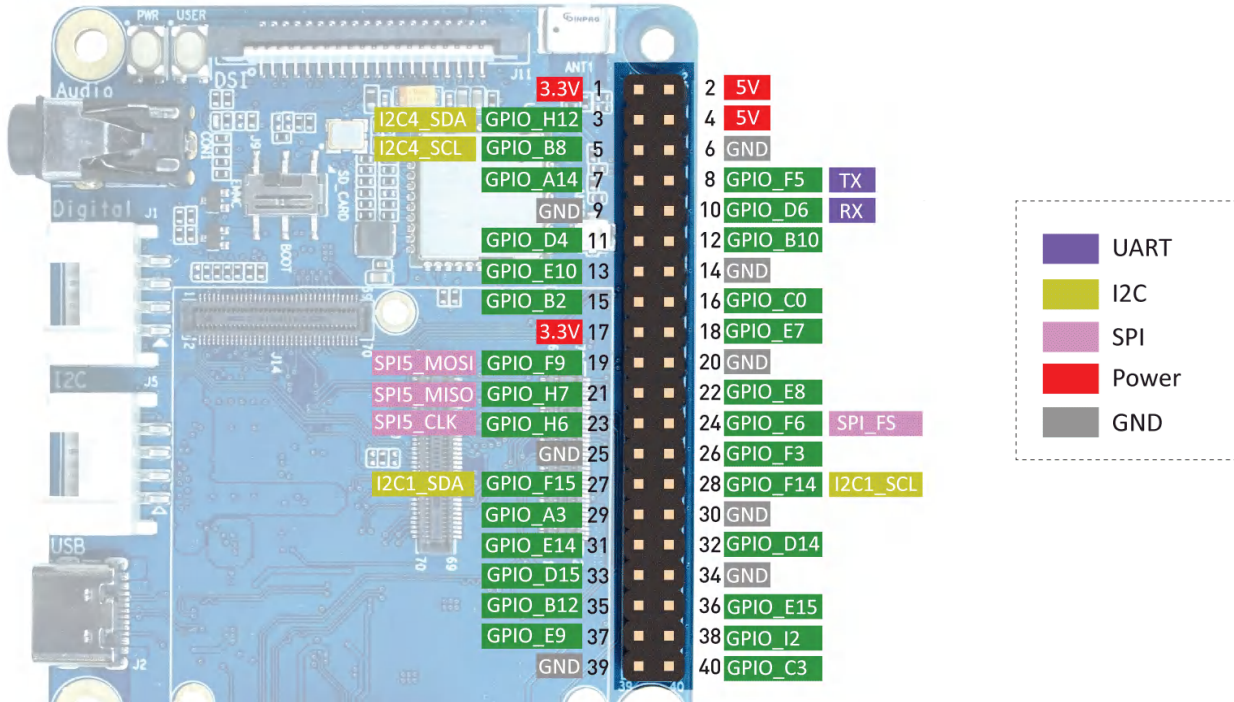

ODYSSEY - STM32MP157C's 40-pins are fully compatible with Raspberry Pi's 40-pins including GPIO, I2C, UART, SPI, I2S and PWM pins.

#### SoM Components Details

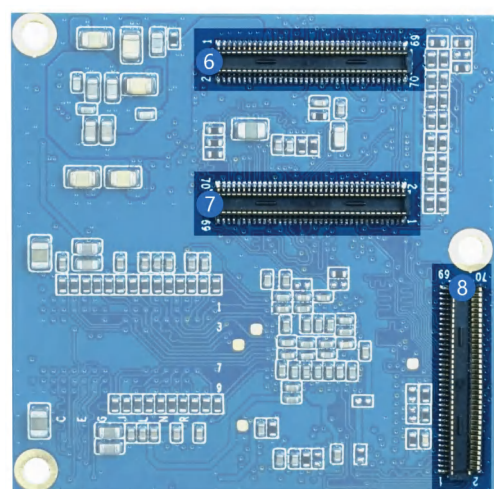
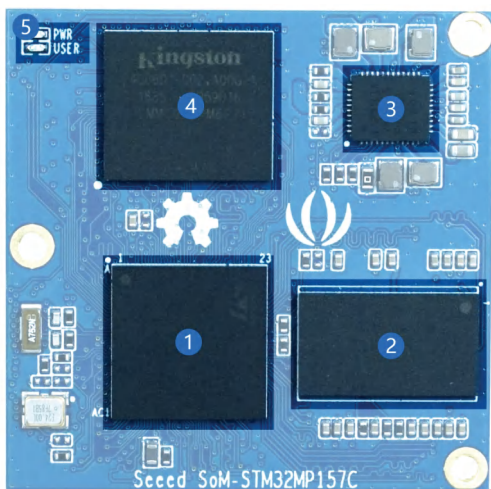

### 1.STM32MP157C: Development Board Main Control Chip

(Dual architecture processor: Arm® Cortex®-A7 and Cortex®-M4 )

### 2.MT41K256M16TW-107:P: 512MB 16-bit RAM Memory Chip

### 3.STPMIC1APQR: Power Management Chip

### 4.EMMC04G-M627: 4GB eMMC Memory

5.LED: When the power supply is successful, the PWR LED will turn on. When the system is running normally, the USER LED will keep flashing.

6, 7, 8: 70-PIN connectors

## ● Carrier Board Components Details

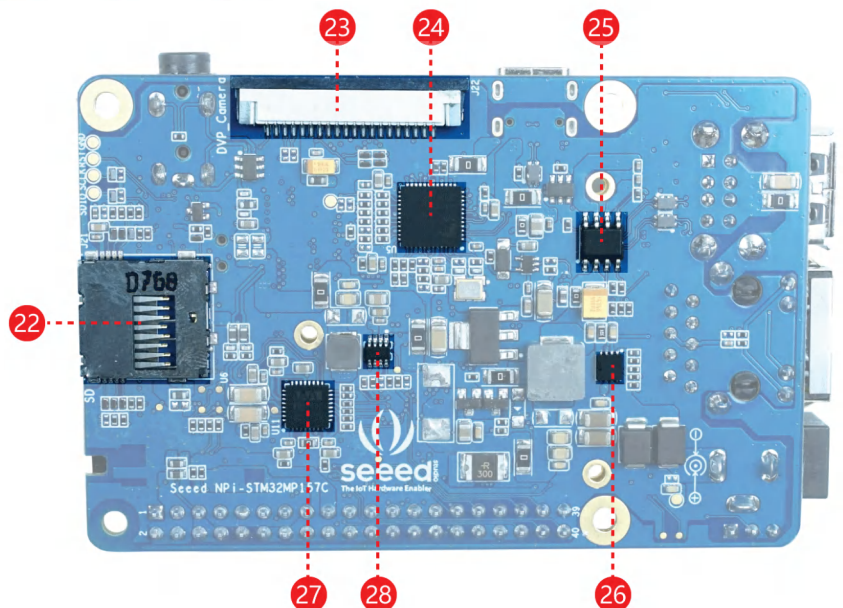
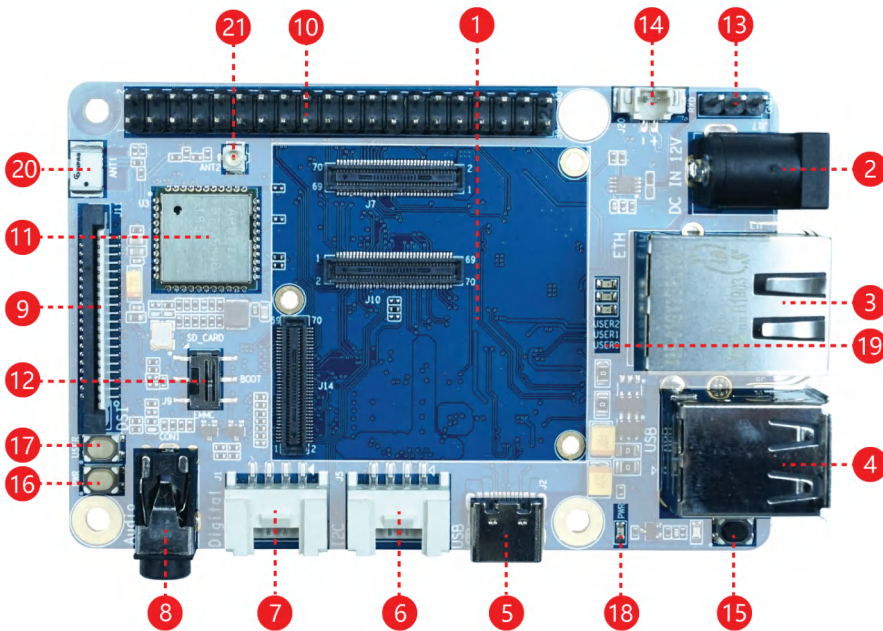

1. **Seed SoM-STM32MP157C Installation Area:** If the user wants to remove the core board, slowly tilt the core board up and then remove. Never remove by hand.
2. **DC Power Input Port:** 12V~24V/2A (12V/2A power input is recommended).
3. **ETH Interface:** Network cable interface can be connected to Gigabit Level Network.
4. **USB Host:** Two USB Host ports.
5. **USB Device:** USB 2.0 Type C. If Type C is used as board power input, a 5V/3A power adapter should be used.
6. **Digital Grove Interface:** Connect Grove modules with digital interface.
7. **I2C Grove Interface:** Connect Grove modules with I2C interface.
8. **American Standard 3.5mm:** Audio interface.
9. **MIPI DSI Interface:** Connect to a display with a MIPI DSI interface (FPC 20Pin 1.0mm).
10. **40 Pin GPIO Interface:** Compatible with Raspberry Pi's 40-Pin.
11. **AP6236:** 2.4G Wi-Fi & BT 4.2 control chip.
12. **Slide Switch:** Can be used to select SD card or eMMC to start.
13. **Debug UART:** The system default debugging serial port. Can enter this serial port to access the system,
14. **JST 1.0mm:** 3V RTC battery interface.
15. **RST Key:** System reset key.
16. **PWR Button:** Long press about 8s to shut down, short press to boot.
17. **User Button:** User programmable buttons.
18. **PWR LED:** Development board power LED.
19. **User LED:** User programmable LED.
20. **ACA-5036-A2-CC-S:** On-board 2.4GHz ceramic antenna.
21. **The IPEX 1 Generation:** 2.4G external antenna seat (When using an external antenna, user needs to remove R49, R51 0Ω welding)
22. **SD Card Slot:** The area in which a Micro-SD card with the system is inserted.
23. **DVP Camera Interface:** Connect to camera with DVP interface (FPC 20Pin 1.0mm).
24. **KSZ9031:** 1000M Network cable drive network card.
25. **STMP2252MTR:** Power switch chip.
26. **MP9943:** Buck DCDC Power chip.
27. **WM8960:** Audio codec chip.
28. **MP2161:** Buck DCDC Power chip.

## FCC Regulatory Compliance Information

This device complies with Part 15 of the FCC Rules. Operation is subject to the following two conditions: (1) this device may not cause harmful interference, and (2) this device must accept any interference received, including interference that may cause undesired operation.

Warning: changes or modifications not expressly approved by the party responsible for compliance could void the user's authority to operate the equipment.

### ● End Device Labelling

Please notice that if the FCC identification number is not visible when the module is installed inside another device, then the outside of the device into which the module is installed must also display a label referring to the enclosed module. This exterior label can use wording such as the following: "Contains FCC ID:XXXXX" any similar wording that expresses the same meaning may be used.

### ● RF Exposure Compliance

This equipment complies with FCC radiation exposure limits set forth for an uncontrolled environment. This equipment should be installed and operated with a minimum distance of 20cm between the radiator & your body. This transmitter must not be co-located or operating in conjunction with any other antenna or transmitter.

### ● Installation Notice

The module is limited to OEM installation ONLY. The OEM integrator is responsible for ensuring that the end-user has no manual instruction to remove or install module.  
antenna configurations.

The module is limited to installation in mobile application; A separate approval is required for all other operating configurations, including portable configurations with respect to Part 2.1093 and difference

### ● FCC Part 15B Compliance of End Device

The OEM integrator is responsible for ensuring that the host product which is installed and operating with the module is in compliant with Part 15B unintentional Radiator requirements, please note that For a Class B digital device or peripheral, the instructions furnished the user manual of the end-user product shall include the following or similar statement, placed in a prominent location in the text of the manual:

Note: This equipment has been tested and found to comply with the limits for a Class B digital device, pursuant to part 15 of the FCC Rules. These limits are designed to provide reasonable protection against harmful interference in a residential installation. This equipment generates, uses and can radiate radio frequency energy and, if not installed and used in accordance with the instructions, may cause harmful interference to radio communications. However, there is no guarantee that interference will not occur in a particular installation. If this equipment does cause harmful interference to radio or television reception, which can be determined by turning the equipment off and on, the user is encouraged to try to correct the interference by one or more of the following measures:

- Reorient or relocate the receiving antenna.
- Increase the separation between the equipment and receiver.
- Connect the equipment into an outlet on a circuit different from that to which the receiver is connected.
- Consult the dealer or an experienced radio/TV technician for help.



If you want to learn about setting up the software and other details,  
please visit the product wiki at

**<http://wiki.seeedstudio.com/ODYSSEY-STM32MP157C/>**

If you still have any further questions, please visit

**[forum.seeedstudio.com](http://forum.seeedstudio.com)**

© 2008-2020 Seeed Technology Co.,Ltd. All rights reserved.

## **Integration instructions for host product manufacturers according to KDB 996369 D03 OEM Manual v01**

### **2.2 List of applicable FCC rules**

FCC Part 15 Subpart C 15.247 & 15.207 & 15.209

### **2.3 Specific operational use conditions**

The module is a module with Bluetooth and WIFI functions.

Operation Frequency: WiFi 2.4G: 802.11b/ g/ n(HT20) 2412-2462MHz

BDR&EDR: 2402-2480MHz

BLE: 2402-2480MHz

Number of Channel: WiFi 2.4G: 11 Channels for 802.11b/ g/ n(HT20)

BDR&EDR: 79 Channels

BLE: 40 Channels

Modulation: WiFi 2.4G: 802.11b CCK; 802.11g/n OFDM

BDR&EDR: GFSK,  $\pi$ /4-DQPSK, 8-DPSK

BLE: GFSK

Type: Ceramic Antenna

Gain: 3 dBi Max.

The module can be used for mobile or portable applications with a maximum 3dBi antenna. The host manufacturer installing this module into their product must ensure that the final composite product complies with the FCC requirements by a technical assessment or evaluation to the FCC rules, including the transmitter operation. The host manufacturer has to be aware not to provide information to the end user regarding how to install or remove this RF module in the user's manual of the end product which integrates this module. The end user manual shall include all required regulatory information/warning as show in this manual.

### **2.4 Limited module procedures**

Not applicable. The module is a Single module and complies with the requirement of FCC Part 15.212.

### **2.5 Trace antenna designs**

Not applicable. The module has its own antenna, and doesn't need a host's printed board microstrip trace antenna etc.

### **2.6 RF exposure considerations**

The module must be installed in the host equipment such that at least 5mm is maintained between the antenna and users' body; and if RF exposure statement or module layout is changed, then the host product manufacturer required to take responsibility of the module through a change in FCC ID or new application. The FCC ID of the module cannot be used on the final product. In these circumstances, the host manufacturer will be responsible for re-evaluating the end product (including the transmitter) and obtaining a separate FCC authorization.

### **2.7 Antennas**

Antenna Specification are as follows:

Type: Ceramic Antenna

Gain: 3 dBi

This device is intended only for host manufacturers under the following conditions:

The transmitter module may not be co-located with any other transmitter or antenna;

The module shall be only used with the internal antenna(s) that has been originally tested and certified with this module. The antenna must be either permanently attached or employ a 'unique' antenna coupler.

As long as the conditions above are met, further transmitter test will not be required. However, the host manufacturer is still responsible for testing their end-product for any additional compliance requirements required with this module installed (for example, digital device emissions, PC peripheral requirements, etc.).

### **2.8 Label and compliance information**

Host product manufacturers need to provide a physical or e-label stating "Contains FCC ID: Z4TSESTM32P157" with their finished product.

### **2.9 Information on test modes and additional testing requirements**

Operation Frequency: WiFi 2.4G: 802.11b/ g/ n(HT20) 2412-2462MHz

BDR&EDR: 2402-2480MHz

BLE: 2402-2480MHz

Number of Channel: WiFi 2.4G: 11 Channels for 802.11b/ g/ n(HT20)

BDR&EDR: 79 Channels

BLE: 40 Channels

Modulation: WiFi 2.4G: 802.11b CCK; 802.11g/n OFDM

BDR&EDR: GFSK,  $\pi/4$ -DQPSK, 8-DPSK

BLE: GFSK

Host manufacturer must perform test of radiated & conducted emission and spurious emission, etc according to the actual test modes for a stand-alone modular transmitter in a host, as well as for multiple simultaneously transmitting modules or other transmitters in a host product.

Only when all the test results of test modes comply with FCC requirements, then the end product can be sold legally.

### **2.10 Additional testing, Part 15 Subpart B disclaimer**

The modular transmitter is **only** FCC authorized for FCC Part 15 Subpart C 15.247 & 15.207 & 15.209 and that the host product manufacturer is responsible for compliance to any other FCC rules that apply to the host not covered by the modular transmitter grant of certification. If the grantee markets their product as being Part 15 Subpart B compliant (when it also contains unintentional-radiator digital circuitry), then the grantee shall provide a notice stating that the final host product still requires Part 15 Subpart B compliance testing with the modular transmitter installed. Federal Communication Commission Statement (FCC, U.S.)

This equipment has been tested and found to comply with the limits for a Class B digital device, pursuant to Part 15 of the FCC Rules. These limits are designed to provide reasonable protection against harmful interference in a residential installation. This equipment generates, uses and can radiate radio frequency energy and, if not installed and used in accordance with the instructions, may cause harmful interference to radio

communications. However, there is no guarantee that interference will not occur in a particular installation. If this equipment does cause harmful interference to radio or television reception, which can be determined by turning the equipment off and on, the user is encouraged to try to correct the interference by one of the following measures:

- Reorient or relocate the receiving antenna.
- Increase the separation between the equipment and receiver.
- Connect the equipment into an outlet on a circuit different from that to which the receiver is connected.
- Consult the dealer or an experienced radio/TV technician for help.

This device complies with Part 15 of the FCC Rules. Operation is subject to the following two conditions: (1) This device may not cause harmful interference, and (2) this device must accept any interference received, including interference that may cause undesired operation.

FCC Caution:

Any changes or modifications not expressly approved by the party responsible for compliance could void the user's authority to operate this equipment.

#### IMPORTANT NOTES

Co-location warning:

This transmitter must not be co-located or operating in conjunction with any other antenna or transmitter.

OEM integration instructions:

This device is intended only for OEM integrators under the following conditions:

The transmitter module may not be co-located with any other transmitter or antenna. The module shall be only used with the external antenna(s) that has been originally tested and certified with this module.

As long as the conditions above are met, further transmitter test will not be required.

However, the OEM integrator is still responsible for testing their end-product for any additional compliance requirements required with this module installed (for example, digital device emissions, PC peripheral requirements, etc.).

Validity of using the module certification:

In the event that these conditions cannot be met (for example certain laptop configurations or co-location with another transmitter), then the FCC authorization for this module in combination with the host equipment is no longer considered valid and the FCC ID of the module cannot be used on the final product. In these circumstances, the OEM integrator will be responsible for re-evaluating the end product (including the transmitter) and obtaining a separate FCC authorization.

End product labeling:

The final end product must be labeled in a visible area with the following: "Contains Transmitter Module FCC ID: Z4TSESTM32P157".

Information that must be placed in the end user manual:

The OEM integrator has to be aware not to provide information to the end user regarding



how to install or remove this RF module in the user's manual of the end product which integrates this module. The end user manual shall include all required regulatory information/warning as show in this manual.