

FCC

RF

TEST REPORT

ISSUED BY  
Shenzhen BALUN Technology Co., Ltd.



FOR  
**LoRa-E5**

ISSUED TO  
Seed Technology Co., Ltd.

9F, Building G3, TCL International E City, ZhongShanYuan Road,  
NanShan, ShenZhen, GuangDong Province, China



Tested by: Ye Hongji  
Ye Hongji  
Date Nov. 25, 2020

Approved by: [Signature]  
Wei Yanquan  
(Chief Engineer)

Date Nov. 25, 2020

Report No.: BL-SZ2080378-601

EUT Name: LoRa-E5

Model Name: LoRa-E5-HF

Brand Name: Seed

Test Standard: 47 CFR Part 15 Subpart C

FCC ID: Z4T-LORA-E5

Test Conclusion: Pass

Test Date: Aug. 17, 2020 ~ Nov. 25, 2020

Date of Issue: Nov. 25, 2020

*NOTE: This test report of test results only related to testing samples, which can be duplicated completely for the legal use with the approval of the applicant; it shall not be reproduced except in full, without the written approval of Shenzhen BALUN Technology Co., Ltd. Any objections should be raised within thirty days from the date of issue. To validate the report, please contact us.*

### Revision History

<u>Version</u>	<u>Issue Date</u>	<u>Revisions Content</u>
<u>Rev. 01</u>	<u>Nov. 16, 2020</u>	<u>Initial Issue</u>
<u>Rev. 02</u>	<u>Nov. 25, 2020</u>	<u>Updated delete the hybrid modulation technology and the corresponding data</u>

## TABLE OF CONTENTS

1	ADMINISTRATIVE DATA (GENERAL INFORMATION) .....	5
1.1	Identification of the Testing Laboratory .....	5
1.2	Identification of the Responsible Testing Location .....	5
1.3	Laboratory Condition .....	5
1.4	Announce .....	6
2	PRODUCT INFORMATION .....	7
2.1	Applicant Information .....	7
2.2	Manufacturer Information .....	7
2.3	Factory Information .....	7
2.4	General Description for Equipment under Test (EUT) .....	7
2.5	Technical Information .....	8
2.6	Additional Instructions .....	9
3	SUMMARY OF TEST RESULTS .....	10
3.1	Test Standards .....	10
3.2	Verdict .....	10
4	GENERAL TEST CONFIGURATIONS .....	11
4.1	Test Environments .....	11
4.2	Test Equipment List .....	11
4.3	Measurement Uncertainty .....	12
4.4	Description of Test Setup .....	12
4.4.1	For Antenna Port Test .....	12
4.4.2	For AC Power Supply Port Test .....	13
4.4.3	For Radiated Test (Below 30 MHz) .....	13
4.4.4	For Radiated Test (30 MHz-1 GHz) .....	14

4.4.5	For Radiated Test (Above 1 GHz).....	14
4.5	Measurement Results Explanation Example.....	15
4.5.1	For conducted test items: .....	15
4.5.2	For radiated band edges and spurious emission test:.....	15
5	TEST ITEMS.....	16
5.1	Antenna Requirements.....	16
5.1.1	Relevant Standards.....	16
5.1.2	Antenna Anti-Replacement Construction .....	16
5.1.3	Antenna Gain .....	16
5.2	Output Power .....	17
5.2.1	Test Limit.....	17
5.2.2	Test Setup .....	17
5.2.3	Test Procedure .....	17
5.2.4	Test Result .....	18
5.3	Occupied Bandwidth .....	19
5.3.1	Limit.....	19
5.3.2	Test Setup .....	19
5.3.3	Test Procedure.....	19
5.3.4	Test Result .....	19
5.4	Conducted Spurious Emission .....	20
5.4.1	Limit.....	20
5.4.2	Test Setup .....	20
5.4.3	Test Procedure.....	20
5.4.4	Test Result .....	21
5.5	Band Edge (Authorized-band band-edge).....	22
5.5.1	Limit.....	22
5.5.2	Test Setup .....	22
5.5.3	Test Procedure.....	22
5.5.4	Test Result .....	22
5.6	Conducted Emission .....	23
5.6.1	Limit.....	23

5.6.2	Test Setup .....	23
5.6.3	Test Procedure .....	23
5.6.4	Test Result .....	23
5.7	Radiated Spurious Emission .....	24
5.7.1	Limit.....	24
5.7.2	Test Setup .....	24
5.7.3	Test Procedure .....	24
5.7.4	Test Result .....	25
5.8	Band Edge (Restricted-band band-edge).....	26
5.8.1	Limit.....	26
5.8.2	Test Setup .....	26
5.8.3	Test Procedure .....	26
1.1.1	Test Result .....	26
5.9	Power Spectral density (PSD).....	27
5.9.1	Limit.....	27
5.9.2	Test Setup .....	27
5.9.3	Test Procedure .....	27
5.9.4	Test Result .....	27
ANNEX A	TEST RESULT .....	28
A.1	Output Power .....	28
A.2	Occupied Bandwidth .....	29
A.3	Conducted Spurious Emissions .....	31
A.4	Band Edge (Authorized-band band-edge).....	34
A.5	Conducted Emissions.....	35
A.6	Radiated Spurious Emission .....	37
A.7	Band Edge (Restricted-band band-edge).....	55
A.8	Power Spectral Density (PSD) .....	57
ANNEX B	TEST SETUP PHOTOS .....	58
ANNEX C	EUT EXTERNAL PHOTOS .....	58
ANNEX D	EUT INTERNAL PHOTOS .....	58

# 1 ADMINISTRATIVE DATA (GENERAL INFORMATION)

## 1.1 Identification of the Testing Laboratory

Company Name	Shenzhen BALUN Technology Co., Ltd.
Address	Block B, 1st FL, Baisha Science and Technology Park, Shahe Xi Road, Nanshan District, Shenzhen, Guangdong Province, P. R. China
Phone Number	+86 755 6685 0100

## 1.2 Identification of the Responsible Testing Location

Test Location	Shenzhen BALUN Technology Co., Ltd.
Address	Block B, 1st FL, Baisha Science and Technology Park, Shahe Xi Road, Nanshan District, Shenzhen, Guangdong Province, P. R. China
Accreditation Certificate	<p>The laboratory has been listed by Industry Canada to perform electromagnetic emission measurements. The recognition numbers of test site are 11524A-1.</p> <p>The laboratory is a testing organization accredited by FCC as a accredited testing laboratory. The designation number is CN1196.</p> <p>The laboratory is a testing organization accredited by American Association for Laboratory Accreditation(A2LA) according to ISO/IEC 17025.The accreditation certificate is 4344.01.</p> <p>The laboratory is a testing organization accredited by China National Accreditation Service for Conformity Assessment (CNAS) according to ISO/IEC 17025. The accreditation certificate number is L6791.</p>
Description	All measurement facilities used to collect the measurement data are located at Block B, FL 1, Baisha Science and Technology Park, Shahe Xi Road, Nanshan District, Shenzhen, Guangdong Province, P. R. China 518055

## 1.3 Laboratory Condition

Ambient Temperature	20°C to 25°C
Ambient Relative Humidity	45% to 55%
Ambient Pressure	100 kPa to 102 kPa

## 1.4 Announce

- (1) The test report reference to the report template version v2.3.
- (2) The test report is invalid if not marked with the signatures of the persons responsible for preparing and approving the test report.
- (3) The test report is invalid if there is any evidence and/or falsification.
- (4) The results documented in this report apply only to the tested sample, under the conditions and modes of operation as described herein.
- (5) This document may not be altered or revised in any way unless done so by BALUN and all revisions are duly noted in the revisions section.
- (6) Content of the test report, in part or in full, cannot be used for publicity and/or promotional purposes without prior written approval from the laboratory.
- (7) The laboratory is only responsible for the data released by the laboratory, except for the part provided by the applicant.

## 2 PRODUCT INFORMATION

### 2.1 Applicant Information

Applicant	Seeed Technology Co., Ltd.
Address	9F, Building G3, TCL International E City, ZhongShanYuan Road, NanShan, ShenZhen, GuangDong Province, China

### 2.2 Manufacturer Information

Manufacturer	Seeed Technology Co., Ltd.
Address	9F, Building G3, TCL International E City, ZhongShanYuan Road, NanShan, ShenZhen, GuangDong Province, China

### 2.3 Factory Information

Factory	N/A
Address	N/A

### 2.4 General Description for Equipment under Test (EUT)

EUT Name	LoRa-E5
Model Name Under Test	LoRa-E5-HF
Series Model Name	N/A
Description of Model name differentiation	N/A
Hardware Version	LoRa-E5-V1.0
Software Version	4.0.10
Dimensions (Approx.)	N/A
Weight (Approx.)	N/A

## 2.5 Technical Information

Network and Wireless connectivity	LoRa
-----------------------------------	------

The requirement for the following technical information of the EUT was tested in this report:

Modulation Technology	DTS
Modulation Type	LoRa
Product Type	<input checked="" type="checkbox"/> Mobile <input type="checkbox"/> Portable <input type="checkbox"/> Fix Location
Frequency Range	The frequency range used is 902 MHz to 928 MHz.
Number of channel	8
Tested Channel	0 (903.0 MHz), 3 (907.8 MHz), 7 (914.2 MHz)
Antenna Type	Dipole Antenna
Antenna Gain	2 dBi (In test items related to antenna gain, the final results reflect this figure. This value is provided by the applicant.)
Antenna System(MIMO Smart Antenna)	N/A

All channel was listed on the following table:

Channel number	Freq. (MHz)	Channel number	Freq. (MHz)	Channel number	Freq. (MHz)	Channel number	Freq. (MHz)
0	<b>903.0</b>	2	906.2	4	909.4	6	912.6
1	904.6	3	<b>907.8</b>	5	911.0	7	<b>914.2</b>



## 2.6 Additional Instructions

EUT Software Settings:

Mode	<input checked="" type="checkbox"/> Special software is used. The software provided by client to enable the EUT under transmission condition continuously at specific channel frequencies individually.
------	--

During testing, Channel and Power Controlling Software provided by the customer was used to control the operating channel as well as the output power level. The RF output power selection is for the setting of RF output power expected by the customer and is going to be fixed on the firmware of the final end product.

Power level setup in software			
Test Software Version	SSCOM V5.12.2		
Support Units (Software installation media)	Description	Manufacturer	Model
		Notebook	Lenovo
Mode	Channel		Soft Set
LoRa	ALL		17

Run Software

The screenshot shows the SSCOM V5.12.2 software interface. The main window displays a log of serial port communication between a host and a device. The log shows several AT commands being sent and received, including power control and mode setting commands. A configuration window titled '多条字符串发送' (Multiple String Sending) is open, showing a list of strings to be sent, such as '13 00 FF 88', 'output string', and '欢迎您使用SSCOM!'. The interface also includes various control buttons like '清除窗口', '打开文件', '发送文件', and '停止', along with settings for baud rate (9600) and other parameters.

### 3 SUMMARY OF TEST RESULTS

#### 3.1 Test Standards

No.	Identity	Document Title
1	47 CFR Part 15, Subpart C	Miscellaneous Wireless Communications Services
2	KDB Publication 558074 D01v05r02	GUIDANCE FOR COMPLIANCE MEASUREMENTS ON DIGITAL TRANSMISSION SYSTEM, FREQUENCY HOPPING SPREAD SPECTRUM SYSTEM, AND HYBRID SYSTEM DEVICES OPERATING UNDER SECTION 15.247 OF THE FCC RULES
3	KDB Publication 662911 D01v02r01	Emissions Testing of Transmitters with Multiple Outputs in the Same Band (e.g., MIMO, Smart Antenna, etc)
4	ANSI C63.10-2013	American National Standard for Testing Unlicensed Wireless Devices

#### 3.2 Verdict

No.	Description	FCC Part No.	Test Result	Verdict
1	Antenna Requirement	15.203	--	Pass <sup>Note1</sup>
2	Output Power	15.247(b)	ANNEX A.1	Pass
3	Occupied Bandwidth	15.247(a)	ANNEX A.2	Pass
4	Conducted Spurious Emission	15.247(d)	ANNEX A.3	Pass
5	Band Edge(Authorized-band band-edge)	15.247(d)	ANNEX A.4	Pass
6	Conducted Emission	15.207	ANNEX A.5	N/A <sup>Note2</sup>
7	Radiated Spurious Emission	15.209 15.247(d)	ANNEX A.6	Pass
8	Band Edge(Restricted-band band-edge)	15.209 15.247(d)	ANNEX A.7	Pass
9	Power spectral density (PSD)	15.247(e)	ANNEX A.8	Pass

Note<sup>1</sup>: The EUT has a permanently and irreplaceable attached antenna, which complies with the requirement FCC 15.203.

Note<sup>2</sup>: The EUT is powered by battery, so the Conducted Emission test is not applicable.

## 4 GENERAL TEST CONFIGURATIONS

### 4.1 Test Environments

During the measurement, the normal environmental conditions were within the listed ranges:

Relative Humidity	45% to 55%	
Atmospheric Pressure	100 kPa to 102 kPa	
Temperature	NT (Normal Temperature)	+22°C to +25°C
Working Voltage of the EUT	NV (Normal Voltage)	3.3 V

### 4.2 Test Equipment List

Description	Manufacturer	Model	Serial No.	Cal. Date	Cal. Due
Spectrum Analyzer	ROHDE&SCHWARZ	FSV-30	103118	2020.06.08	2021.06.07
Switch Unit with OSP-B157	ROHDE&SCHWARZ	OSP120	101270	2020.06.08	2021.06.07
EMI Receiver	KEYSIGHT	N9038A	MY53220118	2020.06.09	2021.06.08
EMI Receiver	ROHDE&SCHWARZ	ESRP	101036	2020.06.09	2021.06.08
LISN	SCHWARZBECK	NSLK 8127	8127-687	2020.06.09	2021.06.08
Bluetooth Tester	ROHDE&SCHWARZ	CBT	101005	2020.06.08	2021.06.07
DC Power Supply	ROHDE&SCHWARZ	HMP2020	018141664	2020.06.08	2021.06.07
Power Splitter	KMW	DCPD-LDC	1305003215	--	--
Power Sensor	ROHDE&SCHWARZ	NRP-Z21	103971	2020.06.08	2021.06.07
Attenuator (20 dB)	KMW	ZA-S1-201	110617091	--	--
Attenuator (6 dB)	KMW	ZA-S1-61	1305003189	--	--
Temperature Chamber	AHK	SP20	1412	2020.06.10	2021.06.09
Test Antenna-Loop(9 kHz-30 MHz)	SCHWARZBECK	FMZB 1519	1519-037	2019.10.29	2021.10.28
Test Antenna-Bi-Log(30 MHz-3 GHz)	SCHWARZBECK	VULB 9163	9163-624	2019.07.02	2021.07.01
Test Antenna-Horn(1-18 GHz)	SCHWARZBECK	BBHA 9120D	9120D-1917	2019.07.02	2021.07.01
Test Antenna-Horn (18-40 GHz)	A-INFO	LB-180400KF	J211060273	2019.01.06	2021.01.05
Anechoic Chamber	RAINFORD	9m*6m*6m	N/A	2017.02.21	2022.02.20
Anechoic Chamber	EMC Electronic Co., Ltd	20.10*11.60*7.35m	N/A	2018.08.08	2021.08.07
Shielded Enclosure	ChangNing	CN-130701	130703	--	--
Signal Generator	ROHDE&SCHWARZ	SMB100A	177746	2020.06.08	2021.06.07
Power Amplifier	OPHIR RF	5225F	1037	2020.02.19	2021.02.18
Power Amplifier	OPHIR RF	5273F	1016	2020.02.19	2021.02.18
Directional Coupler	Werlantone	C5982-10	109275	N/A	N/A
Directional Coupler	Werlantone	CHP-273E	S00801z-01	N/A	N/A
Sound Level Meter	B&K	NL-20	00844023	2020.10.23	2021.10.22
Ear Simulator	B&K	4192-L-001	3038758	2020.02.19	2021.02.18

Description	Manufacturer	Model	Serial No.	Cal. Date	Cal. Due
Audio analyzer	B&K	UPL 16	100129	2020.02.28	2021.02.27

### 4.3 Measurement Uncertainty

The following measurement uncertainty levels have been estimated for tests performed on the EUT as specified in CISPR 16-4-2.

This uncertainty represents an expanded uncertainty expressed at approximately the 95% confidence level using a coverage factor of k=2.

Measurement	Value
Occupied Channel Bandwidth	±4%
RF output power, conducted	±1.4 dB
Power Spectral Density, conducted	±2.5 dB
Unwanted Emissions, conducted	±2.8 dB
All emissions, radiated	±5.4 dB
Temperature	±1°C
Humidity	±4%

### 4.4 Description of Test Setup

#### 4.4.1 For Antenna Port Test

Conducted value (dBm) = Measurement value (dBm) + cable loss (dB)

For example: the measurement value is 10 dBm and the cable 0.5dBm used, then the final result of EUT:

Conducted value (dBm) = 10 dBm + 0.5 dB = 10.5 dBm

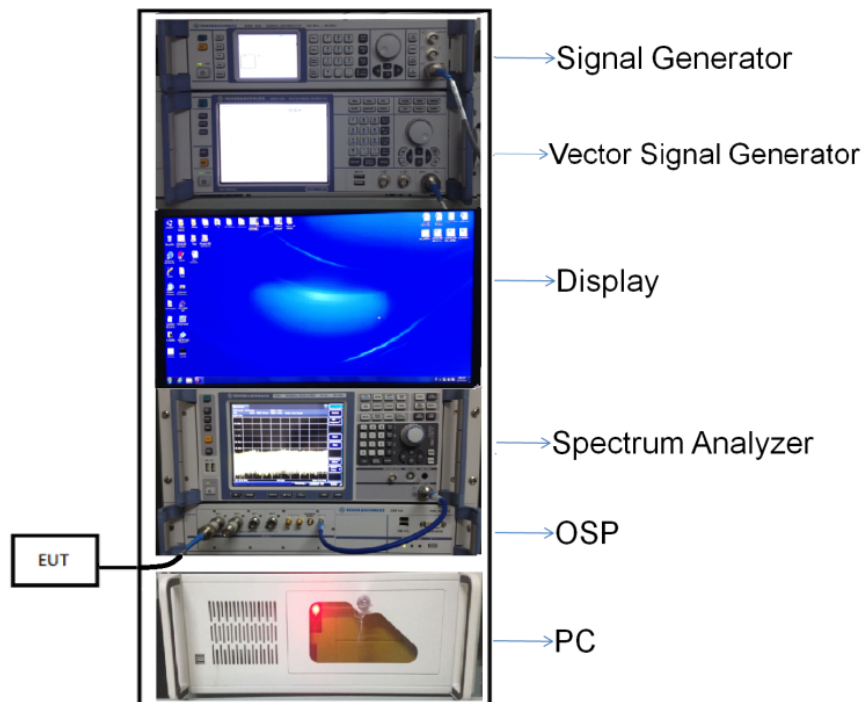

(Diagram 1)

## 4.4.2 For AC Power Supply Port Test

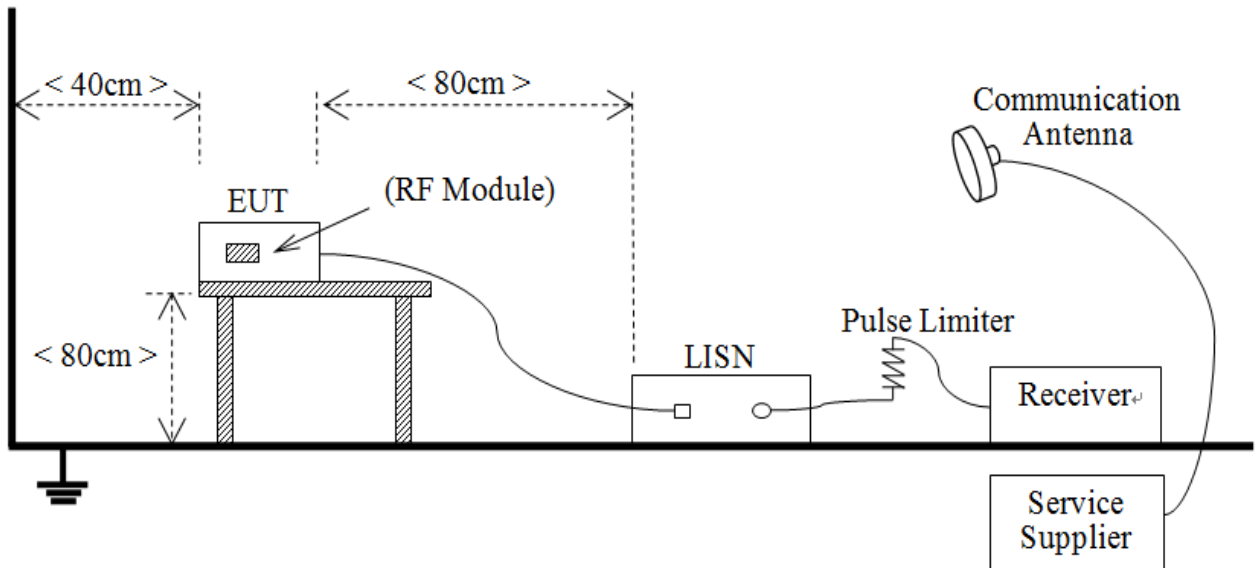

(Diagram 2)

## 4.4.3 For Radiated Test (Below 30 MHz)

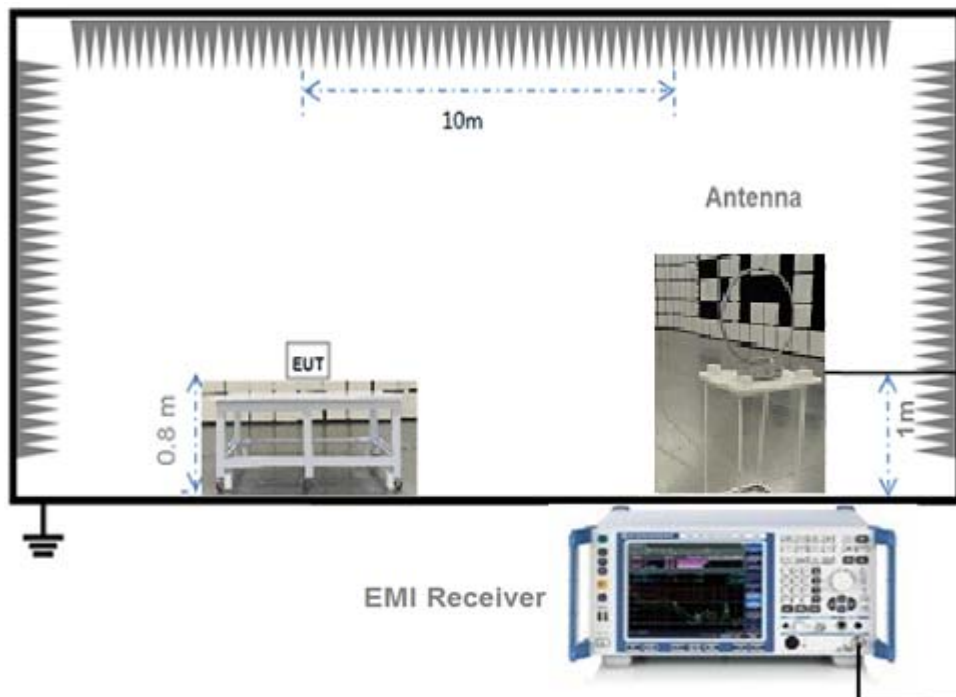

(Diagram 3)

4.4.4 For Radiated Test (30 MHz-1 GHz)

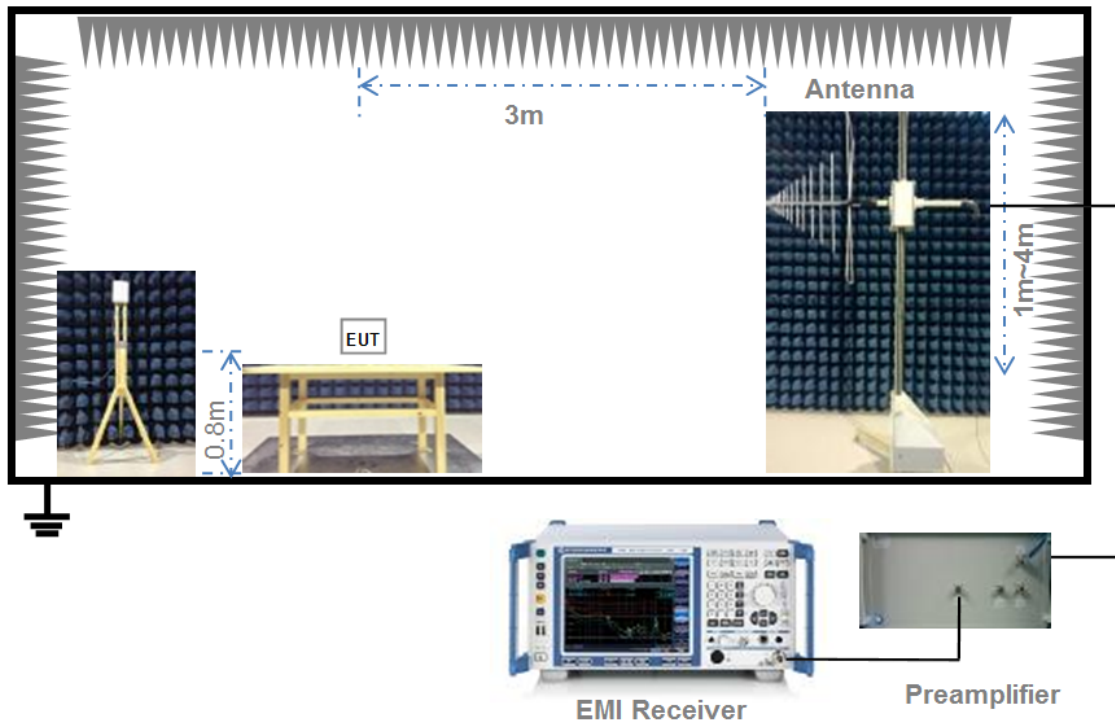

(Diagram 4)

4.4.5 For Radiated Test (Above 1 GHz)

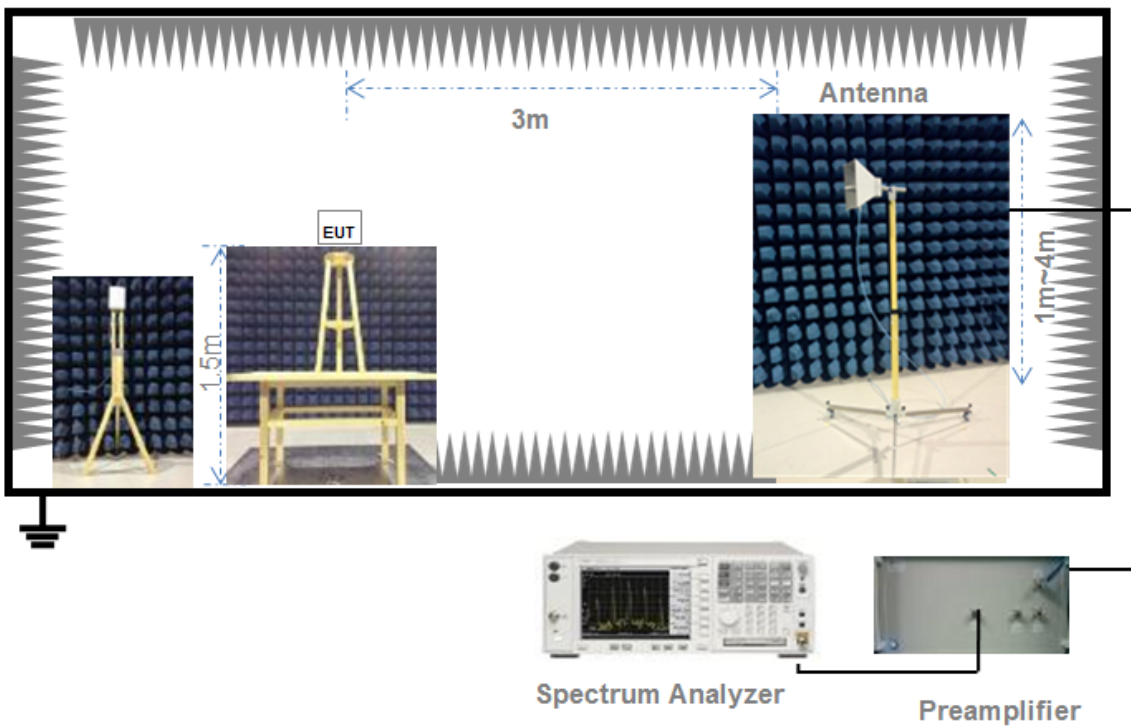

(Diagram 5)

## 4.5 Measurement Results Explanation Example

### 4.5.1 For conducted test items:

The offset level is set in the spectrum analyzer to compensate the RF cable loss and attenuator between EUT conducted output port and spectrum analyzer. With the offset compensation, the spectrum analyzer reading level is exactly the EUT RF output level.

The spectrum analyzer offset is derived from RF cable loss and attenuator factor.

Offset = RF cable loss + attenuator factor.

### 4.5.2 For radiated band edges and spurious emission test:

$$E = \text{EIRP} - 20\log D + 104.8$$

where:

E = electric field strength in dB $\mu$ V/m,

EIRP = equivalent isotropic radiated power in dBm

D = specified measurement distance in meters.

EIRP = Measure Conducted output power Value (dBm) + Maximum transmit antenna gain (dBi) + the appropriate maximum ground reflection factor (dB)

## 5 TEST ITEMS

### 5.1 Antenna Requirements

#### 5.1.1 Relevant Standards

FCC §15.203 & 15.247(b); RSS-247, 5.4 (6)

An intentional radiator shall be designed to ensure that no antenna other than that furnished by the responsible party shall be used with the device. The use of a permanently attached antenna or of an antenna that uses a unique coupling to the intentional radiator shall be considered sufficient to comply with the provisions of this section. The manufacturer may design the unit so that a broken antenna can be replaced by the user, but the use of a standard antenna jack or electrical connector is prohibited. This requirement does not apply to carrier current devices or to devices operated under the provisions of § 15.211, § 15.213, § 15.217, § 15.219, or § 15.221. Further, this requirement does not apply to intentional radiators that must be professionally installed, such as perimeter protection systems and some field disturbance sensors, or to other intentional radiators which, in accordance with § 15.31(d), must be measured at the installation site. However, the installer shall be responsible for ensuring that the proper antenna is employed so that the limits in this part are not exceeded.

If directional gain of transmitting antennas is greater than 6 dBi, the power shall be reduced by the same level in dB comparing to gain minus 6 dBi. For the fixed point-to-point operation, the power shall be reduced by one dB for every 3 dB that the directional gain of the antenna exceeds 6 dBi. The use of a permanently attached antenna or of an antenna that uses a unique coupling to the intentional radiator shall be considered sufficient to comply with the FCC rule.

#### 5.1.2 Antenna Anti-Replacement Construction

The Antenna Anti-Replacement as following method:

Protected Method	Description
The antenna is embedded in the product.	The antenna is welded on the mainboard, can't be replaced by the consumer

Reference Documents	Item
Photo	Please refer to the EUT Photo documents.

#### 5.1.3 Antenna Gain

The antenna peak gain of EUT is less than 6 dBi. Therefore, it is not necessary to reduce maximum peak output power limit.



## 5.2 Output Power

### 5.2.1 Test Limit

FCC § 15.247(b)

For systems using digital modulation in the 902-928 MHz, 2400-2483.5 MHz, and 5725-5850 MHz bands: 1 Watt. As an alternative to a peak power measurement, compliance with the one Watt limit can be based on a measurement of the maximum conducted output power. Maximum Conducted Output Power is defined as the total transmit power delivered to all antennas and antenna elements averaged across all symbols in the signaling alphabet when the transmitter is operating at its maximum power control level. Power must be summed across all antennas and antenna elements.

RSS-247, 5.4 (4)

For DTSs employing digital modulation techniques operating in the bands 902-928 MHz and 2400-2483.5 MHz, the maximum peak conducted output power shall not exceed 1W. Except as provided in Section 5.4(5), the e.i.r.p. shall not exceed 4 W.

### 5.2.2 Test Setup

See section 4.4.1 for test setup description for the antenna port. The photo of test setup please refer to ANNEX B.

### 5.2.3 Test Procedure

#### a) Maximum peak conducted output power

This procedure shall be used when the measurement instrument has available a resolution bandwidth that is greater than the DTS bandwidth.

Set the RBW  $\geq$  DTS bandwidth.

Set VBW  $\geq 3 \times$  RBW.

Set span  $\geq 3 \times$  RBW

Sweep time = auto couple.

Detector = peak.

Trace mode = max hold.

Allow trace to fully stabilize.

Use peak marker function to determine the peak amplitude level.

#### b) Measurements of duty cycle

The zero-span mode on a spectrum analyzer or EMI receiver if the response time and spacing between bins on the sweep are sufficient to permit accurate measurements of the on and off times of the transmitted signal.

Set the center frequency of the instrument to the center frequency of the transmission.

Set RBW  $\geq$  OBW if possible; otherwise, set RBW to the largest available value.

Set VBW  $\geq$  RBW. Set detector = peak or average.

The zero-span measurement method shall not be used unless both RBW and VBW are  $> 50/T$  and the number of

sweep points across duration T exceeds 100. (For example, if VBW and/or RBW are limited to 3 MHz, then the zero-span method of measuring duty cycle shall not be used if  $T \leq 16.7$  microseconds.)

#### 5.2.4 Test Result

Please refer to ANNEX A.1.

## 5.3 Occupied Bandwidth

### 5.3.1 Limit

FCC §15.247(a); RSS-247, 5.1 (1); RSS-GEN, 6.6

Make the measurement with the spectrum analyzer's resolution bandwidth (RBW) = 100 kHz. In order to make an accurate measurement, set the span greater than RBW. The 6 dB bandwidth must be greater than 500 kHz.

### 5.3.2 Test Setup

See section 4.4.1 for test setup description for the antenna port. The photo of test setup please refer to ANNEX B.

### 5.3.3 Test Procedure

Use the following spectrum analyzer settings:

Set RBW = 100 kHz.

Set the video bandwidth (VBW)  $\geq 3$  RBW.

Detector = Peak.

Trace mode = max hold.

Sweep = auto couple.

Allow the trace to stabilize.

Measure the maximum width of the emission that is constrained by the frequencies associated with the two outermost amplitude points (upper and lower frequencies) that are attenuated by 6 dB relative to the maximum level measured in the fundamental emission.

### 5.3.4 Test Result

Please refer to ANNEX A.2.

## 5.4 Conducted Spurious Emission

### 5.4.1 Limit

FCC §15.247(d); RSS-247, 5.5

In any 100 kHz bandwidth outside the frequency band in which the spread spectrum or digitally modulated intentional radiator is operating, the radio frequency power that is produced by the intentional radiator shall be at least 20 dB below that in the 100 kHz bandwidth within the band that contains the highest level of the desired power, based on either an RF conducted or a radiated measurement.

### 5.4.2 Test Setup

See section 4.4.1 for test setup description for the antenna port. The photo of test setup please refer to ANNEX B.

### 5.4.3 Test Procedure

The DTS rules specify that in any 100 kHz bandwidth outside of the authorized frequency band, the power shall be attenuated according to the following conditions:

- a) If the maximum peak conducted output power procedure was used to demonstrate compliance as described in 9.1, then the peak output power measured in any 100 kHz bandwidth outside of the authorized frequency band shall be attenuated by at least 20 dB relative to the maximum in-band peak PSD level in 100 kHz (i.e., 20 dBc).
- b) If maximum conducted (average) output power was used to demonstrate compliance as described in 9.2, then the peak power in any 100 kHz bandwidth outside of the authorized frequency band shall be attenuated by at least 30 dB relative to the maximum in-band peak PSD level in 100 kHz (i.e., 30 dBc).
- c) In either case, attenuation to levels below the 15.209 general radiated emissions limits is not required.

The following procedures shall be used to demonstrate compliance to these limits. Note that these procedures can be used in either an antenna-port conducted or radiated test set-up. Radiated tests must conform to the test site requirements and utilize maximization procedures defined herein.

Reference level measurement:

Establish a reference level by using the following procedure:

Set instrument center frequency to DTS channel center frequency.

Set the span to  $\geq 1.5$  times the DTS bandwidth.

Set the RBW = 100 kHz.

Set the VBW  $\geq 3 \times$  RBW.

Detector = peak.

Sweep time = auto couple.

Trace mode = max hold.

Allow trace to fully stabilize.

Use the peak marker function to determine the maximum PSD level.

Emission level measurement:

Use the following spectrum analyzer settings:

Span = wide enough to capture the peak level of the in-band emission and all spurious emissions (e.g., harmonics) from the lowest frequency generated in the EUT up through the 10th harmonic. Typically, several plots are required to cover this entire span.

Set the RBW = 100 kHz.

Set the VBW  $\geq 3 \times$  RBW.

Detector = peak.

Sweep time = auto couple.

Trace mode = max hold.

Allow trace to fully stabilize.

Use the peak marker function to determine the maximum amplitude level.

Ensure that the amplitude of all unwanted emissions outside of the authorized frequency band (excluding restricted frequency bands) are attenuated by at least the minimum requirements specified in 11.1 a) or 11.1 b). Report the three highest emissions relative to the limit.

#### 5.4.4 Test Result

Please refer to ANNEX A.3.

## 5.5 Band Edge (Authorized-band band-edge)

### 5.5.1 Limit

FCC §15.247(d); RSS-247, 5.5

In any 100 kHz bandwidth outside the frequency band in which the spread spectrum or digitally modulated intentional radiator is operating, the radio frequency power that is produced by the intentional radiator shall be at least 20 dB below that in the 100 kHz bandwidth within the band that contains the highest level of the desired power, based on either an RF conducted or a radiated measurement.

### 5.5.2 Test Setup

See section 4.4.1 for test setup description for the antenna port. The photo of test setup please refer to ANNEX B.

### 5.5.3 Test Procedure

The following procedures may be used to determine the peak or average field strength or power of an unwanted emission that is within 2 MHz of the authorized band edge. If a peak detector is utilized, use the procedure described in 13.2.1. Use the procedure described in 13.2.2 when using an average detector and the EUT can be configured to transmit continuously (i.e., duty cycle  $\geq 98\%$ ). Use the procedure described in 13.2.3 when using an average detector and the EUT cannot be configured to transmit continuously but the duty cycle is constant (i.e., duty cycle variations are less than  $\pm 2$  percent). Use the procedure described in 13.2.4 when using an average detector for those cases where the EUT cannot be configured to transmit continuously and the duty cycle is not constant (duty cycle variations equal or exceed 2 percent).

When using a peak detector to measure unwanted emissions at or near the band edge (within 2 MHz of the authorized band), the following integration procedure can be used.

Set instrument center frequency to the frequency of the emission to be measured (must be within 2 MHz of the authorized band edge).

Set span to 2 MHz

RBW = 100 kHz.

VBW  $\geq 3 \times$  RBW.

Detector = peak.

Sweep time = auto.

Trace mode = max hold.

Allow sweep to continue until the trace stabilizes (required measurement time may increase for low duty cycle applications)

Compute the power by integrating the spectrum over 1 MHz using the analyzer's band power measurement function with band limits set equal to the emission frequency (femission)  $\pm 0.5$  MHz. If the instrument does not have a band power function, then sum the amplitude levels (in power units) at 100 kHz intervals extending across the 1 MHz spectrum defined by femission  $\pm 0.5$  MHz.

### 5.5.4 Test Result

Please refer to ANNEX A.4.

## 5.6 Conducted Emission

### 5.6.1 Limit

FCC §15.207; RSS-GEN, 8.8

For an intentional radiator that is designed to be connected to the public utility (AC) power line, the radio frequency voltage that is conducted back onto the AC power line on any frequency within the band 150 kHz to 30 MHz shall not exceed the limits in the following table, as measured using a 50 $\mu$ H/50 $\Omega$  line impedance stabilization network (LISN).

Frequency range (MHz)	Conducted Limit (dB $\mu$ V)	
	Quai-peak	Average
0.15 - 0.50	66 to 56	56 to 46
0.50 - 5	56	46
0.50 - 30	60	50

### 5.6.2 Test Setup

See section 4.4.2 for test setup description for the AC power supply port. The photo of test setup please refer to ANNEX B.

### 5.6.3 Test Procedure

The maximum conducted interference is searched using Peak (PK), if the emission levels more than the AV and QP limits, and that have narrow margins from the AV and QP limits will be re-measured with AV and QP detectors. Tests for both L phase and N phase lines of the power mains connected to the EUT are performed. Refer to recorded points and plots below.

Devices subject to Part 15 must be tested for all available U.S. voltages and frequencies (such as a nominal 120 VAC, 50/60 Hz and 240 VAC, 50/60 Hz) for which the device is capable of operation. A device rated for 50/60 Hz operation need not be tested at both frequencies provided the radiated and line conducted emissions are the same at both frequencies.

### 5.6.4 Test Result

Please refer to ANNEX A.5.

## 5.7 Radiated Spurious Emission

### 5.7.1 Limit

FCC §15.209&15.247(d); RSS-GEN, 8.9; RSS-247, 5.5

Radiated emission outside the frequency band attenuation below the general limits specified in FCC section 15.209(a) is not required. In addition, radiated emissions which fall in the restricted bands, as defined in FCC section 15.205(a), must also comply with the radiated emission limits specified in FCC section 15.209(a).

According to FCC section 15.209 (a), except as provided elsewhere in this subpart, the emissions from an intentional radiator shall not exceed the field strength levels specified in the following table:

Frequency (MHz)	Field Strength ( $\mu\text{V}/\text{m}$ )	Measurement Distance (m)
0.009 - 0.490	2400/F(kHz)	300
0.490 - 1.705	24000/F(kHz)	30
1.705 - 30.0	30	30
30 - 88	100	3
88 - 216	150	3
216 - 960	200	3
Above 960	500	3

Note:

1. Field Strength (dB $\mu\text{V}/\text{m}$ ) = 20\*log[Field Strength ( $\mu\text{V}/\text{m}$ )].
2. In the emission tables above, the tighter limit applies at the band edges.
3. For Above 1000 MHz, the emission limit in this paragraph is based on measurement instrumentation employing an average detector, measurement using instrumentation with a peak detector function, corresponding to 20dB above the maximum permitted average limit.
4. For above 1000 MHz, limit field strength of harmonics: 54dBuV/m@3m (AV) and 74dBuV/m@3m (PK).

### 5.7.2 Test Setup

See section 4.4.3 to 4.4.5 for test setup description for the antenna port. The photo of test setup please refer to ANNEX B.

### 5.7.3 Test Procedure

The measurement frequency range is from 9 kHz to the 10th harmonic of the fundamental frequency. The Turn Table is actuated to turn from 0° to 360°, and both horizontal and vertical polarizations of the Test Antenna are used to find the maximum radiated power. Mid channels on all channel bandwidth verified. Only the worst RB size/offset presented.

The power of the EUT transmitting frequency should be ignored.

All Spurious Emission tests were performed in X, Y, Z axis direction. And only the worst axis test condition was recorded in this test report.

Use the following spectrum analyzer settings:

Span = wide enough to fully capture the emission being measured



RBW = 1 MHz for  $f \geq 1$  GHz, 100 kHz for  $f < 1$  GHz

VBW  $\geq$  RBW

Sweep = auto

Detector function = peak

Trace = max hold

For measurement below 1GHz, If the emission level of the EUT measured by the peak detector is 3 dB lower than the applicable limit, the peak emission level will be reported, Otherwise, the emission measurement will be repeated using the quasi-peak detector and reported.

#### 5.7.4 Test Result

Please refer to ANNEX A.6.

## 5.8 Band Edge (Restricted-band band-edge)

### 5.8.1 Limit

FCC §15.209&15.247(d); RSS-GEN, 8.9; RSS-247, 5.5

Radiated emission outside the frequency band attenuation below the general limits specified in FCC section 15.209(a) is not required. In addition, radiated emissions which fall in the restricted bands, as defined in FCC section 15.205(a), must also comply with the radiated emission limits specified in FCC section 15.209(a).

### 5.8.2 Test Setup

See section 4.4.3 to 4.4.5 for test setup description for the antenna port. The photo of test setup please refer to ANNEX B.

### 5.8.3 Test Procedure

The measurement frequency range is from 9 kHz to the 10th harmonic of the fundamental frequency. The Turn Table is actuated to turn from 0° to 360°, and both horizontal and vertical polarizations of the Test Antenna are used to find the maximum radiated power. Mid channels on all channel bandwidth verified. Only the worst RB size/offset presented.

The power of the EUT transmitting frequency should be ignored.

All Spurious Emission tests were performed in X, Y, Z axis direction. And only the worst axis test condition was recorded in this test report.

Use the following spectrum analyzer settings:

Span = wide enough to fully capture the emission being measured

RBW = 1 MHz for  $f \geq 1$  GHz, 100 kHz for  $f < 1$  GHz

VBW  $\geq$  RBW

Sweep = auto

Detector function = peak

Trace = max hold

For measurement below 1GHz, If the emission level of the EUT measured by the peak detector is 3 dB lower than the applicable limit, the peak emission level will be reported, Otherwise, the emission measurement will be repeated using the quasi-peak detector and reported.

For transmitters operating above 1 GHz repeat the measurement with an average detector.

### 1.1.1 Test Result

Please refer to ANNEX A.7.

## 5.9 Power Spectral density (PSD)

### 5.9.1 Limit

FCC §15.247(e); RSS-247, 5.2 (2)

The same method of determining the conducted output power shall be used to determine the power spectral density. If a peak output power is measured, then a peak power spectral density measurement is required. If an average output power is measured, then an average power spectral density measurement should be used.

The transmitter power spectral density conducted from the transmitter to the antenna shall not be greater than 8 dBm in any 3 kHz band during any time interval of continuous transmission. This power spectral density shall be determined in accordance with the provisions of Section 5.4(4), (i.e. the power spectral density shall be determined using the same method as is used to determine the conducted output power).

### 5.9.2 Test Setup

See section 4.4.1 (Diagram 1) for test setup description for the antenna port. The photo of test setup please refer to ANNEX B.

### 5.9.3 Test Procedure

Set analyzer center frequency to DTS channel center frequency.

Set the span to 1.5 times the DTS bandwidth.

Set the RBW to:  $3 \text{ kHz} \leq \text{RBW} \leq 100 \text{ kHz}$ .

Set the VBW  $\geq 3 \text{ RBW}$ .

Detector = peak.

Sweep time = auto couple.

Trace mode = max hold.

Allow trace to fully stabilize.

Use the peak marker function to determine the maximum amplitude level within the RBW.

If measured value exceeds limit, reduce RBW (no less than 3 kHz) and repeat.

### 5.9.4 Test Result

Please refer to ANNEX A.7.

# ANNEX A TEST RESULT

## A.1 Output Power

### Peak Power Test Data

Channel	Measured Output Peak Power		Limit		Verdict
	LoRa		dBm	mW	
	dBm	mW			
Low	15.82	38.19	30	1000	Pass
Middle	15.74	37.50			Pass
High	16.02	39.99			Pass

### Test plots

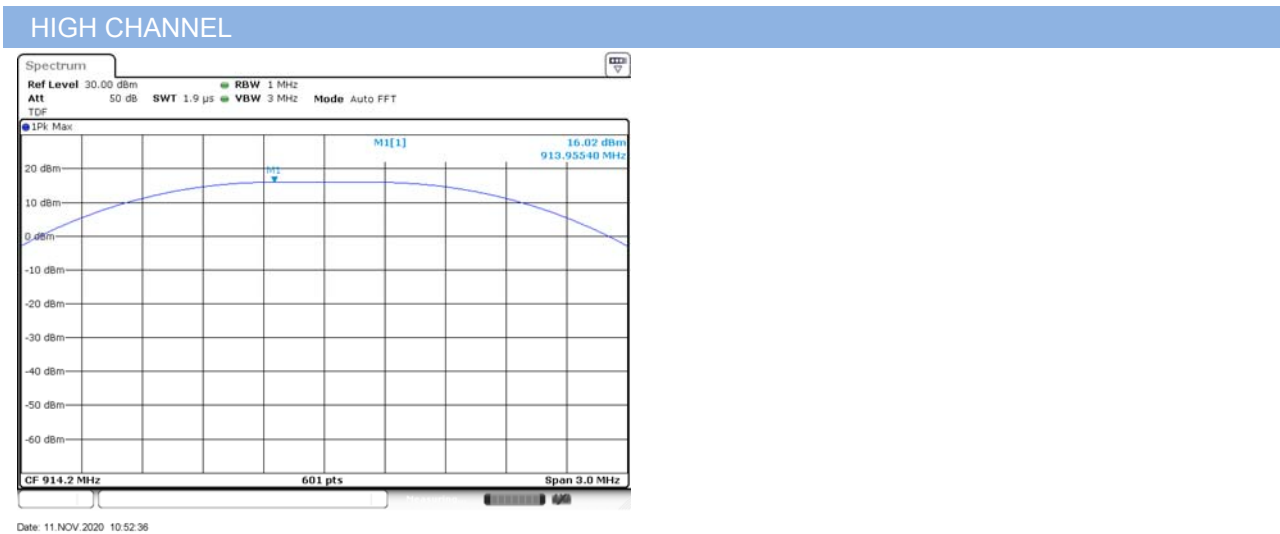
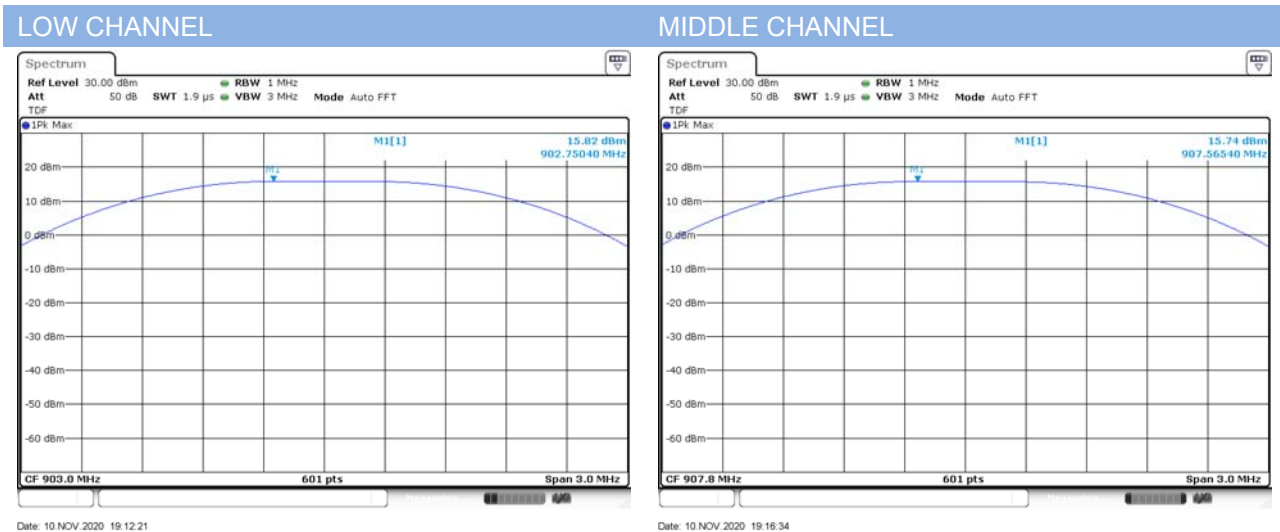

## A.2 Occupied Bandwidth

### Test Data

Test Mode	LoRa		
Channel	6 dB Bandwidth (kHz)	99% Bandwidth (kHz)	6 dB Bandwidth Limits (kHz)
Low Channel	0.641296	0.666000	≥500
Middle Channel	0.643494	0.681000	≥500
High Channel	0.641357	0.655500	≥500

### Test plots (6 dB Bandwidth)

#### LOW CHANNEL



Date: 10 NOV 2020 19:12:27

#### MIDDLE CHANNEL

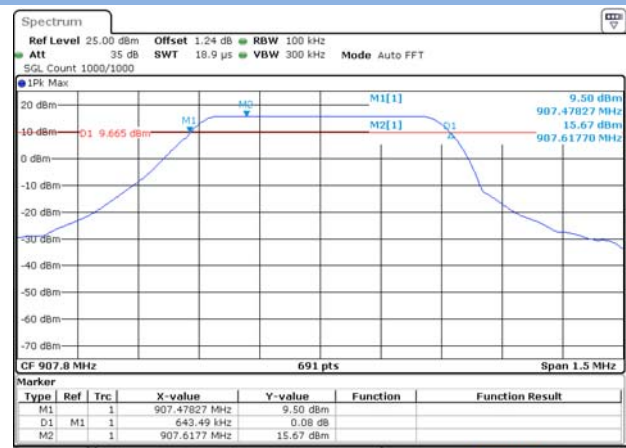

Date: 10 NOV 2020 19:16:40

#### HIGH CHANNEL

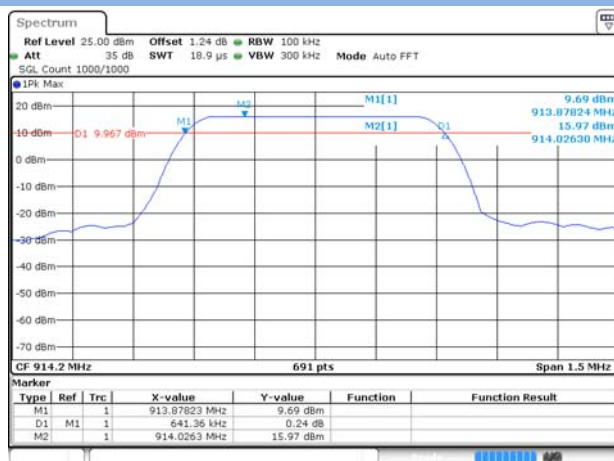

Date: 11 NOV 2020 10:52:42

Test plots (99% Bandwidth)

LOW CHANNEL

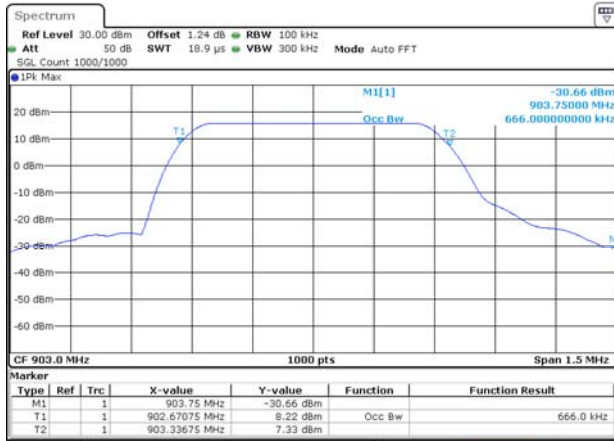

Date: 10 NOV 2020 19:12:51

MIDDLE CHANNEL

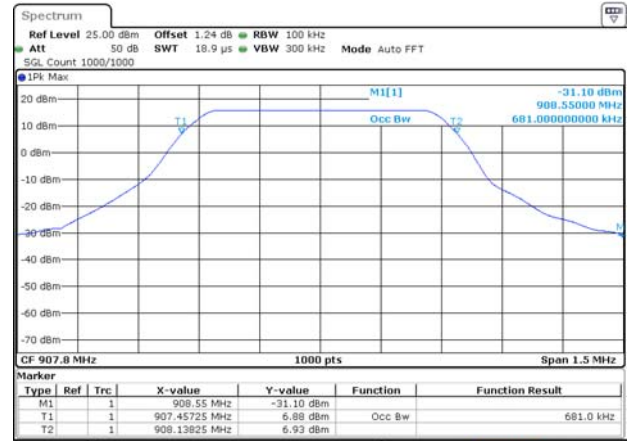

Date: 10 NOV 2020 19:17:18

HIGH CHANNEL

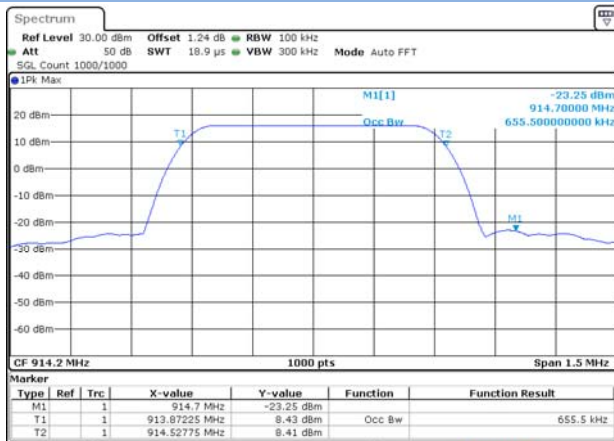

Date: 11 NOV 2020 10:53:08

### A.3 Conducted Spurious Emissions

#### Test Data

LoRa				
Channel	Measured Max. Out of Band Emission (dBm)	Limit (dBm)		Verdict
		Carrier Level	Calculated 20 dBc Limit	
Low	-26.11	15.79	-4.21	Pass
Middle	-25.37	15.71	-4.29	Pass
High	-25.34	15.96	-4.04	Pass

#### Test Plots

##### LOW CHANNEL, CARRIER LEVEL

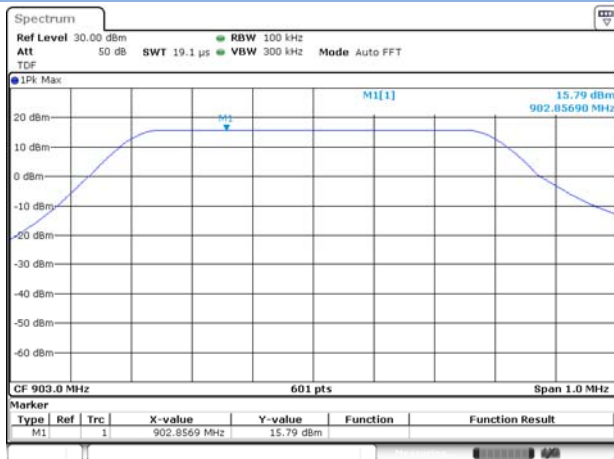

Date: 10 NOV 2020 19:13:19

##### LOW CHANNEL, SPURIOUS 30 MHz ~ 3 GHz

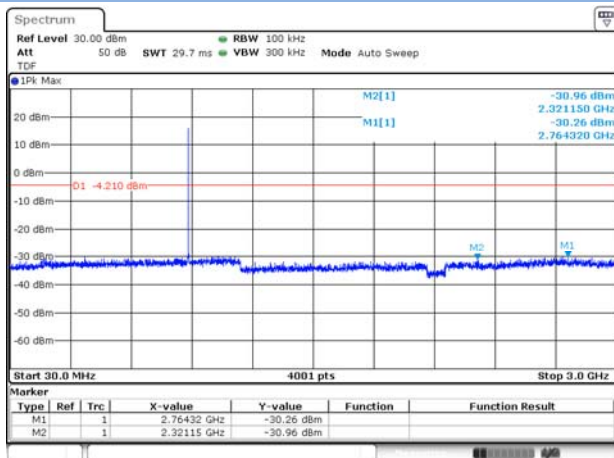

Date: 10 NOV 2020 19:14:07

##### LOW CHANNEL, SPURIOUS 3 GHz ~ 25 GHz

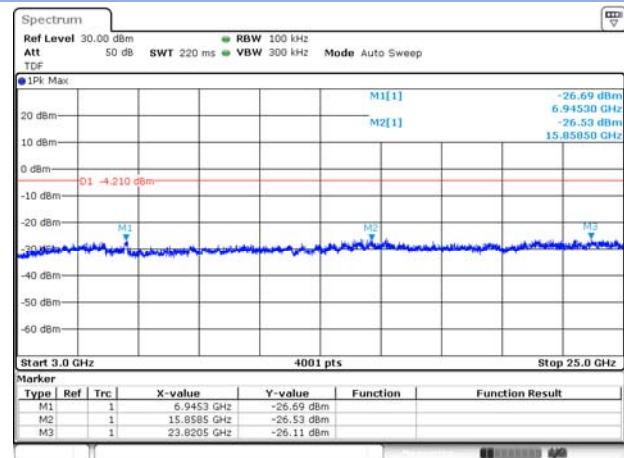

Date: 10 NOV 2020 19:14:25

MIDDLE CHANNEL, CARRIER LEVEL

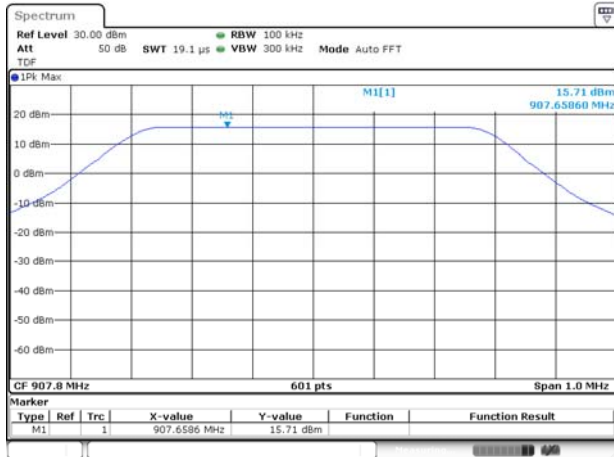

Date: 10.NOV.2020 19:17:33

MIDDLE CHANNEL, SPURIOUS 30 MHz ~ 3 GHz

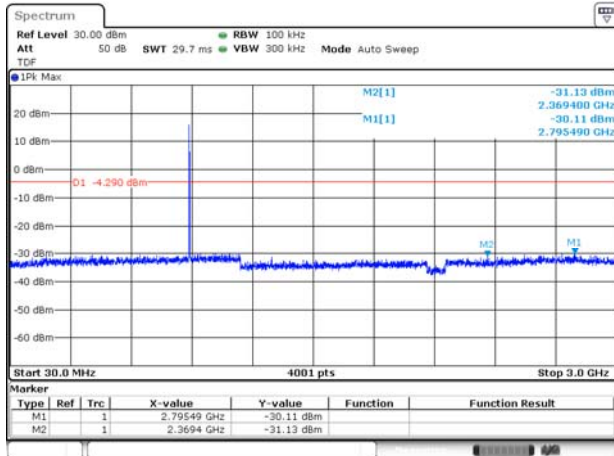

Date: 10.NOV.2020 19:18:01

MIDDLE CHANNEL, SPURIOUS 3 GHz ~ 25 GHz

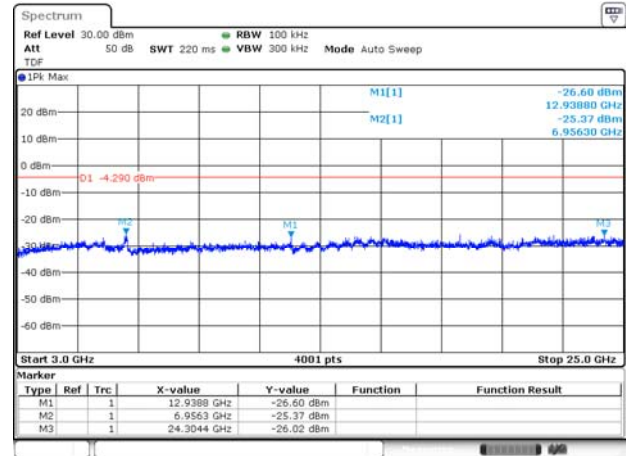

Date: 10.NOV.2020 19:18:18

High CHANNEL, CARRIER LEVEL

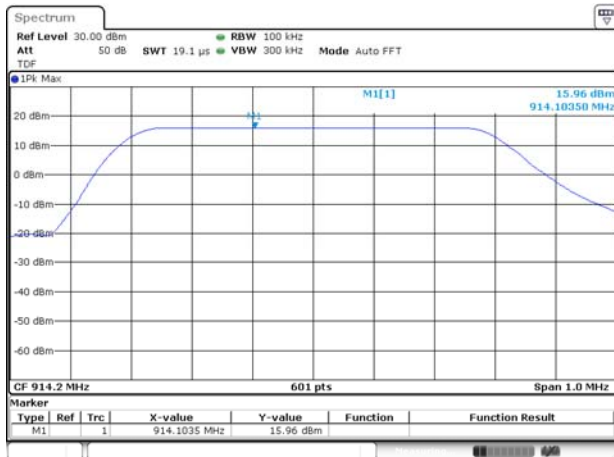

Date: 11.NOV.2020 10:53:24



HIGH CHANNEL, SPURIOUS 30 MHz ~ 3 GHz

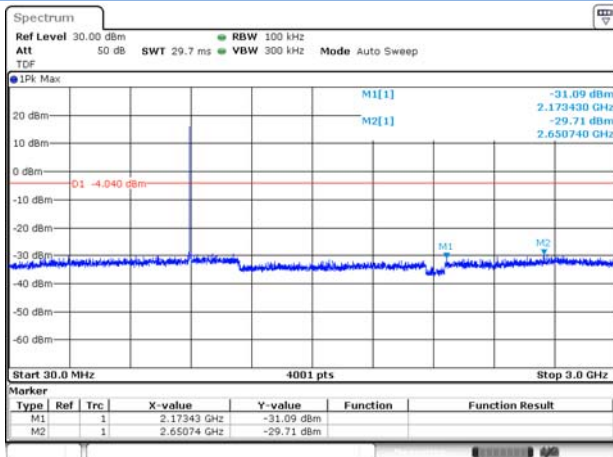

Date: 11.NOV.2020 10:54:03

HIGH CHANNEL, SPURIOUS 3 GHz ~ 25 GHz

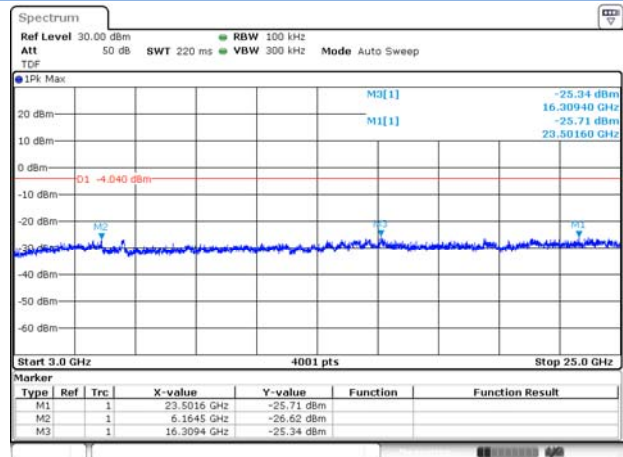

Date: 11.NOV.2020 10:54:23

## A.4 Band Edge (Authorized-band band-edge)

Note: The lowest and highest channels are tested to verify the band edge emissions. Please refer to the following the plots for emissions values.

Channel	Measured Max. Band Edge Emission (dBm)	Limit (dBm)		Verdict
		Carrier Level	Calculated 20 dBc Limit	
Low Channel	-31.73	15.79	-4.21	Pass
High Channel	-55.49	15.96	-4.04	Pass

### Test Plots

LOW CHANNEL, Carrier level

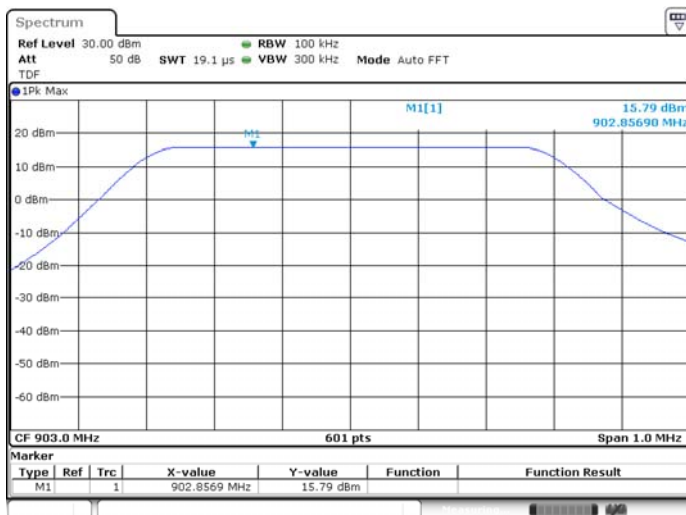

Date: 10 NOV 2020 19:13:19

LOW CHANNEL, Band Edge



Date: 10 NOV 2020 19:15:00

High CHANNEL, Carrier level

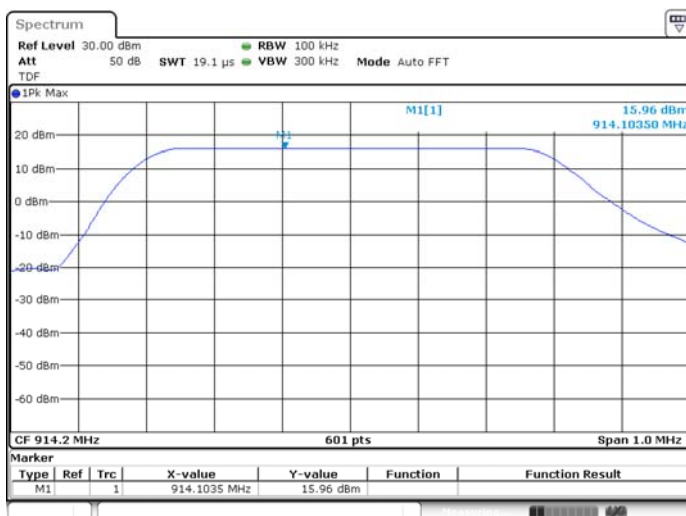

Date: 11 NOV 2020 10:53:24

High CHANNEL, Band Edge

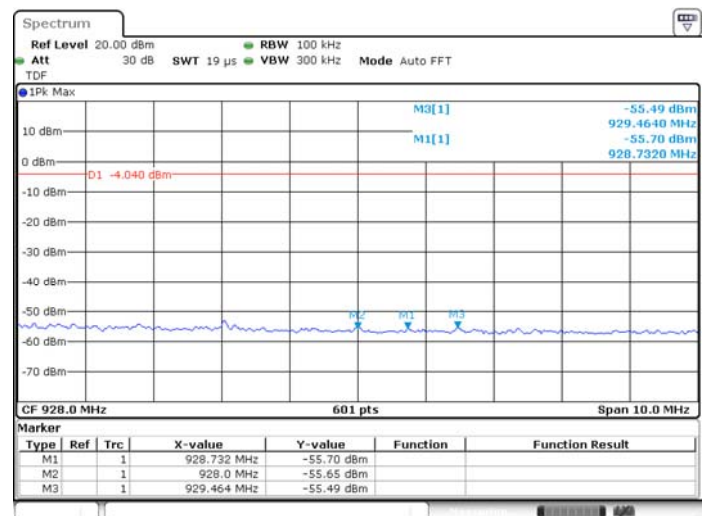

Date: 11 NOV 2020 10:54:46

## A.5 Conducted Emissions

Note<sup>1</sup>: The EUT is working in the Normal link mode. All modes have been tested and normal link mode is worst.  
 Note<sup>2</sup>: Devices subject to Part 15 must be tested for all available U.S. voltages and frequencies (such as a nominal 120 VAC, 60 Hz and 240 VAC, 50 Hz) for which the device is capable of operation. So, The configuration 120 VAC, 60 Hz and 240 VAC, 50 Hz were tested respectively, but only the worst configuration (120 VAC, 60 Hz ) shown here.

Note<sup>3</sup>: Results (dBuV) = Original reading level of Spectrum Analyzer (dBuV) + Factor (dB)

### Test Data and Plots

#### PHASE L

CE Test case\_FCC\_CE\_FCC PART 15B\_Class B

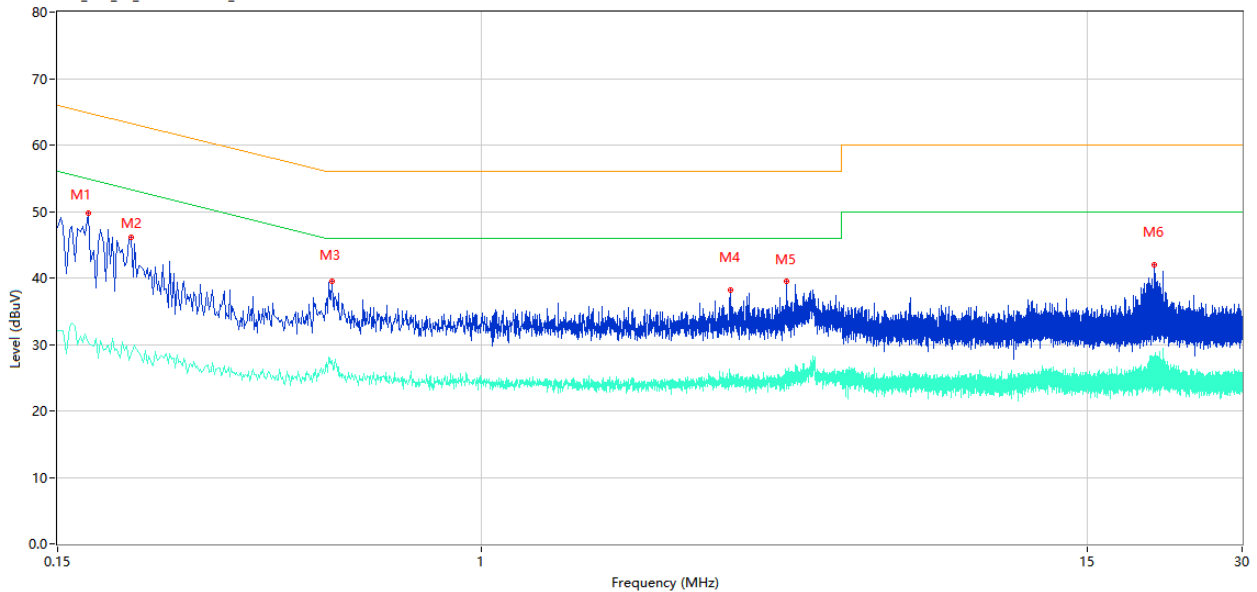

No.	Frequency (MHz)	Results (dBuV)	Factor (dB)	Limit (dBuV)	Over Limit (dB)	Detector	Line	Verdict
1	0.172	49.83	10.40	64.86	-15.03	Peak	L	Pass
1**	0.172	30.27	10.40	54.86	-24.59	AV	L	Pass
2	0.208	46.14	10.38	63.28	-17.14	Peak	L	Pass
2**	0.208	28.59	10.38	53.28	-24.69	AV	L	Pass
3	0.512	39.54	10.30	56.00	-16.46	Peak	L	Pass
3**	0.512	27.68	10.30	46.00	-18.32	AV	L	Pass
4	3.038	38.22	10.28	56.00	-17.78	Peak	L	Pass
4**	3.038	24.89	10.28	46.00	-21.11	AV	L	Pass
5	3.902	39.58	10.30	56.00	-16.42	Peak	L	Pass
5**	3.902	25.97	10.30	46.00	-20.03	AV	L	Pass
6	20.248	41.96	10.56	60.00	-18.04	Peak	L	Pass
6**	20.248	27.93	10.56	50.00	-22.07	AV	L	Pass

## PHASE N

CE Test case\_FCC\_CE\_FCC PART 15B\_Class B

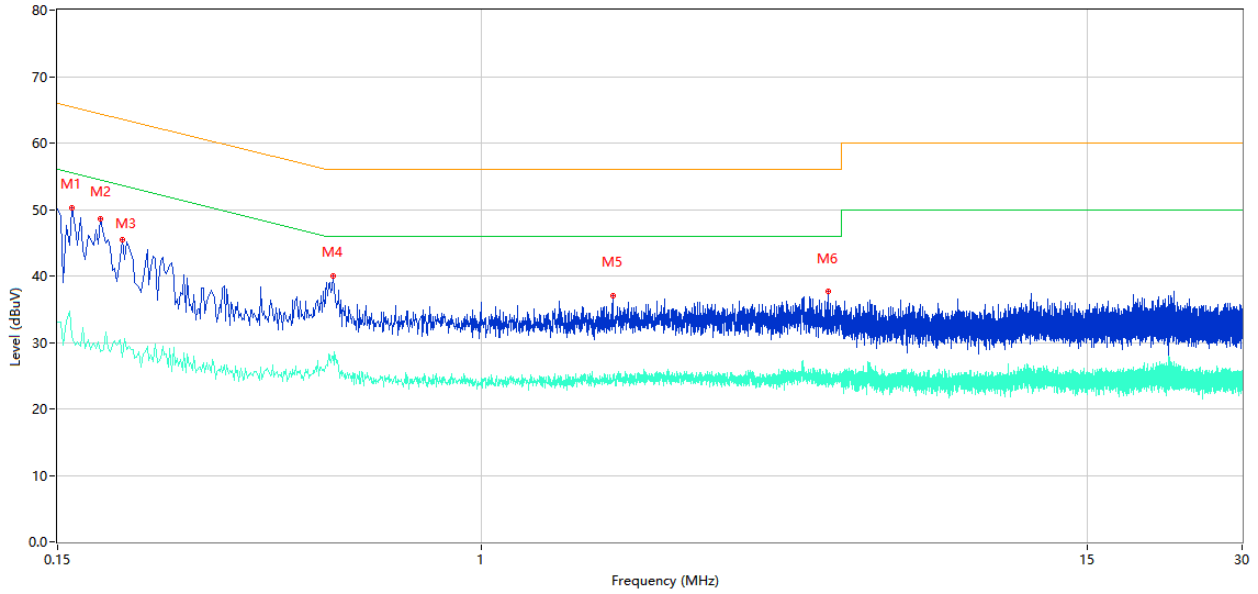

No.	Frequency (MHz)	Results (dBuV)	Factor (dB)	Limit (dBuV)	Over Limit (dB)	Detector	Line	Verdict
1	0.160	50.20	10.40	65.46	-15.26	Peak	N	Pass
1**	0.160	30.87	10.40	55.46	-24.59	AV	N	Pass
2	0.182	48.60	10.39	64.39	-15.79	Peak	N	Pass
2**	0.182	28.52	10.39	54.39	-25.87	AV	N	Pass
3	0.200	45.44	10.38	63.61	-18.17	Peak	N	Pass
3**	0.200	27.82	10.38	53.61	-25.79	AV	N	Pass
4	0.514	40.01	10.30	56.00	-15.99	Peak	N	Pass
4**	0.514	27.20	10.30	46.00	-18.80	AV	N	Pass
5	1.798	37.10	10.25	56.00	-18.90	Peak	N	Pass
5**	1.798	24.44	10.25	46.00	-21.56	AV	N	Pass
6	4.714	37.63	10.29	56.00	-18.37	Peak	N	Pass
6**	4.714	24.33	10.29	46.00	-21.67	AV	N	Pass

## A.6 Radiated Spurious Emission

Note<sup>1</sup>: The symbol of "--" in the table which means not application.

Note<sup>2</sup>: For the test data above 1 GHz, according the ANSI C63.4-2014, where limits are specified for both average and peak (or quasi-peak) detector functions, if the peak (or quasi-peak) measured value complies with the average limit, it is unnecessary to perform an average measurement.

Note<sup>3</sup>: The low frequency, which started from 9 kHz to 30 MHz, was pre-scanned and the result which was 20 dB lower than the limit line per 15.31(o) was not reported.

Note<sup>4</sup>: The marked spikes near 900 MHz with circle should be ignored because they are Fundamental signal.

### Test Data and Plots

#### LOW CHANNEL, 850 MHz to 950 MHz, ANT H

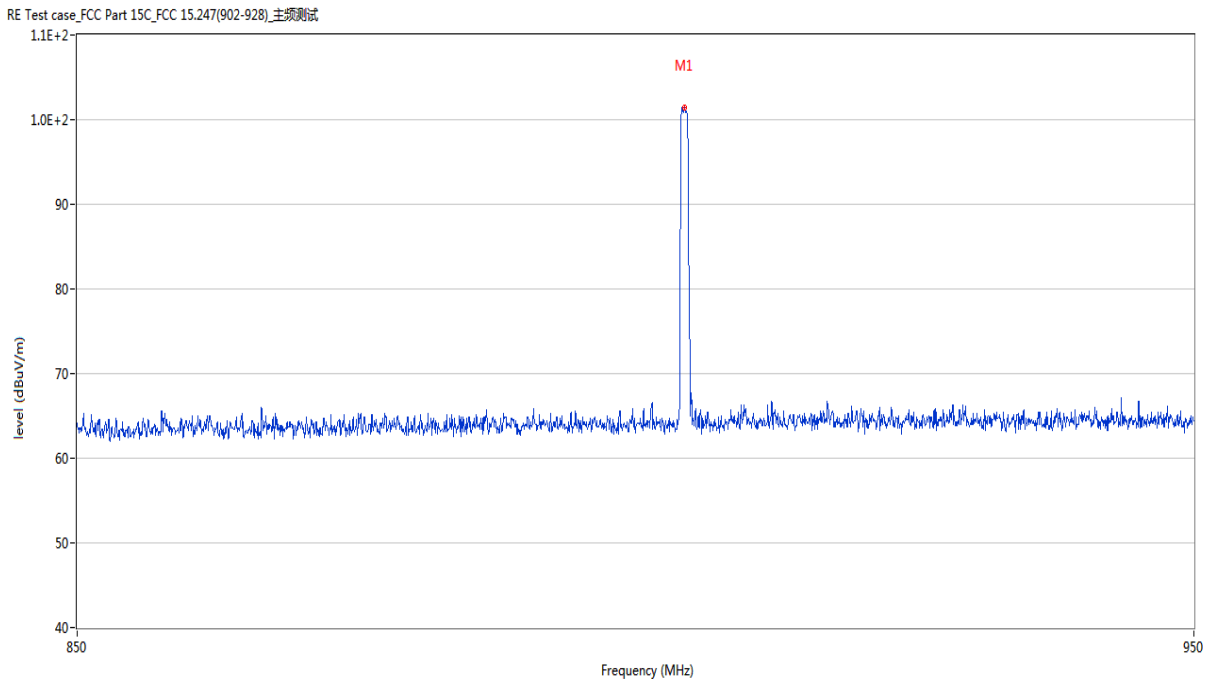

No.	Frequency (MHz)	Results (dBuV/m)	Factor (dB)	Limit (dBuV/m)	Over Limit (dB)	Detector	Table (Degree)	Height (cm)	Antenna	Verdict
1	903.049	101.40	30.03	--	--	Peak	83.00	200	Horizontal	N/A

LOW CHANNEL, 850 MHz to 950 MHz, ANT V

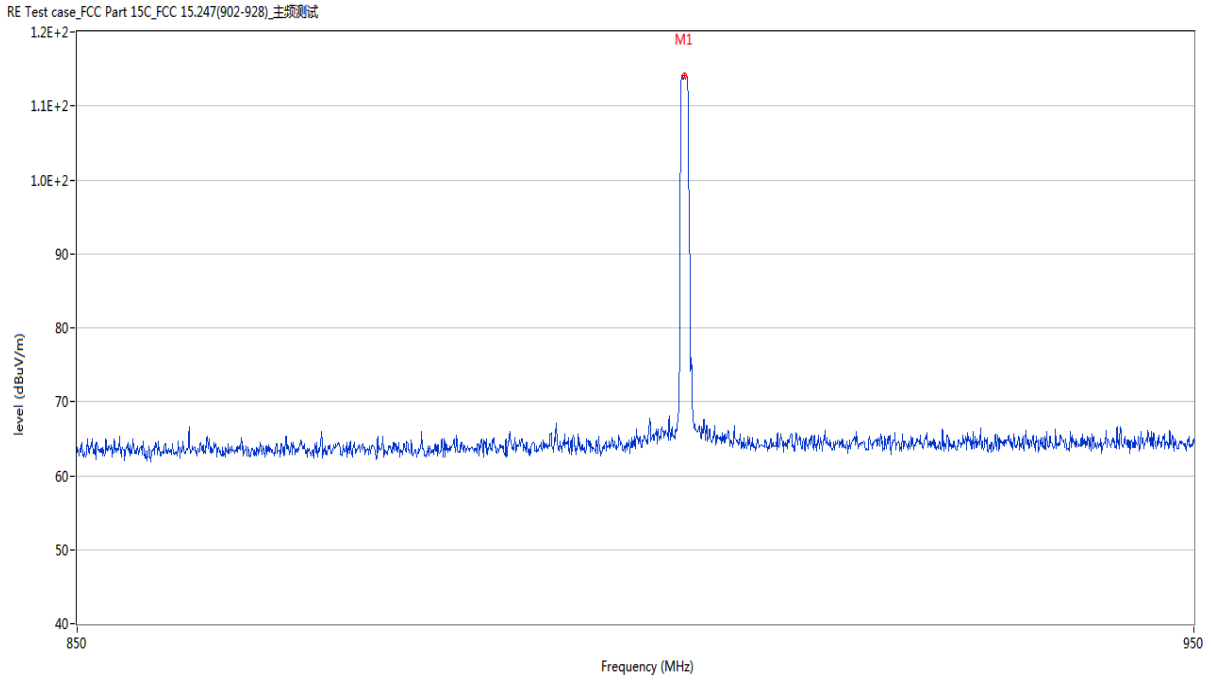

No.	Frequency (MHz)	Results (dBuV/m)	Factor (dB)	Limit (dBuV/m)	Over Limit (dB)	Detector	Table (Degree)	Height (cm)	Antenna	Verdict
1	903.000	114.05	30.03	--	--	Peak	119.00	200	Vertical	Pass

MIDDLE CHANNEL, 850 MHz to 950 MHz, ANT H

RE Test case\_FCC Part 15C\_FCC 15.247(902-928)\_主频测试

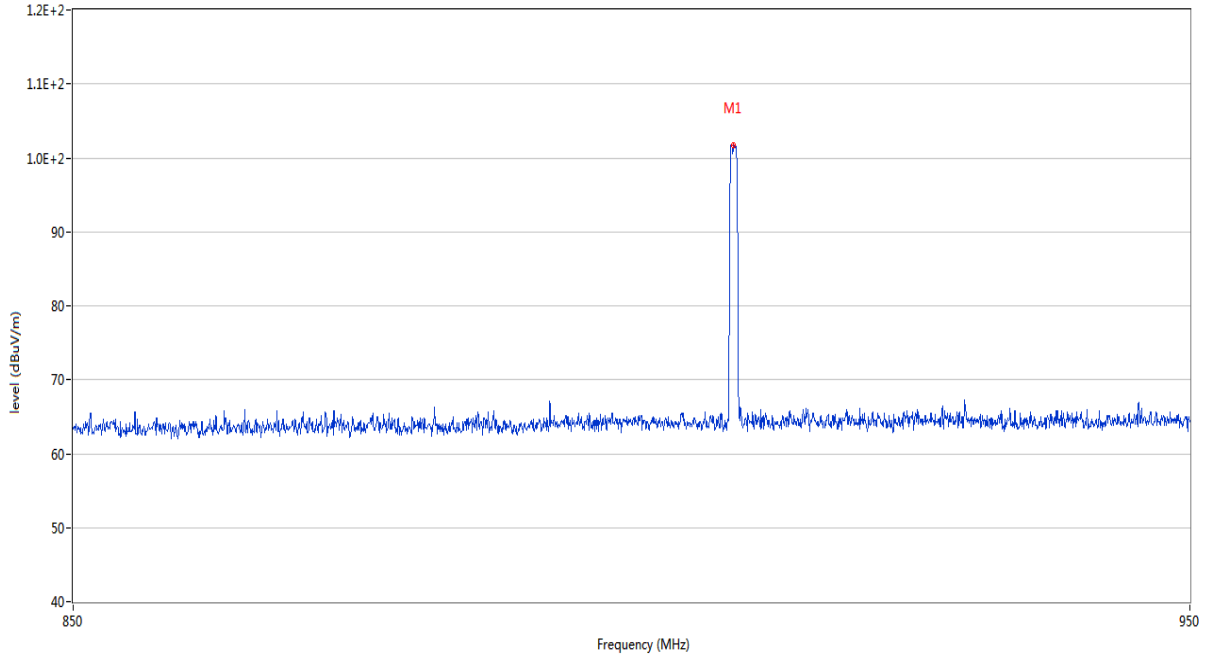

No.	Frequency (MHz)	Results (dBuV/m)	Factor (dB)	Limit (dBuV/m)	Over Limit (dB)	Detector	Table (Degree)	Height (cm)	Antenna	Verdict
1	907.802	101.77	30.23	--	--	Peak	78.00	200	Horizontal	N/A

MIDDLE CHANNEL, 850 MHz to 950 MHz, ANT V

RE Test case\_FCC Part 15C\_FCC 15.247(902-928)\_主频测试

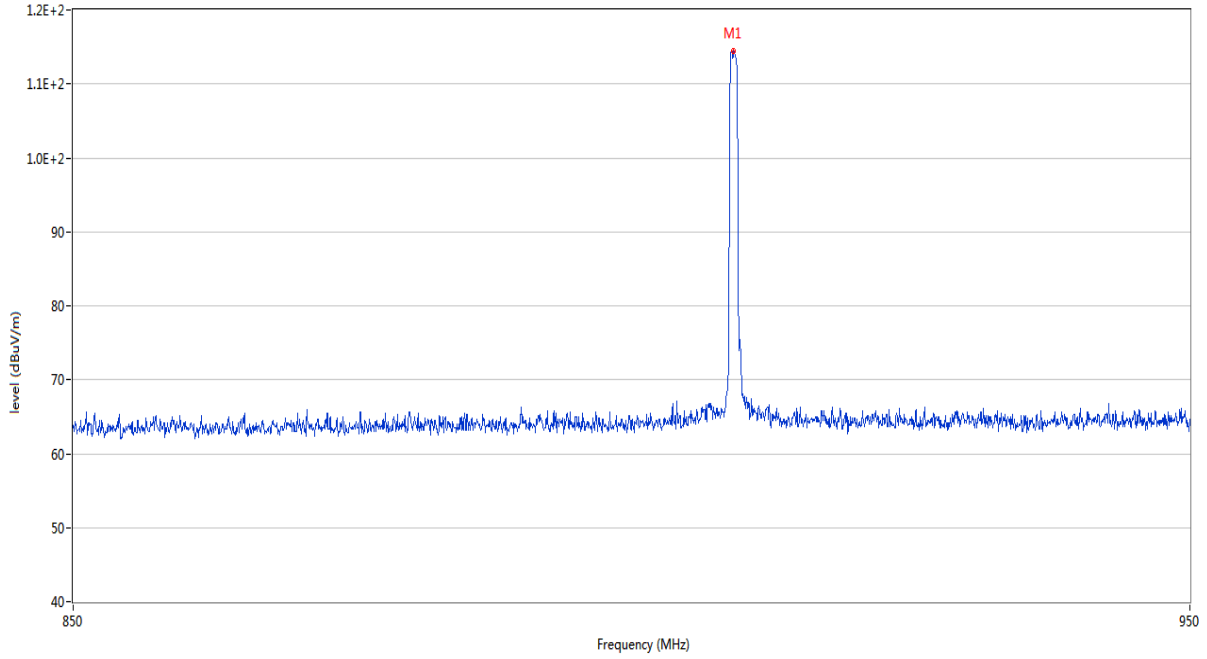

No.	Frequency (MHz)	Results (dBuV/m)	Factor (dB)	Limit (dBuV/m)	Over Limit (dB)	Detector	Table (Degree)	Height (cm)	Antenna	Verdict
1	907.802	114.41	30.23	--	--	Peak	118.00	200	Vertical	Pass



HIGH CHANNEL, 850 MHz to 950 MHz, ANT H

RE Test case\_FCC Part 15C\_FCC 15.247(902-928)\_主频测试

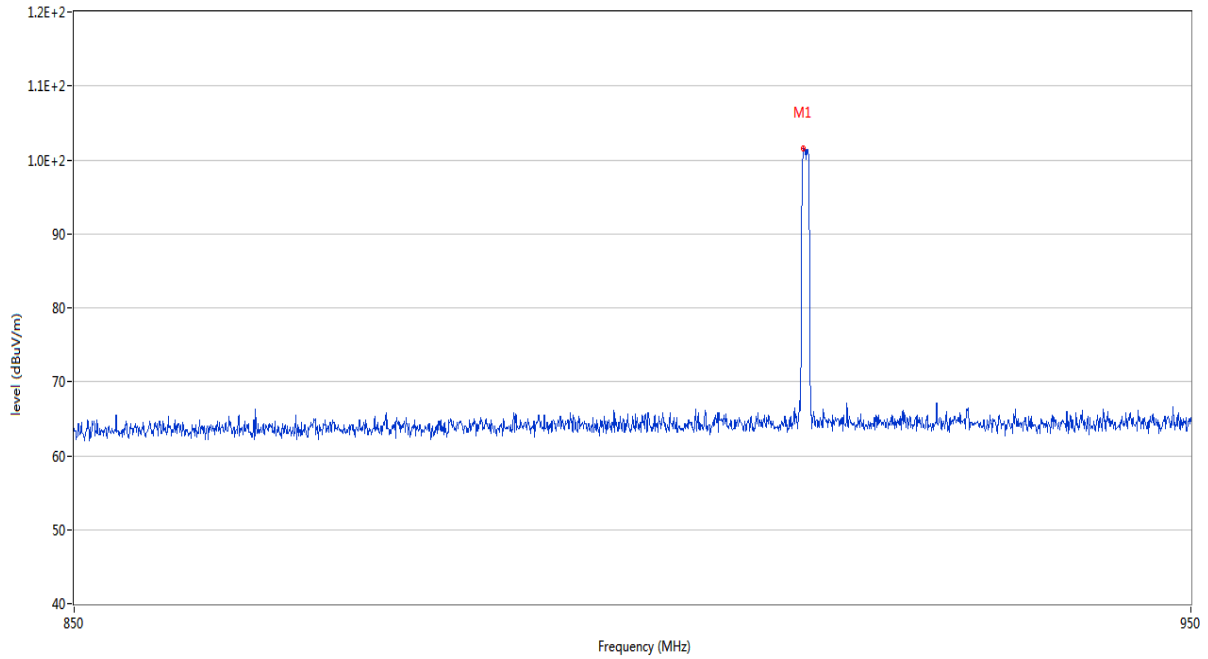

No.	Frequency (MHz)	Results (dBuV/m)	Factor (dB)	Limit (dBuV/m)	Over Limit (dB)	Detector	Table (Degree)	Height (cm)	Antenna	Verdict
1	914.058	101.49	30.38	--	--	Peak	75.00	200	Horizontal	N/A

HIGH CHANNEL, 850 MHz to 950 MHz, ANT V

RE Test case\_FCC Part 15C\_FCC 15.247(902-928)\_主频测试

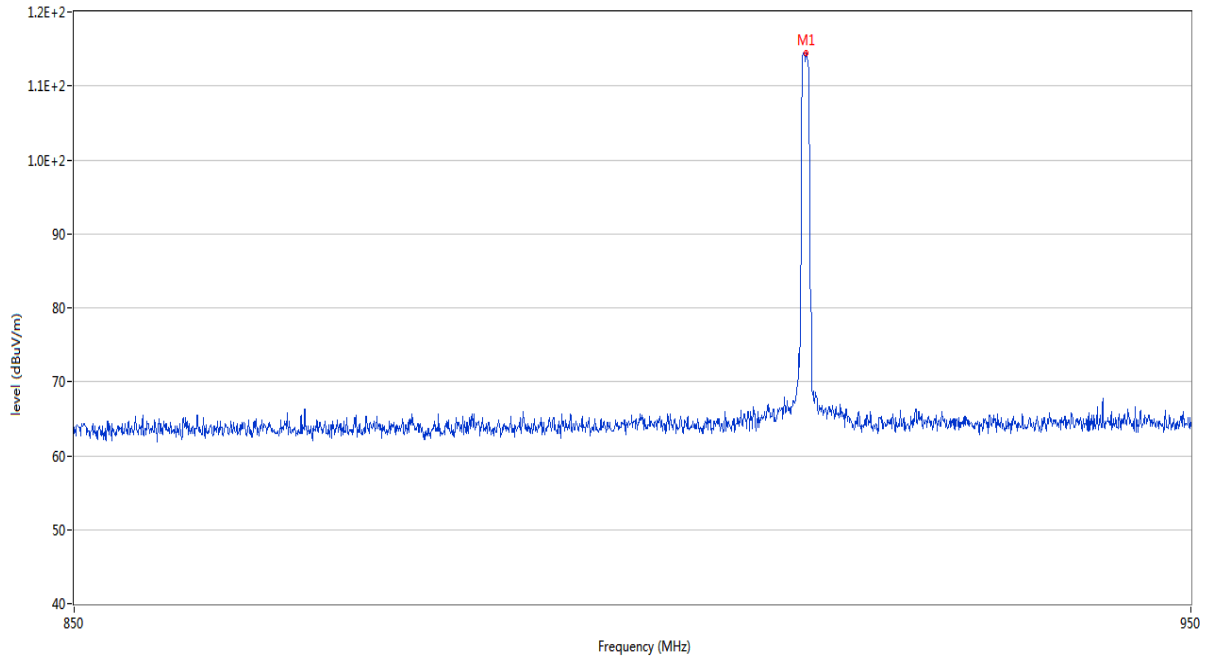

No.	Frequency (MHz)	Results (dBuV/m)	Factor (dB)	Limit (dBuV/m)	Over Limit (dB)	Detector	Table (Degree)	Height (cm)	Antenna	Verdict
1	914.300	114.52	30.38	--	--	Peak	117.00	200	Vertical	Pass

LOW CHANNEL, ANT H

RE Test case\_FCC Part 15C\_FCC 15.247(902-928MHz)\_30MHz-1GHz

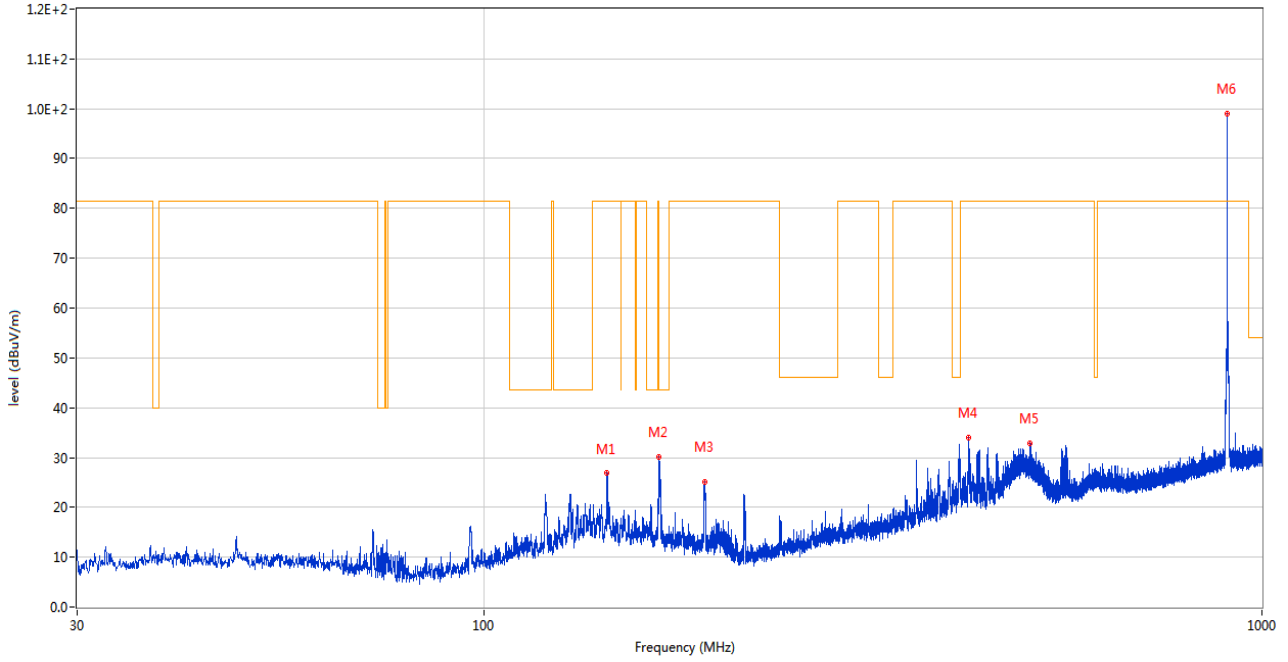

No.	Frequency (MHz)	Results (dBuV/m)	Factor (dB)	Limit (dBuV/m)	Over Limit (dB)	Detector	Table (Degree)	Height (cm)	Antenna	Verdict
1	143.975	26.81	-24.35	81.4	-54.59	Peak	299.00	200	Horizontal	Pass
2	167.982	30.21	-24.11	43.5	-13.29	Peak	96.00	200	Horizontal	Pass
3	191.990	25.05	-26.85	81.4	-56.35	Peak	110.00	100	Horizontal	Pass
4	420.280	33.96	-18.50	81.4	-47.44	Peak	75.00	100	Horizontal	Pass
5	503.942	32.75	-16.14	81.4	-49.65	Peak	312.00	100	Horizontal	Pass
6	903.242	98.96	-7.58	81.4	17.56	Peak	257.00	100	Horizontal	N/A

LOW CHANNEL, ANT V

RE Test case\_FCC Part 15C\_FCC 15.247(902-928MHz)\_30MHz-1GHz

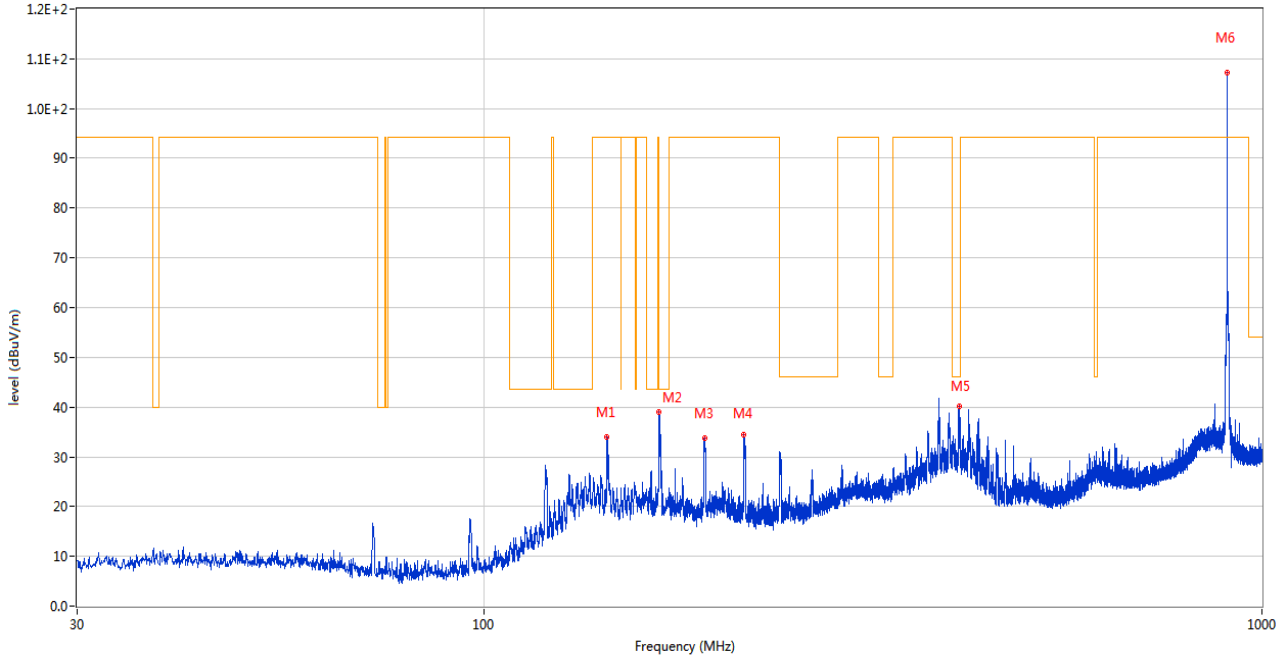

No.	Frequency (MHz)	Results (dBuV/m)	Factor (dB)	Limit (dBuV/m)	Over Limit (dB)	Detector	Table (Degree)	Height (cm)	Antenna	Verdict
1	143.975	34.00	-24.35	94.1	-60.10	Peak	179.00	100	Vertical	Pass
2	167.982	38.93	-24.11	43.5	-4.57	Peak	296.00	200	Vertical	Pass
3	192.038	33.87	-26.86	94.1	-60.23	Peak	323.00	100	Vertical	Pass
4	215.949	34.34	-26.22	94.1	-59.76	Peak	330.00	100	Vertical	Pass
5	407.961	40.14	-18.99	46.0	-5.86	Peak	351.00	200	Vertical	Pass
6	903.242	107.23	-7.58	94.1	13.03	Peak	330.00	100	Vertical	N/A

MIDDLE CHANNEL, ANT H

RE Test case\_FCC Part 15C\_FCC 15.247(902-928MHz)\_30MHz-1GHz

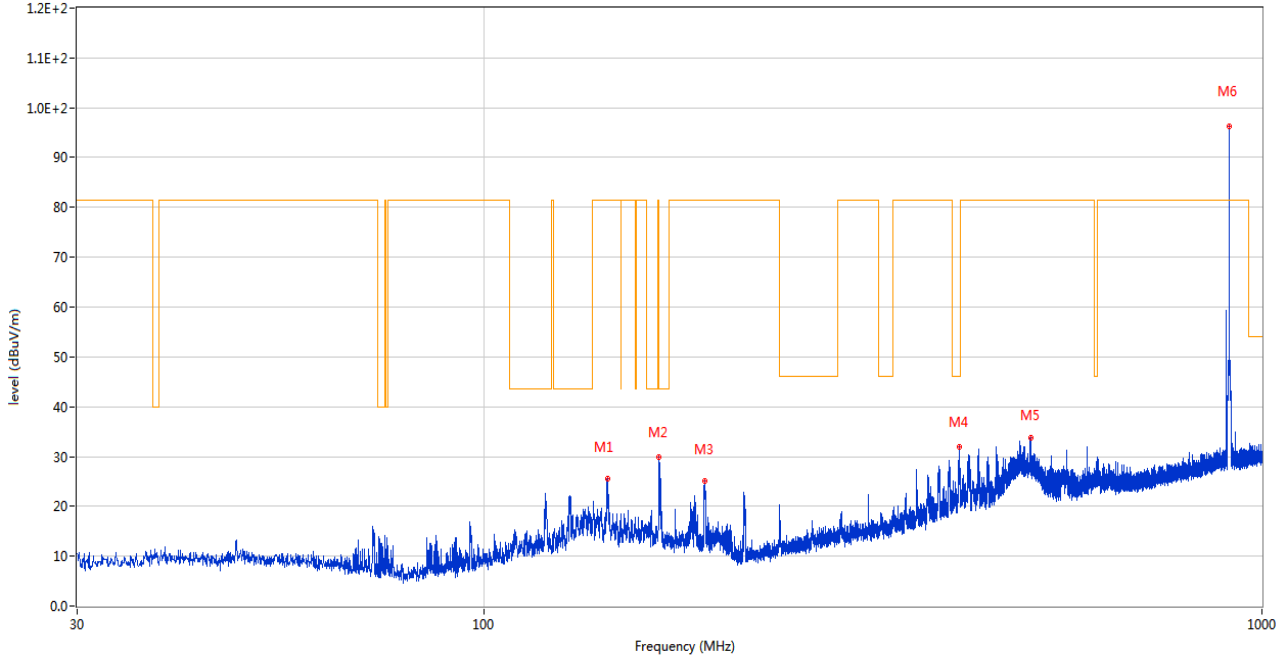

No.	Frequency (MHz)	Results (dBuV/m)	Factor (dB)	Limit (dBuV/m)	Over Limit (dB)	Detector	Table (Degree)	Height (cm)	Antenna	Verdict
1	144.024	25.51	-24.34	81.8	-56.29	Peak	246.00	100	Horizontal	Pass
2	167.982	29.99	-24.11	43.5	-13.51	Peak	46.00	200	Horizontal	Pass
3	191.990	25.03	-26.85	81.8	-56.77	Peak	115.00	100	Horizontal	Pass
4	407.961	31.95	-18.99	46.0	-14.05	Peak	211.00	100	Horizontal	Pass
5	503.990	33.86	-16.14	81.8	-47.94	Peak	335.00	200	Horizontal	Pass
6	908.044	96.37	-7.63	81.8	14.57	Peak	253.00	100	Horizontal	N/A

MIDDLE CHANNEL, ANT V

RE Test case\_FCC Part 15C\_FCC 15.247(902-928MHz)\_30MHz-1GHz

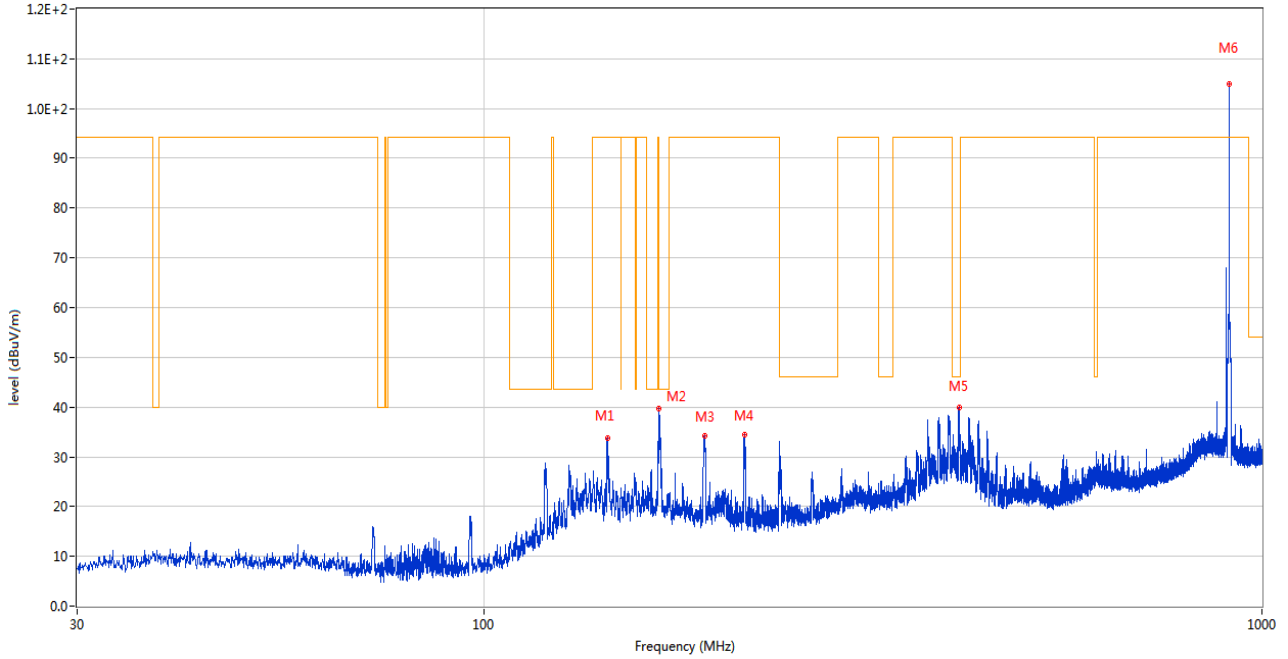

No.	Frequency (MHz)	Results (dBuV/m)	Factor (dB)	Limit (dBuV/m)	Over Limit (dB)	Detector	Table (Degree)	Height (cm)	Antenna	Verdict
1	144.024	33.78	-24.34	94.4	-60.62	Peak	170.00	100	Vertical	Pass
2	167.982	39.71	-24.11	43.5	-3.79	Peak	324.00	200	Vertical	Pass
3	191.990	34.24	-26.85	94.4	-60.16	Peak	332.00	100	Vertical	Pass
4	216.240	34.53	-26.21	94.4	-59.87	Peak	339.00	200	Vertical	Pass
5	408.058	40.01	-19.01	46.0	-5.99	Peak	346.00	100	Vertical	Pass
6	908.044	104.85	-7.63	94.4	10.45	Peak	339.00	100	Vertical	N/A

HIGH CHANNEL, ANT H

RE Test case\_FCC Part 15C\_FCC 15.247(902-928MHz)\_30MHz-1GHz

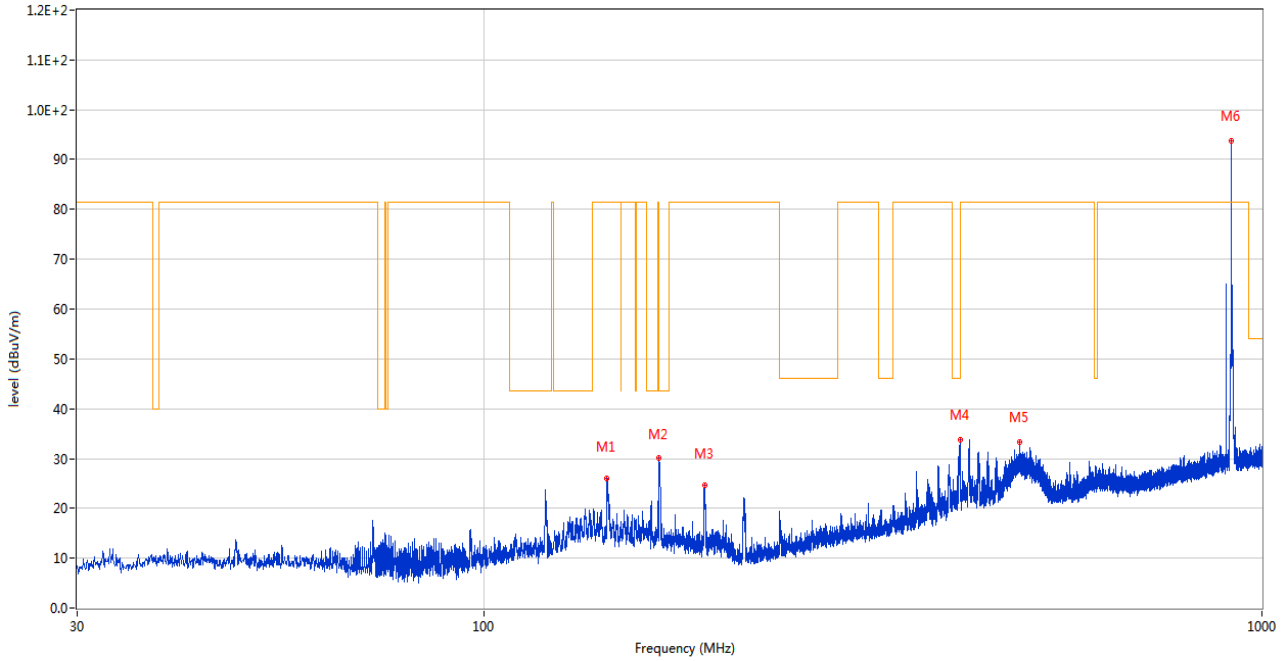

No.	Frequency (MHz)	Results (dBuV/m)	Factor (dB)	Limit (dBuV/m)	Over Limit (dB)	Detector	Table (Degree)	Height (cm)	Antenna	Verdict
1	143.975	25.93	-24.35	81.5	-55.57	Peak	280.00	100	Horizontal	Pass
2	167.982	30.08	-24.11	43.5	-13.42	Peak	110.00	100	Horizontal	Pass
3	191.990	24.74	-26.85	81.5	-56.76	Peak	89.00	200	Horizontal	Pass
4	409.173	33.81	-18.90	46.0	-12.19	Peak	193.00	100	Horizontal	Pass
5	487.743	33.36	-16.60	81.5	-48.14	Peak	316.00	200	Horizontal	Pass
6	914.398	93.75	-7.16	81.5	12.25	Peak	258.00	100	Horizontal	N/A

HIGH CHANNEL, ANT V

RE Test case\_FCC Part 15C\_FCC 15.247(902-928MHz)\_30MHz-1GHz

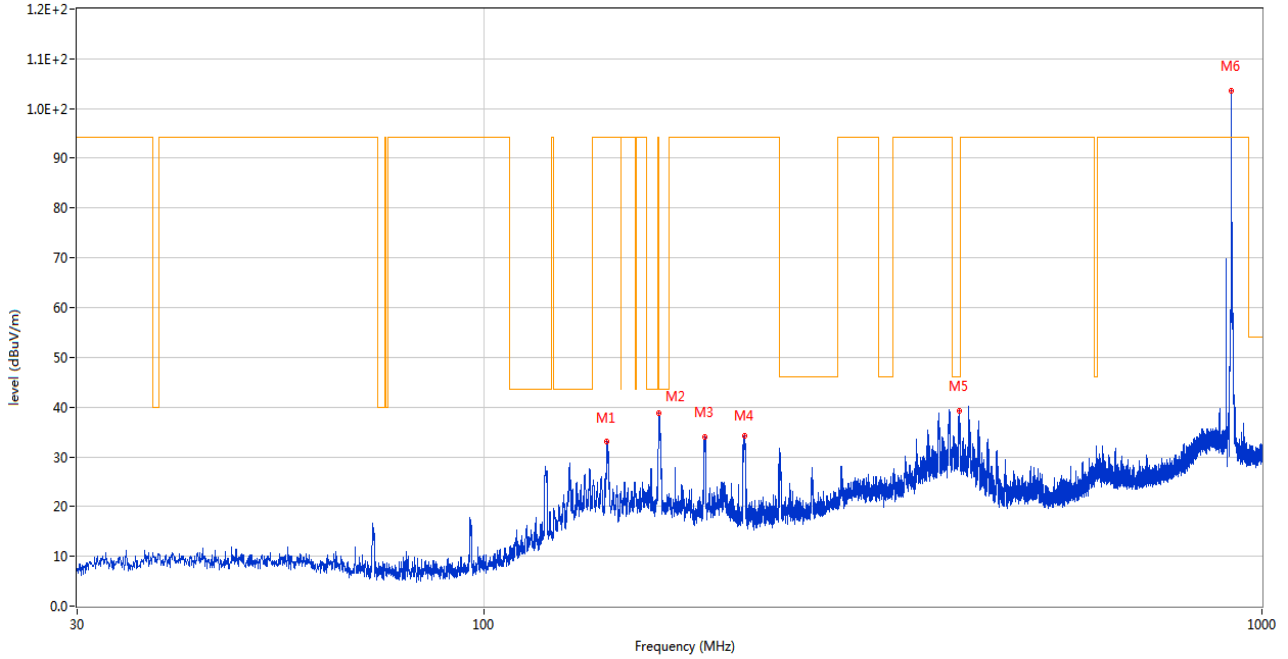

No.	Frequency (MHz)	Results (dBuV/m)	Factor (dB)	Limit (dBuV/m)	Over Limit (dB)	Detector	Table (Degree)	Height (cm)	Antenna	Verdict
1	143.975	33.06	-24.35	94.5	-61.44	Peak	191.00	200	Vertical	Pass
2	168.031	38.68	-24.12	43.5	-4.82	Peak	296.00	100	Vertical	Pass
3	192.038	33.90	-26.86	94.5	-60.6	Peak	337.00	100	Vertical	Pass
4	216.337	34.23	-26.20	94.5	-60.27	Peak	330.00	200	Vertical	Pass
5	408.058	39.28	-19.01	46.0	-6.72	Peak	359.00	100	Vertical	Pass
6	914.446	103.53	-7.16	94.5	9.03	Peak	302.00	100	Vertical	N/A



LOW CHANNEL 1 GHz to 10 GHz, ANT H

RE Test case\_FCC Part 15C\_FCC 15.247(902-928)\_1GHz-10GHz

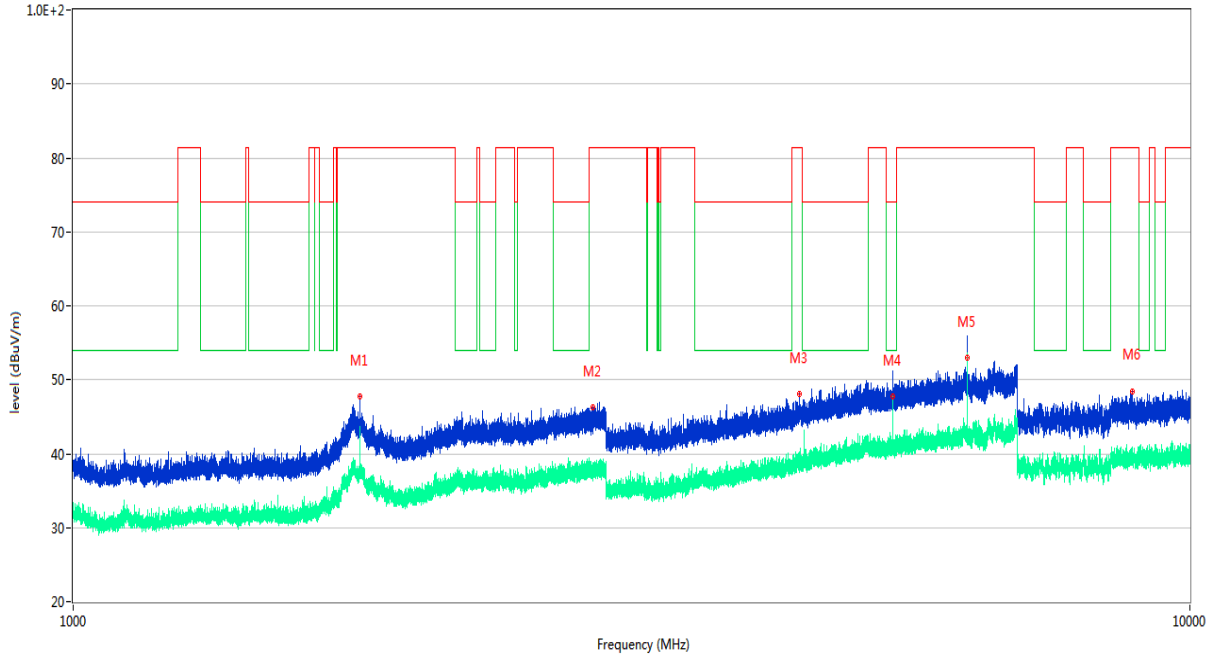

No.	Frequency (MHz)	Results (dBuV/m)	Factor (dB)	Limit (dBuV/m)	Over Limit (dB)	Detector	Table (Degree)	Height (cm)	Antenna	Verdict
1	1805.700	47.73	-8.70	81.4	-33.67	Peak	52.00	150	Horizontal	Pass
1**	1805.700	43.07	-8.70	81.4	-38.33	AV	52.00	150	Horizontal	Pass
2	2919.800	46.22	-5.82	81.4	-35.18	Peak	360.00	150	Horizontal	Pass
2**	2919.800	38.67	-5.82	81.4	-42.73	AV	360.00	150	Horizontal	Pass
3	4468.400	48.00	-3.61	81.4	-33.40	Peak	234.00	150	Horizontal	Pass
3**	4468.400	38.35	-3.61	81.4	-43.05	AV	234.00	150	Horizontal	Pass
4	5419.400	49.42	-2.73	74.0	-24.58	Peak	221.00	150	Horizontal	Pass
4**	5419.400	47.68	-2.73	54.0	-6.32	AV	221.00	150	Horizontal	Pass
5	6322.000	55.87	-1.47	81.4	-25.53	Peak	234.00	150	Horizontal	Pass
5**	6322.000	53.00	-1.47	81.4	-28.40	AV	234.00	150	Horizontal	Pass
6	8873.349	48.39	-0.83	81.4	-33.01	Peak	15.00	150	Horizontal	Pass
6**	8873.349	40.05	-0.83	81.4	-41.35	AV	15.00	150	Horizontal	Pass

LOW CHANNEL 1 GHz to 10 GHz, ANT H

RE Test case\_FCC Part 15C\_FCC 15.247(902-928)\_1GHz-10GHz

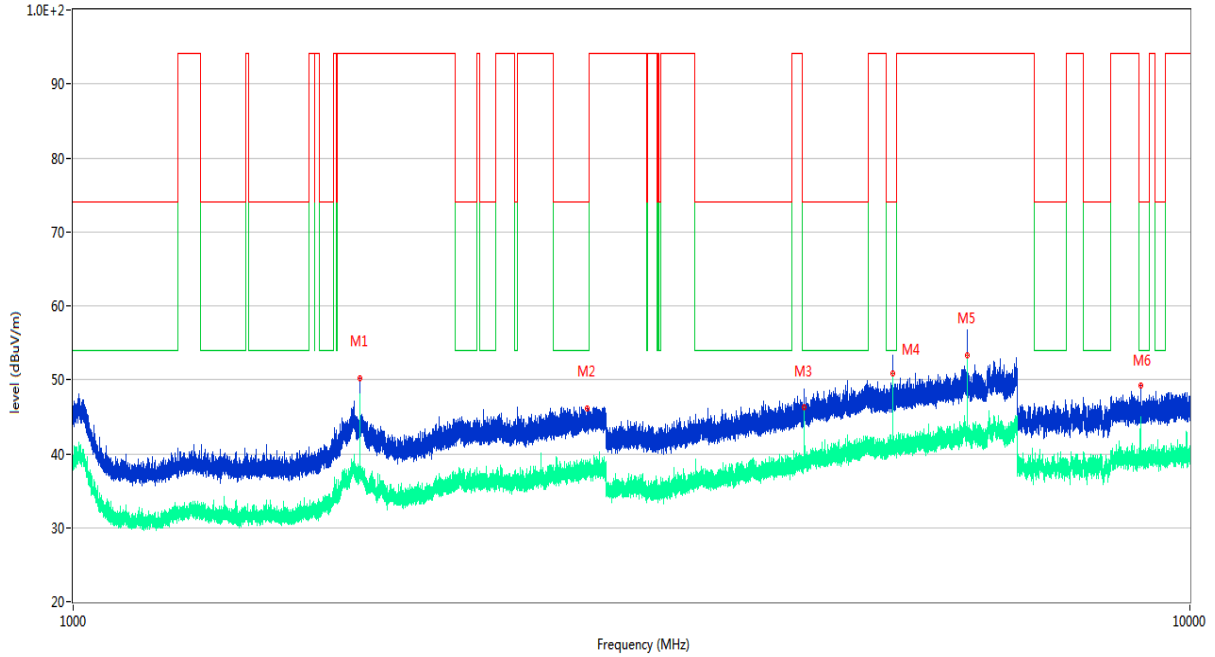

No.	Frequency (MHz)	Results (dBuV/m)	Factor (dB)	Limit (dBuV/m)	Over Limit (dB)	Detector	Table (Degree)	Height (cm)	Antenna	Verdict
1	1806.400	50.19	-8.68	94.1	-43.91	Peak	123.00	150	Vertical	Pass
1**	1806.400	47.44	-8.68	94.1	-46.66	AV	123.00	150	Vertical	Pass
2	2886.500	46.20	-5.91	74.0	-27.80	Peak	360.00	150	Vertical	Pass
2**	2886.500	37.56	-5.91	54.0	-16.44	AV	360.00	150	Vertical	Pass
3	4514.600	47.97	-3.78	74.0	-26.03	Peak	248.00	150	Vertical	Pass
3**	4514.600	46.26	-3.78	54.0	-7.74	AV	248.00	150	Vertical	Pass
4	5418.400	53.30	-2.76	74.0	-20.70	Peak	92.00	150	Vertical	Pass
4**	5418.400	50.86	-2.76	54.0	-3.14	AV	92.00	150	Vertical	Pass
5	6321.200	54.95	-1.46	94.1	-39.15	Peak	29.00	150	Vertical	Pass
5**	6321.200	53.33	-1.46	94.1	-40.77	AV	29.00	150	Vertical	Pass
6	9030.325	49.30	-0.79	74.0	-24.70	Peak	92.00	150	Vertical	Pass
6**	9030.325	43.81	-0.79	54.0	-10.19	AV	92.00	150	Vertical	Pass

MIDDLE CHANNEL 1 GHz to 10 GHz, ANT H

RE Test case\_FCC Part 15C\_FCC 15.247(902-928)\_1GHz-10GHz

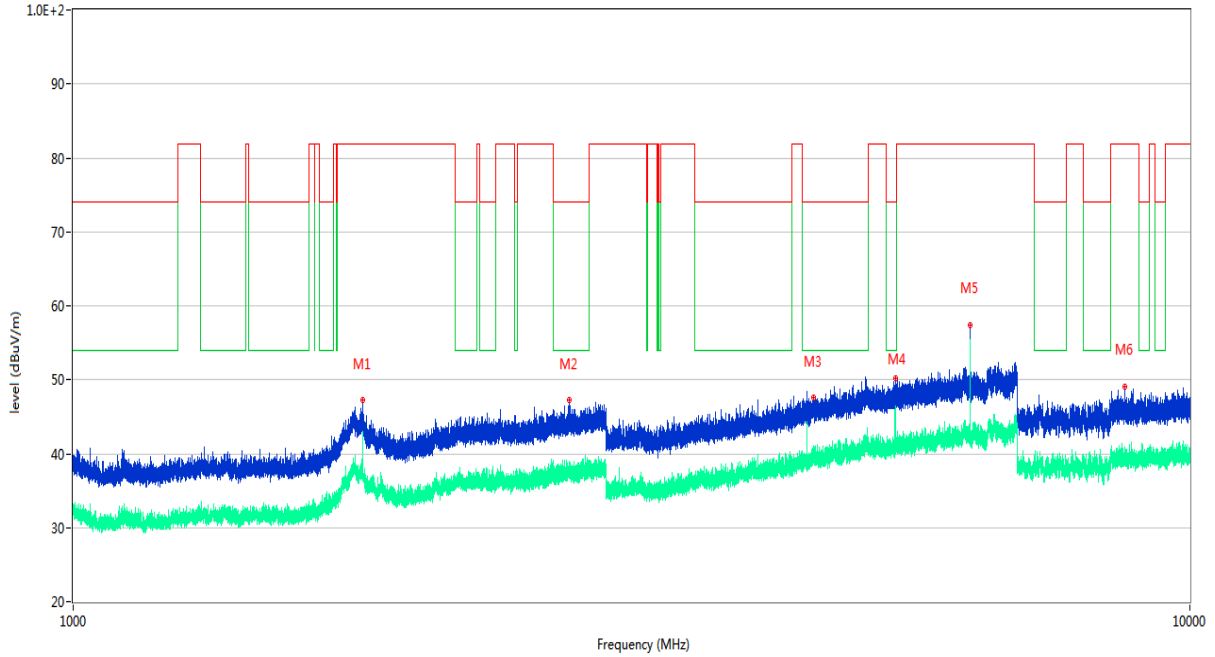

No.	Frequency (MHz)	Results (dBuV/m)	Factor (dB)	Limit (dBuV/m)	Over Limit (dB)	Detector	Table (Degree)	Height (cm)	Antenna	Verdict
1	1815.900	47.23	-8.71	81.8	-34.57	Peak	222.00	150	Horizontal	Pass
1**	1815.900	41.33	-8.71	81.8	-40.47	AV	222.00	150	Horizontal	Pass
2	2783.300	47.21	-6.61	74.0	-26.79	Peak	360.00	150	Horizontal	Pass
2**	2783.300	37.54	-6.61	54.0	-16.46	AV	360.00	150	Horizontal	Pass
3	4604.400	47.53	-4.08	74.0	-26.47	Peak	320.00	150	Horizontal	Pass
3**	4604.400	39.13	-4.08	54.0	-14.87	AV	320.00	150	Horizontal	Pass
4	5446.400	50.27	-2.45	74.0	-23.73	Peak	187.00	150	Horizontal	Pass
4**	5446.400	45.56	-2.45	54.0	-8.44	AV	187.00	150	Horizontal	Pass
5	6356.000	57.31	-2.01	81.8	-24.49	Peak	231.00	150	Horizontal	Pass
5**	6356.000	53.99	-2.01	81.8	-27.81	AV	231.00	150	Horizontal	Pass
6	8752.312	49.06	-1.52	81.8	-32.74	Peak	58.00	150	Horizontal	Pass
6**	8752.312	39.66	-1.52	81.8	-42.14	AV	58.00	150	Horizontal	Pass

## MIDDLE CHANNEL 1 GHz to 10 GHz, ANT V

RE Test case\_FCC Part 15C\_FCC 15.247(902-928)\_1GHz-10GHz

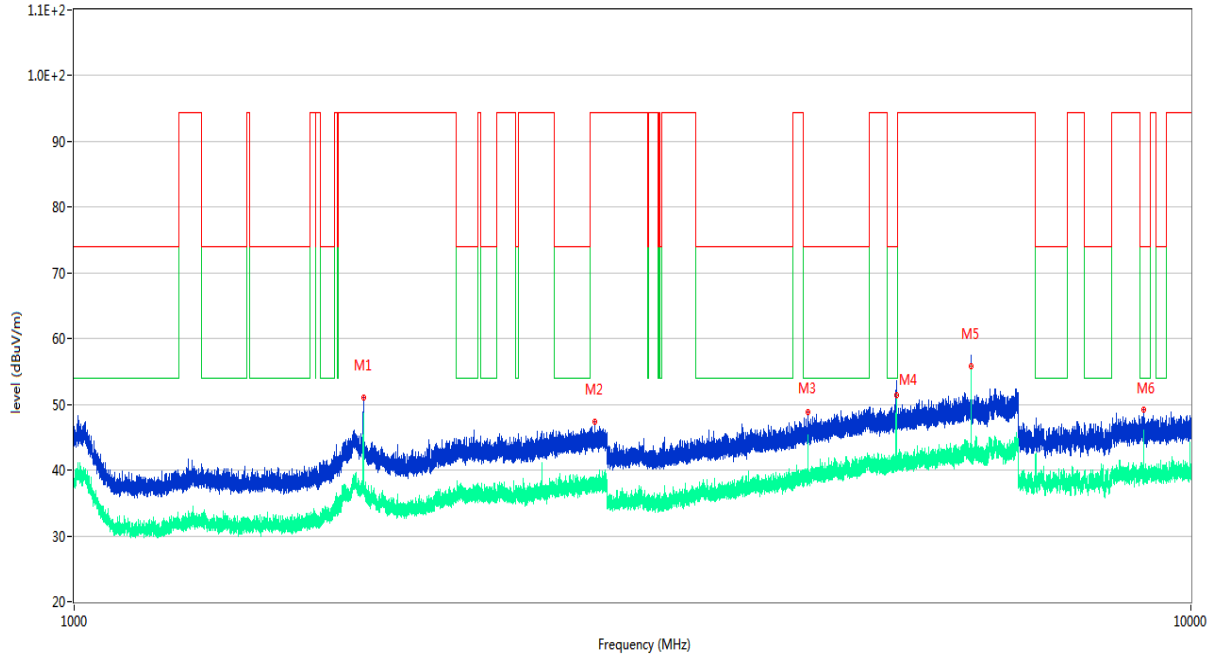

No.	Frequency (MHz)	Results (dBuV/m)	Factor (dB)	Limit (dBuV/m)	Over Limit (dB)	Detector	Table (Degree)	Height (cm)	Antenna	Verdict
1	1816.200	50.95	-8.72	94.4	-43.45	Peak	112.00	150	Vertical	Pass
1**	1816.200	48.34	-8.72	94.4	-46.06	AV	112.00	150	Vertical	Pass
2	2923.200	47.30	-5.80	94.4	-47.10	Peak	112.00	150	Vertical	Pass
2**	2923.200	37.56	-5.80	94.4	-56.84	AV	112.00	150	Vertical	Pass
3	4540.000	48.83	-4.33	74.0	-25.17	Peak	0.00	150	Vertical	Pass
3**	4540.000	45.39	-4.33	54.0	-8.61	AV	0.00	150	Vertical	Pass
4	5448.400	52.95	-2.35	74.0	-21.05	Peak	109.00	150	Vertical	Pass
4**	5448.400	50.88	-2.35	54.0	3.12	AV	109.00	150	Vertical	Pass
5	6356.000	56.12	-2.01	94.4	-38.28	Peak	44.00	150	Vertical	Pass
5**	6356.000	55.86	-2.01	94.4	-38.54	AV	44.00	150	Vertical	Pass
6	9076.612	49.17	-1.42	74.0	-24.83	Peak	105.00	150	Vertical	Pass
6**	9076.612	44.58	-1.42	54.0	-9.42	AV	105.00	150	Vertical	Pass

HIGH CHANNEL 1 GHz to 10 GHz, ANT H

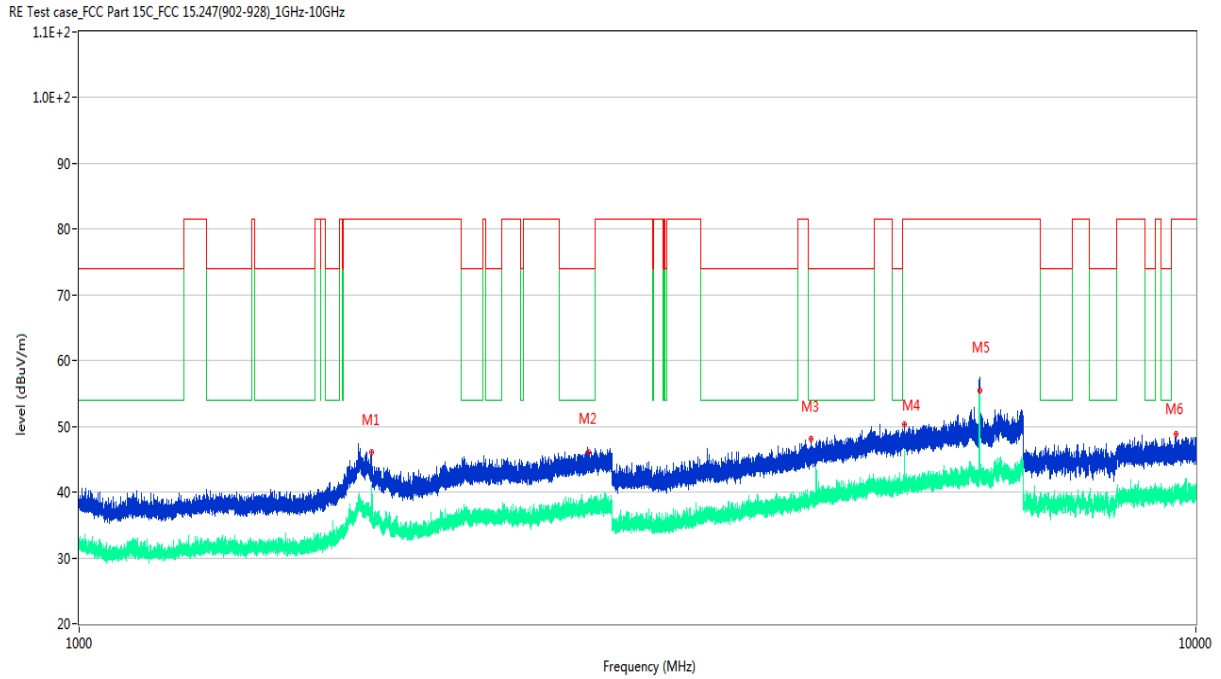

No.	Frequency (MHz)	Results (dBuV/m)	Factor (dB)	Limit (dBuV/m)	Over Limit (dB)	Detector	Table (Degree)	Height (cm)	Antenna	Verdict
1	1828.700	46.07	-9.99	81.5	-35.43	Peak	98.00	150	Horizontal	Pass
1**	1828.700	41.07	-9.99	81.5	-40.43	AV	98.00	150	Horizontal	Pass
2	2859.100	46.14	-6.52	74.0	-27.86	Peak	154.00	150	Horizontal	Pass
2**	2859.100	37.21	-6.52	54.0	-16.79	AV	154.00	150	Horizontal	Pass
3	4519.600	48.04	-3.73	74.0	-25.96	Peak	360.00	150	Horizontal	Pass
3**	4519.600	38.94	-3.73	54.0	-15.06	AV	360.00	150	Horizontal	Pass
4	5484.000	50.35	-2.45	81.5	-31.15	Peak	28.00	150	Horizontal	Pass
4**	5484.000	44.18	-2.45	81.5	-37.32	AV	28.00	150	Horizontal	Pass
5	6399.800	56.17	-1.16	81.5	-25.33	Peak	237.00	150	Horizontal	Pass
5**	6399.800	55.52	-1.16	81.5	-25.98	AV	237.00	150	Horizontal	Pass
6	9590.662	48.85	-0.04	81.5	-32.65	Peak	50.00	150	Horizontal	Pass
6**	9590.662	39.83	-0.04	81.5	-41.67	AV	50.00	150	Horizontal	Pass

HIGH CHANNEL 1 GHz to 10 GHz, ANT V

RE Test case\_FCC Part 15C\_FCC 15.247(902-928)\_1GHz-10GHz

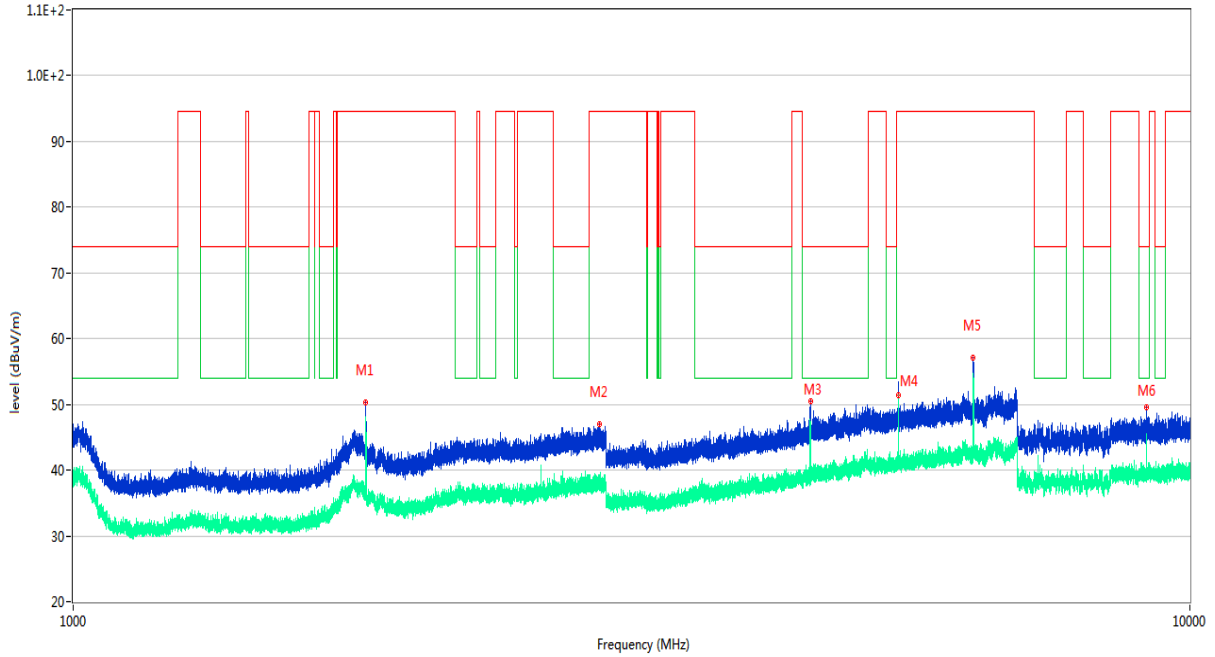

No.	Frequency (MHz)	Results (dBuV/m)	Factor (dB)	Limit (dBuV/m)	Over Limit (dB)	Detector	Table (Degree)	Height (cm)	Antenna	Verdict
1	1828.500	50.25	-9.98	94.5	-44.25	Peak	47.00	150	Vertical	Pass
1**	1828.500	46.95	-9.98	94.5	-47.55	AV	47.00	150	Vertical	Pass
2	2957.400	46.94	-5.70	94.5	-47.56	Peak	162.00	150	Vertical	Pass
2**	2957.400	37.87	-5.70	94.5	-56.63	AV	162.00	150	Vertical	Pass
3	4572.200	50.52	-3.94	74.0	-23.48	Peak	71.00	150	Vertical	Pass
3**	4572.200	47.28	-3.94	54.0	-6.72	AV	71.00	150	Vertical	Pass
4	5485.800	53.05	-2.46	94.5	-41.45	Peak	86.00	150	Vertical	Pass
4**	5485.800	51.33	-2.46	94.5	-43.17	AV	86.00	150	Vertical	Pass
5	6398.200	57.07	-1.23	94.5	-37.43	Peak	25.00	150	Vertical	Pass
5**	6398.200	53.69	-1.23	94.5	-40.81	AV	25.00	150	Vertical	Pass
6	9139.863	49.53	-1.47	74.0	-24.47	Peak	130.00	150	Vertical	Pass
6**	9139.863	44.84	-1.47	54.0	-9.16	AV	130.00	150	Vertical	Pass

## A.7 Band Edge (Restricted-band band-edge)

Note<sup>1</sup>: The lowest and highest channels are tested to verify the band edge emissions. Please refer to the following the plots for emissions values.

Note<sup>2</sup>: The test data all are tested in the vertical and horizontal antenna which the trace is max hold. So these plots have shown the worst case.

Note<sup>3</sup>: According the ANSI C63.10-2013, where limits are specified for both average and peak (or quasi-peak) detector functions, if the peak (or quasi-peak) measured value complies with the average limit, it is unnecessary to perform an average measurement.

Note<sup>4</sup>: The Level (dBuV/m) has been corrected by factor.

Test Mode	Test Channel	Frequency (MHz)	Level (dBuV/m)	Factor (dB)	Limit Line (dBuV/m)	Margin (dB)	Remark	Verdict
LoRa	Low	614	43.394	3.16	74	30.606	PEAK	Pass
		614	N/A	N/A	54	N/A	AVERAGE	Pass
LoRa	High	960	48.625	28.00	74	25.375	PEAK	Pass
		960	N/A	N/A	54	N/A	AVERAGE	Pass

LOW CHANNEL, PEAK

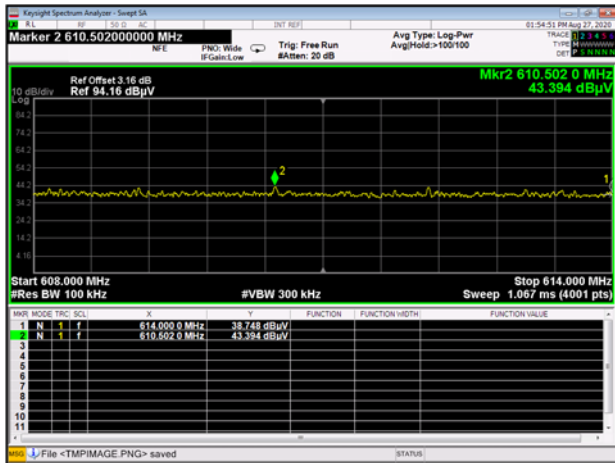

HIGH CHANNEL, PEAK

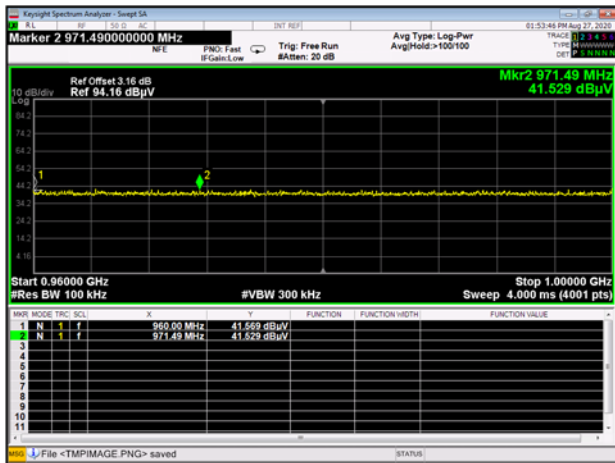

HIGH CHANNEL, AV

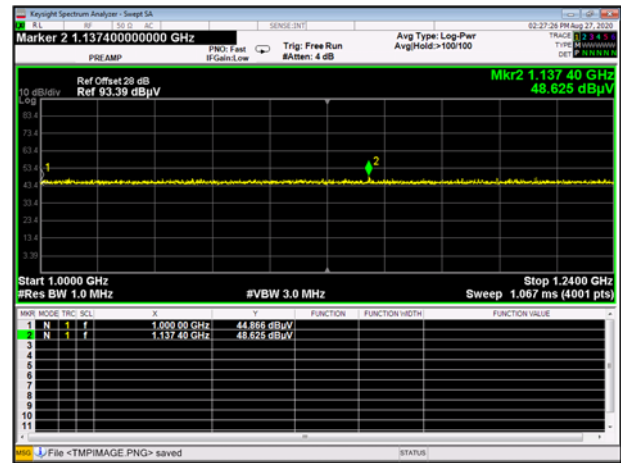



## A.8 Power Spectral Density (PSD)

### Test Data

Channel	Spectral power density (dBm/3kHz)	Limit (dBm/3kHz)	Verdict
Low Channel	-5.23	8	Pass
Middle Channel	-5.32	8	Pass
High Channel	-5.00	8	Pass

### Test plots

#### LOW CHANNEL

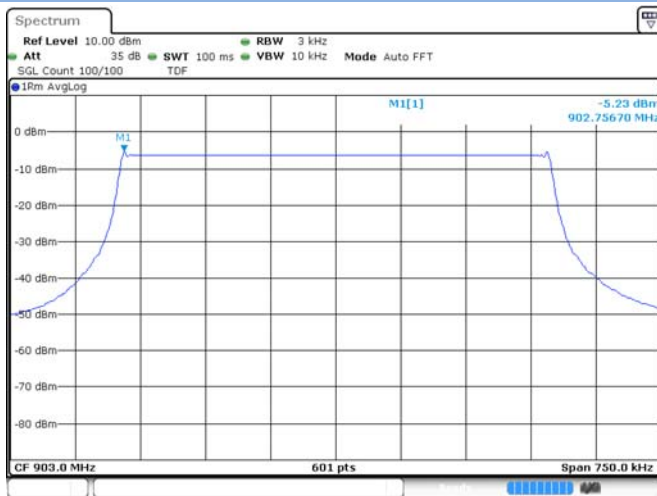

Date: 10.NOV.2020 19:15:27

#### MIDDLE CHANNEL

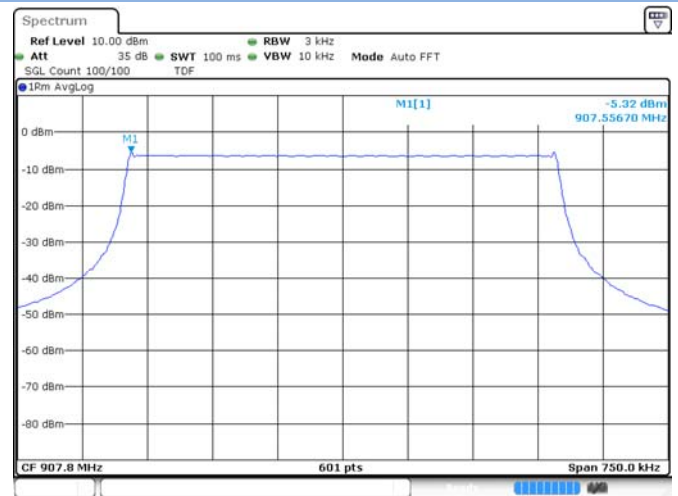

Date: 10.NOV.2020 19:18:47

#### HIGH CHANNEL

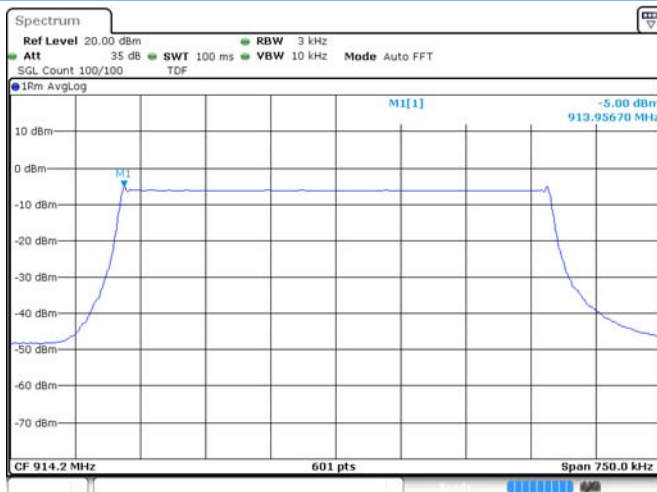

Date: 11.NOV.2020 10:55:16

## **ANNEX B TEST SETUP PHOTOS**

Please refer the document "BL-SZ2080378-AR.PDF".

## **ANNEX C EUT EXTERNAL PHOTOS**

Please refer the document "BL-SZ2080378-AW.PDF".

## **ANNEX D EUT INTERNAL PHOTOS**

Please refer the document "BL-SZ2080378-AI.PDF".

--END OF REPORT--