

FCC Test Report

Report No.: RF150902C17

FCC ID: Z4T-LINKITS7688

Test Model: LinkIt Smart 7688

Received Date: Sep.02, 2015

Test Date: Sep. 23, 2015 ~ Oct. 01, 2015

Issued Date: Oct. 06, 2015

Applicant: Seeed Technology Limited

Address: F2, Building 8, Shiling Industrial Park, Xili Town, Nanshan District,
Shenzhen, Guangdong, PRC

Issued By: Bureau Veritas Consumer Products Services (H.K.) Ltd., Taoyuan Branch

Lab Address: No. 47-2, 14th Ling, Chia Pau Vil., Lin Kou Dist., New Taipei City, Taiwan
(R.O.C)

Test Location (1): No.19, Hwa Ya 2nd Rd., Wen Hwa Vil., Kwei Shan Dist., Taoyuan City
33383, Taiwan, R.O.C.

Test Location (2): No.215, Sec. 3, Beixin Rd., Xindian Dist., New Taipei City 231, Taiwan,
R.O.C



This report is for your exclusive use. Any copying or replication of this report to or for any other person or entity, or use of our name or trademark, is permitted only with our prior written permission. This report sets forth our findings solely with respect to the test samples identified herein. The results set forth in this report are not indicative or representative of the quality or characteristics of the lot from which a test sample was taken or any similar or identical product unless specifically and expressly noted. Our report includes all of the tests requested by you and the results thereof based upon the information that you provided to us. You have 60 days from date of issuance of this report to notify us of any material error or omission caused by our negligence, provided, however, that such notice shall be in writing and shall specifically address the issue you wish to raise. A failure to raise such issue within the prescribed time shall constitute your unqualified acceptance of the completeness of this report, the tests conducted and the correctness of the report contents. Unless specific mention, the uncertainty of measurement has been explicitly taken into account to declare the compliance or non-compliance to the specification.

Table of Contents

Release Control Record	4
1 Certificate of Conformity	5
2 Summary of Test Results	6
2.1 Measurement Uncertainty	6
2.2 Modification Record	6
3 General Information	7
3.1 General Description of EUT	7
3.2 Description of Test Modes	8
3.2.1 Test Mode Applicability and Tested Channel Detail	9
3.3 Duty Cycle of Test Signal	11
3.4 Description of Support Units	12
3.4.1 Configuration of System under Test	12
3.5 General Description of Applied Standards	12
4 Test Types and Results	13
4.1 Radiated Emission and Bandedge Measurement	13
4.1.1 Limits of Radiated Emission and Bandedge Measurement	13
4.1.2 Test Instruments	14
4.1.3 Test Procedures	15
4.1.4 Deviation from Test Standard	15
4.1.5 Test Set Up	16
4.1.6 EUT Operating Conditions	16
4.1.7 Test Results	17
4.2 Conducted Emission Measurement	30
4.2.1 Limits of Conducted Emission Measurement	30
4.2.2 Test Instruments	30
4.2.3 Test Procedures	31
4.2.4 Deviation from Test Standard	31
4.2.5 Test Setup	31
4.2.6 EUT Operating Conditions	31
4.2.7 Test Results	32
4.3 6dB Bandwidth Measurement	34
4.3.1 Limits of 6dB Bandwidth Measurement	34
4.3.2 Test Setup	34
4.3.3 Test Instruments	34
4.3.4 Test Procedure	34
4.3.5 Deviation from Test Standard	34
4.3.6 EUT Operating Conditions	34
4.3.7 Test Result	35
4.4 Conducted Output Power Measurement	37
4.4.1 Limits of Conducted Output Power Measurement	37
4.4.2 Test Setup	37
4.4.3 Test Instruments	37
4.4.4 Test Procedures	37
4.4.5 Deviation from Test Standard	37
4.4.6 EUT Operating Conditions	37
4.4.7 Test Results	38
4.5 Power Spectral Density Measurement	39
4.5.1 Limits of Power Spectral Density Measurement	39
4.5.2 Test Setup	39
4.5.3 Test Instruments	39
4.5.4 Test Procedure	39
4.5.5 Deviation from Test Standard	39
4.5.6 EUT Operating Condition	39



4.5.7 Test Results	40
4.6 Conducted Out of Band Emission Measurement	42
4.6.1 Limits of Conducted Out of Band Emission Measurement.....	42
4.6.2 Test Setup.....	42
4.6.3 Test Instruments	42
4.6.4 Test Procedure	42
4.6.5 Deviation from Test Standard	42
4.6.6 EUT Operating Condition	42
4.6.7 Test Results	43
5 Pictures of Test Arrangements.....	51
Appendix – Information on the Testing Laboratories	52



A D T

Release Control Record

Issue No.	Description	Date Issued
RF150902C17	Original Release	Oct. 06, 2015



1 Certificate of Conformity

Product: 802.11b/g/n IoT Module
Brand: Seeed
Test Model: LinkIt Smart 7688
Sample Status: Identical Prototype
Applicant: Seeed Technology Limited
Test Date: Sep. 23, 2015 ~ Oct. 01, 2015
Standards: 47 CFR FCC Part 15, Subpart C (Section 15.247)
ANSI C63.10:2013

The above equipment has been tested by **Bureau Veritas Consumer Products Services (H.K.) Ltd., Taoyuan Branch**, and found compliance with the requirement of the above standards. The test record, data evaluation & Equipment Under Test (EUT) configurations represented herein are true and accurate accounts of the measurements of the sample's EMC characteristics under the conditions specified in this report.

Prepared by : Rona Chen , **Date:** Oct. 06, 2015
Rona Chen / Specialist

Approved by : Kay Wu , **Date:** Oct. 06, 2015
Kay Wu / Supervisor

2 Summary of Test Results

47 CFR FCC Part 15, Subpart C (SECTION 15.247)			
FCC Clause	Test Item	Result	Remarks
15.207	AC Power Conducted Emission	PASS	Meet the requirement of limit. Minimum passing margin is -9.84 dB at 0.16181 MHz.
15.205 / 15.209 / 15.247(d)	Radiated Emissions and Band Edge Measurement	PASS	Meet the requirement of limit. Minimum passing margin is -1.62 dB at 2486 MHz.
15.247(d)	Antenna Port Emission	PASS	Meet the requirement of limit.
15.247(a)(2)	6dB bandwidth	PASS	Meet the requirement of limit.
15.247(b)	Conducted power	PASS	Meet the requirement of limit.
15.247(e)	Power Spectral Density	PASS	Meet the requirement of limit.
15.203	Antenna Requirement	PASS	No antenna connector is used.

2.1 Measurement Uncertainty

Where relevant, the following measurement uncertainty levels have been estimated for tests performed on the EUT:

The listed uncertainties are the worst case uncertainty for the entire range of measurement. Please note that the uncertainty values are provided for informational purposes only and are not used in determining the PASS/FAIL results.

Measurement	Frequency	Expanded Uncertainty (k=2) (\pm)
Conducted Emissions at mains ports	150kHz ~ 30MHz	2.44 dB
Radiated Emissions up to 1 GHz	30MHz ~ 200MHz	2.0153 dB
	200MHz ~ 1000MHz	2.0224 dB
Radiated Emissions above 1 GHz	1GHz ~ 18GHz	1.0121 dB
	18GHz ~ 40GHz	1.1508 dB

2.2 Modification Record

There were no modifications required for compliance.

3 General Information

3.1 General Description of EUT

Product	802.11b/g/n IoT Module
Brand	Seeed
Test Model	LinkIt Smart 7688
Status of EUT	Identical Prototype
Power Supply Rating	3.3Vdc (Host equipment)
Modulation Type	CCK, DQPSK, DBPSK for DSSS 64QAM, 16QAM, QPSK, BPSK for OFDM
Modulation Technology	DSSS, OFDM
Transfer Rate	802.11b: 11.0 / 5.5 / 2.0 / 1.0 Mbps 802.11g: 54.0 / 48.0 / 36.0 / 24.0 / 18.0 / 12.0 / 9.0 / 6.0 Mbps 802.11n: up to MCS7
Operating Frequency	2412 ~ 2462MHz
Number of Channel	11 for 802.11b, 802.11g, 802.11n (20MHz) 7 for 802.11n (40MHz)
Output Power	206.06mW
Antenna Type	Chip antenna with 0.31 dBi gain
Antenna Connector	N/A
Accessory Device	Refer to Note as below
Data Cable Supplied	Refer to Note as below

Note:

1. Physically, the EUT provides one completed transmitter and one receiver.

Modulation Mode	TX Function
802.11b	1TX
802.11g	1TX
802.11n (20MHz)	1TX
802.11n (40MHz)	1TX

2. The above EUT information is declared by manufacturer and for more detailed features description, please refer to the manufacturer's specifications or user's manual.

3.2 Description of Test Modes

11 channels are provided for 802.11b, 802.11g and 802.11n (20MHz):

Channel	Frequency (MHz)	Channel	Frequency (MHz)
1	2412	7	2442
2	2417	8	2447
3	2422	9	2452
4	2427	10	2457
5	2432	11	2462
6	2437		

7 channels are provided for 802.11n (40MHz):

Channel	Frequency	Channel	Frequency
3	2422	7	2442
4	2427	8	2447
5	2432	9	2452
6	2437		

3.2.1 Test Mode Applicability and Tested Channel Detail

EUT Configure Mode	Applicable To				Description
	RE \geq 1G	RE<1G	PLC	APCM	
-	√	√	√	√	-

Where **RE \geq 1G**: Radiated Emission above 1GHz **RE<1G**: Radiated Emission below 1GHz
PLC: Power Line Conducted Emission **APCM**: Antenna Port Conducted Measurement

NOTE: The EUT had been pre-tested on the positioned of each 3 axis. The worst case was found when positioned on **X-plane**.
NOTE: “-” means no effect.

Radiated Emission Test (Above 1GHz):

- Pre-Scan has been conducted to determine the worst-case mode from all possible combinations between available modulations, data rates and antenna ports (if EUT with antenna diversity architecture).
- Following channel(s) was (were) selected for the final test as listed below.

EUT Configure Mode	Mode	Available Channel	Tested Channel	Modulation Technology	Modulation Type	Data Rate (Mbps)
-	802.11b	1 to 11	1, 6, 11	DSSS	DBPSK	1.0
-	802.11g	1 to 11	1, 6, 11	OFDM	BPSK	6.0
-	802.11n (20MHz)	1 to 11	1, 6, 11	OFDM	BPSK	MCS0
-	802.11n (40MHz)	3 to 9	3, 6, 9	OFDM	BPSK	MCS0

Radiated Emission Test (Below 1GHz):

- Pre-Scan has been conducted to determine the worst-case mode from all possible combinations between available modulations, data rates and antenna ports (if EUT with antenna diversity architecture).
- Following channel(s) was (were) selected for the final test as listed below.

EUT Configure Mode	Mode	Available Channel	Tested Channel	Modulation Technology	Modulation Type	Data Rate (Mbps)
-	802.11n (40MHz)	3 to 9	9	OFDM	BPSK	MCS0

Power Line Conducted Emission Test:

- Pre-Scan has been conducted to determine the worst-case mode from all possible combinations between available modulations, data rates and antenna ports (if EUT with antenna diversity architecture).
- Following channel(s) was (were) selected for the final test as listed below.

EUT Configure Mode	Mode	Available Channel	Tested Channel	Modulation Technology	Modulation Type	Data Rate (Mbps)
-	802.11n (40MHz)	3 to 9	9	OFDM	BPSK	MCS0

Bandedge Measurement:

- Pre-Scan has been conducted to determine the worst-case mode from all possible combinations between available modulations, data rates and antenna ports (if EUT with antenna diversity architecture).
- Following channel(s) was (were) selected for the final test as listed below.

EUT Configure Mode	Mode	Available Channel	Tested Channel	Modulation Technology	Modulation Type	Data Rate (Mbps)
-	802.11b	1 to 11	1, 11	DSSS	DBPSK	1.0
-	802.11g	1 to 11	1, 11	OFDM	BPSK	6.0
-	802.11n (20MHz)	1 to 11	1, 11	OFDM	BPSK	MCS0
-	802.11n (40MHz)	3 to 9	3, 9	OFDM	BPSK	MCS0

Antenna Port Conducted Measurement:

- This item includes all test value of each mode, but only includes spectrum plot of worst value of each mode.
- Pre-Scan has been conducted to determine the worst-case mode from all possible combinations between available modulations, data rates and antenna ports (if EUT with antenna diversity architecture).
- Following channel(s) was (were) selected for the final test as listed below.

EUT Configure Mode	Mode	Available Channel	Tested Channel	Modulation Technology	Modulation Type	Data Rate (Mbps)
-	802.11b	1 to 11	1, 6, 11	DSSS	DBPSK	1.0
-	802.11g	1 to 11	1, 6, 11	OFDM	BPSK	6.0
-	802.11n (20MHz)	1 to 11	1, 6, 11	OFDM	BPSK	MCS0
-	802.11n (40MHz)	3 to 9	3, 6, 9	OFDM	BPSK	MCS0

Test Condition:

Applicable To	Environmental Conditions	Input Power	Tested by
RE≥1G	25deg. C, 65%RH	120Vac, 60Hz	Charles Hsiao
RE<1G	25deg. C, 65%RH	120Vac, 60Hz	Charles Hsiao
PLC	25deg. C, 65%RH	120Vac, 60Hz	Toby Tian
APCM	25deg. C, 65%RH	3.3Vdc	Carlos Chen

3.3 Duty Cycle of Test Signal

802.11b: Duty cycle of test signal is 100 %, duty factor is not required.

802.11g: Duty cycle = $1.358/1.592 = 0.853$, Duty factor = $10 * \log(1/0.853) = 0.69$

802.11n (20MHz): Duty cycle = $1.283/1.417 = 0.906$, Duty factor = $10 * \log(1/0.906) = 0.43$

802.11n (40MHz): Duty cycle = $0.608/0.825 = 0.737$, Duty factor = $10 * \log(1/0.737) = 1.32$

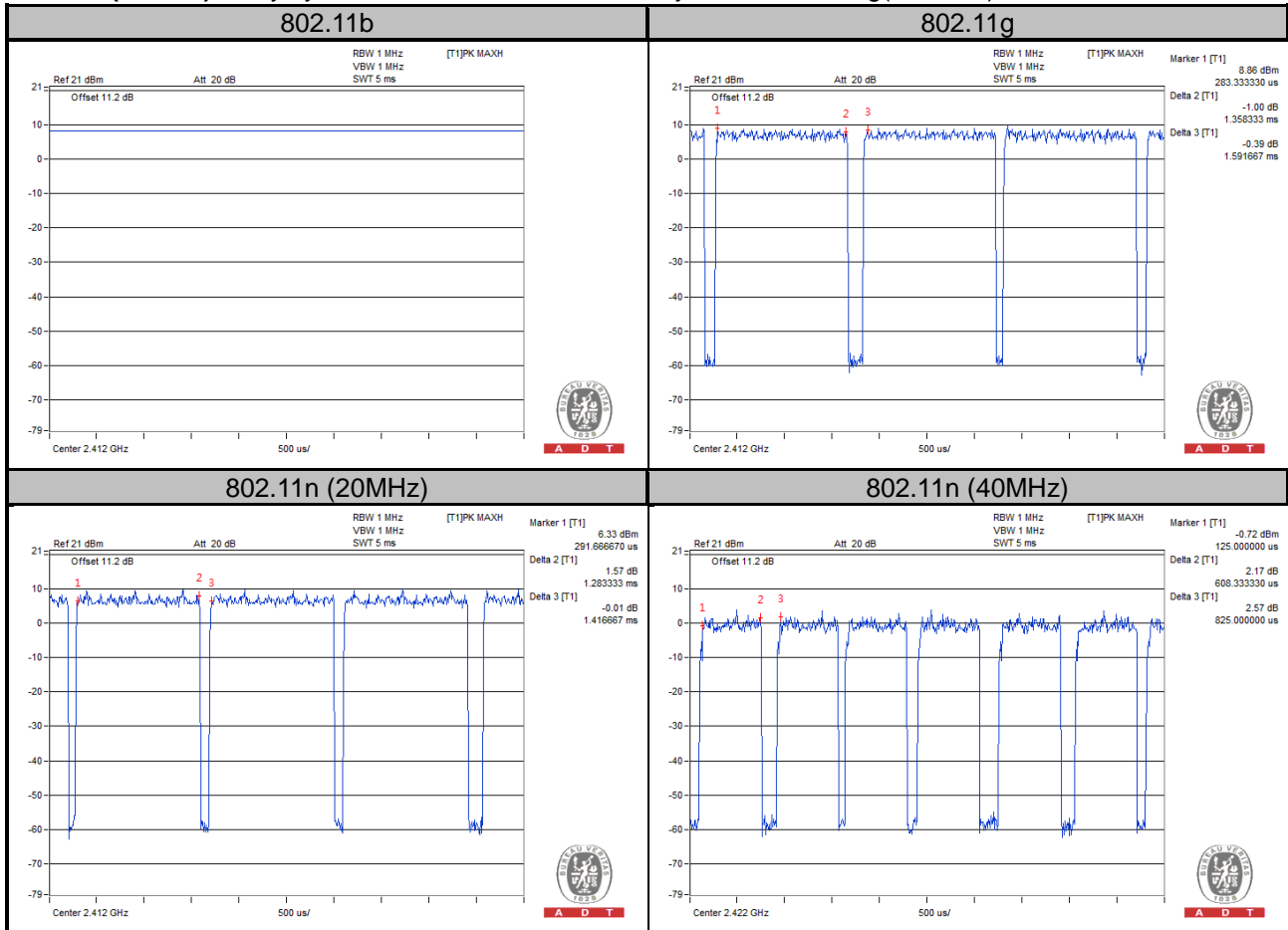

3.4 Description of Support Units

The EUT has been tested as an independent unit together with other necessary accessories or support units. The following support units or accessories were used to form a representative test configuration during the tests.

No.	Product	Brand	Model No.	Serial No.	FCC ID
1.	Notebook	DELL	N/A	N/A	N/A

No.	Signal Cable Description Of The Above Support Units
1.	N/A

Note:

1. All power cords of the above support units are non-shielded (1.8m).

3.4.1 Configuration of System under Test

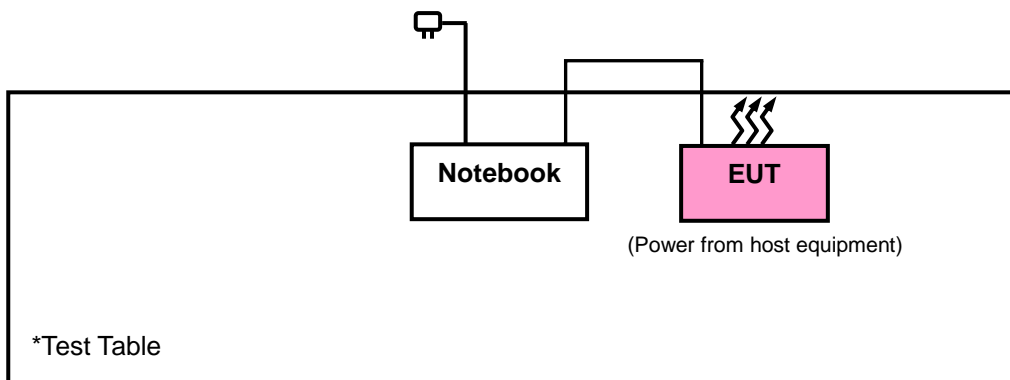

3.5 General Description of Applied Standards

The EUT is a RF Product. According to the specifications of the manufacturer, it must comply with the requirements of the following standards:

FCC Part 15, Subpart C (15.247)

558074 D01 DTS Meas Guidance v03r03

ANSI C63.10-2013

All test items have been performed and recorded as per the above standards.

NOTE: The EUT has been verified to comply with the requirements of FCC Part 15, Subpart B, Class B (DoC). The test report has been issued separately.

4 Test Types and Results

4.1 Radiated Emission and Bandedge Measurement

4.1.1 Limits of Radiated Emission and Bandedge Measurement

Radiated emissions which fall in the restricted bands must comply with the radiated emission limits specified as below table. Other emissions shall be at least 20dB below the highest level of the desired power:

Frequencies (MHz)	Field Strength (microvolts/meter)	Measurement Distance (meters)
0.009 ~ 0.490	2400/F(kHz)	300
0.490 ~ 1.705	24000/F(kHz)	30
1.705 ~ 30.0	30	30
30 ~ 88	100	3
88 ~ 216	150	3
216 ~ 960	200	3
Above 960	500	3

NOTE:

1. The lower limit shall apply at the transition frequencies.
2. Emission level (dBuV/m) = 20 log Emission level (uV/m).
3. For frequencies above 1000MHz, the field strength limits are based on average detector, however, the peak field strength of any emission shall not exceed the maximum permitted average limits, specified above by more than 20dB under any condition of modulation.

4.1.2 Test Instruments

Description & Manufacturer	Model No.	Serial No.	Date of Calibration	Due Date of Calibration
Spectrum Analyzer Agilent Technologies	N9038A	MY52260177	May 19, 2015	May 18, 2016
Spectrum Analyzer ROHDE & SCHWARZ	FSU43	101261	Dec. 10, 2014	Dec. 09, 2015
BILOG Antenna SCHWARZBECK	VULB9168	9168-472	Feb. 04, 2015	Feb. 04, 2016
HORN Antenna SCHWARZBECK	BBHA 9120 D	9120D-969	Feb. 09, 2015	Feb. 09, 2016
HORN Antenna ETS-Lindgren	3117	00143293	Jan. 05, 2015	Jan. 04, 2016
Loop Antenna	EM-6879	269	Jul. 31, 2015	Jul. 30, 2016
Bluetooth Tester	CBT	100980	Apr. 27, 2015	Apr. 26, 2017
Agilent Communications Tester-Wireless	8960 Series 10	MY53201073	Jul. 03, 2015	Jul. 02, 2017
Preamplifier Agilent	310N	187226	Jun. 29, 2015	Jun. 28, 2016
Preamplifier Agilent	83017A	MY39501357	Jun. 29, 2015	Jun. 28, 2016
Power Meter Anritsu	ML2495A	1232002	Sep. 21, 2015	Sep. 20, 2016
Power Meter Anritsu	ML2495A	1207325	Sep. 21, 2015	Sep. 20, 2016
RF signal cable ETS-LINDGREN	5D-FB	Cable-CH1-01(R FC-SMS-100-SM S-120+RFC-SMS -100-SMS-400)	Jun. 27, 2015	Jun. 26, 2016
RF signal cable ETS-LINDGREN	8D-FB	Cable-CH1-02(R FC-SMS-100-SM S-24)	Jun. 27, 2015	Jun. 26, 2016
Software BV ADT	E3 8.130425b	NA	NA	NA
Antenna Tower MF	NA	NA	NA	NA
Turn Table MF	NA	NA	NA	NA
Antenna Tower & Turn Table Controller MF	MF-7802	NA	NA	NA

- Note: 1. The calibration interval of the above test instruments is 12 months and the calibrations are traceable to NML/ROC and NIST/USA.
2. The test was performed in HsinTien Chamber 1.
3. The horn antenna and preamplifier (model: 83017A) are used only for the measurement of emission frequency above 1GHz if tested.
4. The FCC Site Registration No. is 149147.
5. The IC Site Registration No. is IC7450I-1.

4.1.3 Test Procedures

- a. The EUT was placed on the top of a rotating table 0.8 meters (for below 1GHz) / 1.5 meters (for above 1GHz) above the ground at 3 meter chamber room for test. The table was rotated 360 degrees to determine the position of the highest radiation.
- b. The EUT was set 3 meters away from the interference-receiving antenna, which was mounted on the top of a variable-height antenna tower.
- c. The height of antenna is varied from one meter to four meters above the ground to determine the maximum value of the field strength. Both horizontal and vertical polarizations of the antenna are set to make the measurement.
- d. For each suspected emission, the EUT was arranged to its worst case and then the antenna was tuned to heights from 1 meter to 4 meters and the rotatable table was turned from 0 degrees to 360 degrees to find the maximum reading.
- e. The test-receiver system was set to quasi-peak detect function and specified bandwidth with maximum hold mode when the test frequency is below 1 GHz.
- f. The test-receiver system was set to peak and average detect function and specified bandwidth with maximum hold mode when the test frequency is above 1 GHz. If the peak reading value also meets average limit, measurement with the average detector is unnecessary.

Note:

1. The resolution bandwidth and video bandwidth of test receiver/spectrum analyzer is 120 kHz for Quasi-peak detection (QP) at frequency below 1 GHz.
2. The resolution bandwidth of test receiver/spectrum analyzer is 1 MHz and the video bandwidth is 3 MHz for Peak detection (PK) at frequency above 1 GHz.
3. The resolution bandwidth of test receiver/spectrum analyzer is 1 MHz and the video bandwidth is 3 MHz for RMS Average (Duty cycle < 98%) for Average detection (AV) at frequency above 1GHz, then the measurement results was added to a correction factor ($10 \log(1/\text{duty cycle})$).
4. The resolution bandwidth of test receiver/spectrum analyzer is 1MHz and the video bandwidth is 10 Hz (Duty cycle $\geq 98\%$) for Average detection (AV) at frequency above 1 GHz.
5. All modes of operation were investigated and the worst-case emissions are reported.

4.1.4 Deviation from Test Standard

No deviation.

4.1.5 Test Set Up

<Frequency Range below 1GHz>

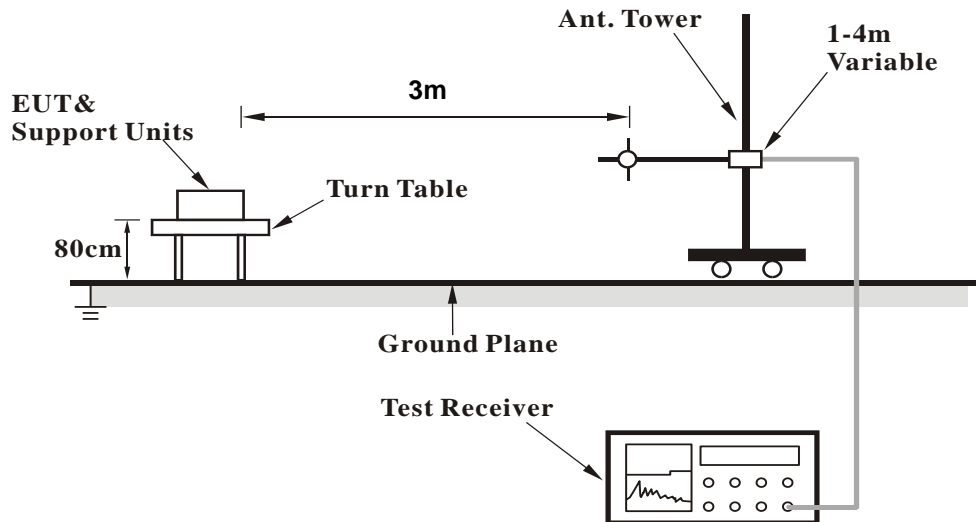

<Frequency Range above 1GHz>

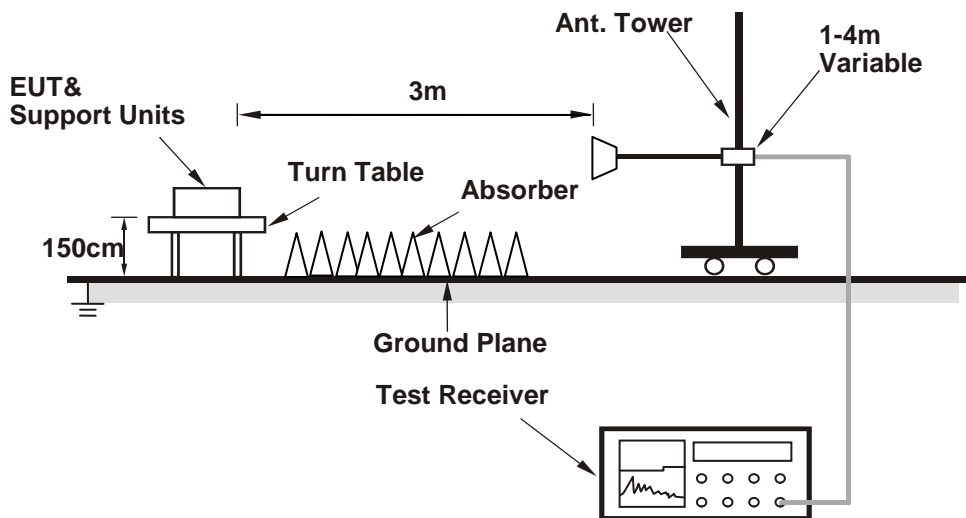

For the actual test configuration, please refer to the attached file (Test Setup Photo).

4.1.6 EUT Operating Conditions

- Placed the EUT on a testing table.
- Use the software to control the EUT under transmission condition continuously at specific channel frequency.

4.1.7 Test Results
Above 1GHz Data :
802.11b

EUT TEST CONDITION		MEASUREMENT DETAIL	
CHANNEL	Channel 1	FREQUENCY RANGE	1GHz ~ 25GHz
INPUT POWER	120Vac, 60 Hz	DETECTOR FUNCTION	Peak (PK) Average (AV)
ENVIRONMENTAL CONDITIONS	25deg. C, 65%RH	TESTED BY	Charles Hsiao

ANTENNA POLARITY & TEST DISTANCE: HORIZONTAL AT 3 M

FREQ. (MHz)	EMISSION LEVEL (dBuV/m)	READ LEVEL (dBuV)	LIMIT (dBuV/m)	MARGIN (dB)	ANTENNA FACTOR (dB/m)	CABLE LOSS (dB)	PREAMP FACTOR (dB)	ANTENNA HEIGHT (cm)	TABLE ANGLE (Degree)	REMARK
2320	40.05	38.54	54	-13.95	31.73	5.3	35.52	156	196	Average
2320	55.17	53.66	74	-18.83	31.73	5.3	35.52	156	196	Peak
2412	97.01	95.24			31.81	5.43	35.47	156	196	Average
2412	100.82	99.05			31.81	5.43	35.47	156	196	Peak
2498	40.3	38.28	54	-13.7	31.9	5.53	35.41	156	196	Average
2498	55.98	53.96	74	-18.02	31.9	5.53	35.41	156	196	Peak

ANTENNA POLARITY & TEST DISTANCE: VERTICAL AT 3 M

FREQ. (MHz)	EMISSION LEVEL (dBuV/m)	READ LEVEL (dBuV)	LIMIT (dBuV/m)	MARGIN (dB)	ANTENNA FACTOR (dB/m)	CABLE LOSS (dB)	PREAMP FACTOR (dB)	ANTENNA HEIGHT (cm)	TABLE ANGLE (Degree)	REMARK
2355	39.1	37.47	54	-14.9	31.76	5.37	35.5	259	326	Average
2355	55.44	53.81	74	-18.56	31.76	5.37	35.5	259	326	Peak
2412	90.58	88.81			31.81	5.43	35.47	259	326	Average
2412	93.09	91.32			31.81	5.43	35.47	259	326	Peak
2486	40.11	38.12	54	-13.89	31.88	5.53	35.42	259	326	Average
2486	55.45	53.46	74	-18.55	31.88	5.53	35.42	259	326	Peak

REMARKS:

- Emission Level = Read Level + Antenna Factor + Cable Loss - Preamp Factor
Margin value = Emission level – Limit value
- 2412MHz: Fundamental frequency.



EUT TEST CONDITION		MEASUREMENT DETAIL	
CHANNEL	Channel 6	FREQUENCY RANGE	1GHz ~ 25GHz
INPUT POWER	120Vac, 60 Hz	DETECTOR FUNCTION	Peak (PK) Average (AV)
ENVIRONMENTAL CONDITIONS	25deg. C, 65%RH	TESTED BY	Charles Hsiao

ANTENNA POLARITY & TEST DISTANCE: HORIZONTAL AT 3 M										
FREQ. (MHz)	EMISSION LEVEL (dBuV/m)	READ LEVEL (dBuV)	LIMIT (dBuV/m)	MARGIN (dB)	ANTENNA FACTOR (dB/m)	CABLE LOSS (dB)	PREAMP FACTOR (dB)	ANTENNA HEIGHT (cm)	TABLE ANGLE (Degree)	REMARK
2318	38.88	37.37	54	-15.12	31.73	5.3	35.52	172	196	Average
2318	54.99	53.48	74	-19.01	31.73	5.3	35.52	172	196	Peak
2437	97.38	95.53			31.85	5.46	35.46	172	196	Average
2437	100.4	98.55			31.85	5.46	35.46	172	196	Peak
2488	39.5	37.49	54	-14.5	31.9	5.53	35.42	172	196	Average
2488	55.51	53.5	74	-18.49	31.9	5.53	35.42	172	196	Peak
ANTENNA POLARITY & TEST DISTANCE: VERTICAL AT 3 M										
FREQ. (MHz)	EMISSION LEVEL (dBuV/m)	READ LEVEL (dBuV)	LIMIT (dBuV/m)	MARGIN (dB)	ANTENNA FACTOR (dB/m)	CABLE LOSS (dB)	PREAMP FACTOR (dB)	ANTENNA HEIGHT (cm)	TABLE ANGLE (Degree)	REMARK
2352	39.08	37.49	54	-14.92	31.76	5.33	35.5	259	326	Average
2352	55.31	53.72	74	-18.69	31.76	5.33	35.5	259	326	Peak
2437	90.27	88.42			31.85	5.46	35.46	259	326	Average
2437	93.86	92.01			31.85	5.46	35.46	259	326	Peak
2484	39.7	37.74	54	-14.3	31.88	5.5	35.42	259	326	Average
2484	55.8	53.84	74	-18.2	31.88	5.5	35.42	259	326	Peak

REMARKS:

- Emission Level = Read Level + Antenna Factor + Cable Loss - Preamp Factor
Margin value = Emission level – Limit value
- 2437MHz: Fundamental frequency.



A D T

EUT TEST CONDITION		MEASUREMENT DETAIL	
CHANNEL	Channel 11	FREQUENCY RANGE	1GHz ~ 25GHz
INPUT POWER	120Vac, 60 Hz	DETECTOR FUNCTION	Peak (PK) Average (AV)
ENVIRONMENTAL CONDITIONS	25deg. C, 65%RH	TESTED BY	Charles Hsiao

ANTENNA POLARITY & TEST DISTANCE: HORIZONTAL AT 3 M										
FREQ. (MHz)	EMISSION LEVEL (dBuV/m)	READ LEVEL (dBuV)	LIMIT (dBuV/m)	MARGIN (dB)	ANTENNA FACTOR (dB/m)	CABLE LOSS (dB)	PREAMP FACTOR (dB)	ANTENNA HEIGHT (cm)	TABLE ANGLE (Degree)	REMARK
2388	39.1	37.39	54	-14.9	31.8	5.4	35.49	170	196	Average
2388	54.97	53.26	74	-19.03	31.8	5.4	35.49	170	196	Peak
2462	97.15	95.22			31.87	5.5	35.44	170	196	Average
2462	100.42	98.49			31.87	5.5	35.44	170	196	Peak
2490	40.19	38.18	54	-13.81	31.9	5.53	35.42	170	196	Average
2490	55.77	53.76	74	-18.23	31.9	5.53	35.42	170	196	Peak

ANTENNA POLARITY & TEST DISTANCE: VERTICAL AT 3 M										
FREQ. (MHz)	EMISSION LEVEL (dBuV/m)	READ LEVEL (dBuV)	LIMIT (dBuV/m)	MARGIN (dB)	ANTENNA FACTOR (dB/m)	CABLE LOSS (dB)	PREAMP FACTOR (dB)	ANTENNA HEIGHT (cm)	TABLE ANGLE (Degree)	REMARK
2362	39.02	37.39	54	-14.98	31.76	5.37	35.5	273	328	Average
2362	54.85	53.22	74	-19.15	31.76	5.37	35.5	273	328	Peak
2462	90.11	88.18			31.87	5.5	35.44	273	328	Average
2462	93.28	91.35			31.87	5.5	35.44	273	328	Peak
2500	39.83	37.81	54	-14.17	31.9	5.53	35.41	273	328	Average
2500	55.35	53.33	74	-18.65	31.9	5.53	35.41	273	328	Peak

REMARKS:

- Emission Level = Read Level + Antenna Factor + Cable Loss - Preamp Factor
Margin value = Emission level – Limit value
- 2462MHz: Fundamental frequency.

802.11g

EUT TEST CONDITION		MEASUREMENT DETAIL	
CHANNEL	Channel 1	FREQUENCY RANGE	1GHz ~ 25GHz
INPUT POWER	120Vac, 60 Hz	DETECTOR FUNCTION	Peak (PK) Average (AV)
ENVIRONMENTAL CONDITIONS	25deg. C, 65%RH	TESTED BY	Charles Hsiao

ANTENNA POLARITY & TEST DISTANCE: HORIZONTAL AT 3 M

FREQ. (MHz)	EMISSION LEVEL (dBuV/m)	READ LEVEL (dBuV)	LIMIT (dBuV/m)	MARGIN (dB)	ANTENNA FACTOR (dB/m)	CABLE LOSS (dB)	PREAMP FACTOR (dB)	ANTENNA HEIGHT (cm)	TABLE ANGLE (Degree)	REMARK
2390	43.54	41.81	54	-10.46	31.8	5.4	35.47	156	196	Average
2390	56.36	54.63	74	-17.64	31.8	5.4	35.47	156	196	Peak
2412	92.92	91.15			31.81	5.43	35.47	156	196	Average
2412	100.45	98.68			31.81	5.43	35.47	156	196	Peak
2500	40.27	38.25	54	-13.73	31.9	5.53	35.41	156	196	Average
2500	56.16	54.14	74	-17.84	31.9	5.53	35.41	156	196	Peak

ANTENNA POLARITY & TEST DISTANCE: VERTICAL AT 3 M

FREQ. (MHz)	EMISSION LEVEL (dBuV/m)	READ LEVEL (dBuV)	LIMIT (dBuV/m)	MARGIN (dB)	ANTENNA FACTOR (dB/m)	CABLE LOSS (dB)	PREAMP FACTOR (dB)	ANTENNA HEIGHT (cm)	TABLE ANGLE (Degree)	REMARK
2350	40.02	38.45	54	-13.98	31.74	5.33	35.5	259	326	Average
2350	55.09	53.52	74	-18.91	31.74	5.33	35.5	259	326	Peak
2412	85.84	84.07			31.81	5.43	35.47	259	326	Average
2412	93.6	91.83			31.81	5.43	35.47	259	326	Peak
2490	40.25	38.24	54	-13.75	31.9	5.53	35.42	259	326	Average
2490	55.18	53.17	74	-18.82	31.9	5.53	35.42	259	326	Peak

REMARKS:

- Emission Level = Read Level + Antenna Factor + Cable Loss - Preamp Factor
Margin value = Emission level – Limit value
- 2412MHz: Fundamental frequency.



A D T

EUT TEST CONDITION		MEASUREMENT DETAIL	
CHANNEL	Channel 6	FREQUENCY RANGE	1GHz ~ 25GHz
INPUT POWER	120Vac, 60 Hz	DETECTOR FUNCTION	Peak (PK) Average (AV)
ENVIRONMENTAL CONDITIONS	25deg. C, 65%RH	TESTED BY	Charles Hsiao

ANTENNA POLARITY & TEST DISTANCE: HORIZONTAL AT 3 M										
FREQ. (MHz)	EMISSION LEVEL (dBuV/m)	READ LEVEL (dBuV)	LIMIT (dBuV/m)	MARGIN (dB)	ANTENNA FACTOR (dB/m)	CABLE LOSS (dB)	PREAMP FACTOR (dB)	ANTENNA HEIGHT (cm)	TABLE ANGLE (Degree)	REMARK
2310	39.75	38.27	54	-14.25	31.71	5.3	35.53	156	196	Average
2310	54.29	52.81	74	-19.71	31.71	5.3	35.53	156	196	Peak
2437	93.11	91.26			31.85	5.46	35.46	156	196	Average
2437	100.69	98.84			31.85	5.46	35.46	156	196	Peak
2484	41.68	39.72	54	-12.32	31.88	5.5	35.42	156	196	Average
2484	55.69	53.73	74	-18.31	31.88	5.5	35.42	156	196	Peak

ANTENNA POLARITY & TEST DISTANCE: VERTICAL AT 3 M										
FREQ. (MHz)	EMISSION LEVEL (dBuV/m)	READ LEVEL (dBuV)	LIMIT (dBuV/m)	MARGIN (dB)	ANTENNA FACTOR (dB/m)	CABLE LOSS (dB)	PREAMP FACTOR (dB)	ANTENNA HEIGHT (cm)	TABLE ANGLE (Degree)	REMARK
2370	39.99	38.33	54	-14.01	31.78	5.37	35.49	259	326	Average
2370	55.6	53.94	74	-18.4	31.78	5.37	35.49	259	326	Peak
2437	85.1	83.25			31.85	5.46	35.46	259	326	Average
2437	93.27	91.42			31.85	5.46	35.46	259	326	Peak
2496	40.3	38.28	54	-13.7	31.9	5.53	35.41	259	326	Average
2496	55.7	53.68	74	-18.3	31.9	5.53	35.41	259	326	Peak

REMARKS:

- Emission Level = Read Level + Antenna Factor + Cable Loss - Preamp Factor
Margin value = Emission level – Limit value
- 2437MHz: Fundamental frequency.



A D T

EUT TEST CONDITION		MEASUREMENT DETAIL	
CHANNEL	Channel 11	FREQUENCY RANGE	1GHz ~ 25GHz
INPUT POWER	120Vac, 60 Hz	DETECTOR FUNCTION	Peak (PK) Average (AV)
ENVIRONMENTAL CONDITIONS	25deg. C, 65%RH	TESTED BY	Charles Hsiao

ANTENNA POLARITY & TEST DISTANCE: HORIZONTAL AT 3 M										
FREQ. (MHz)	EMISSION LEVEL (dBuV/m)	READ LEVEL (dBuV)	LIMIT (dBuV/m)	MARGIN (dB)	ANTENNA FACTOR (dB/m)	CABLE LOSS (dB)	PREAMP FACTOR (dB)	ANTENNA HEIGHT (cm)	TABLE ANGLE (Degree)	REMARK
2320	39.85	38.34	54	-14.15	31.73	5.3	35.52	170	196	Average
2320	55.3	53.79	74	-18.7	31.73	5.3	35.52	170	196	Peak
2462	93.8	91.87			31.87	5.5	35.44	170	196	Average
2462	101.17	99.24			31.87	5.5	35.44	170	196	Peak
2484	46.96	45	54	-7.04	31.88	5.5	35.42	170	196	Average
2484	61.11	59.15	74	-12.89	31.88	5.5	35.42	170	196	Peak

ANTENNA POLARITY & TEST DISTANCE: VERTICAL AT 3 M										
FREQ. (MHz)	EMISSION LEVEL (dBuV/m)	READ LEVEL (dBuV)	LIMIT (dBuV/m)	MARGIN (dB)	ANTENNA FACTOR (dB/m)	CABLE LOSS (dB)	PREAMP FACTOR (dB)	ANTENNA HEIGHT (cm)	TABLE ANGLE (Degree)	REMARK
2340	39.49	37.92	54	-14.51	31.74	5.33	35.5	273	308	Average
2340	55.75	54.18	74	-18.25	31.74	5.33	35.5	273	308	Peak
2462	85.66	83.73			31.87	5.5	35.44	273	308	Average
2462	93.29	91.36			31.87	5.5	35.44	273	308	Peak
2484	42	40.04	54	-12	31.88	5.5	35.42	273	308	Average
2484	55.98	54.02	74	-18.02	31.88	5.5	35.42	273	308	Peak

REMARKS:

- Emission Level = Read Level + Antenna Factor + Cable Loss - Preamp Factor
Margin value = Emission level – Limit value
- 2462MHz: Fundamental frequency.

802.11n (20MHz)

EUT TEST CONDITION		MEASUREMENT DETAIL	
CHANNEL	Channel 1	FREQUENCY RANGE	1GHz ~ 25GHz
INPUT POWER	120Vac, 60 Hz	DETECTOR FUNCTION	Peak (PK) Average (AV)
ENVIRONMENTAL CONDITIONS	25deg. C, 65%RH	TESTED BY	Charles Hsiao

ANTENNA POLARITY & TEST DISTANCE: HORIZONTAL AT 3 M

FREQ. (MHz)	EMISSION LEVEL (dBuV/m)	READ LEVEL (dBuV)	LIMIT (dBuV/m)	MARGIN (dB)	ANTENNA FACTOR (dB/m)	CABLE LOSS (dB)	PREAMP FACTOR (dB)	ANTENNA HEIGHT (cm)	TABLE ANGLE (Degree)	REMARK
2390	45	43.27	54	-9	31.8	5.4	35.47	156	196	Average
2390	59.55	57.82	74	-14.45	31.8	5.4	35.47	156	196	Peak
2412	92.39	90.62			31.81	5.43	35.47	156	196	Average
2412	100.2	98.43			31.81	5.43	35.47	156	196	Peak
2490	40.11	38.1	54	-13.89	31.9	5.53	35.42	156	196	Average
2490	55.43	53.42	74	-18.57	31.9	5.53	35.42	156	196	Peak

ANTENNA POLARITY & TEST DISTANCE: VERTICAL AT 3 M

FREQ. (MHz)	EMISSION LEVEL (dBuV/m)	READ LEVEL (dBuV)	LIMIT (dBuV/m)	MARGIN (dB)	ANTENNA FACTOR (dB/m)	CABLE LOSS (dB)	PREAMP FACTOR (dB)	ANTENNA HEIGHT (cm)	TABLE ANGLE (Degree)	REMARK
2310	40.19	38.71	54	-13.81	31.71	5.3	35.53	259	326	Average
2310	55.15	53.67	74	-18.85	31.71	5.3	35.53	259	326	Peak
2412	85.59	83.82			31.81	5.43	35.47	259	326	Average
2412	93.61	91.84			31.81	5.43	35.47	259	326	Peak
2488	40.35	38.34	54	-13.65	31.9	5.53	35.42	259	326	Average
2488	55.12	53.11	74	-18.88	31.9	5.53	35.42	259	326	Peak

REMARKS:

- Emission Level = Read Level + Antenna Factor + Cable Loss - Preamp Factor
Margin value = Emission level – Limit value
- 2412MHz: Fundamental frequency.



A D T

EUT TEST CONDITION		MEASUREMENT DETAIL	
CHANNEL	Channel 6	FREQUENCY RANGE	1GHz ~ 25GHz
INPUT POWER	120Vac, 60 Hz	DETECTOR FUNCTION	Peak (PK) Average (AV)
ENVIRONMENTAL CONDITIONS	25deg. C, 65%RH	TESTED BY	Charles Hsiao

ANTENNA POLARITY & TEST DISTANCE: HORIZONTAL AT 3 M										
FREQ. (MHz)	EMISSION LEVEL (dBuV/m)	READ LEVEL (dBuV)	LIMIT (dBuV/m)	MARGIN (dB)	ANTENNA FACTOR (dB/m)	CABLE LOSS (dB)	PREAMP FACTOR (dB)	ANTENNA HEIGHT (cm)	TABLE ANGLE (Degree)	REMARK
2328	39.9	38.39	54	-14.1	31.73	5.3	35.52	172	196	Average
2328	55.34	53.83	74	-18.66	31.73	5.3	35.52	172	196	Peak
2437	93.18	91.33			31.85	5.46	35.46	172	196	Average
2437	100.87	99.02			31.85	5.46	35.46	172	196	Peak
2488	42.1	40.09	54	-11.9	31.9	5.53	35.42	172	196	Average
2488	56	53.99	74	-18	31.9	5.53	35.42	172	196	Peak

ANTENNA POLARITY & TEST DISTANCE: VERTICAL AT 3 M										
FREQ. (MHz)	EMISSION LEVEL (dBuV/m)	READ LEVEL (dBuV)	LIMIT (dBuV/m)	MARGIN (dB)	ANTENNA FACTOR (dB/m)	CABLE LOSS (dB)	PREAMP FACTOR (dB)	ANTENNA HEIGHT (cm)	TABLE ANGLE (Degree)	REMARK
2330	39.44	37.9	54	-14.56	31.73	5.33	35.52	259	326	Average
2330	55.17	53.63	74	-18.83	31.73	5.33	35.52	259	326	Peak
2437	86.31	84.46			31.85	5.46	35.46	259	326	Average
2437	93.55	91.7			31.85	5.46	35.46	259	326	Peak
2488	40.4	38.39	54	-13.6	31.9	5.53	35.42	259	326	Average
2488	55.98	53.97	74	-18.02	31.9	5.53	35.42	259	326	Peak

REMARKS:

- Emission Level = Read Level + Antenna Factor + Cable Loss - Preamp Factor
Margin value = Emission level – Limit value
- 2437MHz: Fundamental frequency.



EUT TEST CONDITION		MEASUREMENT DETAIL	
CHANNEL	Channel 11	FREQUENCY RANGE	1GHz ~ 25GHz
INPUT POWER	120Vac, 60 Hz	DETECTOR FUNCTION	Peak (PK) Average (AV)
ENVIRONMENTAL CONDITIONS	25deg. C, 65%RH	TESTED BY	Charles Hsiao

ANTENNA POLARITY & TEST DISTANCE: HORIZONTAL AT 3 M										
FREQ. (MHz)	EMISSION LEVEL (dBuV/m)	READ LEVEL (dBuV)	LIMIT (dBuV/m)	MARGIN (dB)	ANTENNA FACTOR (dB/m)	CABLE LOSS (dB)	PREAMP FACTOR (dB)	ANTENNA HEIGHT (cm)	TABLE ANGLE (Degree)	REMARK
2380	40.05	38.39	54	-13.95	31.78	5.37	35.49	108	196	Average
2380	55.51	53.85	74	-18.49	31.78	5.37	35.49	108	196	Peak
2462	92.66	90.73			31.87	5.5	35.44	108	196	Average
2462	100.97	99.04			31.87	5.5	35.44	108	196	Peak
2484	47.69	45.73	54	-6.31	31.88	5.5	35.42	108	196	Average
2484	62.2	60.24	74	-11.8	31.88	5.5	35.42	108	196	Peak
ANTENNA POLARITY & TEST DISTANCE: VERTICAL AT 3 M										
FREQ. (MHz)	EMISSION LEVEL (dBuV/m)	READ LEVEL (dBuV)	LIMIT (dBuV/m)	MARGIN (dB)	ANTENNA FACTOR (dB/m)	CABLE LOSS (dB)	PREAMP FACTOR (dB)	ANTENNA HEIGHT (cm)	TABLE ANGLE (Degree)	REMARK
2386	39.9	38.19	54	-14.1	31.8	5.4	35.49	273	307	Average
2386	55	53.29	74	-19	31.8	5.4	35.49	273	307	Peak
2462	86.28	84.35			31.87	5.5	35.44	273	307	Average
2462	93.14	91.21			31.87	5.5	35.44	273	307	Peak
2484	43.11	41.15	54	-10.89	31.88	5.5	35.42	273	307	Average
2484	57.49	55.53	74	-16.51	31.88	5.5	35.42	273	307	Peak

REMARKS:

- Emission Level = Read Level + Antenna Factor + Cable Loss - Preamp Factor
Margin value = Emission level – Limit value
- 2462MHz: Fundamental frequency.

802.11n (40MHz)

EUT TEST CONDITION		MEASUREMENT DETAIL	
CHANNEL	Channel 3	FREQUENCY RANGE	1GHz ~ 25GHz
INPUT POWER	120Vac, 60 Hz	DETECTOR FUNCTION	Peak (PK) Average (AV)
ENVIRONMENTAL CONDITIONS	25deg. C, 65%RH	TESTED BY	Charles Hsiao

ANTENNA POLARITY & TEST DISTANCE: HORIZONTAL AT 3 M

FREQ. (MHz)	EMISSION LEVEL (dBuV/m)	READ LEVEL (dBuV)	LIMIT (dBuV/m)	MARGIN (dB)	ANTENNA FACTOR (dB/m)	CABLE LOSS (dB)	PREAMP FACTOR (dB)	ANTENNA HEIGHT (cm)	TABLE ANGLE (Degree)	REMARK
2390	49.89	48.16	54	-4.11	31.8	5.4	35.47	108	196	Average
2390	62.79	61.06	74	-11.21	31.8	5.4	35.47	108	196	Peak
2422	89.83	88.03			31.83	5.43	35.46	108	196	Average
2422	97.01	95.21			31.83	5.43	35.46	108	196	Peak
2484	44.77	42.81	54	-9.23	31.88	5.5	35.42	108	196	Average
2484	56.29	54.33	74	-17.71	31.88	5.5	35.42	108	196	Peak

ANTENNA POLARITY & TEST DISTANCE: VERTICAL AT 3 M

FREQ. (MHz)	EMISSION LEVEL (dBuV/m)	READ LEVEL (dBuV)	LIMIT (dBuV/m)	MARGIN (dB)	ANTENNA FACTOR (dB/m)	CABLE LOSS (dB)	PREAMP FACTOR (dB)	ANTENNA HEIGHT (cm)	TABLE ANGLE (Degree)	REMARK
2390	43.07	41.34	54	-10.93	31.8	5.4	35.47	273	308	Average
2390	55.42	53.69	74	-18.58	31.8	5.4	35.47	273	308	Peak
2422	84.22	82.42			31.83	5.43	35.46	273	308	Average
2422	92.48	90.68			31.83	5.43	35.46	273	308	Peak
2498	42.11	40.09	54	-11.89	31.9	5.53	35.41	273	308	Average
2498	55.85	53.83	74	-18.15	31.9	5.53	35.41	273	308	Peak

REMARKS:

- Emission Level = Read Level + Antenna Factor + Cable Loss - Preamp Factor
Margin value = Emission level – Limit value
- 2422MHz: Fundamental frequency.



A D T

EUT TEST CONDITION		MEASUREMENT DETAIL	
CHANNEL	Channel 6	FREQUENCY RANGE	1GHz ~ 25GHz
INPUT POWER	120Vac, 60 Hz	DETECTOR FUNCTION	Peak (PK) Average (AV)
ENVIRONMENTAL CONDITIONS	25deg. C, 65%RH	TESTED BY	Charles Hsiao

ANTENNA POLARITY & TEST DISTANCE: HORIZONTAL AT 3 M										
FREQ. (MHz)	EMISSION LEVEL (dBuV/m)	READ LEVEL (dBuV)	LIMIT (dBuV/m)	MARGIN (dB)	ANTENNA FACTOR (dB/m)	CABLE LOSS (dB)	PREAMP FACTOR (dB)	ANTENNA HEIGHT (cm)	TABLE ANGLE (Degree)	REMARK
2382	40.98	39.29	54	-13.02	31.78	5.4	35.49	174	196	Average
2382	55.37	53.68	74	-18.63	31.78	5.4	35.49	174	196	Peak
2437	90.81	88.96			31.85	5.46	35.46	174	196	Average
2437	98.16	96.31			31.85	5.46	35.46	174	196	Peak
2494	43.43	41.41	54	-10.57	31.9	5.53	35.41	174	196	Average
2494	56.39	54.37	74	-17.61	31.9	5.53	35.41	174	196	Peak
ANTENNA POLARITY & TEST DISTANCE: VERTICAL AT 3 M										
FREQ. (MHz)	EMISSION LEVEL (dBuV/m)	READ LEVEL (dBuV)	LIMIT (dBuV/m)	MARGIN (dB)	ANTENNA FACTOR (dB/m)	CABLE LOSS (dB)	PREAMP FACTOR (dB)	ANTENNA HEIGHT (cm)	TABLE ANGLE (Degree)	REMARK
2358	40.63	39	54	-13.37	31.76	5.37	35.5	273	308	Average
2358	54.9	53.27	74	-19.1	31.76	5.37	35.5	273	308	Peak
2437	85.31	83.46			31.85	5.46	35.46	273	308	Average
2437	92.47	90.62			31.85	5.46	35.46	273	308	Peak
2484	42.18	40.22	54	-11.82	31.88	5.5	35.42	273	308	Average
2484	55.55	53.59	74	-18.45	31.88	5.5	35.42	273	308	Peak

REMARKS:

- Emission Level = Read Level + Antenna Factor + Cable Loss - Preamp Factor
Margin value = Emission level – Limit value
- 2437MHz: Fundamental frequency.



A D T

EUT TEST CONDITION		MEASUREMENT DETAIL	
CHANNEL	Channel 9	FREQUENCY RANGE	1GHz ~ 25GHz
INPUT POWER	120Vac, 60 Hz	DETECTOR FUNCTION	Peak (PK) Average (AV)
ENVIRONMENTAL CONDITIONS	25deg. C, 65%RH	TESTED BY	Charles Hsiao

ANTENNA POLARITY & TEST DISTANCE: HORIZONTAL AT 3 M										
FREQ. (MHz)	EMISSION LEVEL (dBuV/m)	READ LEVEL (dBuV)	LIMIT (dBuV/m)	MARGIN (dB)	ANTENNA FACTOR (dB/m)	CABLE LOSS (dB)	PREAMP FACTOR (dB)	ANTENNA HEIGHT (cm)	TABLE ANGLE (Degree)	REMARK
2388	39.89	38.18	54	-14.11	31.8	5.4	35.49	107	196	Average
2388	55.11	53.4	74	-18.89	31.8	5.4	35.49	107	196	Peak
2452	91.48	89.61			31.85	5.46	35.44	107	196	Average
2452	98.78	96.91			31.85	5.46	35.44	107	196	Peak
2486	52.38	50.39	54	-1.62	31.88	5.53	35.42	107	196	Average
2486	67.11	65.12	74	-6.89	31.88	5.53	35.42	107	196	Peak

ANTENNA POLARITY & TEST DISTANCE: VERTICAL AT 3 M										
FREQ. (MHz)	EMISSION LEVEL (dBuV/m)	READ LEVEL (dBuV)	LIMIT (dBuV/m)	MARGIN (dB)	ANTENNA FACTOR (dB/m)	CABLE LOSS (dB)	PREAMP FACTOR (dB)	ANTENNA HEIGHT (cm)	TABLE ANGLE (Degree)	REMARK
2340	40.11	38.54	54	-13.89	31.74	5.33	35.5	273	308	Average
2340	55.14	53.57	74	-18.86	31.74	5.33	35.5	273	308	Peak
2452	85.14	83.27			31.85	5.46	35.44	273	308	Average
2452	92.14	90.27			31.85	5.46	35.44	273	308	Peak
2486	46.36	44.37	54	-7.64	31.88	5.53	35.42	273	308	Average
2486	60.1	58.11	74	-13.9	31.88	5.53	35.42	273	308	Peak

REMARKS:

- Emission Level = Read Level + Antenna Factor + Cable Loss - Preamp Factor
Margin value = Emission level – Limit value
- 2452MHz: Fundamental frequency.

9kHz ~ 30MHz DATA:

The amplitude of spurious emissions attenuated more than 20dB below the permissible value is not required to be report.

30MHz ~ 1GHz WORST-CASE DATA:
802.11n (40MHz)

EUT TEST CONDITION		MEASUREMENT DETAIL	
CHANNEL	Channel 9	FREQUENCY RANGE	30MHz ~ 1GHz
INPUT POWER	120Vac, 60 Hz	DETECTOR FUNCTION	Peak (PK)
ENVIRONMENTAL CONDITIONS	25deg. C, 65%RH	TESTED BY	Charles Hsiao

ANTENNA POLARITY & TEST DISTANCE: HORIZONTAL AT 3 M										
FREQ. (MHz)	EMISSION LEVEL (dBuV/m)	READ LEVEL (dBuV)	LIMIT (dBuV/m)	MARGIN (dB)	ANTENNA FACTOR (dB/m)	CABLE LOSS (dB)	PREAMP FACTOR (dB)	ANTENNA HEIGHT (cm)	TABLE ANGLE (Degree)	REMARK
74.28	22.88	45.76	40	-17.12	8.23	1.11	32.22	174	112	Peak
186.6	18.3	38.54	43.5	-25.2	10.4	1.61	32.25	161	246	Peak
278.94	22.5	38.85	46	-23.5	13.74	2.03	32.12	122	50	Peak
328	31.55	46.17	46	-14.45	15.37	2.11	32.1	109	180	Peak
639.5	24.39	31.52	46	-21.61	22.1	2.93	32.16	100	181	Peak
967.1	36.27	37.55	54	-17.73	25.88	3.67	30.83	196	171	Peak
ANTENNA POLARITY & TEST DISTANCE: VERTICAL AT 3 M										
FREQ. (MHz)	EMISSION LEVEL (dBuV/m)	READ LEVEL (dBuV)	LIMIT (dBuV/m)	MARGIN (dB)	ANTENNA FACTOR (dB/m)	CABLE LOSS (dB)	PREAMP FACTOR (dB)	ANTENNA HEIGHT (cm)	TABLE ANGLE (Degree)	REMARK
74.01	25.94	48.83	40	-14.06	8.22	1.11	32.22	125	174	Peak
193.35	25.35	45.44	43.5	-18.15	10.57	1.61	32.27	193	35	Peak
292.98	28.67	44.92	46	-17.33	13.85	2.03	32.13	103	320	Peak
357.4	29.19	42.65	46	-16.81	16.37	2.26	32.09	157	144	Peak
817.3	29.53	34.45	46	-16.47	23.72	3.32	31.96	153	225	Peak
966.4	41.83	43.04	54	-12.17	25.96	3.67	30.84	196	305	Peak

REMARKS:

1. Emission Level = Read Level + Antenna Factor + Cable Loss - Preamp Factor

Margin value = Emission level – Limit value

4.2 Conducted Emission Measurement

4.2.1 Limits of Conducted Emission Measurement

Frequency (MHz)	Conducted Limit (dBuV)	
	Quasi-peak	Average
0.15 - 0.5	66 - 56	56 - 46
0.50 - 5.0	56	46
5.0 - 30.0	60	50

Note: 1. The lower limit shall apply at the transition frequencies.

2. The limit decreases in line with the logarithm of the frequency in the range of 0.15 to 0.50MHz.

4.2.2 Test Instruments

Description & Manufacturer	Model No.	Serial No.	Date of Calibration	Due Date of Calibration
Test Receiver ROHDE & SCHWARZ	ESCI	100613	Nov. 11, 2014	Nov. 10, 2015
RF signal cable Woken	5D-FB	Cable-cond1-01	Dec. 26, 2014	Dec. 25, 2015
LISN ROHDE & SCHWARZ (EUT)	ESH3-Z5	835239/001	Feb. 26, 2015	Feb. 25, 2016
LISN ROHDE & SCHWARZ (Peripheral)	ESH3-Z5	100311	Jul. 24, 2015	Jul. 23, 2016
Software ADT	BV ADT_Cond_ V7.3.7.3	NA	NA	NA

Note: 1. The calibration interval of the above test instruments is 12 months and the calibrations are traceable to NML/ROC and NIST/USA.

2. The test was performed in HwaYa Shielded Room 1.

3. The VCCI Site Registration No. is C-2040.

4.2.3 Test Procedures

- a. The EUT was placed 0.4 meters from the conducting wall of the shielded room with EUT being connected to the power mains through a line impedance stabilization network (LISN). Other support units were connected to the power mains through another LISN. The two LISNs provide 50 ohm / 50uH of coupling impedance for the measuring instrument.
- b. Both lines of the power mains connected to the EUT were checked for maximum conducted interference.
- c. The frequency range from 150 kHz to 30MHz was searched. Emission levels under (Limit - 20dB) was not recorded.

NOTE: All modes of operation were investigated and the worst-case emissions are reported.

4.2.4 Deviation from Test Standard

No deviation.

4.2.5 Test Setup

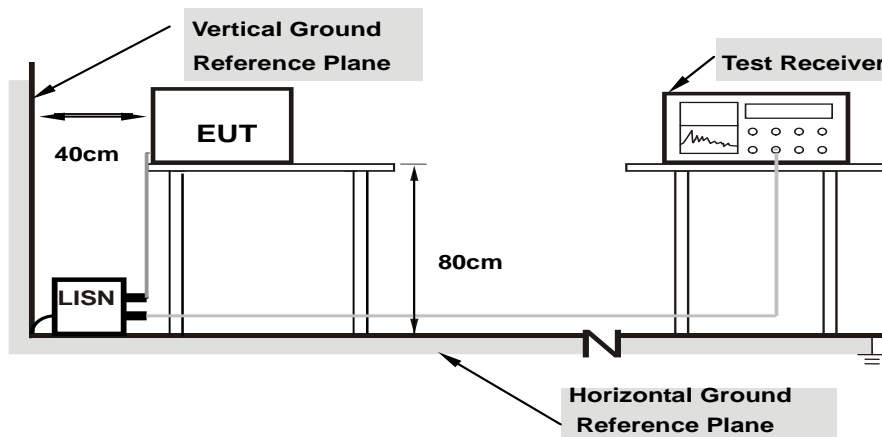

Note: 1.Support units were connected to second LISN.

For the actual test configuration, please refer to the attached file (Test Setup Photo).

4.2.6 EUT Operating Conditions

Same as 4.1.6.

4.2.7 Test Results

Frequency Range	150kHz ~ 30MHz	Detector Function & Resolution Bandwidth	Quasi-Peak (QP) / Average (AV), 9kHz
Input Power	120Vac, 60Hz	Environmental Conditions	25°C, 65%RH
Tested by	Toby Tian	Test Date	2015/10/01

Phase Of Power : Line (L)										
No	Freq. [MHz]	Corr.	Reading Value		Emission Level		Limit		Margin	
		Factor	[dB (uV)]		[dB (uV)]		[dB (uV)]		(dB)	
		(dB)	Q.P.	AV.	Q.P.	AV.	Q.P.	AV.	Q.P.	AV.
1	0.16181	9.86	45.67	32.35	55.53	42.21	65.37	55.37	-9.84	-13.16
2	0.22024	9.93	37.52	25.19	47.45	35.12	62.81	52.81	-15.36	-17.69
3	0.27903	9.92	28.56	16.56	38.48	26.48	60.84	50.84	-22.37	-24.37
4	0.33377	9.91	22.84	10.77	32.75	20.68	59.36	49.36	-26.61	-28.68
5	0.38851	9.90	23.71	12.16	33.61	22.06	58.10	48.10	-24.48	-26.03
6	1.47992	10.06	20.27	11.75	30.33	21.81	56.00	46.00	-25.67	-24.19

REMARKS:

1. Q.P. and AV. are abbreviations of quasi-peak and average individually.
2. The emission levels of other frequencies were very low against the limit.
3. Margin value = Emission level - Limit value
4. Correction factor = Insertion loss + Cable loss
5. Emission Level = Correction Factor + Reading Value.

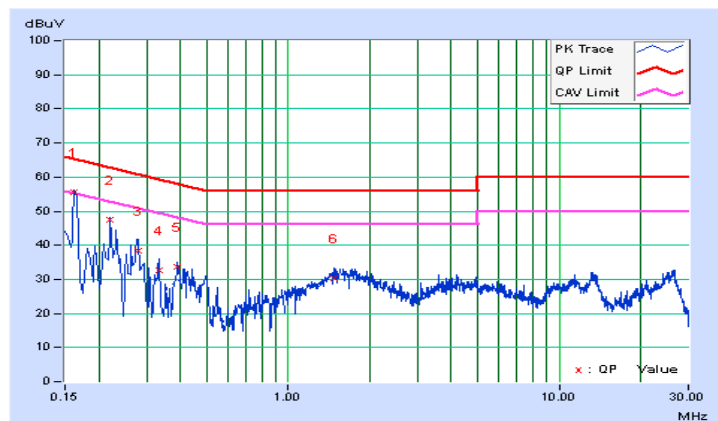

Frequency Range	150kHz ~ 30MHz	Detector Function & Resolution Bandwidth	Quasi-Peak (QP) / Average (AV), 9kHz
Input Power	120Vac, 60Hz	Environmental Conditions	25°C, 65%RH
Tested by	Toby Tian	Test Date	2015/10/01

Phase Of Power : Neutral (N)										
No	Freq. [MHz]	Corr.	Reading Value		Emission Level		Limit		Margin	
		Factor	[dB (uV)]		[dB (uV)]		[dB (uV)]		(dB)	
		(dB)	Q.P.	AV.	Q.P.	AV.	Q.P.	AV.	Q.P.	AV.
1	0.16181	9.92	45.26	28.93	55.18	38.85	65.37	55.37	-10.19	-16.52
2	0.17346	9.96	43.81	26.04	53.77	36.00	64.79	54.79	-11.03	-18.80
3	0.21647	10.03	37.65	21.38	47.68	31.41	62.95	52.95	-15.28	-21.55
4	0.24775	10.02	32.68	14.15	42.70	24.17	61.83	51.83	-19.13	-27.66
5	0.32204	10.01	20.56	7.47	30.57	17.48	59.65	49.65	-29.09	-32.18
6	1.60843	10.07	18.82	10.24	28.89	20.31	56.00	46.00	-27.11	-25.69

REMARKS:

1. Q.P. and AV. are abbreviations of quasi-peak and average individually.
2. The emission levels of other frequencies were very low against the limit.
3. Margin value = Emission level - Limit value
4. Correction factor = Insertion loss + Cable loss
5. Emission Level = Correction Factor + Reading Value.

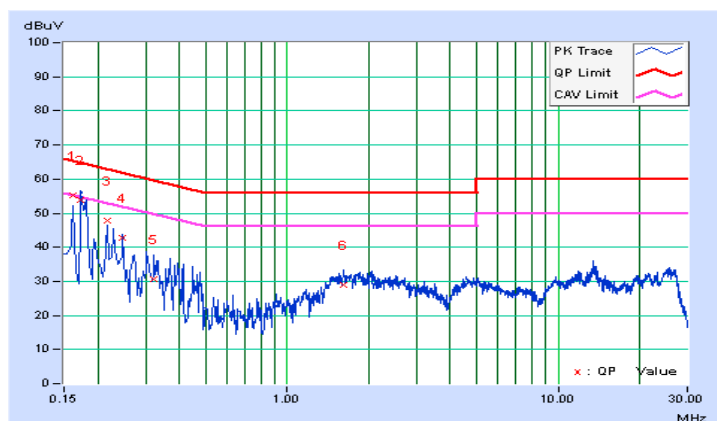

4.3 6dB Bandwidth Measurement

4.3.1 Limits of 6dB Bandwidth Measurement

The minimum of 6dB Bandwidth Measurement is 0.5 MHz.

4.3.2 Test Setup

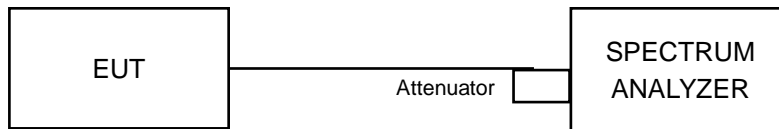

4.3.3 Test Instruments

Refer to section 4.1.2 to get information of above instrument.

4.3.4 Test Procedure

- Set resolution bandwidth (RBW) = 100kHz
- Set the video bandwidth (VBW) $\geq 3 \times$ RBW, Detector = Peak.
- Trace mode = max hold.
- Sweep = auto couple.
- Measure the maximum width of the emission that is constrained by the frequencies associated with the two amplitude points (upper and lower) that are attenuated by 6 dB relative to the maximum level measured in the fundamental emission

4.3.5 Deviation from Test Standard

No deviation.

4.3.6 EUT Operating Conditions

The software provided by client to enable the EUT under transmission condition continuously at lowest, middle and highest channel frequencies individually.

4.3.7 Test Result

802.11b

Channel	Frequency (MHz)	6db Bandwidth (MHz)	Minimum Limit (MHz)	Pass / Fail
1	2412	9.11	0.5	Pass
6	2437	9.59	0.5	Pass
11	2462	9.59	0.5	Pass

802.11g

Channel	Frequency (MHz)	6db Bandwidth (MHz)	Minimum Limit (MHz)	Pass / Fail
1	2412	15.13	0.5	Pass
6	2437	15.17	0.5	Pass
11	2462	15.15	0.5	Pass

802.11n (20MHz)

Channel	Frequency (MHz)	6db Bandwidth (MHz)	Minimum Limit (MHz)	Pass / Fail
1	2412	15.13	0.5	Pass
6	2437	15.16	0.5	Pass
11	2462	15.17	0.5	Pass

802.11n (40MHz)

Channel	Frequency (MHz)	6db Bandwidth (MHz)	Minimum Limit (MHz)	Pass / Fail
3	2422	35.13	0.5	Pass
6	2437	35.13	0.5	Pass
9	2452	35.16	0.5	Pass

Spectrum Plot of Worst Value

802.11b

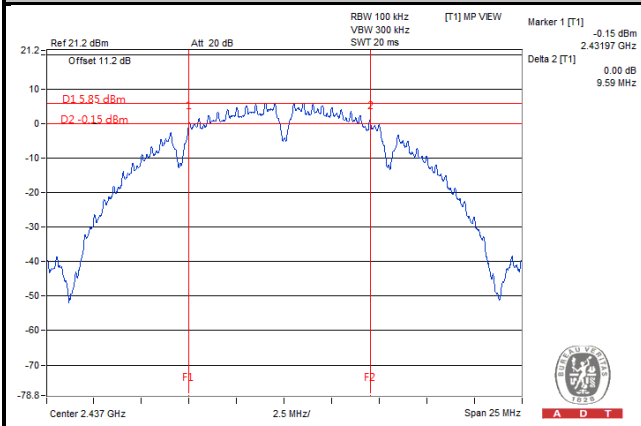

802.11g

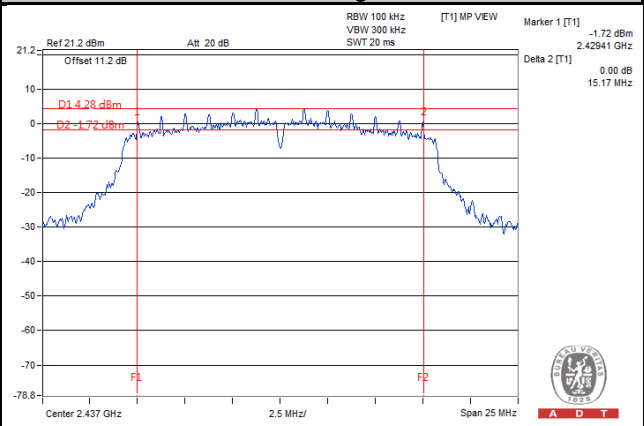

802.11n (20MHz)

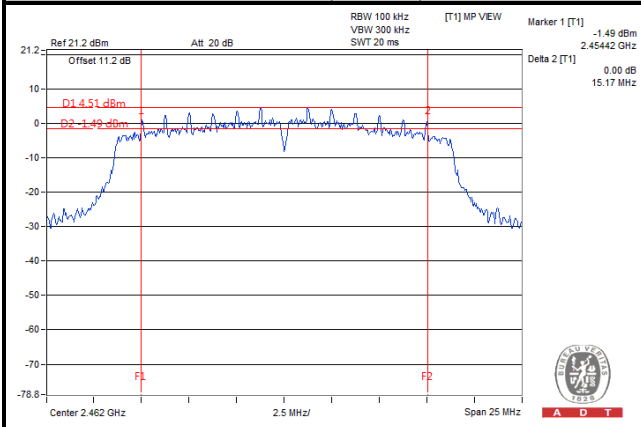

802.11n (40MHz)

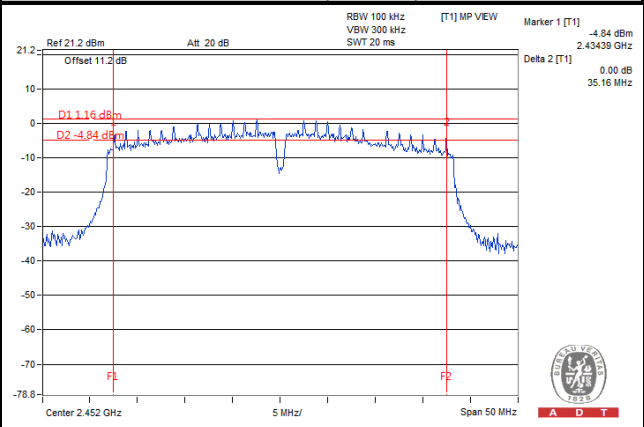

4.4 Conducted Output Power Measurement

4.4.1 Limits of Conducted Output Power Measurement

For systems using digital modulation in the 2400–2483.5 MHz bands: 1 Watt (30dBm)

4.4.2 Test Setup

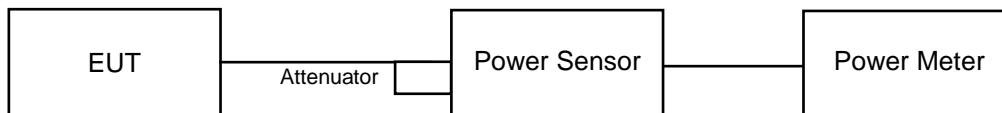

4.4.3 Test Instruments

Refer to section 4.1.2 to get information of above instrument.

4.4.4 Test Procedures

A peak power sensor was used on the output port of the EUT. A power meter was used to read the response of the peak power sensor. Record the power level.

4.4.5 Deviation from Test Standard

No deviation.

4.4.6 EUT Operating Conditions

Same as 4.3.6.

4.4.7 Test Results

802.11b

Channel	Frequency (MHz)	Peak Power (mW)	Peak Power (dBm)	Limit (dBm)	Pass / Fail
1	2412	65.16	18.14	30	Pass
6	2437	65.92	18.19	30	Pass
11	2462	66.22	18.21	30	Pass

802.11g

Channel	Frequency (MHz)	Peak Power (mW)	Peak Power (dBm)	Limit (dBm)	Pass / Fail
1	2412	196.79	22.94	30	Pass
6	2437	201.37	23.04	30	Pass
11	2462	204.17	23.1	30	Pass

802.11n (20MHz)

Channel	Frequency (MHz)	Peak Power (mW)	Peak Power (dBm)	Limit (dBm)	Pass / Fail
1	2412	195.43	22.91	30	Pass
6	2437	206.06	23.14	30	Pass
11	2462	194.54	22.89	30	Pass

802.11n (40MHz)

Channel	Frequency (MHz)	Peak Power (mW)	Peak Power (dBm)	Limit (dBm)	Pass / Fail
3	2422	174.58	22.42	30	Pass
6	2437	167.11	22.23	30	Pass
9	2452	164.82	22.17	30	Pass

4.5 Power Spectral Density Measurement

4.5.1 Limits of Power Spectral Density Measurement

The Maximum of Power Spectral Density Measurement is 8dBm.

4.5.2 Test Setup

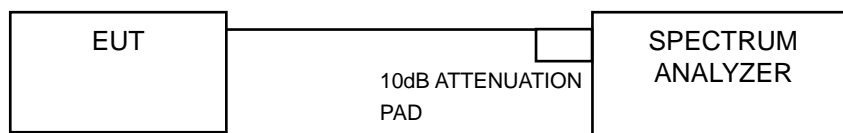

4.5.3 Test Instruments

Refer to section 4.1.2 to get information of above instrument.

4.5.4 Test Procedure

- Set analyzer center frequency to DTS channel center frequency.
- Set the span to 1.5 times the DTS bandwidth.
- Set the RBW to: $3 \text{ kHz} \leq \text{RBW} \leq 100 \text{ kHz}$.
- Set the VBW $\geq 3 \times \text{RBW}$.
- Detector = peak.
- Sweep time = auto couple.
- Trace mode = max hold.
- Allow trace to fully stabilize.
- Use the peak marker function to determine the maximum amplitude level within the RBW.

4.5.5 Deviation from Test Standard

No deviation.

4.5.6 EUT Operating Condition

Same as Item 4.3.6

4.5.7 Test Results

802.11b

Channel	Frequency (MHz)	PSD (dBm)	Limit (dBm)	Pass / Fail
1	2412	-9.52	8	Pass
6	2437	-9.38	8	Pass
11	2462	-9.32	8	Pass

802.11g

Channel	Frequency (MHz)	PSD (dBm)	Limit (dBm)	Pass / Fail
1	2412	-11.60	8	Pass
6	2437	-10.49	8	Pass
11	2462	-11.88	8	Pass

802.11n (20MHz)

Channel	Frequency (MHz)	PSD (dBm)	Limit (dBm)	Pass / Fail
1	2412	-10.47	8	Pass
6	2437	-11.22	8	Pass
11	2462	-11.45	8	Pass

802.11n (40MHz)

Channel	Frequency (MHz)	PSD (dBm)	Limit (dBm)	Pass / Fail
3	2422	-15.62	8	Pass
6	2437	-15.18	8	Pass
9	2452	-15.71	8	Pass

Spectrum Plot of Worst Value

802.11b

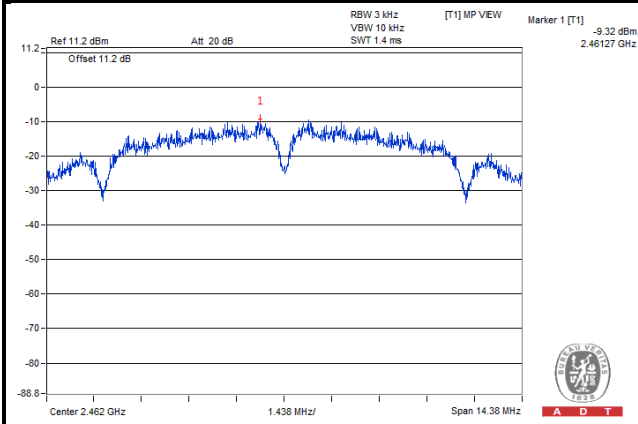

802.11g

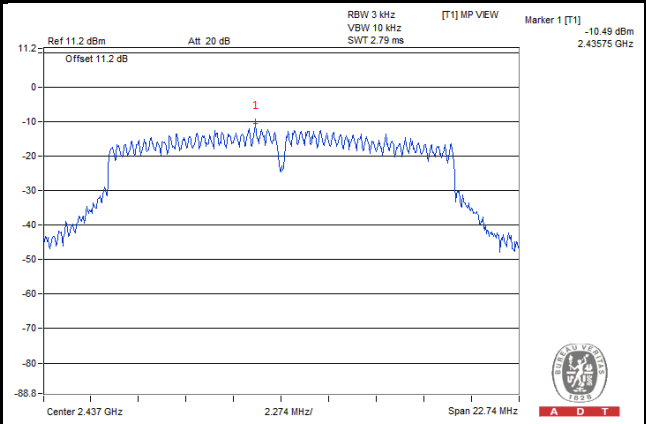

802.11n (20MHz)

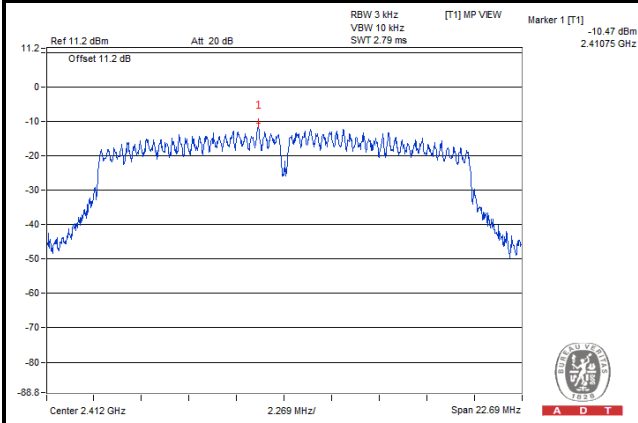

802.11n (40MHz)

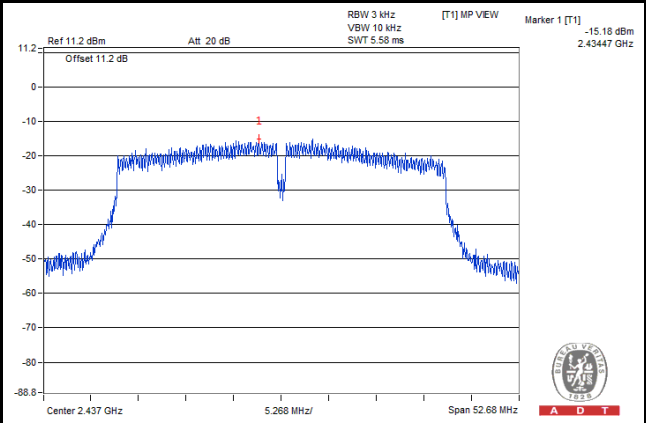

4.6 Conducted Out of Band Emission Measurement

4.6.1 Limits of Conducted Out of Band Emission Measurement

Below 20dB of the highest emission level of operating band (in 100kHz Resolution Bandwidth).

4.6.2 Test Setup

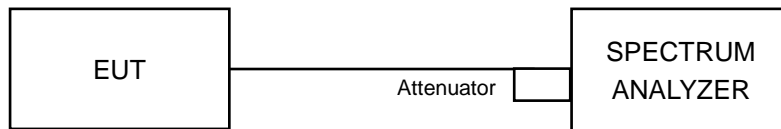

4.6.3 Test Instruments

Refer to section 4.1.2 to get information of above instrument.

4.6.4 Test Procedure

MEASUREMENT PROCEDURE REF

1. Set the RBW = 100 kHz.
2. Set the VBW \geq 300 kHz.
3. Detector = peak.
4. Sweep time = auto couple.
5. Trace mode = max hold.
6. Allow trace to fully stabilize.
7. Use the peak marker function to determine the maximum power level in any 100 kHz band segment within the fundamental EBW.

MEASUREMENT PROCEDURE OOB

1. Set RBW = 100 kHz.
2. Set VBW \geq 300 kHz.
3. Detector = peak.
4. Sweep = auto couple.
5. Trace Mode = max hold.
6. Allow trace to fully stabilize.
7. Use the peak marker function to determine the maximum amplitude level.

4.6.5 Deviation from Test Standard

No deviation.

4.6.6 EUT Operating Condition

Same as Item 4.3.6

4.6.7 Test Results

The spectrum plots are attached on the following images. D1 line indicates the highest level, and D2 line indicates the 20dB offset below D1. It shows compliance with the requirement.

802.11b

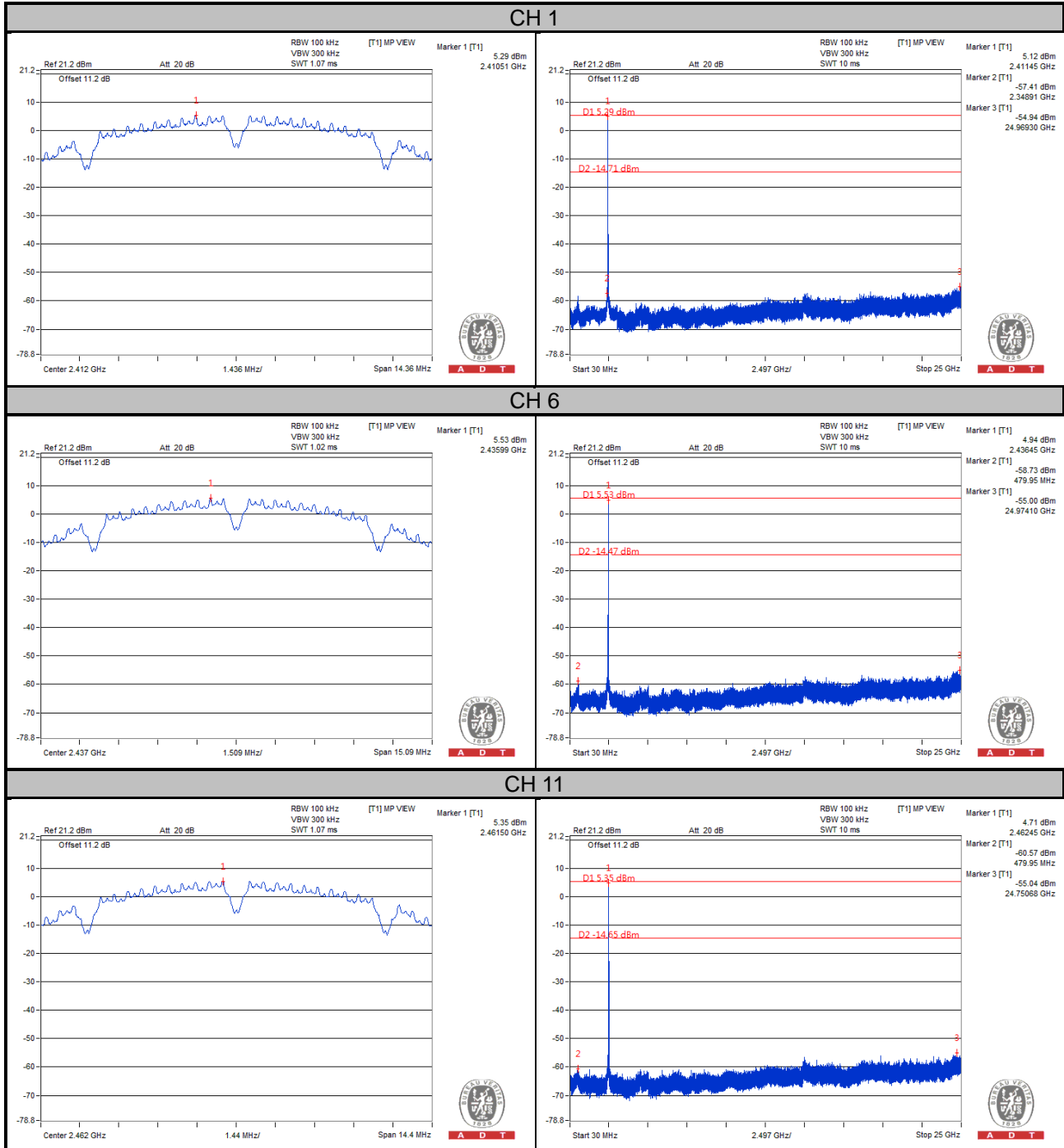

CH 1 Band Edge

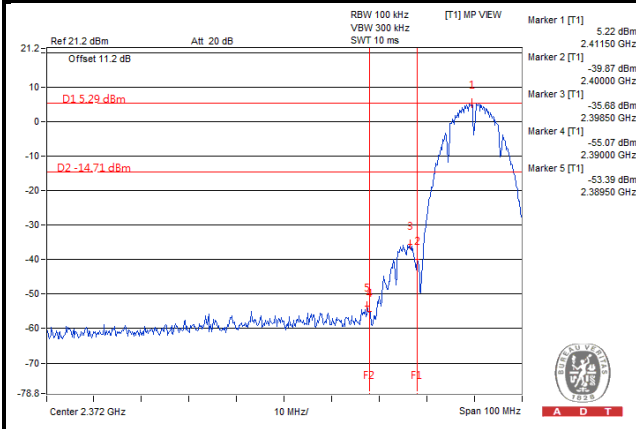

CH 11 Band Edge

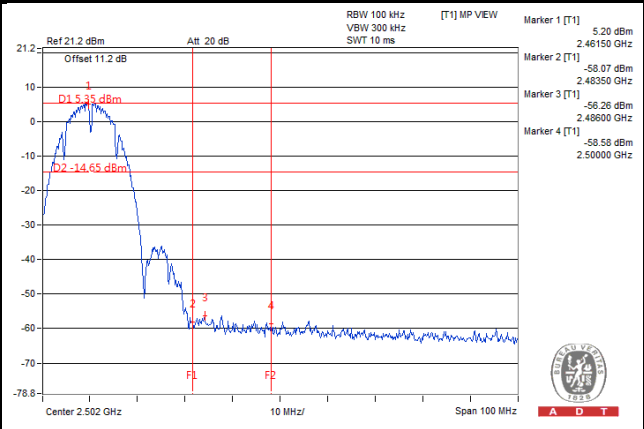

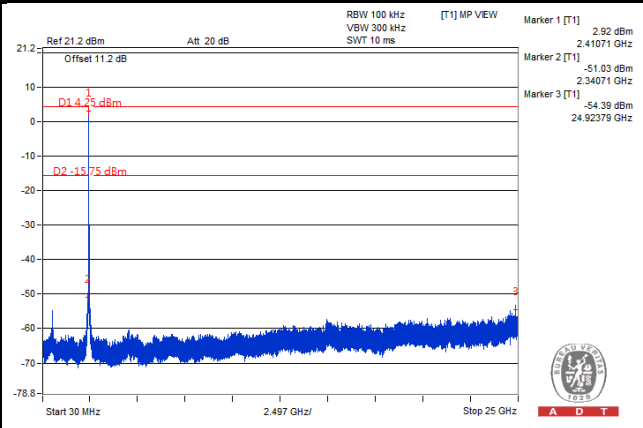
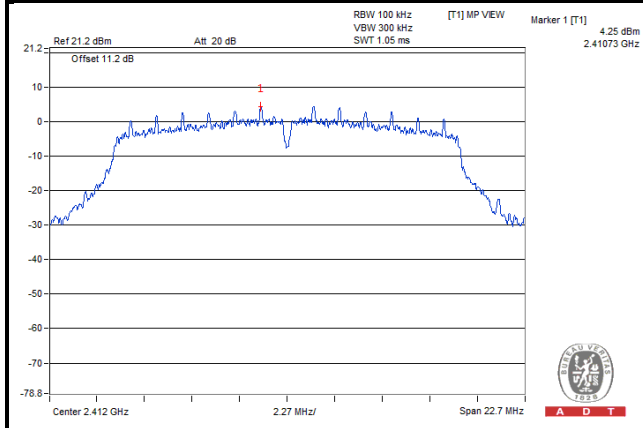
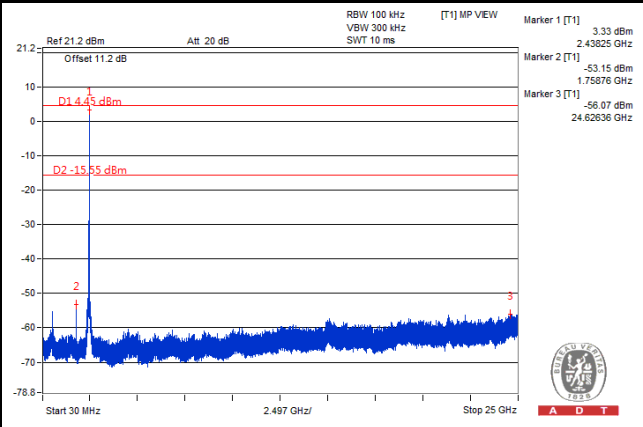
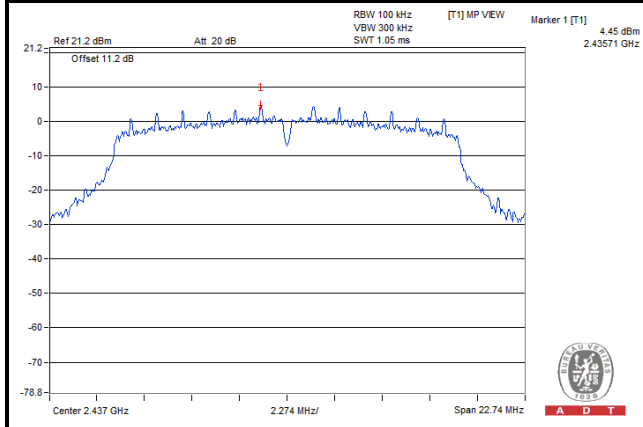
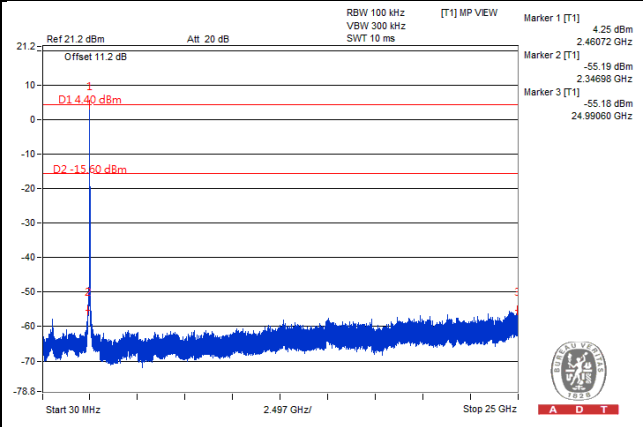
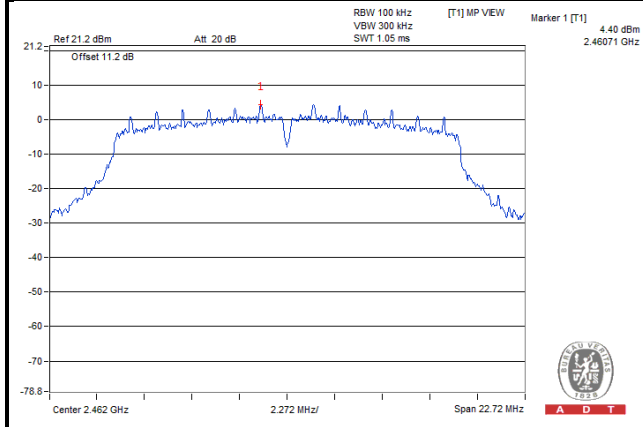
802.11g**CH 1****CH 6****CH 11**

CH 1 Band Edge

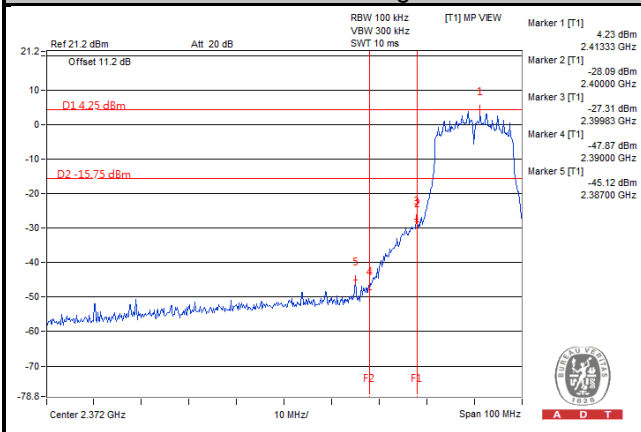

CH 11 Band Edge

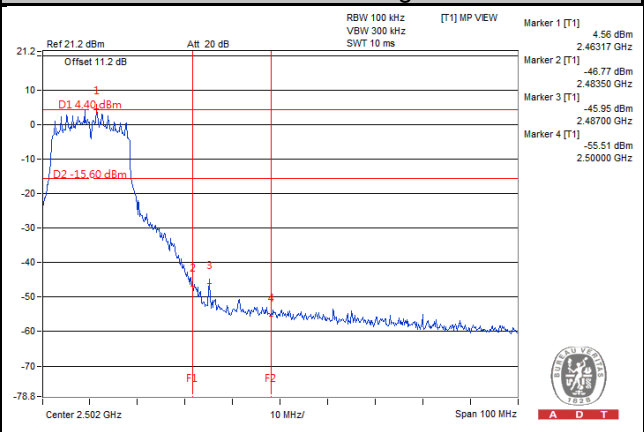

802.11n (20MHz)

CH 1

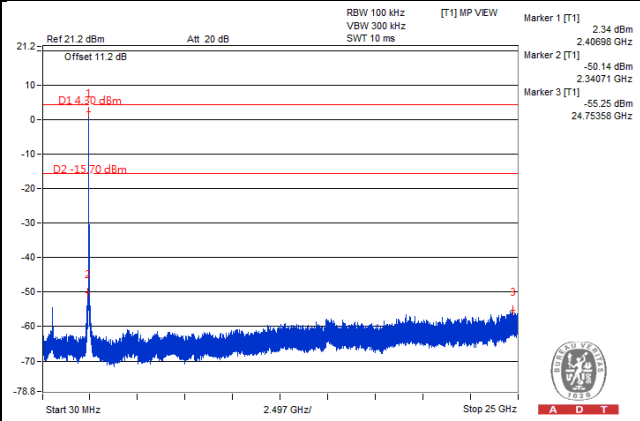
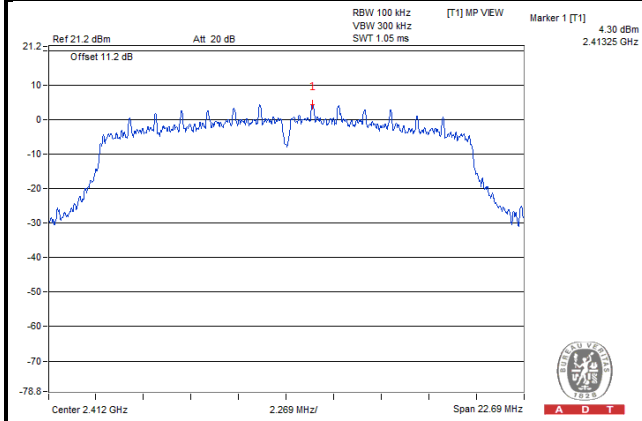

CH 6

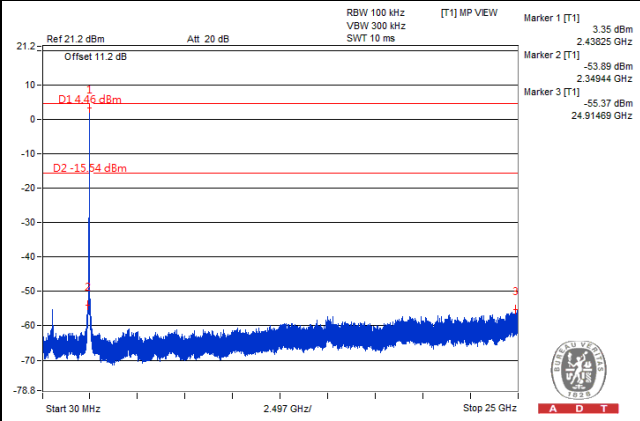
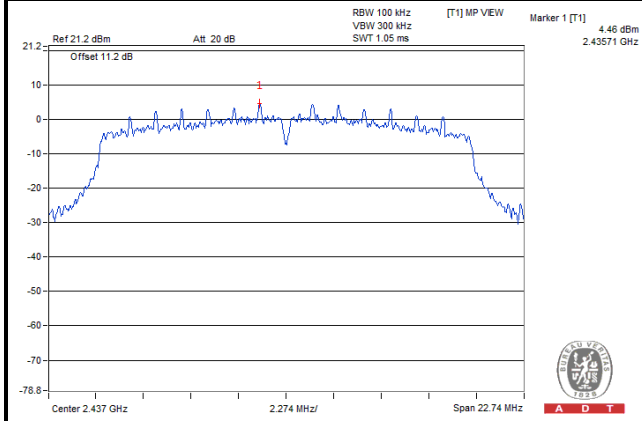

CH 11

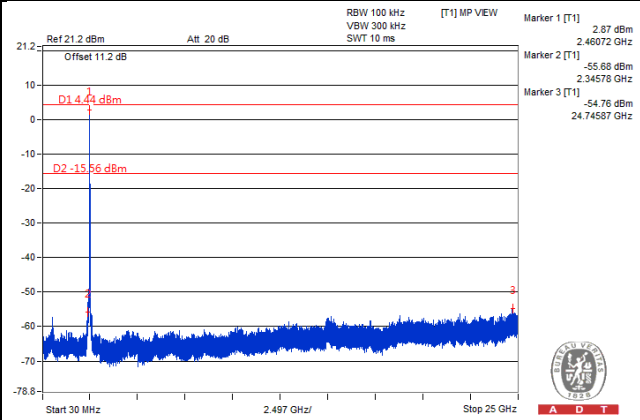
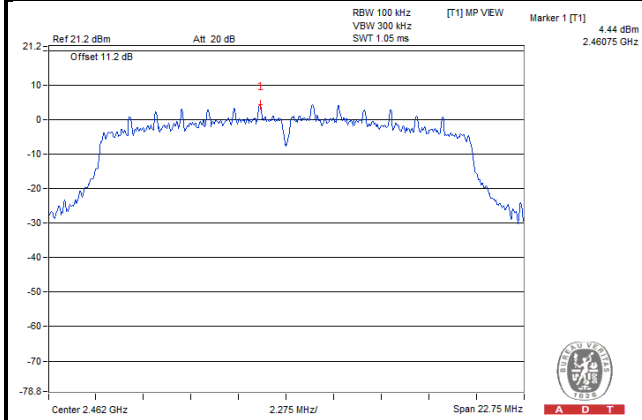

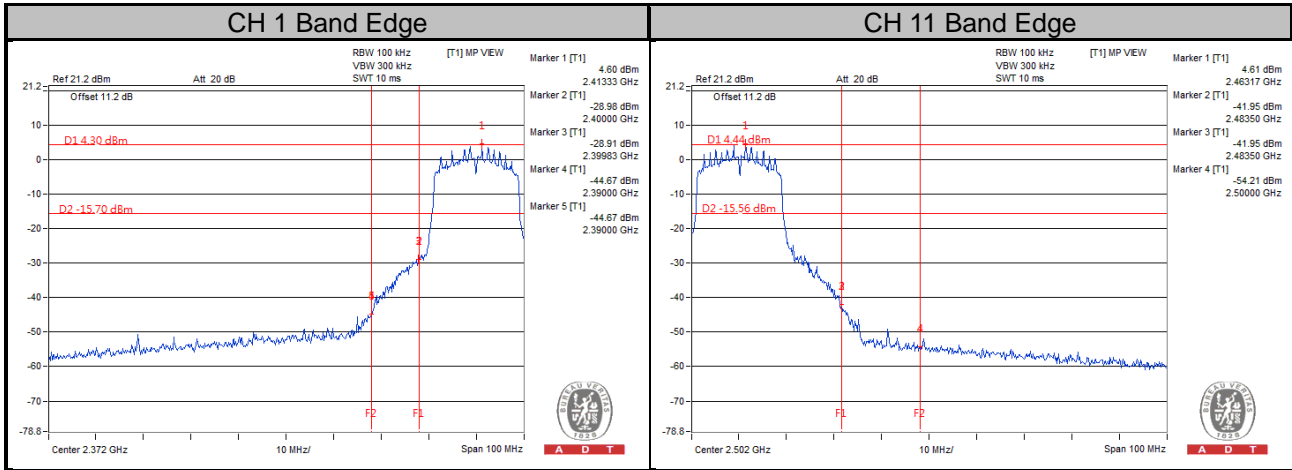

802.11n (40MHz)

CH 3

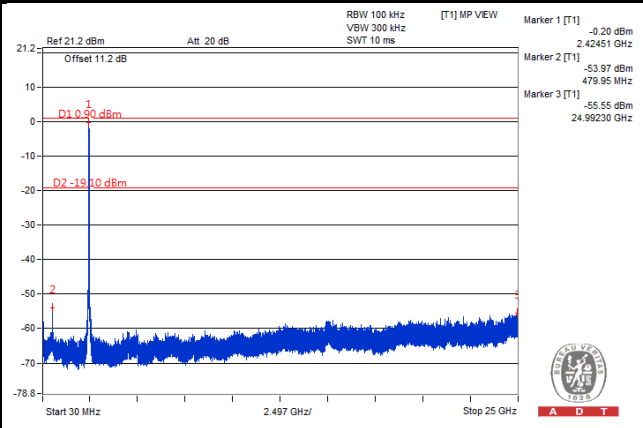
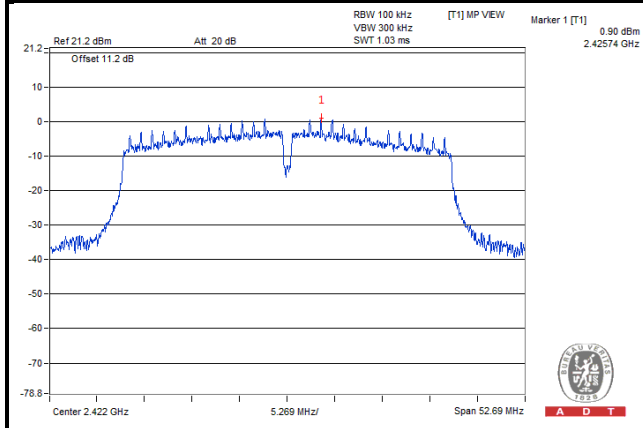

CH 6

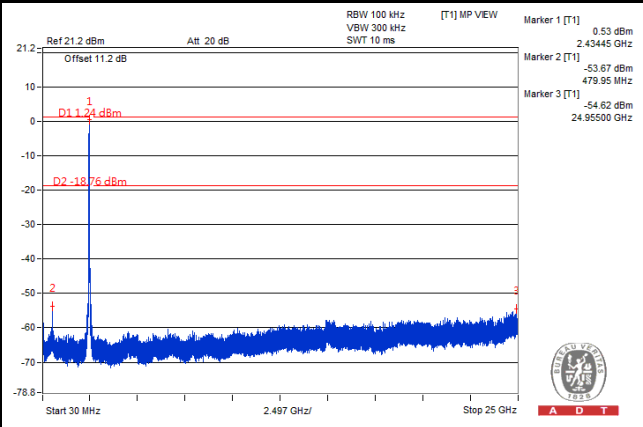
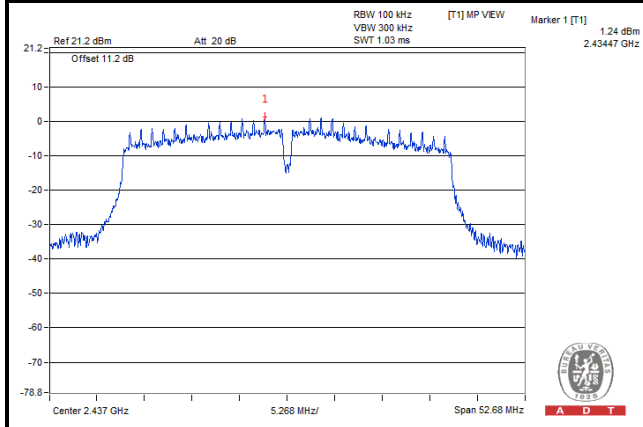

CH 9

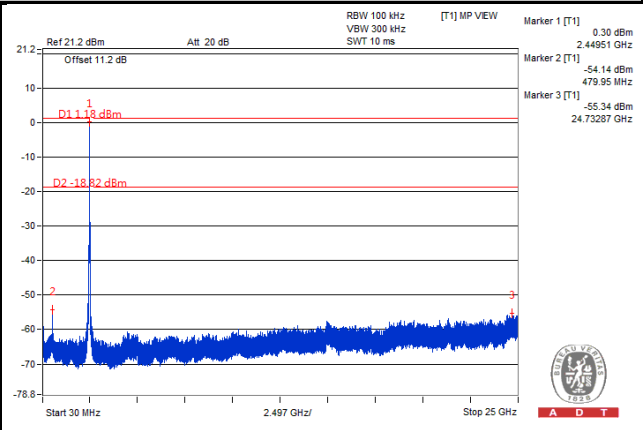
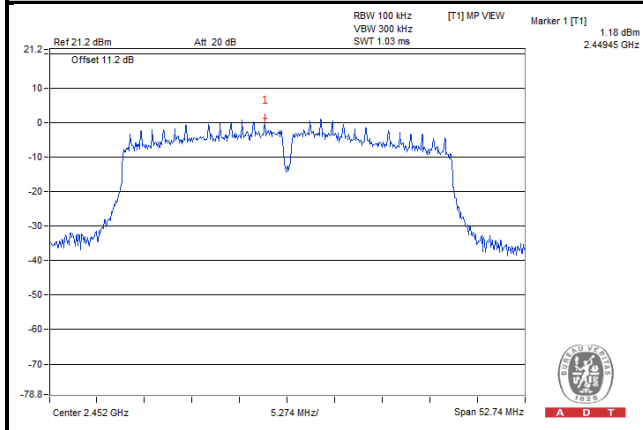

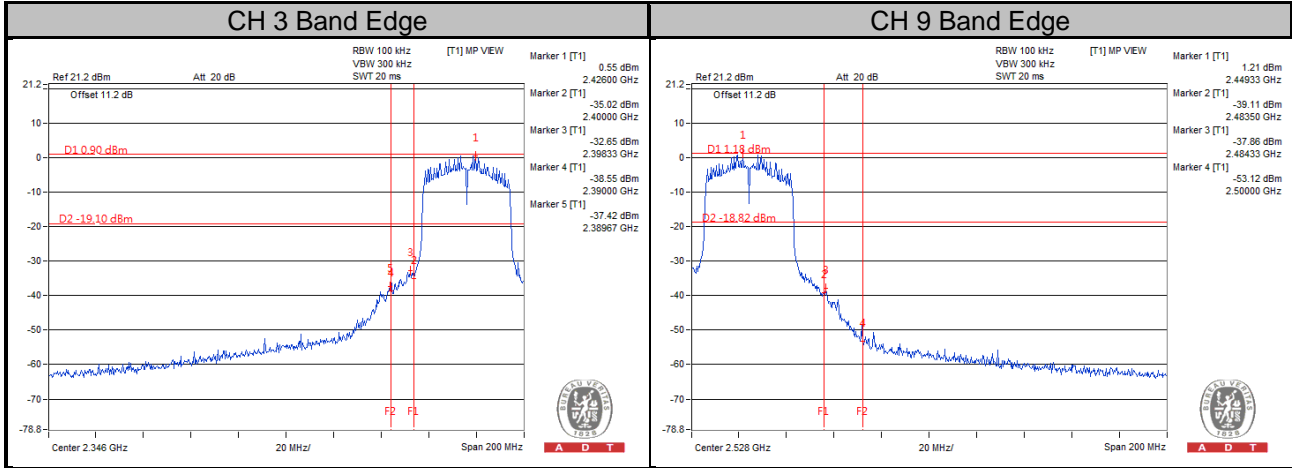



5 Pictures of Test Arrangements

Please refer to the attached file (Test Setup Photo).



A D T

Appendix – Information on the Testing Laboratories

We, Bureau Veritas Consumer Products Services (H.K.) Ltd., Taoyuan Branch, were founded in 1988 to provide our best service in EMC, Radio, Telecom and Safety consultation. Our laboratories are accredited and approved according to ISO/IEC 17025.

If you have any comments, please feel free to contact us at the following:

Linko EMC/RF Lab

Tel: 886-2-26052180

Fax: 886-2-26051924

Hsin Chu EMC/RF/Telecom Lab

Tel: 886-3-5935343

Fax: 886-3-5935342

Hwa Ya EMC/RF/Safety Lab

Tel: 886-3-3183232

Fax: 886-3-3270892

Email: service.adt@tw.bureauveritas.com

Web Site: www.bureauveritas-adt.com

The address and road map of all our labs can be found in our web site also.

--- END ---