



SPORTON International Inc.

No. 52, Hwa Ya 1st Rd., Hwa Ya Technology Park, Kwei-Shan Hsiang, Tao Yuan Hsien, Taiwan, R.O.C.
Ph: 886-3-327-3456 / FAX: 886-3-327-0973 / www.sporton.com.tw

FCC RADIO TEST REPORT

Applicant's company	AirTies Wireless Networks
Applicant Address	Gülbahar Mah. Avni Dilligil Sok. Celik Is Merkezi ISTANBUL, 34394 Turkey
FCC ID	Z3WAIR49200
Manufacturer's company	SHENZHEN GONGJIN ELECTRONICS CO.,LTD.
Manufacturer Address	2F/3F/4F Baiying Building, 1019#Naihui RD, Nanshan Dist., Shenzhen, Guangdong, CHINA

Product Name	2 Port Gigabit Ethernet 11ac/11n Wireless Router
Brand Name	AirTies
Model No.	Air 4920
Test Rule Part(s)	47 CFR FCC Part 15 Subpart E § 15.407
Test Freq. Range	5250 ~ 5350MHz / 5470 ~ 5725MHz
Received Date	Oct. 22, 2014
Final Test Date	Jul. 09, 2015
Submission Type	Class II Change

Statement

Test result included is for the IEEE 802.11n and IEEE 802.11a/ac of the product.

The test result in this report refers exclusively to the presented test model / sample.

Without written approval of SPORTON International Inc., the test report shall not be reproduced except in full.

The measurements and test results shown in this test report were made in accordance with the procedures and found in compliance with the limit given in **ANSI C63.10-2013, 47 CFR FCC Part 15 Subpart E, KDB789033 D02 v01, KDB662911 D01 v02r01, KDB644545 D03 v01.**

The test equipment used to perform the test is calibrated and traceable to NML/ROC.



Table of Contents

1. VERIFICATION OF COMPLIANCE	1
2. SUMMARY OF THE TEST RESULT	2
3. GENERAL INFORMATION	3
3.1. Product Details.....	3
3.2. Accessories.....	5
3.3. Table for Filed Antenna.....	6
3.4. Table for Carrier Frequencies	7
3.5. Table for Test Modes.....	8
3.6. Table for Testing Locations.....	10
3.7. Table for Class II Change	10
3.8. Table for Supporting Units	10
3.9. Table for Parameters of Test Software Setting	11
3.10. EUT Operation during Test	11
3.11. Duty Cycle.....	12
3.12. Test Configurations	13
4. TEST RESULT	15
4.1. 26dB Bandwidth and 99% Occupied Bandwidth Measurement.....	15
4.2. Maximum Conducted Output Power Measurement.....	28
4.3. Power Spectral Density Measurement	31
4.4. Radiated Emissions Measurement	39
4.5. Band Edge Emissions Measurement	61
4.6. Frequency Stability Measurement	70
4.7. Antenna Requirements	74
5. LIST OF MEASURING EQUIPMENTS	75
6. MEASUREMENT UNCERTAINTY	76
APPENDIX A. TEST PHOTOS	A1 ~ A2
APPENDIX B. MAXIMUM PERMISSIBLE EXPOSURE	B1 ~ B4



History of This Test Report

REPORT NO.	VERSION	DESCRIPTION	ISSUED DATE
FR552501-01	Rev. 01	Initial issue of report	Jul. 22, 2015



1. VERIFICATION OF COMPLIANCE

Product Name : 2 Port Gigabit Ethernet 11ac/11n Wireless Router
Brand Name : AirTies
Model No. : Air 4920
Applicant : AirTies Wireless Networks
Test Rule Part(s) : 47 CFR FCC Part 15 Subpart E § 15.407

Sporton International as requested by the applicant to evaluate the EMC performance of the product sample received on Oct. 22, 2014 would like to declare that the tested sample has been evaluated and found to be in compliance with the tested rule parts. The data recorded as well as the test configuration specified is true and accurate for showing the sample's EMC nature.

A handwritten signature in blue ink, appearing to read "Sam Chen", written over a horizontal line.

Sam Chen

SPORTON INTERNATIONAL INC.

2. SUMMARY OF THE TEST RESULT

Applied Standard: 47 CFR FCC Part 15 Subpart E				
Part	Rule Section	Description of Test	Result	Under Limit
4.1	15.407(a)	26dB Spectrum Bandwidth and 99% Occupied Bandwidth	Complies	-
4.2	15.407(a)	Maximum Conducted Output Power	Complies	0.07 dB
4.3	15.407(a)	Power Spectral Density	Complies	0.14 dB
4.4	15.407(b)	Radiated Emissions	Complies	4.68 dB
4.5	15.407(b)	Band Edge Emissions	Complies	0.01 dB
4.6	15.407(g)	Frequency Stability	Complies	-
4.7	15.203	Antenna Requirements	Complies	-

3. GENERAL INFORMATION

3.1. Product Details

Items	Description
Product Type	IEEE 802.11a: WLAN (1TX, 1RX) IEEE 802.11n: WLAN (3TX, 3RX) IEEE 802.11ac: WLAN (3TX, 3RX)
Radio Type	Intentional Transceiver
Power Type	From power adapter
Modulation	IEEE 802.11a: OFDM IEEE 802.11n/ac: see the below table
Data Modulation	IEEE 802.11a/n: OFDM (BPSK / QPSK / 16QAM / 64QAM) IEEE 802.11ac: OFDM (BPSK / QPSK / 16QAM / 64QAM / 256QAM)
Data Rate (Mbps)	IEEE 802.11a: OFDM (6/9/12/18/24/36/48/54) IEEE 802.11n/ac: see the below table
Frequency Range	5250 ~ 5350MHz / 5470 ~ 5725MHz
Channel Number	12 for 20MHz bandwidth ; 5 for 40MHz bandwidth 2 for 80MHz bandwidth
Channel Band Width (99%)	<p>Band 2:</p> <p><u>For non-beamforming mode:</u> IEEE 802.11a: 28.05 MHz</p> <p><u>For beamforming mode:</u> IEEE 802.11ac MCS0/Nss1 (VHT20): 17.97 MHz IEEE 802.11ac MCS0/Nss1 (VHT40): 36.76 MHz IEEE 802.11ac MCS0/Nss1 (VHT80): 75.83 MHz</p> <p>Band 3:</p> <p><u>For non-beamforming mode:</u> IEEE 802.11a: 26.74 MHz</p> <p><u>For beamforming mode:</u> IEEE 802.11ac MCS0/Nss1 (VHT20): 17.97 MHz IEEE 802.11ac MCS0/Nss1 (VHT40): 36.76 MHz IEEE 802.11ac MCS0/Nss1 (VHT80): 75.83 MHz</p>

Maximum Conducted Output Power	<p>Band 2:</p> <p><u>For non-beamforming mode:</u></p> <p>IEEE 802.11a: 23.83 dBm</p> <p><u>For beamforming mode:</u></p> <p>IEEE 802.11ac MCS0/Nss1 (VHT20): 23.91 dBm</p> <p>IEEE 802.11ac MCS0/Nss1 (VHT40): 23.86 dBm</p> <p>IEEE 802.11ac MCS0/Nss1 (VHT80): 21.06 dBm</p> <p>Band 3:</p> <p><u>For non-beamforming mode:</u></p> <p>IEEE 802.11a: 23.89 dBm</p> <p><u>For beamforming mode:</u></p> <p>IEEE 802.11ac MCS0/Nss1 (VHT20): 23.86 dBm</p> <p>IEEE 802.11ac MCS0/Nss1 (VHT40): 23.93 dBm</p> <p>IEEE 802.11ac MCS0/Nss1 (VHT80): 20.82 dBm</p>
Carrier Frequencies	Please refer to section 3.4
Antenna	Please refer to section 3.3

Items	Description	
Communication Mode	<input checked="" type="checkbox"/> IP Based (Load Based)	<input type="checkbox"/> Frame Based
TPC Function	<input checked="" type="checkbox"/> With TPC	<input type="checkbox"/> Without TPC
Weather Band (5600~5650MHz)	<input type="checkbox"/> With 5600~5650MHz	<input checked="" type="checkbox"/> Without 5600~5650MHz
Beamforming Function	<input checked="" type="checkbox"/> With beamforming	<input type="checkbox"/> Without beamforming
Operating Mode	<input type="checkbox"/> Outdoor access point	
	<input checked="" type="checkbox"/> Indoor access point	
	<input type="checkbox"/> Fixed point-to-point access points	
	<input type="checkbox"/> Mobile and portable client devices	

Note: The product has beamforming function for 802.11n/ac in 5GHz.

Antenna and Band width

Antenna	Single (TX)			Three (TX)		
	20 MHz	40 MHz	80 MHz	20 MHz	40 MHz	80 MHz
IEEE 802.11a	V	X	X	X	X	X
IEEE 802.11n	X	X	X	V	V	X
IEEE 802.11ac	X	X	X	V	V	V

IEEE 11n/ac Spec.

Protocol	Number of Transmit Chains (NTX)	Data Rate / MCS
802.11n (HT20)	3	MCS 0-23
802.11n (HT40)	3	MCS 0-23
802.11ac (VHT20)	3	MCS 0-9/Nss1-3
802.11ac (VHT40)	3	MCS 0-9/Nss1-3
802.11ac (VHT80)	3	MCS 0-9/Nss1-3

Note 1: IEEE Std. 802.11n modulation consists of HT20 and HT40 (HT: High Throughput).
Then EUT supports HT20 and HT40.

Note 2: IEEE Std. 802.11ac modulation consists of VHT20, VHT40, VHT80 and VHT160 (VHT: Very High Throughput). Then EUT supports VHT20, VHT40 and VHT80.

Note 3: Modulation modes consist of below configuration:
HT20/HT40: IEEE 802.11n, VHT20/VHT40/VHT80: IEEE 802.11ac

3.2. Accessories

Power	Brand	Model	Rating
Adapter	MOSO	MSP-C1000IC12.0-12B-US	INPUT: 100-240V~50/60Hz, 0.5A max. OUTPUT: 12.0V, 1A

3.3. Table for Filed Antenna

Ant.	Brand	Model Name	Antenna Type	Connector	Gain (dBi)	
					2.4GHz	5GHz
1	-	-	PCB Antenna	N/A	2.5	-
2	Airgain	N2420S-T-G50U	PIFA Antenna	I-PEX	2.5	-
3	-	-	PCB Antenna	N/A	-	0
4	-	-	PCB Antenna	N/A	-	0
5	-	-	PCB Antenna	N/A	-	0

Note: The EUT has five antennas. There are two antennas for 2.4GHz and three antennas for 5GHz.

For 2.4GHz band:

For 802.11b/g mode:

Only Chain 1 could transmit/receive simultaneously.

For 802.11n mode:

Chain 1 and Chain 2 could transmit/receive simultaneously.

For 5GHz band:

For 802.11a mode:

Only Chain 3 could transmit/receive simultaneously.

For 802.11n/ac mode:

Chain 3, Chain 4 and Chain 5 could transmit/receive simultaneously.

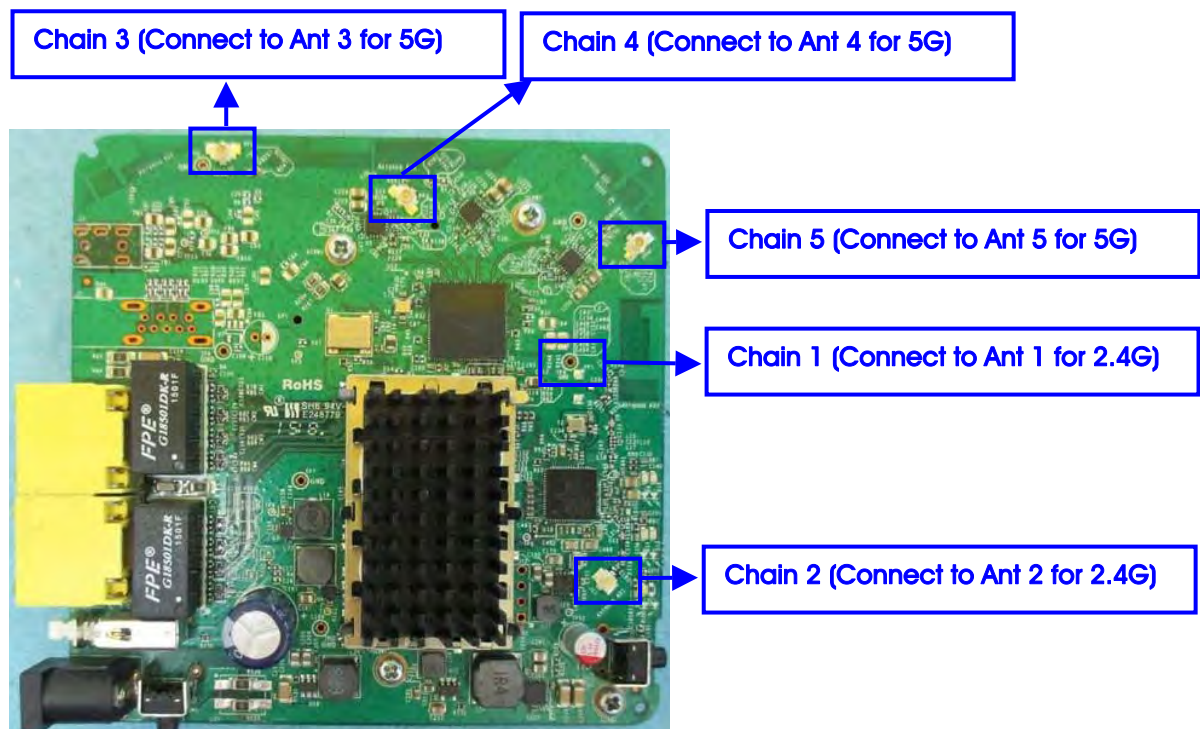

3.4. Table for Carrier Frequencies

There are three bandwidth systems.

For 20MHz bandwidth systems, use Channel 52, 56, 60, 64, 100, 104, 108, 112, 116, 132, 136, 140.

For 40MHz bandwidth systems, use Channel 54, 62, 102, 110, 134.

For 80MHz bandwidth systems, use Channel 58, 106.

Frequency Band	Channel No.	Frequency	Channel No.	Frequency
5250~5350 MHz Band 2	52	5260 MHz	60	5300 MHz
	54	5270 MHz	62	5310 MHz
	56	5280 MHz	64	5320 MHz
	58	5290 MHz	-	-
5470~5725 MHz Band 3	100	5500 MHz	112	5560 MHz
	102	5510 MHz	116	5580 MHz
	104	5520 MHz	132	5660 MHz
	106	5530 MHz	134	5670 MHz
	108	5540 MHz	136	5680 MHz
	110	5550 MHz	140	5700 MHz

3.5. Table for Test Modes

Preliminary tests were performed in different data rate to find the worst radiated emission. The data rate shown in the table below is the worst-case rate with respect to the specific test item. Investigation has been done on all the possible configurations for searching the worst cases. The following table is a list of the test modes shown in this test report.

Test Items	Mode		Data Rate	Channel	Chain
Max. Conducted Output Power	<u>For non-beamforming mode:</u>				
	11a/BPSK	Band 2-3	6Mbps	52/60/64/100/ 116/140	3
	<u>For beamforming mode:</u>				
	11ac VHT20	Band 2-3	MCS0/Nss1	52/60/64/100/ 116/140	3+4+5
	11ac VHT40	Band 2-3	MCS0/Nss1	54/62/102/110/ 134	3+4+5
	11ac VHT80	Band 2-3	MCS0/Nss1	58/106	3+4+5
Power Spectral Density	<u>For non-beamforming mode:</u>				
	11a/BPSK	Band 2-3	6Mbps	52/60/64/100/ 116/140	3
	<u>For beamforming mode:</u>				
	11ac VHT20	Band 2-3	MCS0/Nss1	52/60/64/100/ 116/140	3+4+5
	11ac VHT40	Band 2-3	MCS0/Nss1	54/62/102/110/ 134	3+4+5
	11ac VHT80	Band 2-3	MCS0/Nss1	58/106	3+4+5
26dB Spectrum Bandwidth 99% Occupied Bandwidth Measurement	<u>For non-beamforming mode:</u>				
	11a/BPSK	Band 2-3	6Mbps	52/60/64/100/ 116/140	3
	<u>For beamforming mode:</u>				
	11ac VHT20	Band 2-3	MCS0/Nss1	52/60/64/100/ 116/140	3+4+5
	11ac VHT40	Band 2-3	MCS0/Nss1	54/62/102/110/ 134	3+4+5
	11ac VHT80	Band 2-3	MCS0/Nss1	58/106	3+4+5

Radiated Emission Above 1GHz	<u>For non-beamforming mode:</u>				
	11a/BPSK	Band 2-3	6Mbps	52/60/64/100/ 116/140	3
	<u>For beamforming mode:</u>				
	11ac VHT20	Band 2-3	MCS0/Nss1	52/60/64/100/ 116/140	3+4+5
	11ac VHT40	Band 2-3	MCS0/Nss1	54/62/102/110/ 134	3+4+5
	11ac VHT80	Band 2-3	MCS0/Nss1	58/106	3+4+5
Band Edge Emission	<u>For non-beamforming mode:</u>				
	11a/BPSK	Band 2-3	6Mbps	52/60/64/100/ 116/140	3
	<u>For beamforming mode:</u>				
	11ac VHT20	Band 2-3	MCS0/Nss1	52/60/64/100/ 116/140	3+4+5
	11ac VHT40	Band 2-3	MCS0/Nss1	54/62/102/110/ 134	3+4+5
	11ac VHT80	Band 2-3	MCS0/Nss1	58/106	3+4+5
Frequency Stability	20 MHz	Band 2-3	-	60/116	3+4+5
	40 MHz	Band 2-3	-	62/110	3+4+5
	80 MHz	Band 2-3	-	58/106	3+4+5

Note: 1. VHT20/VHT40 covers HT20/HT40, due to same modulation. The power setting for 802.11n HT20 and HT40 are the same or lower than 802.11ac VHT20 and VHT40.

2. There are two modes of EUT, one is beamforming mode, and the other is non-beamforming mode for 802.11n/ac in 5GHz, after evaluating, beamforming mode has been evaluated to be the worst case, so it was selected to test and record in this test report.

3.6. Table for Testing Locations

Test Site Location					
Address:	No.8, Lane 724, Bo-ai St., Jhubei City, Hsinchu County 302, Taiwan, R.O.C.				
TEL:	886-3-656-9065				
FAX:	886-3-656-9085				
Test Site No.	Site Category	Location	FCC Reg. No.	IC File No.	VCCI Reg. No
03CH01-CB	SAC	Hsin Chu	262045	IC 4086D	-
TH01-CB	OVEN Room	Hsin Chu	-	-	-

Open Area Test Site (OATS); Semi Anechoic Chamber (SAC).

3.7. Table for Class II Change

This product is an extension of original one reported under Sporton project number: FR552501

Below is the table for the change of the product with respect to the original one.

Modifications	Performance Checking
Adding Band 2 and Band 3 (5250~5350 MHz, 5470~5725 MHz) for this device.	<ol style="list-style-type: none"> 1. Max. Conducted Output Power. 2. Power Spectral Density. 3. 26dB Spectrum Bandwidth. 4. 99% Occupied Bandwidth Measurement. 5. Radiated Emission Above 1GHz. 6. Band Edge Emission 7. Frequency Stability. 8. Maximum Permissible Exposure.

Note: Maximum Permissible Exposure of 5GHz Band 1 (NII), 5GHz Band 4 (DTS) and 2.4GHz Band are based on original test report (please refer to Appendix B).

3.8. Table for Supporting Units

For Test Site No: 03CH01-CB

For non-beamforming mode:

Support Unit	Brand	Model	FCC ID
NB	DELL	E4300	DoC

For beamforming mode:

Support Unit	Brand	Model	FCC ID
NB	DELL	E4300	DoC
NB	DELL	E4300	DoC
WLAN ac Dongle	Netgear	A6200	PY31220200

For Test Site No: TH01-CB

Support Unit	Brand	Model	FCC ID
--------------	-------	-------	--------

Support Unit	Brand	Model	FCC ID
NB	DELL	E4300	DoC

3.9. Table for Parameters of Test Software Setting

During testing, Channel and Power Controlling Software provided by the customer was used to control the operating channel as well as the output power level. The RF output power selection is for the setting of RF output power expected by the customer and is going to be fixed on the firmware of the final end product.

For non-beamforming mode:

Test Software Version	Mtool 2.0.0.7					
Mode	Test Frequency (MHz)					
	NCB: 20MHz					
	5260 MHz	5300 MHz	5320 MHz	5500 MHz	5580 MHz	5700 MHz
802.11a	100	100	86	90	94	83

For beamforming mode:

Test Software Version	Mtool 2.0.0.7					
Mode	Test Frequency (MHz)					
	NCB: 20MHz					
	5260 MHz	5300 MHz	5320 MHz	5500 MHz	5580 MHz	5700 MHz
802.11ac MCS0/Nss1 VHT20	72	72	72	73	75	72
Mode	NCB: 40MHz					
802.11ac MCS0/Nss1 VHT40	5270 MHz	5310 MHz	5510 MHz	5550 MHz	5670 MHz	
	74	65	70	77	78	
Mode	NCB: 80MHz					
802.11ac MCS0/Nss1 VHT80	5290 MHz			5530 MHz		
	61			63		

3.10. EUT Operation during Test

For non-beamforming mode:

The EUT was programmed to be in continuously transmitting mode.

For beamforming mode:

For Conducted Mode:

The EUT was programmed to be in continuously transmitting mode.

For Radiated Mode:

During the test, the following programs under WIN XP were executed.

The program was executed as follows:

1. During the test, the EUT operation to normal function.
2. Executed command fixed test channel under DOS.
3. Executed "Lantest.exe " to link with the remote workstation to receive and transmit packet by WLAN ac

Dongle and transmit duty cycle no less 98%

3.11. Duty Cycle

For non-beamforming mode:

Mode	On Time (ms)	On+Off Time (ms)	Duty Cycle (%)	Duty Factor (dB)	1/T Minimum VBW (kHz)
802.11a	2.058	2.101	97.93	0.09	0.49

For beamforming mode:

Mode	On Time (ms)	On+Off Time (ms)	Duty Cycle (%)	Duty Factor (dB)	1/T Minimum VBW (kHz)
802.11ac MCS0/Nss1 VHT20	3.840	3.960	96.97	0.13	0.26
802.11ac MCS0/Nss1 VHT40	0.954	1.033	92.35	0.35	1.05
802.11ac MCS0/Nss1 VHT80	0.463	0.539	85.85	0.66	2.16

3.12. Test Configurations

3.12.1. Radiation Emissions Test Configuration

For non-beamforming mode:

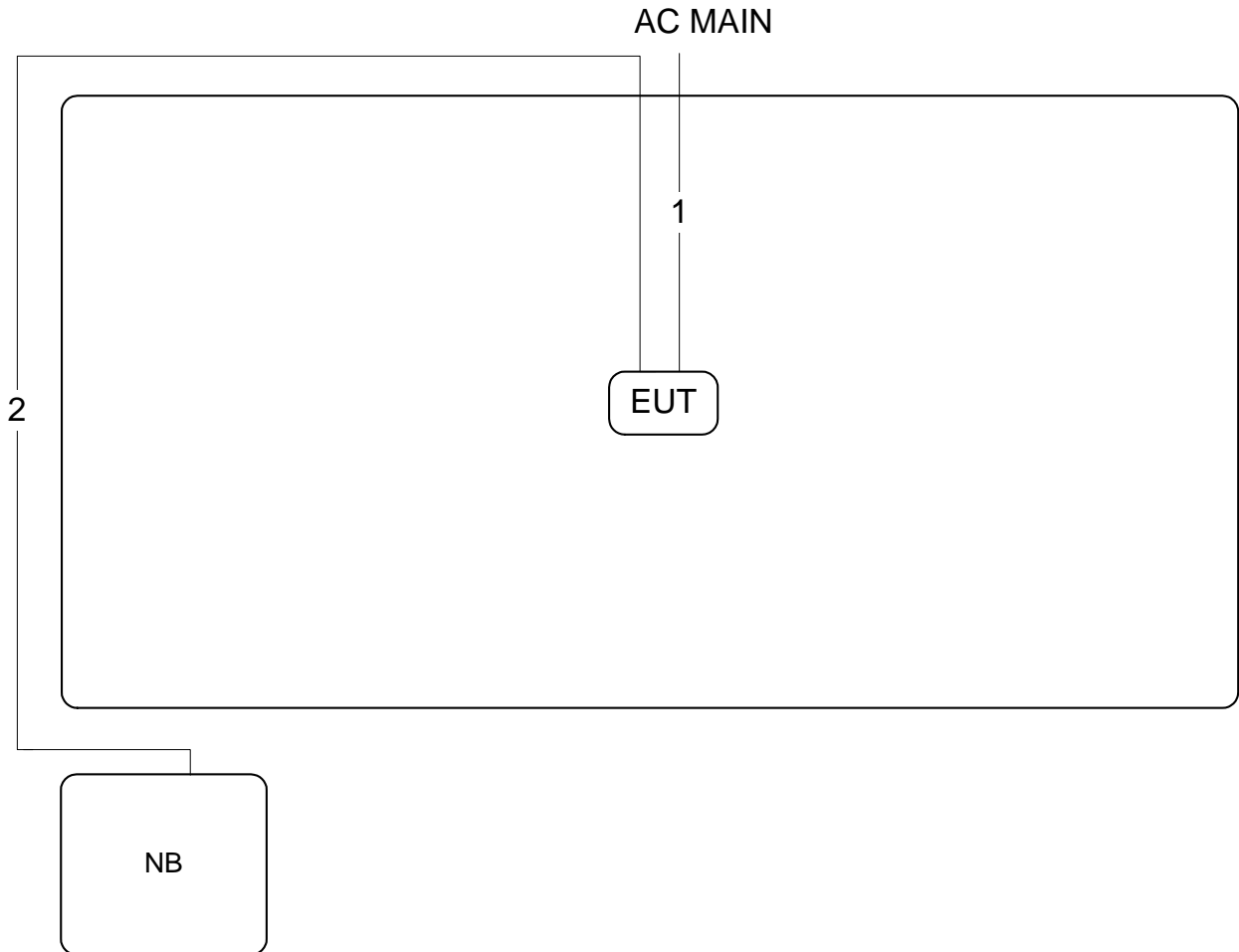

Item	Connection	Shielded	Length
1	Power cable	No	1.5m
2	RJ-45 cable	No	10m

For beamforming mode:

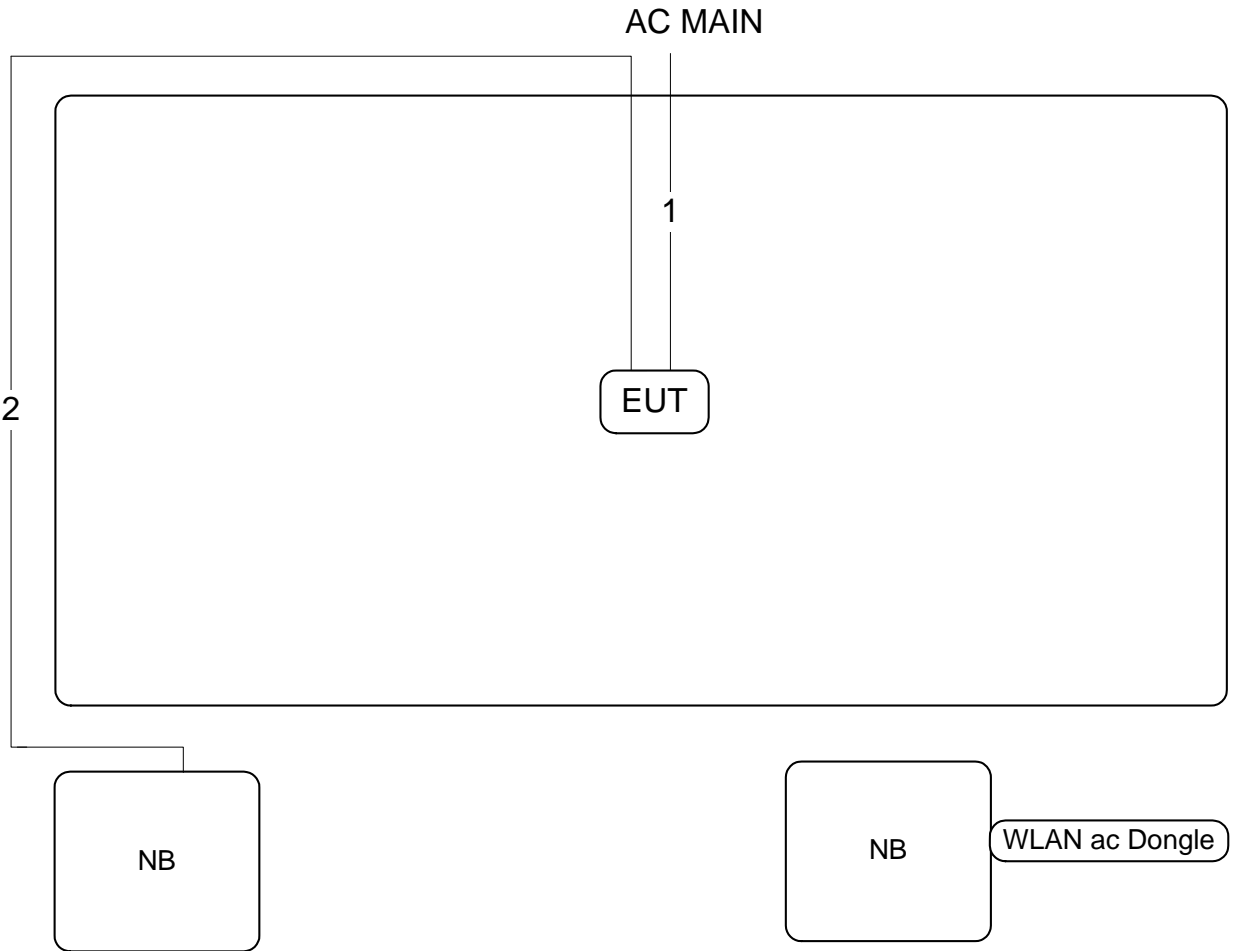

Item	Connection	Shielded	Length
1	Power cable	No	1.5m
2	RJ-45 cable	No	10m

4. TEST RESULT

4.1. 26dB Bandwidth and 99% Occupied Bandwidth Measurement

4.1.1. Limit

No restriction limits.

4.1.2. Measuring Instruments and Setting

Please refer to section 5 of equipments list in this report. The following table is the setting of the spectrum analyzer.

26dB Bandwidth	
Spectrum Parameters	Setting
Attenuation	Auto
Span Frequency	> 26dB Bandwidth
RBW	Approximately 1% of the emission bandwidth
VBW	VBW > RBW
Detector	Peak
Trace	Max Hold
Sweep Time	Auto
99% Occupied Bandwidth	
Spectrum Parameters	Setting
Span	1.5 times to 5.0 times the OBW
RBW	1 % to 5 % of the OBW
VBW	$\geq 3 \times$ RBW
Detector	Peak
Trace	Max Hold

4.1.3. Test Procedures

For Radiated 26dB Bandwidth and 99% Occupied Bandwidth Measurement:

1. The transmitter was radiated to the spectrum analyzer in peak hold mode.
2. Measure the maximum width of the emission that is 26 dB down from the peak of the emission. Compare this with the RBW setting of the analyzer. Readjust RBW and repeat measurement as needed until the RBW/EBW ratio is approximately 1%.

4.1.4. Test Setup Layout

For Radiated 26dB Bandwidth and 99% Occupied Bandwidth Measurement:

This test setup layout is the same as that shown in section 4.4.4.

4.1.5. Test Deviation

There is no deviation with the original standard.

4.1.6. EUT Operation during Test

The EUT was programmed to be in continuously transmitting mode.

4.1.7. Test Result of 26dB Bandwidth and 99% Occupied Bandwidth

Temperature	20°C	Humidity	59%
Test Engineer	Roki Liu	Test Mode	Non-beamforming mode

Mode	Frequency	26dB Bandwidth (MHz)	99% Occupied Bandwidth (MHz)
802.11a	5260 MHz	41.74	28.05
	5300 MHz	41.74	27.61
	5320 MHz	37.39	21.53
	5500 MHz	34.09	19.97
	5580 MHz	41.74	26.74
	5700 MHz	31.30	17.63

Temperature	20°C	Humidity	59%
Test Engineer	Lucas Huang	Test Mode	Beamforming mode

Mode	Frequency	26dB Bandwidth (MHz)	99% Occupied Bandwidth (MHz)
802.11ac MCS0/Nss1 VHT20	5260 MHz	20.70	17.97
	5300 MHz	20.43	17.89
	5320 MHz	20.78	17.89
	5500 MHz	20.43	17.89
	5580 MHz	20.78	17.89
	5700 MHz	20.70	17.97
802.11ac MCS0/Nss1 VHT40	5270 MHz	41.01	36.76
	5310 MHz	40.87	36.76
	5510 MHz	40.73	36.76
	5550 MHz	40.73	36.76
	5670 MHz	40.87	36.76
802.11ac MCS0/Nss1 VHT80	5290 MHz	82.03	75.83
	5530 MHz	82.03	75.83

For non-beamforming mode:

26dB Bandwidth and 99% Occupied Bandwidth Plot on Configuration IEEE 802.11a / Chain 3 / 5260 MHz

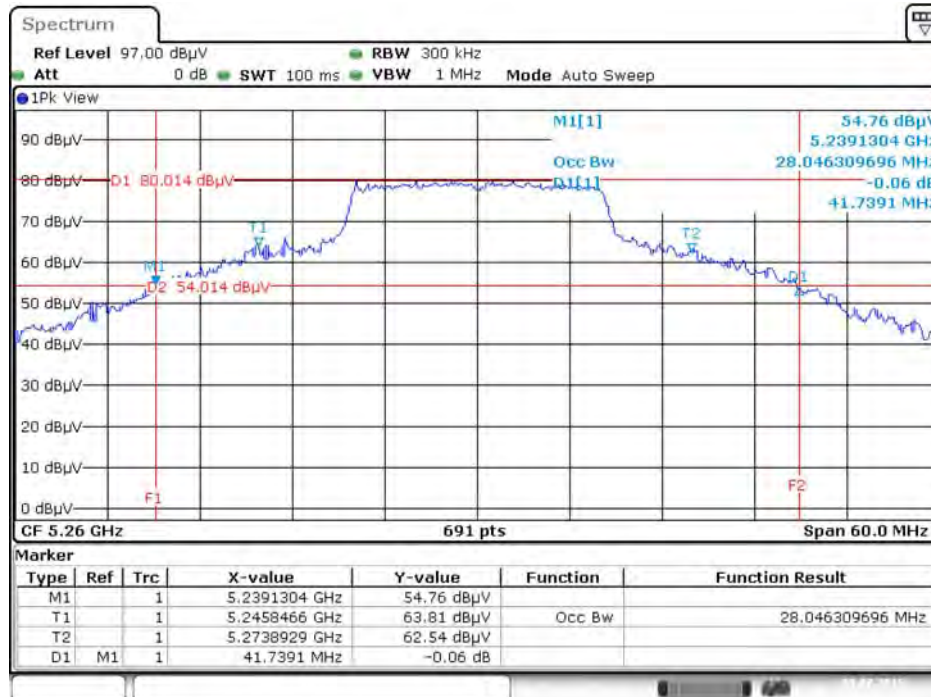

Date: 9 JUL 2015 11:11:34

26dB Bandwidth and 99% Occupied Bandwidth Plot on Configuration IEEE 802.11a / Chain 3 / 5300 MHz

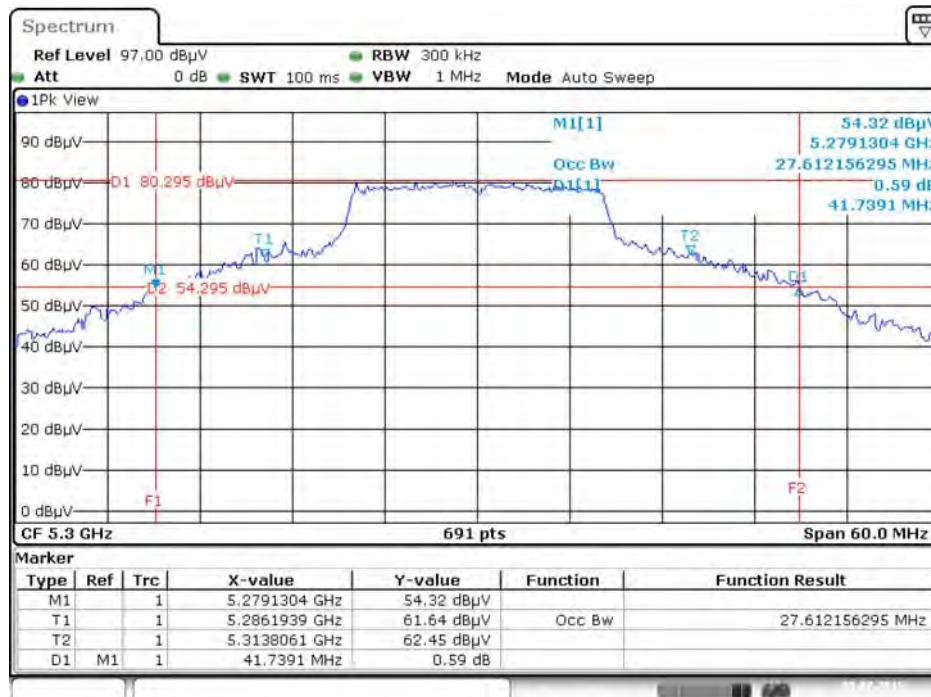

Date: 9 JUL 2015 11:12:53

26dB Bandwidth and 99% Occupied Bandwidth Plot on Configuration IEEE 802.11 a / Chain 3 / 5320 MHz

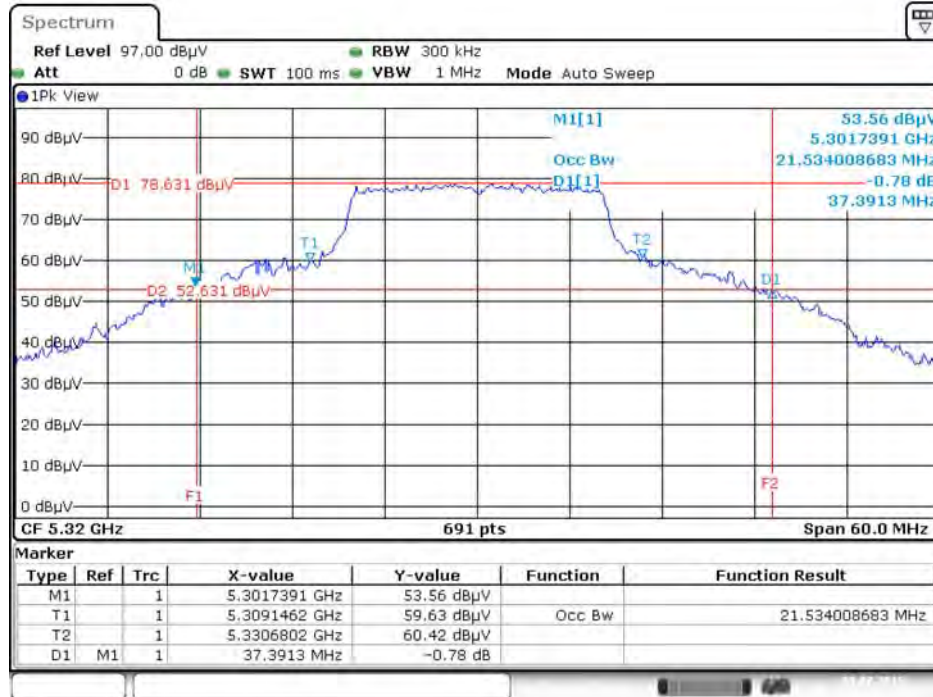

Date: 9 JUL 2015 11:13:43

26dB Bandwidth and 99% Occupied Bandwidth Plot on Configuration IEEE 802.11 a / Chain 3 / 5500 MHz

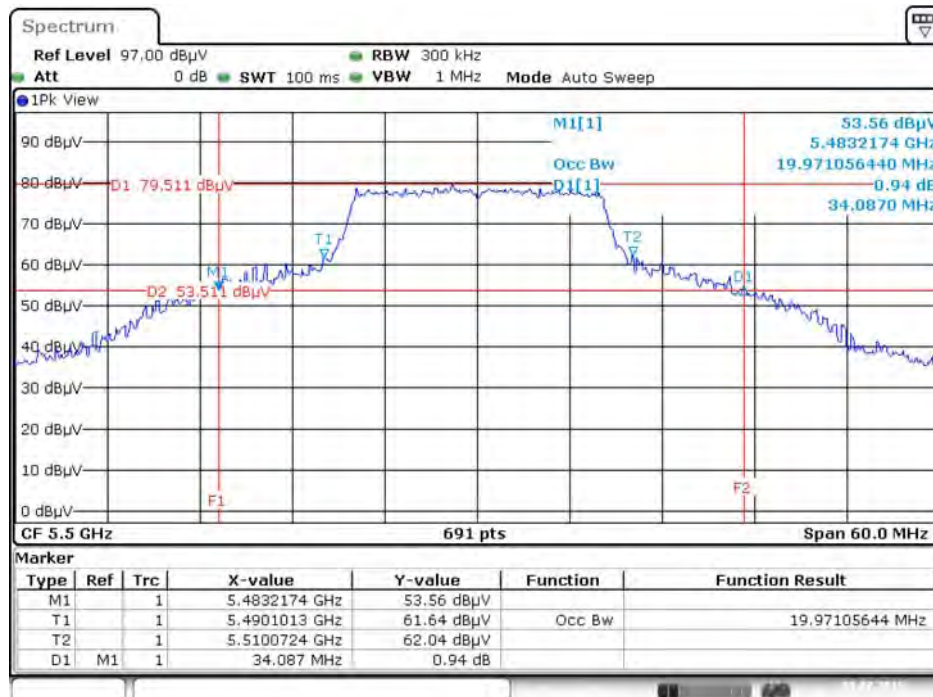

Date: 9 JUL 2015 11:15:12

26dB Bandwidth and 99% Occupied Bandwidth Plot on Configuration IEEE 802.11a / Chain 3 / 5580 MHz

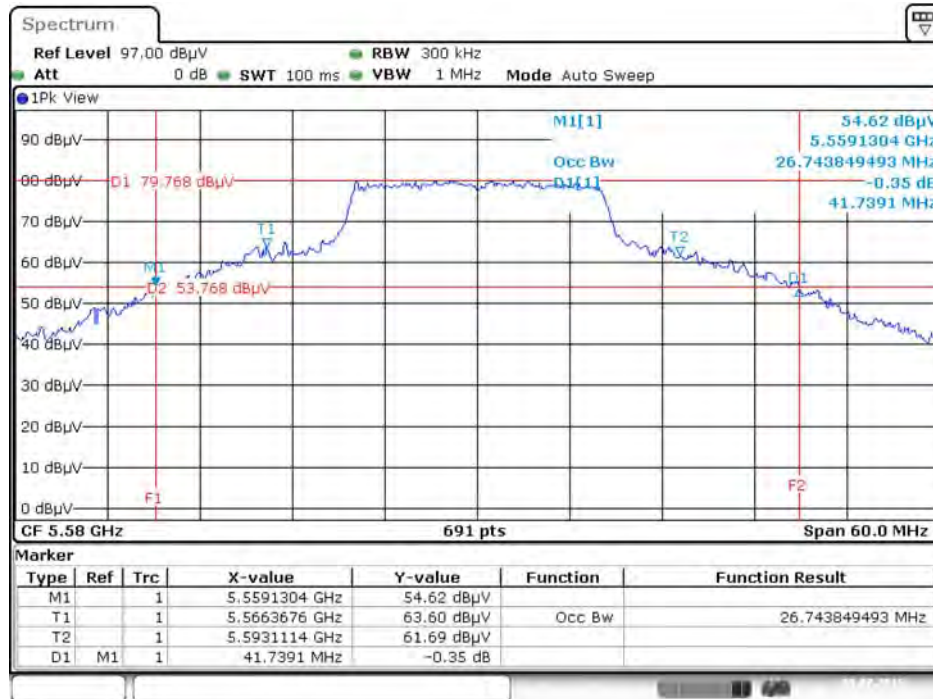

Date: 9 JUL 2015 11:15:57

26dB Bandwidth and 99% Occupied Bandwidth Plot on Configuration IEEE 802.11a / Chain 3 / 5700 MHz

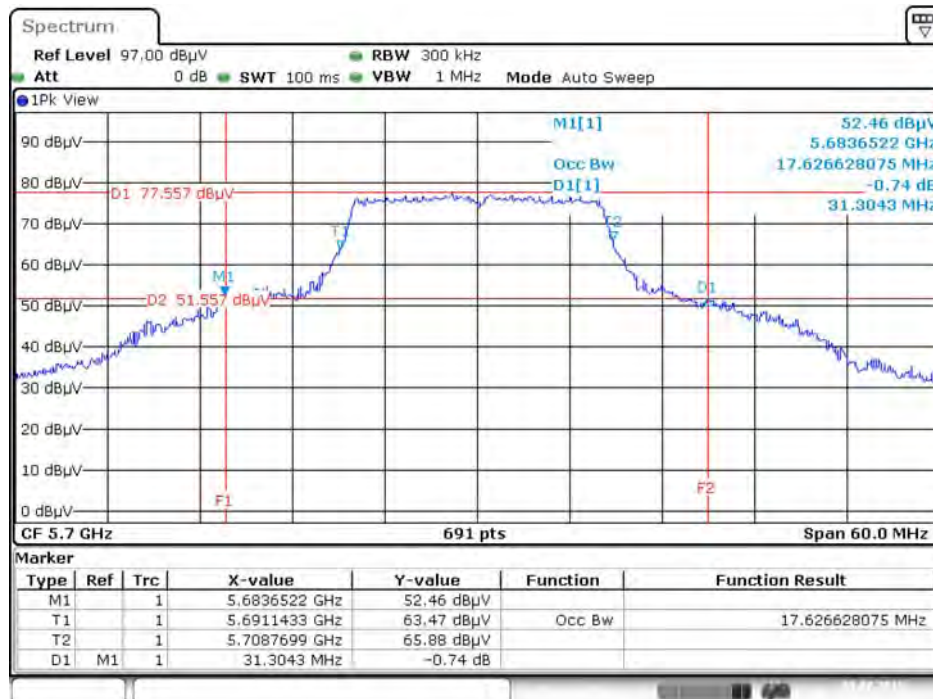

Date: 9 JUL 2015 11:16:38

For beamforming mode:

26dB Bandwidth and 99% Occupied Bandwidth Plot on Configuration IEEE 802.11ac MCS0/Nss1 VHT20 / Chain 3 + Chain 4 + Chain 5 / 5260 MHz

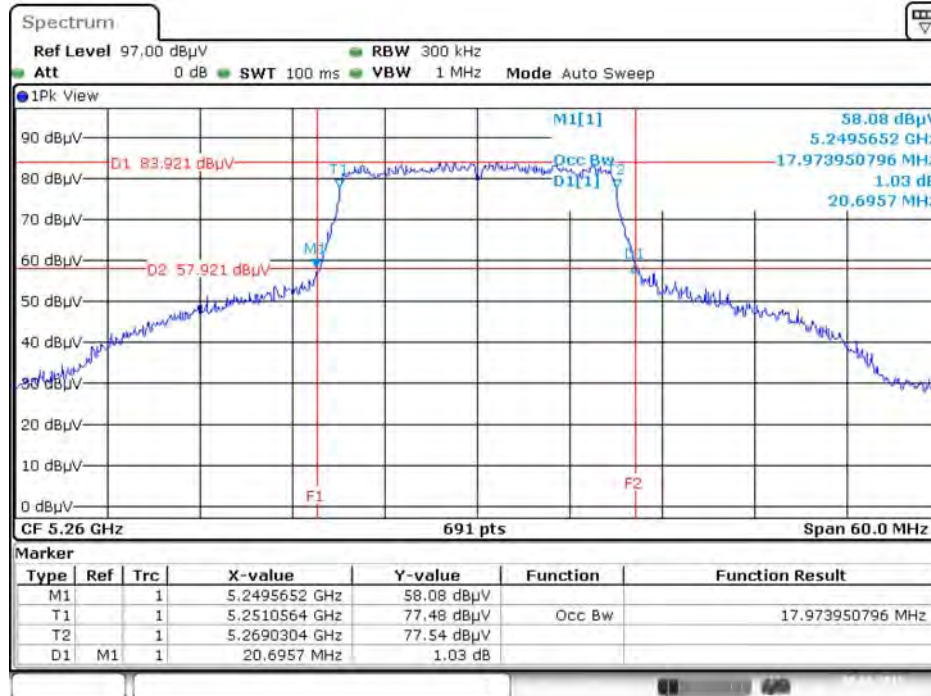

Date: 30.JUN.2015 17:33:39

26dB Bandwidth and 99% Occupied Bandwidth Plot on Configuration IEEE 802.11ac MCS0/Nss1 VHT20 / Chain 3 + Chain 4 + Chain 5 / 5300 MHz

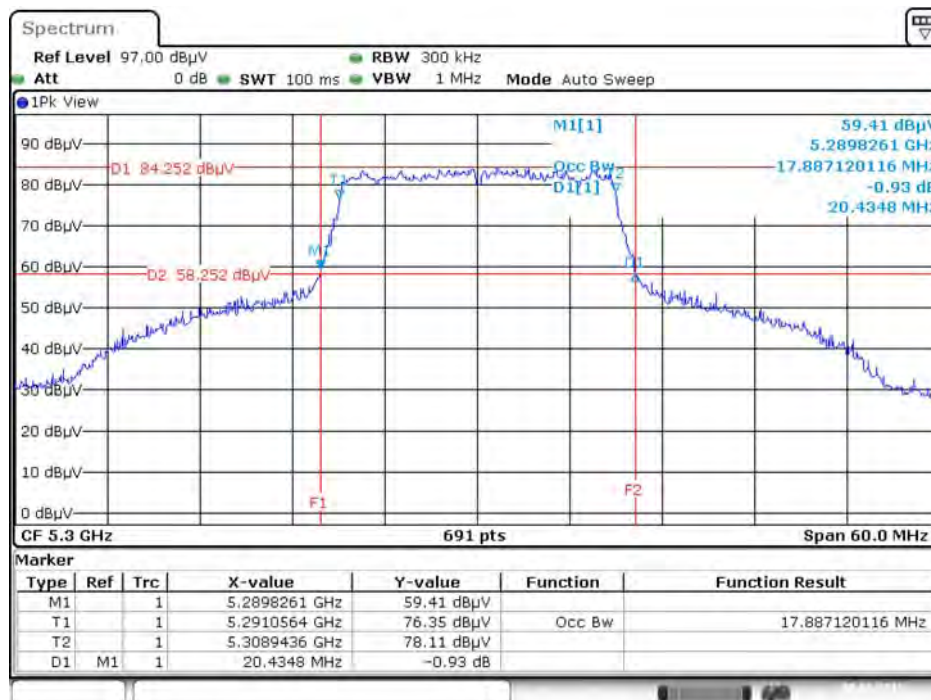

Date: 30.JUN.2015 17:34:06

26dB Bandwidth and 99% Occupied Bandwidth Plot on Configuration IEEE 802.11ac MCS0/Nss1 VHT20 / Chain 3 + Chain 4 + Chain 5 / 5320 MHz



Date: 30.JUN.2015 17:34:34

26dB Bandwidth and 99% Occupied Bandwidth Plot on Configuration IEEE 802.11ac MCS0/Nss1 VHT20 / Chain 3 + Chain 4 + Chain 5 / 5500 MHz

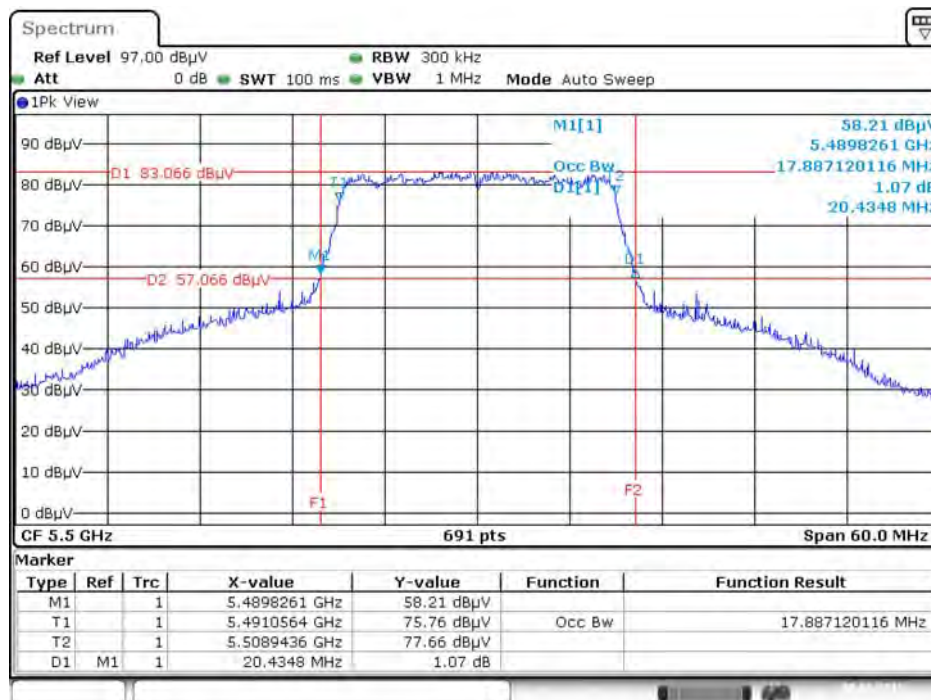

Date: 30.JUN.2015 17:35:05

26dB Bandwidth and 99% Occupied Bandwidth Plot on Configuration IEEE 802.11ac MCS0/Nss1 VHT20 / Chain 3 + Chain 4 + Chain 5 / 5580 MHz

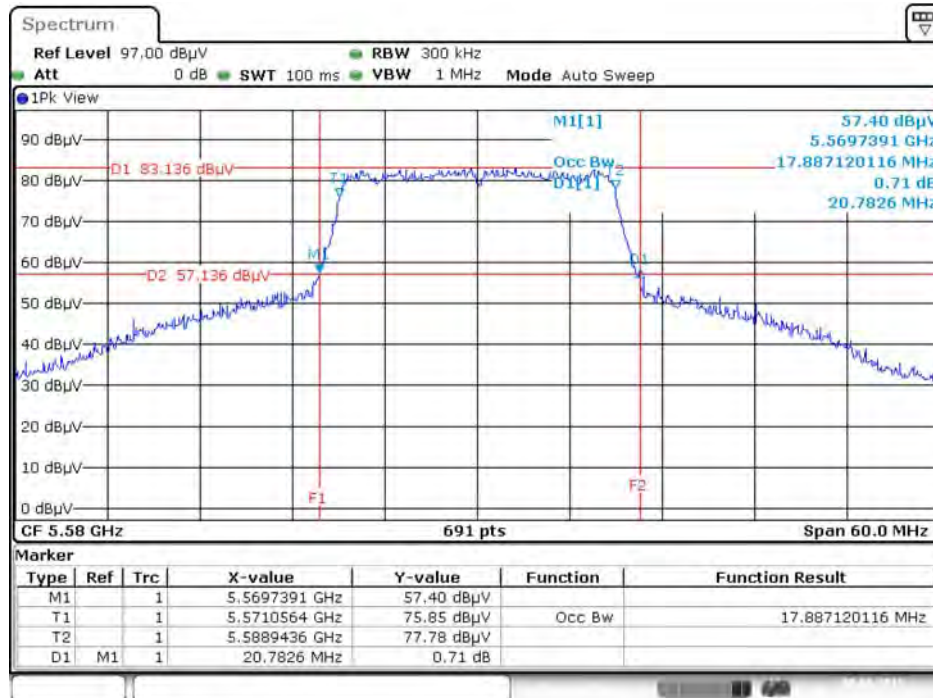

Date: 30.JUN.2015 17:35:45

26dB Bandwidth and 99% Occupied Bandwidth Plot on Configuration IEEE 802.11ac MCS0/Nss1 VHT20 / Chain 3 + Chain 4 + Chain 5 / 5700 MHz

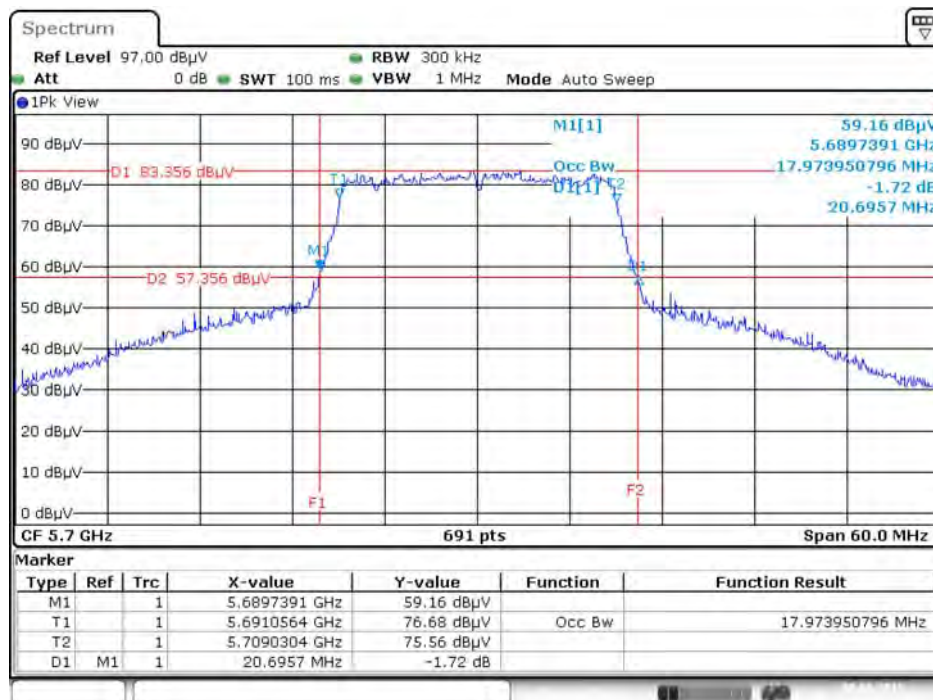

Date: 30.JUN.2015 17:36:21

26dB Bandwidth and 99% Occupied Bandwidth Plot on Configuration IEEE 802.11ac MCS0/Nss1 VHT40 / Chain 3 + Chain 4 + Chain 5 / 5270 MHz

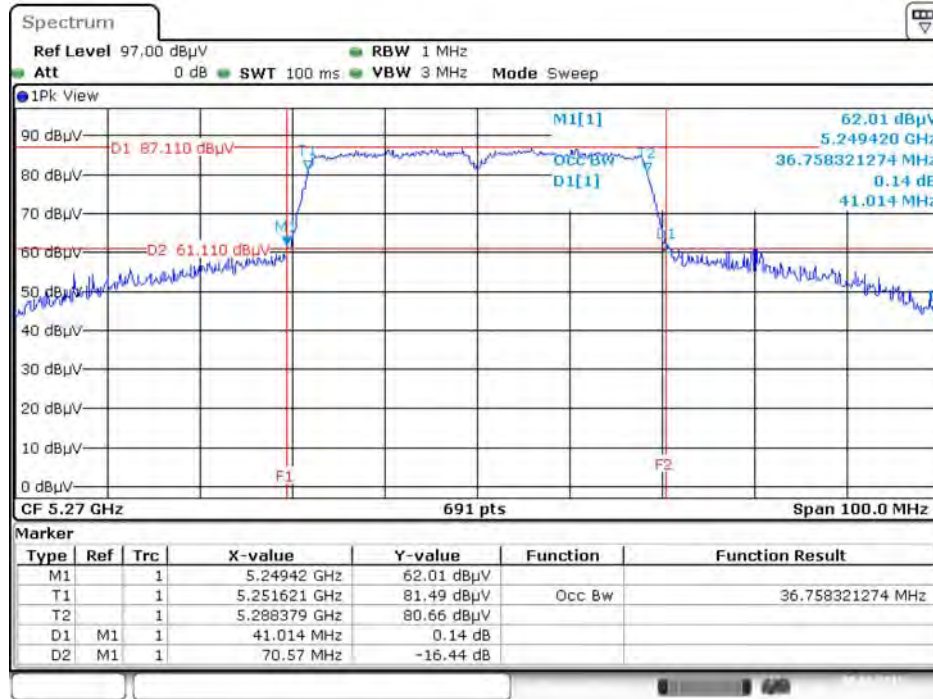

Date: 30.JUN.2015 17:29:03

26dB Bandwidth and 99% Occupied Bandwidth Plot on Configuration IEEE 802.11ac MCS0/Nss1 VHT40 / Chain 3 + Chain 4 + Chain 5 / 5310 MHz

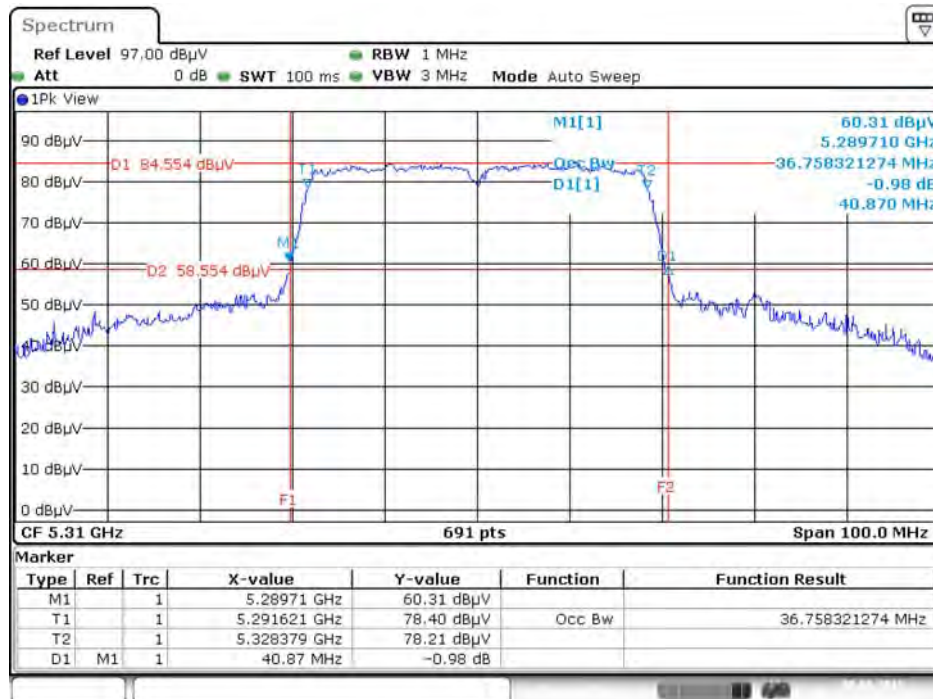

Date: 30.JUN.2015 17:30:23

26dB Bandwidth and 99% Occupied Bandwidth Plot on Configuration IEEE 802.11ac MCS0/Nss1 VHT40 / Chain 3 + Chain 4 + Chain 5 / 5510 MHz

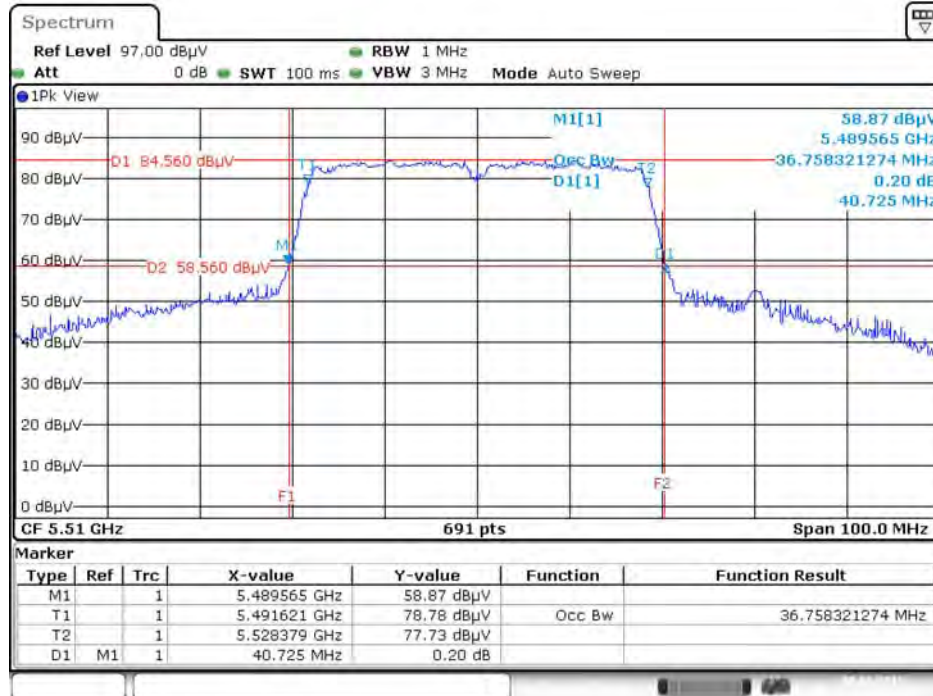

Date: 30.JUN.2015 17:31:01

26dB Bandwidth and 99% Occupied Bandwidth Plot on Configuration IEEE 802.11ac MCS0/Nss1 VHT40 / Chain 3 + Chain 4 + Chain 5 / 5550 MHz

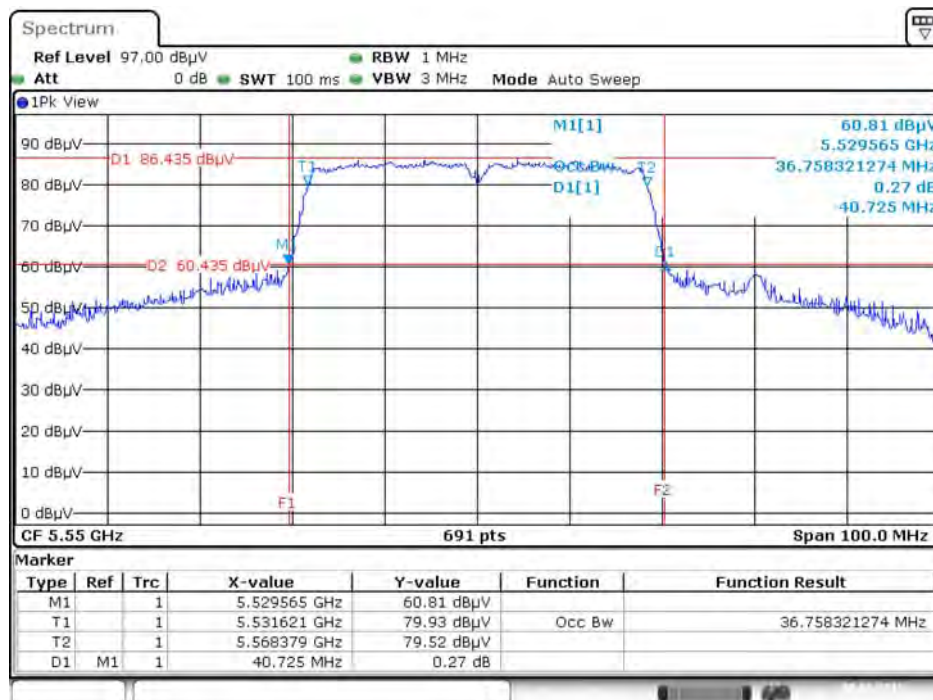

Date: 30.JUN.2015 17:31:55

26dB Bandwidth and 99% Occupied Bandwidth Plot on Configuration IEEE 802.11ac MCS0/Nss1 VHT40 / Chain 3 + Chain 4 + Chain 5 / 5670 MHz

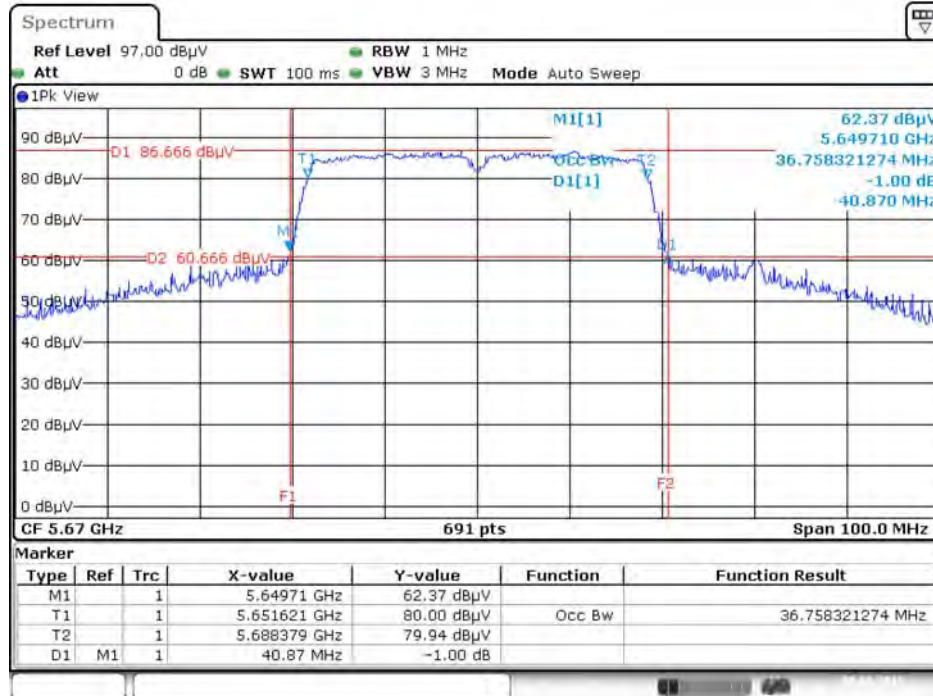

Date: 30.JUN.2015 17:32:29

26dB Bandwidth and 99% Occupied Bandwidth Plot on Configuration IEEE 802.11ac MCS0/Nss1 VHT80 / Chain 3 + Chain 4 + Chain 5 / 5290 MHz

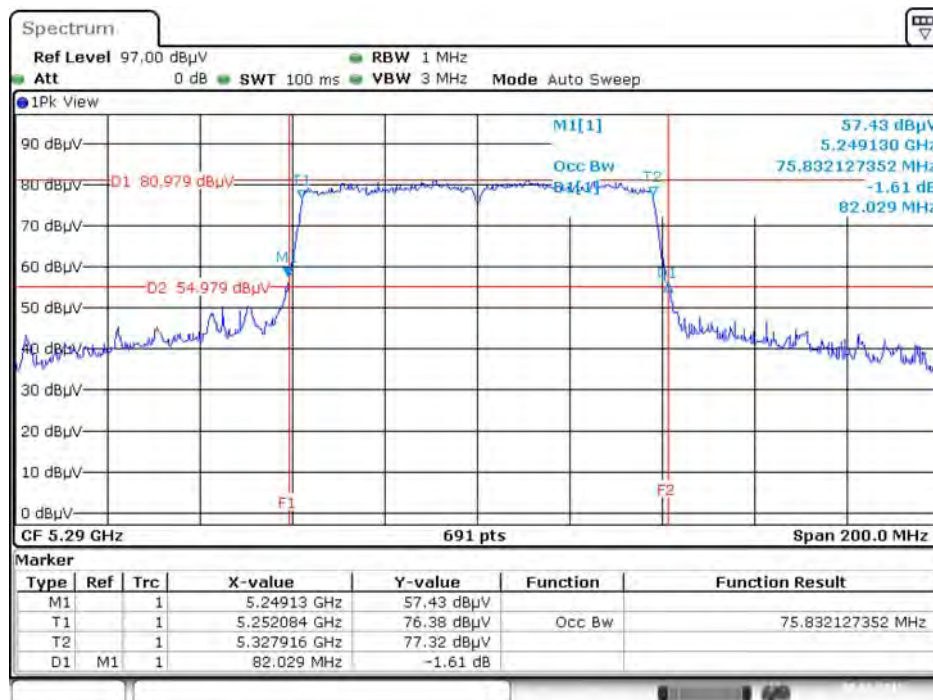

Date: 30.JUN.2015 17:39:47

26dB Bandwidth and 99% Occupied Bandwidth Plot on Configuration IEEE 802.11ac MCS0/Nss1 VHT80 / Chain 3 + Chain 4 + Chain 5 / 5530 MHz

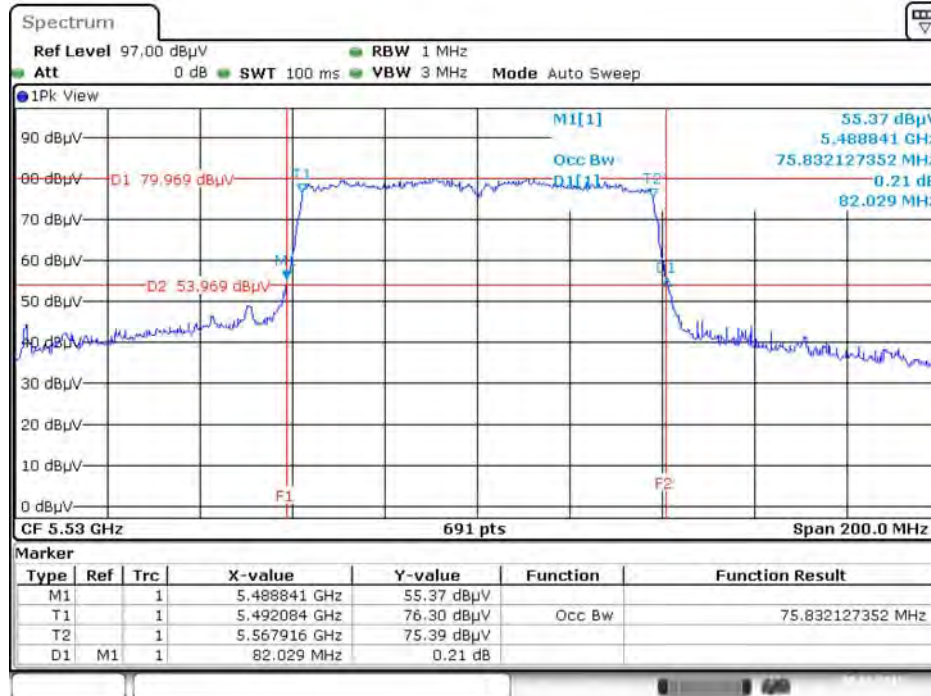

Date: 30.JUN.2015 17:40:17

4.2. Maximum Conducted Output Power Measurement

4.2.1. Limit

Frequency Band		Limit
<input checked="" type="checkbox"/>	5.25-5.35 GHz	The maximum conducted output power over the frequency bands of operation shall not exceed the lesser of 250 mW (24dBm) or 11 dBm 10 log B, where B is the 26 dB emission bandwidth in megahertz. If transmitting antennas of directional gain greater than 6 dBi are used, both the maximum conducted output power and the maximum power spectral density shall be reduced by the amount in dB that the directional gain of the antenna exceeds 6 dBi.
<input checked="" type="checkbox"/>	5.470-5.725 GHz	

4.2.2. Measuring Instruments and Setting

Please refer to section 5 of equipments list in this report. The following table is the setting of the power meter.

Power Meter Parameter	Setting
Detector	AVERAGE

4.2.3. Test Procedures

1. The transmitter output (antenna port) was connected to the power meter.
2. Test was performed in accordance with KDB789033 D02 v01 for Compliance Testing of Unlicensed National Information Infrastructure (U-NII) Devices - section (E) Maximum conducted output power =>3. Measurement using a Power Meter (PM) =>b) Method PM-G (Measurement using a gated RF average power meter).
3. Multiple antenna systems was performed in accordance with KDB662911 D01 v02r01 Emissions Testing of Transmitters with Multiple Outputs in the Same Band.
4. When measuring maximum conducted output power with multiple antenna systems, add every result of the values by mathematic formula.

4.2.4. Test Setup Layout

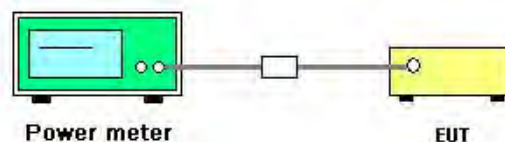

4.2.5. Test Deviation

There is no deviation with the original standard.

4.2.6. EUT Operation during Test

The EUT was programmed to be in continuously transmitting mode.

4.2.7. Test Result of Maximum Conducted Output Power

Temperature	20°C	Humidity	59%
Test Engineer	Roki Liu	Test Date	Jul. 09, 2015
Test Mode	Non-beamforming mode		

Mode	Frequency	Conducted Power (dBm)	Max. Limit (dBm)	Result
		Chain 3		
802.11a	5260 MHz	23.24	24.00	Complies
	5300 MHz	23.83	24.00	Complies
	5320 MHz	22.47	24.00	Complies
	5500 MHz	22.95	24.00	Complies
	5580 MHz	23.89	24.00	Complies
	5700 MHz	20.81	24.00	Complies

Temperature	20°C	Humidity	59%
Test Engineer	Lucas Huang	Test Date	Jun. 30, 2015
Test Mode	Beamforming mode		

Mode	Frequency	Conducted Power (dBm)				Max. Limit (dBm)	Result
		Chain 3	Chain 4	Chain 5	Total		
802.11ac MCS0/Nss1 VHT20	5260 MHz	18.95	18.97	19.32	23.85	24.00	Complies
	5300 MHz	19.11	18.85	19.25	23.84	24.00	Complies
	5320 MHz	19.15	18.95	19.31	23.91	24.00	Complies
	5500 MHz	18.57	18.70	18.61	23.40	24.00	Complies
	5580 MHz	19.13	19.04	19.11	23.86	24.00	Complies
	5700 MHz	18.31	18.39	18.58	23.20	24.00	Complies
802.11ac MCS0/Nss1 VHT40	5270 MHz	19.02	18.92	19.32	23.86	24.00	Complies
	5310 MHz	16.87	17.22	17.24	21.88	24.00	Complies
	5510 MHz	17.42	17.29	17.52	22.18	24.00	Complies
	5550 MHz	18.96	18.92	19.14	23.78	24.00	Complies
	5670 MHz	19.23	19.05	19.18	23.93	24.00	Complies
802.11ac MCS0/Nss1 VHT80	5290 MHz	16.52	15.96	16.38	21.06	24.00	Complies
	5530 MHz	15.98	15.83	16.31	20.82	24.00	Complies

Note: $Directional\ Gain = 10 \log \left[\frac{\sum_{j=1}^{N_{SS}} \left\{ \sum_{K=1}^{N_{ANT}} g_{j,k} \right\}^2}{N_{ANT}} \right] = 4.77 \text{dBi} < 6 \text{dBi}$, so the limit doesn't reduce.

4.3. Power Spectral Density Measurement

4.3.1. Limit

The following table is power spectral density limits and decrease power density limit rule refer to section 4.2.1.

	Frequency Band	Limit
<input checked="" type="checkbox"/>	5.25-5.35 GHz	11 dBm/MHz
<input checked="" type="checkbox"/>	5.470-5.725 GHz	11 dBm/MHz

4.3.2. Measuring Instruments and Setting

Please refer to section 5 of equipments list in this report. The following table is the setting of the spectrum analyzer.

Spectrum Parameter	Setting
Attenuation	Auto
Span Frequency	Encompass the entire emissions bandwidth (EBW) of the signal
RBW	1000 kHz
VBW	3000 kHz
Detector	RMS
Trace	AVERAGE
Sweep Time	Auto
Trace Average	100 times

4.3.3. Test Procedures

1. The transmitter output (antenna port) was connected RF switch to the spectrum analyzer.
2. Test was performed in accordance with KDB789033 D02 v01 for Compliance Testing of Unlicensed National Information Infrastructure (U-NII) Devices - section (F) Maximum Power Spectral Density (PSD).
3. Multiple antenna systems was performed in accordance KDB662911 D01 v02r01 in-Band Power Spectral Density (PSD) Measurements (a) Measure and sum the spectra across the outputs.
4. When measuring first spectral bin of output 1 is summed with that in the first spectral bin of output 2 and that from the first spectral bin of output 3 and so on up to the Nth output to obtain the value for the first frequency bin of the summed spectrum. The summed spectrum value for each of the other frequency bins is computed in the same way.

4.3.4. Test Setup Layout

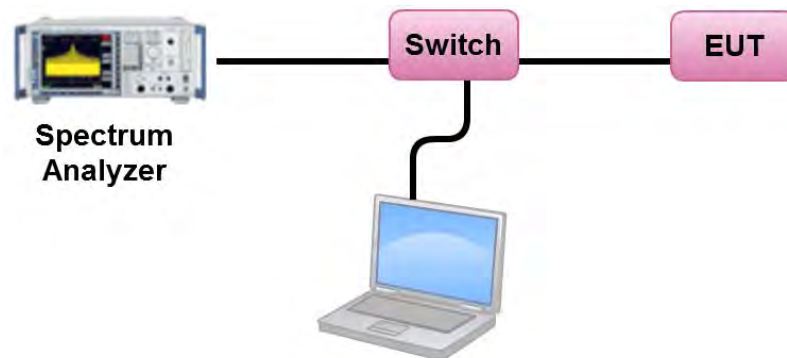

4.3.5. Test Deviation

There is no deviation with the original standard.

4.3.6. EUT Operation during Test

The EUT was programmed to be in continuously transmitting mode.

4.3.7. Test Result of Power Spectral Density

Temperature	20°C	Humidity	59%
Test Engineer	Roki Liu	Test Date	Jul. 09, 2015
Test Mode	Non-beamforming mode		

Mode	Frequency	Power Density (dBm/MHz)	Max. Limit (dBm/MHz)	Result
802.11a	5260 MHz	10.06	11.00	Complies
	5300 MHz	10.55	11.00	Complies
	5320 MHz	9.42	11.00	Complies
	5500 MHz	9.69	11.00	Complies
	5580 MHz	10.86	11.00	Complies
	5700 MHz	7.65	11.00	Complies

Temperature	20°C	Humidity	59%
Test Engineer	Lucas Huang	Test Date	Jun. 30, 2015
Test Mode	Beamforming mode		

Mode	Frequency	Power Density (dBm/MHz)	Max. Limit (dBm/MHz)	Result
802.11ac MCS0/Nss1 VHT20	5260 MHz	10.46	11.00	Complies
	5300 MHz	10.47	11.00	Complies
	5320 MHz	10.43	11.00	Complies
	5500 MHz	9.86	11.00	Complies
	5580 MHz	10.38	11.00	Complies
	5700 MHz	9.47	11.00	Complies
802.11ac MCS0/Nss1 VHT40	5270 MHz	7.45	11.00	Complies
	5310 MHz	5.25	11.00	Complies
	5510 MHz	5.58	11.00	Complies
	5550 MHz	7.35	11.00	Complies
	5670 MHz	7.59	11.00	Complies
802.11ac MCS0/Nss1 VHT80	5290 MHz	1.56	11.00	Complies
	5530 MHz	0.96	11.00	Complies

Note: $Directional\ Gain = 10 \log \left[\frac{\sum_{j=1}^{N_{SS}} \left\{ \sum_{K=1}^{N_{ANT}} g_{j,k} \right\}^2}{N_{ANT}} \right] = 4.77 \text{ dBi} < 6 \text{ dBi}$, so the limit doesn't reduce.

Note: All the test values were listed in the report.

For plots, only the channel with worse result was shown.

For non-beamforming mode:

Power Density Plot on Configuration IEEE 802.11a / Chain 3 / 5300 MHz

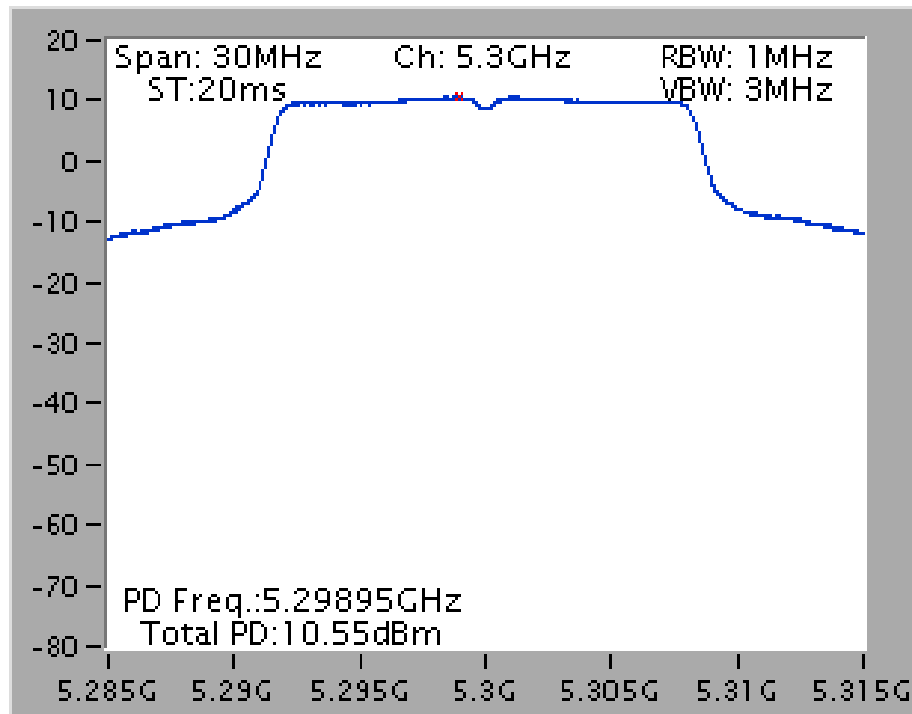

Power Density Plot on Configuration IEEE 802.11a / Chain 3 / 5580 MHz

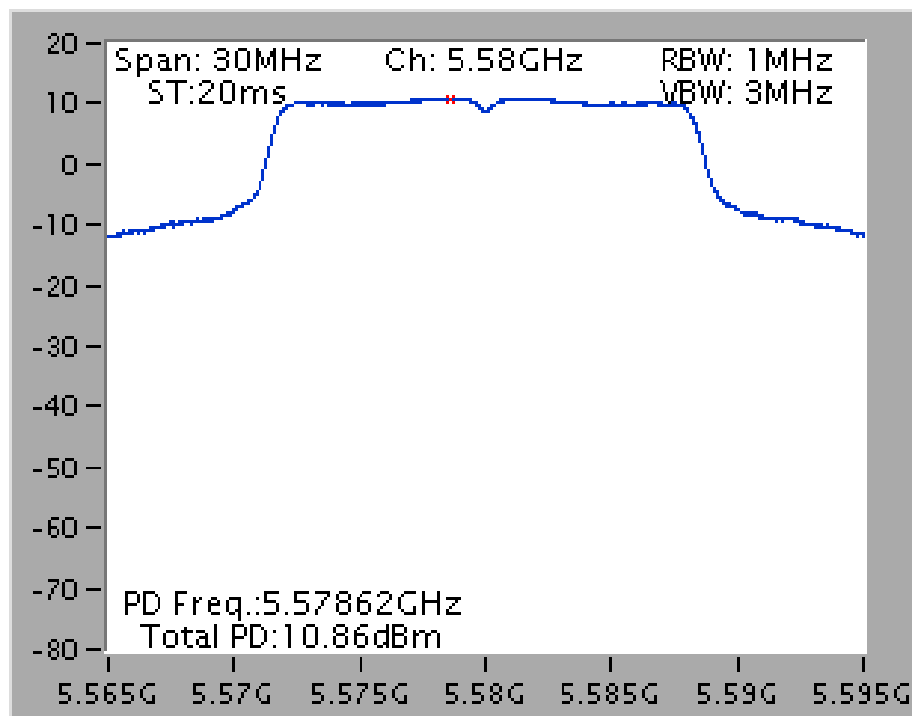

For beamforming mode:

Power Density Plot on Configuration IEEE 802.11ac MCS0/Nss1 VHT20 / Chain 3 + Chain 4 + Chain 5 /
5300 MHz

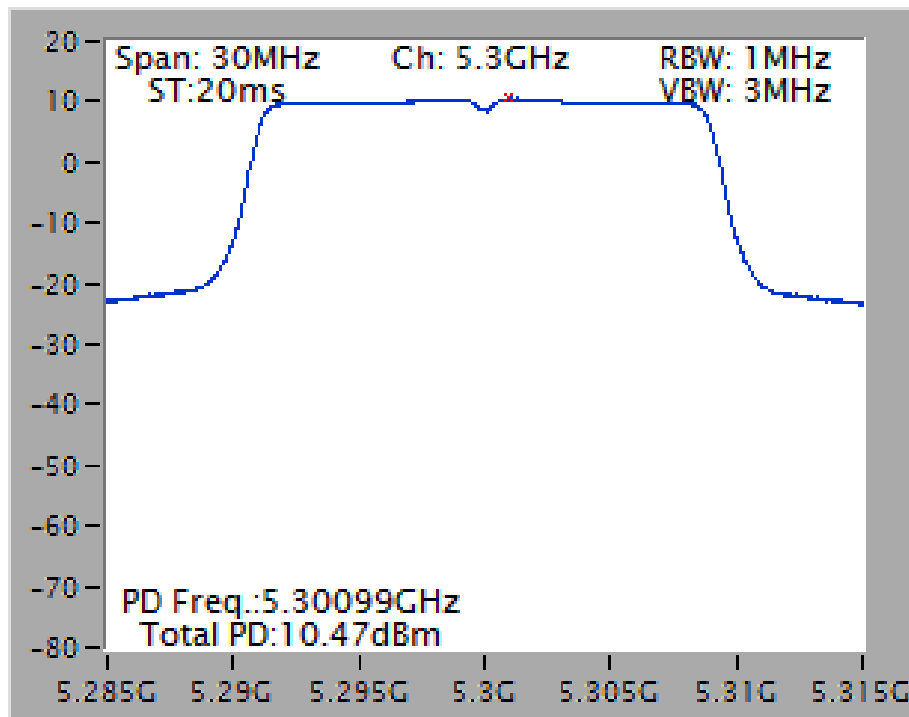

Power Density Plot on Configuration IEEE 802.11ac MCS0/Nss1 VHT20 / Chain 3 + Chain 4 + Chain 5 /
5580 MHz

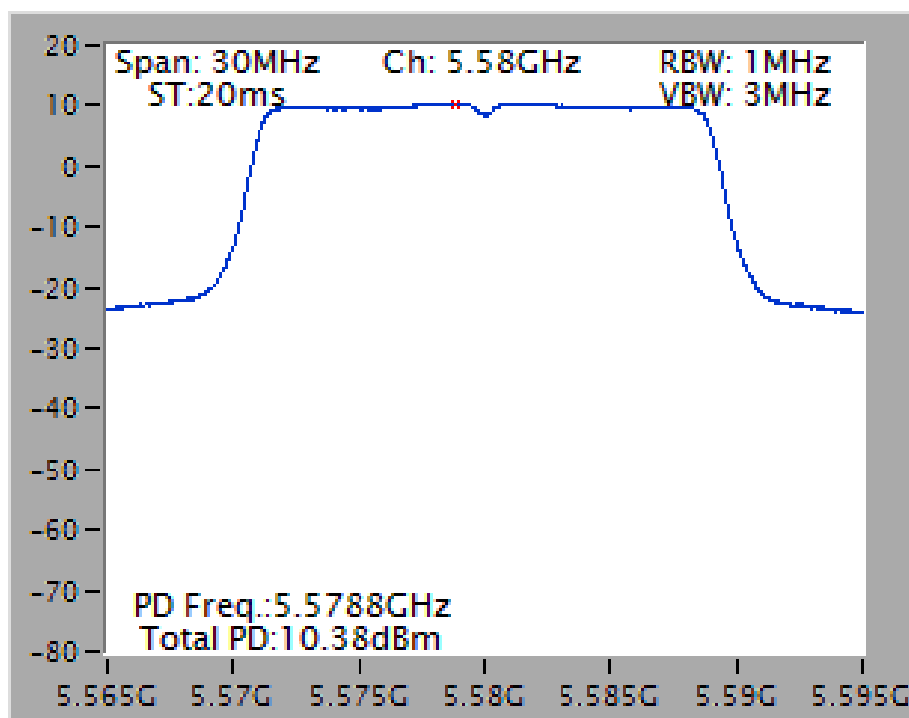

Power Density Plot on Configuration IEEE 802.11ac MCS0/Nss1 VHT40 / Chain 3 + Chain 4 + Chain 5 /
5270 MHz

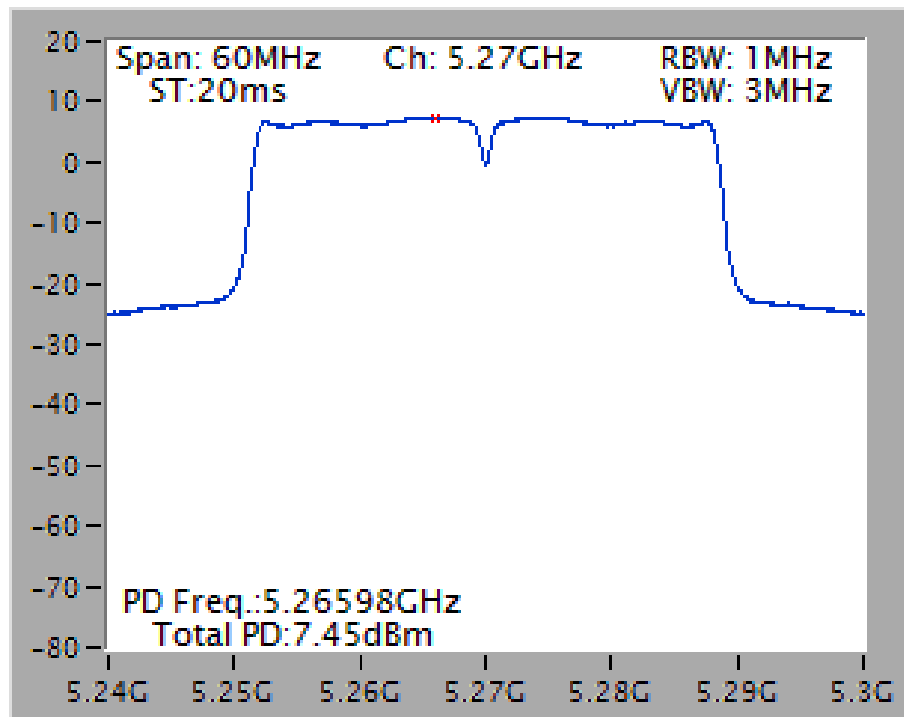

Power Density Plot on Configuration IEEE 802.11ac MCS0/Nss1 VHT40 / Chain 3 + Chain 4 + Chain 5 /
5670 MHz

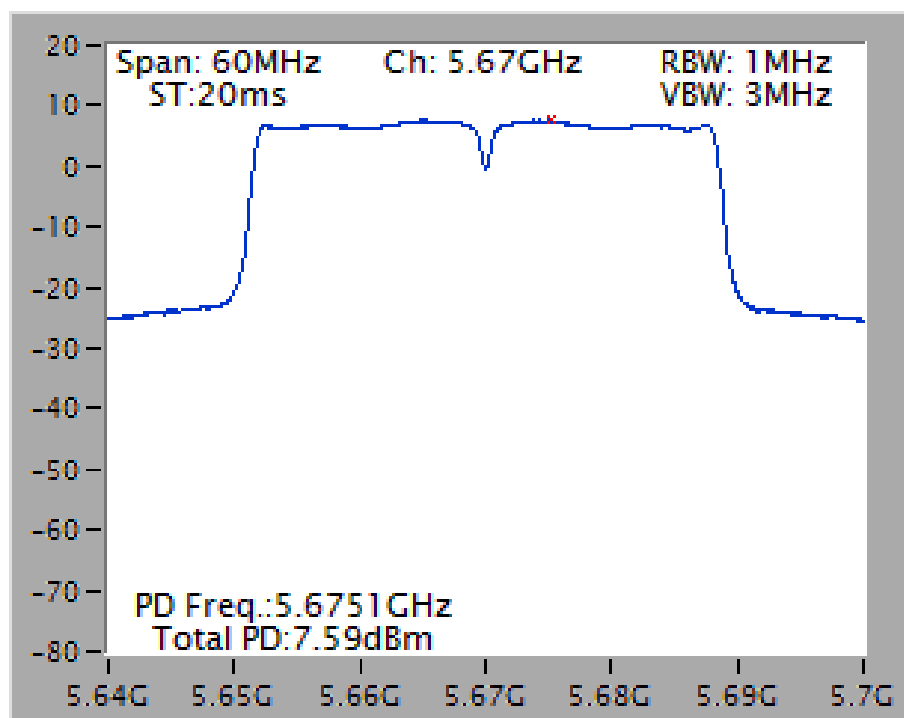

Power Density Plot on Configuration IEEE 802.11ac MCS0/Nss1 VHT80 / Chain 3 + Chain 4 + Chain 5 /
5290 MHz

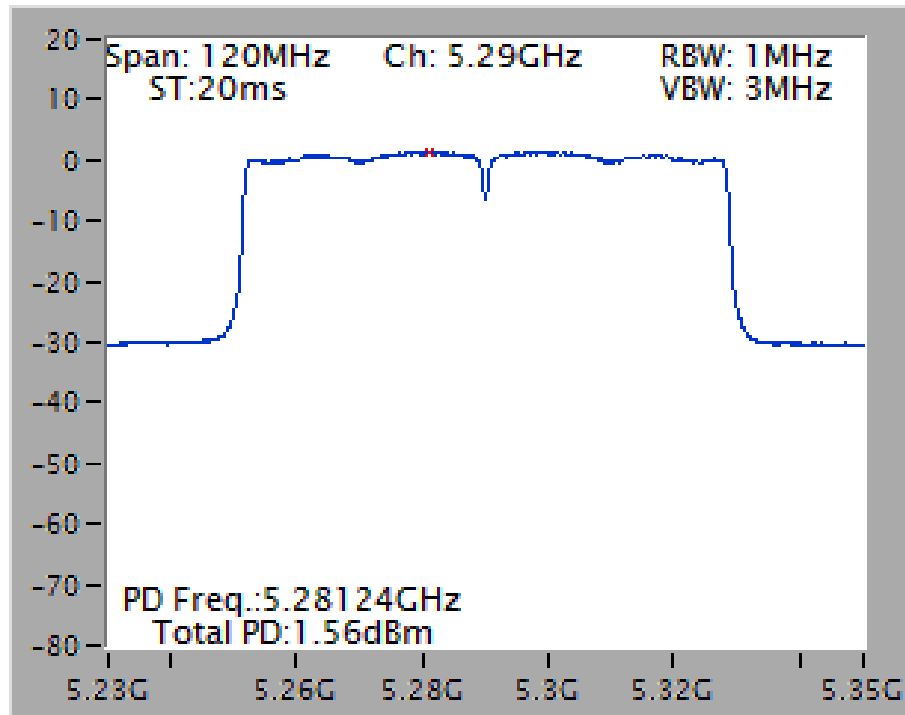

Power Density Plot on Configuration IEEE 802.11ac MCS0/Nss1 VHT80 / Chain 3 + Chain 4 + Chain 5 /
5530 MHz

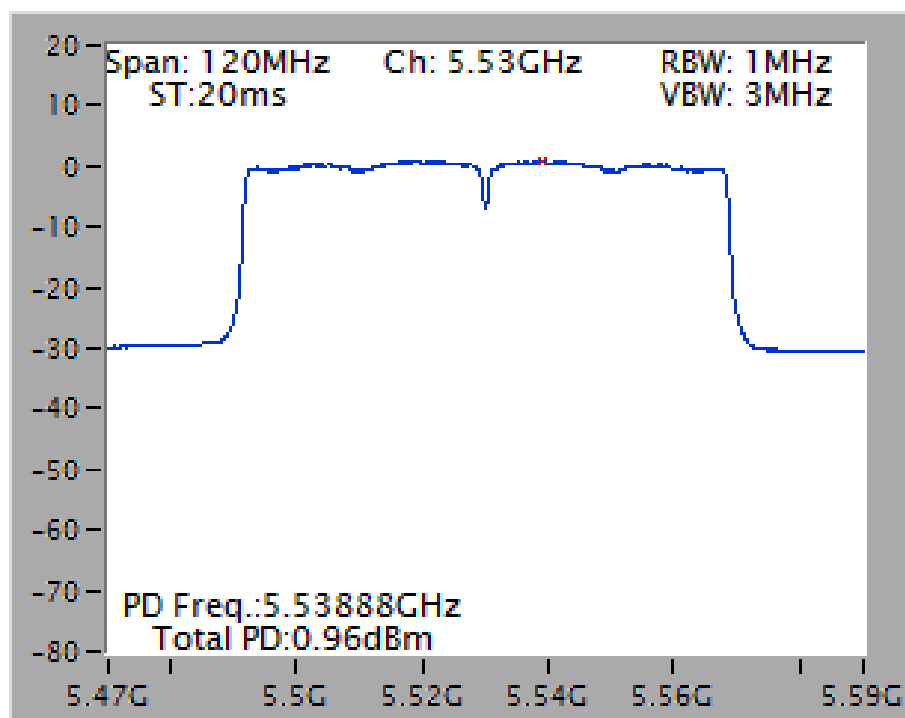

4.4. Radiated Emissions Measurement

4.4.1. Limit

For transmitters operating in the 5.25-5.35 GHz band: all emissions outside of the 5.15-5.35 GHz band shall not exceed an e.i.r.p. of -27 dBm/MHz.

For transmitters operating in the 5.470-5.725 GHz band: all emissions outside of the 5.47-5.725 GHz band shall not exceed an e.i.r.p. of -27 dBm/MHz.

In addition, In case the emission fall within the restricted band specified on 15.205(a), then the 15.209(a) limit in the table below has to be followed.

Frequencies (MHz)	Field Strength (micorvolts/meter)	Measurement Distance (meters)
0.009~0.490	2400/F(kHz)	300
0.490~1.705	24000/F(kHz)	30
1.705~30.0	30	30
30~88	100	3
88~216	150	3
216~960	200	3
Above 960	500	3

4.4.2. Measuring Instruments and Setting

Please refer to section 5 of equipments list in this report. The following table is the setting of spectrum analyzer and receiver.

Spectrum Parameter	Setting
Attenuation	Auto
Start Frequency	1000 MHz
Stop Frequency	40 GHz
RBW / VBW (Emission in restricted band)	1 MHz / 3MHz for Peak, 1 MHz / 1/T for Average
RBW / VBW (Emission in non-restricted band)	1 MHz / 3MHz for peak

Receiver Parameter	Setting
Attenuation	Auto
Start ~ Stop Frequency	9kHz~150kHz / RBW 200Hz for QP
Start ~ Stop Frequency	150kHz~30MHz / RBW 9kHz for QP
Start ~ Stop Frequency	30MHz~1000MHz / RBW 120kHz for QP

4.4.3. Test Procedures

1. Configure the EUT according to ANSI C63.10. The EUT was placed on the top of the turntable 1.5 meter above ground. The phase center of the receiving antenna mounted on the top of a height-variable antenna tower was placed 1m & 3m far away from the turntable.
2. Power on the EUT and all the supporting units. The turntable was rotated by 360 degrees to determine the position of the highest radiation.
3. The height of the broadband receiving antenna was varied between one meter and four meters above ground to find the maximum emissions field strength of both horizontal and vertical polarization.
4. For each suspected emissions, the antenna tower was scan (from 1 M to 4 M) and then the turntable was rotated (from 0 degree to 360 degrees) to find the maximum reading.
5. Set the test-receiver system to Peak or CISPR quasi-peak Detect Function with specified bandwidth under Maximum Hold Mode.
6. For emissions above 1GHz, use 1MHz VBW and 3MHz RBW for peak reading. Then 1MHz RBW and 1/T VBW for average reading in spectrum analyzer.
7. If the emissions level of the EUT in peak mode was 3 dB lower than the average limit specified, then testing will be stopped and peak values of EUT will be reported, otherwise, the emissions which do not have 3 dB margin will be repeated one by one using the quasi-peak method for below 1GHz.
8. For testing above 1GHz, the emissions level of the EUT in peak mode was lower than average limit (that means the emissions level in peak mode also complies with the limit in average mode), then testing will be stopped and peak values of EUT will be reported, otherwise, the emissions will be measured in average mode again and reported.
9. In case the emission is lower than 30MHz, loop antenna has to be used for measurement and the recorded data should be QP measured by receiver. High – Low scan is not required in this case.

4.4.4. Test Setup Layout

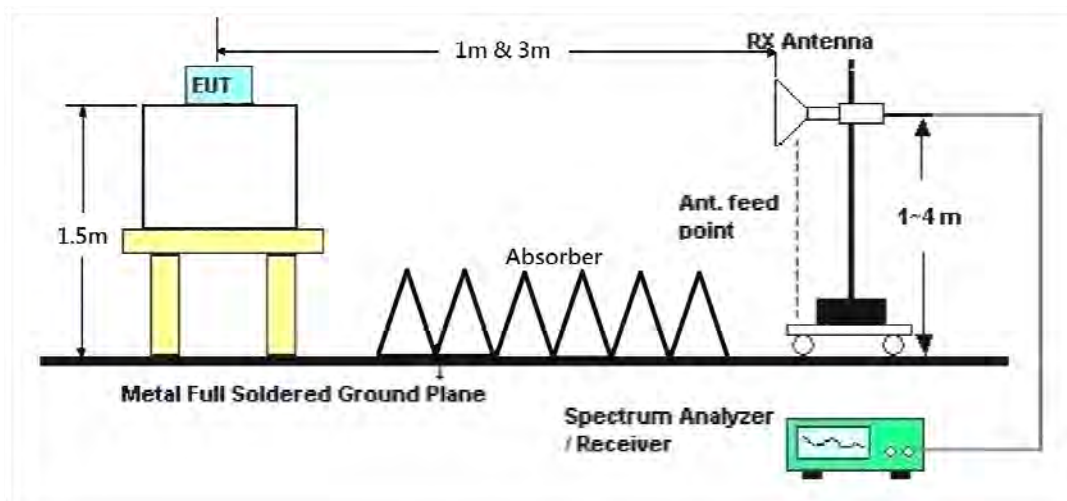

4.4.5. Test Deviation

There is no deviation with the original standard.

4.4.6. EUT Operation during Test

For non-beamforming mode:

The EUT was programmed to be in continuously transmitting mode.

For beamforming mode:

The EUT was programmed to be in beamforming transmitting mode.

4.4.7. Results for Radiated Emissions (1GHz~40GHz)

Temperature	22°C	Humidity	38%
Test Engineer	Gary Chu	Configurations	IEEE 802.11a CH 52 / Chain 3
Test Date	Jul. 09, 2015	Test Mode	Non-beamforming mode

Horizontal

	Freq	Level	Limit Line	Over Limit	Read Level	CableAntenna Loss	Antenna Factor	Preamp Factor	A/Pos	T/Pos	Pol/Phase	Remark
	MHz	dBuV/m	dBuV/m	dB	dBuV	dB	dB/m	dB	cm	deg		
1	15805.90	57.45	74.00	-16.55	44.77	10.11	38.33	35.76	123	339	HORIZONTAL	Peak
2	15806.34	44.72	54.00	-9.28	32.04	10.11	38.33	35.76	123	339	HORIZONTAL	Average

Vertical

	Freq	Level	Limit Line	Over Limit	Read Level	CableAntenna Loss	Antenna Factor	Preamp Factor	A/Pos	T/Pos	Pol/Phase	Remark
	MHz	dBuV/m	dBuV/m	dB	dBuV	dB	dB/m	dB	cm	deg		
1	15813.72	44.62	54.00	-9.38	31.94	10.11	38.33	35.76	130	290	VERTICAL	Average
2	15819.07	57.24	74.00	-16.76	44.57	10.11	38.33	35.77	130	290	VERTICAL	Peak



Temperature	22°C	Humidity	38%
Test Engineer	Gary Chu	Configurations	IEEE 802.11a CH 60 / Chain 3
Test Date	Jul. 09, 2015	Test Mode	Non-beamforming mode

Horizontal

	Freq	Level	Limit Line	Over Limit	Read Level	Cable Loss	Antenna Factor	Preamp Factor	A/Pos	T/Pos	Pol/Phase	Remark
	MHz	dBuV/m	dBuV/m	dB	dBuV	dB	dB/m	dB	cm	deg		
1	10598.84	57.60	74.00	-16.40	44.06	8.31	39.06	33.83	165	285	HORIZONTAL	Peak
2	10600.29	45.10	54.00	-8.90	31.56	8.31	39.06	33.83	165	285	HORIZONTAL	Average
3	15905.07	45.24	54.00	-8.76	32.53	10.12	38.36	35.77	100	32	HORIZONTAL	Average
4	15909.26	58.10	74.00	-15.90	45.37	10.14	38.36	35.77	100	32	HORIZONTAL	Peak

Vertical

	Freq	Level	Limit Line	Over Limit	Read Level	Cable Loss	Antenna Factor	Preamp Factor	A/Pos	T/Pos	Pol/Phase	Remark
	MHz	dBuV/m	dBuV/m	dB	dBuV	dB	dB/m	dB	cm	deg		
1	10602.17	45.69	54.00	-8.31	32.15	8.31	39.06	33.83	182	254	VERTICAL	Average
2	10609.99	59.21	74.00	-14.79	45.67	8.32	39.06	33.84	182	254	VERTICAL	Peak
3	15875.83	58.85	74.00	-15.15	46.14	10.12	38.36	35.77	141	23	VERTICAL	Peak
4	15884.95	45.42	54.00	-8.58	32.71	10.12	38.36	35.77	141	23	VERTICAL	Average



Temperature	22°C	Humidity	38%
Test Engineer	Gary Chu	Configurations	IEEE 802.11a CH 64 / Chain 3
Test Date	Jul. 09, 2015	Test Mode	Non-beamforming mode

Horizontal

	Freq	Level	Limit Line	Over Limit	Read Level	Cable Loss	Antenna Factor	Preamp Factor	A/Pos	T/Pos	Pol/Phase	Remark
	MHz	dBuV/m	dBuV/m	dB	dBuV	dB	dB/m	dB	cm	deg		
1	10642.03	44.66	54.00	-9.34	31.11	8.33	39.08	33.86	159	284	HORIZONTAL	Average
2	10643.85	58.48	74.00	-15.52	44.93	8.33	39.08	33.86	159	284	HORIZONTAL	Peak
3	15956.06	45.62	54.00	-8.38	32.88	10.14	38.38	35.78	172	337	HORIZONTAL	Average
4	15967.24	59.82	74.00	-14.18	47.05	10.15	38.40	35.78	172	337	HORIZONTAL	Peak

Vertical

	Freq	Level	Limit Line	Over Limit	Read Level	Cable Loss	Antenna Factor	Preamp Factor	A/Pos	T/Pos	Pol/Phase	Remark
	MHz	dBuV/m	dBuV/m	dB	dBuV	dB	dB/m	dB	cm	deg		
1	10639.28	46.08	54.00	-7.92	32.54	8.32	39.08	33.86	175	255	VERTICAL	Average
2	10644.08	60.92	74.00	-13.08	47.37	8.33	39.08	33.86	175	255	VERTICAL	Peak
3	15950.62	44.91	54.00	-9.09	32.17	10.14	38.38	35.78	179	165	VERTICAL	Average
4	15963.59	59.10	74.00	-14.90	46.35	10.15	38.38	35.78	179	165	VERTICAL	Peak



Temperature	22°C	Humidity	38%
Test Engineer	Gary Chu	Configurations	IEEE 802.11a CH 100 / Chain 3
Test Date	Jul. 09, 2015	Test Mode	Non-beamforming mode

Horizontal

	Freq	Level	Limit Line	Over Limit	Read Level	Cable Loss	Antenna Factor	Preamp Factor	A/Pos	T/Pos	Pol/Phase	Remark
	MHz	dBuV/m	dBuV/m	dB	dBuV	dB	dB/m	dB	cm	deg		
1	11002.34	57.58	74.00	-16.42	43.86	8.43	39.30	34.01	166	320	HORIZONTAL	Peak
2	11002.43	44.19	54.00	-9.81	30.47	8.43	39.30	34.01	166	320	HORIZONTAL	Average

Vertical

	Freq	Level	Limit Line	Over Limit	Read Level	Cable Loss	Antenna Factor	Preamp Factor	A/Pos	T/Pos	Pol/Phase	Remark
	MHz	dBuV/m	dBuV/m	dB	dBuV	dB	dB/m	dB	cm	deg		
1	11001.30	45.16	54.00	-8.84	31.44	8.43	39.30	34.01	190	256	VERTICAL	Average
2	11003.04	58.85	74.00	-15.15	45.13	8.43	39.30	34.01	190	256	VERTICAL	Peak



Temperature	22°C	Humidity	38%
Test Engineer	Gary Chu	Configurations	IEEE 802.11a CH 116 / Chain 3
Test Date	Jul. 09, 2015	Test Mode	Non-beamforming mode

Horizontal

	Freq	Level	Limit	Over	Read	CableAntenna	Preamp	A/Pos	T/Pos	Pol/Phase	Remark
	MHz	dBuV/m	dBuV/m	dB	dBuV	dB	dB/m	dB	cm	deg	
1	11161.19	47.14	54.00	-6.86	33.46	8.52	39.27	34.11	177	317	HORIZONTAL Average
2	11162.37	60.84	74.00	-13.16	47.16	8.52	39.27	34.11	177	317	HORIZONTAL Peak

Vertical

	Freq	Level	Limit	Over	Read	CableAntenna	Preamp	A/Pos	T/Pos	Pol/Phase	Remark
	MHz	dBuV/m	dBuV/m	dB	dBuV	dB	dB/m	dB	cm	deg	
1	11160.41	62.07	74.00	-11.93	48.39	8.52	39.27	34.11	187	250	VERTICAL Peak
2	11162.05	48.73	54.00	-5.27	35.05	8.52	39.27	34.11	187	250	VERTICAL Average



Temperature	22°C	Humidity	38%
Test Engineer	Gary Chu	Configurations	IEEE 802.11a CH 140 / Chain 3
Test Date	Jul. 09, 2015	Test Mode	Non-beamforming mode

Horizontal

	Freq	Level	Limit Line	Over Limit	Read Level	CableAntenna Loss	Antenna Factor	Preamp Factor	A/Pos	T/Pos	Pol/Phase	Remark
	MHz	dBuV/m	dBuV/m	dB	dBuV	dB	dB/m	dB	cm	deg		
1	11400.00	45.04	54.00	-8.96	31.44	8.66	39.22	34.28	166	123	HORIZONTAL	Average
2	11409.67	57.29	74.00	-16.71	43.67	8.68	39.22	34.28	166	123	HORIZONTAL	Peak

Vertical

	Freq	Level	Limit Line	Over Limit	Read Level	CableAntenna Loss	Antenna Factor	Preamp Factor	A/Pos	T/Pos	Pol/Phase	Remark
	MHz	dBuV/m	dBuV/m	dB	dBuV	dB	dB/m	dB	cm	deg		
1	11397.08	61.14	74.00	-12.86	47.54	8.66	39.22	34.28	186	293	VERTICAL	Peak
2	11401.91	47.36	54.00	-6.64	33.76	8.66	39.22	34.28	186	293	VERTICAL	Average

Temperature	22°C	Humidity	38%
Test Engineer	Gary Chu	Configurations	IEEE 802.11ac MCS0/Nss1 VHT20 CH 52 / Chain 3 + Chain 4 + Chain 5
Test Date	Jul. 09, 2015	Test Mode	Beamforming mode

Horizontal

	Freq	Level	Limit Line	Over Limit	Read Level	CableAntenna Loss	Antenna Factor	Preamp Factor	A/Pos	T/Pos	Pol/Phase	Remark
	MHz	dBuV/m	dBuV/m	dB	dBuV	dB	dB/m	dB	cm	deg		
1	15775.80	60.11	74.00	-13.89	47.46	10.10	38.31	35.76	152	210	HORIZONTAL	Peak
2	15780.87	47.11	54.00	-6.89	34.46	10.10	38.31	35.76	152	210	HORIZONTAL	Average

Vertical

	Freq	Level	Limit Line	Over Limit	Read Level	CableAntenna Loss	Antenna Factor	Preamp Factor	A/Pos	T/Pos	Pol/Phase	Remark
	MHz	dBuV/m	dBuV/m	dB	dBuV	dB	dB/m	dB	cm	deg		
1	15795.56	44.84	54.00	-9.16	32.17	10.10	38.33	35.76	147	91	VERTICAL	Average
2	15803.66	58.01	74.00	-15.99	45.34	10.10	38.33	35.76	147	91	VERTICAL	Peak



Temperature	22°C	Humidity	38%
Test Engineer	Gary Chu	Configurations	IEEE 802.11ac MCS0/Nss1 VHT20 CH 60 / Chain 3 + Chain 4 + Chain 5
Test Date	Jul. 09, 2015	Test Mode	Beamforming mode

Horizontal

	Freq	Level	Limit Line	Over Limit	Read Level	CableAntenna Loss	Antenna Factor	Preamp Factor	A/Pos	T/Pos	Pol/Phase	Remark
	MHz	dBuV/m	dBuV/m	dB	dBuV	dB	dB/m	dB	cm	deg		
1	10591.17	61.03	74.00	-12.97	47.49	8.31	39.06	33.83	194	222	HORIZONTAL	Peak
2	10601.08	47.72	54.00	-6.28	34.18	8.31	39.06	33.83	194	222	HORIZONTAL	Average
3	15900.14	59.34	74.00	-14.66	46.63	10.12	38.36	35.77	172	276	HORIZONTAL	Peak
4	15900.58	46.46	54.00	-7.54	33.75	10.12	38.36	35.77	172	276	HORIZONTAL	Average

Vertical

	Freq	Level	Limit Line	Over Limit	Read Level	CableAntenna Loss	Antenna Factor	Preamp Factor	A/Pos	T/Pos	Pol/Phase	Remark
	MHz	dBuV/m	dBuV/m	dB	dBuV	dB	dB/m	dB	cm	deg		
1	10600.00	47.26	54.00	-6.74	33.72	8.31	39.06	33.83	189	249	VERTICAL	Average
2	10600.07	60.31	74.00	-13.69	46.77	8.31	39.06	33.83	189	249	VERTICAL	Peak
3	15894.07	58.72	74.00	-15.28	46.01	10.12	38.36	35.77	100	9	VERTICAL	Peak
4	15898.70	46.20	54.00	-7.80	33.49	10.12	38.36	35.77	100	9	VERTICAL	Average



Temperature	22°C	Humidity	38%
Test Engineer	Gary Chu	Configurations	IEEE 802.11ac MCS0/Nss1 VHT20 CH 64 / Chain 3 + Chain 4 + Chain 5
Test Date	Jul. 09, 2015	Test Mode	Beamforming mode

Horizontal

	Freq	Level	Limit Line	Over Limit	Read Level	CableAntenna Loss	Antenna Factor	Preamp Factor	A/Pos	T/Pos	Pol/Phase	Remark
	MHz	dBuV/m	dBuV/m	dB	dBuV	dB	dB/m	dB	cm	deg		
1	10620.03	55.71	74.00	-18.29	42.17	8.32	39.06	33.84	142	188	HORIZONTAL	Peak
2	10653.17	43.04	54.00	-10.96	29.48	8.33	39.09	33.86	142	188	HORIZONTAL	Average
3	15939.16	58.35	74.00	-15.65	45.61	10.14	38.38	35.78	126	349	HORIZONTAL	Peak
4	15960.72	46.11	54.00	-7.89	33.37	10.14	38.38	35.78	126	348	HORIZONTAL	Average

Vertical

	Freq	Level	Limit Line	Over Limit	Read Level	CableAntenna Loss	Antenna Factor	Preamp Factor	A/Pos	T/Pos	Pol/Phase	Remark
	MHz	dBuV/m	dBuV/m	dB	dBuV	dB	dB/m	dB	cm	deg		
1	10640.22	56.18	74.00	-17.82	42.64	8.32	39.08	33.86	147	27	VERTICAL	Peak
2	10659.32	43.10	54.00	-10.90	29.54	8.33	39.09	33.86	147	27	VERTICAL	Average
3	15935.54	58.35	74.00	-15.65	45.61	10.14	38.38	35.78	184	81	VERTICAL	Peak
4	15949.15	44.96	54.00	-9.04	32.22	10.14	38.38	35.78	184	81	VERTICAL	Average



Temperature	22°C	Humidity	38%
Test Engineer	Gary Chu	Configurations	IEEE 802.11ac MCS0/Nss1 VHT20 CH 100 / Chain 3 + Chain 4 + Chain 5
Test Date	Jul. 09, 2015	Test Mode	Beamforming mode

Horizontal

	Freq	Level	Limit	Over	Read	Cable	Antenna	Preamp	A/Pos	T/Pos	Pol/Phase	Remark
	MHz	dBuV/m	dBuV/m	dB	dBuV	dB	dB/m	dB	cm	deg		
1	10999.20	45.12	54.00	-8.88	31.40	8.43	39.30	34.01	177	299	HORIZONTAL	Average
2	10999.57	58.06	74.00	-15.94	44.34	8.43	39.30	34.01	177	299	HORIZONTAL	Peak

Vertical

	Freq	Level	Limit	Over	Read	Cable	Antenna	Preamp	A/Pos	T/Pos	Pol/Phase	Remark
	MHz	dBuV/m	dBuV/m	dB	dBuV	dB	dB/m	dB	cm	deg		
1	11000.00	58.62	74.00	-15.38	44.90	8.43	39.30	34.01	189	244	VERTICAL	Peak
2	11000.22	46.01	54.00	-7.99	32.29	8.43	39.30	34.01	189	244	VERTICAL	Average



Temperature	22°C	Humidity	38%
Test Engineer	Gary Chu	Configurations	IEEE 802.11ac MCS0/Nss1 VHT20 CH 116 / Chain 3 + Chain 4 + Chain 5
Test Date	Jun. 30, 2015	Test Mode	Beamforming mode

Horizontal

	Freq	Level	Limit	Over	Read	CableAntenna	Preamp	A/Pos	T/Pos	Pol/Phase	Remark
	MHz	dBuV/m	dBuV/m	dB	dBuV	dB	dB/m	dB	cm	deg	
1	11160.00	49.29	54.00	-4.71	35.61	8.52	39.27	34.11	192	214	HORIZONTAL Average
2	11161.40	62.38	74.00	-11.62	48.70	8.52	39.27	34.11	192	214	HORIZONTAL Peak

Vertical

	Freq	Level	Limit	Over	Read	CableAntenna	Preamp	A/Pos	T/Pos	Pol/Phase	Remark
	MHz	dBuV/m	dBuV/m	dB	dBuV	dB	dB/m	dB	cm	deg	
1	11151.30	62.72	74.00	-11.28	49.04	8.52	39.27	34.11	233	250	VERTICAL Peak
2	11156.70	49.32	54.00	-4.68	35.64	8.52	39.27	34.11	233	250	VERTICAL Average



Temperature	22°C	Humidity	38%
Test Engineer	Gary Chu	Configurations	IEEE 802.11ac MCS0/Nss1 VHT20 CH 140 / Chain 3 + Chain 4 + Chain 5
Test Date	Jun. 30, 2015	Test Mode	Beamforming mode

Horizontal

	Freq	Level	Limit Line	Over Limit	Read Level	Cable Loss	Antenna Factor	Preamp Factor	A/Pos	T/Pos	Pol/Phase	Remark
	MHz	dBuV/m	dBuV/m	dB	dBuV	dB	dB/m	dB	cm	deg		
1	11396.20	45.19	54.00	-8.81	31.59	8.66	39.22	34.28	170	310	HORIZONTAL	Average
2	11402.80	57.94	74.00	-16.06	44.34	8.66	39.22	34.28	170	310	HORIZONTAL	Peak

Vertical

	Freq	Level	Limit Line	Over Limit	Read Level	Cable Loss	Antenna Factor	Preamp Factor	A/Pos	T/Pos	Pol/Phase	Remark
	MHz	dBuV/m	dBuV/m	dB	dBuV	dB	dB/m	dB	cm	deg		
1	11410.80	56.20	74.00	-17.80	42.58	8.68	39.22	34.28	114	200	VERTICAL	Peak
2	11422.80	43.44	54.00	-10.56	29.83	8.68	39.21	34.28	114	200	VERTICAL	Average



Temperature	22°C	Humidity	38%
Test Engineer	Gary Chu	Configurations	IEEE 802.11ac MCS0/Nss1 VHT40 CH 54 / Chain 3 + Chain 4 + Chain 5
Test Date	Jun. 29, 2015	Test Mode	Beamforming mode

Horizontal

	Freq	Level	Limit	Over	Read	CableAntenna	Preamp	A/Pos	T/Pos	Pol/Phase	Remark
	MHz	dBuV/m	dBuV/m	dB	dBuV	dB	dB/m	dB	cm	deg	
1	15800.71	43.17	54.00	-10.83	30.50	10.10	38.33	35.76	176	198	HORIZONTAL Average
2	15800.96	56.09	74.00	-17.91	43.42	10.10	38.33	35.76	176	198	HORIZONTAL Peak

Vertical

	Freq	Level	Limit	Over	Read	CableAntenna	Preamp	A/Pos	T/Pos	Pol/Phase	Remark
	MHz	dBuV/m	dBuV/m	dB	dBuV	dB	dB/m	dB	cm	deg	
1	15802.02	57.09	74.00	-16.91	44.42	10.10	38.33	35.76	153	294	VERTICAL Peak
2	15807.24	42.83	54.00	-11.17	30.15	10.11	38.33	35.76	153	294	VERTICAL Average



Temperature	22°C	Humidity	38%
Test Engineer	Gary Chu	Configurations	IEEE 802.11ac MCS0/Nss1 VHT40 CH 62 / Chain 3 + Chain 4 + Chain 5
Test Date	Jun. 29, 2015	Test Mode	Beamforming mode

Horizontal

	Freq	Level	Limit	Over	Read	CableAntenna	Preamp	A/Pos	T/Pos	Pol/Phase	Remark
	MHz	dBuV/m	dBuV/m	dB	dBuV	dB	dB/m	dB	cm	deg	
1	10610.26	42.08	54.00	-11.92	28.54	8.32	39.06	33.84	174	172	HORIZONTAL Average
2	10629.58	55.01	74.00	-18.99	41.45	8.32	39.08	33.84	174	172	HORIZONTAL Peak
3	15930.80	57.68	74.00	-16.32	44.94	10.14	38.38	35.78	147	210	HORIZONTAL Peak
4	15933.37	43.25	54.00	-10.75	30.51	10.14	38.38	35.78	147	210	HORIZONTAL Average

Vertical

	Freq	Level	Limit	Over	Read	CableAntenna	Preamp	A/Pos	T/Pos	Pol/Phase	Remark
	MHz	dBuV/m	dBuV/m	dB	dBuV	dB	dB/m	dB	cm	deg	
1	10619.71	42.26	54.00	-11.74	28.72	8.32	39.06	33.84	217	43	VERTICAL Average
2	10628.65	55.44	74.00	-18.56	41.88	8.32	39.08	33.84	217	70	VERTICAL Peak
3	15927.31	43.27	54.00	-10.73	30.53	10.14	38.38	35.78	146	131	VERTICAL Average
4	15928.40	56.37	74.00	-17.63	43.63	10.14	38.38	35.78	146	131	VERTICAL Peak

Temperature	22°C	Humidity	38%
Test Engineer	Gary Chu	Configurations	IEEE 802.11ac MCS0/Nss1 VHT40 CH 102 / Chain 3 + Chain 4 + Chain 5
Test Date	Jun. 29, 2015	Test Mode	Beamforming mode

Horizontal

	Freq	Level	Limit	Over	Read	CableAntenna	Preamp	A/Pos	T/Pos	Pol/Phase	Remark
	MHz	dBuV/m	dBuV/m	dB	dBuV	Loss	Factor	Factor	cm	deg	
1	11016.89	42.42	54.00	-11.58	28.70	8.43	39.30	34.01	167	323	HORIZONTAL Average
2	11019.13	55.64	74.00	-18.36	41.92	8.43	39.30	34.01	167	323	HORIZONTAL Peak

Vertical

	Freq	Level	Limit	Over	Read	CableAntenna	Preamp	A/Pos	T/Pos	Pol/Phase	Remark
	MHz	dBuV/m	dBuV/m	dB	dBuV	Loss	Factor	Factor	cm	deg	
1	11010.58	42.38	54.00	-11.62	28.66	8.43	39.30	34.01	212	116	VERTICAL Average
2	11011.76	55.67	74.00	-18.33	41.95	8.43	39.30	34.01	212	116	VERTICAL Peak

Temperature	22°C	Humidity	38%
Test Engineer	Gary Chu	Configurations	IEEE 802.11ac MCS0/Nss1 VHT40 CH 110 / Chain 3 + Chain 4 + Chain 5
Test Date	Jun. 29, 2015	Test Mode	Beamforming mode

Horizontal

	Freq	Level	Limit Line	Over Limit	Read Level	CableAntenna Loss	Antenna Factor	Preamp Factor	A/Pos	T/Pos	Pol/Phase	Remark
	MHz	dBuV/m	dBuV/m	dB	dBuV	dB	dB/m	dB	cm	deg		
1	11101.86	60.49	74.00	-13.51	46.81	8.48	39.28	34.08	195	252	HORIZONTAL	Peak
2	11102.47	46.42	54.00	-7.58	32.74	8.48	39.28	34.08	195	252	HORIZONTAL	Average

Vertical

	Freq	Level	Limit Line	Over Limit	Read Level	CableAntenna Loss	Antenna Factor	Preamp Factor	A/Pos	T/Pos	Pol/Phase	Remark
	MHz	dBuV/m	dBuV/m	dB	dBuV	dB	dB/m	dB	cm	deg		
1	11101.09	59.03	74.00	-14.97	45.33	8.48	39.28	34.06	190	237	VERTICAL	Peak
2	11101.67	45.81	54.00	-8.19	32.13	8.48	39.28	34.08	190	237	VERTICAL	Average



Temperature	22°C	Humidity	38%
Test Engineer	Gary Chu	Configurations	IEEE 802.11ac MCS0/Nss1 VHT40 CH 134 / Chain 3 + Chain 4 + Chain 5
Test Date	Jun. 29, 2015	Test Mode	Beamforming mode

Horizontal

	Freq	Level	Limit	Over	Read	CableAntenna	Preamp	A/Pos	T/Pos	Pol/Phase	Remark
	MHz	dBuV/m	dBuV/m	dB	dBuV	dB	dB/m	dB	cm	deg	
1	11340.61	43.73	54.00	-10.27	30.09	8.64	39.23	34.23	196	285	HORIZONTAL Average
2	11341.47	56.83	74.00	-17.17	43.19	8.64	39.23	34.23	196	285	HORIZONTAL Peak

Vertical

	Freq	Level	Limit	Over	Read	CableAntenna	Preamp	A/Pos	T/Pos	Pol/Phase	Remark
	MHz	dBuV/m	dBuV/m	dB	dBuV	dB	dB/m	dB	cm	deg	
1	11331.25	58.24	74.00	-15.76	44.60	8.64	39.23	34.23	171	266	VERTICAL Peak
2	11334.01	44.49	54.00	-9.51	30.85	8.64	39.23	34.23	171	266	VERTICAL Average



Temperature	22°C	Humidity	38%
Test Engineer	Gary Chu	Configurations	IEEE 802.11ac MCS0/Nss1 VHT80 CH 58 / Chain 3 + Chain 4 + Chain 5
Test Date	Jun. 29, 2015	Test Mode	Beamforming mode

Horizontal

	Freq	Level	Limit	Over	Read	CableAntenna	Preamp	A/Pos	T/Pos	Pol/Phase	Remark
	MHz	dBuV/m	dBuV/m	dB	dBuV	dB	dB/m	dB	cm	deg	
1	15862.08	56.30	74.00	-17.70	43.60	10.12	38.35	35.77	162	109	HORIZONTAL Peak
2	15875.26	43.04	54.00	-10.96	30.33	10.12	38.36	35.77	162	109	HORIZONTAL Average

Vertical

	Freq	Level	Limit	Over	Read	CableAntenna	Preamp	A/Pos	T/Pos	Pol/Phase	Remark
	MHz	dBuV/m	dBuV/m	dB	dBuV	dB	dB/m	dB	cm	deg	
1	15876.12	55.79	74.00	-18.21	43.08	10.12	38.36	35.77	182	310	VERTICAL Peak
2	15879.87	43.02	54.00	-10.98	30.31	10.12	38.36	35.77	182	310	VERTICAL Average

Temperature	22°C	Humidity	38%
Test Engineer	Gary Chu	Configurations	IEEE 802.11ac MCS0/Nss1 VHT80 CH 106 / Chain 3 + Chain 4 + Chain 5
Test Date	Jun. 29, 2015	Test Mode	Beamforming mode

Horizontal

	Freq	Level	Limit Line	Over Limit	Read Level	CableAntenna Loss Factor	Preamp Factor	A/Pos	T/Pos	Pol/Phase	Remark
	MHz	dBuV/m	dBuV/m	dB	dBuV	dB	dB/m	dB	cm	deg	
1	11060.10	55.47	74.00	-18.53	41.76	8.45	39.29	34.03	180	248	HORIZONTAL Peak
2	11067.88	42.15	54.00	-11.85	28.47	8.45	39.29	34.06	180	248	HORIZONTAL Average

Vertical

	Freq	Level	Limit Line	Over Limit	Read Level	CableAntenna Loss Factor	Preamp Factor	A/Pos	T/Pos	Pol/Phase	Remark
	MHz	dBuV/m	dBuV/m	dB	dBuV	dB	dB/m	dB	cm	deg	
1	11050.93	55.22	74.00	-18.78	41.51	8.45	39.29	34.03	160	325	VERTICAL Peak
2	11057.34	42.29	54.00	-11.71	28.58	8.45	39.29	34.03	160	325	VERTICAL Average

Note:

The amplitude of spurious emissions that are attenuated by more than 20dB below the permissible value has no need to be reported.

Emission level (dBuV/m) = 20 log Emission level (uV/m).

Corrected Reading: Antenna Factor + Cable Loss + Read Level - Preamp Factor = Level.

4.5. Band Edge Emissions Measurement

4.5.1. Limit

For transmitters operating in the 5.25-5.35 GHz band: all emissions outside of the 5.15-5.35 GHz band shall not exceed an e.i.r.p. of -27 dBm/MHz.

For transmitters operating in the 5.470-5.725 GHz band: all emissions outside of the 5.47-5.725 GHz band shall not exceed an e.i.r.p. of -27 dBm/MHz.

In addition, In case the emission fall within the restricted band specified on 15.205(a), then the 15.209(a) limit in the table below has to be followed.

Frequencies (MHz)	Field Strength (micorvolts/meter)	Measurement Distance (meters)
0.009~0.490	2400/F(kHz)	300
0.490~1.705	24000/F(kHz)	30
1.705~30.0	30	30
30~88	100	3
88~216	150	3
216~960	200	3
Above 960	500	3

4.5.2. Measuring Instruments and Setting

Please refer to section 5 of equipments list in this report. The following table is the setting of the spectrum analyzer.

Spectrum Parameter	Setting
Attenuation	Auto
Span Frequency	100 MHz
RBW / VBW (Emission in restricted band)	1 MHz / 3MHz for Peak, 1 MHz / 1/T for Average
RBW / VBW (Emission in non-restricted band)	1 MHz / 3MHz for Peak

4.5.3. Test Procedures

1. The test procedure is the same as section 4.4.3.

4.5.4. Test Setup Layout

This test setup layout is the same as that shown in section 4.4.4.

4.5.5. Test Deviation

There is no deviation with the original standard.

4.5.6. EUT Operation during Test

For non-beamforming mode:

The EUT was programmed to be in continuously transmitting mode.

For beamforming mode:

The EUT was programmed to be in beamforming transmitting mode.

4.5.7. Test Result of Band Edge and Fundamental Emissions

Temperature	22°C	Humidity	38%
Test Engineer	Gary Chu	Configurations	IEEE 802.11a CH 52, 60, 64 / Chain 3
Test Date	Jul. 08, 2015	Test Mode	Non-beamforming mode

Channel 52

	Freq	Level	Limit	Over	Read	CableAntenna	Preamp	A/Pos	T/Pos	Pol/Phase	Remark
	MHz	dBuV/m	dBuV/m	dB	dBuV	dB	dB/m	dB	cm	deg	
1	5141.32	46.08	54.00	-7.92	41.76	5.51	33.15	34.34	200	354 VERTICAL	Average
2	5144.93	58.26	74.00	-15.74	53.92	5.51	33.17	34.34	200	354 VERTICAL	Peak
3	5259.28	101.25			96.66	5.56	33.36	34.33	200	354 VERTICAL	Average
4	5259.28	111.76			107.17	5.56	33.36	34.33	200	354 VERTICAL	Peak
5	5373.15	46.83	54.00	-7.17	41.97	5.60	33.58	34.32	200	354 VERTICAL	Average
6	5380.39	60.26	74.00	-13.74	55.40	5.60	33.58	34.32	200	354 VERTICAL	Peak

Item 3, 4 are the fundamental frequency at 5260 MHz.

Channel 60

	Freq	Level	Limit	Over	Read	CableAntenna	Preamp	A/Pos	T/Pos	Pol/Phase	Remark
	MHz	dBuV/m	dBuV/m	dB	dBuV	dB	dB/m	dB	cm	deg	
1	5301.45	102.19			97.50	5.57	33.45	34.33	186	2 HORIZONTAL	Average
2	5302.89	112.23			107.54	5.57	33.45	34.33	186	2 HORIZONTAL	Peak
3	5378.22	62.64	74.00	-11.36	57.78	5.60	33.58	34.32	186	2 HORIZONTAL	Peak
4	5378.94	51.49	54.00	-2.51	46.63	5.60	33.58	34.32	186	2 HORIZONTAL	Average

Item 1, 2 are the fundamental frequency at 5300 MHz.

Channel 64

	Freq	Level	Limit	Over	Read	CableAntenna	Preamp	A/Pos	T/Pos	Pol/Phase	Remark
	MHz	dBuV/m	dBuV/m	dB	dBuV	dB	dB/m	dB	cm	deg	
1	5319.28	110.79			106.07	5.58	33.47	34.33	184	358 VERTICAL	Peak
2	5321.45	100.88			96.16	5.58	33.47	34.33	184	358 VERTICAL	Average
3	5350.00	53.62	54.00	-0.38	48.82	5.59	33.53	34.32	184	358 VERTICAL	Average
4	5350.00	68.93	74.00	-5.07	64.13	5.59	33.53	34.32	184	358 VERTICAL	Peak

Item 1, 2 are the fundamental frequency at 5320 MHz.

Temperature	22°C	Humidity	38%
Test Engineer	Gary Chu	Configurations	IEEE 802.11a CH 100, 116, 140 / Chain 3
Test Date	Jul. 08, 2015	Test Mode	Non-beamforming mode

Channel 100

	Freq	Level	Limit Line	Over Limit	Read Level	Cable Loss	Antenna Factor	Preamp Factor	A/Pos	T/Pos	Pol/Phase	Remark
	MHz	dBuV/m	dBuV/m	dB	dBuV	dB	dB/m	dB	cm	deg		
1	5418.03	50.43	54.00	-3.57	45.47	5.62	33.66	34.32	211	168	VERTICAL	Average
2	5460.00	68.17	74.00	-5.83	63.13	5.63	33.72	34.31	211	168	VERTICAL	Peak
3	5470.00	53.89	54.00	-0.11	48.81	5.64	33.75	34.31	211	168	VERTICAL	Average
4	5470.00	71.63	74.00	-2.37	66.55	5.64	33.75	34.31	211	168	VERTICAL	Peak
5	5499.28	111.12			105.98	5.65	33.80	34.31	211	168	VERTICAL	Peak
6	5501.45	100.68			95.54	5.65	33.80	34.31	211	168	VERTICAL	Average

Item 5, 6 are the fundamental frequency at 5500 MHz.

Channel 116

	Freq	Level	Limit Line	Over Limit	Read Level	Cable Loss	Antenna Factor	Preamp Factor	A/Pos	T/Pos	Pol/Phase	Remark
	MHz	dBuV/m	dBuV/m	dB	dBuV	dB	dB/m	dB	cm	deg		
1	5459.28	47.78	54.00	-6.22	42.74	5.63	33.72	34.31	196	167	VERTICAL	Average
2	5460.00	62.63	74.00	-11.37	57.59	5.63	33.72	34.31	196	167	VERTICAL	Peak
3	5467.83	47.79	54.00	-6.21	42.72	5.63	33.75	34.31	196	167	VERTICAL	Average
4	5470.00	62.31	74.00	-11.69	57.23	5.64	33.75	34.31	196	167	VERTICAL	Peak
5	5581.45	102.55			97.11	5.72	34.05	34.33	196	167	VERTICAL	Average
6	5583.62	112.55			107.11	5.72	34.05	34.33	196	167	VERTICAL	Peak
7	5725.00	61.39	74.00	-12.61	55.40	5.85	34.50	34.36	196	167	VERTICAL	Peak
8	5726.45	47.66	54.00	-6.34	41.67	5.85	34.50	34.36	196	167	VERTICAL	Average

Item 5, 6 are the fundamental frequency at 5580 MHz.

Channel 140

	Freq	Level	Limit Line	Over Limit	Read Level	Cable Loss	Antenna Factor	Preamp Factor	A/Pos	T/Pos	Pol/Phase	Remark
	MHz	dBuV/m	dBuV/m	dB	dBuV	dB	dB/m	dB	cm	deg		
1	5698.55	108.71			102.83	5.83	34.40	34.35	198	158	VERTICAL	Peak
2	5701.45	98.46			92.58	5.83	34.40	34.35	198	158	VERTICAL	Average
3	5725.00	53.64	54.00	-0.36	47.65	5.85	34.50	34.36	198	158	VERTICAL	Average
4	5725.72	69.23	74.00	-4.77	63.24	5.85	34.50	34.36	198	158	VERTICAL	Peak

Item 1, 2 are the fundamental frequency at 5700 MHz.

Temperature	22°C	Humidity	38%
Test Engineer	Gary Chu	Configurations	IEEE 802.11ac MCS0/Nss1 VHT20 CH 52, 60, 64 / Chain 3 + Chain 4 + Chain 5
Test Date	Jun. 30, 2015	Test Mode	Beamforming mode

Channel 52

	Freq	Level	Limit Line	Over Limit	Read Level	CableAntenna Loss	Antenna Factor	Preamp Factor	A/Pos	T/Pos	Pol/Phase	Remark
	MHz	dBuV/m	dBuV/m	dB	dBuV	dB	dB/m	dB	cm	deg		
1	5148.00	47.82	54.00	-6.18	43.48	5.51	33.17	34.34	183	350	VERTICAL	Average
2	5149.00	60.72	74.00	-13.28	56.38	5.51	33.17	34.34	183	350	VERTICAL	Peak
3	5268.00	108.87			104.25	5.56	33.39	34.33	183	350	VERTICAL	Average
4	5268.00	117.86			113.24	5.56	33.39	34.33	183	350	VERTICAL	Peak
5	5350.00	49.20	54.00	-4.80	44.40	5.59	33.53	34.32	183	350	VERTICAL	Average
6	5388.00	60.64	74.00	-13.36	55.75	5.60	33.61	34.32	183	350	VERTICAL	Peak

Item 3, 4 are the fundamental frequency at 5260 MHz.

Channel 60

	Freq	Level	Limit Line	Over Limit	Read Level	CableAntenna Loss	Antenna Factor	Preamp Factor	A/Pos	T/Pos	Pol/Phase	Remark
	MHz	dBuV/m	dBuV/m	dB	dBuV	dB	dB/m	dB	cm	deg		
1	5301.00	115.72			111.03	5.57	33.45	34.33	177	1	VERTICAL	Peak
2	5302.00	105.27			100.58	5.57	33.45	34.33	177	1	VERTICAL	Average
3	5380.00	53.75	54.00	-0.25	48.89	5.60	33.58	34.32	177	1	VERTICAL	Average
4	5383.00	64.71	74.00	-9.29	59.85	5.60	33.58	34.32	177	1	VERTICAL	Peak

Item 1, 2 are the fundamental frequency at 5300 MHz.

Channel 64

	Freq	Level	Limit Line	Over Limit	Read Level	CableAntenna Loss	Antenna Factor	Preamp Factor	A/Pos	T/Pos	Pol/Phase	Remark
	MHz	dBuV/m	dBuV/m	dB	dBuV	dB	dB/m	dB	cm	deg		
1	5312.00	104.60			99.88	5.58	33.47	34.33	196	213	HORIZONTAL	Average
2	5321.00	114.29			109.57	5.58	33.47	34.33	196	213	HORIZONTAL	Peak
3	5350.00	65.06	74.00	-8.94	60.26	5.59	33.53	34.32	196	213	HORIZONTAL	Peak
4	5392.00	53.99	54.00	-0.01	49.10	5.60	33.61	34.32	196	213	HORIZONTAL	Average

Item 1, 2 are the fundamental frequency at 5320 MHz.

Temperature	22°C	Humidity	38%
Test Engineer	Gary Chu	Configurations	IEEE 802.11ac MCS0/Nss1 VHT20 CH 100, 116, 140 / Chain 3 + Chain 4 + Chain 5
Test Date	Jun. 30, 2015	Test Mode	Beamforming mode

Channel 100

	Freq	Level	Limit Line	Over Limit	Read Level	CableAntenna Loss	Antenna Factor	Preamp Factor	A/Pos	T/Pos	Pol/Phase	Remark
	MHz	dBuV/m	dBuV/m	dB	dBuV	dB	dB/m	dB	cm	deg		
1	5428.00	53.91	54.00	-0.09	48.95	5.62	33.66	34.32	216	222	HORIZONTAL	Average
2	5428.00	64.24	74.00	-9.76	59.28	5.62	33.66	34.32	216	222	HORIZONTAL	Peak
3	5470.00	46.43	54.00	-7.57	41.35	5.64	33.75	34.31	216	222	HORIZONTAL	Average
4	5470.00	59.17	74.00	-14.83	54.09	5.64	33.75	34.31	216	222	HORIZONTAL	Peak
5	5508.00	115.05			109.90	5.66	33.80	34.31	216	222	HORIZONTAL	Peak
6	5509.00	105.55			100.40	5.66	33.80	34.31	216	222	HORIZONTAL	Average

Item 5, 6 are the fundamental frequency at 5500 MHz.

Channel 116

	Freq	Level	Limit Line	Over Limit	Read Level	CableAntenna Loss	Antenna Factor	Preamp Factor	A/Pos	T/Pos	Pol/Phase	Remark
	MHz	dBuV/m	dBuV/m	dB	dBuV	dB	dB/m	dB	cm	deg		
1	5452.00	50.66	54.00	-3.34	45.62	5.63	33.72	34.31	200	225	HORIZONTAL	Average
2	5454.00	62.24	74.00	-11.76	57.20	5.63	33.72	34.31	200	225	HORIZONTAL	Peak
3	5462.00	59.69	74.00	-14.31	54.65	5.63	33.72	34.31	200	225	HORIZONTAL	Peak
4	5468.00	46.94	54.00	-7.06	41.87	5.63	33.75	34.31	200	225	HORIZONTAL	Average
5	5572.00	109.80			104.42	5.71	34.00	34.33	200	225	HORIZONTAL	Average
6	5572.00	119.03			113.65	5.71	34.00	34.33	200	225	HORIZONTAL	Peak
7	5725.00	61.15	74.00	-12.85	55.16	5.85	34.50	34.36	200	225	HORIZONTAL	Peak
8	5733.00	47.11	54.00	-6.89	41.10	5.87	34.50	34.36	200	225	HORIZONTAL	Average

Item 5, 6 are the fundamental frequency at 5580 MHz.

Channel 140

	Freq	Level	Limit Line	Over Limit	Read Level	CableAntenna Loss	Antenna Factor	Preamp Factor	A/Pos	T/Pos	Pol/Phase	Remark
	MHz	dBuV/m	dBuV/m	dB	dBuV	dB	dB/m	dB	cm	deg		
1	5692.00	105.13			99.25	5.83	34.40	34.35	197	158	VERTICAL	Average
2	5699.00	114.91			109.03	5.83	34.40	34.35	197	158	VERTICAL	Peak
3	5725.00	69.48	74.00	-4.52	63.49	5.85	34.50	34.36	197	158	VERTICAL	Peak
4	5778.00	53.98	54.00	-0.02	47.80	5.90	34.65	34.37	197	158	VERTICAL	Average

Item 1, 2 are the fundamental frequency at 5700 MHz.

Temperature	22°C	Humidity	38%
Test Engineer	Gary Chu	Configurations	IEEE 802.11ac MCS0/Nss1 VHT40 CH 54, 62 / Chain 3 + Chain 4 + Chain 5
Test Date	Jun. 29, 2015	Test Mode	Beamforming mode

Channel 54

	Freq	Level	Limit Line	Over Limit	Read Level	CableAntenna Loss	Preamp Factor	A/Pos	T/Pos	Pol/Phase	Remark
	MHz	dBuV/m	dBuV/m	dB	dBuV	dB	dB/m	dB	cm	deg	
1	5266.64	105.02			100.40	5.56	33.39	34.33	190	359	VERTICAL Average
2	5268.56	114.59			109.97	5.56	33.39	34.33	190	359	VERTICAL Peak
3	5353.17	53.68	54.00	-0.32	48.88	5.59	33.53	34.32	190	359	VERTICAL Average
4	5353.65	64.28	74.00	-9.72	59.48	5.59	33.53	34.32	190	359	VERTICAL Peak

Item 1, 2 are the fundamental frequency at 5270 MHz.

Channel 62

	Freq	Level	Limit Line	Over Limit	Read Level	CableAntenna Loss	Preamp Factor	A/Pos	T/Pos	Pol/Phase	Remark
	MHz	dBuV/m	dBuV/m	dB	dBuV	dB	dB/m	dB	cm	deg	
1	5315.77	100.36			95.64	5.58	33.47	34.33	210	357	VERTICAL Average
2	5324.42	109.69			104.94	5.58	33.50	34.33	210	357	VERTICAL Peak
3	5350.87	68.03	74.00	-5.97	63.23	5.59	33.53	34.32	210	357	VERTICAL Peak
4	5351.35	53.62	54.00	-0.38	48.82	5.59	33.53	34.32	210	357	VERTICAL Average

Item 1, 2 are the fundamental frequency at 5310 MHz.

Temperature	22°C	Humidity	38%
Test Engineer	Gary Chu	Configurations	IEEE 802.11ac MCS0/Nss1 VHT40 CH 102, 110, 134 / Chain 3 + Chain 4 + Chain 5
Test Date	Jun. 29, 2015	Test Mode	Beamforming mode

Channel 102

	Freq	Level	Limit	Over	Read	CableAntenna	Preamp	A/Pos	T/Pos	Pol/Phase	Remark
	MHz	dBuV/m	dBuV/m	dB	dBuV	dB	dB/m	dB	cm	deg	
1	5437.40	49.66	54.00	-4.34	44.66	5.63	33.69	34.32	210	360	VERTICAL Average
2	5460.00	64.20	74.00	-9.80	59.16	5.63	33.72	34.31	210	360	VERTICAL Peak
3	5469.14	69.70	74.00	-4.30	64.62	5.64	33.75	34.31	210	360	VERTICAL Peak
4	5470.00	53.84	54.00	-0.16	48.76	5.64	33.75	34.31	210	360	VERTICAL Average
5	5513.85	100.25			95.05	5.66	33.85	34.31	210	360	VERTICAL Average
6	5516.25	110.80			105.60	5.66	33.85	34.31	210	360	VERTICAL Peak

Item 5, 6 are the fundamental frequency at 5510 MHz.

Channel 110

	Freq	Level	Limit	Over	Read	CableAntenna	Preamp	A/Pos	T/Pos	Pol/Phase	Remark
	MHz	dBuV/m	dBuV/m	dB	dBuV	dB	dB/m	dB	cm	deg	
1	5456.25	52.34	54.00	-1.66	47.30	5.63	33.72	34.31	209	360	VERTICAL Average
2	5459.14	64.26	74.00	-9.74	59.22	5.63	33.72	34.31	209	360	VERTICAL Peak
3	5464.90	53.67	54.00	-0.33	48.60	5.63	33.75	34.31	209	360	VERTICAL Average
4	5467.79	64.64	74.00	-9.36	59.57	5.63	33.75	34.31	209	360	VERTICAL Peak
5	5544.71	104.24			98.92	5.69	33.95	34.32	209	360	VERTICAL Average
6	5547.12	114.23			108.91	5.69	33.95	34.32	209	360	VERTICAL Peak

Item 5, 6 are the fundamental frequency at 5550 MHz.

Channel 134

	Freq	Level	Limit	Over	Read	CableAntenna	Preamp	A/Pos	T/Pos	Pol/Phase	Remark
	MHz	dBuV/m	dBuV/m	dB	dBuV	dB	dB/m	dB	cm	deg	
1	5672.89	114.35			108.54	5.81	34.35	34.35	202	207	HORIZONTAL Peak
2	5676.25	103.90			98.09	5.81	34.35	34.35	202	207	HORIZONTAL Average
3	5733.46	69.78	74.00	-4.22	63.77	5.87	34.50	34.36	202	207	HORIZONTAL Peak
4	5755.10	53.97	54.00	-0.03	47.91	5.88	34.55	34.37	202	207	HORIZONTAL Average

Item 1, 2 are the fundamental frequency at 5670 MHz.

Temperature	22°C	Humidity	38%
Test Engineer	Gary Chu	Configurations	IEEE 802.11ac MCS0/Nss1 VHT80 CH 58, 106 / Chain 3 + Chain 4 + Chain 5
Test Date	Jun. 29, 2015	Test Mode	Beamforming mode

Channel 58

	Freq	Level	Limit Line	Over Limit	Read Level	CableAntenna Loss	Preamp Factor	A/Pos	T/Pos	Pol/Phase	Remark
	MHz	dBuV/m	dBuV/m	dB	dBuV	dB	dB/m	cm	deg		
1	5117.72	57.47	74.00	-16.53	53.20	5.50	33.12	34.35	185	350 VERTICAL	Peak
2	5144.17	46.02	54.00	-7.98	41.68	5.51	33.17	34.34	185	350 VERTICAL	Average
3	5261.96	96.25			91.66	5.56	33.36	34.33	185	350 VERTICAL	Average
4	5282.79	106.70			102.05	5.56	33.42	34.33	185	350 VERTICAL	Peak
5	5351.70	53.86	54.00	-0.14	49.06	5.59	33.53	34.32	185	350 VERTICAL	Average
6	5353.30	69.46	74.00	-4.54	64.66	5.59	33.53	34.32	185	350 VERTICAL	Peak

Item 3, 4 are the fundamental frequency at 5290 MHz.

Channel 106

	Freq	Level	Limit Line	Over Limit	Read Level	CableAntenna Loss	Preamp Factor	A/Pos	T/Pos	Pol/Phase	Remark
	MHz	dBuV/m	dBuV/m	dB	dBuV	dB	dB/m	cm	deg		
1	5454.39	67.66	74.00	-6.34	62.62	5.63	33.72	34.31	221	360 VERTICAL	Peak
2	5456.28	52.03	54.00	-1.97	46.99	5.63	33.72	34.31	221	360 VERTICAL	Average
3	5470.00	53.67	54.00	-0.33	48.59	5.64	33.75	34.31	221	360 VERTICAL	Average
4	5470.00	68.57	74.00	-5.43	63.49	5.64	33.75	34.31	221	360 VERTICAL	Peak
5	5539.62	96.40			91.14	5.68	33.90	34.32	221	360 VERTICAL	Average
6	5544.42	105.57			100.25	5.69	33.95	34.32	221	360 VERTICAL	Peak
7	5725.00	47.06	54.00	-6.94	41.07	5.85	34.50	34.36	221	360 VERTICAL	Average
8	5729.01	59.48	74.00	-14.52	53.47	5.87	34.50	34.36	221	360 VERTICAL	Peak

Item 5, 6 are the fundamental frequency at 5530 MHz.

Note:

Emission level (dBuV/m) = 20 log Emission level (uV/m)

Corrected Reading: Antenna Factor + Cable Loss + Read Level - Preamp Factor = Level

4.6. Frequency Stability Measurement

4.6.1. Limit

In-band emission is maintained within the band of operation under all conditions of normal operation as specified in the user's manual.

The transmitter center frequency tolerance shall be ± 20 ppm maximum for the 5 GHz band (IEEE 802.11n specification).

4.6.2. Measuring Instruments and Setting

Please refer to section 5 of equipments list in this report. The following table is the setting of the spectrum analyzer.

Spectrum Parameter	Setting
Attenuation	Auto
Span Frequency	Entire absence of modulation emissions bandwidth
RBW	10 kHz
VBW	10 kHz
Sweep Time	Auto

4.6.3. Test Procedures

1. The transmitter output (antenna port) was connected to the spectrum analyzer.
2. EUT have transmitted absence of modulation signal and fixed channelize.
3. Set the spectrum analyzer span to view the entire absence of modulation emissions bandwidth.
4. Set RBW = 10 kHz, VBW = 10 kHz with peak detector and maxhold settings.
5. f_c is declaring of channel frequency. Then the frequency error formula is $(f_c - f) / f_c \times 10^6$ ppm and the limit is less than ± 20 ppm (IEEE 802.11n specification).
6. The test extreme voltage is to change the primary supply voltage from 85 to 115 percent of the nominal value
7. Extreme temperature is $0^\circ\text{C} \sim 40^\circ\text{C}$.

4.6.4. Test Setup Layout

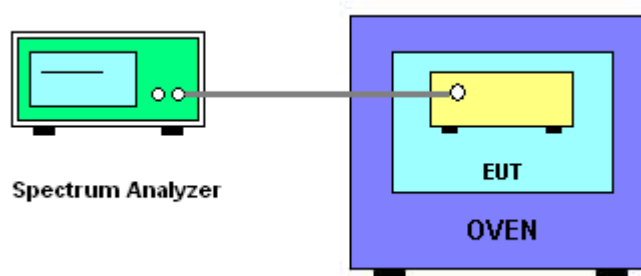

4.6.5. Test Deviation

There is no deviation with the original standard.

4.6.6. EUT Operation during Test

The EUT was programmed to be in continuously un-modulation transmitting mode.

4.6.7. Test Result of Frequency Stability

Temperature	20°C	Humidity	59%
Test Engineer	Lucas Huang	Test Date	Jun. 30, 2015

Mode: 20 MHz

Voltage vs. Frequency Stability

Voltage	Measurement Frequency (MHz)	
	5300 MHz	5580 MHz
(V)		
126.50	5300.0466	5580.0655
110.00	5300.0456	5580.0477
93.50	5300.0656	5580.0655
Max. Deviation (MHz)	0.0656	0.0655
Max. Deviation (ppm)	12.38	11.74

Temperature vs. Frequency Stability

Temperature	Measurement Frequency (MHz)	
	5300 MHz	5580 MHz
(°C)		
0	5300.0477	5580.0599
10	5300.0699	5580.0599
20	5300.0530	5580.0655
30	5300.0544	5580.0544
40	5300.0566	5580.0544
Max. Deviation (MHz)	0.0699	0.0655
Max. Deviation (ppm)	13.19	11.74

Mode: 40 MHz

Voltage vs. Frequency Stability

Voltage	Measurement Frequency (MHz)	
(V)	5310 MHz	5550 MHz
126.50	5310.0596	5550.0699
110.00	5310.0599	5550.0549
93.50	5310.0599	5550.0996
Max. Deviation (MHz)	0.0599	0.0996
Max. Deviation (ppm)	11.28	17.95

Temperature vs. Frequency Stability

Temperature	Measurement Frequency (MHz)	
(°C)	5310 MHz	5550 MHz
0	5310.0578	5550.0655
10	5310.0569	5550.0655
20	5310.0590	5550.0655
30	5310.0597	5550.0655
40	5310.0598	5550.0655
Max. Deviation (MHz)	0.0598	0.0655
Max. Deviation (ppm)	11.26	11.80

Mode: 80 MHz

Voltage vs. Frequency Stability

Voltage	Measurement Frequency (MHz)	
(V)	5290 MHz	5530 MHz
126.50	5290.0565	5530.0544
110.00	5290.0569	5530.0596
93.50	5290.0599	5530.0699
Max. Deviation (MHz)	0.0599	0.0699
Max. Deviation (ppm)	11.32	12.64

Temperature vs. Frequency Stability

Temperature	Measurement Frequency (MHz)	
(°C)	5290 MHz	5530 MHz
0	5290.0699	5530.0569
10	5290.0536	5530.0599
20	5290.0536	5530.0699
30	5290.0569	5530.0566
40	5290.0596	5530.0599
Max. Deviation (MHz)	0.0699	0.0699
Max. Deviation (ppm)	13.21	12.64

4.7. Antenna Requirements

4.7.1. Limit

Except for special regulations, the Low-power Radio-frequency Devices must not be equipped with any jacket for installing an antenna with extension cable. An intentional radiator shall be designed to ensure that no antenna other than that furnished by the responsible party shall be used with the device. The use of a permanently attached antenna or of an antenna that uses a unique coupling to the intentional radiator shall be considered sufficient to comply with the provisions of this Section. The manufacturer may design the unit so that the user can replace a broken antenna, but the use of a standard antenna jack or electrical connector is prohibited. Further, this requirement does not apply to intentional radiators that must be professionally installed.

4.7.2. Antenna Connector Construction

Please refer to section 3.3 in this test report; antenna connector complied with the requirements.

5. LIST OF MEASURING EQUIPMENTS

Instrument	Manufacturer	Model No.	Serial No.	Characteristics	Calibration Date	Remark
Spectrum analyzer	R&S	FSV40	100979	9kHz~40GHz	Dec. 12, 2014	Conducted (TH01-CB)
Temp. and Humidity Chamber	Ten Billion	TTH-D3SP	TBN-931011	-30~100 degree	Jun. 02, 2015	Conducted (TH01-CB)
RF Cable-high	Woken	RG402	High Cable-7	1 GHz – 26.5 GHz	Nov. 15, 2014	Conducted (TH01-CB)
RF Cable-high	Woken	RG402	High Cable-8	1 GHz – 26.5 GHz	Nov. 15, 2014	Conducted (TH01-CB)
RF Cable-high	Woken	RG402	High Cable-9	1 GHz – 26.5 GHz	Nov. 15, 2014	Conducted (TH01-CB)
RF Cable-high	Woken	RG402	High Cable-10	1 GHz – 26.5 GHz	Nov. 15, 2014	Conducted (TH01-CB)
RF Cable-high	Woken	RG402	High Cable-6	1 GHz – 26.5 GHz	Nov. 15, 2014	Conducted (TH01-CB)
Power Sensor	Agilent	U2021XA	MY53410001	50MHz~18GHz	Nov. 03, 2014	Conducted (TH01-CB)
Horn Antenna	EMCO	3115	00075790	750MHz ~ 18GHz	Oct. 28, 2014	Radiation (03CH01-CB)
Horn Antenna	Schwarzbeck	BBHA 9170	BBHA9170252	15GHz ~ 40GHz	Aug. 22, 2014	Radiation (03CH01-CB)
Pre-Amplifier	Agilent	8449B	3008A02310	1GHz ~ 26.5GHz	Jan. 12, 2015	Radiation (03CH01-CB)
Pre-Amplifier	WM	TF-130N-R1	923365	26GHz ~ 40GHz	Nov. 25, 2014	Radiation (03CH01-CB)
Spectrum Analyzer	R&S	FSP40	100056	9kHz ~ 40GHz	Nov. 06, 2014	Radiation (03CH01-CB)
RF Cable-high	Woken	High Cable-40G-1	N/A	1 GHz ~ 40 GHz	Nov. 15, 2014	Radiation (03CH01-CB)
RF Cable-high	Woken	High Cable-40G-2	N/A	1 GHz ~ 40 GHz	Nov. 15, 2014	Radiation (03CH01-CB)

Note: Calibration Interval of instruments listed above is one year.

6. MEASUREMENT UNCERTAINTY

Test Items	Uncertainty	Remark
Radiated Emission (1GHz ~ 18GHz)	3.7 dB	Confidence levels of 95%
Radiated Emission (18GHz ~ 40GHz)	3.5 dB	Confidence levels of 95%
Conducted Emission	1.7 dB	Confidence levels of 95%