

SAR Test Report

Product Name : 300 Mbps 802.11n Wireless
USB Adapter
Model No. : Air 2411
FCC ID : Z3W-00001-AIR2411

Applicant : AirTies Wireless Networks
Address : Gulbahar Mah. Avni Dilligil sk. No:5 Celik Is Merkezi
Mecidiyekoy Istanbul, Turkey

Date of Receipt : 09/01/2012
Date of Test : 30/01/2012
Issued Date : 02/02/2012
Report No. : 121S014R-HP-US-P03V01
Report Version : V2.1



The test results relate only to the samples tested.

The test report shall not be reproduced except in full without the written approval of QuieTek Corporation.

Test Report Certification

Issued Date: 02/02/2012

Report No: 121S014R-HP-US-P03V01



Product Name : 300 Mbps 802.11n Wireless USB Adapter

Applicant : AirTies Wireless Networks

Address : Gulbahar Mah. Avni Dilligil sk. No:5 Celik Is Merkezi Mecidiyekoy
Istanbul, Turkey

Manufacturer : Shenzhen Gongjin Electronics Co., Ltd.

Address : B116-B118, A211-213LA311-313; B411-413 Baiying Building,
1019# Naihai RD, Nanshan Section, Shenzhen, Guangdong,
China

FCC ID : Z3W-00001-AIR2411

Model No. : Air 2411

Brand Name : AirTies

EUT Voltage : DC 5V

Applicable Standard : FCC OET65 Supplement C June 2001
IEEE Std. 1528-2003,
47CFR § 2.1093

Test Result : Max. SAR Measurement (1g)
802.11b (2.4GHz): **0.643** W/kg
802.11n(20MHz)(5GHz): **0.374** W/kg

Performed Location : Suzhou EMC Laboratory
No.99 Hongye Rd., Suzhou Industrial Park Loufeng Hi-Tech
Development Zone., Suzhou, China
TEL: +86-512-6251-5088 / FAX: +86-512-6251-5098
FCC Registration Number: 800392

Documented By : Alice Ni
(Engineering ADM: Alice Ni)

Reviewed By : Robin Wu
(Engineering Supervisor: Robin Wu)

Approved By : Marlin Chen
(Engineering Manager: Marlin Chen)

Laboratory Information

We , **Quietek Corporation**, are an independent EMC and safety consultancy that was established the whole facility in our laboratories. The test facility has been accredited by the following accreditation Bodies in compliance with ISO 17025, EN 45001 and Guide 25:

Taiwan R.O.C.	:	BSMI, NCC, TAF
Germany	:	TUV Rheinland
Norway	:	Nemko, DNV
USA	:	FCC, NVLAP
Japan	:	VCCI

The related certificate for our laboratories about the test site and management system can be downloaded from Quietek Corporation's Web Site: <http://tw.quietek.com/modules/myalbum/>
The address and introduction of Quietek Corporation's laboratories can be founded in our Web site: <http://www.quietek.com/>
If you have any comments, Please don't hesitate to contact us. Our contact information is as below:

HsinChu Testing Laboratory :

No.75-2, 3rd Lin, Wangye Keng, Yonghxing Tsuen, Qionglin Shiang, Hsinchu County 307, Taiwan, R.O.C.
TEL:+886-3-592-8858 / FAX:+886-3-592-8859 E-Mail : service@quietek.com



LinKou Testing Laboratory :

No. 5-22, Ruei-Shu Valley, Ruei-Ping Tsuen, Lin-Kou Shiang, Taipei, Taiwan, R.O.C.
TEL : 886-2-8601-3788 / FAX : 886-2-8601-3789 E-Mail : service@quietek.com



Suzhou (China) Testing Laboratory :

No. 99 Hongye Rd., Suzhou Industrial Park Loufeng Hi-Tech Development Zone., Suzhou,China.
TEL : +86-512-6251-5088 / FAX : +86-512-6251-5098 E-Mail : service@quietek.com



TABLE OF CONTENTS

Description	Page
1. General Information	5
1.1. EUT Description	5
1.2. Test Environment.....	6
2. SAR Measurement System	7
2.1. DASY5 System Description	7
2.1.1. Applications	8
2.1.2. Area Scans	8
2.1.3. Zoom Scan (Cube Scan Averaging)	8
2.1.4. Uncertainty of Inter-/Extrapolation and Averaging	8
2.2. DASY5 E-Field Probe.....	9
2.2.1. Isotropic E-Field Probe Specification	9
2.3. Boundary Detection Unit and Probe Mounting Device	10
2.4. DATA Acquisition Electronics (DAE) and Measurement Server	10
2.5. Robot.....	11
2.6. Light Beam Unit.....	11
2.7. Device Holder.....	12
2.8. SAM Twin Phantom.....	12
3. Tissue Simulating Liquid.....	13
3.1. The composition of the tissue simulating liquid	13
3.2. Tissue Calibration Result.....	13
3.3. Tissue Dielectric Parameters for Head and Body Phantoms	14
4. SAR Measurement Procedure.....	15
4.1. SAR System Validation.....	15
4.1.1. Validation Dipoles	15
4.1.2. Validation Result	15
4.2. SAR Measurement Procedure.....	17
5. SAR Exposure Limits.....	18
6. Test Equipment List	19
7. Measurement Uncertainty.....	23
8. Conducted Power Measurement.....	25
9. Test Procedures.....	28
9.1. Test position and configuration	28
9.2. SAR Test Results Summary	29
Appendix A. SAR System Validation Data	32
Appendix B. SAR measurement Data.....	35
Appendix C. Test Setup Photographs & EUT Photographs	60
Appendix D. Probe Calibration Data	66
Appendix E. Dipole Calibration Data.....	66

1. General Information

1.1. EUT Description

Product Name	300 Mbps 802.11n Wireless USB Adapter
FCC ID	Z3W-00001-AIR2411
Brand Name	AirTies
Model No.	Air 2411
Frequency Range	For 2.4GHz Band 802.11b/g/n(20MHz): 2412 - 2462 MHz 802.11n(40MHz): 2422 - 2452 MHz For 5.0GHz Band 802.11n(20MHz): 5180 - 5240 MHz, 5745 - 5825MHz 802.11n(40MHz): 5190 - 5230 MHz, 5755 - 5795 MHz
Channel Number	For 2.4GHz Band 802.11b/g/n(20MHz): 11 802.11n(40MHz): 7 For 5.0GHz Band 802.11n(20MHz): 9 802.11n(40MHz): 4
Type of Modulation	802.11b: DSSS 802.11g/n: OFDM
Data Rate	802.11g: 6/9/12/18/24/36/48/54 Mbps 802.11b: 1/2/5.5/11 Mbps 802.11n: up to 300 Mbps
Device Category	Mobile
RF Exposure Environment	Uncontrolled
Antenna Type	PCB (Internal)
Peak Antenna Gain	2.15 dBi for 2.4GHz band 0 dBi for 5GHz band
Max. Output Power (Conducted)	802.11b: 11.70dBm 802.11g: 11.42dBm 802.11n(20MHz): 15.50dBm 802.11n(40MHz): 14.65dBm

1.2. Test Environment

Ambient conditions in the laboratory:

Items	Required	Actual
Temperature (°C)	18-25	21.5± 2
Humidity (%RH)	30-70	52

2. SAR Measurement System

2.1. DASY5 System Description

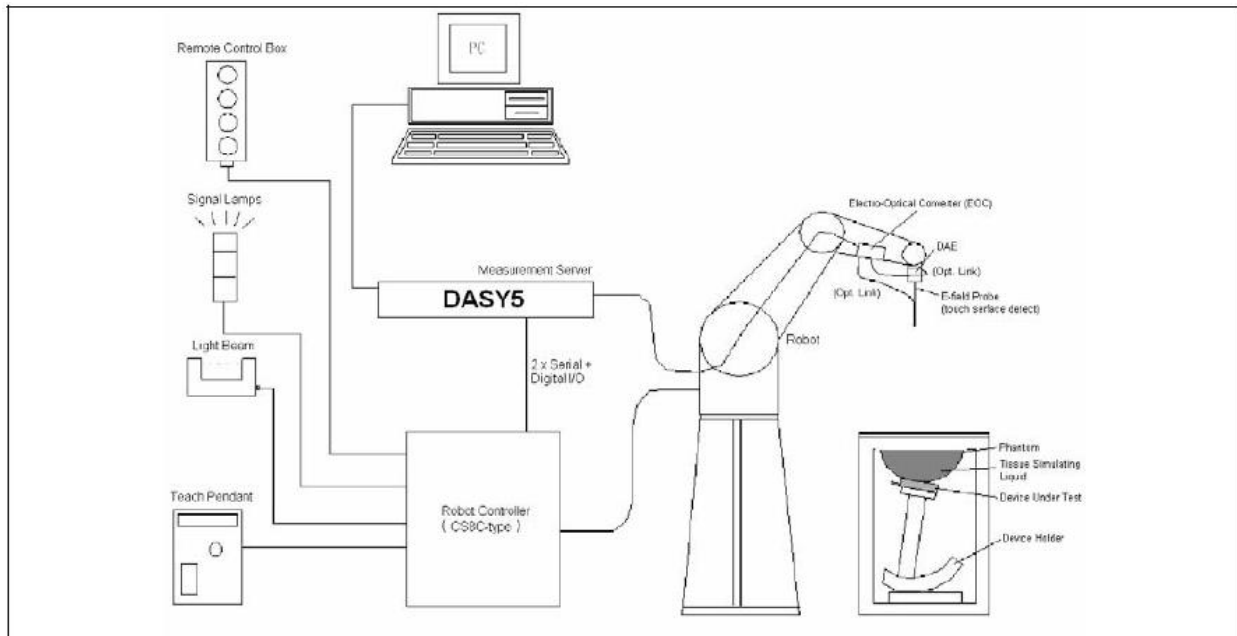

The DASY5 system for performing compliance tests consists of the following items:

- A standard high precision 6-axis robot with controller, teach pendant and software. An arm extension for accommodating the data acquisition electronics (DAE).
- A data acquisition electronics (DAE) which performs the signal amplification, signal multiplexing, AD-conversion, offset measurements, mechanical surface detection, collision detection, etc. The unit is battery powered with standard or rechargeable batteries. The signal is optically transmitted to the EOC.
- The Electro-optical converter (EOC) performs the conversion from optical to electrical signals for the digital communication to the DAE. To use optical surface detection, a special version of the EOC is required. The EOC signal is transmitted to the measurement server.
- The Light Beam used is for probe alignment. This improves the (absolute) accuracy of the probe positioning.
- A computer running WinXP and the DASY5 software.
- Remote control and teach pendant as well as additional circuitry for robot safety such as warning lamps, etc.
- The phantom, the device holder and other accessories according to the targeted measurement.

2.1.1. Applications

Predefined procedures and evaluations for automated compliance testing with all worldwide standards, e.g., IEEE 1528, OET 65, IEC 62209-1, IEC 62209-2, EN 50360, EN 50383 and others.

2.1.2. Area Scans

Area scans are defined prior to the measurement process being executed with a user defined variable spacing between each measurement point (integral) allowing low uncertainty measurements to be conducted. Scans defined for FCC applications utilize a 10mm² step integral, with 1mm interpolation used to locate the peak SAR area used for zoom scan assessments.

When an Area Scan has measured all reachable points, it computes the field maxima found in the scanned area, within a range of the global maximum. The range (in dB) is specified in the standards for compliance testing. For example, a 2 dB range is required in IEEE 1528-2003, EN 50361 and IEC 62209 standards, whereby 3 dB is a requirement when compliance is assessed in accordance with the ARIB standard (Japan).

2.1.3. Zoom Scan (Cube Scan Averaging)

Zoom Scans are used to assess the peak spatial SAR values within a cubic averaging volume containing 1 g and 10 g of simulated tissue. A density of 1000 kg/m³ is used to represent the head and body tissue density and not the phantom liquid density, in order to be consistent with the definition of the liquid dielectric properties, i.e. the side length of the 1 g cube is 10mm, with the side length of the 10 g cube 21,5mm.

The zoom scan integer steps can be user defined so as to reduce uncertainty, but normal practice for typical test applications utilize a physical step of 7x7x7 (5mmx5mmx5mm) providing a volume of 30mm in the X & Y axis, and 30mm in the Z axis.

2.1.4. Uncertainty of Inter-/Extrapolation and Averaging

In order to evaluate the uncertainty of the interpolation, extrapolation and averaged SAR calculation algorithms of the Postprocessor, DASY5 allows the generation of measurement grids which are artificially predefined by analytically based test functions. Therefore, the grids of area scans and zoom scans can be filled with uncertainty test data, according to the SAR benchmark functions of IEEE 1528. The three analytical functions shown in equations as below are used to describe the possible range of the expected SAR distributions for the tested handsets. The field gradients are covered by the spatially flat distribution f1, the spatially steep distribution f3 and f2 accounts for H-field cancellation on the phantom/tissue surface.

$$f_1(x, y, z) = Ae^{-\frac{z}{2a}} \cos^2 \left(\frac{\pi \sqrt{x'^2 + y'^2}}{2 \cdot 5a} \right)$$

$$f_2(x, y, z) = Ae^{-\frac{z}{a}} \frac{a^2}{a^2 + x'^2} \left(3 - e^{-\frac{2z}{a}} \right) \cos^2 \left(\frac{\pi y'}{2 \cdot 3a} \right)$$

$$f_3(x, y, z) = A \frac{a^2}{\frac{a^2}{4} + x'^2 + y'^2} \left(e^{-\frac{2z}{a}} + \frac{a^2}{2(a + 2z)^2} \right)$$

2.2. DASY5 E-Field Probe

The SAR measurement is conducted with the dosimetric probe manufactured by SPEAG. The probe is specially designed and calibrated for use in liquid with high permittivity. The dosimetric probe has special calibration in liquid at different frequency. SPEAG conducts the probe calibration in compliance with international and national standards (e.g. IEEE 1528, EN 62209-1, IEC 62209, etc.) under ISO 17025. The calibration data are in Appendix D.

2.2.1. Isotropic E-Field Probe Specification

Model	EX3DV4	
Construction	Symmetrical design with triangular core Built-in shielding against static charges PEEK enclosure material (resistant to organic solvents, e.g., DGBE)	
Frequency	10 MHz to 6 GHz Linearity: ± 0.2 dB (30 MHz to 6 GHz)	
Directivity	± 0.3 dB in HSL (rotation around probe axis) ± 0.5 dB in tissue material (rotation normal to probe axis)	
Dynamic Range	10 µW/g to 100 mW/g Linearity: ± 0.2 dB (noise: typically < 1 µW/g)	
Dimensions	Overall length: 330 mm (Tip: 20 mm) Tip diameter: 2.5 mm (Body: 12 mm) Typical distance from probe tip to dipole centers: 1 mm	
Application	High precision dosimetric measurements in any exposure scenario (e.g., very strong gradient fields). Only probe which enables compliance testing for frequencies up to 6 GHz with precision of better 30%.	

2.3. Boundary Detection Unit and Probe Mounting Device

The DASY probes use a precise connector and an additional holder for the probe, consisting of a plastic tube and a flexible silicon ring to center the probe. The connector at the DAE is flexibly mounted and held in the default position with magnets and springs. Two switching systems in the connector mount detect frontal and lateral probe collisions and trigger the necessary software response.

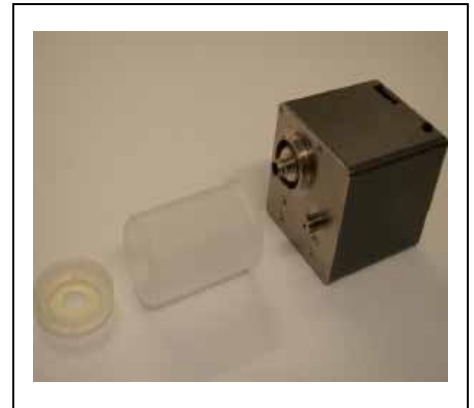

2.4. DATA Acquisition Electronics (DAE) and Measurement Server

The data acquisition electronics (DAE) consists of a highly sensitive electrometer-grade preamplifier with auto-zeroing, a channel and gain-switching multiplexer, a fast 16 bit AD-converter and a command decoder and control logic unit.

Transmission to the measurement server is accomplished through an optical downlink for data and status information as well as an optical uplink for commands and the clock.

The input impedance of the DAE4 is 200M Ohm; the inputs are symmetrical and floating. Common mode rejection is above 80dB.



The DASY5 measurement server is based on a PC/104 CPU board with a 400MHz intel ULV Celeron, 128MB chipdisk and 128MB RAM. The necessary circuits for communication with the DAE electronics box, as well as the 16 bit AD converter system for optical detection and digital I/O interface are contained on the DASY5 I/O board, which is directly connected to the PC/104 bus of the CPU board.



2.5. Robot

The DASY5 system uses the high precision robots TX90 XL type out of the newer series from Stäubli SA (France). For the 6-axis controller DASY5 system, the CS8C robot controller version from Stäubli is used.

The XL robot series have many features that are important for our application:

- High precision (repeatability 0.02 mm)
- High reliability (industrial design)
- Jerk-free straight movements
- Low ELF interference (the closed metallic construction shields against motor control fields)
- 6-axis controller



2.6. Light Beam Unit

The light beam switch allows automatic "tooling" of the probe. During the process, the actual position of the probe tip with respect to the robot arm is measured, as well as the probe length and the horizontal probe offset. The software then corrects all movements, such that the robot coordinates are valid for the probe tip.

The repeatability of this process is better than 0.1 mm. If a position has been taught with an aligned probe, the same position will be reached with another aligned probe within 0.1 mm, even if the other probe has different dimensions. During probe rotations, the probe tip will keep its actual position.



2.7. Device Holder

The DASY5 device holder is designed to cope with different positions given in the standard. It has two scales for the device rotation (with respect to the body axis) and the device inclination (with respect to the line between the ear reference points). The rotation center for both scales is the ear reference point (EPR).

Thus the device needs no repositioning when changing the angles.

The DASY5 device holder has been made out of low-loss POM material having the following dielectric parameters: relative permittivity $\epsilon_r = 3$ and loss tangent $\delta = 0.02$. The amount of dielectric material has been reduced in the closest vicinity of the device, since measurements have suggested that the influence of the clamp on the test results could thus be lowered.



2.8. SAM Twin Phantom

The SAM twin phantom is a fiberglass shell phantom with 2mm shell thickness (except the ear region where shell thickness increases to 6mm). It has three measurement areas:

- Left head
- Right head
- Flat phantom



The bottom plate contains three pair of bolts for locking the device holder. The device holder positions are adjusted to the standard measurement positions in the three sections. A white cover is provided to tap the phantom during off-periods to prevent water evaporation and changes in the liquid parameters. On the phantom top, three reference markers are provided to identify the phantom position with respect to the robot.

3. Tissue Simulating Liquid

3.1. The composition of the tissue simulating liquid

INGREDIENT (% Weight)	2450MHz Head	2450MHz Body	5800MHz Body
Water	46.7	73.2	75.68
Salt	0.00	0.04	0.43
Sugar	0.00	0.00	0.00
HEC	0.00	0.00	0.00
Preventol	0.00	0.00	0.00
DGBE	53.3	26.7	4.42
Triton X-100	0.00	0.00	19.47

3.2. Tissue Calibration Result

The dielectric parameters of the liquids were verified prior to the SAR evaluation using DASY5 Dielectric Probe Kit and Agilent Vector Network Analyzer E5071C

Body Tissue Simulant Measurement				
Frequency [MHz]	Description	Dielectric Parameters		Tissue Temp. [°C]
		ϵ_r	σ [s/m]	
2450MHz	Reference result ± 5% window	52.7 50.07 to 55.34	1.95 1.85 to 2.05	N/A
	30-01-2012	52.29	2.00	21.0
5200MHz	Reference result ± 5% window	49.0 46.55 to 51.45	5.30 5.04 to 5.57	N/A
	30-01-2012	47.95	5.15	21.0
5800MHz	Reference result ± 5% window	48.2 45.79 to 50.61	6.00 5.70 to 6.30	N/A
	30-01-2012	46.27	6.02	21.0

3.3. Tissue Dielectric Parameters for Head and Body Phantoms

The head tissue dielectric parameters recommended by the IEEE SCC-34/SC-2 in P1528 have been incorporated in the following table. These head parameters are derived from planar layer models simulating the highest expected SAR for the dielectric properties and tissue thickness variations in a human head. Other head and body tissue parameters that have not been specified in P1528 are derived from the tissue dielectric parameters computed from the 4-Cole-Cole equations described in Reference [12] and extrapolated according to the head parameters specified in P1528.

Target Frequency (MHz)	Head		Body	
	ϵ_r	σ (S/m)	ϵ_r	σ (S/m)
150	52.3	0.76	61.9	0.80
300	45.3	0.87	58.2	0.92
450	43.5	0.87	56.7	0.94
835	41.5	0.90	55.2	0.97
900	41.5	0.97	55.0	1.05
915	41.5	0.98	55.0	1.06
1450	40.5	1.20	54.0	1.30
1610	40.3	1.29	53.8	1.40
1800 – 2000	40.0	1.40	53.3	1.52
2450	39.2	1.80	52.7	1.95
3000	38.5	2.40	52.0	2.73
5800	35.3	5.27	48.2	6.00

(ϵ_r = relative permittivity, σ = conductivity and $\rho = 1000 \text{ kg/m}^3$)

4. SAR Measurement Procedure

4.1. SAR System Validation

4.1.1. Validation Dipoles

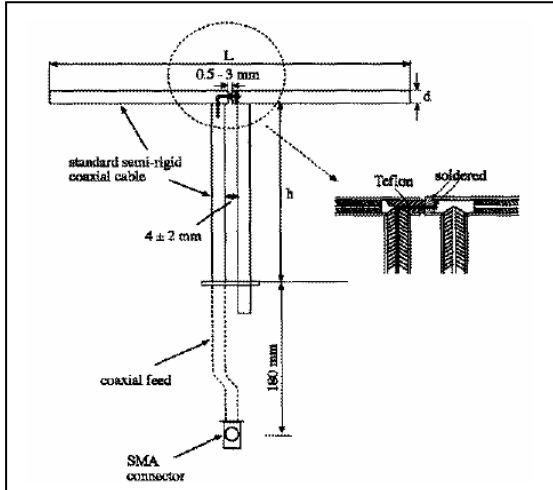

The dipoles used is based on the IEEE-1528 standard, and is complied with mechanical and electrical specifications in line with the requirements of both IEEE and FCC Supplement C. the table below provides details for the mechanical and electrical specifications for the dipoles.

Frequency	L (mm)	h (mm)	d (mm)
2450MHz	53.5	30.4	3.6
5800MHz	20.6	14.2	3.6

4.1.2. Validation Result

System Performance Check at 2450MHz				
Validation Dipole: D2450V2, SN: 839				
Frequency [MHz]	Description	SAR [w/kg] 1g	SAR [w/kg] 10g	Tissue Temp. [°C]
2450 MHz	Reference result ± 10% window	51.6 46.44 to 56.76	24.2 21.78 to 26.62	N/A
	30-01-2012	52.40	24.48	21.0
Note: All SAR values are normalized to 1W forward power.				

System Performance Check at 5200MHz				
Validation Dipole: D5GHzV2, SN: 1078				
Frequency [MHz]	Description	SAR [w/kg] 1g	SAR [w/kg] 10g	Tissue Temp. [°C]
5200 MHz	Reference result ± 10% window	77.9 70.11 to 85.69	21.8 19.62 to 23.98	N/A
	30-01-2012	77.50	21.70	21.0
Note: All SAR values are normalized to 1W forward power.				

System Performance Check at 5800MHz				
Validation Kit: D5GHzV2, SN: 1078				
Frequency [MHz]	Description	SAR [w/kg] 1g	SAR [w/kg] 10g	Tissue Temp. [°C]
5800 MHz	Reference result ± 10% window	73.3 65.97 to 80.63	20.2 18.18 to 22.22	N/A
	30-01-2012	75.00	21.90	21.0
Note: All SAR values are normalized to 1W forward power.				

4.2. SAR Measurement Procedure

The DASY 5 calculates SAR using the following equation,

$$SAR = \frac{\sigma |E|^2}{\rho}$$

σ : represents the simulated tissue conductivity

ρ : represents the tissue density

The EUT is set to transmit at the required power in line with product specification, at each frequency relating to the LOW, MID, and HIGH channel settings.

Pre-scans are made on the device to establish the location for the transmitting antenna, using a large area scan in either air or tissue simulation fluid.

The EUT is placed against the Universal Phantom where the maximum area scan dimensions are larger than the physical size of the resonating antenna. When the scan size is not large enough to cover the peak SAR distribution, it is modified by either extending the area scan size in both the X and Y directions, or the device is shifted within the predefined area.

The area scan is then run to establish the peak SAR location (interpolated resolution set at 1mm^2) which is then used to orient the center of the zoom scan. The zoom scan is then executed and the 1g and 10g averages are derived from the zoom scan volume (interpolated resolution set at 1mm^3).

5. SAR Exposure Limits

SAR assessments have been made in line with the requirements of IEEE-1528, FCC Supplement C, and comply with ANSI/IEEE C95.1-1992 “Uncontrolled Environments” limits. These limits apply to a location which is deemed as “Uncontrolled Environment” which can be described as a situation where the general public may be exposed to an RF source with no prior knowledge or control over their exposure.

Limits for General Population/Uncontrolled Exposure (W/kg)

Type Exposure	Uncontrolled Environment Limit
Spatial Peak SAR (1g cube tissue for brain or body)	1.60 W/kg
Spatial Average SAR (whole body)	0.08 W/kg
Spatial Peak SAR (10g for hands, feet, ankles and wrist)	4.00 W/kg

6. Test Equipment List

Instrument	Manufacturer	Model No.	Serial No.	Cali. Due Date
Stäubli Robot TX60L	Stäubli	TX60L	F10/5C90A1/A/01	only once
Controller	Stäubli	SP1	S-0034	only once
Dipole Validation Kits	Speag	D2450V2	839	2012.03.12
Dipole Validation Kits	Speag	D5GHzV2	1078	2012.03.11
SAM Twin Phantom	Speag	SAM	TP-1561/1562	N/A
Device Holder	Speag	SD 000 H01 HA	N/A	N/A
Data Acquisition Electronic	Speag	DAE4	915	2012.07.26
E-Field Probe	Speag	EX3DV4	3698	2012.07.28
SAR Software	Speag	DASY5	V5.2 Build 162	N/A
Power Amplifier	Mini-Circuit	ZHL-42	D051404-28	N/A
Directional Coupler	Agilent	778D	20160	N/A
Universal Radio Communication Tester	R&S	CMU 200	117088	2012.04.29
Vector Network	Agilent	E5071C	MY48367267	2012.04.10
Signal Generator	Agilent	E4438C	MY49070163	2012.04.23
Power Meter	Anritsu	ML2495A	0905006	2013.01.12
Wide Bandwidth Sensor	Anritsu	MA2411B	0846014	2013.01.12

Note: Per KDB 450824 D02 requirements for dipole calibration, Quietek Lab has adopted two years calibration intervals. On annual basis, every measurement dipole has been evaluated and is in compliance with the following criteria:

1. There is no physical damage on the dipole;
2. System validation with specific dipole is within 10% of calibrated value;
3. Return-loss is within 20% of calibrated measurement (Show below);
4. Impedance is within 5Ω of calibrated measurement (Show below).

Impedance Plot for D2450V2

2450 Body

Calibrated impedance: 50 Ω ; Measured impedance: 50.36 Ω (within 5 Ω)

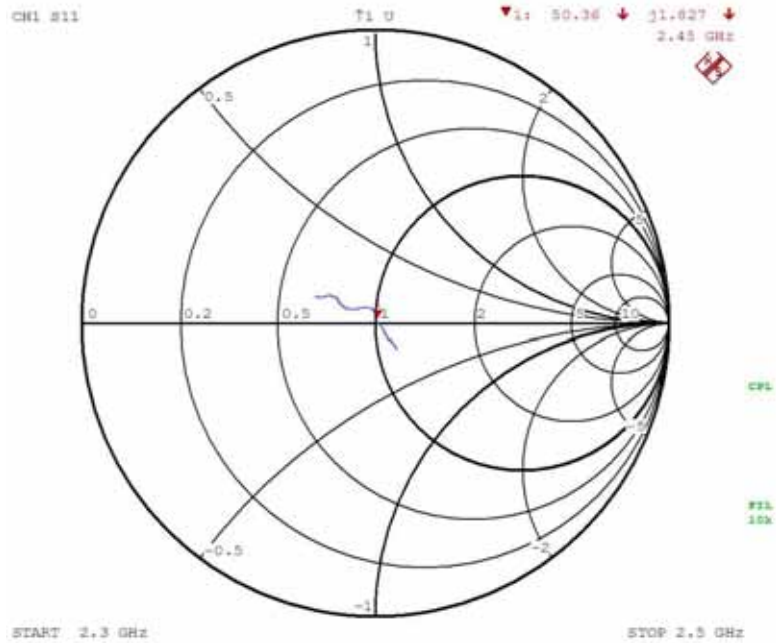

Calibrated return loss: -40.8 dB; Measured impedance: -42.22 dB (within 20%)

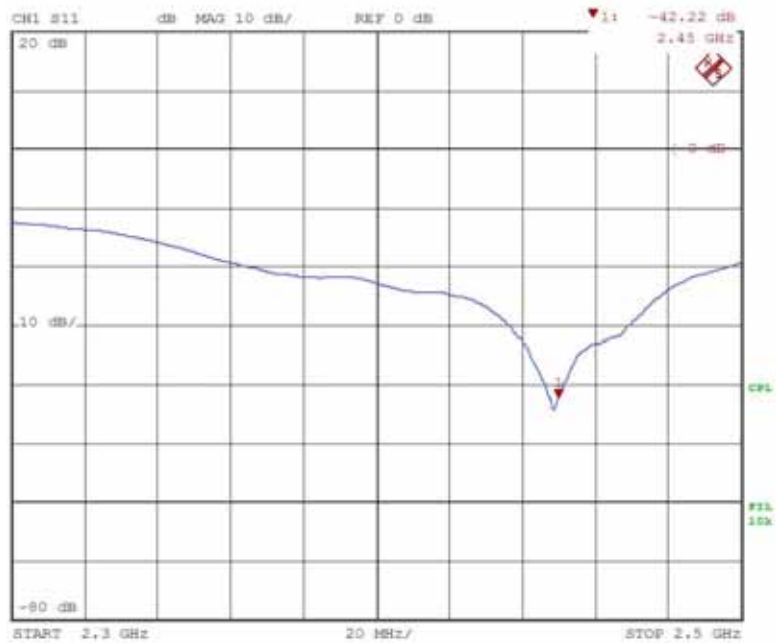

5200 Body

Calibrated impedance: 53.6 Ω ; Measured impedance: 54.4 Ω (within 5 Ω)

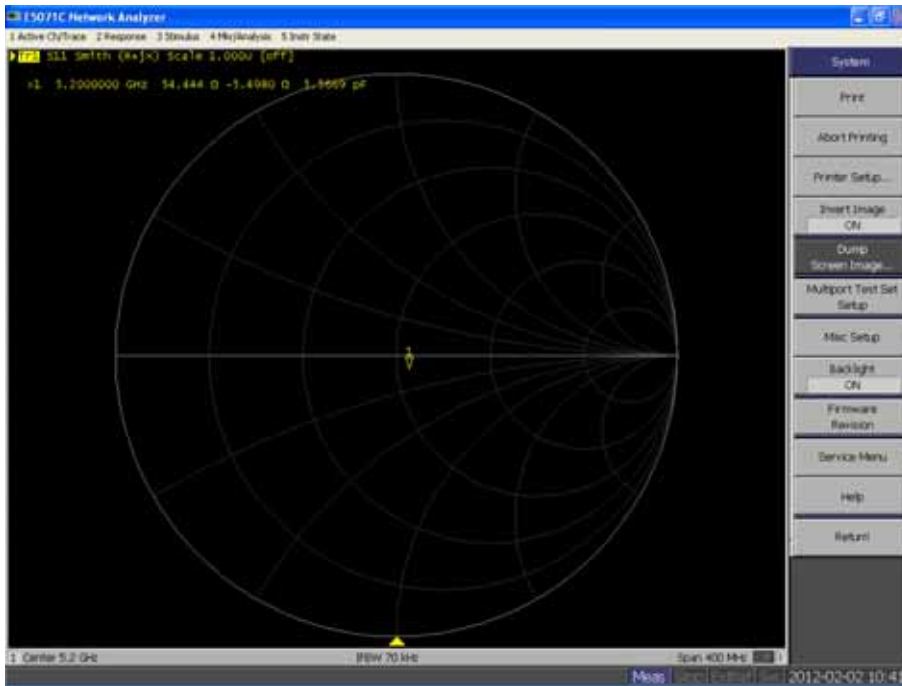

Calibrated return loss: -20.8 dB; Measured impedance: -20.5 dB (within 20%)

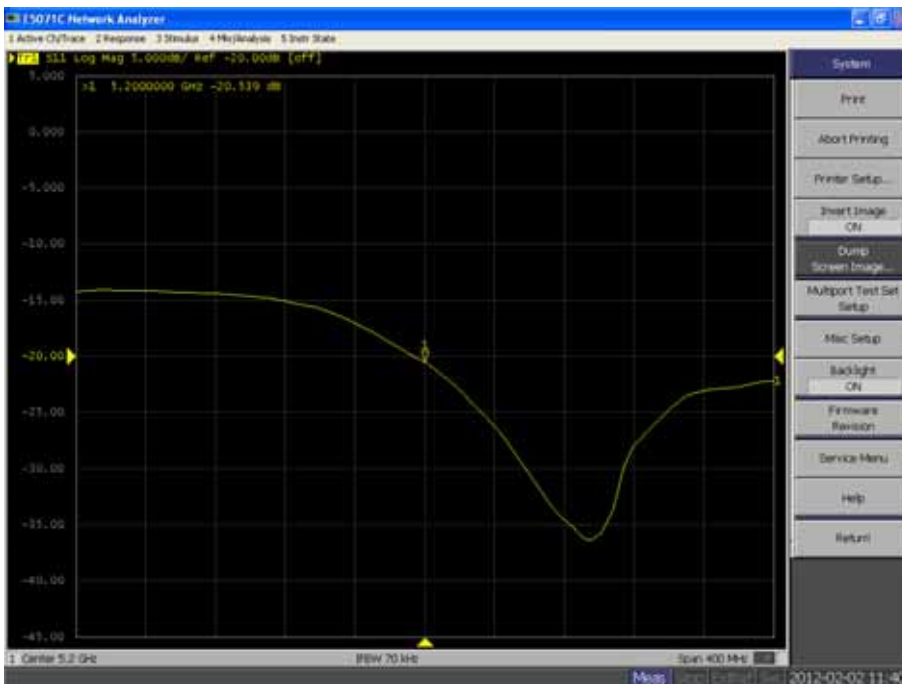

5800 Body

Calibrated impedance: 55.6 Ω; Measured impedance: 55.9 Ω (within 5Ω)

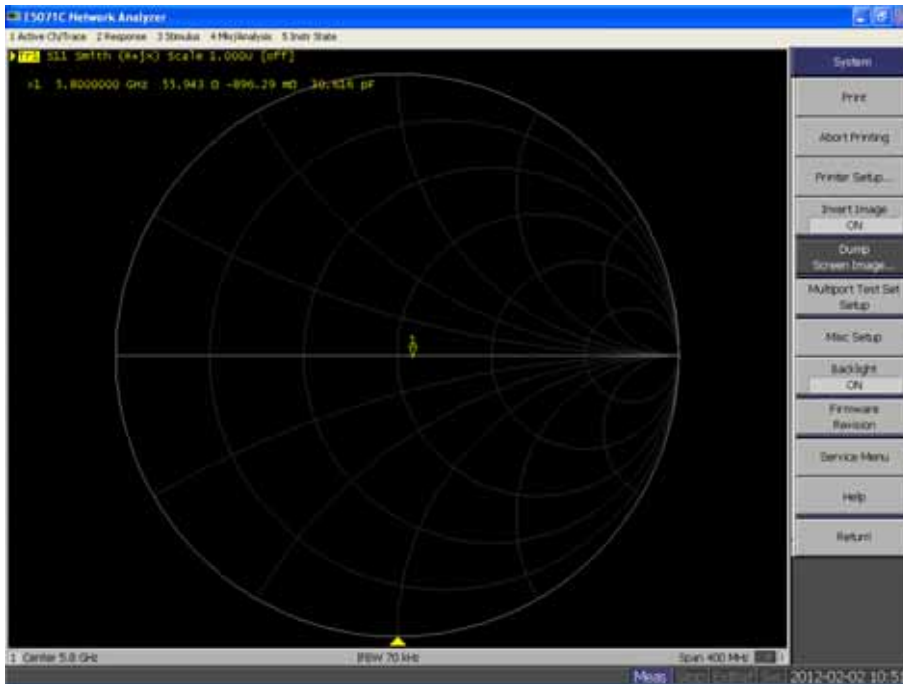

Calibrated return loss: -25.2 dB; Measured impedance: -25.7 dB (within 20%)

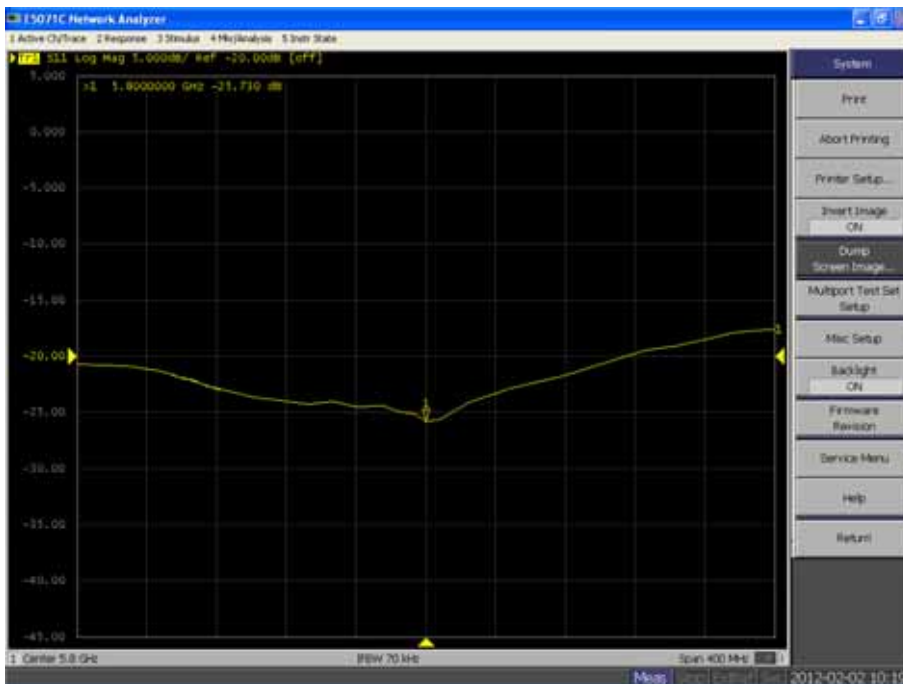

7. Measurement Uncertainty

DASY5 Uncertainty								
Measurement uncertainty for 300 MHz to 3 GHz averaged over 1 gram / 10 gram.								
Error Description	Uncert. value	Prob. Dist.	Div.	(ci) 1g	(ci) 10g	Std. Unc. (1g)	Std. Unc. (10g)	(vi) V _{eff}
Measurement System								
Probe Calibration	±6.0%	N	1	1	1	±6.0%	±6.0%	∞
Axial Isotropy	±4.7%	R	√3	0.7	0.7	±1.9%	±1.9%	∞
Hemispherical Isotropy	±9.6%	R	√3	0.7	0.7	±3.9%	±3.9%	∞
Boundary Effects	±1.0%	R	√3	1	1	±0.6%	±0.6%	∞
Linearity	±4.7%	R	√3	1	1	±2.7%	±2.7%	∞
System Detection Limits	±1.0%	R	√3	1	1	±0.6%	±0.6%	∞
Readout Electronics	±0.3%	N	1	1	1	±0.3%	±0.3%	∞
Response Time	±0.8%	R	√3	1	1	±0.5%	±0.5%	∞
Integration Time	±2.6%	R	√3	1	1	±1.5%	±1.5%	∞
RF Ambient Noise	±3.0%	R	√3	1	1	±1.7%	±1.7%	∞
RF Ambient Reflections	±3.0%	R	√3	1	1	±1.7%	±1.7%	∞
Probe Positioner	±0.4%	R	√3	1	1	±0.2%	±0.2%	∞
Probe Positioning	±2.9%	R	√3	1	1	±1.7%	±1.7%	∞
Max. SAR Eval.	±1.0%	R	√3	1	1	±0.6%	±0.6%	∞
Test Sample Related								
Device Positioning	±2.9%	N	1	1	1	±2.9%	±2.9%	145
Device Holder	±3.6%	N	1	1	1	±3.6%	±3.6%	5
Power Drift	±5.0%	R	√3	1	1	±2.9%	±2.9%	∞
Phantom and Setup								
Phantom Uncertainty	±4.0%	R	√3	1	1	±2.3%	±2.3%	∞
Liquid Conductivity (target)	±5.0%	R	√3	0.64	0.43	±1.8%	±1.2%	∞
Liquid Conductivity (meas.)	±2.5%	N	1	0.64	0.43	±1.6%	±1.1%	∞
Liquid Permittivity (target)	±5.0%	R	√3	0.6	0.49	±1.7%	±1.4%	∞
Liquid Permittivity (meas.)	±2.5%	N	1	0.6	0.49	±1.5%	±1.2%	∞
Combined Std. Uncertainty						±10.9%	±10.7%	387
Expanded STD Uncertainty						±21.9%	±21.4%	

DASY5 Uncertainty								
Measurement uncertainty for 3 GHz to 6 GHz averaged over 1 gram / 10 gram.								
Error Description	Uncert. value	Prob. Dist.	Div.	(ci) 1g	(ci) 10g	Std. Unc. (1g)	Std. Unc. (10g)	(vi) V _{eff}
Measurement System								
Probe Calibration	±6.55%	N	1	1	1	±6.55%	±6.55%	∞
Axial Isotropy	±4.7%	R	√3	0.7	0.7	±1.9%	±1.9%	∞
Hemispherical Isotropy	±9.6%	R	√3	0.7	0.7	±3.9%	±3.9%	∞
Boundary Effects	±2.0%	R	√3	1	1	±1.2%	±1.2%	∞
Linearity	±4.7%	R	√3	1	1	±2.7%	±2.7%	∞
System Detection Limits	±1.0%	R	√3	1	1	±0.6%	±0.6%	∞
Readout Electronics	±0.3%	N	1	1	1	±0.3%	±0.3%	∞
Response Time	±0.8%	R	√3	1	1	±0.5%	±0.5%	∞
Integration Time	±2.6%	R	√3	1	1	±1.5%	±1.5%	∞
RF Ambient Noise	±3.0%	R	√3	1	1	±1.7%	±1.7%	∞
RF Ambient Reflections	±3.0%	R	√3	1	1	±1.7%	±1.7%	∞
Probe Positioner	±0.8%	R	√3	1	1	±0.5%	±0.5%	∞
Probe Positioning	±9.9%	R	√3	1	1	±5.7%	±5.7%	∞
Max. SAR Eval.	±4.0%	R	√3	1	1	±2.3%	±2.3%	∞
Test Sample Related								
Device Positioning	±2.9%	N	1	1	1	±2.9%	±2.9%	145
Device Holder	±3.6%	N	1	1	1	±3.6%	±3.6%	5
Power Drift	±5.0%	R	√3	1	1	±2.9%	±2.9%	∞
Phantom and Setup								
Phantom Uncertainty	±4.0%	R	√3	1	1	±2.3%	±2.3%	∞
Liquid Conductivity (target)	±5.0%	R	√3	0.64	0.43	±1.8%	±1.2%	∞
Liquid Conductivity (meas.)	±2.5%	N	1	0.64	0.43	±1.6%	±1.1%	∞
Liquid Permittivity (target)	±5.0%	R	√3	0.6	0.49	±1.7%	±1.4%	∞
Liquid Permittivity (meas.)	±2.5%	N	1	0.6	0.49	±1.5%	±1.2%	∞
Combined Std. Uncertainty						±12.8%	±12.6%	330
Expanded STD Uncertainty						±25.6%	±25.2%	

8. Conducted Power Measurement

1Tx Chain 0

Test Mode	Channel No.	Frequency (MHz)	Conducted Power (dBm)
802.11b	01	2412	11.70
	06	2437	11.35
	11	2462	11.22
802.11g	01	2412	11.42
	06	2437	10.95
	11	2462	10.82
802.11n(20MHz)	01	2412	10.82
	06	2437	10.53
	11	2462	10.52
802.11n(40MHz)	03	2422	10.61
	06	2437	10.57
	09	2452	10.74
802.11n(20MHz)	36	5180	15.50
	48	5240	14.60
	149	5745	13.84
	157	5785	13.70
	165	5825	13.41
802.11n(40MHz)	38	5190	14.12
	46	5230	14.65
	151	5755	11.14
	159	5795	11.71

1Tx Chain 1

Test Mode	Channel No.	Frequency (MHz)	Conducted Power (dBm)
802.11b	01	2412	11.70
	06	2437	11.35
	11	2462	11.22
802.11g	01	2412	11.42
	06	2437	10.95
	11	2462	10.82
802.11n(20MHz)	01	2412	10.82
	06	2437	10.53
	11	2462	10.52
802.11n(40MHz)	03	2422	10.61
	06	2437	10.57
	09	2452	10.74
802.11n(20MHz)	36	5180	15.50
	48	5240	14.60
	149	5745	13.84
	157	5785	13.70
	165	5825	13.41
802.11n(40MHz)	38	5190	14.12
	46	5230	14.65
	151	5755	11.14
	159	5795	11.71

2Tx Chain 2

Test Mode	Channel No.	Frequency (MHz)	Conducted Power (dBm)
802.11n(20MHz)	01	2412	10.82
	06	2437	10.53
	11	2462	10.52
	36	5180	15.50
	48	5240	14.60
	149	5745	13.84
	157	5785	13.70
	165	5825	13.41
802.11n(40MHz)	03	2422	10.61
	06	2437	10.57
	09	2452	10.74
	38	5190	14.12
	46	5230	14.65
	151	5755	11.14
	159	5795	11.71

Note : Antenna chain 0 and chain 1 has the same circuit and transmit power. Therefore, we choose one of the antenna(chain 1) to complete the test(802.11b/g).

9. Test Procedures

9.1. Test position and configuration

SAR was performed with the device configured in the positions according to IEEE1528, and KDB 447498 D02 SAR Procedures for Dongle Xmtr v01 1, body SAR was performed with the device to phantom separation distance of 5mm. All USB orientations (A: Horizontal-Up, B: Horizontal-Down, C: Vertical-Front, D: Vertical-Back, and E: Tip) were evaluated with 15cm USB cable for extension. Please check the SAR test photos.

Other KDB files were referred for this device SAR evaluation: D01 Mobile Portable RF Exposure v04, 248227 802.11abg SAR and 388624 D02 Permit But Ask List v09R01.

9.2. SAR Test Results Summary

SAR MEASUREMENT							
Ambient Temperature (°C) : 21.5 ±2					Relative Humidity (%): 55		
Liquid Temperature (°C) : 21.0 ±2					Depth of Liquid (cm):>15		
Product: 300 Mbps 802.11n Wireless USB Adapter							
Test Mode: 802.11b-1Tx Chain 1							
Test Position Body	Antenna Position	Frequency		Separation Distance (cm)	Power Drift (<±0.2)	SAR 1g (W/kg)	Limit (W/kg)
		Channel	MHz				
Horizontal Up (Laptop)	Fixed	1	2412	0.5	-0.085	0.643	1.6
Horizontal Up (Laptop)	Fixed	6	2437	0.5	0.030	0.564	1.6
Horizontal Up (Laptop)	Fixed	11	2462	0.5	0.095	0.528	1.6
Horizontal Down (USB Cable)	Fixed	1	2412	0.5	-0.137	0.467	1.6
Vertical Front (USB Cable)	Fixed	1	2412	0.5	0.156	0.083	1.6
Vertical Back (USB Cable)	Fixed	1	2412	0.5	-0.083	0.325	1.6
Tip (USB Cable)	Fixed	1	2412	0.5	0.186	0.101	1.6
Test Mode: 802.11g-1Tx Chain 1							
Horizontal Up (Laptop)	Fixed	1	2412	0.5	-0.173	0.366	1.6
Test Mode: 802.11n(20MHz)- 2Tx Chain 2							
Horizontal Up (Laptop)	Fixed	1	2412	0.5	-0.037	0.332	1.6
Test Mode: 802.11n(40MHz)- 2Tx Chain 2							
Horizontal Up (Laptop)	Fixed	9	2452	0.5	0.182	0.331	1.6

SAR MEASUREMENT							
Ambient Temperature (°C) : 21.5 ±2				Relative Humidity (%): 55			
Liquid Temperature (°C) : 21.0 ±2				Depth of Liquid (cm):>15			
Product: 300 Mbps 802.11n Wireless USB Adapter							
Test Mode: 802.11n(20MHz)- 2Tx Chain 2							
Test Position Body	Antenna Position	Frequency		Separation Distance (cm)	Power Drift (<±0.2)	SAR 1g (W/kg)	Limit (W/kg)
		Channel	MHz				
Horizontal Up (Laptop)	Fixed	36	5180	0.5	0.159	0.347	1.6
Horizontal Down (USB Cable)	Fixed	36	5180	0.5	-0.060	0.248	1.6
Vertical Front (USB Cable)	Fixed	36	5180	0.5	-0.105	0.349	1.6
Vertical Back (USB Cable)	Fixed	36	5180	0.5	0.135	0.336	1.6
Tip (USB Cable)	Fixed	36	5180	0.5	0.108	0.080	1.6
Vertical Front (USB Cable)	Fixed	48	5240	0.5	0.032	0.350	1.6
Vertical Front (USB Cable)	Fixed	149	5745	0.5	0.067	0.364	1.6
Vertical Front (USB Cable)	Fixed	157	5785	0.5	0.136	0.374	1.6
Vertical Front (USB Cable)	Fixed	165	5825	0.5	0.096	0.329	1.6

Test Mode: 802.11n(40MHz)- 2Tx Chain 2							
Vertical Front (USB Cable)	Fixed	38	5190	0.5	0.093	0.185	1.6
Vertical Front (USB Cable)	Fixed	46	5230	0.5	0.107	0.175	1.6
Vertical Front (USB Cable)	Fixed	151	5755	0.5	0.115	0.230	1.6
Vertical Front (USB Cable)	Fixed	159	5795	0.5	0.056	0.175	1.6

Appendix A. SAR System Validation Data

Date/Time: 30-01-2012

Test Laboratory: QuieTek Lab

System Check Body 2450MHz

DUT: Dipole 2450 MHz D2450V2; Type: D2450V2

Communication System: CW; Communication System Band: D2450 (2450.0 MHz); Duty Cycle: 1:1;

Frequency: 2450 MHz; Medium parameters used: $f = 2450$ MHz; $\sigma = 2$ mho/m; $\epsilon_r = 52.3$; $\rho = 1000$ kg/m³ ;

Phantom section: Flat Section ; Input Power=250mW

Ambient temperature (°C): 21.5, Liquid temperature (°C): 21.0

DASY5 Configuration:

- Probe: EX3DV4 - SN3698; ConvF(6.60, 6.60, 6.60); Calibrated: 28/07/2011
- Sensor-Surface: 4mm (Mechanical Surface Detection)
- Electronics: DAE4 Sn915; Calibrated: 26/07/2011
- Phantom: SAM2; Type: SAM; Serial: TP1562
- Measurement SW: DASY5, V5.2 Build 162; SEMCAD X Version 14.0 Build 59

Configuration/Body 2450MHz/Area Scan (6x10x1): Measurement grid: dx=10mm, dy=10mm

Maximum value of SAR (measured) = 13.1 mW/g

Configuration/Body 2450MHz/Zoom Scan (7x7x7)/Cube 0: Measurement grid: dx=5mm, dy=5mm,

dz=5mm, Reference Value = 85.8 V/m; Power Drift = 0.039 dB

Peak SAR (extrapolated) = 26.4 W/kg

SAR(1 g) = 13.1 mW/g; SAR(10 g) = 6.12 mW/g Maximum value of SAR (measured) = 15.2 mW/g

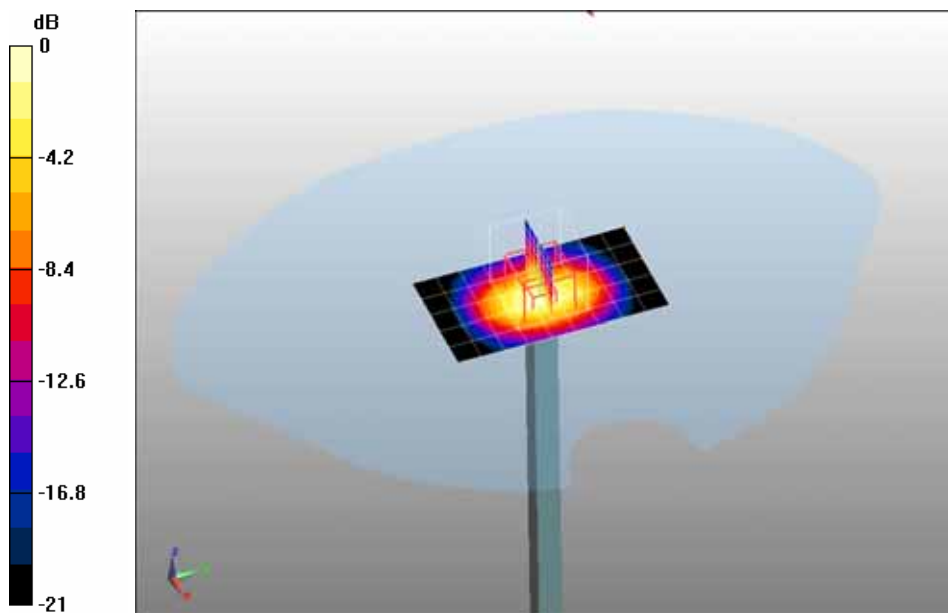

0 dB = 15.2mW/g

Date/Time: 30-01-2012

Test Laboratory: QuieTek Lab

System Check Body 5200MHz

DUT: Dipole D5GHzV2; Type: D5GHzV2

Communication System: CW; Communication System Band: ITD5500 (5000.0 - 5900.0 MHz); Duty Cycle: 1:1; Frequency: 5200 MHz; Medium parameters used: $f = 5200$ MHz; $\sigma = 5.15$ mho/m; $\epsilon_r = 48.0$; $\rho = 1000$ kg/m³; Phantom section: Flat Section ; Input Power=100mW

Ambient temperature (°C): 21.5, Liquid temperature (°C): 21.0

DASY5 Configuration:

- Probe: EX3DV4 - SN3698; ConvF(3.95, 3.95, 3.95); Calibrated: 28/07/2011
- Sensor-Surface: 2mm (Mechanical Surface Detection)
- Electronics: DAE4 Sn915; Calibrated: 26/07/2011
- Phantom: SAM2; Type: SAM; Serial: TP1562
- Measurement SW: DASY5, V5.2 Build 162; SEMCAD X Version 14.0 Build 59

Configuration/Body 5200MHz/Area Scan (6x6x1): Measurement grid: dx=10mm, dy=10mm

Maximum value of SAR (measured) = 5.37 mW/g

Configuration/Body 5200MHz/Zoom Scan (7x7x7)/Cube 0: Measurement grid: dx=5mm, dy=5mm, dz=5mm, Reference Value = 40.3 V/m; Power Drift = -0.082 dB

Peak SAR (extrapolated) = 37.9 W/kg

SAR(1 g) = 7.75 mW/g; SAR(10 g) = 2.17 mW/g Maximum value of SAR (measured) = 8.07 mW/g

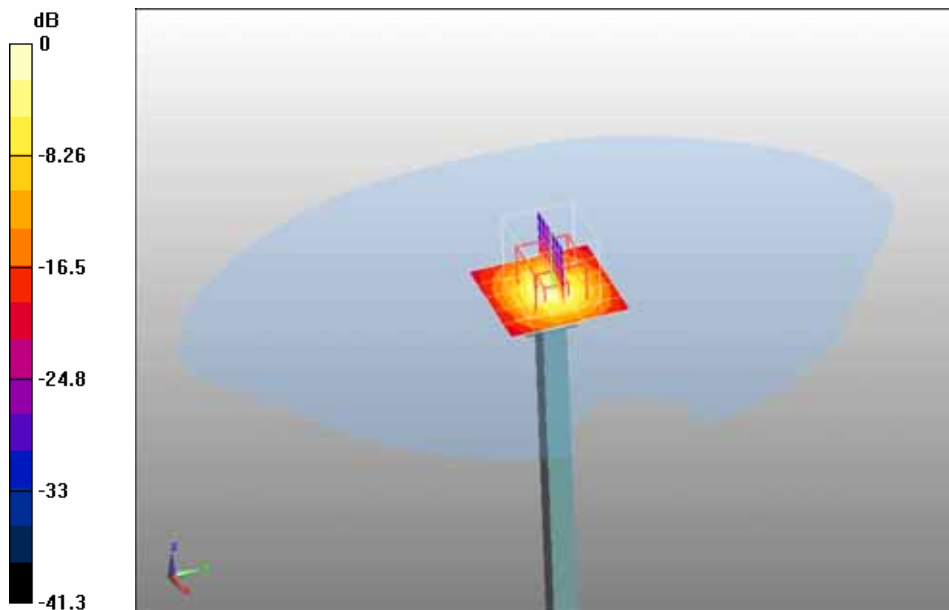

0 dB = 8.07mW/g

Date/Time: 30-01-2012

Test Laboratory: QuieTek Lab

System Check Body 5800MHz

DUT: Dipole D5GHzV2; Type: D5GHzV2

Communication System: CW; Communication System Band: ITD5500 (5000.0 - 5900.0 MHz); Duty Cycle: 1:1; Frequency: 5800 MHz; Medium parameters used: $f = 5800$ MHz; $\sigma = 6.02$ mho/m; $\epsilon_r = 46.3$; $\rho = 1000$ kg/m³; Phantom section: Flat Section ; Input Power=100mW

Ambient temperature (°C): 21.5, Liquid temperature (°C): 21.0

DASY5 Configuration:

- Probe: EX3DV4 - SN3698; ConvF(3.74, 3.74, 3.74); Calibrated: 28/07/2011
- Sensor-Surface: 2mm (Mechanical Surface Detection)
- Electronics: DAE4 Sn915; Calibrated: 26/07/2011
- Phantom: SAM2; Type: SAM; Serial: TP1562
- Measurement SW: DASY5, V5.2 Build 162; SEMCAD X Version 14.0 Build 59

Configuration/Body 5800MHz/Area Scan (6x6x1): Measurement grid: dx=10mm, dy=10mm

Maximum value of SAR (measured) = 6.29 mW/g

Configuration/Body 5800MHz/Zoom Scan (7x7x7)/Cube 0: Measurement grid: dx=5mm, dy=5mm, dz=5mm, Reference Value = 40.3 V/m; Power Drift = -0.057 dB

Peak SAR (extrapolated) = 25.1 W/kg

SAR(1 g) = 7.5 mW/g; SAR(10 g) = 2.19 mW/g Maximum value of SAR (measured) = 9.65 mW/g

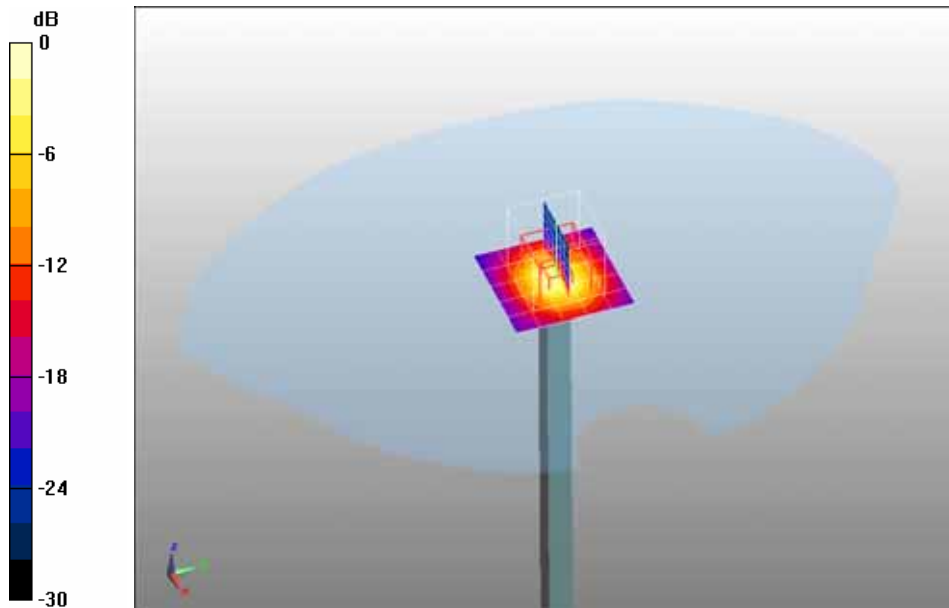

0 dB = 9.65mW/g

Appendix B. SAR measurement Data

Date/Time: 30-01-2012

Test Laboratory: QuieTek Lab

802.11b Low-Horizontal Up

DUT: 300 Mbps 802.11n Wireless USB Adapter; Type: Air 2411

Communication System: Wi-Fi; Communication System Band: 802.11b; Duty Cycle: 1:1; Frequency: 2412 MHz; Medium parameters used: $f = 2412$ MHz; $\sigma = 1.95$ mho/m; $\epsilon_r = 52.4$; $\rho = 1000$ kg/m³; Phantom section: Flat Section

Ambient temperature (°C): 21.5, Liquid temperature (°C): 21.0

DASY5 Configuration:

- Probe: EX3DV4 - SN3698; ConvF(6.60, 6.60, 6.60); Calibrated: 28/07/2011
- Sensor-Surface: 4mm (Mechanical Surface Detection)
- Electronics: DAE4 Sn915; Calibrated: 26/07/2011
- Phantom: SAM2; Type: SAM; Serial: TP1562
- Measurement SW: DASY5, V5.2 Build 162; SEMCAD X Version 14.0 Build 59

Configuration/802.11b Low-Horizontal Up/Area Scan (5x9x1): Measurement grid: dx=15mm, dy=15mm

Maximum value of SAR (measured) = 0.637 mW/g

Configuration/802.11b Low-Horizontal Up/Zoom Scan (5x5x7)/Cube 0: Measurement grid: dx=8mm,

dy=8mm, dz=5mm, Reference Value = 14.2 V/m; Power Drift = -0.085 dB

Peak SAR (extrapolated) = 1.45 W/kg

SAR(1 g) = 0.643 mW/g; SAR(10 g) = 0.295 mW/g Maximum value of SAR (measured) = 0.704 mW/g

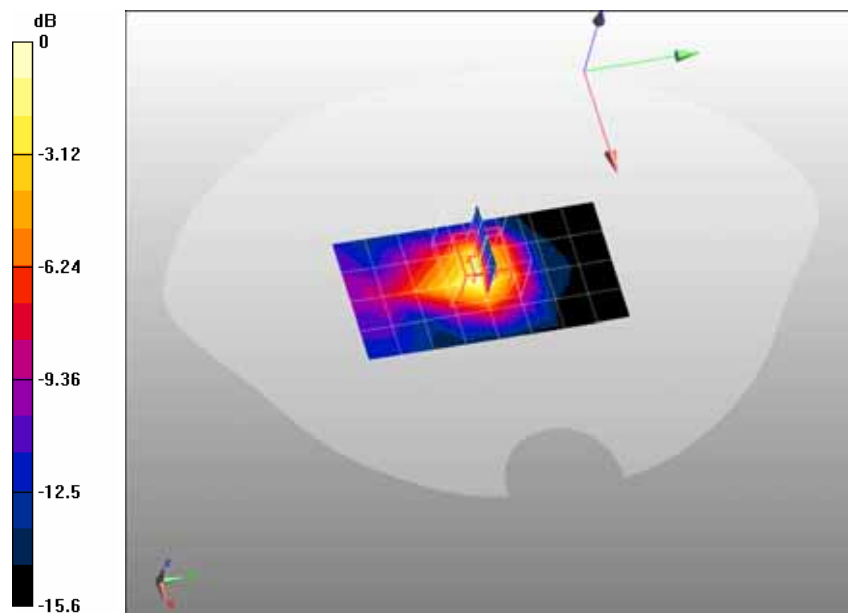

0 dB = 0.704mW/g

Z-Axis Plot

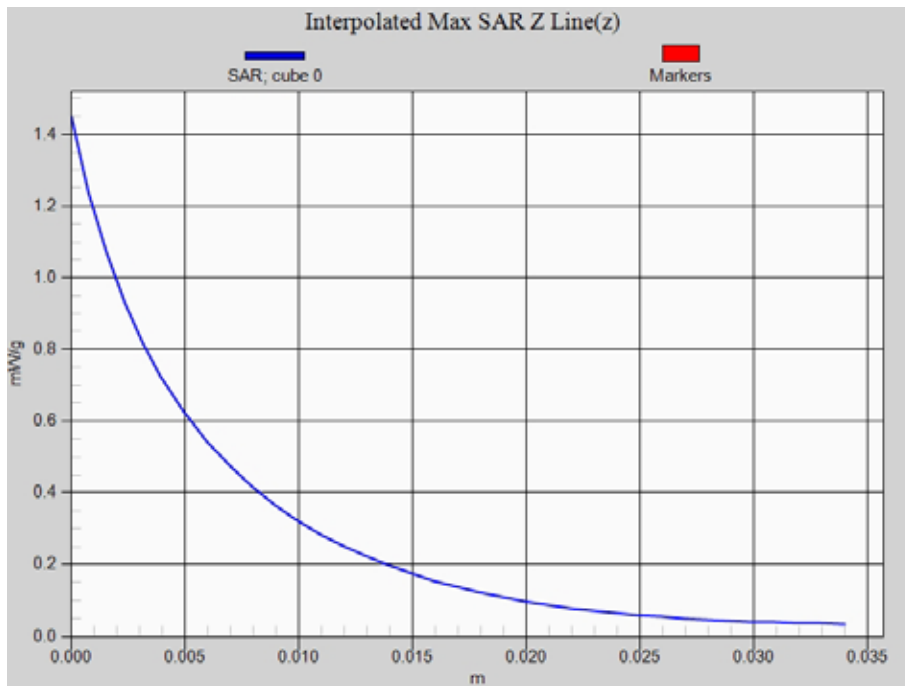

Date/Time: 30-01-2012

Test Laboratory: QuieTek Lab

802.11b Mid-Horizontal Up

DUT: 300 Mbps 802.11n Wireless USB Adapter; Type: Air 2411

Communication System: Wi-Fi; Communication System Band: 802.11b; Duty Cycle: 1:1; Frequency: 2437 MHz; Medium parameters used: $f = 2437$ MHz; $\sigma = 1.99$ mho/m; $\epsilon_r = 52.3$; $\rho = 1000$ kg/m³; Phantom section: Flat Section

Ambient temperature (°C): 21.5, Liquid temperature (°C): 21.0

DASY5 Configuration:

- Probe: EX3DV4 - SN3698; ConvF(6.60, 6.60, 6.60); Calibrated: 28/07/2011
- Sensor-Surface: 4mm (Mechanical Surface Detection)
- Electronics: DAE4 Sn915; Calibrated: 26/07/2011
- Phantom: SAM2; Type: SAM; Serial: TP1562
- Measurement SW: DASY5, V5.2 Build 162; SEMCAD X Version 14.0 Build 59

Configuration/802.11b Mid-Horizontal Up/Area Scan (5x9x1): Measurement grid: dx=15mm, dy=15mm

Maximum value of SAR (measured) = 0.564 mW/g

Configuration/802.11b Mid-Horizontal Up/Zoom Scan (5x5x7)/Cube 0: Measurement grid: dx=8mm, dy=8mm, dz=5mm, Reference Value = 14.2 V/m; Power Drift = 0.030 dB

Peak SAR (extrapolated) = 1.26 W/kg

SAR(1 g) = 0.564 mW/g; SAR(10 g) = 0.265 mW/g Maximum value of SAR (measured) = 0.624 mW/g

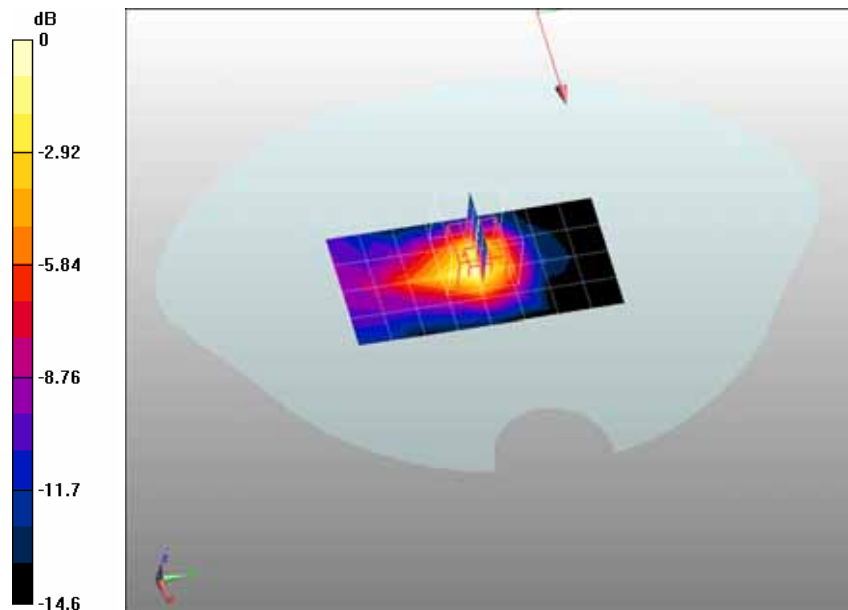

0 dB = 0.624mW/g

Date/Time: 30-01-2012

Test Laboratory: QuieTek Lab

802.11b High-Horizontal Up

DUT: 300 Mbps 802.11n Wireless USB Adapter; Type: Air 2411

Communication System: Wi-Fi; Communication System Band: 802.11b; Duty Cycle: 1:1; Frequency: 2462 MHz; Medium parameters used: $f = 2462$ MHz; $\sigma = 2.02$ mho/m; $\epsilon_r = 52.2$; $\rho = 1000$ kg/m³; Phantom section: Flat Section

Ambient temperature (°C): 21.5, Liquid temperature (°C): 21.0

DASY5 Configuration:

- Probe: EX3DV4 - SN3698; ConvF(6.60, 6.60, 6.60); Calibrated: 28/07/2011
- Sensor-Surface: 4mm (Mechanical Surface Detection)
- Electronics: DAE4 Sn915; Calibrated: 26/07/2011
- Phantom: SAM2; Type: SAM; Serial: TP1562
- Measurement SW: DASY5, V5.2 Build 162; SEMCAD X Version 14.0 Build 59

Configuration/802.11b High-Horizontal Up/Area Scan (5x9x1): Measurement grid: dx=15mm, dy=15mm

Maximum value of SAR (measured) = 0.538 mW/g

Configuration/802.11b High-Horizontal Up/Zoom Scan (5x5x7)/Cube 0: Measurement grid: dx=8mm, dy=8mm, dz=5mm, Reference Value = 15 V/m; Power Drift = 0.095 dB

Peak SAR (extrapolated) = 1.17 W/kg

SAR(1 g) = 0.528 mW/g; SAR(10 g) = 0.247 mW/g Maximum value of SAR (measured) = 0.587 mW/g

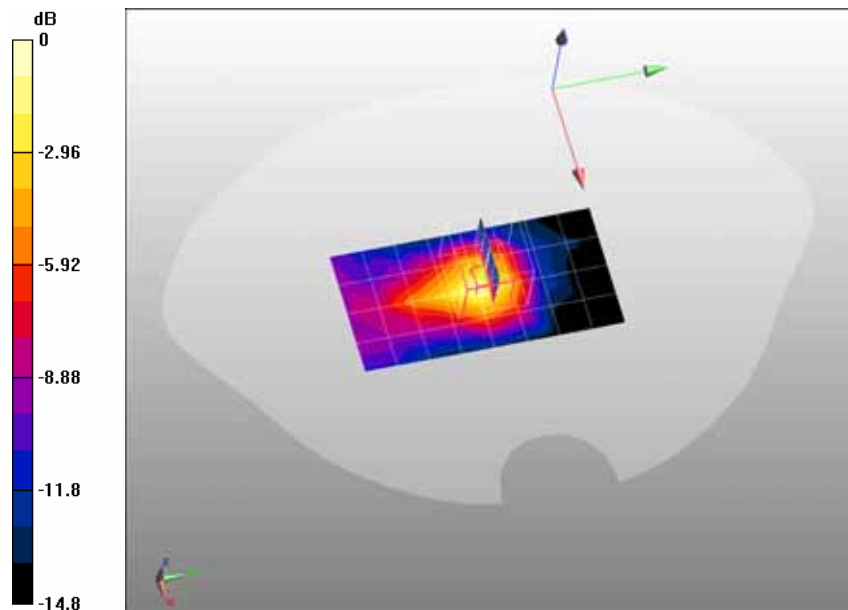

0 dB = 0.587mW/g

Date/Time: 30-01-2012

Test Laboratory: QuieTek Lab

802.11b Low-Horizontal Down

DUT: 300 Mbps 802.11n Wireless USB Adapter; Type: Air 2411

Communication System: Wi-Fi; Communication System Band: 802.11b; Duty Cycle: 1:1; Frequency: 2412 MHz; Medium parameters used: $f = 2412$ MHz; $\sigma = 1.95$ mho/m; $\epsilon_r = 52.4$; $\rho = 1000$ kg/m³; Phantom section: Flat Section

Ambient temperature (°C): 21.5, Liquid temperature (°C): 21.0

DASY5 Configuration:

- Probe: EX3DV4 - SN3698; ConvF(6.60, 6.60, 6.60); Calibrated: 28/07/2011
- Sensor-Surface: 4mm (Mechanical Surface Detection)
- Electronics: DAE4 Sn915; Calibrated: 26/07/2011
- Phantom: SAM2; Type: SAM; Serial: TP1562
- Measurement SW: DASY5, V5.2 Build 162; SEMCAD X Version 14.0 Build 59

Configuration/802.11b Low-Horizontal Down/Area Scan (5x9x1): Measurement grid: dx=15mm, dy=15mm

Maximum value of SAR (measured) = 0.420 mW/g

Configuration/802.11b Low-Horizontal Down/Zoom Scan (5x5x7)/Cube 0: Measurement grid: dx=8mm, dy=8mm, dz=5mm, Reference Value = 15.9 V/m; Power Drift = -0.137 dB

Peak SAR (extrapolated) = 0.991 W/kg

SAR(1 g) = 0.467 mW/g; SAR(10 g) = 0.218 mW/g Maximum value of SAR (measured) = 0.518 mW/g

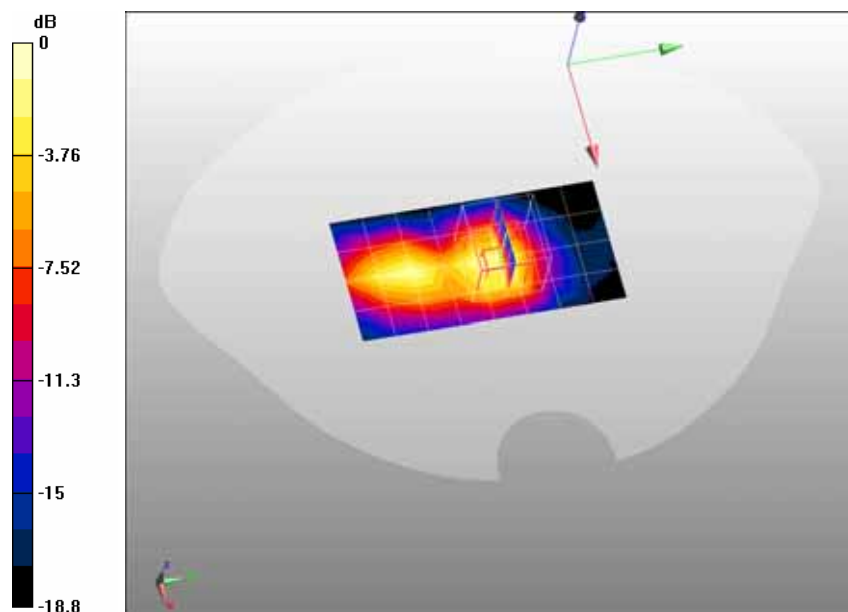

0 dB = 0.518mW/g

Date/Time: 30-01-2012

Test Laboratory: QuieTek Lab

802.11b Low-Vertical Front

DUT: 300 Mbps 802.11n Wireless USB Adapter; Type: Air 2411

Communication System: Wi-Fi; Communication System Band: 802.11b; Duty Cycle: 1:1; Frequency: 2412 MHz; Medium parameters used: $f = 2412$ MHz; $\sigma = 1.95$ mho/m; $\epsilon_r = 52.4$; $\rho = 1000$ kg/m³; Phantom section: Flat Section

Ambient temperature (°C): 21.5, Liquid temperature (°C): 21.0

DASY5 Configuration:

- Probe: EX3DV4 - SN3698; ConvF(6.60, 6.60, 6.60); Calibrated: 28/07/2011
- Sensor-Surface: 4mm (Mechanical Surface Detection)
- Electronics: DAE4 Sn915; Calibrated: 26/07/2011
- Phantom: SAM2; Type: SAM; Serial: TP1562
- Measurement SW: DASY5, V5.2 Build 162; SEMCAD X Version 14.0 Build 59

Configuration/802.11b Low-Vertical Front/Area Scan (5x9x1): Measurement grid: dx=15mm, dy=15mm

Maximum value of SAR (measured) = 0.088 mW/g

Configuration/802.11b Low-Vertical Front/Zoom Scan (5x5x7)/Cube 0: Measurement grid: dx=8mm, dy=8mm, dz=5mm, Reference Value = 6 V/m; Power Drift = 0.156 dB

Peak SAR (extrapolated) = 0.218 W/kg

SAR(1 g) = 0.083 mW/g; SAR(10 g) = 0.038 mW/g Maximum value of SAR (measured) = 0.094 mW/g

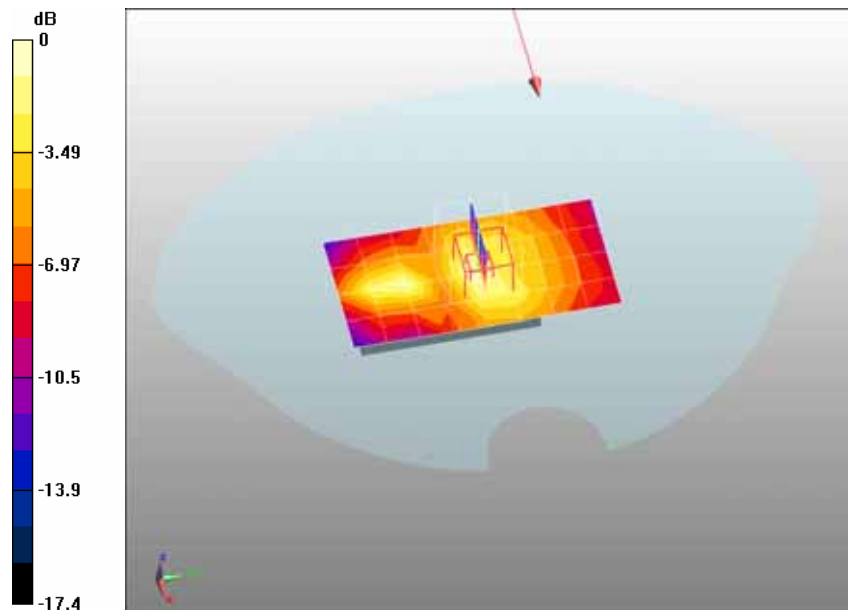

0 dB = 0.094mW/g

Date/Time: 30-01-2012

Test Laboratory: QuieTek Lab

802.11b Low-Vertical Back

DUT: 300 Mbps 802.11n Wireless USB Adapter; Type: Air 2411

Communication System: Wi-Fi; Communication System Band: 802.11b; Duty Cycle: 1:1; Frequency: 2412 MHz; Medium parameters used: $f = 2412$ MHz; $\sigma = 1.95$ mho/m; $\epsilon_r = 52.4$; $\rho = 1000$ kg/m³; Phantom section: Flat Section

Ambient temperature (°C): 21.5, Liquid temperature (°C): 21.0

DASY5 Configuration:

- Probe: EX3DV4 - SN3698; ConvF(6.60, 6.60, 6.60); Calibrated: 28/07/2011
- Sensor-Surface: 4mm (Mechanical Surface Detection)
- Electronics: DAE4 Sn915; Calibrated: 26/07/2011
- Phantom: SAM2; Type: SAM; Serial: TP1562
- Measurement SW: DASY5, V5.2 Build 162; SEMCAD X Version 14.0 Build 59

Configuration/802.11b Low-Vertical Back/Area Scan (5x9x1): Measurement grid: dx=15mm, dy=15mm

Maximum value of SAR (measured) = 0.373 mW/g

Configuration/802.11b Low-Vertical Back/Zoom Scan (5x5x7)/Cube 0: Measurement grid: dx=8mm, dy=8mm, dz=5mm, Reference Value = 12.8 V/m; Power Drift = -0.083 dB

Peak SAR (extrapolated) = 0.733 W/kg

SAR(1 g) = 0.325 mW/g; SAR(10 g) = 0.150 mW/g Maximum value of SAR (measured) = 0.355 mW/g

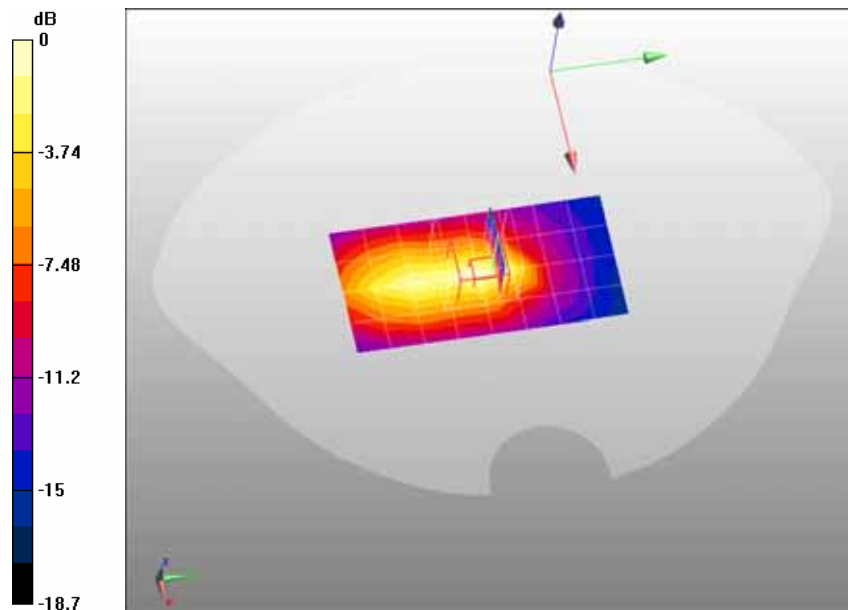

0 dB = 0.355mW/g

Date/Time: 30-01-2012

Test Laboratory: QuieTek Lab

802.11b Low-Tip Mode

DUT: 300 Mbps 802.11n Wireless USB Adapter; Type: Air 2411

Communication System: Wi-Fi; Communication System Band: 802.11b; Duty Cycle: 1:1; Frequency: 2412 MHz; Medium parameters used: $f = 2412$ MHz; $\sigma = 1.95$ mho/m; $\epsilon_r = 52.4$; $\rho = 1000$ kg/m³; Phantom section: Flat Section

Ambient temperature (°C): 21.5, Liquid temperature (°C): 21.0

DASY5 Configuration:

- Probe: EX3DV4 - SN3698; ConvF(6.60, 6.60, 6.60); Calibrated: 28/07/2011
- Sensor-Surface: 4mm (Mechanical Surface Detection)
- Electronics: DAE4 Sn915; Calibrated: 26/07/2011
- Phantom: SAM2; Type: SAM; Serial: TP1562
- Measurement SW: DASY5, V5.2 Build 162; SEMCAD X Version 14.0 Build 59

Configuration/802.11b Low-Tip Mode/Area Scan (7x7x1): Measurement grid: dx=15mm, dy=15mm

Maximum value of SAR (measured) = 0.115 mW/g

Configuration/802.11b Low-Tip Mode/Zoom Scan (5x5x7)/Cube 0: Measurement grid: dx=8mm, dy=8mm, dz=5mm, Reference Value = 7.43 V/m; Power Drift = 0.180 dB

Peak SAR (extrapolated) = 0.201 W/kg

SAR(1 g) = 0.101 mW/g; SAR(10 g) = 0.051 mW/g Maximum value of SAR (measured) = 0.111 mW/g

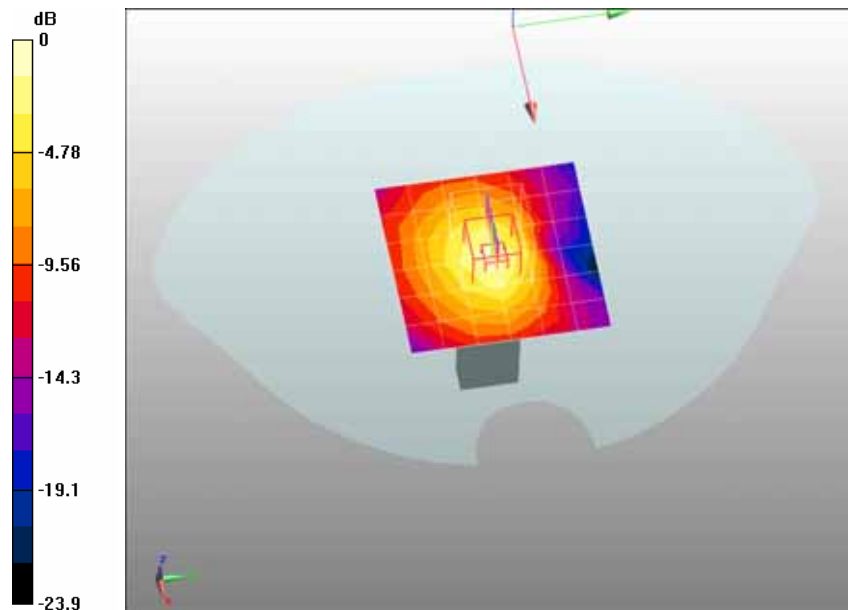

0 dB = 0.111mW/g

Date/Time: 30-01-2012

Test Laboratory: QuieTek Lab

802.11g Low-Horizontal Up

DUT: 300 Mbps 802.11n Wireless USB Adapter; Type: Air 2411

Communication System: Wi-Fi; Communication System Band: 802.11b; Duty Cycle: 1:1; Frequency: 2412 MHz; Medium parameters used: $f = 2412$ MHz; $\sigma = 1.95$ mho/m; $\epsilon_r = 52.4$; $\rho = 1000$ kg/m³; Phantom section: Flat Section

Ambient temperature (°C): 21.5, Liquid temperature (°C): 21.0

DASY5 Configuration:

- Probe: EX3DV4 - SN3698; ConvF(6.60, 6.60, 6.60); Calibrated: 28/07/2011
- Sensor-Surface: 4mm (Mechanical Surface Detection)
- Electronics: DAE4 Sn915; Calibrated: 26/07/2011
- Phantom: SAM2; Type: SAM; Serial: TP1562
- Measurement SW: DASY5, V5.2 Build 162; SEMCAD X Version 14.0 Build 59

Configuration/802.11g Low-Horizontal Up/Area Scan (5x9x1): Measurement grid: dx=15mm, dy=15mm

Maximum value of SAR (measured) = 0.381 mW/g

Configuration/802.11g Low-Horizontal Up/Zoom Scan (5x5x7)/Cube 0: Measurement grid: dx=8mm, dy=8mm, dz=5mm, Reference Value = 15.7 V/m; Power Drift = -0.173 dB

Peak SAR (extrapolated) = 0.790 W/kg

SAR(1 g) = 0.366 mW/g; SAR(10 g) = 0.178 mW/g Maximum value of SAR (measured) = 0.405 mW/g

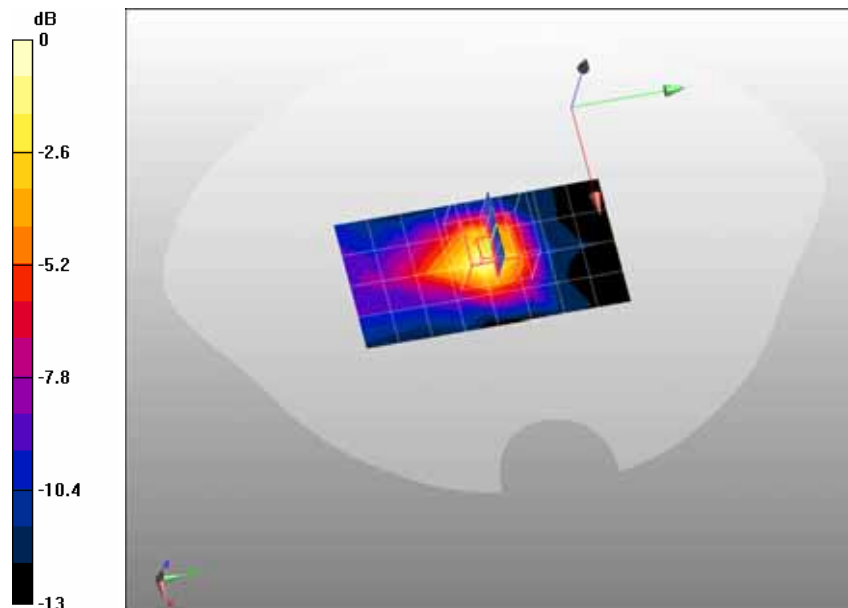

0 dB = 0.405mW/g

Date/Time: 30-01-2012

Test Laboratory: QuieTek Lab

802.11n(20MHz) Low-Horizontal Up

DUT: 300 Mbps 802.11n Wireless USB Adapter; Type: Air 2411

Communication System: Wi-Fi; Communication System Band: 802.11b; Duty Cycle: 1:1; Frequency: 2412 MHz; Medium parameters used: $f = 2412$ MHz; $\sigma = 1.95$ mho/m; $\epsilon_r = 52.4$; $\rho = 1000$ kg/m³; Phantom section: Flat Section

Ambient temperature (°C): 21.5, Liquid temperature (°C): 21.0

DASY5 Configuration:

- Probe: EX3DV4 - SN3698; ConvF(6.60, 6.60, 6.60); Calibrated: 28/07/2011
- Sensor-Surface: 4mm (Mechanical Surface Detection)
- Electronics: DAE4 Sn915; Calibrated: 26/07/2011
- Phantom: SAM2; Type: SAM; Serial: TP1562
- Measurement SW: DASY5, V5.2 Build 162; SEMCAD X Version 14.0 Build 59

Configuration/802.11n(20MHz) Low-Horizontal Up/Area Scan (5x9x1): Measurement grid: dx=15mm, dy=15mm

Maximum value of SAR (measured) = 0.272 mW/g

Configuration/802.11n(20MHz) Low-Horizontal Up/Zoom Scan (5x5x7)/Cube 0: Measurement grid: dx=8mm, dy=8mm, dz=5mm, Reference Value = 11.6 V/m; Power Drift = -0.037 dB

Peak SAR (extrapolated) = 0.731 W/kg

SAR(1 g) = 0.332 mW/g; SAR(10 g) = 0.162 mW/g Maximum value of SAR (measured) = 0.365 mW/g

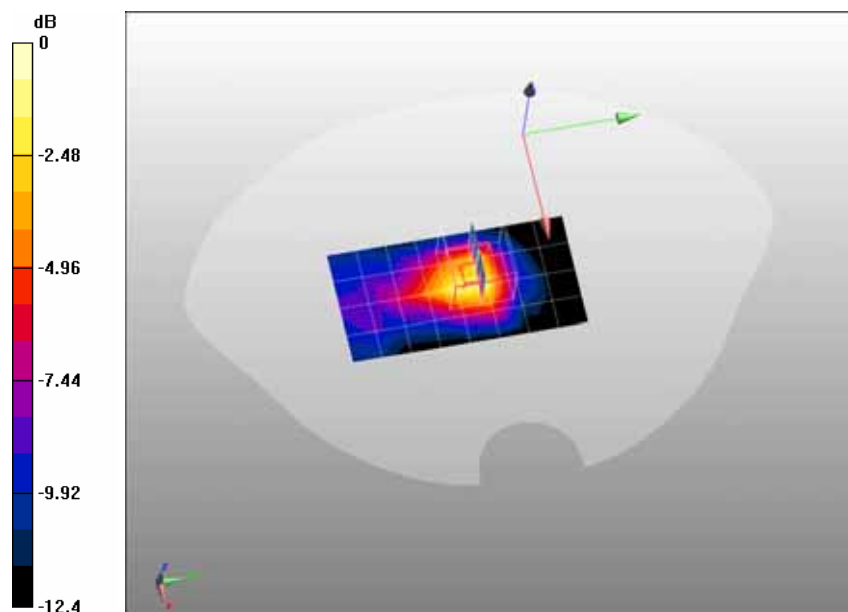

0 dB = 0.365mW/g

Date/Time: 30-01-2012

Test Laboratory: QuieTek Lab

802.11n(40MHz) High-Horizontal Up

DUT: 300 Mbps 802.11n Wireless USB Adapter; Type: Air 2411

Communication System: Wi-Fi; Communication System Band: 802.11n(40MHz); Duty Cycle: 1:1; Frequency: 2452 MHz; Medium parameters used: $f = 2452 \text{ MHz}$; $\sigma = 2.01 \text{ mho/m}$; $\epsilon_r = 52.3$; $\rho = 1000 \text{ kg/m}^3$; Phantom section: Flat Section

Ambient temperature (°C): 21.5, Liquid temperature (°C): 21.0

DASY5 Configuration:

- Probe: EX3DV4 - SN3698; ConvF(6.60, 6.60, 6.60); Calibrated: 28/07/2011
- Sensor-Surface: 4mm (Mechanical Surface Detection)
- Electronics: DAE4 Sn915; Calibrated: 26/07/2011
- Phantom: SAM2; Type: SAM; Serial: TP1562
- Measurement SW: DASY5, V5.2 Build 162; SEMCAD X Version 14.0 Build 59

Configuration/802.11n(40MHz) High-Horizontal Up/Area Scan (5x9x1): Measurement grid: dx=15mm, dy=15mm

Maximum value of SAR (measured) = 0.296 mW/g

Configuration/802.11n(40MHz) High-Horizontal Up/Zoom Scan (5x5x7)/Cube 0: Measurement grid: dx=8mm, dy=8mm, dz=5mm, Reference Value = 10.7 V/m; Power Drift = 0.182 dB

Peak SAR (extrapolated) = 0.688 W/kg

SAR(1 g) = 0.331 mW/g; SAR(10 g) = 0.164 mW/g Maximum value of SAR (measured) = 0.365 mW/g

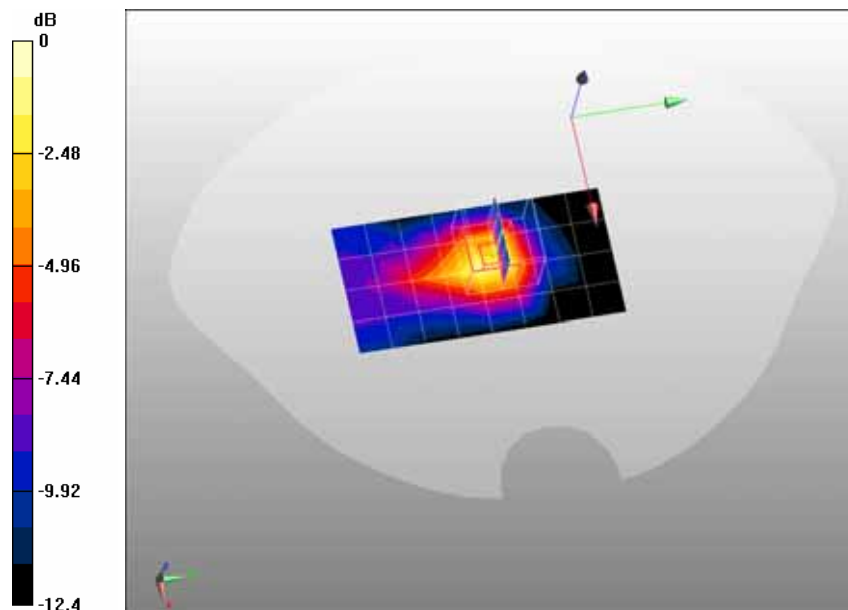

0 dB = 0.365mW/g

Date/Time: 30-01-2012

Test Laboratory: QuieTek Lab

802.11n(20MHz) 5180MHz-Horizontal Up

DUT: 300 Mbps 802.11n Wireless USB Adapter; Type: Air 2411

Communication System: CW; Communication System Band: D5GHz (5000.0 - 6000.0 MHz); Duty Cycle: 1:1; Frequency: 5180 MHz; Medium parameters used: $f = 5180$ MHz; $\sigma = 5.12$ mho/m; $\epsilon_r = 48$; $\rho = 1000$ kg/m³; Phantom section: Flat Section

Ambient temperature (°C): 21.5, Liquid temperature (°C): 21.0

DASY5 Configuration:

- Probe: EX3DV4 - SN3698; ConvF(3.95, 3.95, 3.95); Calibrated: 28/07/2011
- Sensor-Surface: 2mm (Mechanical Surface Detection)
- Electronics: DAE4 Sn915; Calibrated: 26/07/2011
- Phantom: SAM2; Type: SAM; Serial: TP1562
- Measurement SW: DASY5, V5.2 Build 162; SEMCAD X Version 14.0 Build 59

Configuration/802.11n(20MHz) Channel36-Horizontal Up/Area Scan (6x11x1): Measurement grid:

dx=10mm, dy=10mm

Maximum value of SAR (measured) = 0.556 mW/g

Configuration/802.11n(20MHz) Channel36-Horizontal Up/Zoom Scan (7x7x9)/Cube 0: Measurement

grid: dx=4mm, dy=4mm, dz=2.5mm, Reference Value = 8.09 V/m; Power Drift = 0.159 dB

Peak SAR (extrapolated) = 1.35 W/kg

SAR(1 g) = 0.347 mW/g; SAR(10 g) = 0.173 mW/g Maximum value of SAR (measured) = 0.644 mW/g

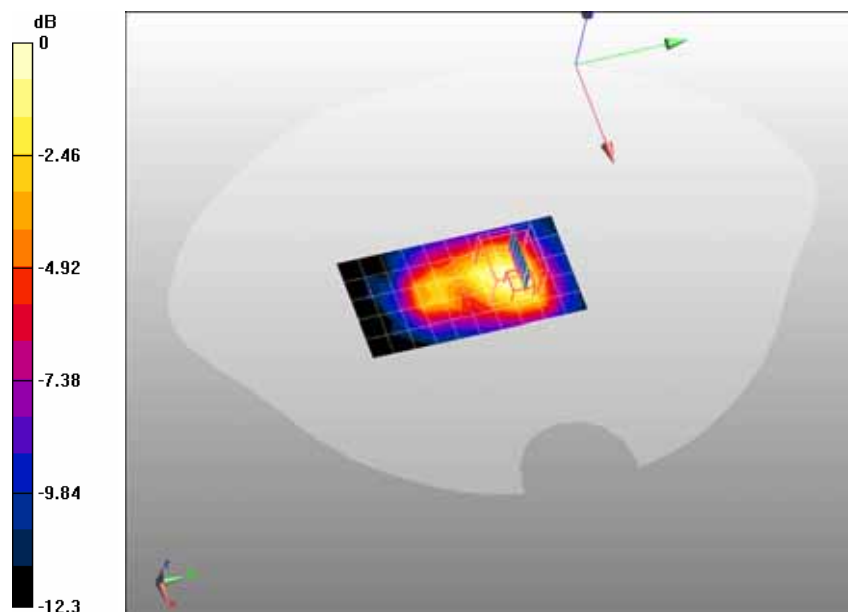

0 dB = 0.644mW/g

Date/Time: 30-01-2012

Test Laboratory: QuieTek Lab

802.11n(20MHz) 5180MHz-Horizontal Down

DUT: 300 Mbps 802.11n Wireless USB Adapter; Type: Air 2411

Communication System: CW; Communication System Band: D5GHz (5000.0 - 6000.0 MHz); Duty Cycle: 1:1; Frequency: 5180 MHz; Medium parameters used: $f = 5180$ MHz; $\sigma = 5.12$ mho/m; $\epsilon_r = 48$; $\rho = 1000$ kg/m³; Phantom section: Flat Section

Ambient temperature (°C): 21.5, Liquid temperature (°C): 21.0

DASY5 Configuration:

- Probe: EX3DV4 - SN3698; ConvF(3.95, 3.95, 3.95); Calibrated: 28/07/2011
- Sensor-Surface: 2mm (Mechanical Surface Detection)
- Electronics: DAE4 Sn915; Calibrated: 26/07/2011
- Phantom: SAM2; Type: SAM; Serial: TP1562
- Measurement SW: DASY5, V5.2 Build 162; SEMCAD X Version 14.0 Build 59

Configuration/802.11n(20MHz) Channel36-Horizontal Down/Area Scan (6x11x1): Measurement grid:

dx=10mm, dy=10mm

Maximum value of SAR (measured) = 0.450 mW/g

Configuration/802.11n(20MHz) Channel36-Horizontal Down/Zoom Scan (7x7x9)/Cube 0: Measurement

grid: dx=4mm, dy=4mm, dz=2.5mm, Reference Value = 6.45 V/m; Power Drift = -0.060 dB

Peak SAR (extrapolated) = 0.891 W/kg

SAR(1 g) = 0.248 mW/g; SAR(10 g) = 0.088 mW/g Maximum value of SAR (measured) = 0.482 mW/g

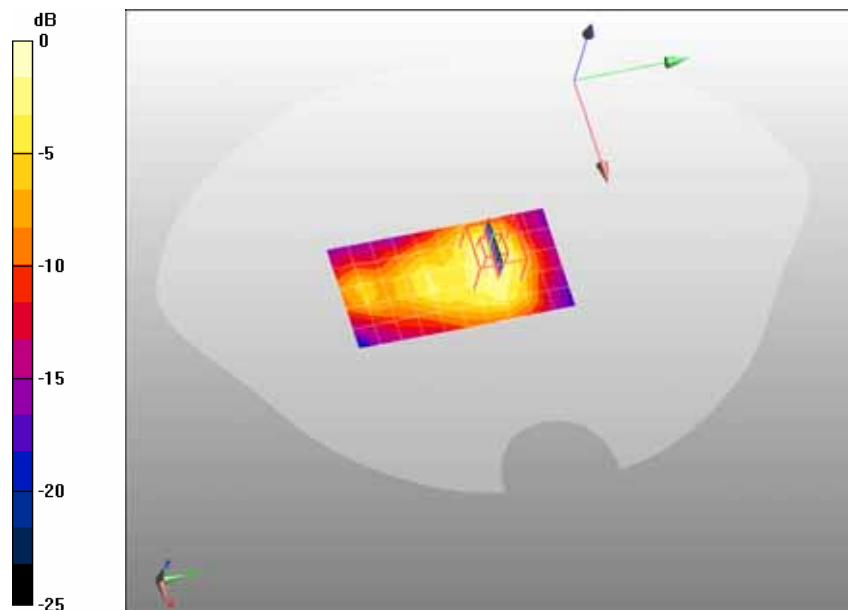

0 dB = 0.482mW/g

Date/Time: 30-01-2012

Test Laboratory: QuieTek Lab

802.11n(20MHz) 5180MHz-Vertical Front

DUT: 300 Mbps 802.11n Wireless USB Adapter; Type: Air 2411

Communication System: CW; Communication System Band: D5GHz (5000.0 - 6000.0 MHz); Duty Cycle: 1:1; Frequency: 5180 MHz; Medium parameters used: $f = 5180$ MHz; $\sigma = 5.12$ mho/m; $\epsilon_r = 48$; $\rho = 1000$ kg/m³; Phantom section: Flat Section

Ambient temperature (°C): 21.5, Liquid temperature (°C): 21.0

DASY5 Configuration:

- Probe: EX3DV4 - SN3698; ConvF(3.95, 3.95, 3.95); Calibrated: 28/07/2011
- Sensor-Surface: 2mm (Mechanical Surface Detection)
- Electronics: DAE4 Sn915; Calibrated: 26/07/2011
- Phantom: SAM2; Type: SAM; Serial: TP1562
- Measurement SW: DASY5, V5.2 Build 162; SEMCAD X Version 14.0 Build 59

Configuration/802.11n(20MHz) Channel36-Vertical Front/Area Scan (6x11x1): Measurement grid:

dx=10mm, dy=10mm

Maximum value of SAR (measured) = 0.612 mW/g

Configuration/802.11n(20MHz) Channel36-Vertical Front/Zoom Scan (7x7x9)/Cube 0: Measurement

grid: dx=4mm, dy=4mm, dz=2.5mm, Reference Value = 9.16 V/m; Power Drift = -0.105 dB

Peak SAR (extrapolated) = 1.27 W/kg

SAR(1 g) = 0.349 mW/g; SAR(10 g) = 0.109 mW/g Maximum value of SAR (measured) = 0.699 mW/g

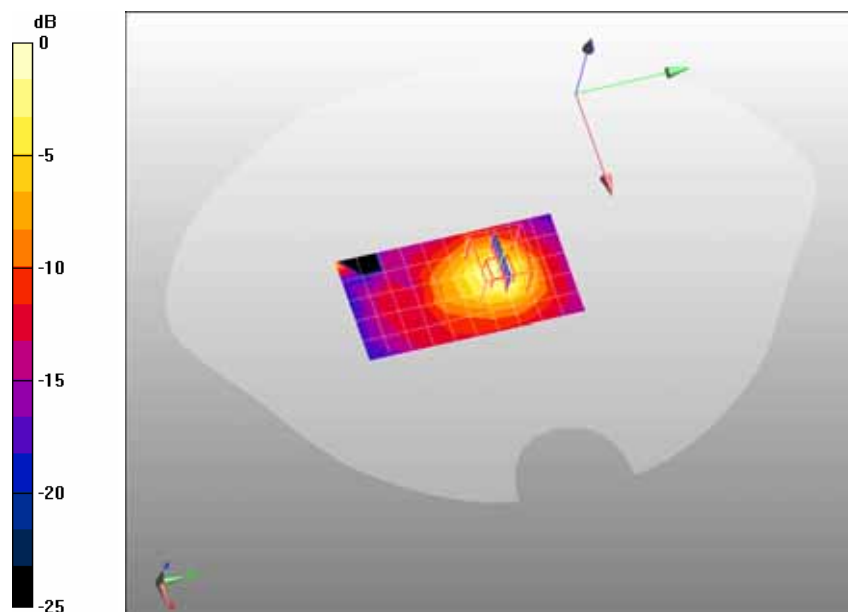

0 dB = 0.699mW/g

Date/Time: 30-01-2012

Test Laboratory: QuieTek Lab

802.11n(20MHz) 5180MHz-Vertical Back

DUT: 300 Mbps 802.11n Wireless USB Adapter; Type: Air 2411

Communication System: CW; Communication System Band: D5GHz (5000.0 - 6000.0 MHz); Duty Cycle: 1:1; Frequency: 5180 MHz; Medium parameters used: $f = 5180$ MHz; $\sigma = 5.12$ mho/m; $\epsilon_r = 48$; $\rho = 1000$ kg/m³; Phantom section: Flat Section

Ambient temperature (°C): 21.5, Liquid temperature (°C): 21.0

DASY5 Configuration:

- Probe: EX3DV4 - SN3698; ConvF(3.95, 3.95, 3.95); Calibrated: 28/07/2011
- Sensor-Surface: 2mm (Mechanical Surface Detection)
- Electronics: DAE4 Sn915; Calibrated: 26/07/2011
- Phantom: SAM2; Type: SAM; Serial: TP1562
- Measurement SW: DASY5, V5.2 Build 162; SEMCAD X Version 14.0 Build 59

Configuration/802.11n(20MHz) Channel36-Vertical Back/Area Scan (6x11x1): Measurement grid:

dx=10mm, dy=10mm

Maximum value of SAR (measured) = 0.480 mW/g

Configuration/802.11n(20MHz) Channel36-Vertical Back/Zoom Scan (7x7x9)/Cube 0: Measurement

grid: dx=4mm, dy=4mm, dz=2.5mm, Reference Value = 8.83 V/m; Power Drift = 0.135 dB

Peak SAR (extrapolated) = 1.33 W/kg

SAR(1 g) = 0.336 mW/g; SAR(10 g) = 0.099 mW/g Maximum value of SAR (measured) = 0.681 mW/g

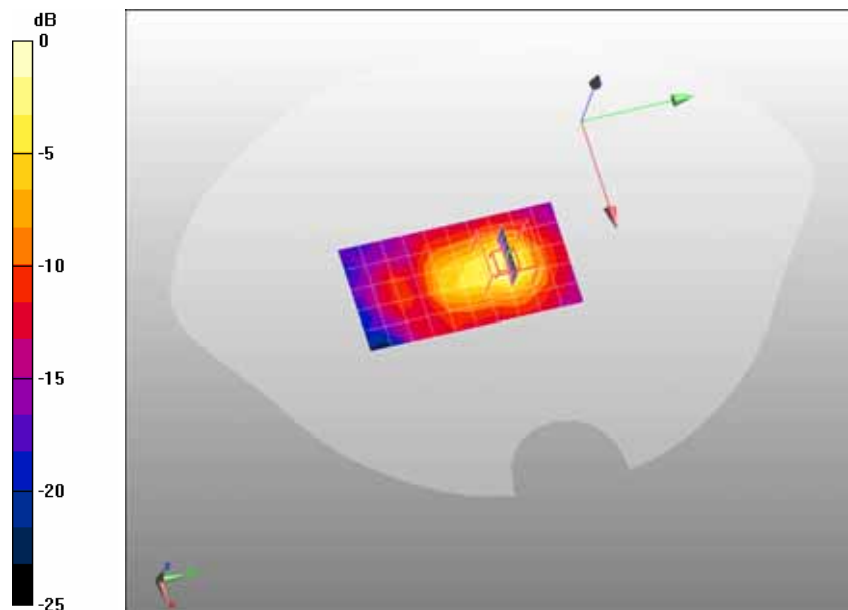

0 dB = 0.681mW/g

Date/Time: 30-01-2012

Test Laboratory: QuieTek Lab

802.11n(20MHz) 5180MHz-Tip Mode

DUT: 300 Mbps 802.11n Wireless USB Adapter; Type: Air 2411

Communication System: CW; Communication System Band: D5GHz (5000.0 - 6000.0 MHz); Duty Cycle: 1:1; Frequency: 5180 MHz; Medium parameters used: $f = 5180$ MHz; $\sigma = 5.12$ mho/m; $\epsilon_r = 48$; $\rho = 1000$ kg/m³; Phantom section: Flat Section

Ambient temperature (°C): 21.5, Liquid temperature (°C): 21.0

DASY5 Configuration:

- Probe: EX3DV4 - SN3698; ConvF(3.95, 3.95, 3.95); Calibrated: 28/07/2011
- Sensor-Surface: 2mm (Mechanical Surface Detection)
- Electronics: DAE4 Sn915; Calibrated: 26/07/2011
- Phantom: SAM2; Type: SAM; Serial: TP1562
- Measurement SW: DASY5, V5.2 Build 162; SEMCAD X Version 14.0 Build 59

Configuration/802.11n(20MHz) Channel36-Tip Mode/Area Scan (6x7x1): Measurement grid: dx=10mm, dy=10mm

Maximum value of SAR (measured) = 0.138 mW/g

Configuration/802.11n(20MHz) Channel36-Tip Mode/Zoom Scan (7x7x9)/Cube 0: Measurement grid: dx=4mm, dy=4mm, dz=2.5mm, Reference Value = 3.51 V/m; Power Drift = 0.108 dB

Peak SAR (extrapolated) = 0.285 W/kg

SAR(1 g) = 0.080 mW/g; SAR(10 g) = 0.030 mW/g Maximum value of SAR (measured) = 0.146 mW/g

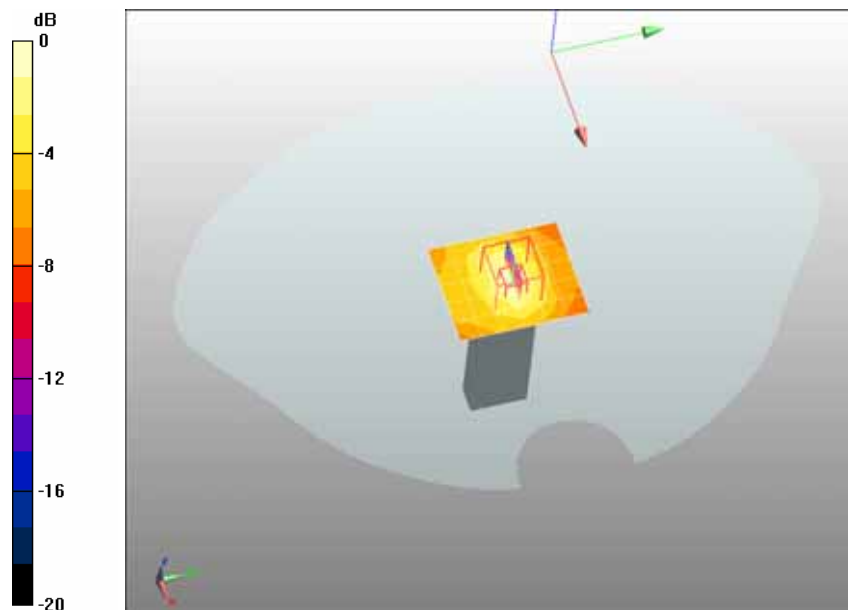

0 dB = 0.146mW/g

Date/Time: 30-01-2012

Test Laboratory: QuieTek Lab

802.11n(20MHz) 5240MHz-Vertical Front

DUT: 300 Mbps 802.11n Wireless USB Adapter; Type: Air 2411

Communication System: CW; Communication System Band: D5GHz (5000.0 - 6000.0 MHz); Duty Cycle: 1:1; Frequency: 5240 MHz; Medium parameters used: $f = 5240$ MHz; $\sigma = 5.2$ mho/m; $\epsilon_r = 47.8$; $\rho = 1000$ kg/m³; Phantom section: Flat Section

Ambient temperature (°C): 21.5, Liquid temperature (°C): 21.0

DASY5 Configuration:

- Probe: EX3DV4 - SN3698; ConvF(3.95, 3.95, 3.95); Calibrated: 28/07/2011
- Sensor-Surface: 2mm (Mechanical Surface Detection)
- Electronics: DAE4 Sn915; Calibrated: 26/07/2011
- Phantom: SAM2; Type: SAM; Serial: TP1562
- Measurement SW: DASY5, V5.2 Build 162; SEMCAD X Version 14.0 Build 59

Configuration/802.11n(20MHz) Channel48-Vertical Front/Area Scan (6x11x1): Measurement grid:

dx=10mm, dy=10mm

Maximum value of SAR (measured) = 0.609 mW/g

Configuration/802.11n(20MHz) Channel48-Vertical Front/Zoom Scan (7x7x9)/Cube 0: Measurement

grid: dx=4mm, dy=4mm, dz=2.5mm, Reference Value = 9 V/m; Power Drift = 0.032 dB

Peak SAR (extrapolated) = 1.26 W/kg

SAR(1 g) = 0.350 mW/g; SAR(10 g) = 0.112 mW/g Maximum value of SAR (measured) = 0.695 mW/g

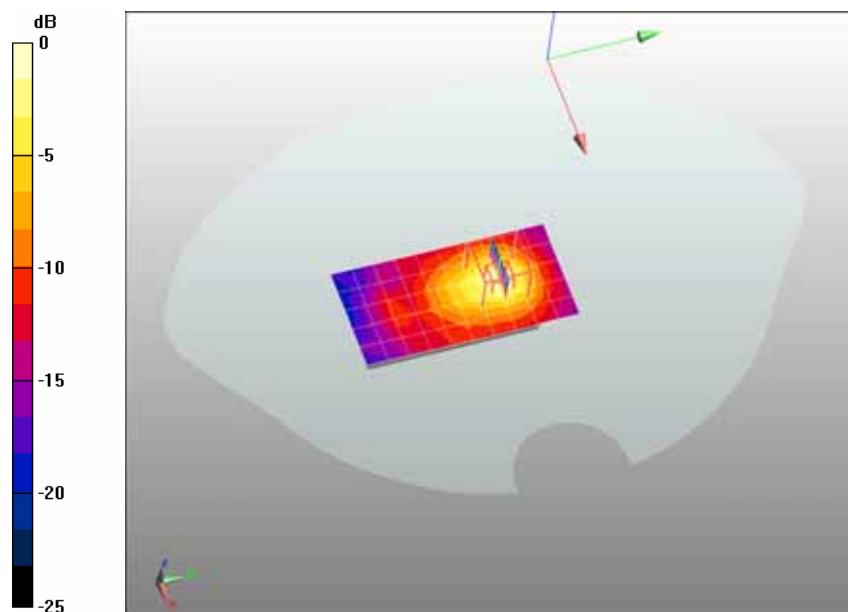

0 dB = 0.695mW/g

Date/Time: 30-01-2012

Test Laboratory: QuieTek Lab

802.11n(20MHz) 5745MHz-Vertical Front

DUT: 300 Mbps 802.11n Wireless USB Adapter; Type: Air 2411

Communication System: CW; Communication System Band: D5GHz (5000.0 - 6000.0 MHz); Duty Cycle: 1:1; Frequency: 5745 MHz; Medium parameters used: $f = 5745$ MHz; $\sigma = 5.95$ mho/m; $\epsilon_r = 46.4$; $\rho = 1000$ kg/m³; Phantom section: Flat Section

Ambient temperature (°C): 21.5, Liquid temperature (°C): 21.0

DASY5 Configuration:

- Probe: EX3DV4 - SN3698; ConvF(3.74, 3.74, 3.74); Calibrated: 28/07/2011
- Sensor-Surface: 2mm (Mechanical Surface Detection)
- Electronics: DAE4 Sn915; Calibrated: 26/07/2011
- Phantom: SAM2; Type: SAM; Serial: TP1562
- Measurement SW: DASY5, V5.2 Build 162; SEMCAD X Version 14.0 Build 59

Configuration/802.11n(20MHz) Channel149-Vertical Front/Area Scan (6x11x1): Measurement grid:

dx=10mm, dy=10mm

Maximum value of SAR (measured) = 0.673 mW/g

Configuration/802.11n(20MHz) Channel149-Vertical Front/Zoom Scan (7x7x9)/Cube 0: Measurement

grid: dx=4mm, dy=4mm, dz=2.5mm, Reference Value = 8.44 V/m; Power Drift = 0.067 dB

Peak SAR (extrapolated) = 1.47 W/kg

SAR(1 g) = 0.364 mW/g; SAR(10 g) = 0.117 mW/g Maximum value of SAR (measured) = 0.748 mW/g

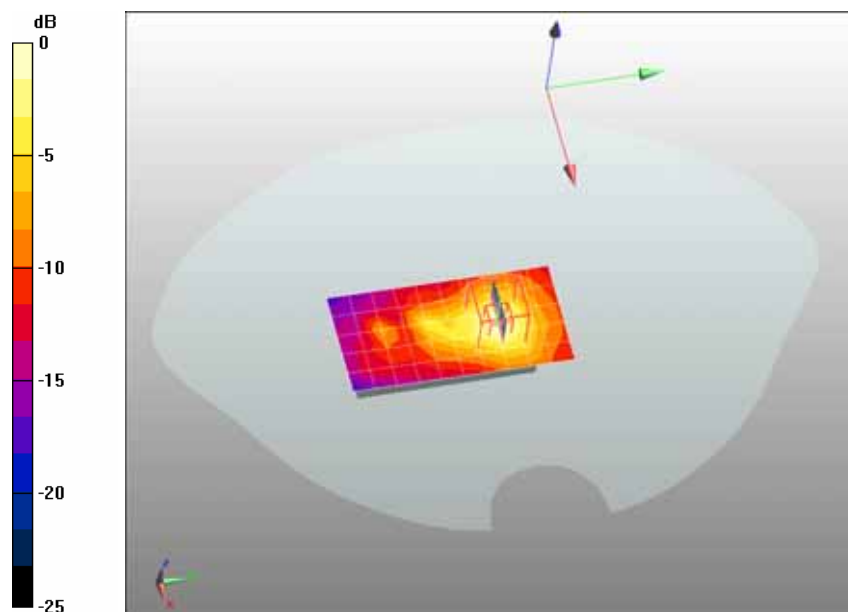

0 dB = 0.748mW/g

Date/Time: 30-01-2012

Test Laboratory: QuieTek Lab

802.11n(20MHz) 5785MHz-Vertical Front

DUT: 300 Mbps 802.11n Wireless USB Adapter; Type: Air 2411

Communication System: CW; Communication System Band: D5GHz (5000.0 - 6000.0 MHz); Duty Cycle: 1:1; Frequency: 5785 MHz; Medium parameters used: $f = 5785 \text{ MHz}$; $\sigma = 6 \text{ mho/m}$; $\epsilon_r = 46.3$; $\rho = 1000 \text{ kg/m}^3$; Phantom section: Flat Section

Ambient temperature (°C): 21.5, Liquid temperature (°C): 21.0

DASY5 Configuration:

- Probe: EX3DV4 - SN3698; ConvF(3.74, 3.74, 3.74); Calibrated: 28/07/2011
- Sensor-Surface: 2mm (Mechanical Surface Detection)
- Electronics: DAE4 Sn915; Calibrated: 26/07/2011
- Phantom: SAM2; Type: SAM; Serial: TP1562
- Measurement SW: DASY5, V5.2 Build 162; SEMCAD X Version 14.0 Build 59

Configuration/802.11n(20MHz) Channel157-Vertical Front/Area Scan (6x11x1): Measurement grid:

$dx=10\text{mm}$, $dy=10\text{mm}$

Maximum value of SAR (measured) = 0.704 mW/g

Configuration/802.11n(20MHz) Channel157-Vertical Front/Zoom Scan (7x7x9)/Cube 0: Measurement

grid: $dx=4\text{mm}$, $dy=4\text{mm}$, $dz=2.5\text{mm}$, Reference Value = 8.46 V/m; Power Drift = 0.136 dB

Peak SAR (extrapolated) = 2.8 W/kg

SAR(1 g) = 0.374 mW/g; SAR(10 g) = 0.123 mW/g Maximum value of SAR (measured) = 0.773 mW/g

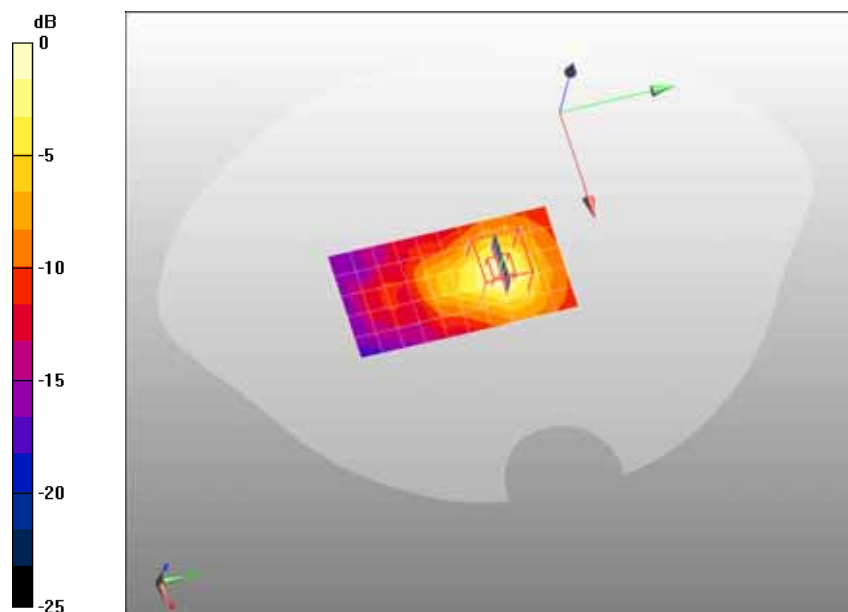

0 dB = 0.773mW/g

Z-Axis Plot

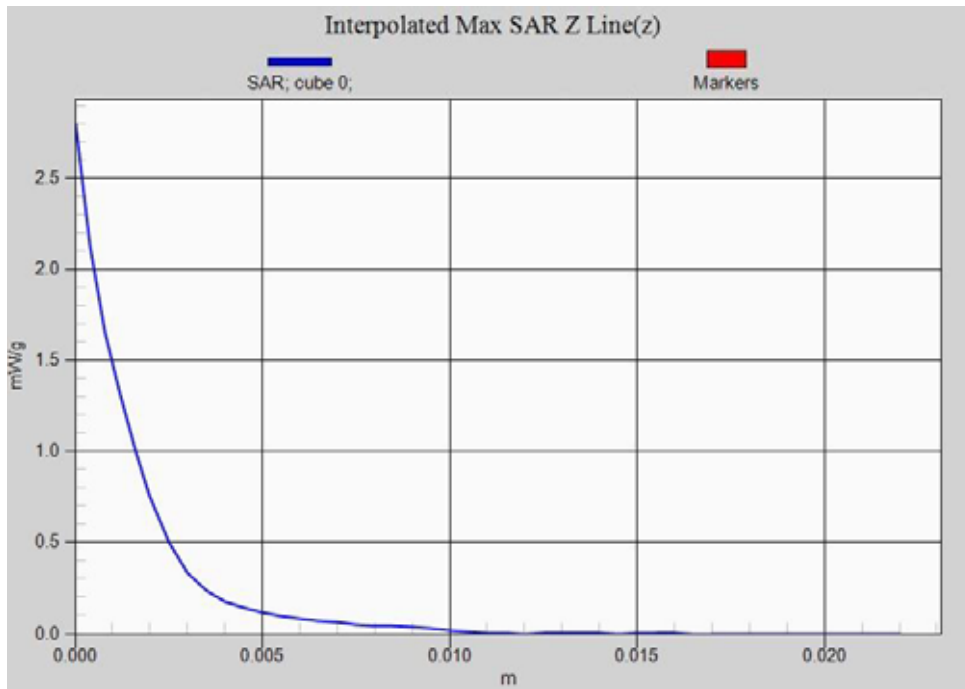

Date/Time: 30-01-2012

Test Laboratory: QuieTek Lab

802.11n(20MHz) 5825MHz-Vertical Front

DUT: 300 Mbps 802.11n Wireless USB Adapter; Type: Air 2411

Communication System: CW; Communication System Band: D5GHz (5000.0 - 6000.0 MHz); Duty Cycle: 1:1; Frequency: 5825 MHz; Medium parameters used: $f = 5825$ MHz; $\sigma = 6.07$ mho/m; $\epsilon_r = 46.2$; $\rho = 1000$ kg/m³; Phantom section: Flat Section

Ambient temperature (°C): 21.5, Liquid temperature (°C): 21.0

DASY5 Configuration:

- Probe: EX3DV4 - SN3698; ConvF(3.74, 3.74, 3.74); Calibrated: 28/07/2011
- Sensor-Surface: 2mm (Mechanical Surface Detection)
- Electronics: DAE4 Sn915; Calibrated: 26/07/2011
- Phantom: SAM2; Type: SAM; Serial: TP1562
- Measurement SW: DASY5, V5.2 Build 162; SEMCAD X Version 14.0 Build 59

Configuration/802.11n(20MHz) Channel165-Vertical Front/Area Scan (6x11x1): Measurement grid:

dx=10mm, dy=10mm

Maximum value of SAR (measured) = 0.593 mW/g

Configuration/802.11n(20MHz) Channel165-Vertical Front/Zoom Scan (7x7x9)/Cube 0: Measurement

grid: dx=4mm, dy=4mm, dz=2.5mm, Reference Value = 7.9 V/m; Power Drift = 0.096 dB

Peak SAR (extrapolated) = 1.34 W/kg

SAR(1 g) = 0.329 mW/g; SAR(10 g) = 0.106 mW/g Maximum value of SAR (measured) = 0.674 mW/g

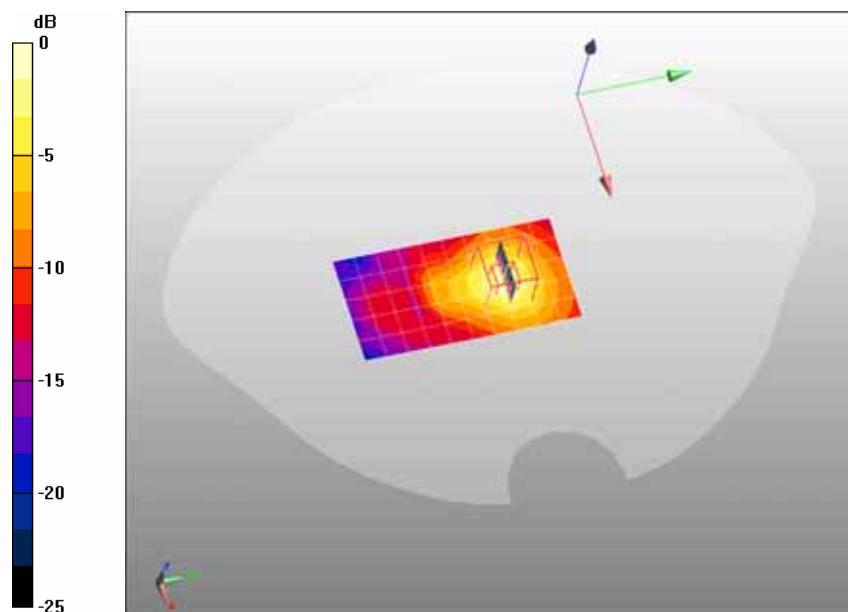

0 dB = 0.674mW/g

Date/Time: 30-01-2012

Test Laboratory: QuieTek Lab

802.11n(40MHz) 5190MHz-Vertical Front

DUT: 300 Mbps 802.11n Wireless USB Adapter; Type: Air 2411

Communication System: CW; Communication System Band: D5GHz (5000.0 - 6000.0 MHz); Duty Cycle: 1:1; Frequency: 5190 MHz; Medium parameters used: $f = 5190$ MHz; $\sigma = 5.14$ mho/m; $\epsilon_r = 47.9$; $\rho = 1000$ kg/m³; Phantom section: Flat Section

Ambient temperature (°C): 21.5, Liquid temperature (°C): 21.0

DASY5 Configuration:

- Probe: EX3DV4 - SN3698; ConvF(3.95, 3.95, 3.95); Calibrated: 28/07/2011
- Sensor-Surface: 2mm (Mechanical Surface Detection)
- Electronics: DAE4 Sn915; Calibrated: 26/07/2011
- Phantom: SAM2; Type: SAM; Serial: TP1562
- Measurement SW: DASY5, V5.2 Build 162; SEMCAD X Version 14.0 Build 59

Configuration/802.11n(40MHz) Channel38-Vertical Front/Area Scan (6x11x1): Measurement grid:

dx=10mm, dy=10mm

Maximum value of SAR (measured) = 0.256 mW/g

Configuration/802.11n(40MHz) Channel38-Vertical Front/Zoom Scan (7x7x9)/Cube 0: Measurement

grid: dx=4mm, dy=4mm, dz=2.5mm, Reference Value = 5.91 V/m; Power Drift = 0.093 dB

Peak SAR (extrapolated) = 0.995 W/kg

SAR(1 g) = 0.185 mW/g; SAR(10 g) = 0.064 mW/g Maximum value of SAR (measured) = 0.343 mW/g

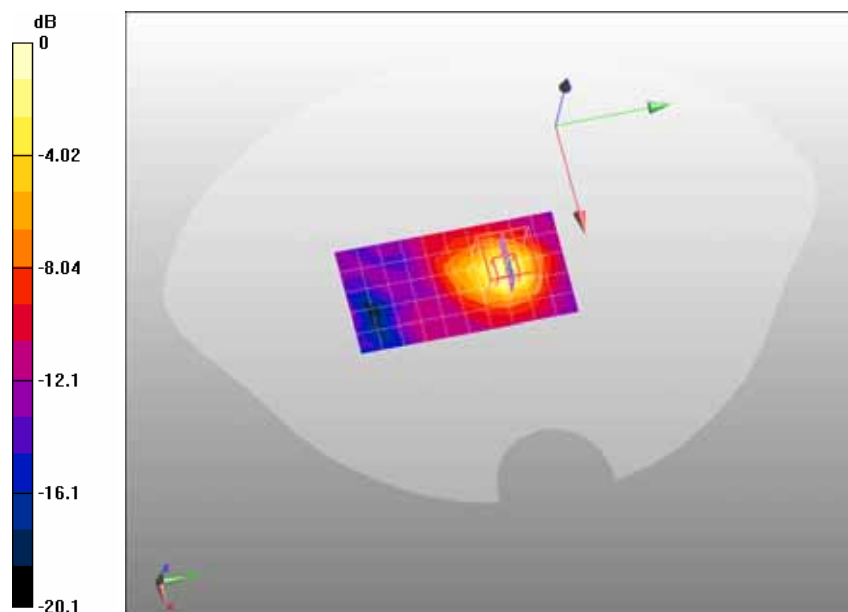

0 dB = 0.343mW/g

Date/Time: 30-01-2012

Test Laboratory: QuieTek Lab

802.11n(40MHz) 5230MHz-Vertical Front

DUT: 300 Mbps 802.11n Wireless USB Adapter; Type: Air 2411

Communication System: CW; Communication System Band: D5GHz (5000.0 - 6000.0 MHz); Duty Cycle: 1:1; Frequency: 5230 MHz; Medium parameters used: $f = 5230 \text{ MHz}$; $\sigma = 5.18 \text{ mho/m}$; $\epsilon_r = 47.9$; $\rho = 1000 \text{ kg/m}^3$; Phantom section: Flat Section

Ambient temperature (°C): 21.5, Liquid temperature (°C): 21.0

DASY5 Configuration:

- Probe: EX3DV4 - SN3698; ConvF(3.95, 3.95, 3.95); Calibrated: 28/07/2011
- Sensor-Surface: 2mm (Mechanical Surface Detection)
- Electronics: DAE4 Sn915; Calibrated: 26/07/2011
- Phantom: SAM2; Type: SAM; Serial: TP1562
- Measurement SW: DASY5, V5.2 Build 162; SEMCAD X Version 14.0 Build 59

Configuration/802.11n(40MHz) Channel46-Vertical Front/Area Scan (6x11x1): Measurement grid:

$dx=10\text{mm}$, $dy=10\text{mm}$

Maximum value of SAR (measured) = 0.275 mW/g

Configuration/802.11n(40MHz) Channel46-Vertical Front/Zoom Scan (7x7x9)/Cube 0: Measurement

grid: $dx=4\text{mm}$, $dy=4\text{mm}$, $dz=2.5\text{mm}$, Reference Value = 6.11 V/m; Power Drift = 0.107 dB

Peak SAR (extrapolated) = 0.853 W/kg

SAR(1 g) = 0.175 mW/g; SAR(10 g) = 0.051 mW/g Maximum value of SAR (measured) = 0.357 mW/g

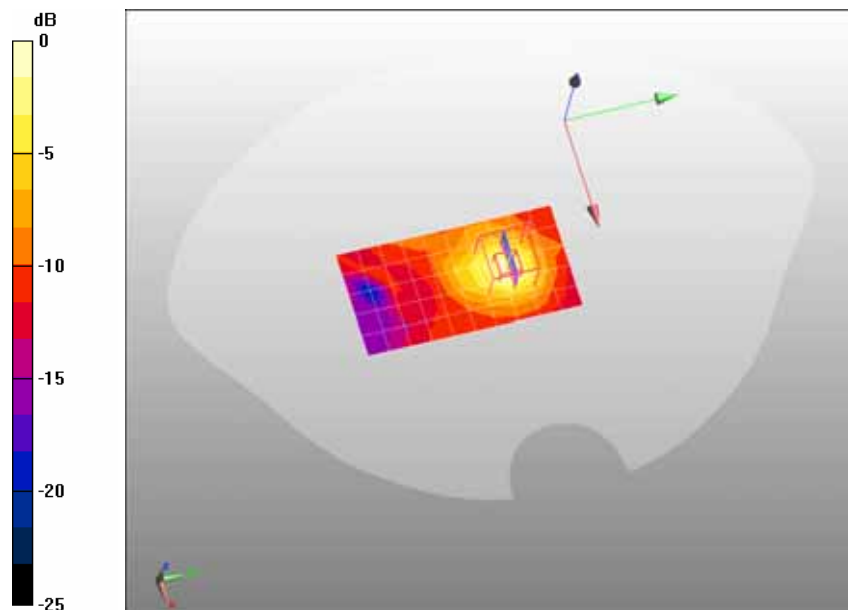

0 dB = 0.357mW/g

Date/Time: 30-01-2012

Test Laboratory: QuieTek Lab

802.11n(40MHz) 5755MHz-Vertical Front

DUT: 300 Mbps 802.11n Wireless USB Adapter; Type: Air 2411

Communication System: CW; Communication System Band: D5GHz (5000.0 - 6000.0 MHz); Duty Cycle: 1:1; Frequency: 5755 MHz; Medium parameters used: $f = 5755 \text{ MHz}$; $\sigma = 5.97 \text{ mho/m}$; $\epsilon_r = 46.4$; $\rho = 1000 \text{ kg/m}^3$; Phantom section: Flat Section

Ambient temperature (°C): 21.5, Liquid temperature (°C): 21.0

DASY5 Configuration:

- Probe: EX3DV4 - SN3698; ConvF(3.74, 3.74, 3.74); Calibrated: 28/07/2011
- Sensor-Surface: 2mm (Mechanical Surface Detection)
- Electronics: DAE4 Sn915; Calibrated: 26/07/2011
- Phantom: SAM2; Type: SAM; Serial: TP1562
- Measurement SW: DASY5, V5.2 Build 162; SEMCAD X Version 14.0 Build 59

Configuration/802.11n(40MHz) Channel151-Vertical Front/Area Scan (6x11x1): Measurement grid:

$dx=10\text{mm}$, $dy=10\text{mm}$

Maximum value of SAR (measured) = 0.338 mW/g

Configuration/802.11n(40MHz) Channel151-Vertical Front/Zoom Scan (7x7x9)/Cube 0: Measurement

grid: $dx=4\text{mm}$, $dy=4\text{mm}$, $dz=2.5\text{mm}$, Reference Value = 5.72 V/m; Power Drift = 0.115 dB

Peak SAR (extrapolated) = 1.75 W/kg

SAR(1 g) = 0.230 mW/g; SAR(10 g) = 0.087 mW/g Maximum value of SAR (measured) = 0.392 mW/g

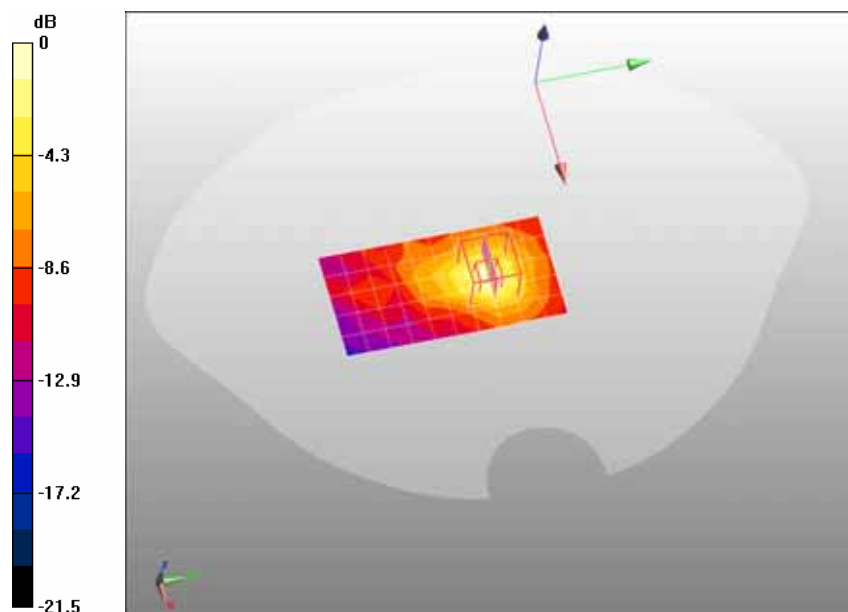

0 dB = 0.392mW/g

Date/Time: 30-01-2012

Test Laboratory: QuieTek Lab

802.11n(40MHz) 5795MHz-Vertical Front

DUT: 300 Mbps 802.11n Wireless USB Adapter; Type: Air 2411

Communication System: CW; Communication System Band: D5GHz (5000.0 - 6000.0 MHz); Duty Cycle: 1:1; Frequency: 5795 MHz; Medium parameters used: $f = 5795$ MHz; $\sigma = 6.01$ mho/m; $\epsilon_r = 46.3$; $\rho = 1000$ kg/m³; Phantom section: Flat Section

Ambient temperature (°C): 21.5, Liquid temperature (°C): 21.0

DASY5 Configuration:

- Probe: EX3DV4 - SN3698; ConvF(3.74, 3.74, 3.74); Calibrated: 28/07/2011
- Sensor-Surface: 2mm (Mechanical Surface Detection)
- Electronics: DAE4 Sn915; Calibrated: 26/07/2011
- Phantom: SAM2; Type: SAM; Serial: TP1562
- Measurement SW: DASY5, V5.2 Build 162; SEMCAD X Version 14.0 Build 59

Configuration/802.11n(40MHz) Channel159-Vertical Front/Area Scan (6x11x1): Measurement grid:

dx=10mm, dy=10mm

Maximum value of SAR (measured) = 0.325 mW/g

Configuration/802.11n(40MHz) Channel159-Vertical Front/Zoom Scan (7x7x9)/Cube 0: Measurement

grid: dx=4mm, dy=4mm, dz=2.5mm, Reference Value = 5.62 V/m; Power Drift = 0.056 dB

Peak SAR (extrapolated) = 0.755 W/kg

SAR(1 g) = 0.175 mW/g; SAR(10 g) = 0.054 mW/g Maximum value of SAR (measured) = 0.386 mW/g

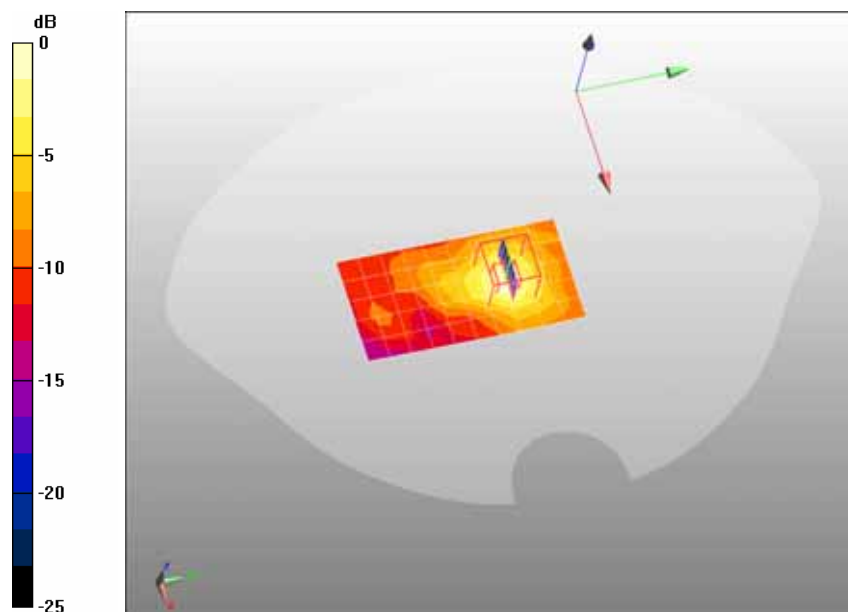

0 dB = 0.386mW/g

Appendix C. Test Setup Photographs & EUT Photographs

Test Setup Photographs



(Horizontal Up)



(Horizontal Down)



(Vertical Front)



(Vertical Back)



(Tip)

Depth of the liquid in the phantom – Zoom in

Note: The position used in the measurements were according to IEEE 1528 - 2003

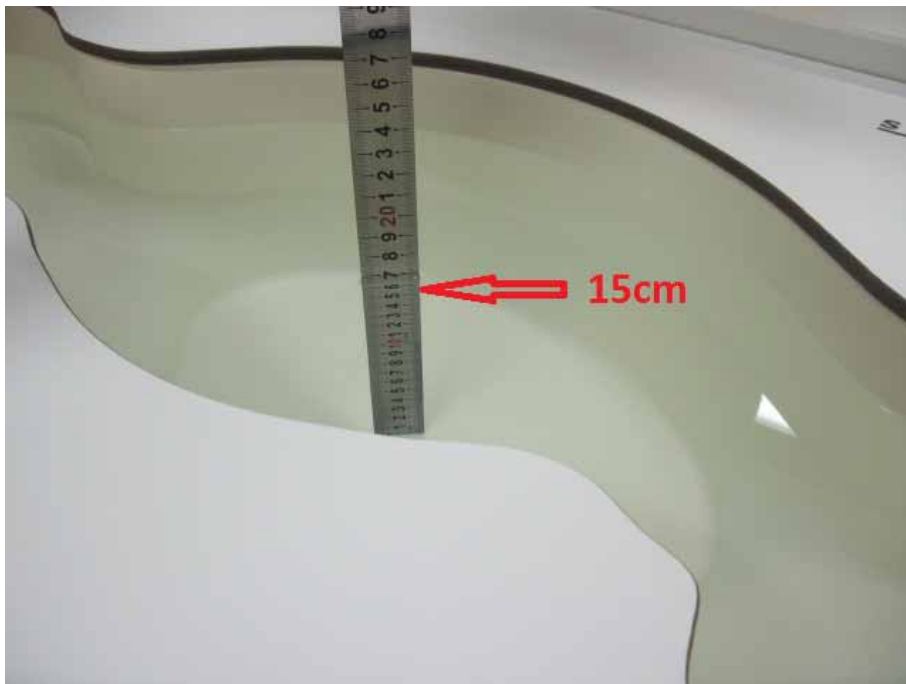

EUT Photographs

(1) EUT Photo

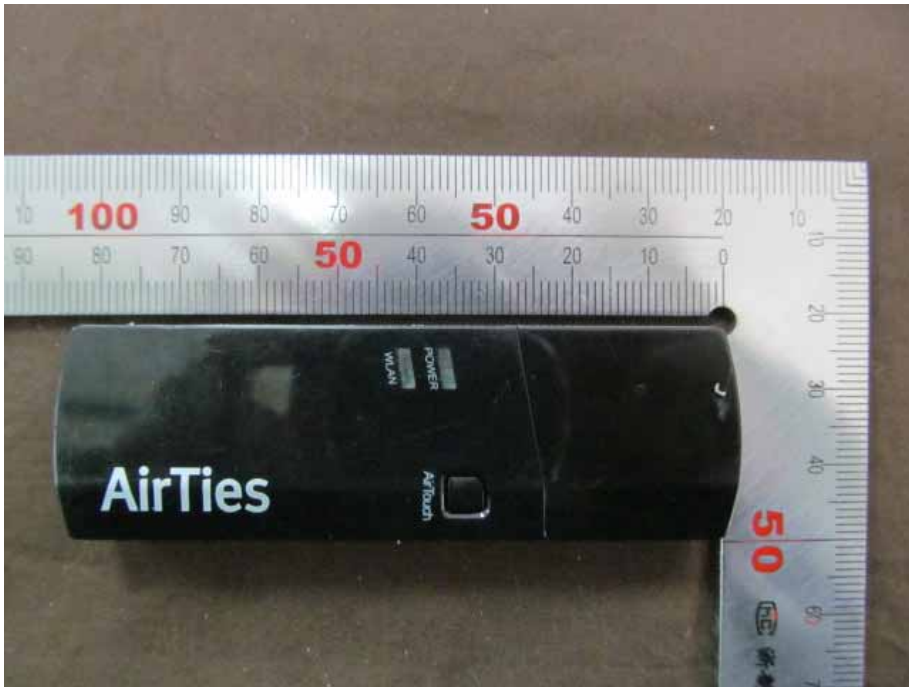

(2) EUT Photo



(3) EUT Photo



(4) EUT Photo



(5) EUT Photo

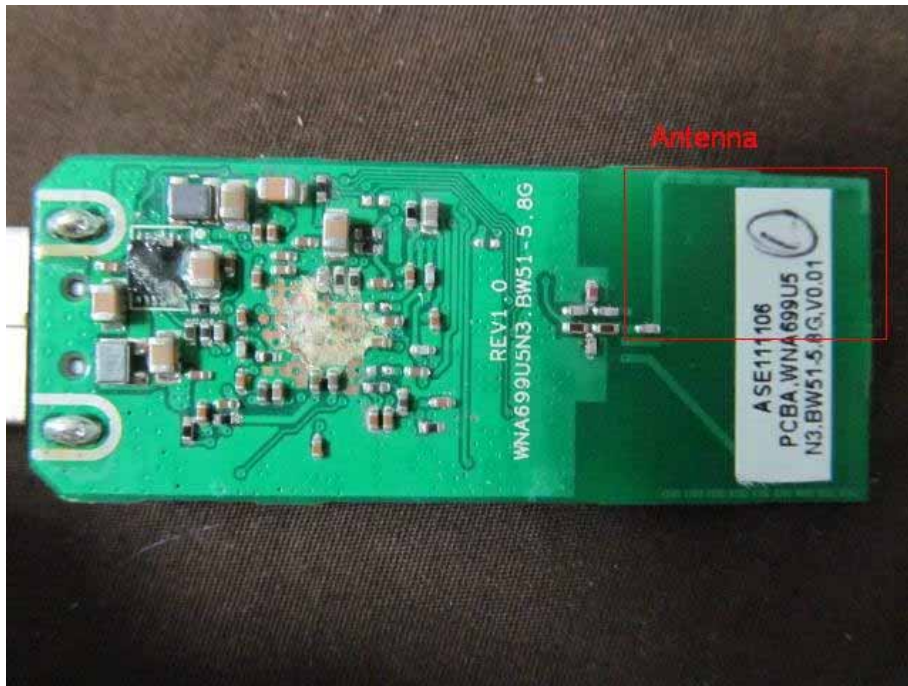

(6) EUT Photo

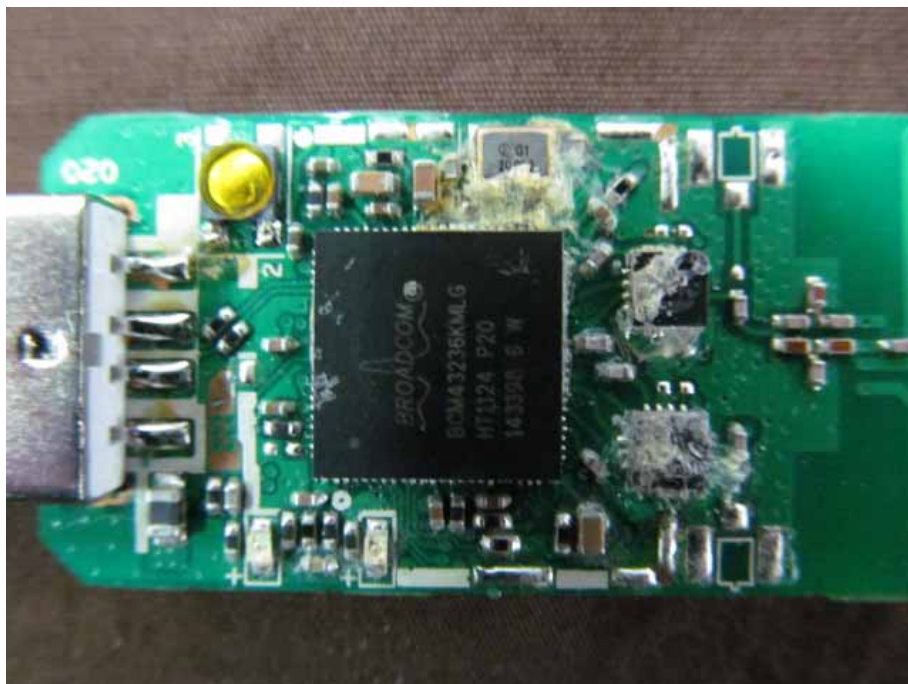

Appendix D. Probe Calibration Data

155

**Calibration Laboratory of
Schmid & Partner
Engineering AG**
Zeughausstrasse 43, 8004 Zurich, Switzerland



S Schweizerischer Kalibrierdienst
S Service suisse d'étalonnage
S Servizio svizzero di taratura
S Swiss Calibration Service

Accredited by the Swiss Accreditation Service (SAS)
The Swiss Accreditation Service is one of the signatories to the EA
Multilateral Agreement for the recognition of calibration certificates

Accreditation No.: **SCS 108**

Client **Quietek (Auden)**

Certificate No: **EX3-3698_Jul11**

CALIBRATION CERTIFICATE

Object: **EX3DV4 - SN:3698**

Calibration procedure(s): **QA CAL-01.v8, QA CAL-14.v3, QA CAL-23.v4, QA CAL-25.v4
Calibration procedure for dosimetric E-field probes**

Calibration date: **July 28, 2011**

This calibration certificate documents the traceability to national standards, which realize the physical units of measurements (SI).
The measurements and the uncertainties with confidence probability are given on the following pages and are part of the certificate.

All calibrations have been conducted in the closed laboratory facility: environment temperature (22 ± 3)°C and humidity < 70%.

Calibration Equipment used (M&TE critical for calibration)

Primary Standards	ID	Cal Date (Certificate No.)	Scheduled Calibration
Power meter E4419B	GB41293874	31-Mar-11 (No. 217-01372)	Apr-12
Power sensor E4412A	MY41498087	31-Mar-11 (No. 217-01372)	Apr-12
Reference 3 dB Attenuator	SN: S5054 (3c)	29-Mar-11 (No. 217-01369)	Apr-12
Reference 20 dB Attenuator	SN: S5086 (20b)	29-Mar-11 (No. 217-01367)	Apr-12
Reference 30 dB Attenuator	SN: S5129 (30b)	29-Mar-11 (No. 217-01370)	Apr-12
Reference Probe ES3DV2	SN: 3013	29-Dec-10 (No. ES3-3013_Dec10)	Dec-11
DAE4	SN: 654	3-May-11 (No. DAE4-654_May11)	May-12
Secondary Standards	ID	Check Date (in house)	Scheduled Check
RF generator HP 8648C	US3642U01700	4-Aug-99 (in house check Oct-09)	In house check: Oct-11
Network Analyzer HP 8753E	US37390585	18-Oct-01 (in house check Oct-10)	In house check: Oct-11

	Name	Function	Signature
Calibrated by:	Katja Pokovic	Technical Manager	
Approved by:	Niels Kuster	Quality Manager	

Issued: July 28, 2011

This calibration certificate shall not be reproduced except in full without written approval of the laboratory.

**Calibration Laboratory of
Schmid & Partner
Engineering AG**
Zeughausstrasse 43, 8004 Zurich, Switzerland



S Schweizerischer Kalibrierdienst
C Service suisse d'étalonnage
S Servizio svizzero di taratura
S Swiss Calibration Service

Accredited by the Swiss Accreditation Service (SAS)
The Swiss Accreditation Service is one of the signatories to the EA
Multilateral Agreement for the recognition of calibration certificates

Accreditation No.: **SCS 108**

Glossary:

TSL	tissue simulating liquid
NORM _{x,y,z}	sensitivity in free space
ConvF	sensitivity in TSL / NORM _{x,y,z}
DCP	diode compression point
CF	crest factor (1/duty_cycle) of the RF signal
A, B, C	modulation dependent linearization parameters
Polarization φ	φ rotation around probe axis
Polarization ϑ	ϑ rotation around an axis that is in the plane normal to probe axis (at measurement center), i.e., $\vartheta = 0$ is normal to probe axis

Calibration is Performed According to the Following Standards:

- a) IEEE Std 1528-2003, "IEEE Recommended Practice for Determining the Peak Spatial-Averaged Specific Absorption Rate (SAR) in the Human Head from Wireless Communications Devices: Measurement Techniques", December 2003
- b) IEC 62209-1, "Procedure to measure the Specific Absorption Rate (SAR) for hand-held devices used in close proximity to the ear (frequency range of 300 MHz to 3 GHz)", February 2005

Methods Applied and Interpretation of Parameters:

- **NORM_{x,y,z}**: Assessed for E-field polarization $\vartheta = 0$ ($f \leq 900$ MHz in TEM-cell; $f > 1800$ MHz: R22 waveguide). NORM_{x,y,z} are only intermediate values, i.e., the uncertainties of NORM_{x,y,z} does not affect the E²-field uncertainty inside TSL (see below ConvF).
- **NORM(f)_{x,y,z}** = NORM_{x,y,z} * frequency_response (see Frequency Response Chart). This linearization is implemented in DASY4 software versions later than 4.2. The uncertainty of the frequency response is included in the stated uncertainty of ConvF.
- **DCP_{x,y,z}**: DCP are numerical linearization parameters assessed based on the data of power sweep with CW signal (no uncertainty required). DCP does not depend on frequency nor media.
- **PAR**: PAR is the Peak to Average Ratio that is not calibrated but determined based on the signal characteristics
- **A_{x,y,z}; B_{x,y,z}; C_{x,y,z}; VR_{x,y,z}; A, B, C** are numerical linearization parameters assessed based on the data of power sweep for specific modulation signal. The parameters do not depend on frequency nor media. VR is the maximum calibration range expressed in RMS voltage across the diode.
- **ConvF and Boundary Effect Parameters**: Assessed in flat phantom using E-field (or Temperature Transfer Standard for $f \leq 800$ MHz) and inside waveguide using analytical field distributions based on power measurements for $f > 800$ MHz. The same setups are used for assessment of the parameters applied for boundary compensation (alpha, depth) of which typical uncertainty values are given. These parameters are used in DASY4 software to improve probe accuracy close to the boundary. The sensitivity in TSL corresponds to NORM_{x,y,z} * ConvF whereby the uncertainty corresponds to that given for ConvF. A frequency dependent ConvF is used in DASY version 4.4 and higher which allows extending the validity from ± 50 MHz to ± 100 MHz.
- **Spherical isotropy (3D deviation from isotropy)**: in a field of low gradients realized using a flat phantom exposed by a patch antenna.
- **Sensor Offset**: The sensor offset corresponds to the offset of virtual measurement center from the probe tip (on probe axis). No tolerance required.

EX3DV4 – SN:3698

July 28, 2011

Probe EX3DV4

SN:3698

Manufactured: April 22, 2009
Calibrated: July 28, 2011

Calibrated for DASY/EASY Systems
(Note: non-compatible with DASY2 system!)

EX3DV4- SN:3698

July 28, 2011

DASY/EASY - Parameters of Probe: EX3DV4 - SN:3698

Basic Calibration Parameters

	Sensor X	Sensor Y	Sensor Z	Unc (k=2)
Norm ($\mu\text{V}/(\text{V}/\text{m})^2$) ^A	0.51	0.44	0.45	± 10.1 %
DCP (mV) ^B	99.1	98.8	101.0	

Modulation Calibration Parameters

UID	Communication System Name	PAR		A dB	B dB	C dB	VR mV	Unc ^E (k=2)
10000	CW	0.00	X	0.00	0.00	1.00	115.2	±2.5 %
			Y	0.00	0.00	1.00	105.0	
			Z	0.00	0.00	1.00	108.1	

The reported uncertainty of measurement is stated as the standard uncertainty of measurement multiplied by the coverage factor k=2, which for a normal distribution corresponds to a coverage probability of approximately 95%.

^A The uncertainties of NormX,Y,Z do not affect the E²-field uncertainty inside TSL (see Pages 5 and 6).

^B Numerical linearization parameter: uncertainty not required.

^E Uncertainty is determined using the max. deviation from linear response applying rectangular distribution and is expressed for the square of the field value.

EX3DV4- SN:3698

July 28, 2011

DASY/EASY - Parameters of Probe: EX3DV4 - SN:3698

Calibration Parameter Determined in Head Tissue Simulating Media

f (MHz) ^C	Relative Permittivity ^F	Conductivity (S/m) ^F	ConvF X	ConvF Y	ConvF Z	Alpha	Depth (mm)	Unct. (k=2)
750	41.9	0.89	8.77	8.77	8.77	0.80	0.67	± 12.0 %
835	41.5	0.90	8.40	8.40	8.40	0.69	0.74	± 12.0 %
900	41.5	0.97	8.29	8.29	8.29	0.64	0.76	± 12.0 %
1750	40.1	1.37	7.38	7.38	7.38	0.80	0.60	± 12.0 %
1900	40.0	1.40	7.18	7.18	7.18	0.80	0.60	± 12.0 %
2450	39.2	1.80	6.51	6.51	6.51	0.80	0.61	± 12.0 %
2600	39.0	1.96	6.39	6.39	6.39	0.74	0.63	± 12.0 %
3500	37.9	2.91	6.41	6.41	6.41	0.20	1.60	± 13.1 %
5200	36.0	4.66	4.80	4.80	4.80	0.35	1.80	± 13.1 %
5300	35.9	4.76	4.58	4.58	4.58	0.35	1.80	± 13.1 %
5500	35.6	4.96	4.48	4.48	4.48	0.40	1.80	± 13.1 %
5600	35.5	5.07	4.16	4.16	4.16	0.45	1.80	± 13.1 %
5800	35.3	5.27	4.22	4.22	4.22	0.45	1.80	± 13.1 %

^C Frequency validity of ± 100 MHz only applies for DASY v4.4 and higher (see Page 2), else it is restricted to ± 50 MHz. The uncertainty is the RSS of the ConvF uncertainty at calibration frequency and the uncertainty for the indicated frequency band.

^F At frequencies below 3 GHz, the validity of tissue parameters (ϵ and σ) can be relaxed to ± 10% if liquid compensation formula is applied to measured SAR values. At frequencies above 3 GHz, the validity of tissue parameters (ϵ and σ) is restricted to ± 5%. The uncertainty is the RSS of the ConvF uncertainty for indicated target tissue parameters.

EX3DV4- SN:3698

July 28, 2011

DASY/EASY - Parameters of Probe: EX3DV4- SN:3698

Calibration Parameter Determined in Body Tissue Simulating Media

f (MHz) ^C	Relative Permittivity ^F	Conductivity (S/m) ^F	ConvF X	ConvF Y	ConvF Z	Alpha	Depth (mm)	Unct. (k=2)
750	55.5	0.96	8.56	8.56	8.56	0.80	0.71	± 12.0 %
835	55.2	0.97	8.59	8.59	8.59	0.80	0.68	± 12.0 %
900	55.0	1.05	8.31	8.31	8.31	0.74	0.75	± 12.0 %
1750	53.4	1.49	7.09	7.09	7.09	0.80	0.68	± 12.0 %
1900	53.3	1.52	6.74	6.74	6.74	0.80	0.65	± 12.0 %
2450	52.7	1.95	6.60	6.60	6.60	0.80	0.60	± 12.0 %
2600	52.5	2.16	6.40	6.40	6.40	0.80	0.50	± 12.0 %
3500	51.3	3.31	5.73	5.73	5.73	0.23	1.90	± 13.1 %
5200	49.0	5.30	3.95	3.95	3.95	0.55	1.90	± 13.1 %
5300	48.9	5.42	3.74	3.74	3.74	0.55	1.90	± 13.1 %
5500	48.6	5.65	3.68	3.68	3.68	0.50	1.90	± 13.1 %
5600	48.5	5.77	3.42	3.42	3.42	0.60	1.90	± 13.1 %
5800	48.2	6.00	3.74	3.74	3.74	0.60	1.90	± 13.1 %

^C Frequency validity of ± 100 MHz only applies for DASY v4.4 and higher (see Page 2), else it is restricted to ± 50 MHz. The uncertainty is the RSS of the ConvF uncertainty at calibration frequency and the uncertainty for the indicated frequency band.

^F At frequencies below 3 GHz, the validity of tissue parameters (ϵ and σ) can be relaxed to ± 10% if liquid compensation formula is applied to measured SAR values. At frequencies above 3 GHz, the validity of tissue parameters (ϵ and σ) is restricted to ± 5%. The uncertainty is the RSS of the ConvF uncertainty for indicated target tissue parameters.

EX3DV4- SN:3698

July 28, 2011

Frequency Response of E-Field (TEM-Cell:ifi110 EXX, Waveguide: R22)

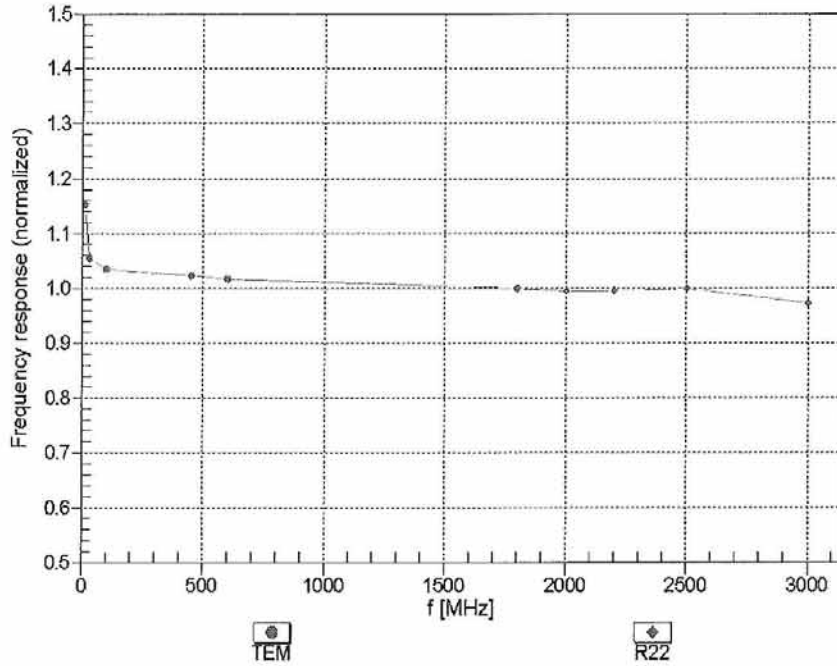

Uncertainty of Frequency Response of E-field: $\pm 6.3\%$ (k=2)

EX3DV4-- SN:3698

July 28, 2011

Receiving Pattern (ϕ), $\theta = 0^\circ$

f=600 MHz,TEM

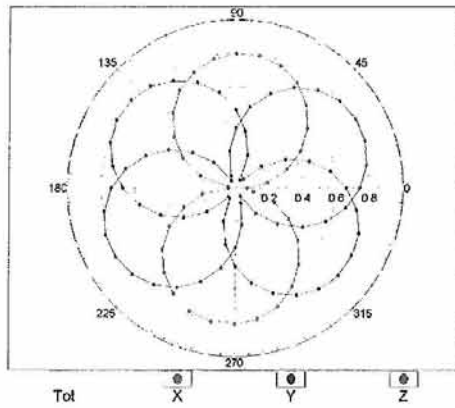

f=1800 MHz,R22

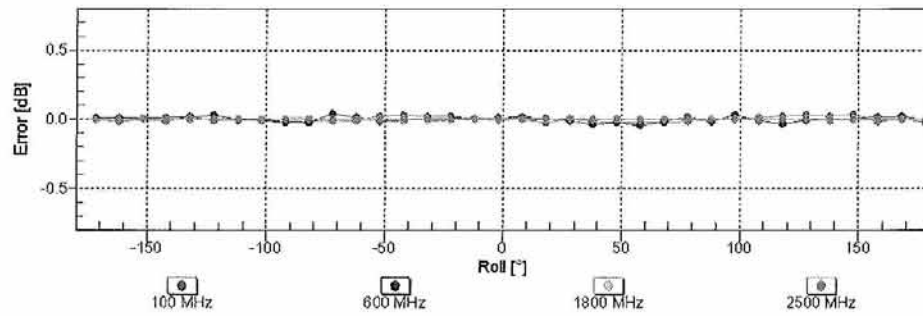
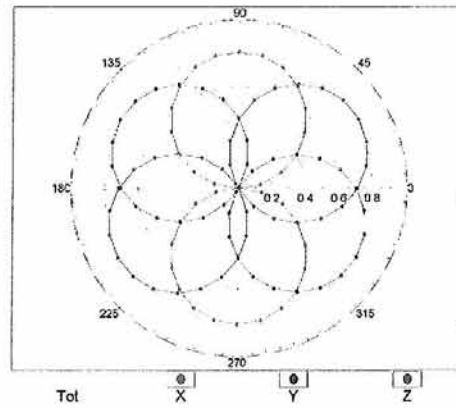

Uncertainty of Axial Isotropy Assessment: $\pm 0.5\%$ (k=2)

EX3DV4- SN:3698

July 28, 2011

Dynamic Range f(SAR_{head})
(TEM cell , f = 900 MHz)

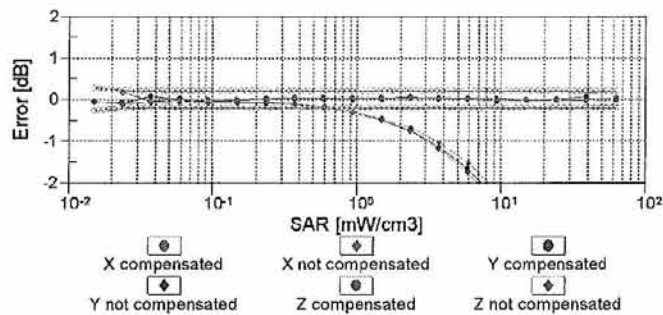
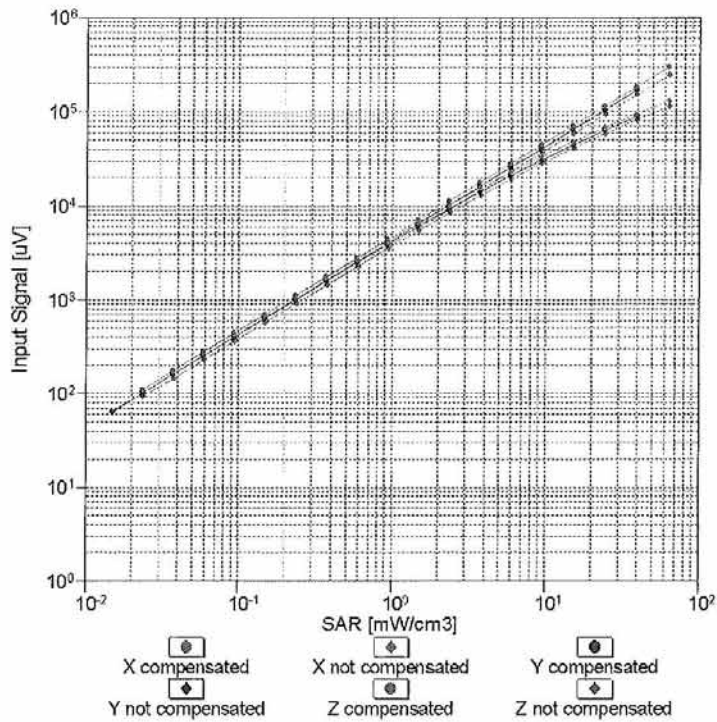

Uncertainty of Linearity Assessment: ± 0.6% (k=2)

EX3DV4- SN:3698

July 28, 2011

Conversion Factor Assessment

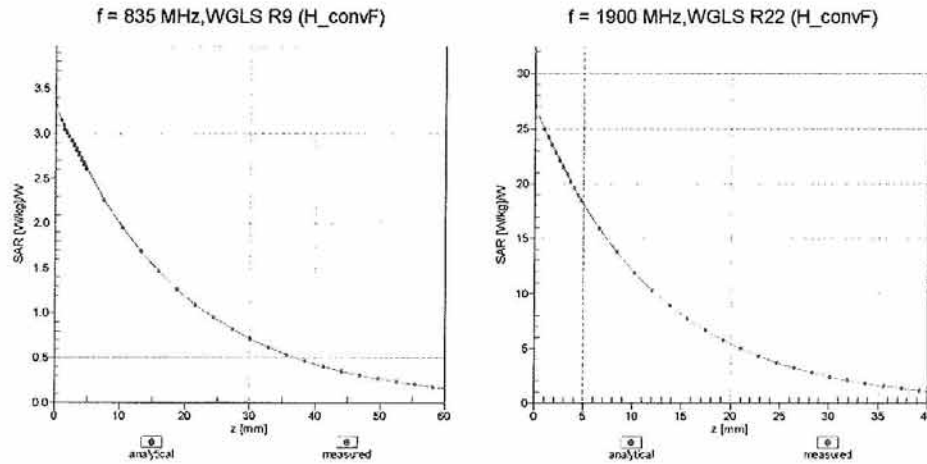

Deviation from Isotropy in Liquid

Error (ϕ, θ), f = 900 MHz

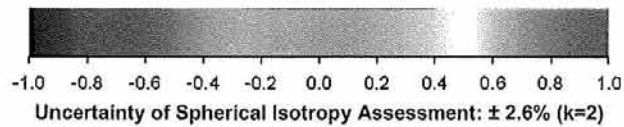
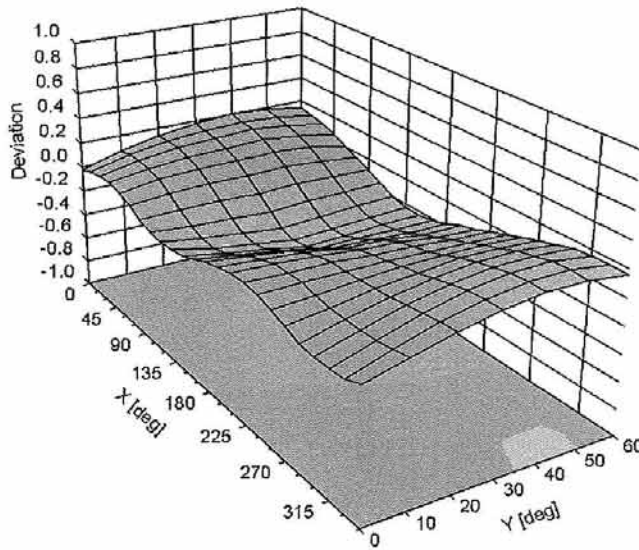

EX3DV4-- SN:3698

July 28, 2011

DASY/EASY - Parameters of Probe: EX3DV4 - SN:3698

Other Probe Parameters

Sensor Arrangement	Triangular
Connector Angle (°)	Not applicable
Mechanical Surface Detection Mode	enabled
Optical Surface Detection Mode	disabled
Probe Overall Length	337 mm
Probe Body Diameter	10 mm
Tip Length	9 mm
Tip Diameter	2.5 mm
Probe Tip to Sensor X Calibration Point	1 mm
Probe Tip to Sensor Y Calibration Point	1 mm
Probe Tip to Sensor Z Calibration Point	1 mm
Recommended Measurement Distance from Surface	2 mm

Appendix E. Dipole Calibration Data

**Calibration Laboratory of
Schmid & Partner
Engineering AG**
Zeughausstrasse 43, 8004 Zurich, Switzerland



S Schweizerischer Kalibrierdienst
S Service suisse d'étalonnage
C Servizio svizzero di taratura
S Swiss Calibration Service

Accredited by the Swiss Accreditation Service (SAS)
The Swiss Accreditation Service is one of the signatories to the EA
Multilateral Agreement for the recognition of calibration certificates

Accreditation No.: **SCS 108**

Client **Quietek (Auden)**

Certificate No: **D2450V2-839_Mar10**

CALIBRATION CERTIFICATE

Object **D2450V2 - SN: 839**

Calibration procedure(s) **QA CAL-05.v7
Calibration procedure for dipole validation kits**

Calibration date: **March 12, 2010**

This calibration certificate documents the traceability to national standards, which realize the physical units of measurements (SI).
The measurements and the uncertainties with confidence probability are given on the following pages and are part of the certificate.

All calibrations have been conducted in the closed laboratory facility: environment temperature (22 ± 3)°C and humidity < 70%.

Calibration Equipment used (M&TE critical for calibration)

Primary Standards	ID #	Cal Date (Certificate No.)	Scheduled Calibration
Power meter EPM-442A	GB37480704	06-Oct-09 (No. 217-01086)	Oct-10
Power sensor HP 8481A	US37292783	06-Oct-09 (No. 217-01086)	Oct-10
Reference 20 dB Attenuator	SN: 5086 (20g)	31-Mar-09 (No. 217-01025)	Mar-10
Type-N mismatch combination	SN: 5047.2 / 06327	31-Mar-09 (No. 217-01029)	Mar-10
Reference Probe ES3DV3	SN: 3205	26-Jun-09 (No. ES3-3205_Jun09)	Jun-10
DAE4	SN: 601	02-Mar-10 (No. DAE4-601_Mar10)	Mar-11
Secondary Standards	ID #	Check Date (in house)	Scheduled Check
Power sensor HP 8481A	MY41092317	18-Oct-02 (in house check Oct-09)	In house check: Oct-11
RF generator R&S SMT-06	100005	4-Aug-99 (in house check Oct-09)	In house check: Oct-11
Network Analyzer HP 8753E	US37390585 S4206	18-Oct-01 (in house check Oct-09)	In house check: Oct-10

Calibrated by:	Name Mike Meili	Function Laboratory Technician	Signature
Approved by:	Name Katja Pokovic	Function Technical Manager	Signature

Issued: March 18, 2010

This calibration certificate shall not be reproduced except in full without written approval of the laboratory.

**Calibration Laboratory of
Schmid & Partner
Engineering AG**
Zeughausstrasse 43, 8004 Zurich, Switzerland



S Schweizerischer Kalibrierdienst
C Service suisse d'étalonnage
S Servizio svizzero di taratura
S Swiss Calibration Service

Accredited by the Swiss Accreditation Service (SAS)
The Swiss Accreditation Service is one of the signatories to the EA
Multilateral Agreement for the recognition of calibration certificates

Accreditation No.: **SCS 108**

Glossary:

TSL	tissue simulating liquid
ConvF	sensitivity in TSL / NORM x,y,z
N/A	not applicable or not measured

Calibration is Performed According to the Following Standards:

- a) IEEE Std 1528-2003, "IEEE Recommended Practice for Determining the Peak Spatial-Averaged Specific Absorption Rate (SAR) in the Human Head from Wireless Communications Devices: Measurement Techniques", December 2003
- b) IEC 62209-1, "Procedure to measure the Specific Absorption Rate (SAR) for hand-held devices used in close proximity to the ear (frequency range of 300 MHz to 3 GHz)", February 2005
- c) Federal Communications Commission Office of Engineering & Technology (FCC OET), "Evaluating Compliance with FCC Guidelines for Human Exposure to Radiofrequency Electromagnetic Fields; Additional Information for Evaluating Compliance of Mobile and Portable Devices with FCC Limits for Human Exposure to Radiofrequency Emissions", Supplement C (Edition 01-01) to Bulletin 65

Additional Documentation:

- d) DAS4/5 System Handbook

Methods Applied and Interpretation of Parameters:

- *Measurement Conditions:* Further details are available from the Validation Report at the end of the certificate. All figures stated in the certificate are valid at the frequency indicated.
- *Antenna Parameters with TSL:* The dipole is mounted with the spacer to position its feed point exactly below the center marking of the flat phantom section, with the arms oriented parallel to the body axis.
- *Feed Point Impedance and Return Loss:* These parameters are measured with the dipole positioned under the liquid filled phantom. The impedance stated is transformed from the measurement at the SMA connector to the feed point. The Return Loss ensures low reflected power. No uncertainty required.
- *Electrical Delay:* One-way delay between the SMA connector and the antenna feed point. No uncertainty required.
- *SAR measured:* SAR measured at the stated antenna input power.
- *SAR normalized:* SAR as measured, normalized to an input power of 1 W at the antenna connector.
- *SAR for nominal TSL parameters:* The measured TSL parameters are used to calculate the nominal SAR result.

Measurement Conditions

DASY system configuration, as far as not given on page 1.

DASY Version	DASY5	V5.2
Extrapolation	Advanced Extrapolation	
Phantom	Modular Flat Phantom V4.9	
Distance Dipole Center - TSL	10 mm	with Spacer
Zoom Scan Resolution	dx, dy, dz = 5 mm	
Frequency	2450 MHz ± 1 MHz	

Head TSL parameters

The following parameters and calculations were applied.

	Temperature	Permittivity	Conductivity
Nominal Head TSL parameters	22.0 °C	39.2	1.80 mho/m
Measured Head TSL parameters	(22.0 ± 0.2) °C	40.4 ± 6 %	1.80 mho/m ± 6 %
Head TSL temperature during test	(21.0 ± 0.2) °C	----	----

SAR result with Head TSL

SAR averaged over 1 cm ³ (1 g) of Head TSL	Condition	
SAR measured	250 mW input power	13.0 mW / g
SAR normalized	normalized to 1W	52.0 mW / g
SAR for nominal Head TSL parameters	normalized to 1W	52.3 mW /g ± 17.0 % (k=2)

SAR averaged over 10 cm ³ (10 g) of Head TSL	condition	
SAR measured	250 mW input power	6.11 mW / g
SAR normalized	normalized to 1W	24.4 mW / g
SAR for nominal Head TSL parameters	normalized to 1W	24.5 mW /g ± 16.5 % (k=2)

Body TSL parameters

The following parameters and calculations were applied.

	Temperature	Permittivity	Conductivity
Nominal Body TSL parameters	22.0 °C	52.7	1.95 mho/m
Measured Body TSL parameters	(22.0 ± 0.2) °C	54.4 ± 6 %	2.00 mho/m ± 6 %
Body TSL temperature during test	(21.0 ± 0.2) °C	----	----

SAR result with Body TSL

SAR averaged over 1 cm ³ (1 g) of Body TSL	Condition	
SAR measured	250 mW input power	13.0 mW / g
SAR normalized	normalized to 1W	52.0 mW / g
SAR for nominal Body TSL parameters	normalized to 1W	51.6 mW / g ± 17.0 % (k=2)

SAR averaged over 10 cm ³ (10 g) of Body TSL	condition	
SAR measured	250 mW input power	6.06 mW / g
SAR normalized	normalized to 1W	24.2 mW / g
SAR for nominal Body TSL parameters	normalized to 1W	24.2 mW / g ± 16.5 % (k=2)

Appendix

Antenna Parameters with Head TSL

Impedance, transformed to feed point	53.5 Ω - 0.6 j Ω
Return Loss	- 29.4 dB

Antenna Parameters with Body TSL

Impedance, transformed to feed point	50.0 Ω + 0.9 j Ω
Return Loss	- 40.8 dB

General Antenna Parameters and Design

Electrical Delay (one direction)	1.134 ns
----------------------------------	----------

After long term use with 100W radiated power, only a slight warming of the dipole near the feedpoint can be measured.

The dipole is made of standard semirigid coaxial cable. The center conductor of the feeding line is directly connected to the second arm of the dipole. The antenna is therefore short-circuited for DC-signals.

No excessive force must be applied to the dipole arms, because they might bend or the soldered connections near the feedpoint may be damaged.

Additional EUT Data

Manufactured by	SPEAG
Manufactured on	July 20, 2009

DASY5 Validation Report for Head TSL

Date/Time: 12.03.2010 13:24:52

Test Laboratory: SPEAG, Zurich, Switzerland

DUT: Dipole 2450 MHz; Type: D2450V2; Serial: D2450V2 - SN:839

Communication System: CW; Frequency: 2450 MHz; Duty Cycle: 1:1

Medium: HSL U11 BB

Medium parameters used: $f = 2450$ MHz; $\sigma = 1.81$ mho/m; $\epsilon_r = 40.5$; $\rho = 1000$ kg/m³

Phantom section: Flat Section

Measurement Standard: DASY5 (IEEE/IEC/ANSI C63.19-2007)

DASY5 Configuration:

- Probe: ES3DV3 - SN3205; ConvF(4.53, 4.53, 4.53); Calibrated: 26.06.2009
- Sensor-Surface: 3mm (Mechanical Surface Detection)
- Electronics: DAE4 Sn601; Calibrated: 02.03.2010
- Phantom: Flat Phantom 5.0 (front); Type: QD000P50AA; Serial: 1001
- Measurement SW: DASY5, V5.2 Build 157; SEMCAD X Version 14.0 Build 57

Head/d=10mm, Pin=250 mW, dist=3.0mm (ES-Probe)/Zoom Scan (7x7x7) (7x7x7)/Cube 0:

Measurement grid: dx=5mm, dy=5mm, dz=5mm

Reference Value = 99.1 V/m; Power Drift = 0.060 dB

Peak SAR (extrapolated) = 26.5 W/kg

SAR(1 g) = 13 mW/g; SAR(10 g) = 6.11 mW/g

Maximum value of SAR (measured) = 16.5 mW/g

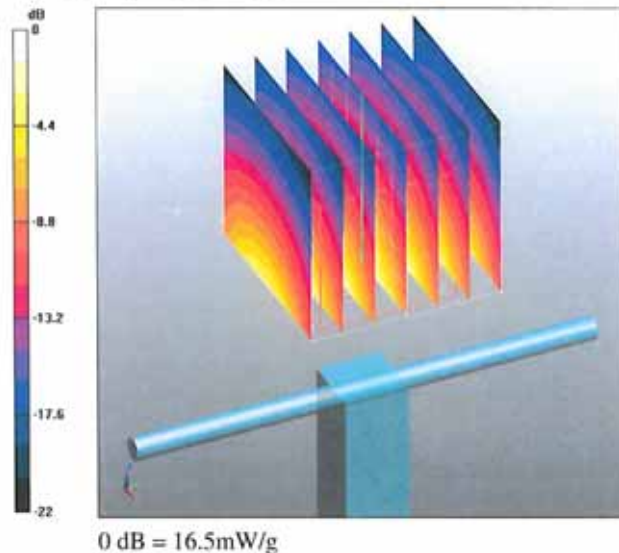

Impedance Measurement Plot for Head TSL

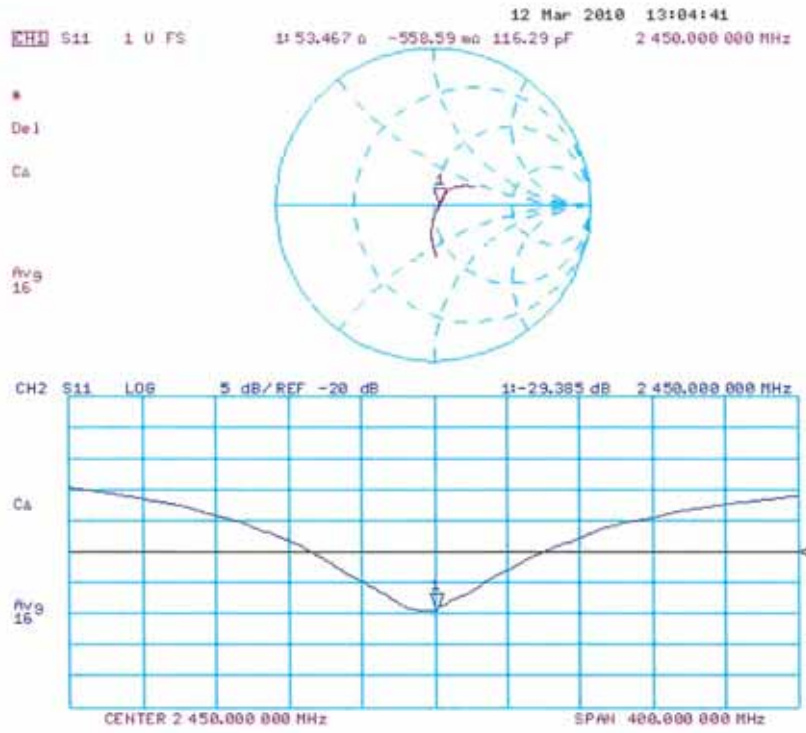

DASY5 Validation Report for Body

Date/Time: 12.03.2010 15:25:35

Test Laboratory: SPEAG, Zurich, Switzerland

DUT: Dipole 2450 MHz; Type: D2450V2; Serial: D2450V2 - SN:839

Communication System: CW; Frequency: 2450 MHz; Duty Cycle: 1:1

Medium: MSL U10 BB

Medium parameters used: $f = 2450$ MHz; $\sigma = 2.01$ mho/m; $\epsilon_r = 54.5$; $\rho = 1000$ kg/m³

Phantom section: Flat Section

Measurement Standard: DASY5 (IEEE/IEC/ANSI C63.19-2007)

DASY5 Configuration:

- Probe: ES3DV3 - SN3205; ConvF(4.31, 4.31, 4.31); Calibrated: 26.06.2009
- Sensor-Surface: 3mm (Mechanical Surface Detection)
- Electronics: DAE4 Sn601; Calibrated: 02.03.2010
- Phantom: Flat Phantom 5.0 (back); Type: QD000P50AA; Serial: 1002
- Measurement SW: DASY5, V5.2 Build 157; SEMCAD X Version 14.0 Build 57

Body/d=10mm, Pin250 mW, dist=3.0mm (ES-Probe)/Zoom Scan (7x7x7) (7x7x7)/Cube 0:

Measurement grid: dx=5mm, dy=5mm, dz=5mm

Reference Value = 94.9 V/m; Power Drift = -0.0047 dB

Peak SAR (extrapolated) = 27.1 W/kg

SAR(1 g) = 13 mW/g; SAR(10 g) = 6.06 mW/g

Maximum value of SAR (measured) = 17.2 mW/g

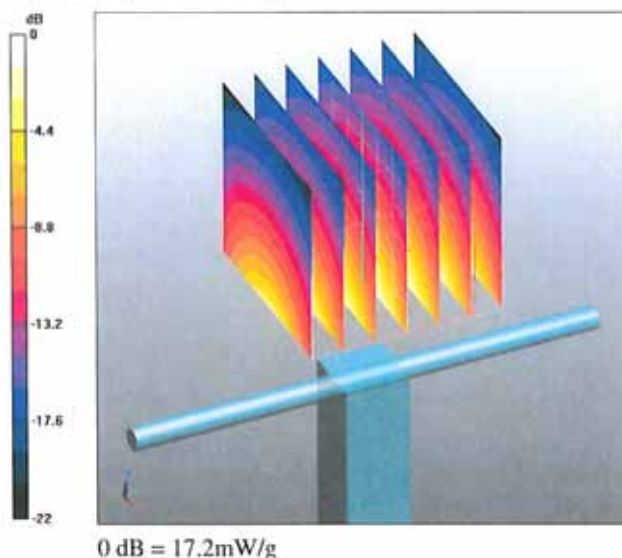

Impedance Measurement Plot for Body TSL

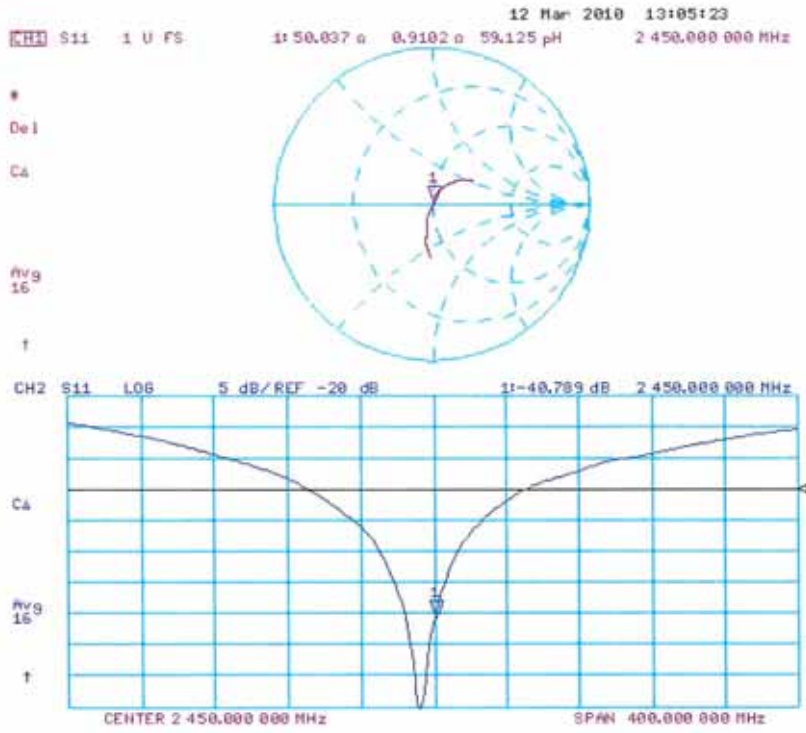

**Calibration Laboratory of
Schmid & Partner
Engineering AG**
Zeughausstrasse 43, 8004 Zurich, Switzerland



S Schweizerischer Kalibrierdienst
C Service suisse d'étalonnage
S Servizio svizzero di taratura
S Swiss Calibration Service

Accredited by the Swiss Accreditation Service (SAS)
The Swiss Accreditation Service is one of the signatories to the EA
Multilateral Agreement for the recognition of calibration certificates

Accreditation No.: **SCS 108**

Client **Quietek (Auden)**

Certificate No: **D5GHzV2-1078_Mar10**

CALIBRATION CERTIFICATE

Object **D5GHzV2 - SN: 1078**

Calibration procedure(s) **QA CAL-22.v1
Calibration procedure for dipole validation kits between 3-6 GHz**

Calibration date: **March 11, 2010**

This calibration certificate documents the traceability to national standards, which realize the physical units of measurements (SI).
The measurements and the uncertainties with confidence probability are given on the following pages and are part of the certificate.

All calibrations have been conducted in the closed laboratory facility: environment temperature (22 ± 3)°C and humidity < 70%.

Calibration Equipment used (M&TE critical for calibration)

Primary Standards	ID #	Cal Date (Certificate No.)	Scheduled Calibration
Power meter EPM-442A	GB37480704	06-Oct-09 (No. 217-01086)	Oct-10
Power sensor HP 8481A	US37292783	06-Oct-09 (No. 217-01086)	Oct-10
Reference 20 dB Attenuator	SN: 5086 (20g)	31-Mar-09 (No. 217-01025)	Mar-10
Type-N mismatch combination	SN: 5047.2 / 06327	31-Mar-09 (No. 217-01029)	Mar-10
Reference Probe EX3DV4	SN: 3503	05-Mar-10 (No. EX3-3503_Mar10)	Mar-11
DAE4	SN: 601	02-Mar-10 (No. DAE4-601_Mar10)	Mar-11
Secondary Standards	ID #	Check Date (in house)	Scheduled Check
Power sensor HP 8481A	MY41092317	18-Oct-02 (in house check Oct-09)	In house check: Oct-11
RF generator R&S SMT-06	100005	4-Aug-99 (in house check Oct-09)	In house check: Oct-11
Network Analyzer HP 8753E	US37390585 S4206	18-Oct-01 (in house check Oct-09)	In house check: Oct-10

Calibrated by:	Name Jeton Kastrati	Function Laboratory Technician	Signature 
Approved by:	Name Katja Pokovic	Technical Manager	

Issued: March 11, 2010

This calibration certificate shall not be reproduced except in full without written approval of the laboratory.

**Calibration Laboratory of
Schmid & Partner
Engineering AG**
Zeughausstrasse 43, 8004 Zurich, Switzerland



S Schweizerischer Kalibrierdienst
C Service suisse d'étalonnage
S Servizio svizzero di taratura
S Swiss Calibration Service

Accredited by the Swiss Accreditation Service (SAS)
The Swiss Accreditation Service is one of the signatories to the EA
Multilateral Agreement for the recognition of calibration certificates

Accreditation No.: **SCS 108**

Glossary:

TSL	tissue simulating liquid
ConvF	sensitivity in TSL / NORM x,y,z
N/A	not applicable or not measured

Calibration is Performed According to the Following Standards:

- a) IEC Std 62209 Part 2, "Evaluation of Human Exposure to Radio Frequency Fields from Handheld and Body-Mounted Wireless Communication Devices in the Frequency Range of 30 MHz to 6 GHz: Human models, Instrumentation, and Procedures"; Part 2: "Procedure to determine the Specific Absorption Rate (SAR) for including accessories and multiple transmitters", Draft Version 0.9, December 2004
- b) Federal Communications Commission Office of Engineering & Technology (FCC OET), "Evaluating Compliance with FCC Guidelines for Human Exposure to Radiofrequency Electromagnetic Fields; Additional Information for Evaluating Compliance of Mobile and Portable Devices with FCC Limits for Human Exposure to Radiofrequency Emissions", Supplement C (Edition 01-01) to Bulletin 65

Additional Documentation:

- c) DASY4/5 System Handbook

Methods Applied and Interpretation of Parameters:

- *Measurement Conditions:* Further details are available from the Validation Report at the end of the certificate. All figures stated in the certificate are valid at the frequency indicated.
- *Antenna Parameters with TSL:* The dipole is mounted with the spacer to position its feed point exactly below the center marking of the flat phantom section, with the arms oriented parallel to the body axis.
- *Feed Point Impedance and Return Loss:* These parameters are measured with the dipole positioned under the liquid filled phantom. The impedance stated is transformed from the measurement at the SMA connector to the feed point. The Return Loss ensures low reflected power. No uncertainty required.
- *Electrical Delay:* One-way delay between the SMA connector and the antenna feed point. No uncertainty required.
- *SAR measured:* SAR measured at the stated antenna input power.
- *SAR normalized:* SAR as measured, normalized to an input power of 1 W at the antenna connector.
- *SAR for nominal TSL parameters:* The measured TSL parameters are used to calculate the nominal SAR result.

Measurement Conditions

DASY system configuration, as far as not given on page 1.

DASY Version	DASY5	V5.2
Extrapolation	Advanced Extrapolation	
Phantom	Modular Flat Phantom V5.0	
Distance Dipole Center - TSL	10 mm	with Spacer
Area Scan resolution	dx, dy = 10 mm	
Zoom Scan Resolution	dx, dy = 4.0 mm, dz = 2.5 mm	
Frequency	5200 MHz ± 1 MHz 5500 MHz ± 1 MHz 5800 MHz ± 1 MHz	

Head TSL parameters at 5200 MHz

The following parameters and calculations were applied.

	Temperature	Permittivity	Conductivity
Nominal Head TSL parameters	22.0 °C	36.0	4.66 mho/m
Measured Head TSL parameters	(22.0 ± 0.2) °C	36.7 ± 6 %	4.56 mho/m ± 6 %
Head TSL temperature during test	(22.0 ± 0.2) °C	----	----

SAR result with Head TSL at 5200 MHz

SAR averaged over 1 cm ³ (1 g) of Head TSL	condition	
SAR measured	100 mW input power	8.17 mW / g
SAR normalized	normalized to 1W	81.7 mW / g
SAR for nominal Head TSL parameters	normalized to 1W	82.0 mW / g ± 19.9 % (k=2)

SAR averaged over 10 cm ³ (10 g) of Head TSL	condition	
SAR measured	100 mW input power	2.31 mW / g
SAR normalized	normalized to 1W	23.1 mW / g
SAR for nominal Head TSL parameters	normalized to 1W	23.1 mW / g ± 19.5 % (k=2)

Head TSL parameters at 5500 MHz

The following parameters and calculations were applied.

	Temperature	Permittivity	Conductivity
Nominal Head TSL parameters	22.0 °C	35.6	4.96 mho/m
Measured Head TSL parameters	(22.0 ± 0.2) °C	36.2 ± 6 %	4.82 mho/m ± 6 %
Head TSL temperature during test	(21.0 ± 0.2) °C	----	----

SAR result with Head TSL at 5500 MHz

SAR averaged over 1 cm ³ (1 g) of Head TSL	condition	
SAR measured	100 mW input power	8.73 mW / g
SAR normalized	normalized to 1W	87.3 mW / g
SAR for nominal Head TSL parameters	normalized to 1W	87.5 mW / g ± 19.9 % (k=2)

SAR averaged over 10 cm ³ (10 g) of Head TSL	condition	
SAR measured	100 mW input power	2.45 mW / g
SAR normalized	normalized to 1W	24.5 mW / g
SAR for nominal Head TSL parameters	normalized to 1W	24.5 mW / g ± 19.5 % (k=2)

Head TSL parameters at 5800 MHz

The following parameters and calculations were applied.

	Temperature	Permittivity	Conductivity
Nominal Head TSL parameters	22.0 °C	35.3	5.27 mho/m
Measured Head TSL parameters	(22.0 ± 0.2) °C	35.6 ± 6 %	5.08 mho/m ± 6 %
Head TSL temperature during test	(22.0 ± 0.2) °C	----	----

SAR result with Head TSL at 5800 MHz

SAR averaged over 1 cm ³ (1 g) of Head TSL	condition	
SAR measured	100 mW input power	8.09 mW / g
SAR normalized	normalized to 1W	80.9 mW / g
SAR for nominal Head TSL parameters	normalized to 1W	80.4 mW / g ± 19.9 % (k=2)

SAR averaged over 10 cm ³ (10 g) of Head TSL	condition	
SAR measured	100 mW input power	2.28 mW / g
SAR normalized	normalized to 1W	22.8 mW / g
SAR for nominal Head TSL parameters	normalized to 1W	22.7 mW / g ± 19.5 % (k=2)

Body TSL parameters at 5200 MHz

The following parameters and calculations were applied.

	Temperature	Permittivity	Conductivity
Nominal Body TSL parameters	22.0 °C	49.0	5.30 mho/m
Measured Body TSL parameters	(22.0 ± 0.2) °C	49.4 ± 6 %	5.44 mho/m ± 6 %
Body TSL temperature during test	(21.6 ± 0.2) °C	----	----

SAR result with Body TSL at 5200 MHz

SAR averaged over 1 cm ³ (1 g) of Body TSL	condition	
SAR measured	100 mW input power	7.78 mW / g
SAR normalized	normalized to 1W	77.8 mW / g
SAR for nominal Body TSL parameters	normalized to 1W	77.9 mW / g ± 19.9 % (k=2)

SAR averaged over 10 cm ³ (10 g) of Body TSL	condition	
SAR measured	100 mW input power	2.17 mW / g
SAR normalized	normalized to 1W	21.7 mW / g
SAR for nominal Body TSL parameters	normalized to 1W	21.8 mW / g ± 19.5 % (k=2)

Body TSL parameters at 5500 MHz

The following parameters and calculations were applied.

	Temperature	Permittivity	Conductivity
Nominal Body TSL parameters	22.0 °C	48.6	5.65 mho/m
Measured Body TSL parameters	(22.0 ± 0.2) °C	48.8 ± 6 %	5.81 mho/m ± 6 %
Body TSL temperature during test	(21.6 ± 0.2) °C	----	----

SAR result with Body TSL at 5500 MHz

SAR averaged over 1 cm ³ (1 g) of Body TSL	condition	
SAR measured	100 mW input power	8.35 mW / g
SAR normalized	normalized to 1W	83.5 mW / g
SAR for nominal Body TSL parameters	normalized to 1W	83.6 mW / g ± 19.9 % (k=2)

SAR averaged over 10 cm ³ (10 g) of Body TSL	condition	
SAR measured	100 mW input power	2.30 mW / g
SAR normalized	normalized to 1W	23.0 mW / g
SAR for nominal Body TSL parameters	normalized to 1W	23.0 mW / g ± 19.5 % (k=2)

Body TSL parameters at 5800 MHz

The following parameters and calculations were applied.

	Temperature	Permittivity	Conductivity
Nominal Body TSL parameters	22.0 °C	48.2	6.00 mho/m
Measured Body TSL parameters	(22.0 ± 0.2) °C	48.2 ± 6 %	6.18 mho/m ± 6 %
Body TSL temperature during test	(21.6 ± 0.2) °C	----	----

SAR result with Body TSL at 5800 MHz

SAR averaged over 1 cm ³ (1 g) of Body TSL	condition	
SAR measured	100 mW input power	7.33 mW / g
SAR normalized	normalized to 1W	73.3 mW / g
SAR for nominal Body TSL parameters	normalized to 1W	73.3 mW / g ± 19.9 % (k=2)

SAR averaged over 10 cm ³ (10 g) of Body TSL	condition	
SAR measured	100 mW input power	2.02 mW / g
SAR normalized	normalized to 1W	20.2 mW / g
SAR for nominal Body TSL parameters	normalized to 1W	20.2 mW / g ± 19.5 % (k=2)

Appendix

Antenna Parameters with Head TSL at 5200 MHz

Impedance, transformed to feed point	53.4 Ω - 8.7 j Ω
Return Loss	-20.9 dB

Antenna Parameters with Head TSL at 5500 MHz

Impedance, transformed to feed point	52.8 Ω - 6.1 j Ω
Return Loss	-23.7 dB

Antenna Parameters with Head TSL at 5800 MHz

Impedance, transformed to feed point	54.6 Ω - 3.8 j Ω
Return Loss	-24.9 dB

Antenna Parameters with Body TSL at 5200 MHz

Impedance, transformed to feed point	53.6 Ω - 8.7 j Ω
Return Loss	-20.8 dB

Antenna Parameters with Body TSL at 5500 MHz

Impedance, transformed to feed point	51.7 Ω - 5.2 j Ω
Return Loss	-25.4 dB

Antenna Parameters with Body TSL at 5800 MHz

Impedance, transformed to feed point	55.6 Ω - 1.4 j Ω
Return Loss	-25.2 dB

General Antenna Parameters and Design

Electrical Delay (one direction)	1.201 ns
----------------------------------	----------

After long term use with 40 W radiated power, only a slight warming of the dipole near the feedpoint can be measured.

The dipole is made of standard semirigid coaxial cable. The center conductor of the feeding line is directly connected to the second arm of the dipole. The antenna is therefore short-circuited for DC-signals.

No excessive force must be applied to the dipole arms, because they might bend or the soldered connections near the feedpoint may be damaged.

Additional EUT Data

Manufactured by	SPEAG
Manufactured on	September 26, 2008

DASY5 Validation Report for Head TSL

Date/Time: 10.03.2010 17:25:49

Test Laboratory: SPEAG, Zurich, Switzerland

DUT: Dipole 5GHz; Type: D5GHzV2; Serial: D5GHzV2 - SN:1078

Communication System: CW; Frequency: 5200 MHz, Frequency: 5500 MHz, Frequency: 5800 MHz; Duty Cycle: 1:1

Medium: HSL 5000

Medium parameters used: $f = 5200$ MHz; $\sigma = 4.56$ mho/m; $\epsilon_r = 36.7$; $\rho = 1000$ kg/m³, Medium parameters used: $f = 5500$ MHz; $\sigma = 4.82$ mho/m; $\epsilon_r = 36.1$; $\rho = 1000$ kg/m³, Medium parameters used: $f = 5800$ MHz; $\sigma = 5.08$ mho/m; $\epsilon_r = 35.6$; $\rho = 1000$ kg/m³

Phantom section: Flat Section

Measurement Standard: DASY5 (IEEE/IEC/ANSI C63.19-2007)

DASY5 Configuration:

- Probe: EX3DV4 - SN3503; ConvF(5.36, 5.36, 5.36), ConvF(4.85, 4.85, 4.85), ConvF(4.74, 4.74, 4.74); Calibrated: 05.03.2010
- Sensor-Surface: 2mm (Mechanical Surface Detection)
- Electronics: DAE4 Sn601; Calibrated: 02.03.2010
- Phantom: Flat Phantom 5.0 (front); Type: QD000P50AA; Serial: 1001
- Measurement SW: DASY5, V5.2 Build 157; SEMCAD X Version 14.0 Build 57

D5GHzV2 Dipole (Head)/d=10mm, Pin=100mW, f=5200 MHz/Zoom Scan (4x4x2.5mm), dist=2mm (8x8x10)/Cube 0: Measurement grid: dx=4mm, dy=4mm, dz=2.5mm
 Reference Value = 64.8 V/m; Power Drift = 0.079 dB
 Peak SAR (extrapolated) = 30.9 W/kg
SAR(1 g) = 8.17 mW/g; SAR(10 g) = 2.31 mW/g
 Maximum value of SAR (measured) = 15.7 mW/g

D5GHzV2 Dipole (Head)/d=10mm, Pin=100mW, f=5500 MHz/Zoom Scan (4x4x2.5mm), dist=2mm (8x8x10)/Cube 0: Measurement grid: dx=4mm, dy=4mm, dz=2.5mm
 Reference Value = 65.4 V/m; Power Drift = 0.074 dB
 Peak SAR (extrapolated) = 35 W/kg
SAR(1 g) = 8.73 mW/g; SAR(10 g) = 2.45 mW/g
 Maximum value of SAR (measured) = 17.1 mW/g

D5GHzV2 Dipole (Head)/d=10mm, Pin=100mW, f=5800 MHz/Zoom Scan (4x4x2.5mm), dist=2mm (8x8x10)/Cube 0: Measurement grid: dx=4mm, dy=4mm, dz=2.5mm
 Reference Value = 62.3 V/m; Power Drift = 0.099 dB
 Peak SAR (extrapolated) = 33.5 W/kg
SAR(1 g) = 8.09 mW/g; SAR(10 g) = 2.28 mW/g
 Maximum value of SAR (measured) = 16 mW/g

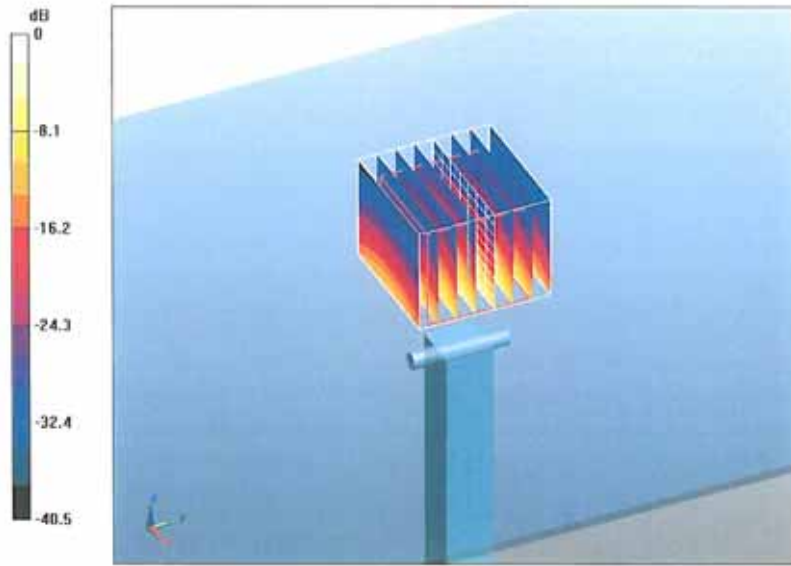

0 dB = 16mW/g

Impedance Measurement Plot for Head TSL

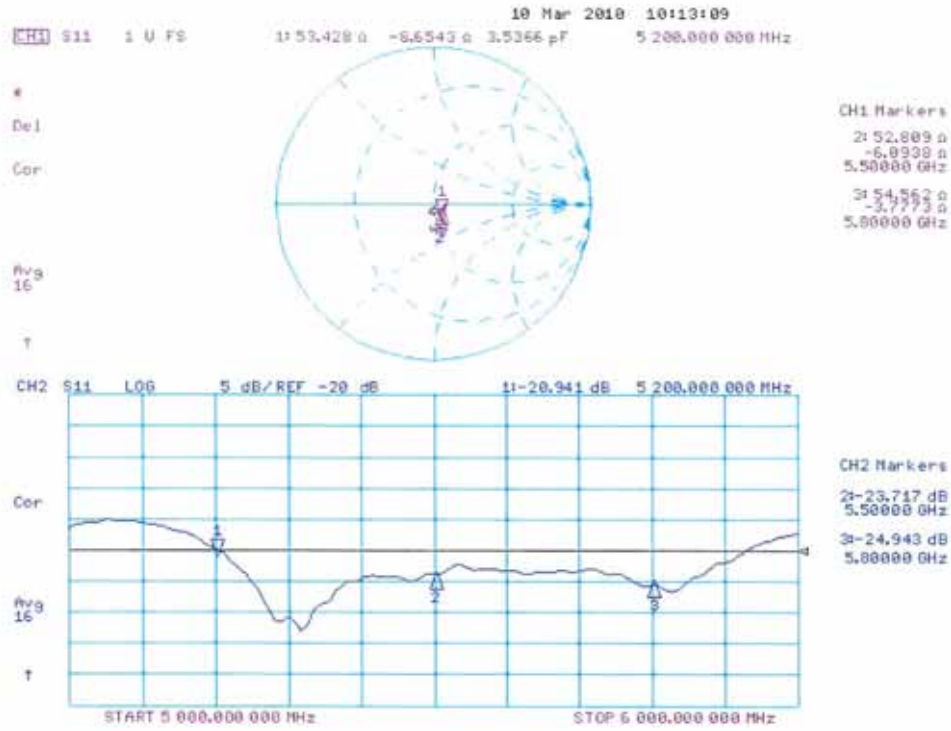

DASY5 Validation Report for Body TSL

Date/Time: 11.03.2010 14:40:41

Test Laboratory: SPEAG, Zurich, Switzerland

DUT: Dipole 5GHz; Type: D5GHzV2; Serial: D5GHzV2 - SN:1078

Communication System: CW; Frequency: 5200 MHz, Frequency: 5500 MHz, Frequency: 5800 MHz; Duty Cycle: 1:1

Medium: MSL 5000 MHz

Medium parameters used: $f = 5200$ MHz; $\sigma = 5.47$ mho/m; $\epsilon_r = 49.4$; $\rho = 1000$ kg/m³, Medium parameters used: $f = 5500$ MHz; $\sigma = 5.84$ mho/m; $\epsilon_r = 48.7$; $\rho = 1000$ kg/m³, Medium parameters used: $f = 5800$ MHz; $\sigma = 6.21$ mho/m; $\epsilon_r = 48.1$; $\rho = 1000$ kg/m³

Phantom section: Flat Section

Measurement Standard: DASY5 (IEEE/IEC/ANSI C63.19-2007)

DASY5 Configuration:

- Probe: EX3DV4 - SN3503; ConvF(4.88, 4.88, 4.88), ConvF(4.37, 4.37, 4.37), ConvF(4.57, 4.57, 4.57); Calibrated: 05.03.2010
- Sensor-Surface: 2mm (Mechanical Surface Detection)
- Electronics: DAE4 Sn601; Calibrated: 02.03.2010
- Phantom: Flat Phantom 5.0 (back); Type: QD000P50AA; Serial: 1002
- Measurement SW: DASY5, V5.2 Build 157; SEMCAD X Version 14.0 Build 57

D5GHzV2 Dipole (Body)/d=10mm, Pin=100mW, f=5200 MHz/Zoom Scan (4x4x2.5mm), dist=2mm (8x8x10)/Cube 0: Measurement grid: dx=4mm, dy=4mm, dz=2.5mm
 Reference Value = 59.5 V/m; Power Drift = 0.000976 dB
 Peak SAR (extrapolated) = 29.6 W/kg
SAR(1 g) = 7.78 mW/g; SAR(10 g) = 2.17 mW/g
 Maximum value of SAR (measured) = 15 mW/g

D5GHzV2 Dipole (Body)/d=10mm, Pin=100mW, f=5500 MHz/Zoom Scan (4x4x2.5mm), dist=2mm (8x8x10)/Cube 0: Measurement grid: dx=4mm, dy=4mm, dz=2.5mm
 Reference Value = 60.4 V/m; Power Drift = 0.013 dB
 Peak SAR (extrapolated) = 34 W/kg
SAR(1 g) = 8.35 mW/g; SAR(10 g) = 2.3 mW/g
 Maximum value of SAR (measured) = 16.4 mW/g

D5GHzV2 Dipole (Body)/d=10mm, Pin=100mW, f=5800 MHz/Zoom Scan (4x4x2.5mm), dist=2mm (8x8x10)/Cube 0: Measurement grid: dx=4mm, dy=4mm, dz=2.5mm
 Reference Value = 55.3 V/m; Power Drift = 0.012 dB
 Peak SAR (extrapolated) = 31.4 W/kg
SAR(1 g) = 7.33 mW/g; SAR(10 g) = 2.02 mW/g
 Maximum value of SAR (measured) = 14.5 mW/g

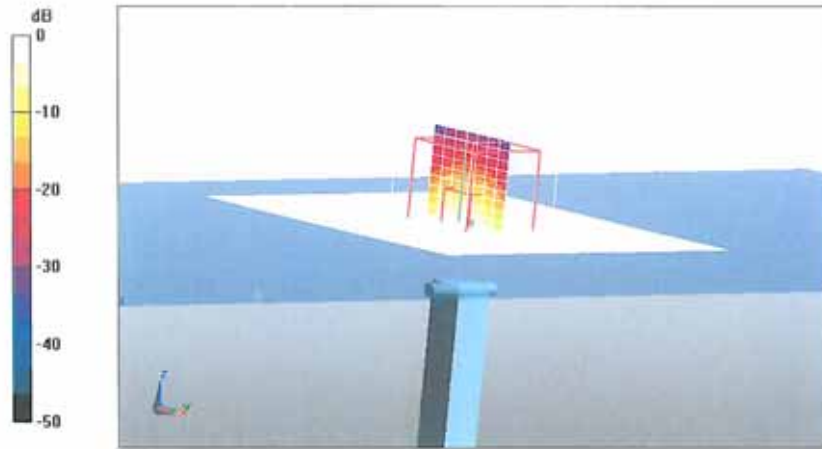

0 dB = 14.5mW/g

Impedance Measurement Plot for Body TSL

