

RF TEST REPORT

ISSUED BY
Shenzhen BALUN Technology Co., Ltd.



FOR
Punkt. MP 02 4G Feature phone

ISSUED TO
Punkt Tronics AG

Via Losanna 4, Lugano 6900, Switzerland



Tested by: Ye Hongji
Ye Hongji

Date: Oct. 09, 2021

Approved by: Liao Jianming

Liao Jianming
(Technical Director)

Date: Oct. 09, 2021

Report No.: BL-SZ2181089-601
EUT Name: Punkt. MP 02 4G Feature phone
Model Name: MP02A
Brand Name: Punkt.
Test Standard: 47 CFR Part 15 Subpart C
RSS-Gen Issue 5
RSS-247 Issue 2
(refer section 3.1)
FCC ID: Z3PMP02A
IC Number: 20683-MP02A
Test conclusion: Pass
Test Date: Sep. 02, 2021 ~ Sep. 18, 2021
Date of Issue: Oct. 09, 2021

NOTE: This test report of test results only related to testing samples, which can be duplicated completely for the legal use with the approval of the applicant; it shall not be reproduced except in full, without the written approval of Shenzhen BALUN Technology Co., Ltd. Any objections should be raised within thirty days from the date of issue. To validate the report, please contact us.

Revision History

<u>Version</u>	<u>Issue Date</u>	<u>Revisions Content</u>
<u>Rev. 01</u>	<u>Oct. 09, 2021</u>	<u>Initial Issue</u>

TABLE OF CONTENTS

1	ADMINISTRATIVE DATA (GENERAL INFORMATION)	5
1.1	Identification of the Testing Laboratory	5
1.2	Identification of the Responsible Testing Location	5
1.3	Laboratory Condition	5
1.4	Announce	5
2	PRODUCT INFORMATION	6
2.1	Applicant Information	6
2.2	Manufacturer Information	6
2.3	Factory Information	6
2.4	General Description for Equipment under Test (EUT)	6
2.5	Technical Information	7
2.6	Additional Instructions	9
3	SUMMARY OF TEST RESULTS	10
3.1	Test Standards	10
3.2	Verdict	11
4	GENERAL TEST CONFIGURATIONS	12
4.1	Test Environments	12
4.2	Test Equipment List	12
4.3	Measurement Uncertainty	12
4.4	Description of Test Setup	13
4.4.1	For Antenna Port Test	13
4.4.2	For AC Power Supply Port Test	13
4.4.3	For Radiated Test (Below 30 MHz)	14
4.4.4	For Radiated Test (30 MHz-1 GHz)	14
4.4.5	For Radiated Test (Above 1 GHz)	15
4.5	Measurement Results Explanation Example	16
4.5.1	For conducted test items:	16

5	TEST ITEMS.....	17
5.1	Antenna Requirements.....	17
5.1.1	Relevant Standards.....	17
5.1.2	Antenna Anti-Replacement Construction	17
5.1.3	Antenna Gain	17
5.2	Frequency Hopping Systems	18
5.2.1	Relevant Standards.....	18
5.2.2	Description of the systems	18
5.3	Number of Hopping Frequencies	20
5.3.1	Limit.....	20
5.3.2	Test Setup	20
5.3.3	Test Procedure.....	20
5.3.4	Test Result	20
5.4	Peak Output Power and E.I.R.P.....	21
5.4.1	Test Limit.....	21
5.4.2	Test Setup	21
5.4.3	Test Procedure.....	21
5.4.4	Test Result	21
5.5	Occupied Bandwidth	22
5.5.1	Limit.....	22
5.5.2	Test Setup	22
5.5.3	Test Procedure.....	22
5.5.4	Test Result	22
5.6	Carrier Frequency Separation	23
5.6.1	Limit.....	23
5.6.2	Test Setup	23
5.6.3	Test Procedure.....	23
5.6.4	Test Result	23
5.7	Time of Occupancy (Dwell time)	24
5.7.1	Limit.....	24
5.7.2	Test Setup	24
5.7.3	Test Procedure.....	24
5.7.4	Test Result	25

5.8	Conducted Spurious Emission & Authorized-band band-edge	26
5.8.1	Limit.....	26
5.8.2	Test Setup	26
5.8.3	Test Procedure	26
5.8.4	Test Result	26
5.9	Conducted Emission	27
5.9.1	Limit.....	27
5.9.2	Test Setup	27
5.9.3	Test Procedure	27
5.9.4	Test Result	27
5.10	Radiated Spurious Emission	28
5.10.1	Limit.....	28
5.10.2	Test Setup	28
5.10.3	Test Procedure	28
5.10.4	Test Result	29
5.11	Band Edge (Restricted-band band-edge).....	30
5.11.1	Limit.....	30
5.11.2	Test Setup	30
5.11.3	Test Procedure	30
5.11.4	Test Result	30
ANNEX A	TEST RESULT	31
A.1	Number of Hopping Frequency	31
A.2	Peak Output Power and E.I.R.P.....	32
A.3	20 dB and 99% bandwidth	35
A.4	Hopping Frequency Separation.....	40
A.5	Average Time of Occupancy	41
A.6	Conducted Spurious Emissions & Authorized-band band-edge	44
A.7	Conducted Emissions.....	51
A.8	Radiated Spurious Emission	53
A.9	Band Edge (Restricted-band band-edge).....	71
ANNEX B	TEST SETUP PHOTOS	79
ANNEX C	EUT EXTERNAL PHOTOS	79
ANNEX D	EUT INTERNAL PHOTOS	79

1 ADMINISTRATIVE DATA (GENERAL INFORMATION)

1.1 Identification of the Testing Laboratory

Company Name	Shenzhen BALUN Technology Co., Ltd.
Address	Block B, 1st FL, Baisha Science and Technology Park, Shahe Xi Road, Nanshan District, Shenzhen, Guangdong Province, P. R. China
Phone Number	+86 755 6685 0100

1.2 Identification of the Responsible Testing Location

Test Location	Shenzhen BALUN Technology Co., Ltd.
Address	Block B, 1st FL, Baisha Science and Technology Park, Shahe Xi Road, Nanshan District, Shenzhen, Guangdong Province, P. R. China
Accreditation Certificate	The laboratory has been listed by Industry Canada to perform electromagnetic emission measurements. The recognition numbers of test site are 11524A-1. The laboratory is a testing organization accredited by FCC as a accredited testing laboratory. The designation number is CN1196.
Description	All measurement facilities used to collect the measurement data are located at Block B, FL 1, Baisha Science and Technology Park, Shahe Xi Road, Nanshan District, Shenzhen, Guangdong Province, P. R. China 518055

1.3 Laboratory Condition

Ambient Temperature	20°C to 25°C
Ambient Relative Humidity	45% to 55%
Ambient Pressure	100 kPa to 102 kPa

1.4 Announce

- (1) The test report reference to the report template version v5.7.
- (2) The test report is invalid if not marked with the signatures of the persons responsible for preparing and approving the test report.
- (3) The test report is invalid if there is any evidence and/or falsification.
- (4) The results documented in this report apply only to the tested sample, under the conditions and modes of operation as described herein.
- (5) This document may not be altered or revised in any way unless done so by BALUN and all revisions are duly noted in the revisions section.
- (6) Content of the test report, in part or in full, cannot be used for publicity and/or promotional purposes without prior written approval from the laboratory.
- (7) The laboratory is only responsible for the data released by the laboratory, except for the part provided by the applicant.

2 PRODUCT INFORMATION

2.1 Applicant Information

Applicant	Punkt Tronics AG
Address	Via Losanna 4, Lugano 6900, Switzerland

2.2 Manufacturer Information

Manufacturer	Shenzhen Unicair Communication Technology Co., Ltd.
Address	8-9/F, Block1, Wutong Island, Shunchang Rd., Xixiang, Bao'an District, Shenzhen China.

2.3 Factory Information

Factory	Dongguan Unicair Communication Tech Co., Ltd
Address	No.49 Yinhu Road, Yinhu Industrial Zone, Qiaotou Town, Dongguan City, Guangdong Province, China

2.4 General Description for Equipment under Test (EUT)

EUT Name	Punkt. MP 02 4G Feature phone
Model Name Under Test	MP02A
Series Model Name	N/A
Description of Model name differentiation	N/A
Serial Number	N/A
Hardware Version	MP02_Main_Rev.B
Software Version	03.00.0301
Dimensions (Approx.)	117*51.3*14.3 mm
Weight (Approx.)	100g (with battery)

2.5 Technical Information

Network and Wireless connectivity	2G Network GSM/GPRS/EDGE 850/1900 MHz 3G Network WCDMA/HSDPA/HSUPA/DC-HSDPA Band 2/4/5 4G Network LTE FDD Band 2/4/5/7/12/17 Bluetooth (BR+EDR+BLE) 2.4G WIFI 802.11b, 802.11g, 802.11n(HT20/40) GPS, GLONASS, BDS
-----------------------------------	--

The requirement for the following technical information of the EUT was tested in this report:

Modulation Technology	FHSS
Modulation Type	GFSK, $\pi/4$ -DQPSK, 8-DPSK
Product Type	<input type="checkbox"/> Mobile <input checked="" type="checkbox"/> Portable <input type="checkbox"/> Fix Location
Transfer Rate	DH5: 1 Mbps 2DH5: 2 Mbps 3DH5: 3 Mbps
Frequency Range	The frequency range used is 2400 MHz to 2483.5 MHz.
Number of Channel	79 (at intervals of 1 MHz)
Tested Channel	0 (2402 MHz), 39 (2441 MHz), 78 (2480 MHz)
Antenna Type	PIFA Antenna
Antenna Gain	2.2 dBi (In test items related to antenna gain, the final results reflect this figure. This value is provided by the applicant.)
Antenna Impedance	50 Ω
Antenna System (MIMO Smart Antenna)	N/A

All channel was listed on the following table:

Channel number	Freq. (MHz)	Channel number	Freq. (MHz)	Channel number	Freq. (MHz)	Channel number	Freq. (MHz)
0	2402	21	2423	42	2444	63	2465
1	2403	22	2424	43	2445	64	2466
2	2404	23	2425	44	2446	65	2467
3	2405	24	2426	45	2447	66	2468
4	2406	25	2427	46	2448	67	2469
5	2407	26	2428	47	2449	68	2470
6	2408	27	2429	48	2450	69	2471
7	2409	28	2430	49	2451	70	2472
8	2410	29	2431	50	2452	71	2473
9	2411	30	2432	51	2453	72	2474
10	2412	31	2433	52	2454	73	2475
11	2413	32	2434	53	2455	74	2476
12	2414	33	2435	54	2456	75	2477
13	2415	34	2436	55	2457	76	2478
14	2416	35	2437	56	2458	77	2479
15	2417	36	2438	57	2459	78	2480
16	2418	37	2439	58	2460	-	-
17	2419	38	2440	59	2461	-	-
18	2420	39	2441	60	2462	-	-
19	2421	40	2442	61	2463	-	-
20	2422	41	2443	62	2464	-	-

2.6 Additional Instructions

EUT Software Settings:

Mode	<input checked="" type="checkbox"/> Special software is used. The software provided by client to enable the EUT under transmission condition continuously at specific channel frequencies individually.
------	--

During testing, Channel and Power Controlling Software provided by the customer was used to control the operating channel as well as the output power level. The RF output power selection is for the setting of RF output power expected by the customer and is going to be fixed on the firmware of the final end product.

Power level setup in software			
Test Software Version	QRCT3		
Support Units (Software installation media)	Description	Manufacturer	Model
		Notebook	Lenovo
Mode	Channel	Frequency (MHz)	Soft Set
DH5	CH0	2402	Power parameter Settings is 8
	CH39	2441	
	CH78	2480	
2DH5	CH0	2402	
	CH39	2441	
	CH78	2480	
3DH5	CH0	2402	
	CH39	2441	
	CH78	2480	

Run Software:

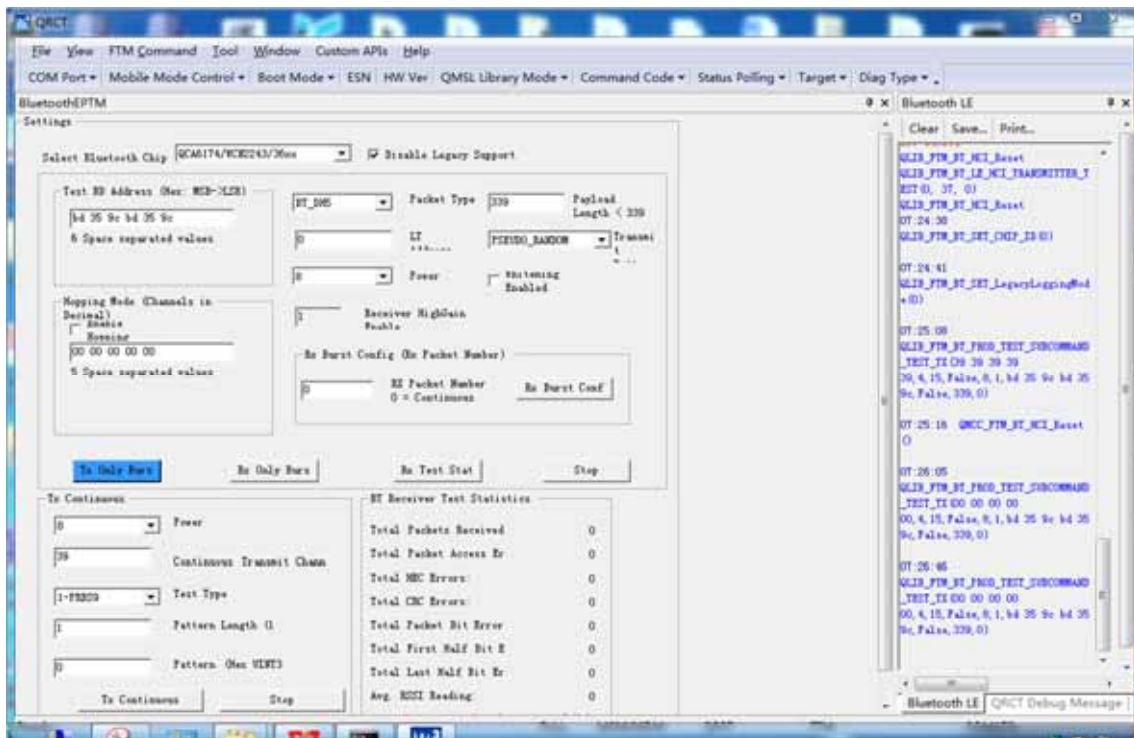

3 SUMMARY OF TEST RESULTS

3.1 Test Standards

No.	Identity	Document Title
1	47 CFR Part 15, Subpart C	Miscellaneous Wireless Communications Services
2	RSS-Gen Issue 5	General Requirements for Compliance of Radio Apparatus
3	RSS-247 Issue 2	Digital Transmission Systems (DTSS), Frequency Hopping Systems(FHSS) and Licence-Exemp Local Area Network (LE-LAN) Devices
4	ANSI C63.10-2013	American National Standard for Testing Unlicensed Wireless Devices
5	KDB 558074 D01 15.247 Meas Guidance v05r02	Guidance for compliance measurements on digital transmission system, frequency hopping spread spectrum system, and hybrid system devices operating under section 15.247 of the FCC rules

3.2 Verdict

No.	Description	FCC Part No.	ISED Part No.	Channel	Test Result	Verdict	Remark
1	Antenna Requirement	15.203	RSS-247, 5.4 (f)	N/A	--	Pass	Note ¹
2	Number of Hopping Frequencies	15.247(a)	RSS-247, 5.1 (d)	Hopping Mode	ANNEX A.1	Pass	Note ²
3	Peak Output Power and E.I.R.P	15.247(b)	RSS-247, 5.4 (b)	Low/Middle/High	ANNEX A.2	Pass	--
4	Occupied Bandwidth	15.247(a)	RSS-247, 5.1 (a)	Low/Middle/High	ANNEX A.3	Pass	Note ²
5	Carrier Frequency Separation	15.247(a)	RSS-247, 5.1 (b)	Hopping Mode	ANNEX A.4	Pass	Note ²
6	Time of Occupancy (Dwell time)	15.247(a)	RSS-247, 5.1 (d)	Hopping Mode	ANNEX A.5	Pass	Note ²
7	Conducted Spurious Emission & Authorized-band band-edge	15.247(d)	RSS-247, 5.5	Low/Middle/High	ANNEX A.6	Pass	Note ²
8	Conducted Emission	15.207	RSS-GEN, 8.8	Low/Middle/High	ANNEX A.7	Pass	Note ²
9	Radiated Spurious Emission	15.209 15.247(d)	RSS-247, 5.5	Hopping Mode, Low/Middle/High	ANNEX A.8	Pass	Note ²
10	Band Edge(Restricted-band band-edge)	15.209 15.247(d)	RSS-247, 5.5	Hopping Mode, Low/Middle/High	ANNEX A.9	Pass	Note ²
11	Receiver Spurious Emissions	--	RSS-Gen, 7.3	--	--	N/A	Note ³

Note ¹: Please refer to section 5.1

Note ²: $\pi/4$ -DQPSK is the EDR 2M rate mode, 8-DPSK is the EDR 3M rate mode. The consistency of test results in $\pi/4$ -DQPSK and 8-DPSK is very high. So we chose 8-DPSK as a typical representative to appear on the report. Another we will show all the modes on the RF output power test item.

Note ³: Only radio communication receivers operating in stand-alone mode within the band 30-960 MHz, as well as scanner receivers, are subject to Industry Canada requirements, so this test is not applicable.

4 GENERAL TEST CONFIGURATIONS

4.1 Test Environments

During the measurement, the normal environmental conditions were within the listed ranges:

Relative Humidity	45% to 55%	
Atmospheric Pressure	100 kPa to 102 kPa	
Temperature	NT (Normal Temperature)	+22°C to +25°C
Working Voltage of the EUT	NV (Normal Voltage)	3.8 V

4.2 Test Equipment List

Description	Manufacturer	Model	Serial No.	Cal. Date	Cal. Due
Spectrum Analyzer	ROHDE&SCHWARZ	FSV-40	101544	2021.04.01	2022.03.31
Bluetooth Signaling Unit	ROHDE&SCHWARZ	CMW500	142028	2021.06.01	2022.05.31
EMI Receiver	KEYSIGHT	N9038A	MY53220118	2021.06.01	2022.05.31
EMI Receiver	ROHDE&SCHWARZ	ESRP	101036	2021.06.01	2022.05.31
LISN	SCHWARZBECK	NSLK 8127	8127-687	2021.06.01	2022.05.31
Test Antenna-Loop(9 kHz-30 MHz)	SCHWARZBECK	FMZB 1519	1519-037	2019.10.29	2021.10.28
Test Antenna-Bi-Log(30 MHz-3 GHz)	SCHWARZBECK	VULB 9163	9163-624	2019.07.02	2022.07.01
Test Antenna-Horn(1-18 GHz)	SCHWARZBECK	BBHA 9120D	9120D-1917	2019.07.02	2022.07.01
Test Antenna-Horn (18-40 GHz)	A-INFO	LB-180400KF	J211060273	2021.01.05	2023.01.04
Anechoic Chamber	RAINFORD	9m*6m*6m	N/A	2017.02.21	2022.02.20
Anechoic Chamber	EMC Electronic Co., Ltd	20.10*11.60*7.35m	N/A	2019.08.08	2022.08.07
Shielded Enclosure	ChangNing	CN-130701	130703	--	--

4.3 Measurement Uncertainty

The following measurement uncertainty levels have been estimated for tests performed on the EUT as specified in CISPR 16-4-2.

This uncertainty represents an expanded uncertainty expressed at approximately the 95% confidence level using a coverage factor of k=2.

Parameters	Uncertainty
Occupied Channel Bandwidth	2.8%
RF output power, conducted	1.28 dB
Power Spectral Density, conducted	1.30 dB
Unwanted Emissions, conducted	1.84 dB
All emissions, radiated	5.36 dB
Temperature	0.82°C
Humidity	4.1%

4.4 Description of Test Setup

4.4.1 For Antenna Port Test

Conducted value (dBm) = Measurement value (dBm) + cable loss (dB)

For example: the measurement value is 10 dBm and the cable 0.5dBm used, then the final result of EUT:

Conducted value (dBm) = 10 dBm + 0.5 dB = 10.5 dBm

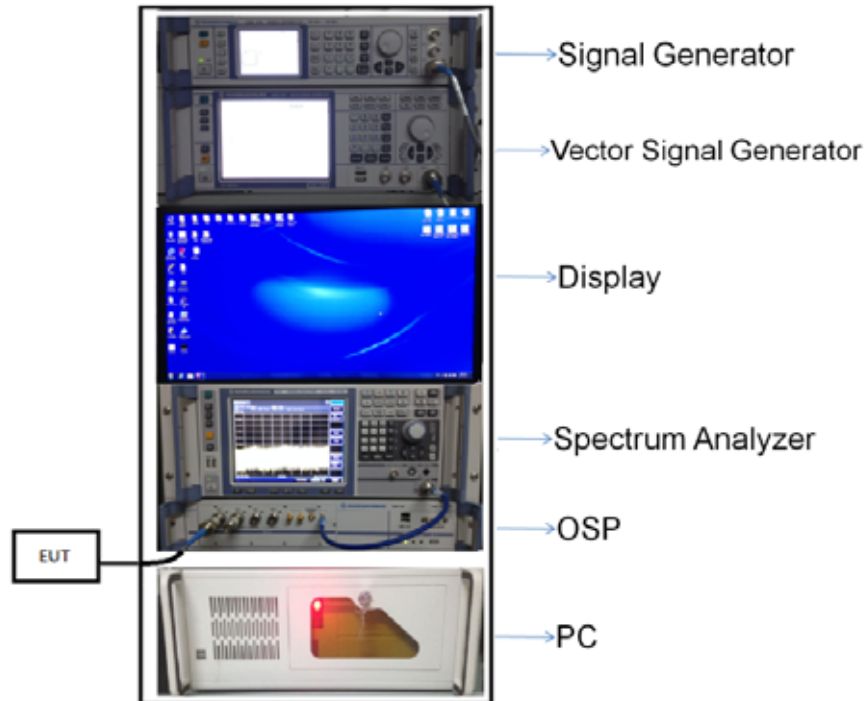

(Diagram 1)

4.4.2 For AC Power Supply Port Test

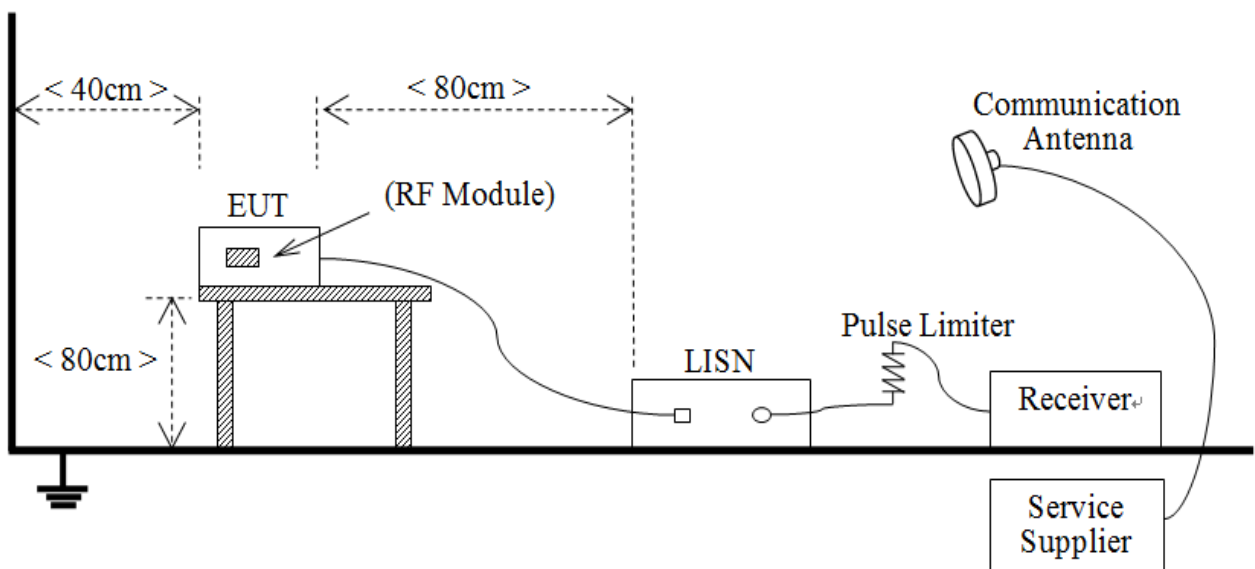

(Diagram 2)

4.4.3 For Radiated Test (Below 30 MHz)

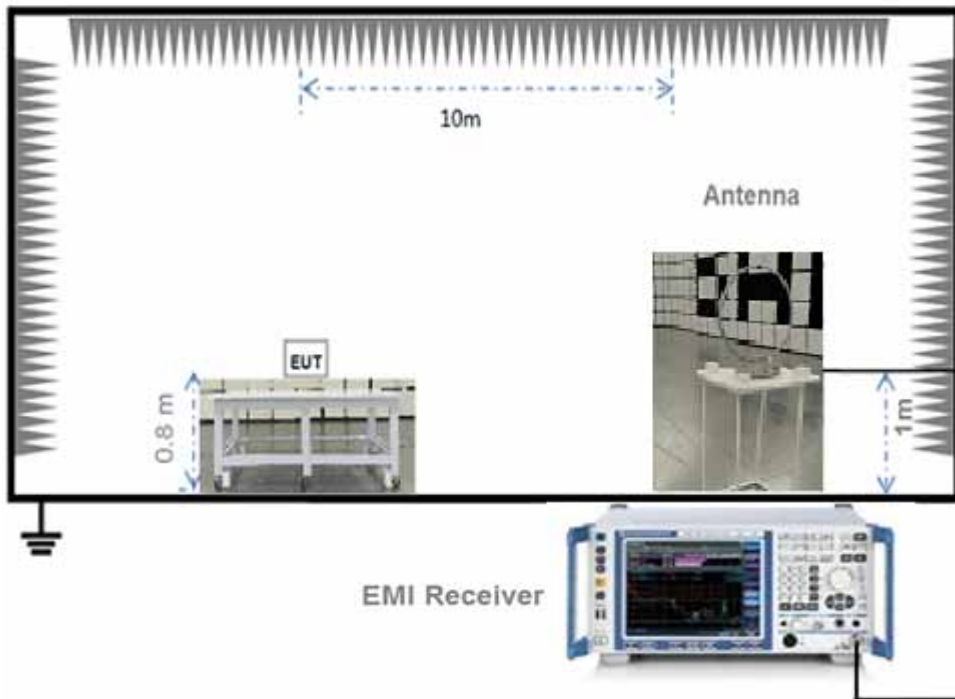

(Diagram 3)

4.4.4 For Radiated Test (30 MHz-1 GHz)

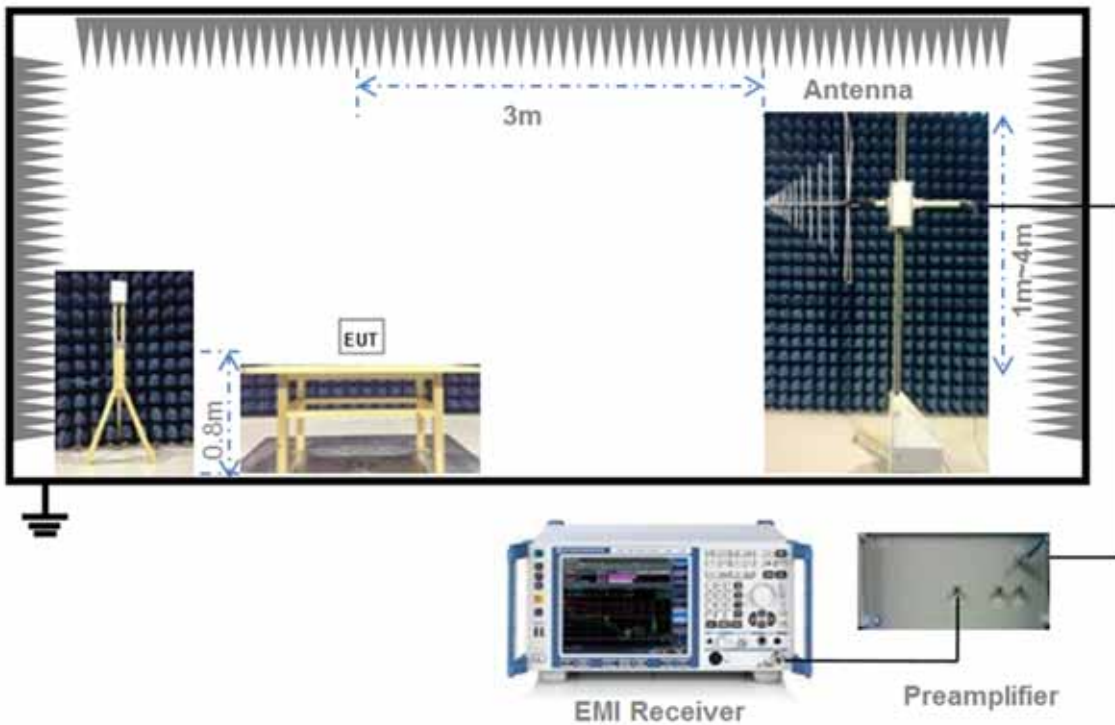

(Diagram 4)

4.4.5 For Radiated Test (Above 1 GHz)

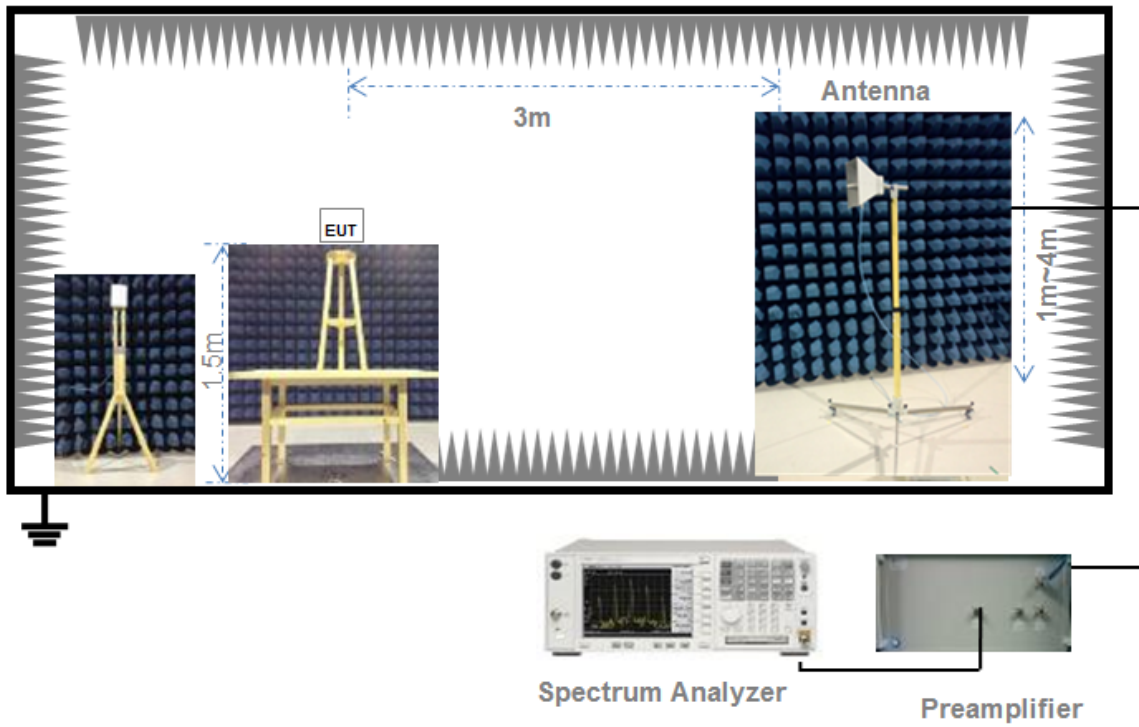

(Diagram 5)

4.5 Measurement Results Explanation Example

4.5.1 For conducted test items:

The offset level is set in the spectrum analyzer to compensate the RF cable loss and attenuator between EUT conducted output port and spectrum analyzer. With the offset compensation, the spectrum analyzer reading level is exactly the EUT RF output level.

The spectrum analyzer offset is derived from RF cable loss and attenuator factor.

Offset = RF cable loss + attenuator factor.

5 TEST ITEMS

5.1 Antenna Requirements

5.1.1 Relevant Standards

FCC §15.203 & 15.247(b); RSS-247, 5.4 (f)

An intentional radiator shall be designed to ensure that no antenna other than that furnished by the responsible party shall be used with the device. The use of a permanently attached antenna or of an antenna that uses a unique coupling to the intentional radiator shall be considered sufficient to comply with the provisions of this section. The manufacturer may design the unit so that a broken antenna can be replaced by the user, but the use of a standard antenna jack or electrical connector is prohibited. This requirement does not apply to carrier current devices or to devices operated under the provisions of § 15.211, § 15.213, § 15.217, § 15.219, or § 15.221. Further, this requirement does not apply to intentional radiators that must be professionally installed, such as perimeter protection systems and some field disturbance sensors, or to other intentional radiators which, in accordance with § 15.31(d), must be measured at the installation site. However, the installer shall be responsible for ensuring that the proper antenna is employed so that the limits in this part are not exceeded.

If directional gain of transmitting antennas is greater than 6 dBi, the power shall be reduced by the same level in dB comparing to gain minus 6 dBi. For the fixed point-to-point operation, the power shall be reduced by one dB for every 3 dB that the directional gain of the antenna exceeds 6 dBi. The use of a permanently attached antenna or of an antenna that uses a unique coupling to the intentional radiator shall be considered sufficient to comply with the FCC rule.

5.1.2 Antenna Anti-Replacement Construction

The Antenna Anti-Replacement as following method:

Protected Method	Description
The antenna is embedded in the product.	An embedded-in antenna design is used.

Reference Documents	Item
Photo	Please refer to the EUT Photo documents.

5.1.3 Antenna Gain

The antenna peak gain of EUT is less than 6 dBi. Therefore, it is not necessary to reduce maximum peak output power limit.

5.2 Frequency Hopping Systems

5.2.1 Relevant Standards

FCC §15.247(a) (1) (i) (ii) (iii) (iv); FCC §15.247(g); FCC §15.247(h)

Describe how the hopping sequence is generated. Provide an example of the hopping sequence channels, to demonstrate that the sequence meets the requirement specified in the definition of an FHSS system. Per the definition in Section 2.1(c), the hop set shall appear as random in the near term, shall appear as evenly distributed in the long term, and sequential hops shall be randomly distributed in both direction and magnitude of change.

Describe how each individual EUT meets the requirement that each of its hopping channels is used equally on average (e.g., that each new transmission event begins on the next channel in the hopping sequence after the final channel used in the previous transmission event).

Describe how the associated receiver(s) complies with the requirement that the input bandwidth (either RF or IF) matches the bandwidth of the transmitted signal.

Describe how the associated receiver(s) has the ability to shift frequencies in synchronization with the transmitted signals.

For short burst systems, describe how the EUT complies with the requirement that it be designed to be capable of operating as a true frequency hopping system. Specifically, the device shall comply with the equal frequency use and pseudorandom hopping sequence requirement when transmitting in short bursts, and shall be designed to comply when presented with continuous data (or information) stream.

Describe how the EUT complies with the requirement that it not have the ability to be coordinated with other FHSS systems in an effort to avoid the simultaneous occupancy of individual hopping frequencies by multiple transmitters.

5.2.2 Description of the systems

1. According to the preset procedure of the whole network, all the stations in the automatic control network synchronously change the frequency multiple times within one second, and temporarily stay on each frequency hopping channel. Periodic synchronization signaling is sent from the primary station, instructing all slaves to simultaneously change the operating frequency, then the hopping sequence is generated.
2. The hop set shall appear as random in the near term, shall appear as evenly distributed in the long term, and sequential hops shall be randomly distributed in both direction and magnitude of change.

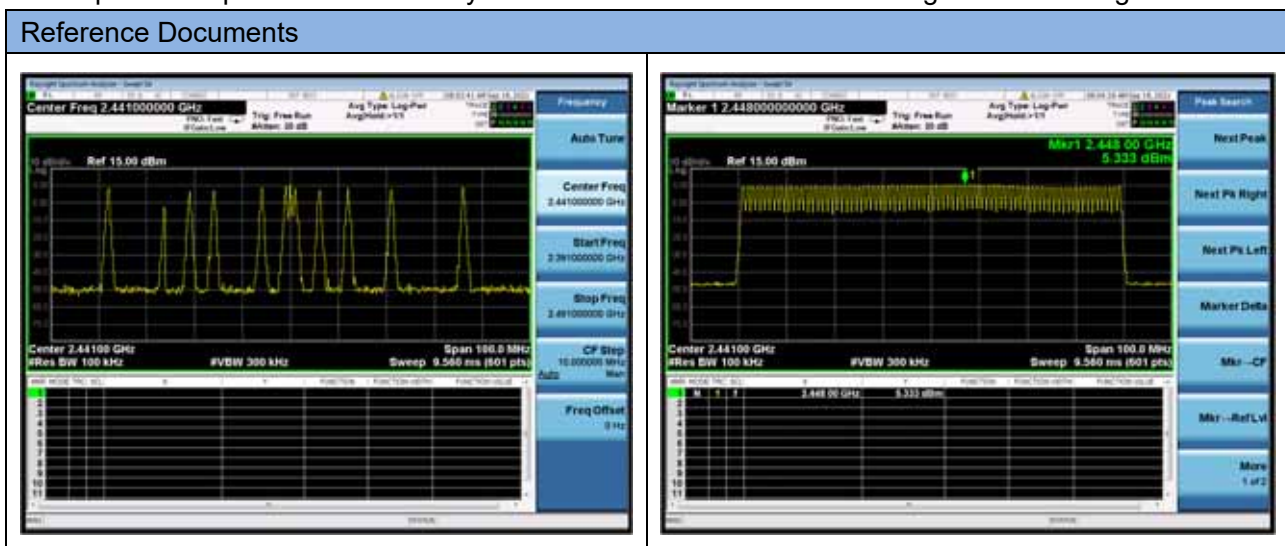

3. Channels are classified into two categories, used and unused, where used channels are part of the hopping sequence and unused channels are replaced in the hopping sequence by used channels in a pseudo-random way. Make each individual EUT meets the requirement that each of its hopping channels is used equally on average.
4. The input bandwidth and transmitted bandwidth are both 1MHz, the associated receiver(s) complies with the requirement that the input bandwidth matches the bandwidth of the transmitted signal.
5. Connected devices communicate on the same physical channel by synchronizing with a common clock and hopping sequence.
6. EUT isn't short burst systems.
7. EUT can't have the ability to be coordinated with other FHSS systems in an effort.

5.3 Number of Hopping Frequencies

5.3.1 Limit

FCC §15.247(a) (1) (iii); RSS-247, 5.1 (d)

Frequency hopping systems operating in the 2400 MHz to 2483.5 MHz bands shall use at least 15 hopping frequencies.

5.3.2 Test Setup

See section 4.4.1 for test setup description for the antenna port. The photo of test setup please refer to ANNEX B.

5.3.3 Test Procedure

The EUT must have its hopping function enabled. Use the following spectrum analyzer settings:

Span = The frequency band of operation

RBW = To identify clearly the individual channels, set the RBW to less than 30% of the channel spacing or the 20 dB bandwidth, whichever is smaller.

VBW \geq RBW

Sweep = auto

Detector function = peak

Trace = max hold

Allow the trace to stabilize

5.3.4 Test Result

Please refer to ANNEX A.1.

5.4 Peak Output Power and E.I.R.P

5.4.1 Test Limit

FCC § 15.247(b)

For frequency hopping systems operating in the 2400-2483.5 MHz band employing at least 75 non-overlapping hopping channels band: 1 watt. For all other frequency hopping systems in the 2400-2483.5 MHz band: 0.125 watts.

RSS-247, 5.4 (b)

For FHSs operating in the band 2400-2483.5 MHz, the maximum peak conducted output power shall not exceed 1.0 W and the e.i.r.p. shall not exceed 4 W if the hopset uses 75 or more hopping channels; the maximum peak conducted output power shall not exceed 0.125 W and the e.i.r.p. shall not exceed 0.5 W if the hopset uses less than 75 hopping channels (see Section 5.4(5) for exceptions).

5.4.2 Test Setup

See section 4.4.1 for test setup description for the antenna port. The photo of test setup please refer to ANNEX B.

5.4.3 Test Procedure

The Module operates at hopping-off test mode. The lowest, middle and highest channels are selected to perform testing to verify the conducted RF output peak power of the Module.

Use the following spectrum analyzer settings:

Span = approximately 5 times the 20 dB bandwidth, centered on a hopping channel

RBW > the 20 dB bandwidth of the emission being measured

VBW \geq RBW

Sweep = auto

Detector function = peak

Trace = max hold

Allow the trace to stabilize.

5.4.4 Test Result

Please refer to ANNEX A.2.

5.5 Occupied Bandwidth

5.5.1 Limit

FCC §15.247(a); RSS-247, 5.1 (a)

Measurement of the 20dB bandwidth of the modulated signal.

5.5.2 Test Setup

See section 4.4.1 for test setup description for the antenna port. The photo of test setup please refer to ANNEX B.

5.5.3 Test Procedure

Use the following spectrum analyzer settings:

Span = approximately 2 to 5 times the 20 dB bandwidth, centered on a hopping channel

RBW = in the range of 1% to 5% of the OBW

VBW \geq RBW

Sweep = auto

Detector function = peak

Trace = max hold

The EUT should be transmitting at its maximum data rate, Allow the trace to stabilize.

5.5.4 Test Result

Please refer to ANNEX A.3.

5.6 Carrier Frequency Separation

5.6.1 Limit

FCC §15.247(a); RSS-247, 5.1 (b)

Frequency hopping systems shall have hopping channel carrier frequencies separated by a minimum of 25 kHz or the 2/3 of the 20 dB bandwidth of the hopping channel, whichever is greater.

5.6.2 Test Setup

See section 4.4.1 for test setup description for the antenna port. The photo of test setup please refer to ANNEX B.

5.6.3 Test Procedure

The EUT must have its hopping function enabled. Use the following spectrum analyzer settings:

Span = wide enough to capture the peaks of two adjacent channels

Resolution (or IF) Bandwidth (RBW) \geq 1% of the span

Video (or Average) Bandwidth (VBW) \geq RBW

Sweep = auto

Detector function = peak

Trace = max hold

Allow the trace to stabilize. Use the marker-delta function to determine the separation between the peaks of the adjacent channels.

5.6.4 Test Result

Please refer to ANNEX A.4.

5.7 Time of Occupancy (Dwell time)

5.7.1 Limit

FCC §15.247(a); RSS-247, 5.1 (d)

Frequency hopping systems in the 2400 MHz - 2483.5 MHz band shall use at least 15 non-overlapping channels. The average time of occupancy on any channel shall not be greater than 0.4 seconds within a period of 0.4 seconds multiplied by the number of hopping channels employed. Frequency hopping systems may avoid or suppress transmissions on a particular hopping frequency provided that a minimum of 15 channels are used.

5.7.2 Test Setup

See section 4.4.1 for test setup description for the antenna port. The photo of test setup please refer to ANNEX B.

5.7.3 Test Procedure

The EUT shall have its hopping function enabled. Use the following spectrum analyzer settings:

Span: Zero span, centered on a hopping channel

RBW shall be channel spacing and where possible RBW should be set $\gg 1 / T$, where T is the expected dwell time per channel

Sweep: As necessary to capture the entire dwell time per hopping channel; where possible use a video trigger and trigger delay so that the transmitted signal starts a little to the right of the start of the plot. The trigger level might need slight adjustment to prevent triggering when the system hops on an adjacent channel; a second plot might be needed with a longer sweep time to show two successive hops on a channel

Detector function: Peak

Trace: Max hold

Use the marker-delta function to determine the transmit time per hop. If this value varies with different modes of operation (data rate, modulation format, number of hopping channels, etc.), then repeat this test for each variation in transmit time.

The average time of occupancy on any channel within the Period can be calculated with formulas:

For GFSK and 8-DPSK:

For DH1 package type

$$\begin{aligned}\{\text{Total of Dwell}\} &= \{\text{Pulse Time}\} * (1600 / 2) / \{\text{Number of Hopping Frequency}\} * \{\text{Period}\} \\ \{\text{Period}\} &= 0.4 \text{ s} * \{\text{Number of Hopping Frequency}\}\end{aligned}$$

For DH3 package type

$$\begin{aligned}\{\text{Total of Dwell}\} &= \{\text{Pulse Time}\} * (1600 / 4) / \{\text{Number of Hopping Frequency}\} * \{\text{Period}\} \\ \{\text{Period}\} &= 0.4 \text{ s} * \{\text{Number of Hopping Frequency}\}\end{aligned}$$

For DH5 package type

$$\begin{aligned}\{\text{Total of Dwell}\} &= \{\text{Pulse Time}\} * (1600 / 6) / \{\text{Number of Hopping Frequency}\} * \{\text{Period}\} \\ \{\text{Period}\} &= 0.4 \text{ s} * \{\text{Number of Hopping Frequency}\}\end{aligned}$$

For AFH Mode:

For DH1 package type

$$\begin{aligned}\{\text{Total of Dwell}\} &= \{\text{Pulse Time}\} * (800 / 2) / \{\text{Number of Hopping Frequency}\} * \{\text{Period}\} \\ \{\text{Period}\} &= 0.4 \text{ s} * \{\text{Number of Hopping Frequency}\}\end{aligned}$$

For DH3 package type

$$\begin{aligned}\{\text{Total of Dwell}\} &= \{\text{Pulse Time}\} * (800 / 4) / \{\text{Number of Hopping Frequency}\} * \{\text{Period}\} \\ \{\text{Period}\} &= 0.4 \text{ s} * \{\text{Number of Hopping Frequency}\}\end{aligned}$$

For DH5 package type

$$\{\text{Total of Dwell}\} = \{\text{Pulse Time}\} * (800 / 6) / \{\text{Number of Hopping Frequency}\} * \{\text{Period}\}$$

{Period} = 0.4 s * {Number of Hopping Frequency}

The lowest, middle and highest channels are selected to perform testing to record the dwell time of each occupation measured in this channel, which is called Pulse Time here.

5.7.4 Test Result

Please refer to ANNEX A.5.

5.8 Conducted Spurious Emission & Authorized-band band-edge

5.8.1 Limit

FCC §15.247(d); RSS-247, 5.5

In any 100 kHz bandwidth outside the frequency band in which the spread spectrum or digitally modulated intentional radiator is operating, the radio frequency power that is produced by the intentional radiator shall be at least 20 dB below that in the 100 kHz bandwidth within the band that contains the highest level of the desired power, based on either an RF conducted or a radiated measurement.

5.8.2 Test Setup

See section 4.4.1 for test setup description for the antenna port. The photo of test setup please refer to ANNEX B.

5.8.3 Test Procedure

Use the following spectrum analyzer settings:

Span = wide enough to capture the peak level of the in-band emission and all spurious emissions (e.g., harmonics) from the lowest frequency generated in the EUT up through the 10th harmonic. Typically, several plots are required to cover this entire span.

RBW = 100 kHz

VBW = 300 kHz

Sweep = auto

Detector function = peak

Trace = max hold

Allow the trace to stabilize

5.8.4 Test Result

Please refer to ANNEX A.6.

5.9 Conducted Emission

5.9.1 Limit

FCC §15.207; RSS-GEN, 8.8

For an intentional radiator that is designed to be connected to the public utility (AC) power line, the radio frequency voltage that is conducted back onto the AC power line on any frequency within the band 150 kHz to 30 MHz shall not exceed the limits in the following table, as measured using a 50 μ H/50 Ω line impedance stabilization network (LISN).

Frequency range (MHz)	Conducted Limit (dB μ V)	
	Quai-peak	Average
0.15 - 0.50	66 to 56	56 to 46
0.50 - 5	56	46
0.50 - 30	60	50

5.9.2 Test Setup

See section 4.4.2 for test setup description for the AC power supply port. The photo of test setup please refer to ANNEX B.

5.9.3 Test Procedure

The maximum conducted interference is searched using Peak (PK), if the emission levels more than the AV and QP limits, and that have narrow margins from the AV and QP limits will be re-measured with AV and QP detectors. Tests for both L phase and N phase lines of the power mains connected to the EUT are performed. Refer to recorded points and plots below.

Devices subject to Part 15 must be tested for all available U.S. voltages and frequencies (such as a nominal 120 VAC, 50/60 Hz and 240 VAC, 50/60 Hz) for which the device is capable of operation. A device rated for 50/60 Hz operation need not be tested at both frequencies provided the radiated and line conducted emissions are the same at both frequencies.

5.9.4 Test Result

Please refer to ANNEX A.7.

5.10 Radiated Spurious Emission

5.10.1 Limit

FCC §15.209&15.247(d); RSS-247, 5.5

Radiated emission outside the frequency band attenuation below the general limits specified in FCC section 15.209(a) is not required. In addition, radiated emissions which fall in the restricted bands, as defined in FCC section 15.205(a), must also comply with the radiated emission limits specified in FCC section 15.209(a).

According to FCC section 15.209 (a), except as provided elsewhere in this subpart, the emissions from an intentional radiator shall not exceed the field strength levels specified in the following table:

Frequency (MHz)	Field Strength ($\mu\text{V}/\text{m}$)	Measurement Distance (m)
0.009 - 0.490	2400/F(kHz)	300
0.490 - 1.705	24000/F(kHz)	30
1.705 - 30.0	30	30
30 - 88	100	3
88 - 216	150	3
216 - 960	200	3
Above 960	500	3

Note:

1. Field Strength ($\text{dB}\mu\text{V}/\text{m}$) = $20 \cdot \log[\text{Field Strength } (\mu\text{V}/\text{m})]$.
2. In the emission tables above, the tighter limit applies at the band edges.
3. For Above 1000 MHz, the emission limit in this paragraph is based on measurement instrumentation employing an average detector, measurement using instrumentation with a peak detector function, corresponding to 20dB above the maximum permitted average limit.
4. For above 1000 MHz, limit field strength of harmonics: $54\text{dB}\mu\text{V}/\text{m}@3\text{m}$ (AV) and $74\text{dB}\mu\text{V}/\text{m}@3\text{m}$ (PK).

5.10.2 Test Setup

See section 4.4.3 to 4.4.5 for test setup description for the antenna port. The photo of test setup please refer to ANNEX B.

5.10.3 Test Procedure

The measurement frequency range is from 9 kHz to the 10th harmonic of the fundamental frequency. The Turn Table is actuated to turn from 0° to 360° , and both horizontal and vertical polarizations of the Test Antenna are used to find the maximum radiated power. Mid channels on all channel bandwidth verified. Only the worst RB size/offset presented.

The power of the EUT transmitting frequency should be ignored.

All Spurious Emission tests were performed in X, Y, Z axis direction. And only the worst axis test condition was recorded in this test report.

Use the following spectrum analyzer settings:

Span = wide enough to fully capture the emission being measured

RBW = 1 MHz for $f \geq 1$ GHz, 100 kHz for $f < 1$ GHz

VBW \geq RBW

Sweep = auto

Detector function = peak

Trace = max hold

For measurement below 1GHz, If the emission level of the EUT measured by the peak detector is 3 dB lower than the applicable limit, the peak emission level will be reported, Otherwise, the emission measurement will be repeated using the quasi-peak detector and reported.

5.10.4 Test Result

Please refer to ANNEX A.8.

5.11 Band Edge (Restricted-band band-edge)

5.11.1 Limit

FCC §15.209&15.247(d)

Radiated emission outside the frequency band attenuation below the general limits specified in FCC section 15.209(a) is not required. In addition, radiated emissions which fall in the restricted bands, as defined in FCC section 15.205(a), must also comply with the radiated emission limits specified in FCC section 15.209(a).

5.11.2 Test Setup

See section 4.4.3 to 4.4.5 for test setup description for the antenna port. The photo of test setup please refer to ANNEX B.

5.11.3 Test Procedure

The measurement frequency range is from 9 kHz to the 10th harmonic of the fundamental frequency. The Turn Table is actuated to turn from 0° to 360°, and both horizontal and vertical polarizations of the Test Antenna are used to find the maximum radiated power. Mid channels on all channel bandwidth verified. Only the worst RB size/offset presented.

The power of the EUT transmitting frequency should be ignored.

All Spurious Emission tests were performed in X, Y, Z axis direction. And only the worst axis test condition was recorded in this test report.

Use the following spectrum analyzer settings:

Span = wide enough to fully capture the emission being measured

RBW = 1 MHz for $f \geq 1$ GHz, 100 kHz for $f < 1$ GHz

VBW \geq RBW

Sweep = auto

Detector function = peak

Trace = max hold

For measurement below 1GHz, If the emission level of the EUT measured by the peak detector is 3 dB lower than the applicable limit, the peak emission level will be reported, Otherwise, the emission measurement will be repeated using the quasi-peak detector and reported.

5.11.4 Test Result

Please refer to ANNEX A.9.

ANNEX A TEST RESULT

A.1 Number of Hopping Frequency

Test Data

Test Mode	Frequency Block (MHz)	Measured Channel Numbers	Min. Limit	Verdict
GFSK	2400 - 2483.5	79	15	Pass
8-DPSK	2400 - 2483.5	79	15	Pass

Test plots

GFSK 2.4 GHz ~ 2.4415 GHz

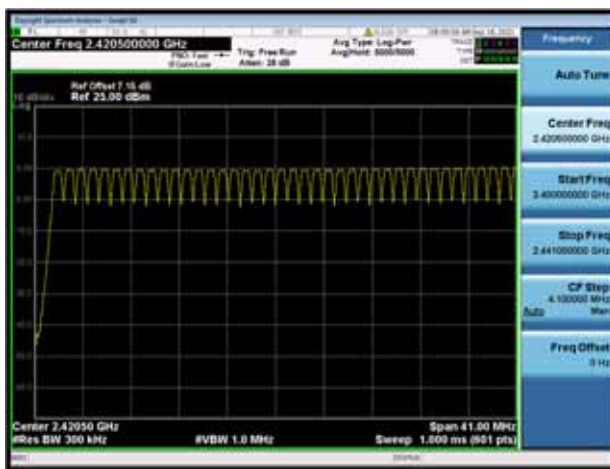

GFSK 2.4415 GHz ~ 2.4835 GHz

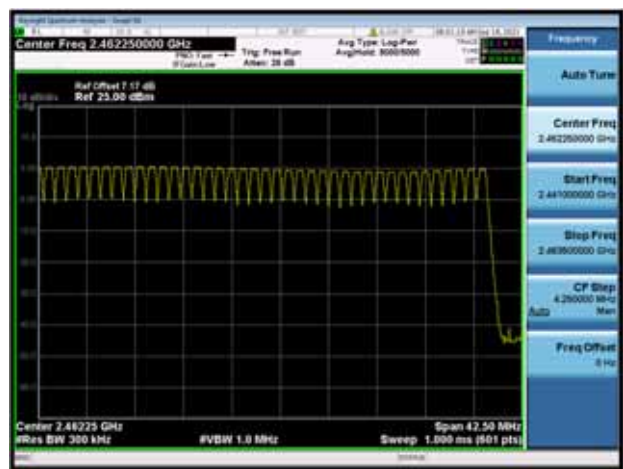

8-DPSK 2.4 GHz ~ 2.4415 GHz

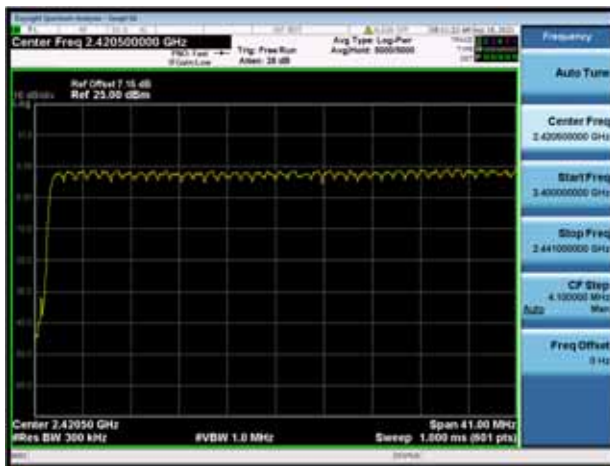

8-DPSK 2.4415 GHz ~ 2.4835 GHz

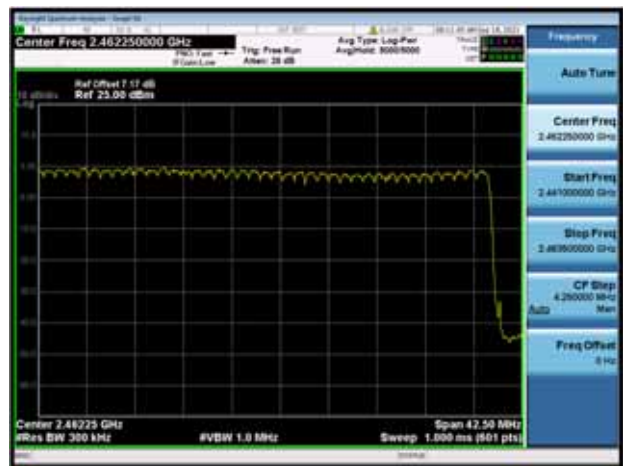

A.2 Peak Output Power and E.I.R.P

Peak Power Test Data

Channel	Measured Output Peak Power		Limit		Verdict
	GFSK		dBm	mW	
	dBm	mW			
Low	4.71	2.96	21	125	Pass
Middle	5.58	3.61			Pass
High	5.04	3.19			Pass

Channel	Measured Output Peak Power				Limit		Verdict
	$\pi/4$ -DQPSK		8-DPSK		dBm	mW	
	dBm	mW	dBm	mW			
Low	5.71	3.73	6.01	3.99	21	125	Pass
Middle	6.73	4.71	7.04	5.06			Pass
High	6.07	4.05	6.39	4.36			Pass

E.I.R.P Test Data (For ISED)

Channel	E.I.R.P						Limit		Verdict
	GFSK		$\pi/4$ -DQPSK		8-DPSK		dBm	mW	
	dBm	mW	dBm	mW	dBm	mW			
Low	6.91	4.91	7.91	6.18	8.21	6.62	36	4000	Pass
Middle	7.78	6.00	8.93	7.82	9.24	8.39			Pass
High	7.24	5.30	8.27	6.71	8.59	7.23			Pass

Test plots

GFSK LOW CHANNEL

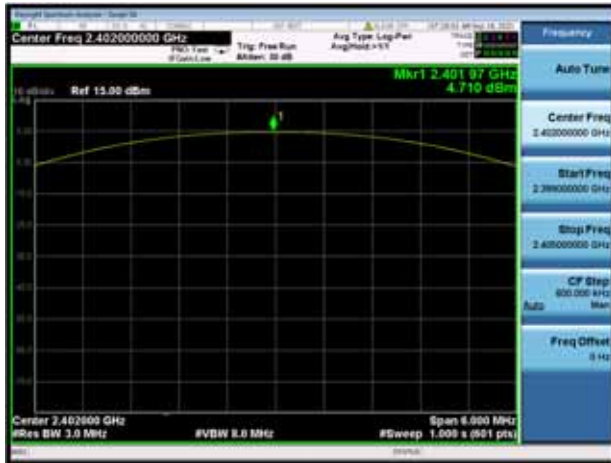

GFSK MIDDLE CHANNEL

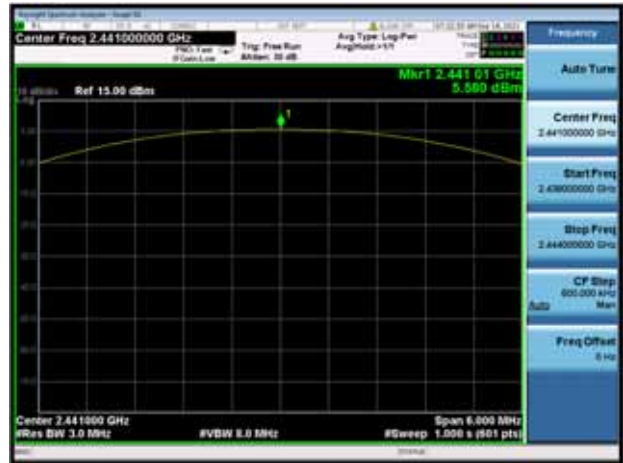

GFSK HIGH CHANNEL



$\pi/4$ -DQPSK LOW CHANNEL

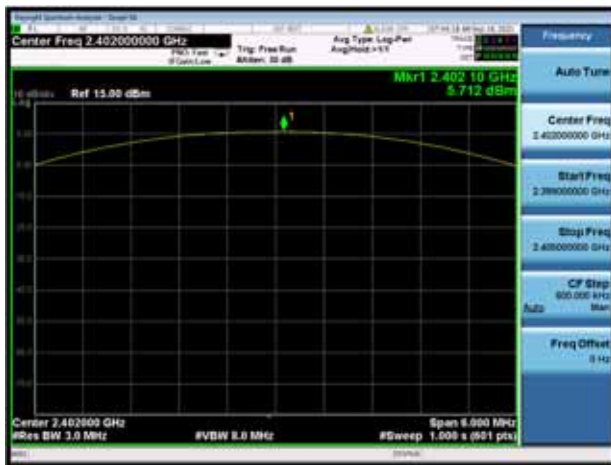

$\pi/4$ -DQPSK MIDDLE CHANNEL

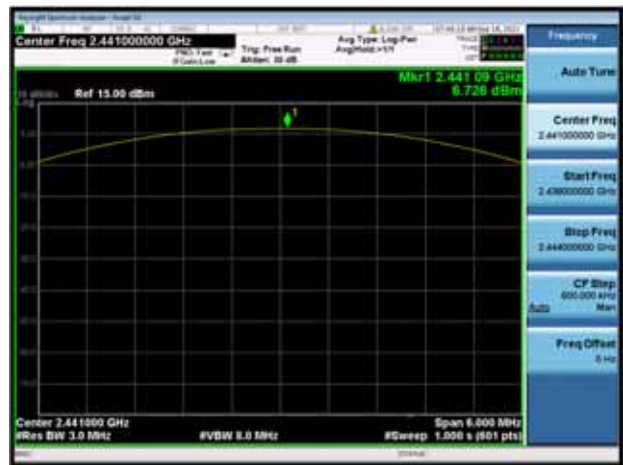

$\pi/4$ -DQPSK HIGH CHANNEL



8-DPSK LOW CHANNEL

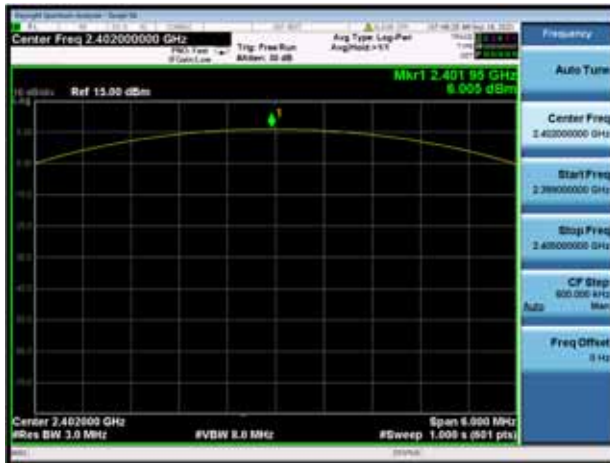

8-DPSK MIDDLE CHANNEL

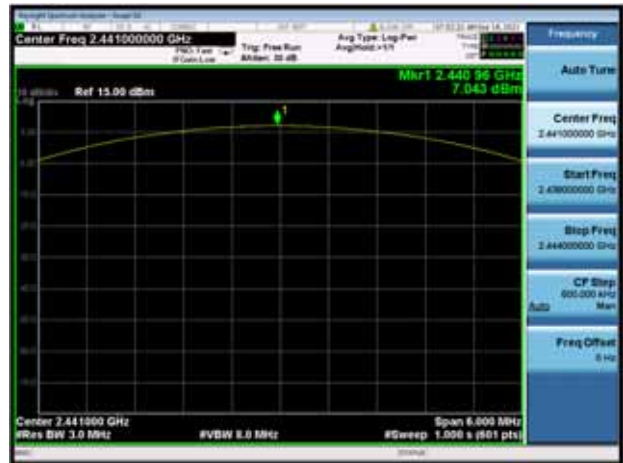

8-DPSK HIGH CHANNEL



A.3 20 dB and 99% bandwidth

Test Data

GFSK		
Channel	20 dB Bandwidth (MHz)	99% Bandwidth (MHz)
Low	0.955000	0.898890
Middle	0.955000	0.898020
High	0.955000	0.897720
$\pi/4$ -DQPSK		
Channel	20 dB Bandwidth (MHz)	99% Bandwidth (MHz)
Low	1.290000	1.171500
Middle	1.290000	1.171400
High	1.290000	1.171500
8-DPSK		
Channel	20 dB Bandwidth (MHz)	99% Bandwidth (MHz)
Low	1.290000	1.173100
Middle	1.290000	1.174100
High	1.290000	1.173300

Test plots

20 dB Bandwidth

GFSK LOW CHANNEL



GFSK MIDDLE CHANNEL



GFSK HIGH CHANNEL

 $\pi/4$ -DQPSK LOW CHANNEL

 $\pi/4$ -DQPSK MIDDLE CHANNEL

$\pi/4$ -DQPSK HIGH CHANNEL



8-DPSK LOW CHANNEL



8-DPSK MIDDLE CHANNEL



8-DPSK HIGH CHANNEL



99% Bandwidth

GFSK LOW CHANNEL



GFSK MIDDLE CHANNEL

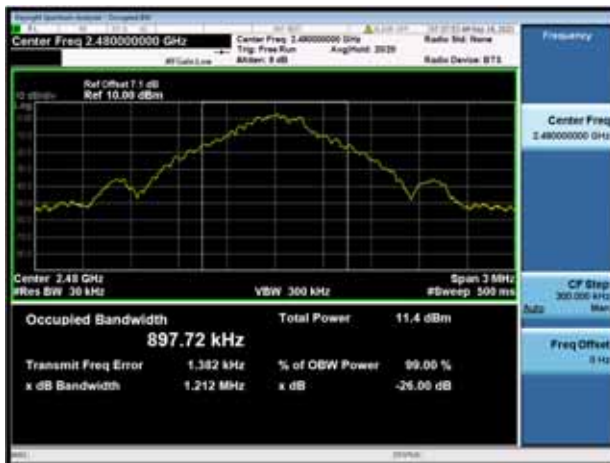

GFSK HIGH CHANNEL

 $\pi/4$ -DQPSK LOW CHANNEL

 $\pi/4$ -DQPSK MIDDLE CHANNEL

$\pi/4$ -DQPSK HIGH CHANNEL



8-DPSK LOW CHANNEL



8-DPSK MIDDLE CHANNEL



8-DPSK HIGH CHANNEL

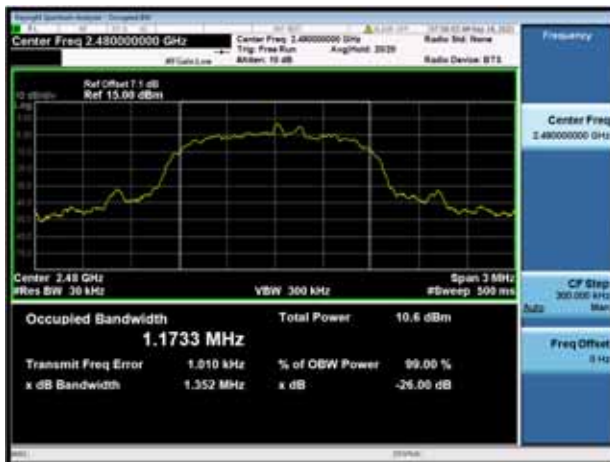

A.4 Hopping Frequency Separation

Test Data

Mode	Frequency separation (MHz)	2/3 of the 20 dB Bandwidth (MHz)	Verdict
GFSK	1.000	0.636667	Pass
8-DPSK	1.000	0.860000	Pass

Test Plots

GFSK



8-DPSK



A.5 Average Time of Occupancy

Test Data

GFSK				
DH Packet	Pulse Width (ms)	Total of Dwell (ms)	Limit (sec)	Verdict
DH 1	0.37920	121.344	0.4	Pass
DH 3	1.63400	261.440	0.4	Pass
DH 5	2.88800	308.053	0.4	Pass
8-DPSK				
DH Packet	Pulse Width (ms)	Total of Dwell (ms)	Limit (sec)	Verdict
DH 1	0.38720	123.904	0.4	Pass
DH 3	1.63400	261.440	0.4	Pass
DH 5	2.88800	308.053	0.4	Pass
AFH Mode				
DH Packet	Pulse Width (ms)	Total of Dwell (ms)	Limit (sec)	Verdict
DH 1	0.37920	60.672	0.4	Pass
DH 3	1.63400	130.720	0.4	Pass
DH 5	2.88800	154.027	0.4	Pass

Test Plots

GFSK DH1

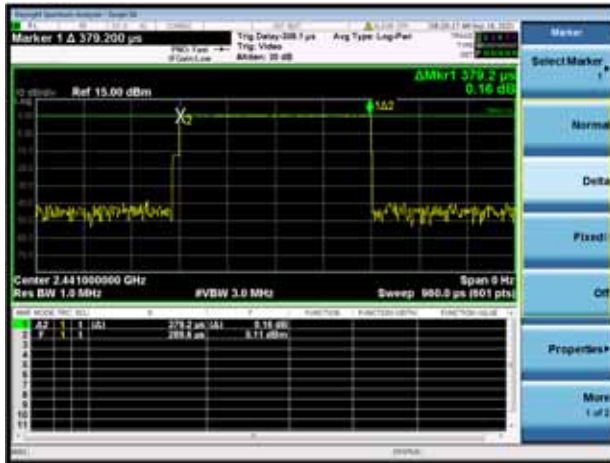

GFSK DH3

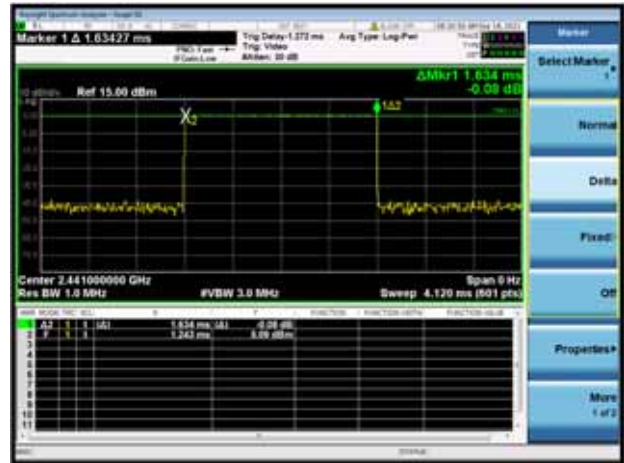

GFSK DH5

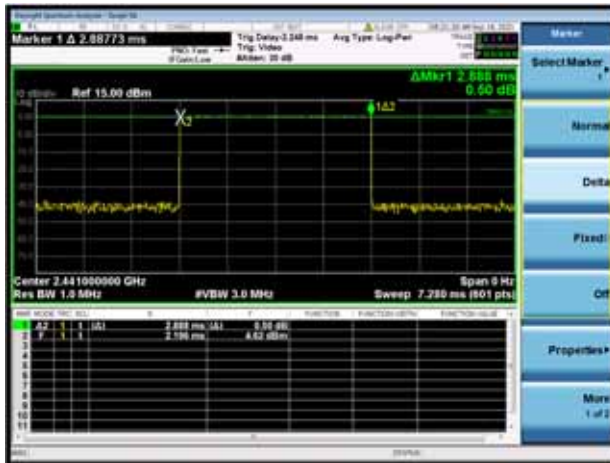

8-DPSK DH1

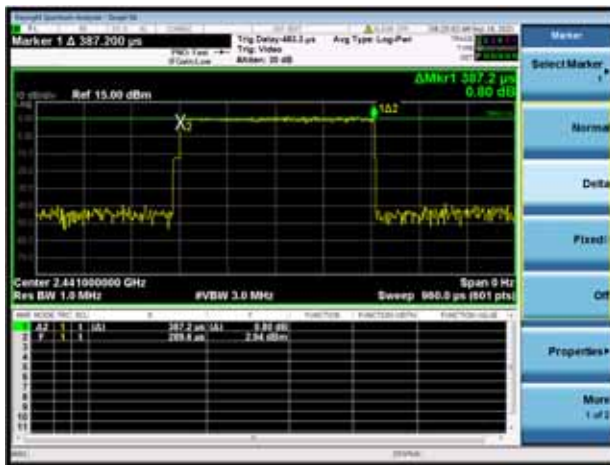

8-DPSK DH3

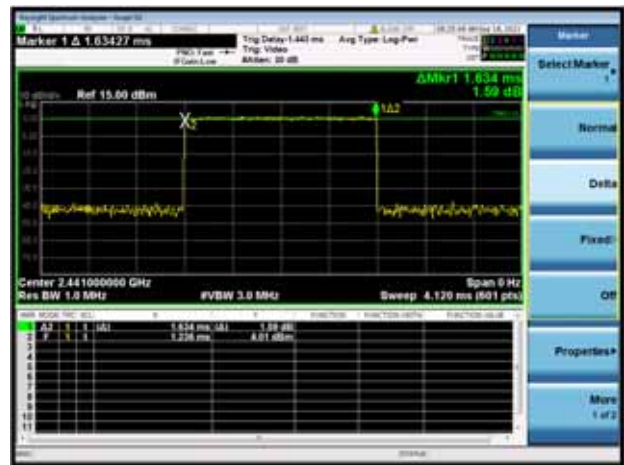

8-DPSK DH5



AFH Mode DH1

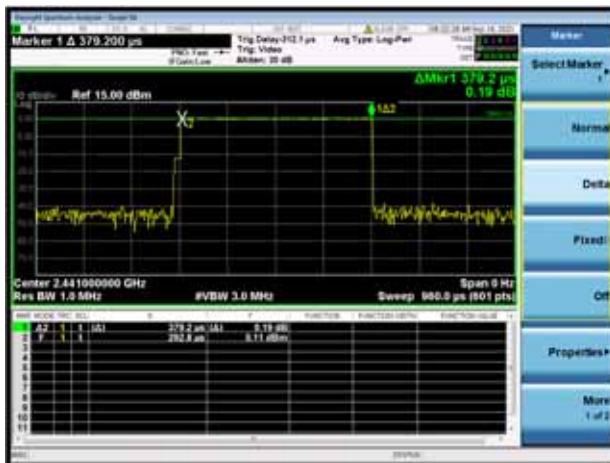

AFH Mode DH3

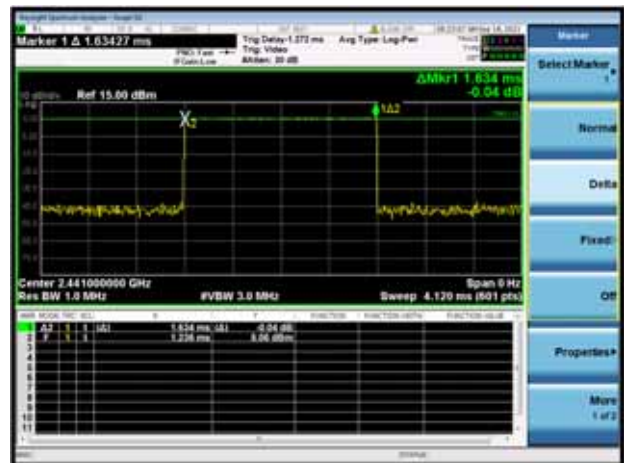

AFH Mode DH5

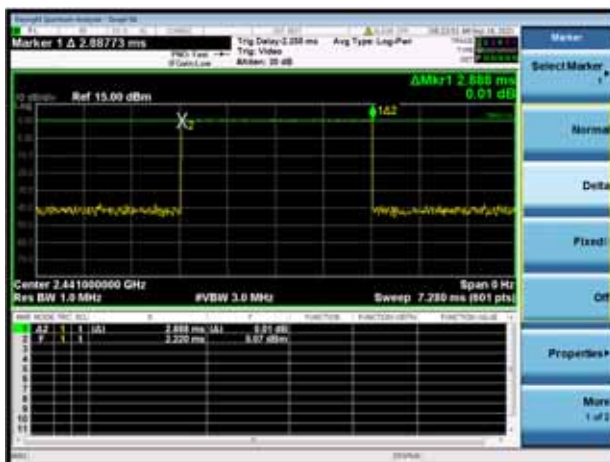

A.6 Conducted Spurious Emissions & Authorized-band band-edge

Test Data

GFSK				
Channel	Measured Max. Out of Band Emission (dBm)	Limit (dBm)		Verdict
		Carrier Level	Calculated 20 dBc Limit	
Low	-36.04	4.18	-15.82	Pass
Middle	-35.36	5.00	-15.00	Pass
High	-36.46	4.56	-15.45	Pass
8-DPSK				
Channel	Measured Max. Out of Band Emission (dBm)	Limit (dBm)		Verdict
		Carrier Level	Calculated 20 dBc Limit	
Low	-36.74	3.22	-16.78	Pass
Middle	-35.97	4.29	-15.72	Pass
High	-36.66	3.61	-16.39	Pass
Hopping Mode				
Mode	Measured Max. Out of Band Emission (dBm)	Limit (dBm)		Verdict
		Carrier Level	Calculated 20 dBc Limit	
GFSK	-36.23	5.33	-14.67	Pass
8-DPSK	-36.74	4.36	-15.65	Pass

Test Plots

GFSK LOW CHANNEL, CARRIER LEVEL



GFSK LOW CHANNEL, BAND EDGE



GFSK LOW CHANNEL, SPURIOUS 30 MHz ~ 3 GHz

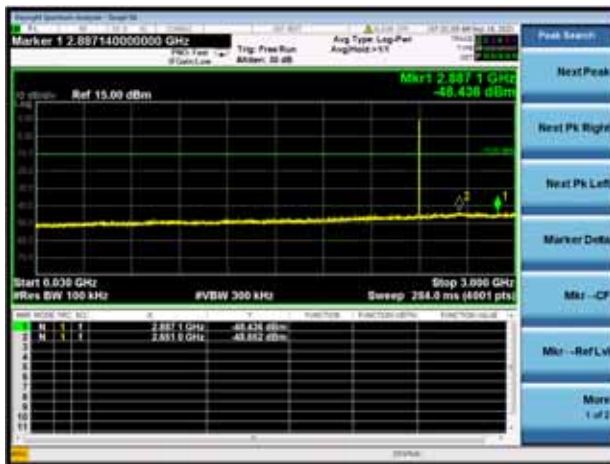

GFSK LOW CHANNEL, SPURIOUS 3 GHz ~ 25 GHz



GFSK MIDDLE CHANNEL, CARRIER LEVEL



GFSK MIDDLE CHANNEL, SPURIOUS 30 MHz ~ 3 GHz



GFSK MIDDLE CHANNEL, SPURIOUS 3 GHz ~ 25 GHz



GFSK HIGH CHANNEL, CARRIER LEVEL



GFSK HIGH CHANNEL, BAND EDGE



GFSK HIGH CHANNEL, SPURIOUS 30 MHz ~ 3 GHz

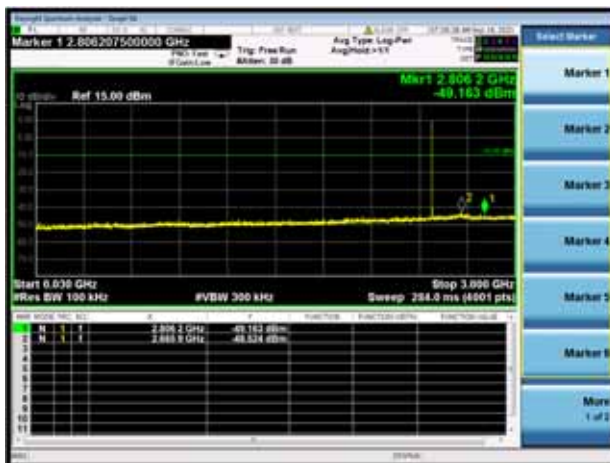

GFSK HIGH CHANNEL, SPURIOUS 3 GHz ~ 25 GHz



8-DPSK LOW CHANNEL, CARRIER LEVEL



8-DPSK LOW CHANNEL, BAND EDGE



8-DPSK LOW CHANNEL, SPURIOUS 30 MHz ~ 3 GHz

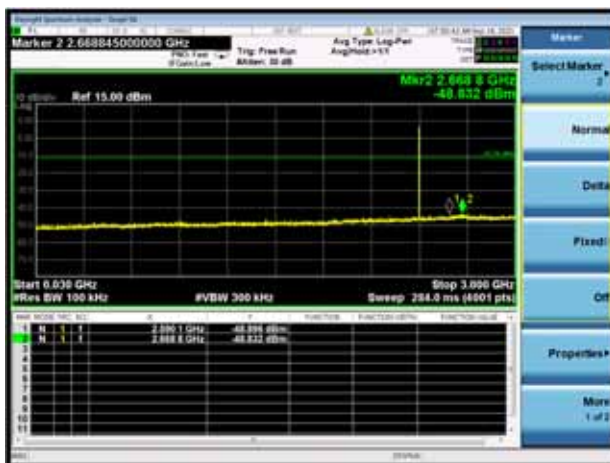

8-DPSK LOW CHANNEL, SPURIOUS 3 GHz ~ 25 GHz

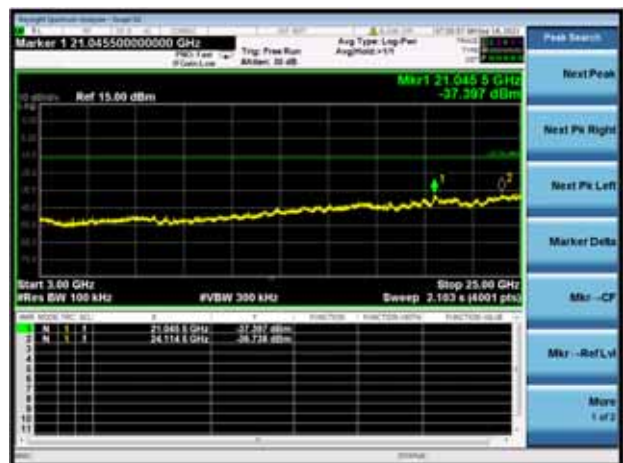

8-DPSK MIDDLE CHANNEL, CARRIER LEVEL



8-DPSK MIDDLE CHANNEL, SPURIOUS 30 MHz ~ 3 GHz



8-DPSK MIDDLE CHANNEL, SPURIOUS 3 GHz ~ 25 GHz



8-DPSK HIGH CHANNEL, CARRIER LEVEL



8-DPSK HIGH CHANNEL, BAND EDGE

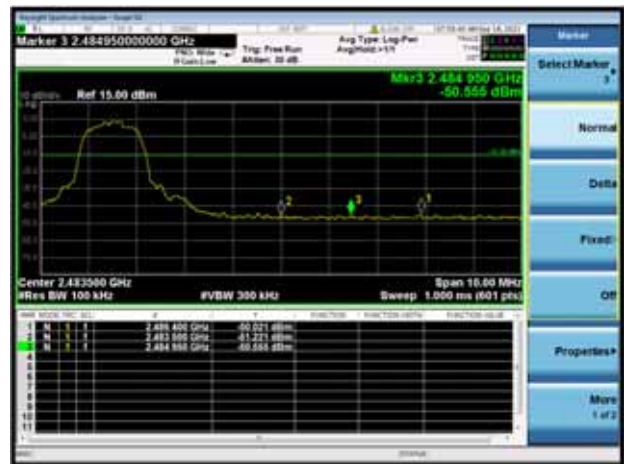

8-DPSK HIGH CHANNEL, SPURIOUS 30 MHz ~ 3 GHz

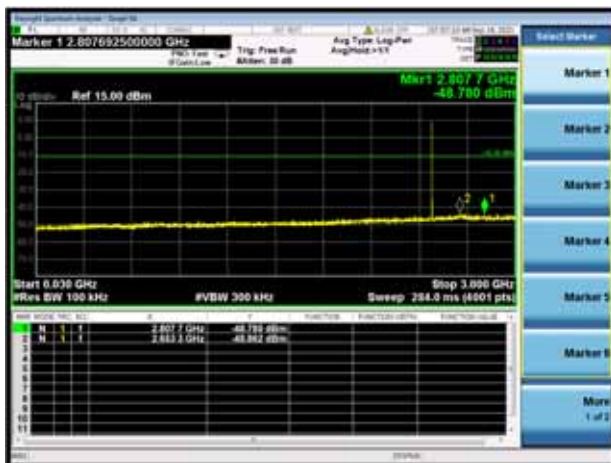

8-DPSK HIGH CHANNEL, SPURIOUS 3 GHz ~ 25 GHz



GFSK HOPPING, CARRIER LEVEL



GFSK HOPPING BAND EDGE (LOW)



GFSK HOPPING BAND EDGE (HIGH)



GFSK Hopping Mode, SPURIOUS 30 MHz ~ 3 GHz

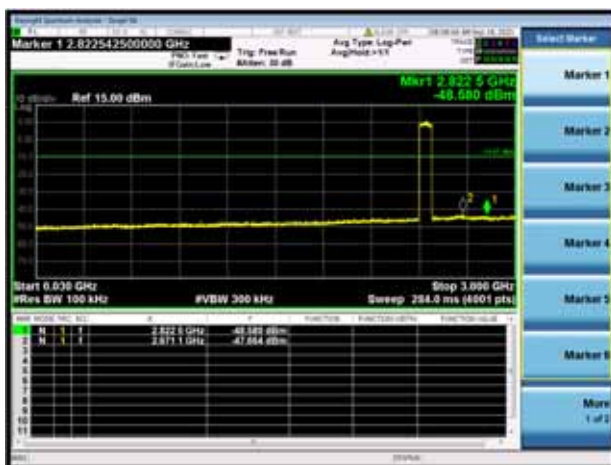

GFSK Hopping Mode, SPURIOUS 30 3GHz ~ 25 GHz

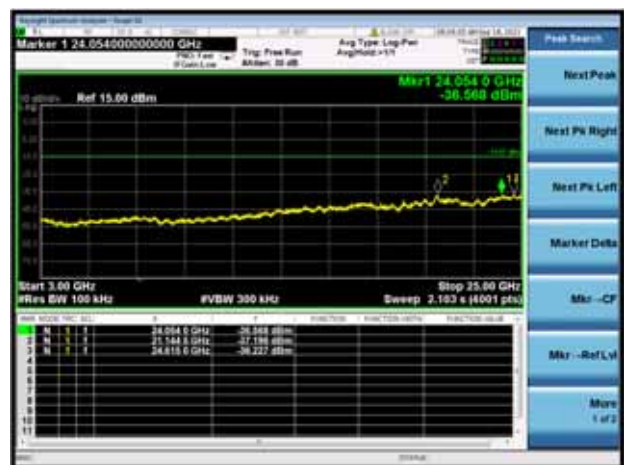

8-DPSK HOPPING, CARRIER LEVEL



8-DPSK Hopping BAND EDGE (LOW)



8-DPSK Hopping BAND EDGE (HIGH)



8-DPSK Hopping Mode, SPURIOUS 30 MHz ~ 3 GHz

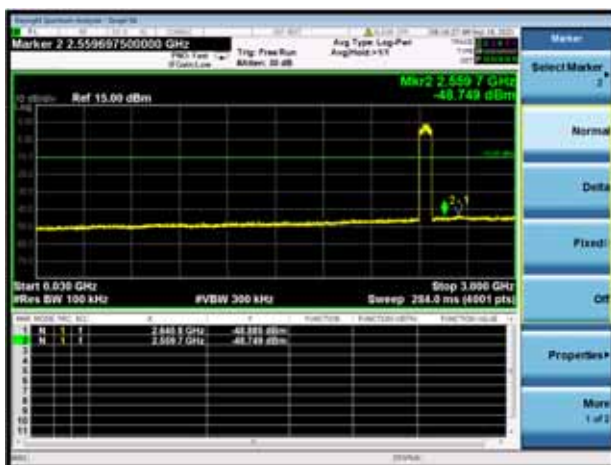

8-DPSK Hopping Mode, SPURIOUS 30 3GHz ~ 25 GHz

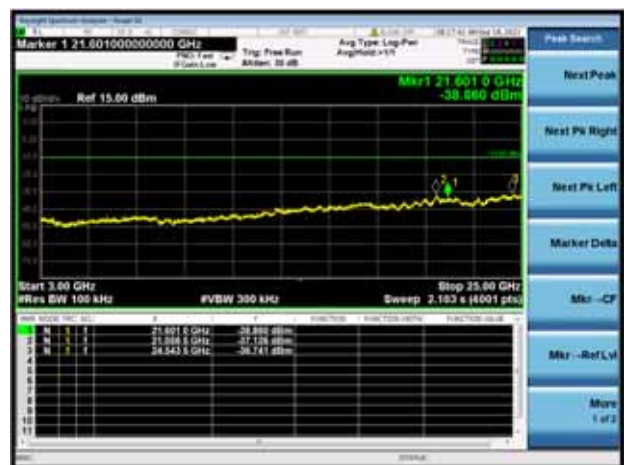

A.7 Conducted Emissions

Note¹: The EUT is working in the Normal link mode. All modes have been tested and normal link mode is worst.
 Note²: Devices subject to Part 15 must be tested for all available U.S. voltages and frequencies (such as a nominal 120 VAC, 60 Hz and 240 VAC, 50 Hz) for which the device is capable of operation. So, The configuration 120 VAC, 60 Hz and 240 VAC, 50 Hz were tested respectively, but only the worst configuration (120 VAC, 60 Hz) shown here.

Note³: Results (dBuV) = Original reading level of Spectrum Analyzer (dBuV) + Factor (dB)

Test Data and Plots

PHASE L

CE Test case_FCC_CE_FCC PART 15B_Class B

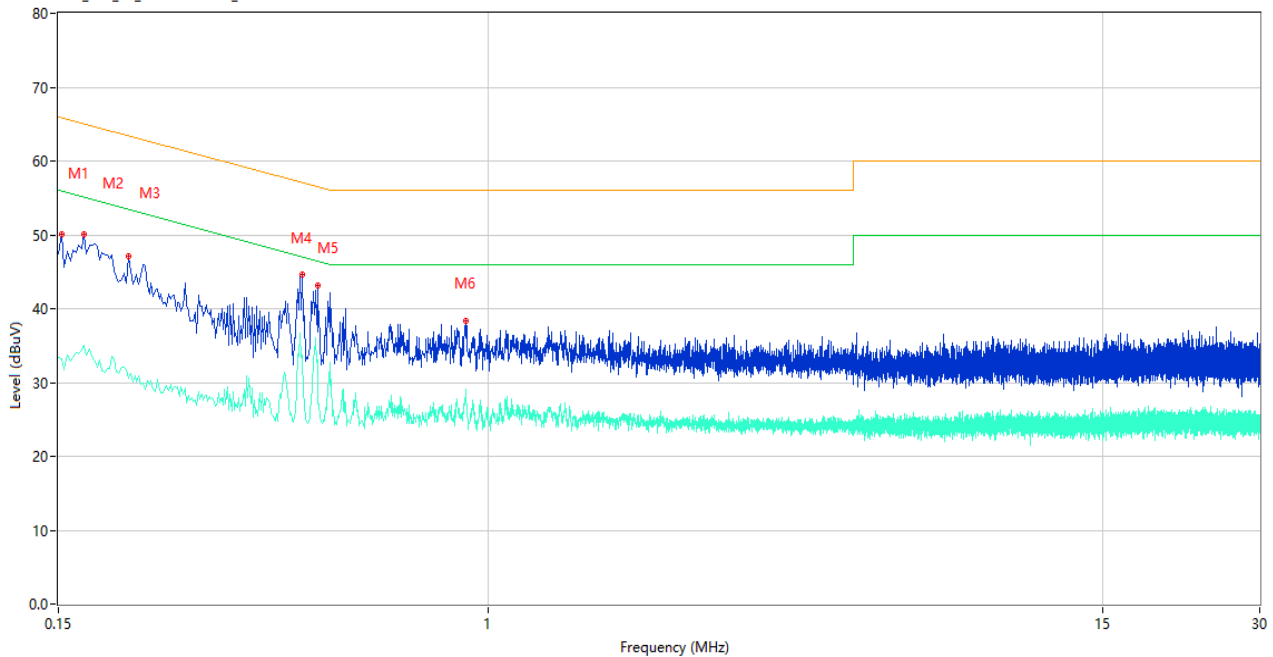

No.	Frequency (MHz)	Results (dBuV)	Factor (dB)	Limit (dBuV)	Over Limit (dB)	Detector	Line	Verdict
1	0.150	47.37	10.41	66.00	-18.63	Peak	L	Pass
1**	0.150	33.36	10.41	56.00	-22.64	AV	L	Pass
2	0.168	50.04	10.40	65.06	-15.02	Peak	L	Pass
2**	0.168	35.09	10.40	55.06	-19.97	AV	L	Pass
3	0.204	47.09	10.38	63.45	-16.36	Peak	L	Pass
3**	0.204	30.58	10.38	53.45	-22.87	AV	L	Pass
4	0.440	44.61	10.31	57.06	-12.45	Peak	L	Pass
4**	0.440	33.64	10.31	47.06	-13.42	AV	L	Pass
5	0.470	43.19	10.30	56.51	-13.32	Peak	L	Pass
5**	0.470	33.03	10.30	46.51	-13.48	AV	L	Pass
6	0.904	38.41	10.24	56.00	-17.59	Peak	L	Pass
6**	0.904	29.14	10.24	46.00	-16.86	AV	L	Pass

PHASE N

CE Test case_FCC_CE_FCC PART 15B_Class B

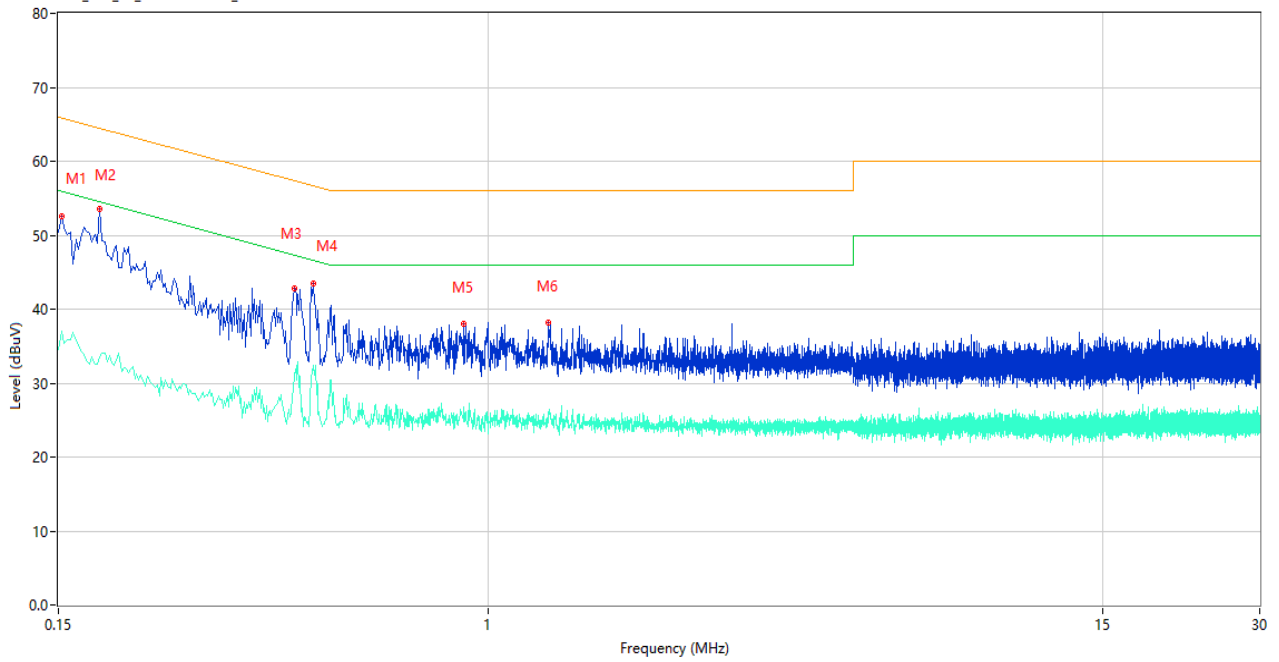

No.	Frequency (MHz)	Results (dBuV)	Factor (dB)	Limit (dBuV)	Over Limit (dB)	Detector	Line	Verdict
1	0.152	52.50	10.41	65.89	-13.39	Peak	N	Pass
1**	0.152	37.03	10.41	55.89	-18.86	AV	N	Pass
2	0.180	53.56	10.39	64.49	-10.93	Peak	N	Pass
2**	0.180	33.63	10.39	54.49	-20.86	AV	N	Pass
3	0.424	42.82	10.31	57.37	-14.55	Peak	N	Pass
3**	0.424	31.43	10.31	47.37	-15.94	AV	N	Pass
4	0.462	43.48	10.30	56.66	-13.18	Peak	N	Pass
4**	0.462	32.33	10.30	46.66	-14.33	AV	N	Pass
5	0.896	38.02	10.24	56.00	-17.98	Peak	N	Pass
5**	0.896	26.75	10.24	46.00	-19.25	AV	N	Pass
6	1.304	38.21	10.25	56.00	-17.79	Peak	N	Pass
6**	1.304	25.98	10.25	46.00	-20.02	AV	N	Pass

A.8 Radiated Spurious Emission

Test Data and Plots

Note¹: The symbol of "--" in the table which means not application.

Note²: For the test data above 1 GHz, according the ANSI C63.10-2013, where limits are specified for both average and peak (or quasi-peak) detector functions, if the peak (or quasi-peak) measured value complies with the average limit, it is unnecessary to perform an average measurement.

Note³: The EUT is working in the Normal link mode below 1 GHz. All modes have been tested and DH5-Hopping mode is the worst.

Note⁴: Results (dBuV/m) = Original reading level of Spectrum Analyzer (dBuV/m) + Factor (dB)

The low frequency, which started from 9 kHz to 30 MHz, was pre-scanned and the result which was 20 dB lower than the limit line per 15.31(o) was not reported.

30 MHz to 1 GHz, ANT H

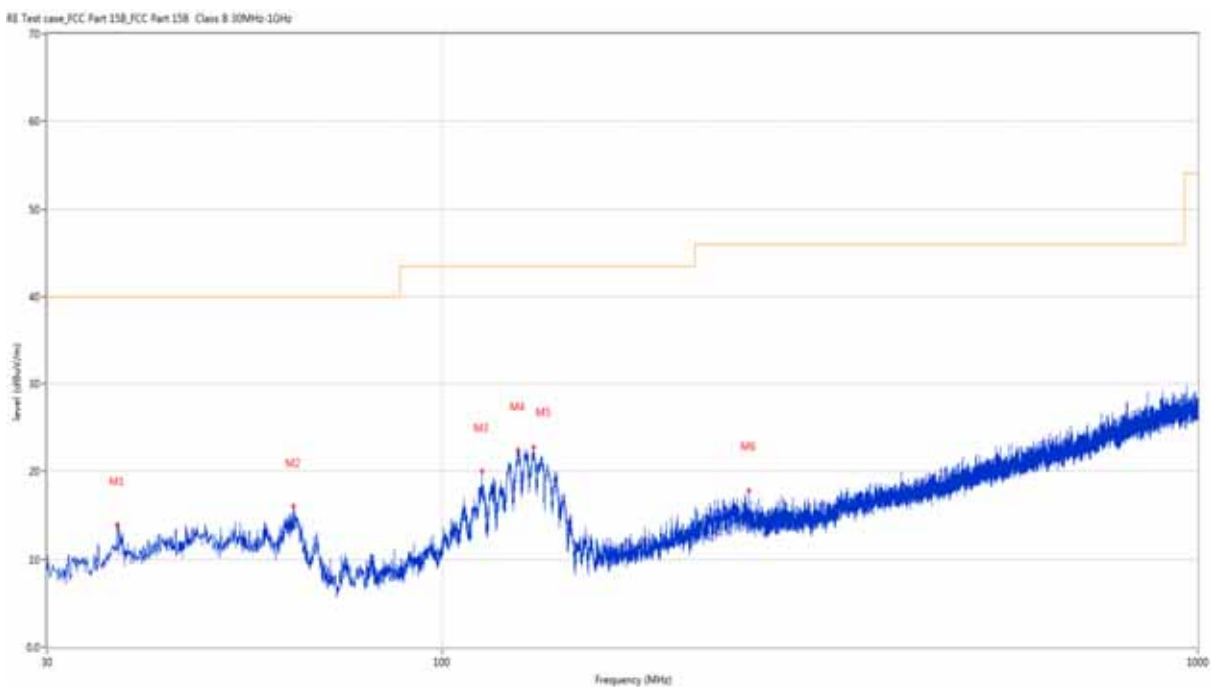

No.	Frequency (MHz)	Results (dBuV/m)	Factor (dB)	Limit (dBuV/m)	Over Limit (dB)	Detector	Table (Degree)	Height (cm)	Antenna	Verdict
1	37.178	13.85	-24.61	40.0	-26.15	Peak	315.50	200	Horizontal	Pass
2	63.611	15.97	-24.87	40.0	-24.03	Peak	360.00	100	Horizontal	Pass
3	112.838	20.02	-24.41	43.5	-23.48	Peak	189.00	200	Horizontal	Pass
4	125.981	22.38	-26.62	43.5	-21.12	Peak	193.20	200	Horizontal	Pass
5	132.238	22.73	-27.27	43.5	-20.77	Peak	175.90	200	Horizontal	Pass
6	254.506	17.83	-22.63	46.0	-28.17	Peak	113.10	100	Horizontal	Pass

30 MHz to 1 GHz, ANT V

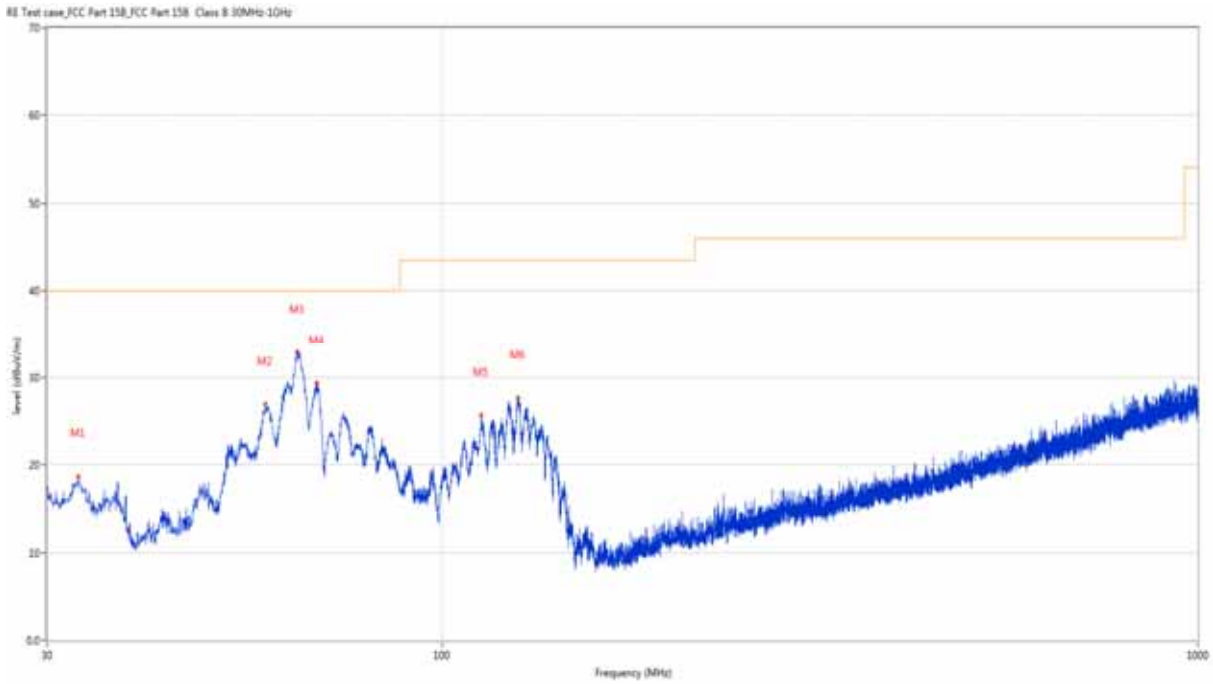

No.	Frequency (MHz)	Results (dBuV/m)	Factor (dB)	Limit (dBuV/m)	Over Limit (dB)	Detector	Table (Degree)	Height (cm)	Antenna	Verdict
1	33.007	18.64	-26.37	40.0	-21.36	Peak	88.50	100	Vertical	Pass
2	58.324	26.90	-24.08	40.0	-13.10	Peak	59.00	100	Vertical	Pass
3	64.338	32.90	-24.97	40.0	-7.10	Peak	341.30	100	Vertical	Pass
4	68.315	29.34	-26.00	40.0	-10.66	Peak	360.00	200	Vertical	Pass
5	112.644	25.72	-24.42	43.5	-17.78	Peak	290.10	100	Vertical	Pass
6	126.127	27.64	-26.67	43.5	-15.86	Peak	336.80	100	Vertical	Pass

Test Data and Plots (1 GHz ~ 10th Harmonic)

Note 1: The marked spikes near 2400 MHz with circle should be ignored because they are Fundamental signal.

Note 2: The spurious from 18GHz-25GHz is noise only, do not show on the report.

GFSK LOW CHANNEL 1 GHz to 18 GHz, ANT H

RE Test case_FCC Part 15C_FCC 15.247(2.4G)_1GHz-18GHz

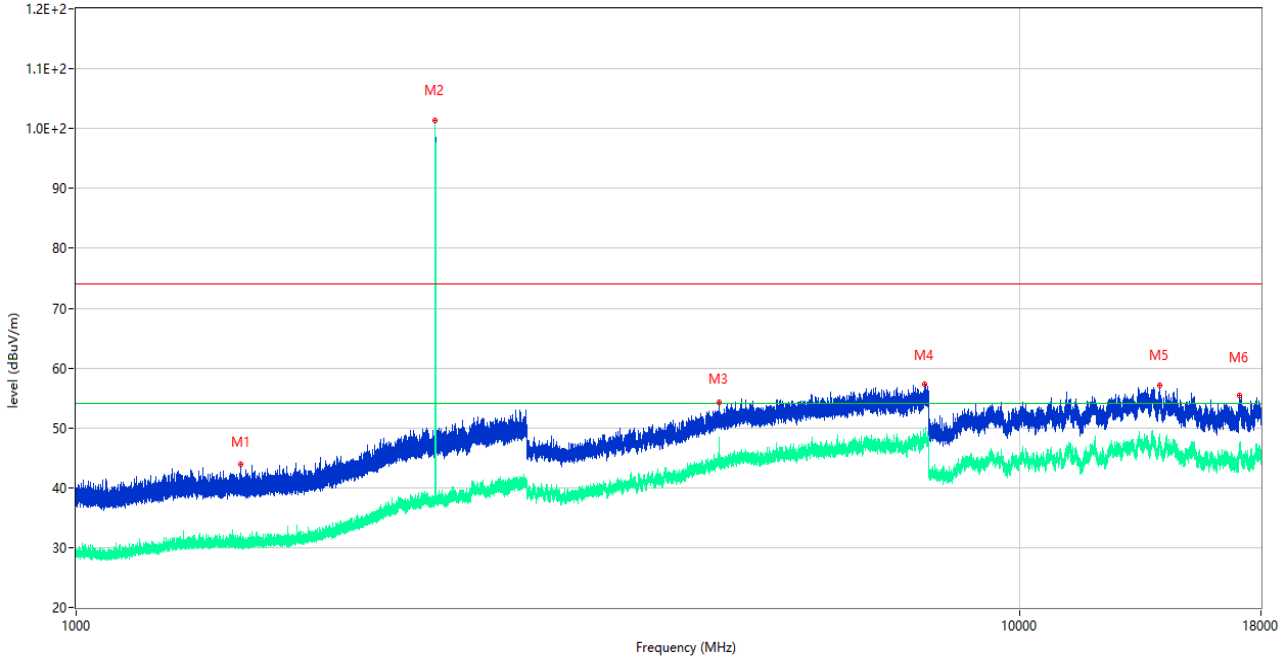

No.	Frequency (MHz)	Results (dBuV/m)	Factor (dB)	Limit (dBuV/m)	Over Limit (dB)	Detector	Table (Degree)	Height (cm)	Antenna	Verdict
1	1492.400	43.98	-16.55	74.0	-30.02	Peak	197.00	150	Horizontal	Pass
1**	1492.400	30.90	-16.55	54.0	-23.10	AV	197.00	150	Horizontal	Pass
2	2401.800	101.32	-11.42	74.0	27.32	Peak	354.00	150	Horizontal	N/A
2**	2401.800	100.31	-11.42	54.0	46.31	AV	354.00	150	Horizontal	N/A
3	4803.500	54.22	0.99	74.0	-19.78	Peak	128.00	150	Horizontal	Pass
3**	4803.500	45.53	0.99	54.0	-8.47	AV	128.00	150	Horizontal	Pass
4	7916.000	57.38	3.31	74.0	-16.62	Peak	82.00	150	Horizontal	Pass
4**	7916.000	47.98	3.31	54.0	-6.02	AV	82.00	150	Horizontal	Pass
5	14060.000	57.05	5.15	74.0	-16.95	Peak	88.00	150	Horizontal	Pass
5**	14060.000	48.32	5.15	54.0	-5.68	AV	88.00	150	Horizontal	Pass
6	17069.000	55.37	2.54	74.0	-18.63	Peak	77.00	150	Horizontal	Pass
6**	17069.000	45.83	2.54	54.0	-8.17	AV	77.00	150	Horizontal	Pass

GFSK LOW CHANNEL 1 GHz to 18 GHz, ANT V

RE Test case_FCC Part 15C_FCC 15.247(2.4G)_1GHz-18GHz

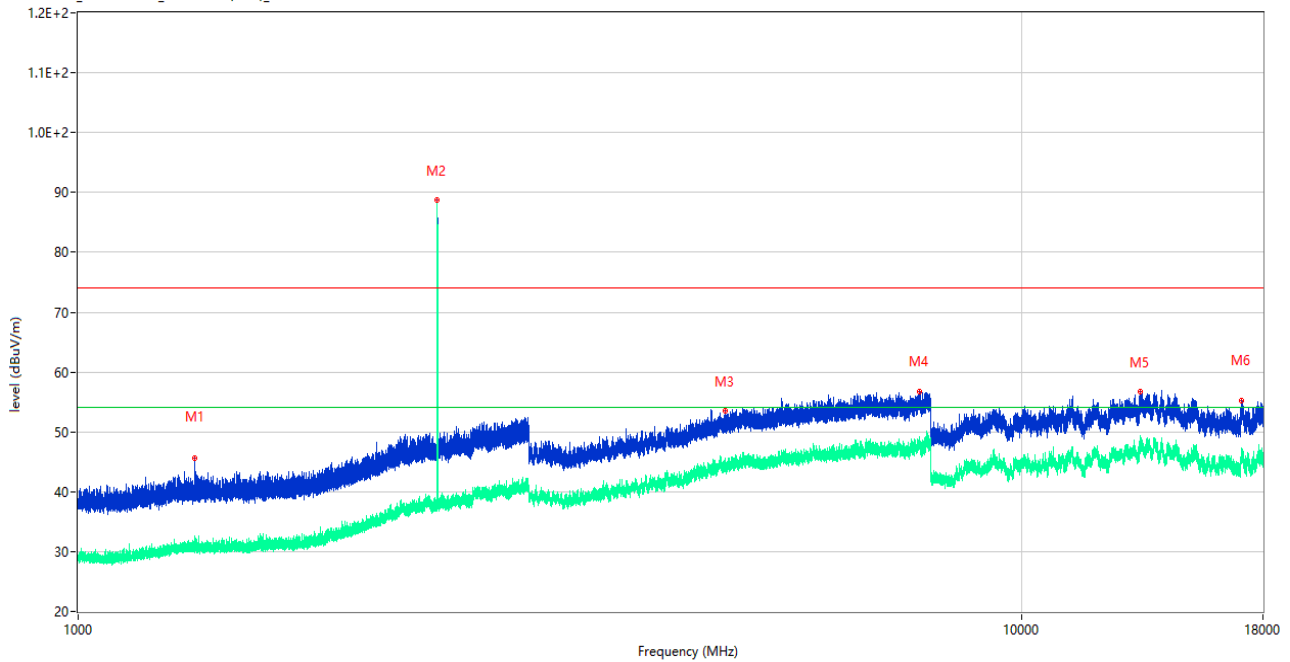

No.	Frequency (MHz)	Results (dBuV/m)	Factor (dB)	Limit (dBuV/m)	Over Limit (dB)	Detector	Table (Degree)	Height (cm)	Antenna	Verdict
1	1330.300	45.62	-16.39	74.0	-28.38	Peak	301.00	150	Vertical	Pass
1**	1330.300	31.27	-16.39	54.0	-22.73	AV	301.00	150	Vertical	Pass
2	2401.800	88.65	-11.42	74.0	14.65	Peak	353.00	150	Vertical	N/A
2**	2401.800	87.49	-11.42	54.0	33.49	AV	353.00	150	Vertical	N/A
3	4844.750	53.47	0.59	74.0	-20.53	Peak	302.00	150	Vertical	Pass
3**	4844.750	43.87	0.59	54.0	-10.13	AV	302.00	150	Vertical	Pass
4	7782.500	56.66	3.79	74.0	-17.34	Peak	194.00	150	Vertical	Pass
4**	7782.500	49.11	3.79	54.0	-4.89	AV	194.00	150	Vertical	Pass
5	13349.500	56.72	5.21	74.0	-17.28	Peak	62.00	150	Vertical	Pass
5**	13349.500	47.40	5.21	54.0	-6.60	AV	62.00	150	Vertical	Pass
6	17087.000	55.26	3.24	74.0	-18.74	Peak	117.00	150	Vertical	Pass
6**	17087.000	46.31	3.24	54.0	-7.69	AV	117.00	150	Vertical	Pass

GFSK MIDDLE CHANNEL 1 GHz to 18 GHz, ANT H

RE Test case_FCC Part 15C_FCC 15.247(2.4G)_1GHz-18GHz

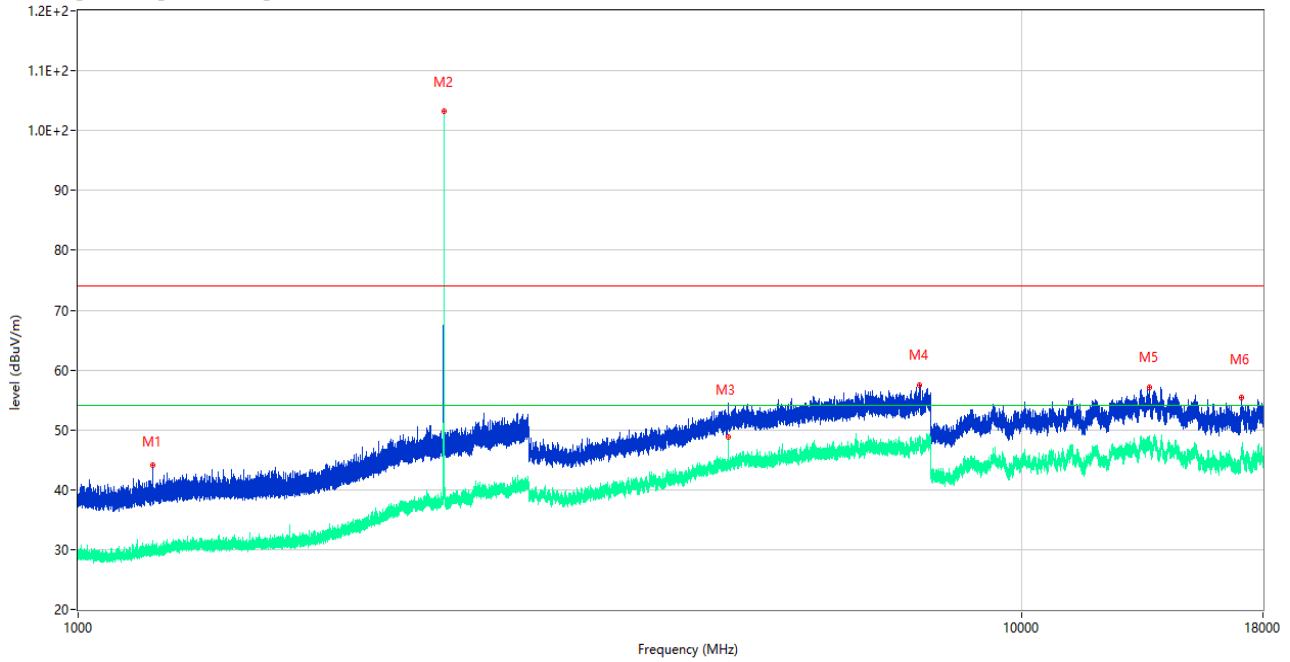

No.	Frequency (MHz)	Results (dBuV/m)	Factor (dB)	Limit (dBuV/m)	Over Limit (dB)	Detector	Table (Degree)	Height (cm)	Antenna	Verdict
1	1199.800	44.03	-16.98	74.0	-29.97	Peak	289.00	150	Horizontal	Pass
1**	1199.800	29.88	-16.98	54.0	-24.12	AV	289.00	150	Horizontal	Pass
2	2441.100	103.20	-11.17	74.0	29.20	Peak	358.00	150	Horizontal	N/A
2**	2441.100	102.88	-11.17	54.0	48.88	AV	358.00	150	Horizontal	N/A
3	4882.000	54.39	0.68	74.0	-19.61	Peak	356.00	150	Horizontal	Pass
3**	4882.000	48.77	0.68	54.0	-5.23	AV	356.00	150	Horizontal	Pass
4	7790.500	57.49	3.56	74.0	-16.51	Peak	42.00	150	Horizontal	Pass
4**	7790.500	47.87	3.56	54.0	-6.13	AV	42.00	150	Horizontal	Pass
5	13630.500	57.14	4.97	74.0	-16.86	Peak	118.00	150	Horizontal	Pass
5**	13630.500	48.35	4.97	54.0	-5.65	AV	118.00	150	Horizontal	Pass
6	17097.000	55.37	3.63	74.0	-18.63	Peak	338.00	150	Horizontal	Pass
6**	17097.000	46.60	3.63	54.0	-7.40	AV	338.00	150	Horizontal	Pass

GFSK MIDDLE CHANNEL 1 GHz to 18 GHz, ANT V

RE Test case_FCC Part 15C_FCC 15.247(2.4G)_1GHz-18GHz

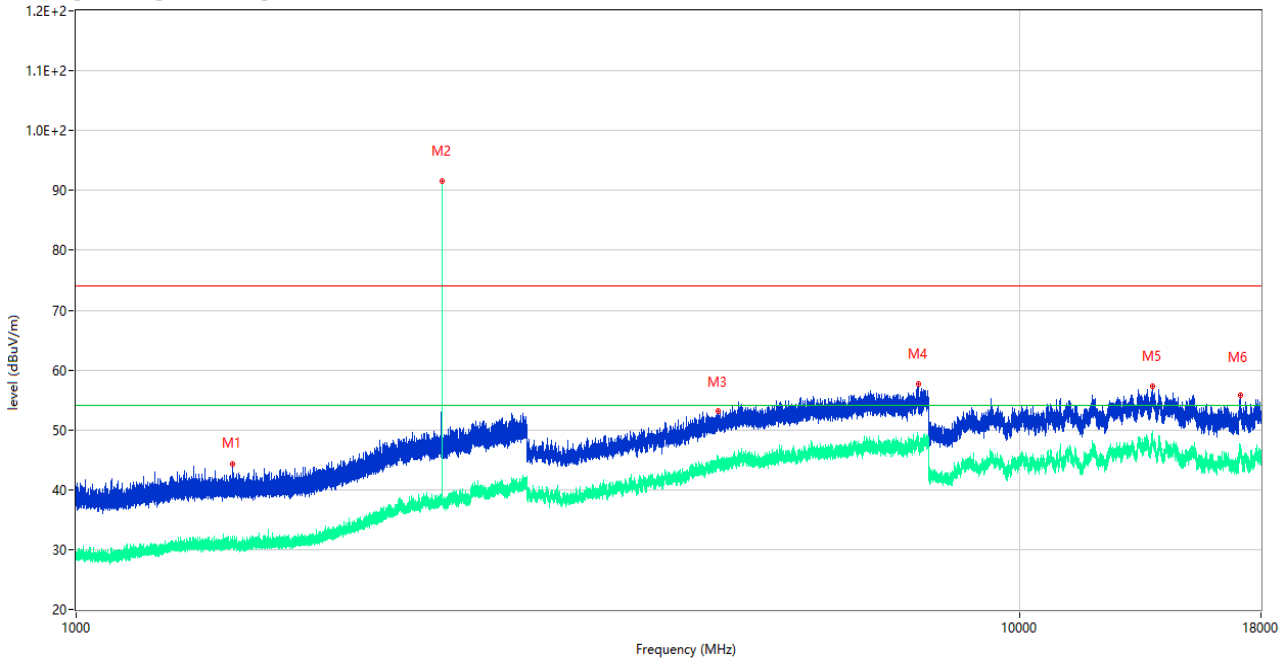

No.	Frequency (MHz)	Results (dBuV/m)	Factor (dB)	Limit (dBuV/m)	Over Limit (dB)	Detector	Table (Degree)	Height (cm)	Antenna	Verdict
1	1466.200	44.28	-16.31	74.0	-29.72	Peak	299.00	150	Vertical	Pass
1**	1466.200	31.05	-16.31	54.0	-22.95	AV	299.00	150	Vertical	Pass
2	2440.800	91.50	-11.18	74.0	17.50	Peak	351.00	150	Vertical	N/A
2**	2440.800	90.67	-11.18	54.0	36.67	AV	351.00	150	Vertical	N/A
3	4790.000	53.22	0.77	74.0	-20.78	Peak	354.00	150	Vertical	Pass
3**	4790.000	43.99	0.77	54.0	-10.01	AV	354.00	150	Vertical	Pass
4	7802.000	57.66	3.15	74.0	-16.34	Peak	190.00	150	Vertical	Pass
4**	7802.000	47.94	3.15	54.0	-6.06	AV	190.00	150	Vertical	Pass
5	13809.500	57.34	5.69	74.0	-16.66	Peak	56.00	150	Vertical	Pass
5**	13809.500	47.62	5.69	54.0	-6.38	AV	56.00	150	Vertical	Pass
6	17122.500	55.80	3.38	74.0	-18.20	Peak	276.00	150	Vertical	Pass
6**	17122.500	45.83	3.38	54.0	-8.17	AV	276.00	150	Vertical	Pass

GFSK HIGH CHANNEL 1 GHz to 18 GHz, ANT H

RE Test case_FCC Part 15C_FCC 15.247(2.4G)_1GHz-18GHz

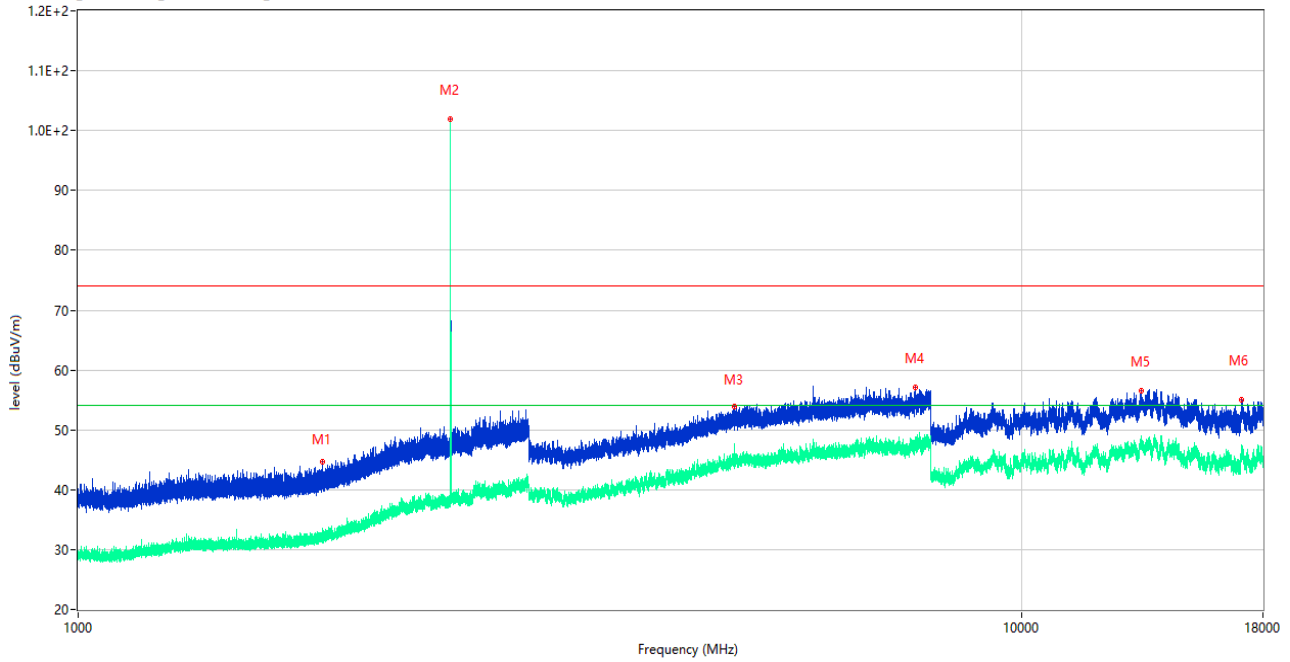

No.	Frequency (MHz)	Results (dBuV/m)	Factor (dB)	Limit (dBuV/m)	Over Limit (dB)	Detector	Table (Degree)	Height (cm)	Antenna	Verdict
1	1814.400	44.66	-15.60	74.0	-29.34	Peak	269.00	150	Horizontal	Pass
1**	1814.400	31.85	-15.60	54.0	-22.15	AV	269.00	150	Horizontal	Pass
2	2479.900	101.87	-10.98	74.0	27.87	Peak	351.00	150	Horizontal	N/A
2**	2479.900	101.34	-10.98	54.0	47.34	AV	351.00	150	Horizontal	N/A
3	4959.750	53.86	1.15	74.0	-20.14	Peak	4.00	150	Horizontal	Pass
3**	4959.750	47.33	1.15	54.0	-6.67	AV	4.00	150	Horizontal	Pass
4	7710.500	57.16	3.49	74.0	-16.84	Peak	0.00	150	Horizontal	Pass
4**	7710.500	48.56	3.49	54.0	-5.44	AV	0.00	150	Horizontal	Pass
5	13367.000	56.54	5.12	74.0	-17.46	Peak	67.00	150	Horizontal	Pass
5**	13367.000	47.81	5.12	54.0	-6.19	AV	67.00	150	Horizontal	Pass
6	17083.500	54.95	3.11	74.0	-19.05	Peak	55.00	150	Horizontal	Pass
6**	17083.500	46.45	3.11	54.0	-7.55	AV	55.00	150	Horizontal	Pass

GFSK HIGH CHANNEL 1 GHz to 18 GHz, ANT V

RE Test case_FCC Part 15C_FCC 15.247(2.4G)_1GHz-18GHz

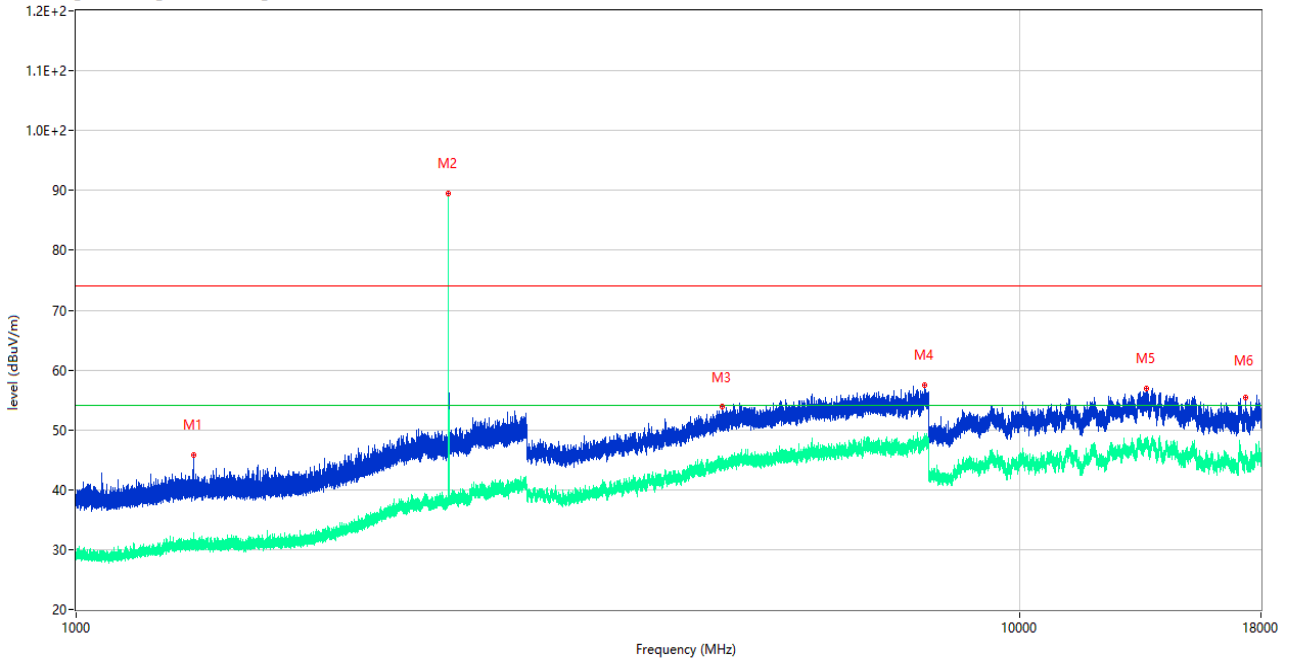

No.	Frequency (MHz)	Results (dBuV/m)	Factor (dB)	Limit (dBuV/m)	Over Limit (dB)	Detector	Table (Degree)	Height (cm)	Antenna	Verdict
1	1332.800	45.85	-16.38	74.0	-28.15	Peak	131.00	150	Vertical	Pass
1**	1332.800	30.54	-16.38	54.0	-23.46	AV	131.00	150	Vertical	Pass
2	2479.800	89.54	-10.98	74.0	15.54	Peak	353.00	150	Vertical	N/A
2**	2479.800	87.87	-10.98	54.0	33.87	AV	353.00	150	Vertical	N/A
3	4840.500	53.85	0.52	74.0	-20.15	Peak	147.00	150	Vertical	Pass
3**	4840.500	43.81	0.52	54.0	-10.19	AV	147.00	150	Vertical	Pass
4	7918.750	57.52	3.48	74.0	-16.48	Peak	256.00	150	Vertical	Pass
4**	7918.750	48.06	3.48	54.0	-5.94	AV	256.00	150	Vertical	Pass
5	13613.000	56.84	4.82	74.0	-17.16	Peak	0.00	150	Vertical	Pass
5**	13613.000	47.07	4.82	54.0	-6.93	AV	0.00	150	Vertical	Pass
6	17346.501	55.44	2.32	74.0	-18.56	Peak	106.00	150	Vertical	Pass
6**	17346.501	45.62	2.32	54.0	-8.38	AV	106.00	150	Vertical	Pass

8-DPSK LOW CHANNEL 1 GHz to 18 GHz, ANT H

RE Test case_FCC Part 15C_FCC 15.247(2.4G)_1GHz-18GHz

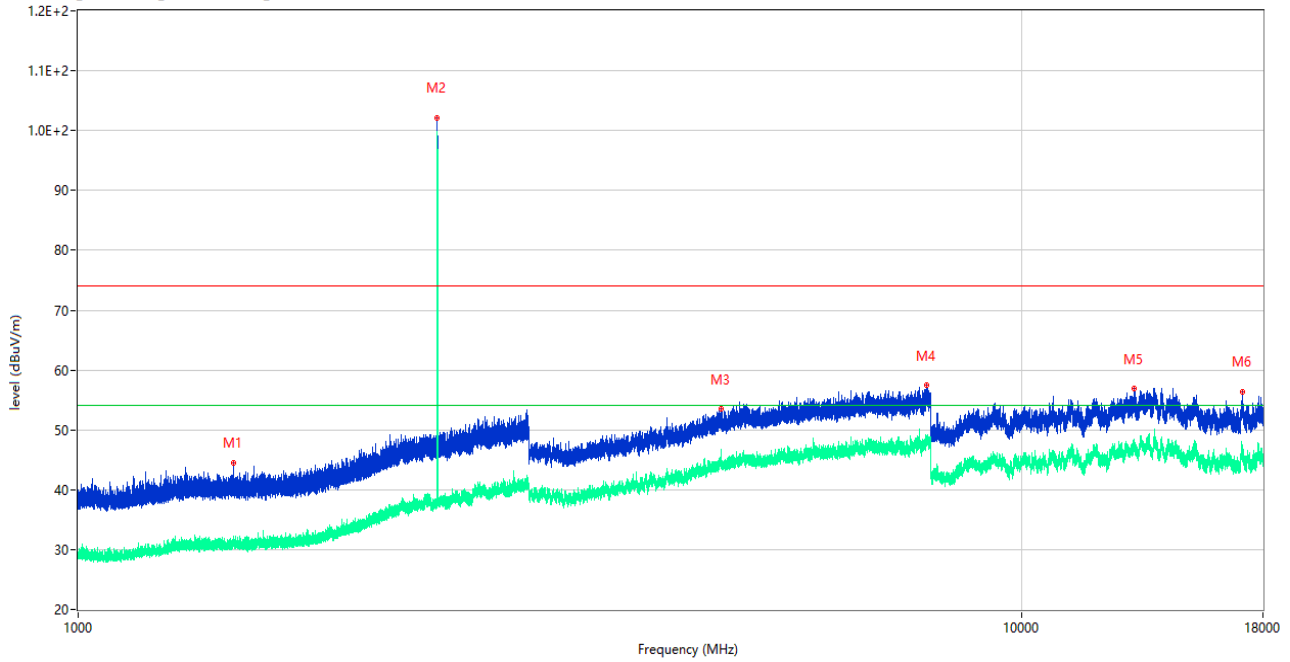

No.	Frequency (MHz)	Results (dBuV/m)	Factor (dB)	Limit (dBuV/m)	Over Limit (dB)	Detector	Table (Degree)	Height (cm)	Antenna	Verdict
1	1461.300	44.57	-16.17	74.0	-29.43	Peak	360.00	150	Horizontal	Pass
1**	1461.300	31.14	-16.17	54.0	-22.86	AV	360.00	150	Horizontal	Pass
2	2402.100	102.07	-11.42	74.0	28.07	Peak	354.00	150	Horizontal	N/A
2**	2402.100	99.81	-11.42	54.0	45.81	AV	354.00	150	Horizontal	N/A
3	4804.250	53.61	0.97	74.0	-20.39	Peak	20.00	150	Horizontal	Pass
3**	4804.250	46.43	0.97	54.0	-7.57	AV	20.00	150	Horizontal	Pass
4	7918.500	57.57	3.48	74.0	-16.43	Peak	207.00	150	Horizontal	Pass
4**	7918.500	48.56	3.48	54.0	-5.44	AV	207.00	150	Horizontal	Pass
5	13141.000	56.95	4.16	74.0	-17.05	Peak	112.00	150	Horizontal	Pass
5**	13141.000	48.17	4.16	54.0	-5.83	AV	112.00	150	Horizontal	Pass
6	17112.500	56.39	3.55	74.0	-17.61	Peak	35.00	150	Horizontal	Pass
6**	17112.500	47.46	3.55	54.0	-6.54	AV	35.00	150	Horizontal	Pass

8-DPSK LOW CHANNEL 1 GHz to 18 GHz, ANT V

RE Test case_FCC Part 15C_FCC 15.247(2.4G)_1GHz-18GHz

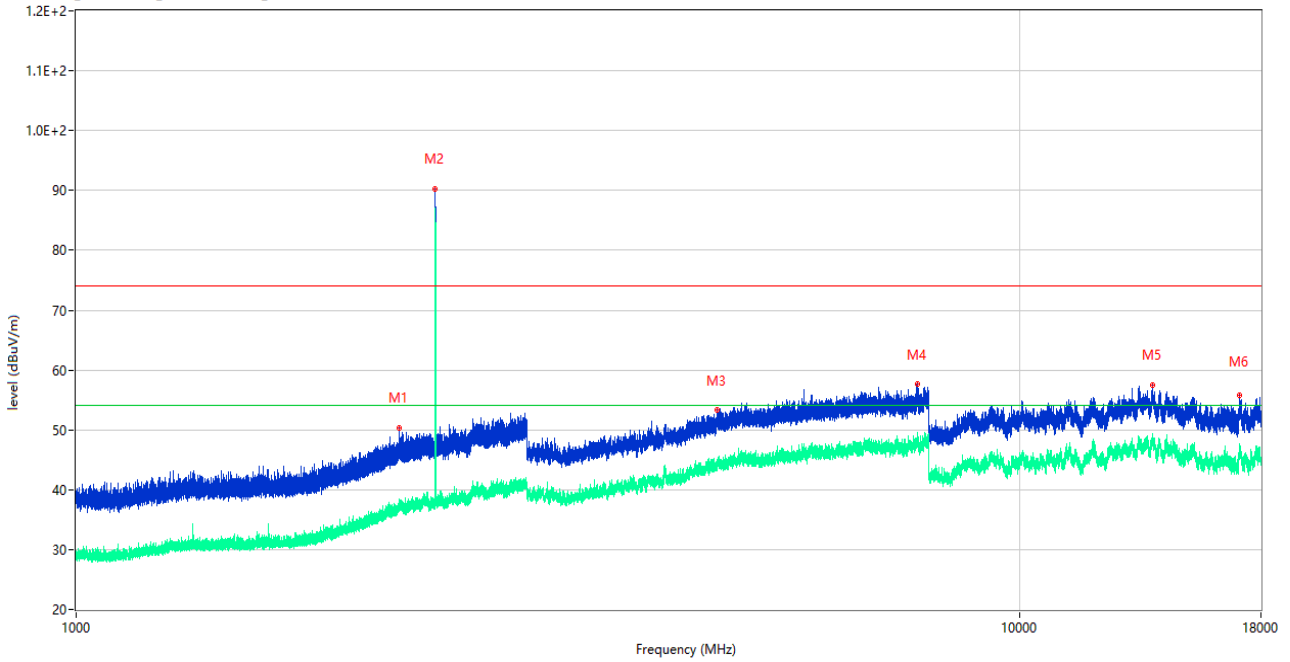

No.	Frequency (MHz)	Results (dBuV/m)	Factor (dB)	Limit (dBuV/m)	Over Limit (dB)	Detector	Table (Degree)	Height (cm)	Antenna	Verdict
1	2199.300	50.25	-11.37	74.0	-23.75	Peak	145.00	150	Vertical	Pass
1**	2199.300	37.30	-11.37	54.0	-16.70	AV	145.00	150	Vertical	Pass
2	2402.100	90.20	-11.42	74.0	16.20	Peak	354.00	150	Vertical	N/A
2**	2402.100	87.07	-11.42	54.0	33.07	AV	354.00	150	Vertical	N/A
3	4772.750	53.30	0.96	74.0	-20.70	Peak	264.00	150	Vertical	Pass
3**	4772.750	44.35	0.96	54.0	-9.65	AV	264.00	150	Vertical	Pass
4	7779.500	57.68	3.70	74.0	-16.32	Peak	256.00	150	Vertical	Pass
4**	7779.500	47.99	3.70	54.0	-6.01	AV	256.00	150	Vertical	Pass
5	13807.500	57.55	5.72	74.0	-16.45	Peak	238.00	150	Vertical	Pass
5**	13807.500	48.65	5.72	54.0	-5.35	AV	238.00	150	Vertical	Pass
6	17091.000	55.77	3.40	74.0	-18.23	Peak	73.00	150	Vertical	Pass
6**	17091.000	45.84	3.40	54.0	-8.16	AV	73.00	150	Vertical	Pass

8-DPSK MIDDLE CHANNEL 1 GHz to 18 GHz, ANT H

RE Test case_FCC Part 15C_FCC 15.247(2.4G)_1GHz-18GHz

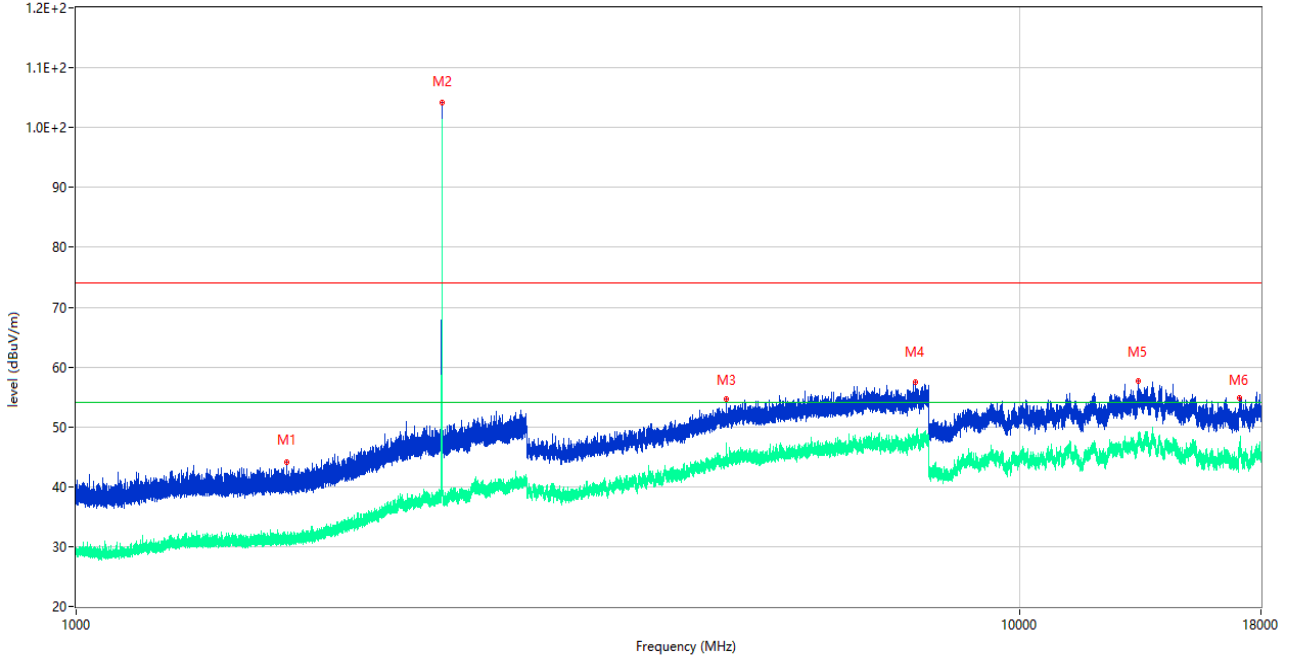

No.	Frequency (MHz)	Results (dBuV/m)	Factor (dB)	Limit (dBuV/m)	Over Limit (dB)	Detector	Table (Degree)	Height (cm)	Antenna	Verdict
1	1670.200	44.05	-16.25	74.0	-29.95	Peak	9.00	150	Horizontal	Pass
1**	1670.200	30.71	-16.25	54.0	-23.29	AV	9.00	150	Horizontal	Pass
2	2441.000	104.10	-11.18	74.0	30.10	Peak	360.00	150	Horizontal	N/A
2**	2441.000	100.97	-11.18	54.0	46.97	AV	360.00	150	Horizontal	N/A
3	4881.750	54.68	0.69	74.0	-19.32	Peak	115.00	150	Horizontal	Pass
3**	4881.750	47.27	0.69	54.0	-6.73	AV	115.00	150	Horizontal	Pass
4	7745.250	57.40	2.87	74.0	-16.60	Peak	349.00	150	Horizontal	Pass
4**	7745.250	48.35	2.87	54.0	-5.65	AV	349.00	150	Horizontal	Pass
5	13353.000	57.67	5.21	74.0	-16.33	Peak	204.00	150	Horizontal	Pass
5**	13353.000	47.71	5.21	54.0	-6.29	AV	204.00	150	Horizontal	Pass
6	17099.000	54.80	3.71	74.0	-19.20	Peak	281.00	150	Horizontal	Pass
6**	17099.000	46.73	3.71	54.0	-7.27	AV	281.00	150	Horizontal	Pass

8-DPSK MIDDLE CHANNEL 1 GHz to 18 GHz, ANT V

RE Test case_FCC Part 15C_FCC 15.247(2.4G)_1GHz-18GHz

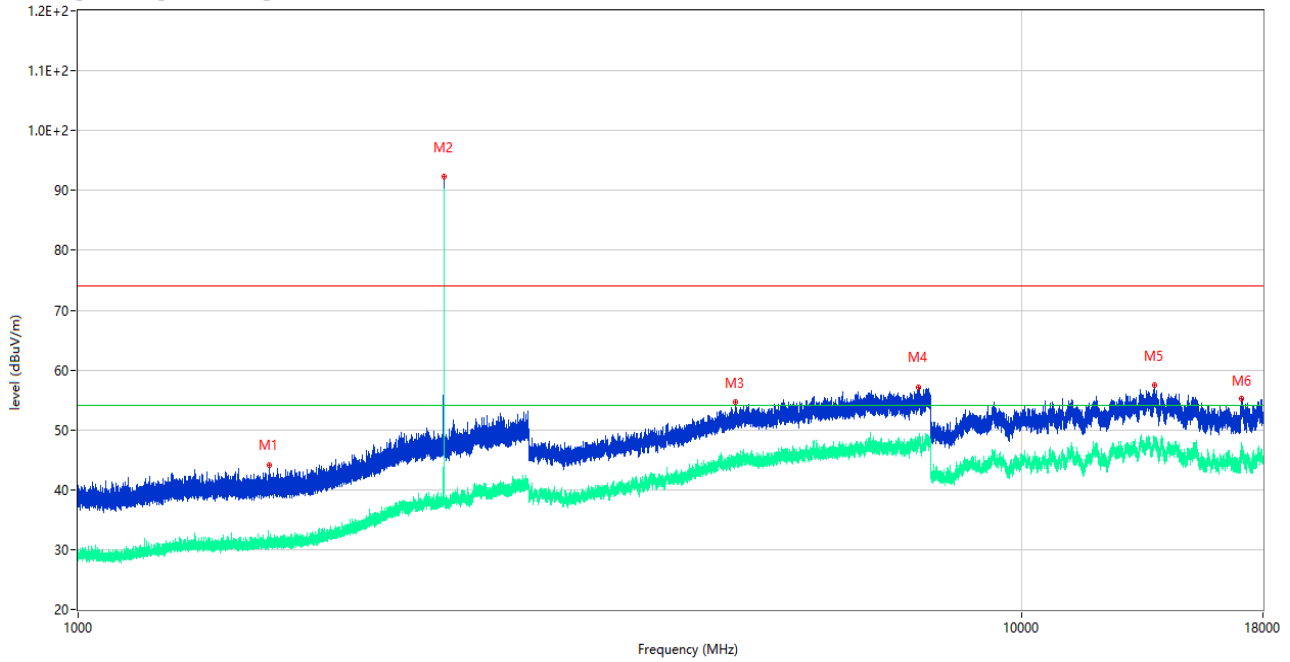

No.	Frequency (MHz)	Results (dBuV/m)	Factor (dB)	Limit (dBuV/m)	Over Limit (dB)	Detector	Table (Degree)	Height (cm)	Antenna	Verdict
1	1594.500	44.07	-16.42	74.0	-29.93	Peak	282.00	150	Vertical	Pass
1**	1594.500	31.12	-16.42	54.0	-22.88	AV	282.00	150	Vertical	Pass
2	2441.000	92.32	-11.18	74.0	18.32	Peak	355.00	150	Vertical	N/A
2**	2441.000	90.18	-11.18	54.0	36.18	AV	355.00	150	Vertical	N/A
3	4969.750	54.63	1.04	74.0	-19.37	Peak	112.00	150	Vertical	Pass
3**	4969.750	44.78	1.04	54.0	-9.22	AV	112.00	150	Vertical	Pass
4	7766.250	57.09	3.08	74.0	-16.91	Peak	11.00	150	Vertical	Pass
4**	7766.250	47.78	3.08	54.0	-6.22	AV	11.00	150	Vertical	Pass
5	13813.500	57.45	5.64	74.0	-16.55	Peak	287.00	150	Vertical	Pass
5**	13813.500	48.29	5.64	54.0	-5.71	AV	287.00	150	Vertical	Pass
6	17094.500	55.28	3.54	74.0	-18.72	Peak	298.00	150	Vertical	Pass
6**	17094.500	47.43	3.54	54.0	-6.57	AV	298.00	150	Vertical	Pass

8-DPSK HIGH CHANNEL 1 GHz to 18 GHz, ANT H

RE Test case_FCC Part 15C_FCC 15.247(2.4G)_1GHz-18GHz

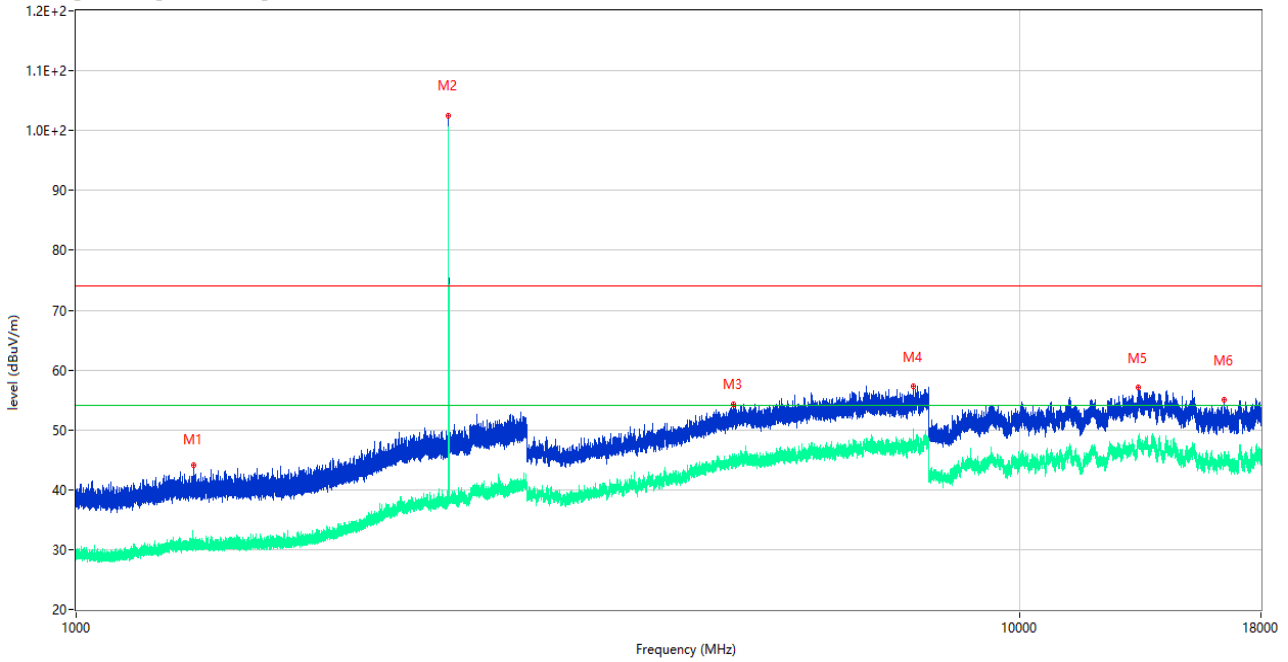

No.	Frequency (MHz)	Results (dBuV/m)	Factor (dB)	Limit (dBuV/m)	Over Limit (dB)	Detector	Table (Degree)	Height (cm)	Antenna	Verdict
1	1333.300	44.06	-16.35	74.0	-29.94	Peak	226.00	150	Horizontal	Pass
1**	1333.300	30.98	-16.35	54.0	-23.02	AV	226.00	150	Horizontal	Pass
2	2479.900	102.46	-10.98	74.0	28.46	Peak	354.00	150	Horizontal	N/A
2**	2479.900	100.65	-10.98	54.0	46.65	AV	354.00	150	Horizontal	N/A
3	4972.000	54.18	0.97	74.0	-19.82	Peak	112.00	150	Horizontal	Pass
3**	4972.000	45.13	0.97	54.0	-8.87	AV	112.00	150	Horizontal	Pass
4	7711.000	57.20	3.48	74.0	-16.80	Peak	360.00	150	Horizontal	Pass
4**	7711.000	50.05	3.48	54.0	-3.95	AV	360.00	150	Horizontal	Pass
5	13344.500	57.13	5.04	74.0	-16.87	Peak	143.00	150	Horizontal	Pass
5**	13344.500	48.15	5.04	54.0	-5.85	AV	143.00	150	Horizontal	Pass
6	16464.500	54.99	1.95	74.0	-19.01	Peak	0.00	150	Horizontal	Pass
6**	16464.500	45.57	1.95	54.0	-8.43	AV	0.00	150	Horizontal	Pass

8-DPSK HIGH CHANNEL 1 GHz to 18 GHz, ANT V

RE Test case_FCC Part 15C_FCC 15.247(2.4G)_1GHz-18GHz

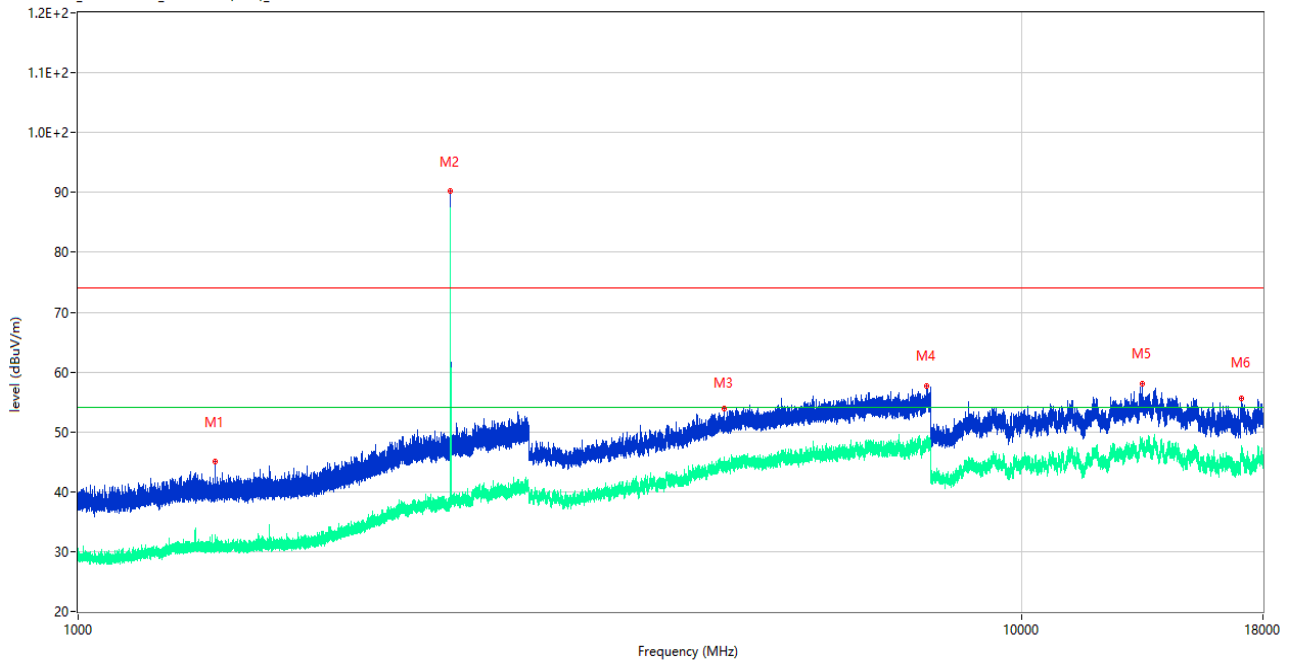

No.	Frequency (MHz)	Results (dBuV/m)	Factor (dB)	Limit (dBuV/m)	Over Limit (dB)	Detector	Table (Degree)	Height (cm)	Antenna	Verdict
1	1396.600	45.09	-16.42	74.0	-28.91	Peak	82.00	150	Vertical	Pass
1**	1396.600	30.27	-16.42	54.0	-23.73	AV	82.00	150	Vertical	Pass
2	2480.100	90.25	-10.96	74.0	16.25	Peak	350.00	150	Vertical	N/A
2**	2480.100	86.77	-10.96	54.0	32.77	AV	350.00	150	Vertical	N/A
3	4831.500	53.99	0.64	74.0	-20.01	Peak	122.00	150	Vertical	Pass
3**	4831.500	43.61	0.64	54.0	-10.39	AV	122.00	150	Vertical	Pass
4	7925.000	57.69	3.50	74.0	-16.31	Peak	38.00	150	Vertical	Pass
4**	7925.000	48.60	3.50	54.0	-5.40	AV	38.00	150	Vertical	Pass
5	13421.500	58.01	4.64	74.0	-15.99	Peak	161.00	150	Vertical	Pass
5**	13421.500	46.94	4.64	54.0	-7.06	AV	161.00	150	Vertical	Pass
6	17084.000	55.61	3.12	74.0	-18.39	Peak	150.00	150	Vertical	Pass
6**	17084.000	46.65	3.12	54.0	-7.35	AV	150.00	150	Vertical	Pass

Hopping Mode:

GFSK MODE 1 GHz to 18 GHz, ANT H

RE Test case_FCC Part 15C_FCC 15.247(2.4G)_1GHz-18GHz

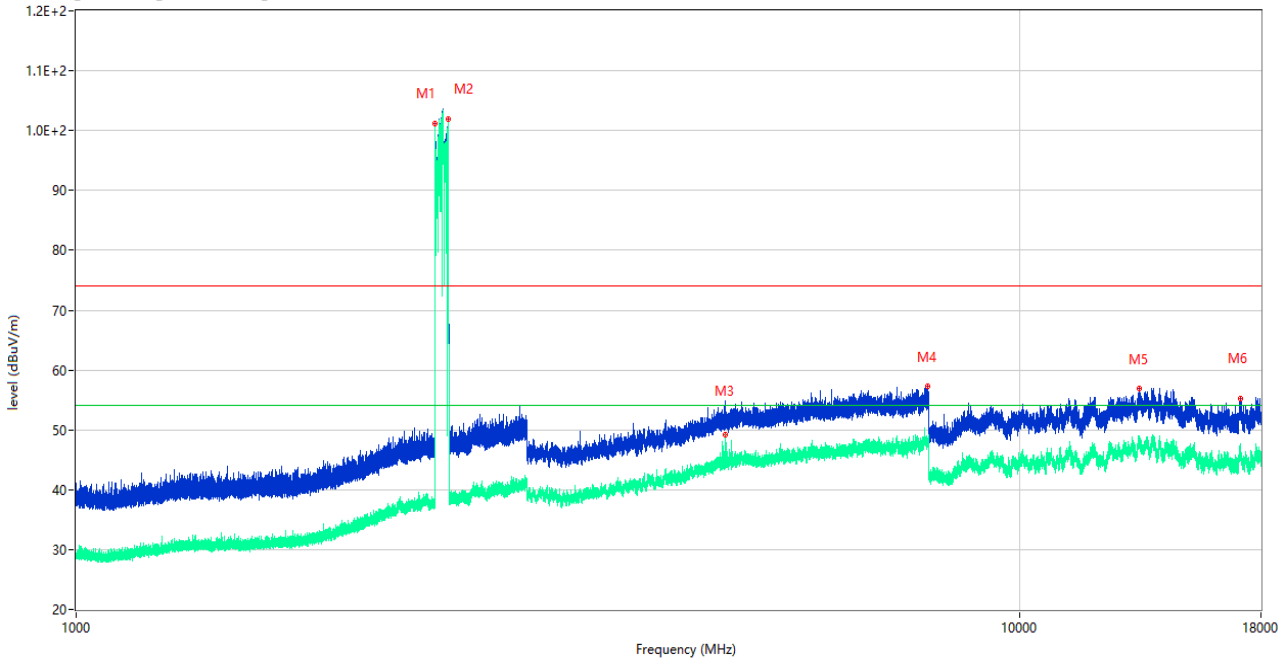

No.	Frequency (MHz)	Results (dBuV/m)	Factor (dB)	Limit (dBuV/m)	Over Limit (dB)	Detector	Table (Degree)	Height (cm)	Antenna	Verdict
1	2402.200	101.08	-11.42	74.0	27.08	Peak	0.00	150	Horizontal	N/A
1**	2402.200	100.37	-11.42	54.0	46.37	AV	0.00	150	Horizontal	N/A
2	2479.800	101.87	-10.98	74.0	27.87	Peak	360.00	150	Horizontal	N/A
2**	2479.800	100.67	-10.98	54.0	46.67	AV	360.00	150	Horizontal	N/A
3	4876.000	52.05	0.67	74.0	-21.95	Peak	194.00	150	Horizontal	Pass
3**	4876.000	49.25	0.67	54.0	-4.75	AV	194.00	150	Horizontal	Pass
4	7974.500	57.26	2.88	74.0	-16.74	Peak	256.00	150	Horizontal	Pass
4**	7974.500	48.25	2.88	54.0	-5.75	AV	256.00	150	Horizontal	Pass
5	13361.500	56.85	5.16	74.0	-17.15	Peak	284.00	150	Horizontal	Pass
5**	13361.500	47.66	5.16	54.0	-6.34	AV	284.00	150	Horizontal	Pass
6	17108.500	55.14	3.61	74.0	-18.86	Peak	29.00	150	Horizontal	Pass
6**	17108.500	46.28	3.61	54.0	-7.72	AV	29.00	150	Horizontal	Pass

GFSK MODE 1 GHz to 18 GHz, ANT V

RE Test case_FCC Part 15C_FCC 15.247(2.4G)_1GHz-18GHz

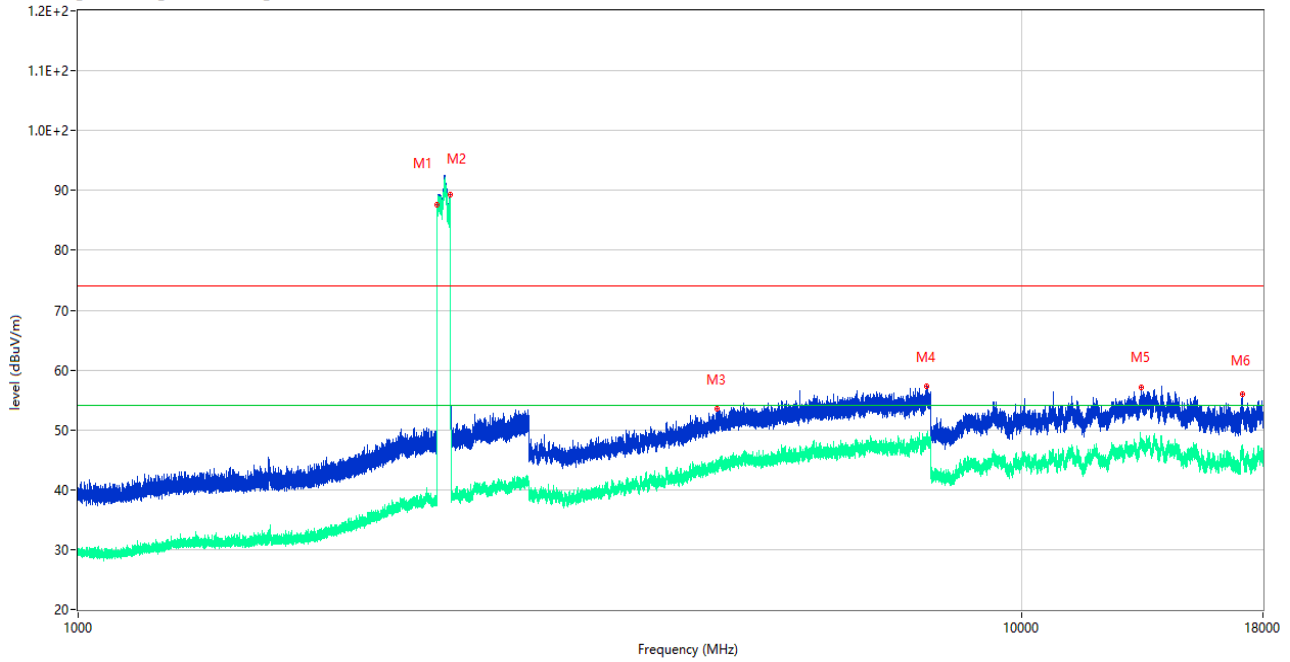

No.	Frequency (MHz)	Results (dBuV/m)	Factor (dB)	Limit (dBuV/m)	Over Limit (dB)	Detector	Table (Degree)	Height (cm)	Antenna	Verdict
1	2401.800	87.55	-11.42	74.0	13.55	Peak	360.00	150	Vertical	N/A
1**	2401.800	86.17	-11.42	54.0	32.17	AV	360.00	150	Vertical	N/A
2	2478.700	89.21	-11.04	74.0	15.21	Peak	344.00	150	Vertical	N/A
2**	2478.700	87.54	-11.04	54.0	33.54	AV	344.00	150	Vertical	N/A
3	4754.750	53.49	-0.06	74.0	-20.51	Peak	81.00	150	Vertical	Pass
3**	4754.750	43.62	-0.06	54.0	-10.38	AV	81.00	150	Vertical	Pass
4	7932.500	57.25	3.61	74.0	-16.75	Peak	297.00	150	Vertical	Pass
4**	7932.500	48.15	3.61	54.0	-5.85	AV	297.00	150	Vertical	Pass
5	13372.000	57.04	5.09	74.0	-16.96	Peak	67.00	150	Vertical	Pass
5**	13372.000	48.24	5.09	54.0	-5.76	AV	67.00	150	Vertical	Pass
6	17115.000	55.97	3.51	74.0	-18.03	Peak	100.00	150	Vertical	Pass
6**	17115.000	45.93	3.51	54.0	-8.07	AV	100.00	150	Vertical	Pass

8-DPSK MODE 1 GHz to 18 GHz, ANT H

RE Test case_FCC Part 15C_FCC 15.247(2.4G)_1GHz-18GHz

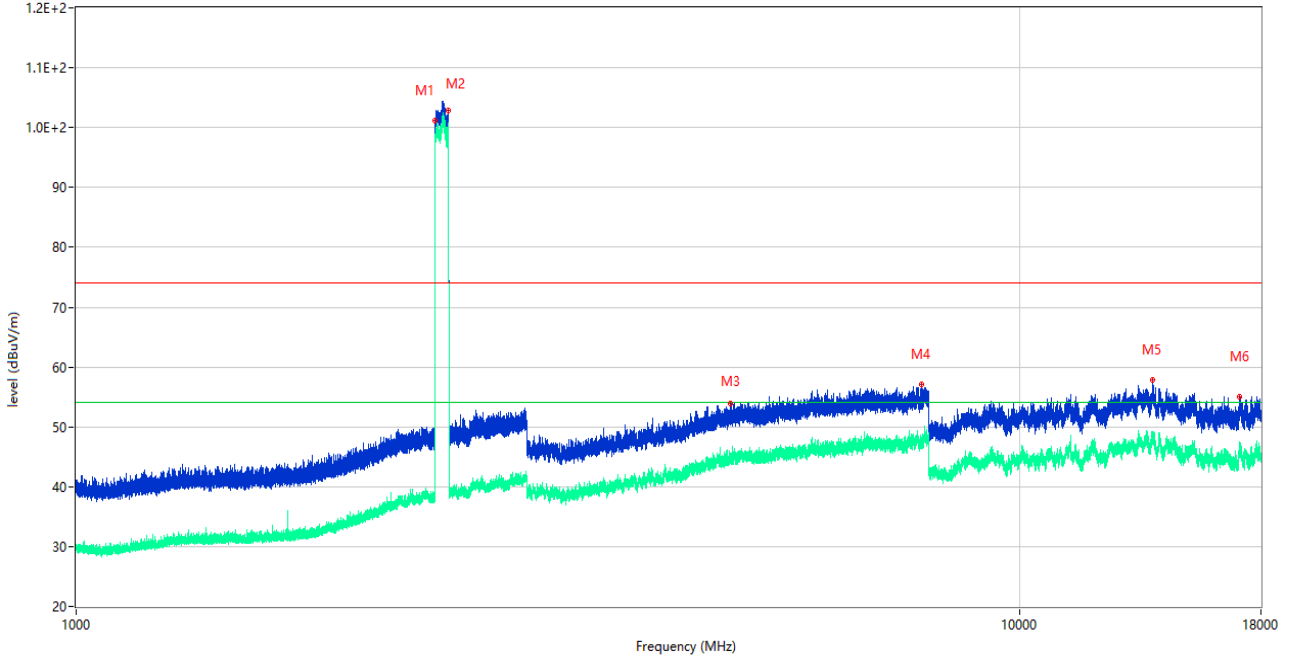

No.	Frequency (MHz)	Results (dBuV/m)	Factor (dB)	Limit (dBuV/m)	Over Limit (dB)	Detector	Table (Degree)	Height (cm)	Antenna	Verdict
1	2401.700	101.16	-11.42	74.0	27.16	Peak	0.00	150	Horizontal	N/A
1**	2401.700	97.91	-11.42	54.0	43.91	AV	0.00	150	Horizontal	N/A
2	2480.000	102.78	-10.97	74.0	28.78	Peak	0.00	150	Horizontal	N/A
2**	2480.000	100.78	-10.97	54.0	46.78	AV	0.00	150	Horizontal	N/A
3	4930.750	53.86	0.96	74.0	-20.14	Peak	262.00	150	Horizontal	Pass
3**	4930.750	44.61	0.96	54.0	-9.39	AV	262.00	150	Horizontal	Pass
4	7870.500	57.01	3.12	74.0	-16.99	Peak	207.00	150	Horizontal	Pass
4**	7870.500	47.58	3.12	54.0	-6.42	AV	207.00	150	Horizontal	Pass
5	13804.500	57.84	5.75	74.0	-16.16	Peak	183.00	150	Horizontal	Pass
5**	13804.500	48.08	5.75	54.0	-5.92	AV	183.00	150	Horizontal	Pass
6	17095.999	55.07	3.60	74.0	-18.93	Peak	217.00	150	Horizontal	Pass
6**	17095.999	45.93	3.60	54.0	-8.07	AV	217.00	150	Horizontal	Pass

8-DPSK MODE 1 GHz to 18 GHz, ANT V

RE Test case_FCC Part 15C_FCC 15.247(2.4G)_1GHz-18GHz

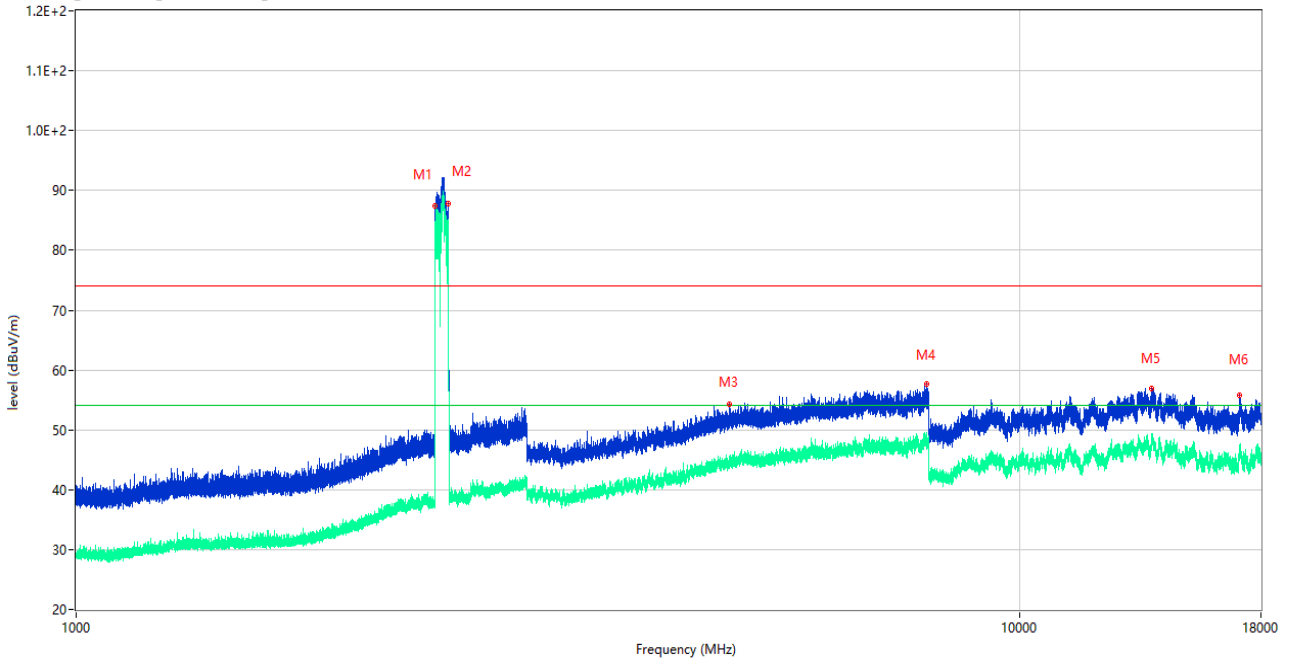

No.	Frequency (MHz)	Results (dBuV/m)	Factor (dB)	Limit (dBuV/m)	Over Limit (dB)	Detector	Table (Degree)	Height (cm)	Antenna	Verdict
1	2401.700	87.46	-11.42	74.0	13.46	Peak	360.00	150	Vertical	N/A
1**	2401.700	83.95	-11.42	54.0	29.95	AV	360.00	150	Vertical	N/A
2	2478.000	87.89	-11.08	74.0	13.89	Peak	336.00	150	Vertical	N/A
2**	2478.000	85.15	-11.08	54.0	31.15	AV	336.00	150	Vertical	N/A
3	4918.750	54.31	0.81	74.0	-19.69	Peak	50.00	150	Vertical	Pass
3**	4918.750	45.37	0.81	54.0	-8.63	AV	50.00	150	Vertical	Pass
4	7959.750	57.64	3.26	74.0	-16.36	Peak	121.00	150	Vertical	Pass
4**	7959.750	47.25	3.26	54.0	-6.75	AV	121.00	150	Vertical	Pass
5	13797.000	57.00	5.68	74.0	-17.00	Peak	100.00	150	Vertical	Pass
5**	13797.000	47.95	5.68	54.0	-6.05	AV	100.00	150	Vertical	Pass
6	17092.500	55.80	3.46	74.0	-18.20	Peak	0.00	150	Vertical	Pass
6**	17092.500	46.58	3.46	54.0	-7.42	AV	0.00	150	Vertical	Pass

A.9 Band Edge (Restricted-band band-edge)

Note¹: The lowest and highest channels are tested to verify the band edge emissions. Please refer to the following the plots for emissions values.

Note²: The test data all are tested in the vertical and horizontal antenna which the trace is max hold. So these plots have shown the worst case.

Note³: According the ANSI C63.10-2013, where limits are specified for both average and peak (or quasi-peak) detector functions, if the peak (or quasi-peak) measured value complies with the average limit, it is unnecessary to perform an average measurement.

Note⁴: The Level (dBuV/m) has been corrected by factor.

Test Data

GFSK LOW CHANNEL

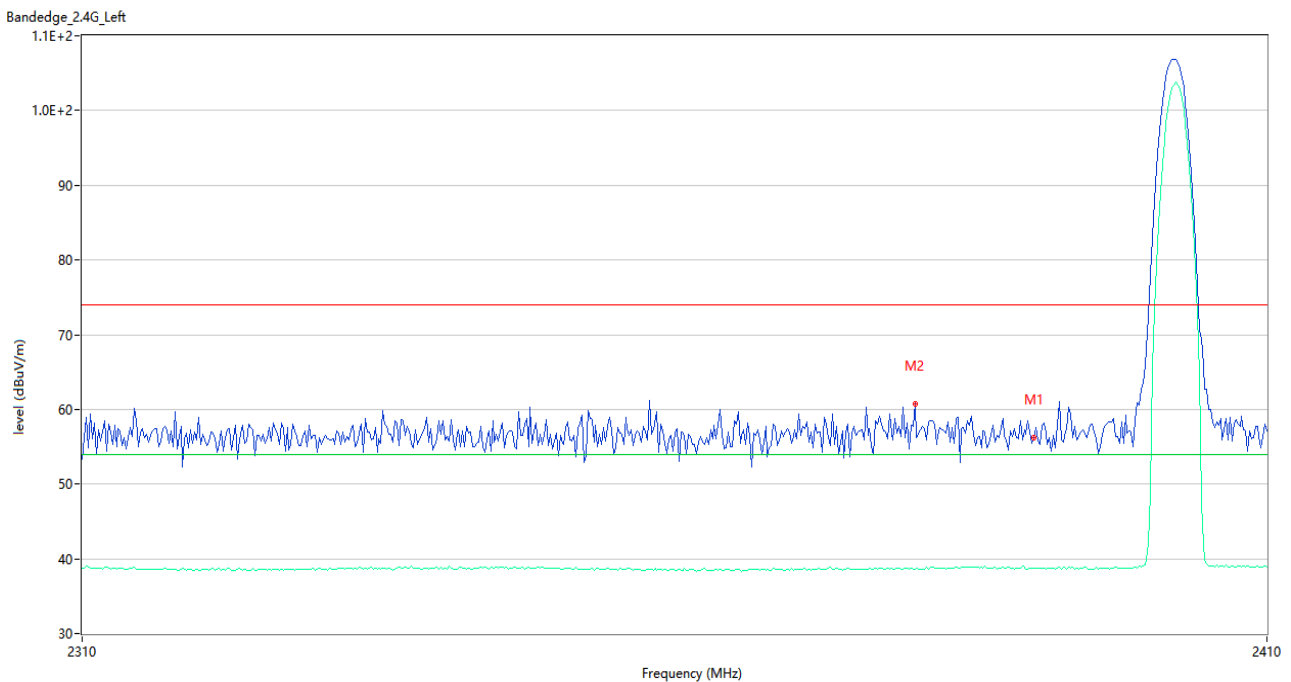

No.	Frequency (MHz)	Results (dBuV/m)	Factor (dB)	Limit (dBuV/m)	Over Limit (dB)	Detector	Table (Degree)	Height (cm)	Antenna	Verdict
1	2390.000	56.21	32.63	74.0	-17.79	Peak	15.00	150	Horizontal	Pass
1**	2390.000	38.74	32.63	54.0	-15.26	AV	15.00	150	Horizontal	Pass
2	2379.833	60.80	32.66	74.0	-13.20	Peak	6.00	150	Horizontal	Pass
2**	2379.833	38.63	32.66	54.0	-15.37	AV	6.00	150	Horizontal	Pass

GFSK HIGH CHANNEL,

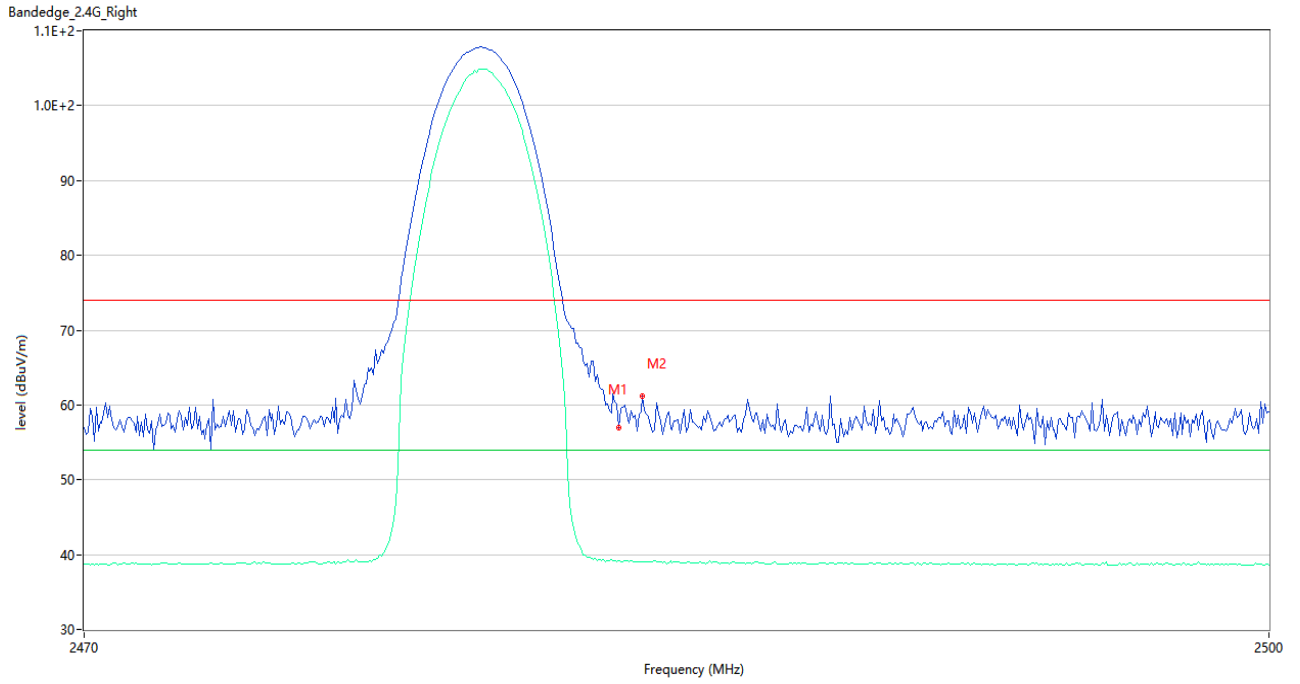

No.	Frequency (MHz)	Results (dBuV/m)	Factor (dB)	Limit (dBuV/m)	Over Limit (dB)	Detector	Table (Degree)	Height (cm)	Antenna	Verdict
1	2483.500	57.04	32.80	74.0	-16.96	Peak	9.00	150	Horizontal	Pass
1**	2483.500	39.17	32.80	54.0	-14.83	AV	9.00	150	Horizontal	Pass
2	2484.100	61.20	32.80	74.0	-12.80	Peak	0.00	150	Horizontal	Pass
2**	2484.100	39.01	32.80	54.0	-14.99	AV	0.00	150	Horizontal	Pass

8-DPSK LOW CHANNEL

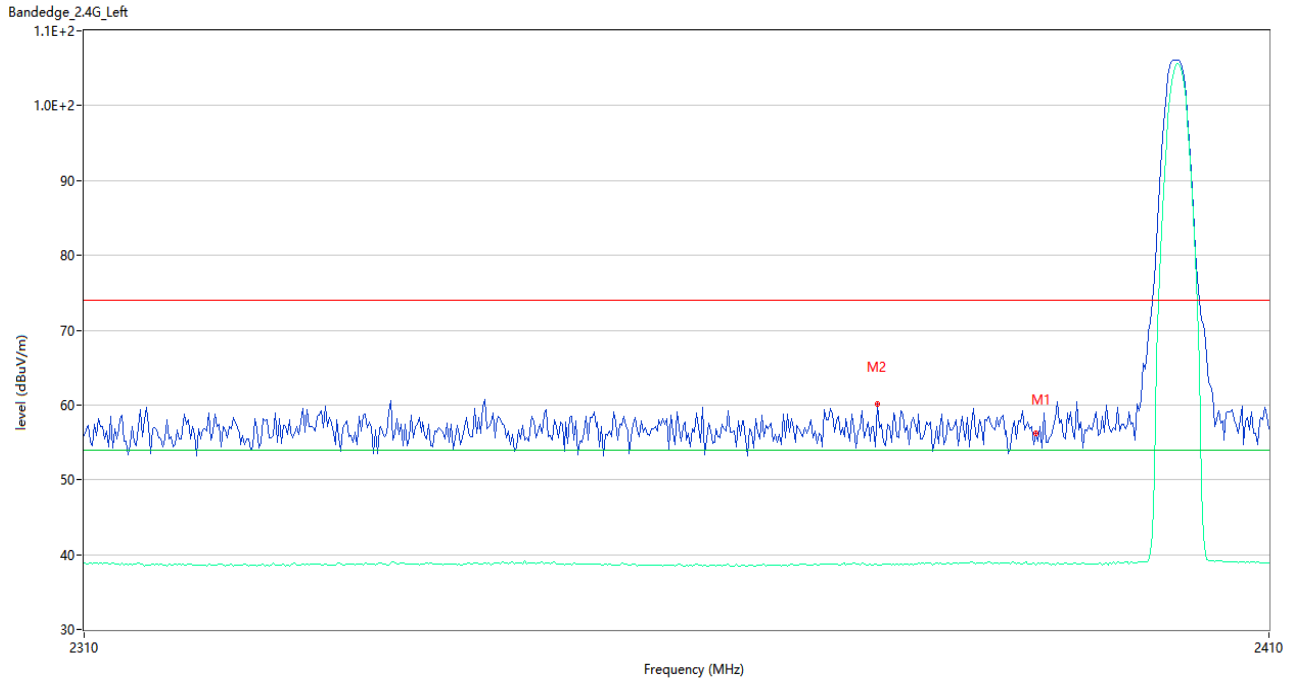

No.	Frequency (MHz)	Results (dBuV/m)	Factor (dB)	Limit (dBuV/m)	Over Limit (dB)	Detector	Table (Degree)	Height (cm)	Antenna	Verdict
1	2390.000	56.18	32.63	74.0	-17.82	Peak	3.00	150	Horizontal	Pass
1**	2390.000	38.66	32.63	54.0	-15.34	AV	3.00	150	Horizontal	Pass
2	2376.500	60.09	32.64	74.0	-13.91	Peak	4.00	150	Horizontal	Pass
2**	2376.500	38.64	32.64	54.0	-15.36	AV	4.00	150	Horizontal	Pass

8-DPSK HIGH CHANNEL

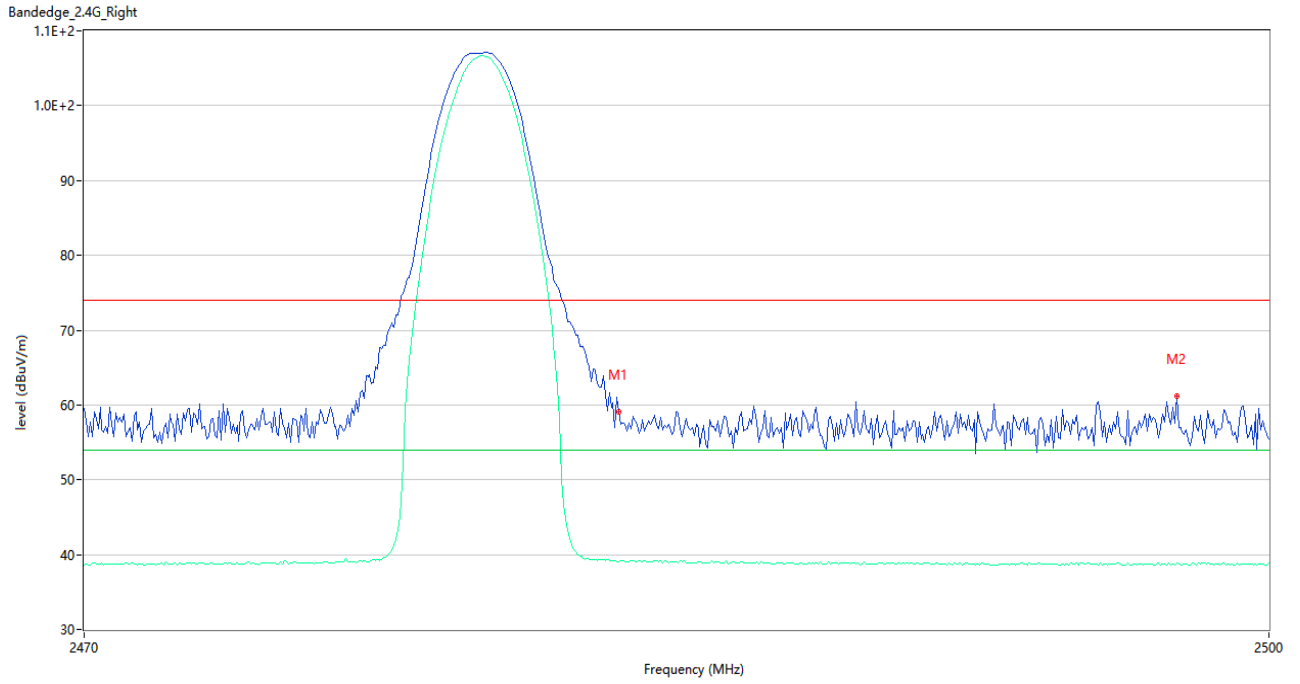

No.	Frequency (MHz)	Results (dBuV/m)	Factor (dB)	Limit (dBuV/m)	Over Limit (dB)	Detector	Table (Degree)	Height (cm)	Antenna	Verdict
1	2483.500	59.04	32.80	74.0	-14.96	Peak	14.00	150	Horizontal	Pass
1**	2483.500	39.04	32.80	54.0	-14.96	AV	14.00	150	Horizontal	Pass
2	2497.650	61.15	32.57	74.0	-12.85	Peak	13.00	150	Horizontal	Pass
2**	2497.650	38.83	32.57	54.0	-15.17	AV	13.00	150	Horizontal	Pass

Hopping Mode:

GFSK LOW FREQUENCY BAND

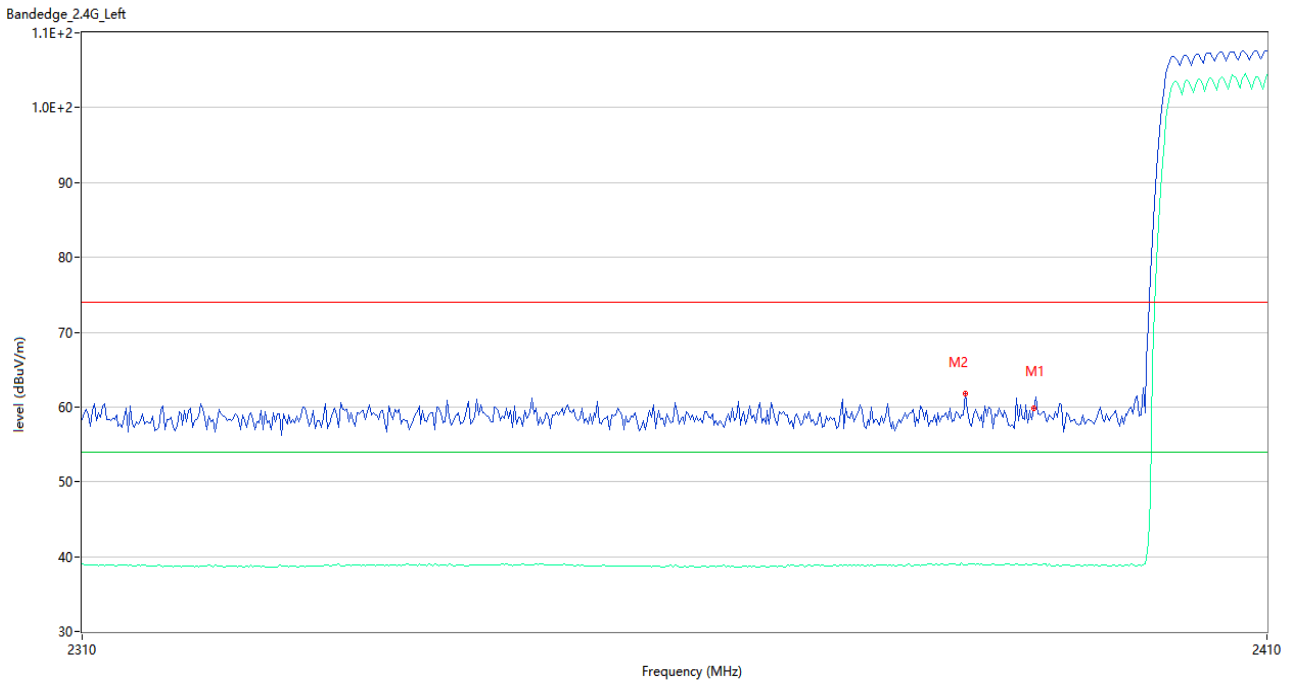

No.	Frequency (MHz)	Results (dBuV/m)	Factor (dB)	Limit (dBuV/m)	Over Limit (dB)	Detector	Table (Degree)	Height (cm)	Antenna	Verdict
1	2390.000	59.81	32.63	74.0	-14.19	Peak	1.00	150	Horizontal	Pass
1**	2390.000	38.99	32.63	54.0	-15.01	AV	1.00	150	Horizontal	Pass
2	2384.167	61.81	32.74	74.0	-12.19	Peak	1.00	150	Horizontal	Pass
2**	2384.167	38.92	32.74	54.0	-15.08	AV	1.00	150	Horizontal	Pass

GFSK HIGH FREQUENCY BAND,

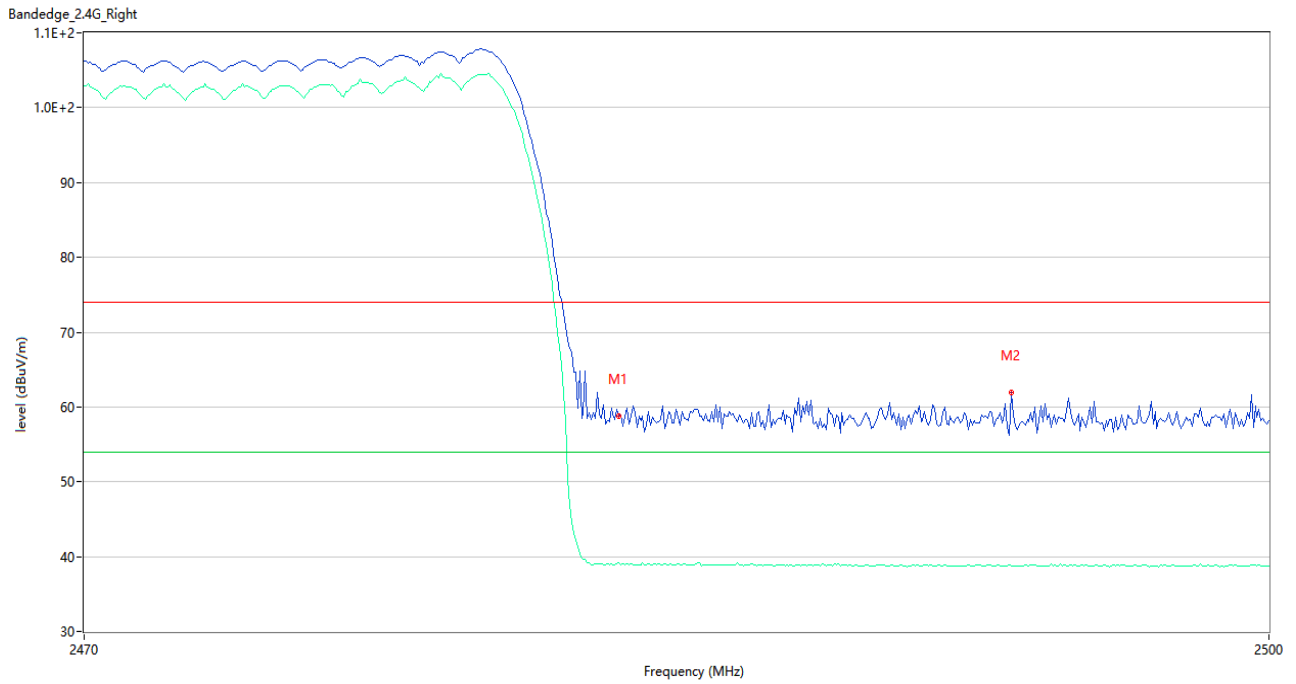

No.	Frequency (MHz)	Results (dBuV/m)	Factor (dB)	Limit (dBuV/m)	Over Limit (dB)	Detector	Table (Degree)	Height (cm)	Antenna	Verdict
1	2483.500	58.76	32.80	74.0	-15.24	Peak	5.00	150	Horizontal	Pass
1**	2483.500	39.19	32.80	54.0	-14.81	AV	5.00	150	Horizontal	Pass
2	2493.450	61.95	32.61	74.0	-12.05	Peak	5.00	150	Horizontal	Pass
2**	2493.450	38.77	32.61	54.0	-15.23	AV	5.00	150	Horizontal	Pass

8-DPSK LOW FREQUENCY BAND



No.	Frequency (MHz)	Results (dBuV/m)	Factor (dB)	Limit (dBuV/m)	Over Limit (dB)	Detector	Table (Degree)	Height (cm)	Antenna	Verdict
1	2390.000	58.68	32.63	74.0	-15.32	Peak	1.00	150	Horizontal	Pass
1**	2390.000	39.01	32.63	54.0	-14.99	AV	1.00	150	Horizontal	Pass
2	2361.333	62.29	32.58	74.0	-11.71	Peak	1.00	150	Horizontal	Pass
2**	2361.333	38.88	32.58	54.0	-15.12	AV	1.00	150	Horizontal	Pass

8-DPSK HIGH FREQUENCY BAND

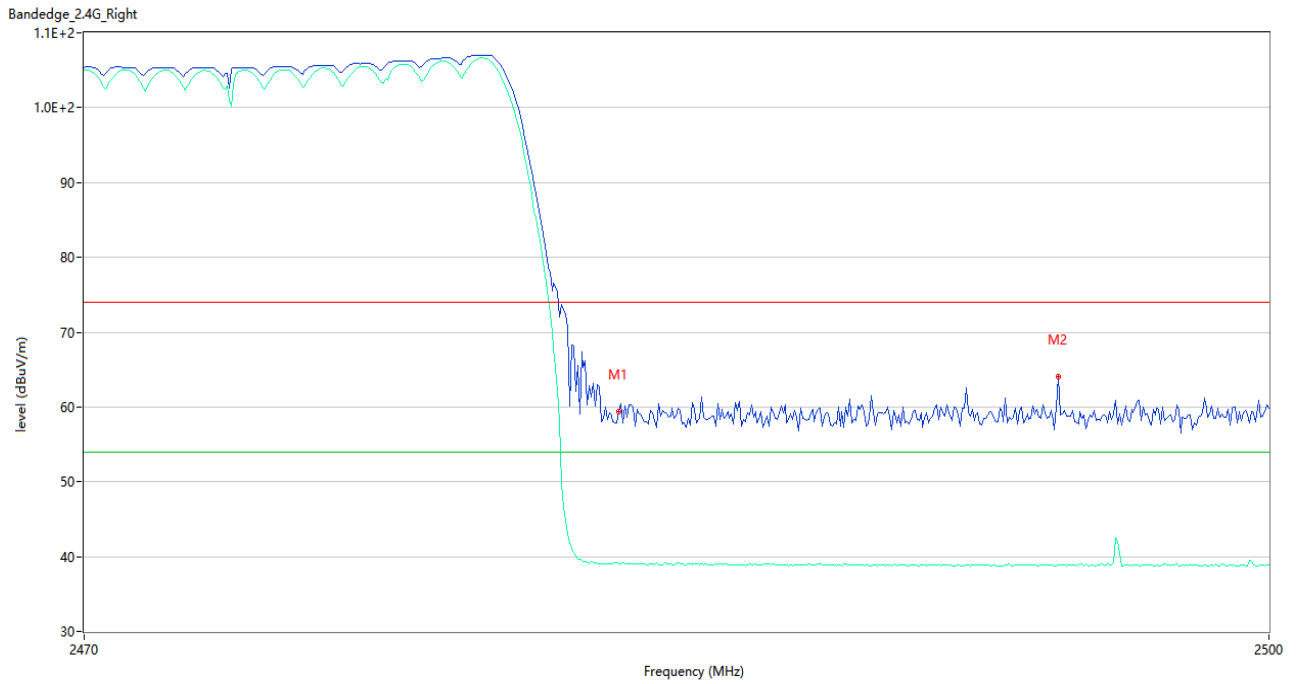

No.	Frequency (MHz)	Results (dBuV/m)	Factor (dB)	Limit (dBuV/m)	Over Limit (dB)	Detector	Table (Degree)	Height (cm)	Antenna	Verdict
1	2483.500	59.31	32.80	74.0	-14.69	Peak	3.00	150	Horizontal	Pass
1**	2483.500	38.99	32.80	54.0	-15.01	AV	3.00	150	Horizontal	Pass
2	2494.650	64.08	32.61	74.0	-9.92	Peak	3.00	150	Horizontal	Pass
2**	2494.650	38.86	32.61	54.0	-15.14	AV	3.00	150	Horizontal	Pass

ANNEX B TEST SETUP PHOTOS

Please refer the document "BL-SZ2181089-AR.PDF".

ANNEX C EUT EXTERNAL PHOTOS

Please refer the document "BL-SZ2181089-AW.PDF".

ANNEX D EUT INTERNAL PHOTOS

Please refer the document "BL-SZ2181089-AI.PDF".

--END OF REPORT--