

## US\_F16\_FL\_994\_IM\_A Size: A5 ( 1c )



5F63ECA



**FLX SKY-I DRONE™**

**8+**



CONFORMS TO THE SAFETY REQUIREMENTS OF ASTM F947

Do not use old and new batteries. Do not mix alkaline, standard carbon zinc, or rechargeable batteries.

FASTLANE IS A MARK OF EST. THE MARQUE DÉPOSÉE EN MARQUE DE (GEOPREY, LLC, A SUBSIDIARY OF THE BROS. JOHN JOHNSON & COMPANY, INC. © 2016 GEOPREY, LLC. NOT TO BE REPRODUCED OR TRANSMITTED IN ANY FORM OR BY ANY MEANS, ELECTRONIC OR MECHANICAL, INCLUDING PHOTOCOPYING, RECORDING, OR BY ANY INFORMATION STORAGE AND RETRIEVAL SYSTEM. IMPORTED BY AMERICA'S PREMIER TOYS, INC. 10000 W. 10TH AVE. DENVER, CO 80202. DISTRIBUTED IN AUSTRIA BY GEOPREY IN AUSTRIA. IMPORTED AND DISTRIBUTED IN AUSTRIA FOR TOYSRUS INTERNATIONAL AUSTRIA BY TOYSRUS. INTERNET: WWW.TSR.COM

## Introduction

This Drone is an easy-to-fly, multifunction remote-control model that can hover, flip and fly in all directions and under different flight modes (Beginner, Intermediate and Advanced). Please read this manual carefully before operating this product.

## 1. Contents

- Drone with camera x 1
- Remote control x 1 (Requires 6 x AA batteries - not included)
- 4.3" LCD screen for FPV x 1
- USB cable for battery charging x 1
- Data cable for SD card reading + LCD screen charging x 1
- 4GB SD card x 1
- Screwdriver x 1
- Blades x 4

## 2. Transmitter

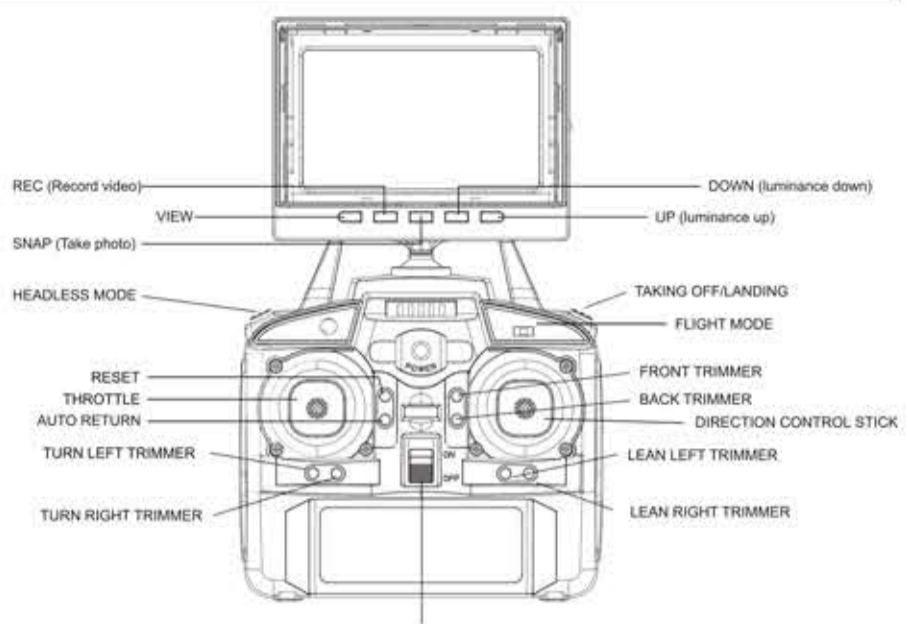

2

## Battery installation

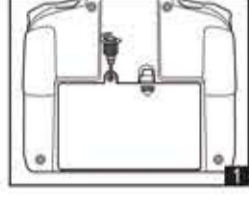

1. Open the cover using screwdriver.

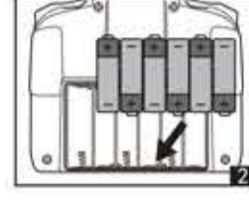

2. Install 6x AA batteries, following the correct polarities.

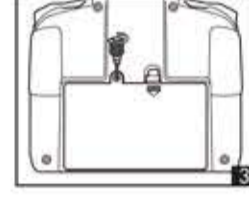

3. Close the cover

### Note:

- Non-rechargeable batteries should not be recharged.
- Only batteries of the same or equivalent type as recommended should be used.
- Batteries should be inserted with the correct polarity.
- Exhausted batteries should be removed from the toy.
- Do not mix the old and new batteries.
- Please remove batteries when they are not in use.

## 3. Battery Charging of the Drone



1. Push the Drone's switch to "OFF".



2. Unscrew the screw of battery lid with the screwdriver (included in the accessory bag)



3. Press the battery lid of Drone; push it backwards and then open the battery lid.



4. Pull out the battery wire from the power port.

3



4. Connect the battery plug to the matching plug on the included USB charger, then connect the USB charger to a USB power source, such as powered-on computer. When battery is charging, LED light is "ON"; when fully charged, LED light is "OFF". Charging time is about 100-120 minutes.

### Caution:

- Do not use or leave the battery near a heat source such as fire. This could cause damage.
- The battery can only be charged with the included USB cable.
- Do not disassemble the battery.
- Never leave the battery unattended during charging.

## 4. Battery charging of the LCD screen

Charge the LCD screen using the matching included USB cable. The indicator light on the LCD will turn red when charging and turn off when fully charged. Charging time is about 30-40 minutes.

Note: Indicator light on LCD will flash when LCD is low on battery, user should turn off LCD before charging.

## 5. Ready to fly



1. Open the battery lid and insert the battery connector into power port of the Drone.



2. Rescrew the battery lid and turn "ON" the Drone's switch. Next, make sure to place the Drone in a horizontal position. Do not move the Drone when indicator light is flashing.

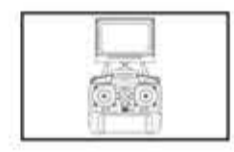

3. Turn on power switch of remote and push the left throttle stick up and down. Once frequency has successfully paired, it will "beep" twice and the LED lights will stop flashing. Drone is now ready to fly.

4

### TIPS:

1. Keep the Drone in the horizontal position before flight.
2. Indoor flight: Please select spacious areas without obstacles, pets, or people.
3. Outdoor flight: Please select a warm, sunny day with no wind or breeze.

### Note:

1. Don't fly in extreme heat or cold, this could affect flight or damage the model.
2. Don't fly in strong wind, this could limit your flight or hinder flight control. In the case of strong wind, your Drone could become lost or damaged.

## 6. Taking off and auto hovering/landing

### 1) Taking off and auto hovering

Upon pairing, press the taking off/landing button to make the blades rotate, then raise the left throttle/control stick to a certain position, causing the Drone to hover in the air. You do not need to control the throttle once it stabilizes.

2) Landing: Press the taking off/landing button and wait 2 seconds to allow the Drone to slowly auto drop for landing.

## 7. Control method

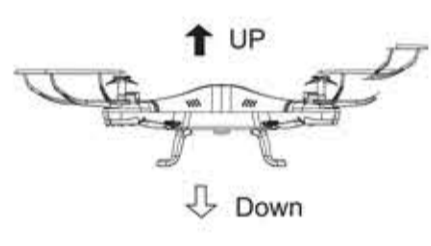
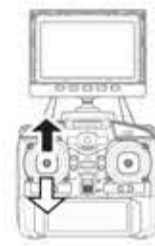

Pushing the left control stick forward or backward will move the Drone up or down.

5

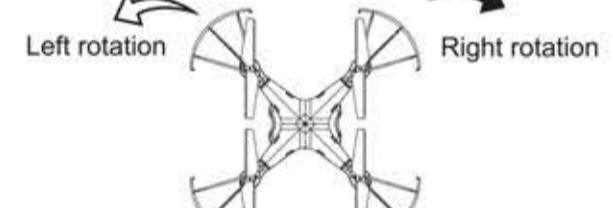
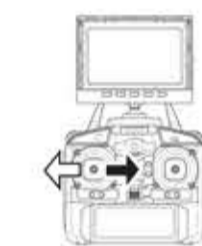

Pushing the left control stick to the left or right will make the Drone rotate left or right.

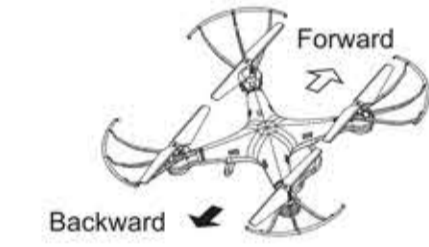
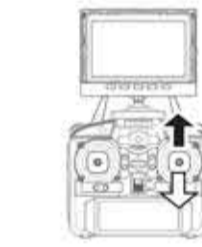

Pushing the right control stick forward and backward will move the Drone forward or backward.

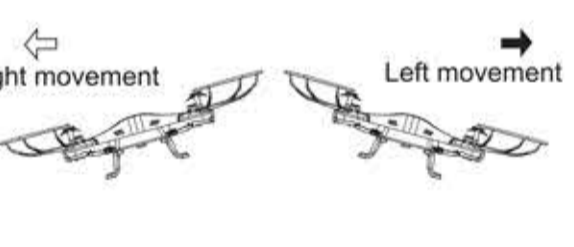
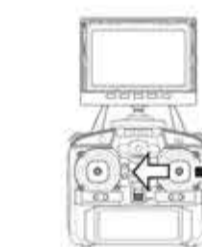

Pushing the right control stick to the left or right will make the Drone lean left or right.

6

## Trim Adjustment

Even after the Drone is calibrated, it may show a tendency to drift while airborne. Adjusting the trim will counter this effect and allow the unit to hover in place. Adjust the trim while flying in control and as low to the ground as possible. If the trim adjustments do not seem to be helping, or seem to be making the problem worse, press the **Reset Button** to the right of the **Left Control Stick** to reset the trim to factory-default settings and try again.

### Lean Trimmer

When the Drone leans to the left or right side during flight, you can adjust it by pressing the LEAN L/R trimming buttons on the remote. Note: If Drone leans to the right, you must press the L LEAN button and if Drone leans to the left, you must press the R LEAN button.

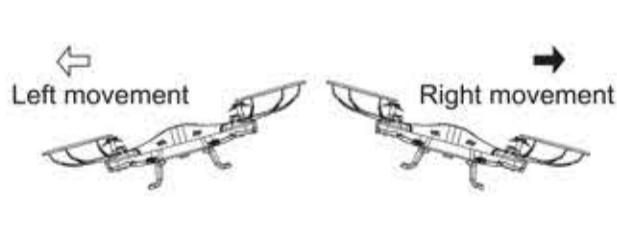

### Turn Trimmer

When the Drone rotates left or right during flight, you can adjust by pressing the TURN L/R trimming buttons on the remote. Note: If Drone rotates to the right, you must press the L TURN button and if Drone rotates to the left, you must press the R TURN button.

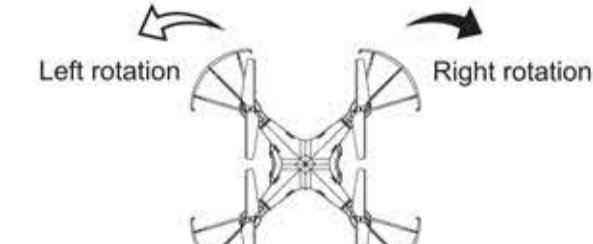

7

## Forward and Backward Trimmer.

When the Drone flies forward or backward, you can adjust by pressing the FRONT / BACK trimming buttons. Note: If Drone flies forward, you must press the BACK button and if Drone flies backward, you must press the FRONT button.

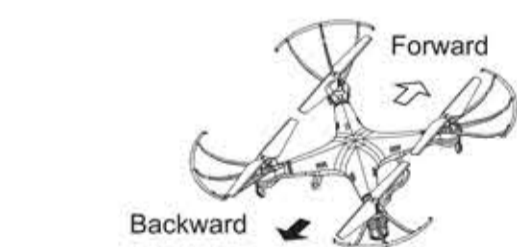

## 8. Flight Mode



The Drone has three flight modes: 30%, 60%, and 100%. The higher settings allow faster and more precise control inputs. It is recommended to start with the lowest setting, and as you become more skilled at flying, increase the sensitivity as you wish.

- 30%: Intended for beginner pilots. This gives a smooth, more relaxed control feel.
- 60%: Intended for intermediate pilots. The Drone will move and respond much faster to all control inputs.
- 100%: Intended for advanced pilots. The Drone will be the fastest and most sensitive to all inputs.

## 9. Flips

To set the Drone into flip mode, press down the right control stick until it beeps. Operate the right control stick forward, backward, left or right, to flip the Drone in each of these directions. Do not attempt to do a flip unless the Drone is 4 feet (1.2 meters) high, to avoid any potential damage.

8

### Left flip

To make the Drone flip one full circle to the left, press down the right control stick until it beeps, then push the stick to the left.



### Right flip

To make the Drone flip one full circle to the right, press down the right control stick until it beeps, then push the stick to the right.



### Forward flip

To make the Drone flip one full circle forward, press down the right control stick until it beeps, then push the stick forward.

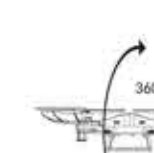

### Backward flip

To make the Drone flip one full circle backward, press down the right control stick until it beeps, then push the stick backward.

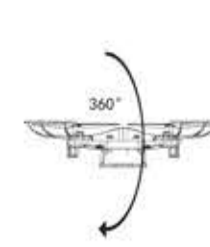

## 10. Reset function



To set the Drone back to its default factory setting, press the reset button.

## 11. Headless mode



1). Turning on headless mode: In headless mode, the Drone has the ability to fly from your viewpoint regardless of its orientation. Upon pairing, place the Drone on the ground or keep it hovering in the air, then press the headless mode button. The Drone will go into headless mode, now you can fly it away from you by pushing down the right lever and fly it away from you by pulling up the right lever. Turning off headless mode: Press the headless mode button again to exit out of this function.

## 12. Auto Return:



Press the auto return button and the Drone will return to you automatically, but make sure not to move. Once the drone is close to you, press the auto return button once again to stop the Drone in its place.

10

### Left flip

To make the Drone flip one full circle to the left, press down the right control stick until it beeps, then push the stick to the left.



### Right flip

To make the Drone flip one full circle to the right, press down the right control stick until it beeps, then push the stick to the right.



### Forward flip

To make the Drone flip one full circle forward, press down the right control stick until it beeps, then push the stick forward.

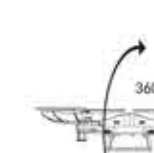

### Backward flip

To make the Drone flip one full circle backward, press down the right control stick until it beeps, then push the stick backward.

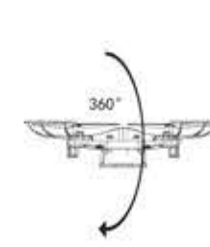

## 10. Reset function



To set the Drone back to its default factory setting, press the reset button.

## 11. Headless mode



1). Turning on headless mode: In headless mode, the Drone has the ability to fly from your viewpoint regardless of its orientation. Upon pairing, place the Drone on the ground or keep it hovering in the air, then press the headless mode button. The Drone will go into headless mode, now you can fly it away from you by pushing down the right lever and fly it away from you by pulling up the right lever. Turning off headless mode: Press the headless mode button again to exit out of this function.

## 12. Auto Return:



Press the auto return button and the Drone will return to you automatically, but make sure not to move. Once the drone is close to you, press the auto return button once again to stop the Drone in its place.

10

9



## 13. LCD Screen and Camera Use

. Connect the camera underneath the Drone and ensure the camera plug is secure to its body. (4GB Micro SD Card must be placed in the camera slot). Next, turn on the Drone and LCD screen. Once the Drone and LCD screen have paired you will be able to watch the video on screen in real time.

1). Recording videos or pictures:

- Install SD card into the slot on the back of the camera.
- Turn on LCD screen and Drone.
- Press the "REC" button to record your video. Note: The word "REC" word will flicker in red on the screen. This indicates that it is recording a video. Press "REC" again to stop recording.
- Press the "SNAP" button to take a picture Note: The word "JPG" will appear on the screen. This indicates that it is taking a picture.

2). Viewing videos and pictures on LCD screen:

- Remove SD card from the camera and insert into the card slot on the LCD screen, noting the correct direction. Do not force it in; it will not fit in the opposite direction.
- Turn on the screen, then press "VIEW" to view videos and pictures.

3). Uploading Images and Videos to computer

- When SD card is inserted in the camera under Drone, you can upload images and videos to your computer by connecting USB cable to micro port in camera ( see image 1)
- When SD card is inserted in the LCD slot, you can upload images and videos to your computer by connecting USB cable to micro port in LCD. (see image 2)

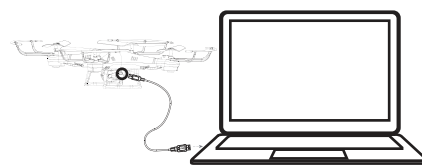

Image 1

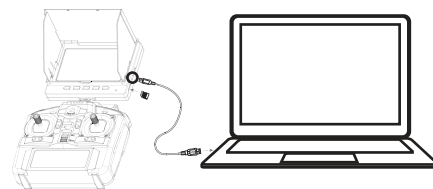

Image 2

## 14. Troubleshooting

1. Transmitter cannot control the Drone.

Solution: Make sure that pairing is successful.

2. Gyro doesn't work well.

Solution 1): Battery voltage is too low. Replace the battery with a new one.

2): Re-pair

3): Make sure the Drone is in the horizontal position.

3. Unable to flip.

Solution: check if battery power is too low and needs to be recharged.

4. Drone is shacking with noise.

Solution: Check to make sure the motors, shell, case and propellers are all properly installed.

5. Drone doesn't take off.

Solution 1): check whether the installation of blades is correct or not.

2): Make sure Drone's shell is not loose.

3): Make sure Drone's battery is fully charged.

6. Blades get damaged after a crash

Solution: replace them with the spare blades in the accessories bag.

To replace a blade, use a small Phillips-head screwdriver (included in the Accessories bag) and remove the screw connecting the blade to the electric motor shaft. Remove the damaged blade and replace with a new one, then screw it back into place on the motor shaft.

**REMINDER: It is extremely important to use the correct blade (A or B) for replacement. Using the incorrect blade will cause the drone's flight to be erratic and impossible to control.**

**Follow the marking on the top of the blade.**

See image below

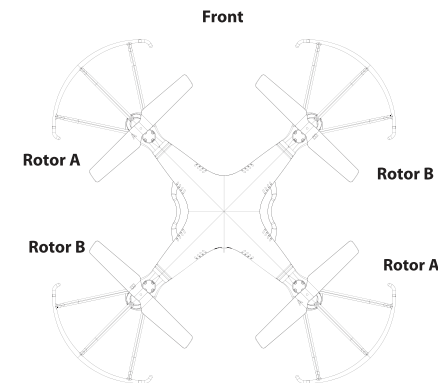

**Warning:**

**Please fly away from obstructions such as people, buildings, high-voltage power lines, etc.. Also avoid flying during extreme weather conditions such as rain, hail, sleet, snow, thunder or heavy winds.**

This device complies with Part 15 of the FCC Rules.

Operation is subject to the following two conditions:

(1) this device may not cause harmful interference, and

(2) this device must accept any interference received,

including interference that may cause undesired operation.

CAUTION: changes or modifications not expressly approved by the party responsible for compliance could void the user's authority to operate the equipment.

NOTE: This equipment has been tested and found to comply with the limits for a Class B digital device, pursuant to Part 15 of the FCC Rules. These limits are designed to provide reasonable protection against harmful interference in a residential installation. This equipment generates, uses and can radiate radio frequency energy and, if not installed and used in accordance with the instructions, may cause harmful interference to radio communications. However, there is no guarantee that interference will not occur in a particular installation. If this equipment does cause harmful interference to radio or television reception, which can be determined by turning the equipment off and on, the user is encouraged to try to correct the interference by one or more of the following measures:

-Reorient or relocate the receiving antenna.

-Increase the separation between the equipment and receiver.

-Connect the equipment into an outlet on a circuit different from that to which the receiver is connected.

-Consult the deal or experienced radio /TV technician for help.

