



FALCON *PRO*

QUADCOPTER DRONE WITH VIDEO CAMERA

User's Guide for Model DRC376R v1648-01

Warnings & Precautions

Important Safety Instructions

- Read and follow all instructions.
- Keep these instructions for future reference.
- Heed all Warnings.
- Intended for children ages 14 and higher. Adult supervision is required.
- Only use attachments/accessories specified by the manufacturer.
- Before flying, always check the body, rotors, and battery for any damage or obstructions.
- Battery should be free from cracks or swelling.
- Keep the rotors clear of any obstructions and body parts to avoid potential damage and injury.
- Manufacturer and dealer assume no liability for accidental damages from improper use or installation of parts, or from damage incurred from worn or broken parts.
- Pilots are responsible for their actions and any damage caused from improper use.
- Pilots should keep the craft in sight at all times during flight. If you lose sight of the craft at any time, power down and cease flight immediately.
- Only fly in large, open areas that are free from obstacles or potential hazards, such as trees, power lines, ceiling fans, and the like.
- Flying over bodies of water is not recommended.
- Flying at night is not recommended.
- Never try to retrieve the craft from areas you cannot safely reach, such as rooftops or trees.
- Never launch the craft from your hand.
- Never leave the craft unattended while it is powered on or while the battery is charging.

FCC Warnings

Warning: Changes or modifications to this unit not expressly approved by the party responsible for compliance could void the user's authority to operate the equipment.

NOTE: This equipment has been tested and found to comply with the limits for a Class B digital device, pursuant to Part 15 of the FCC Rules. These limits are designed to provide reasonable protection against harmful interference in a residential installation. This equipment generates, uses, and can radiate radio frequency energy and, if not installed and used in accordance with the instructions, may cause harmful interference to radio communications. However, there is no guarantee that interference will not occur in a particular installation. If this equipment does cause harmful interference to radio or television reception, which can be determined by turning the equipment off and on, the user is encouraged to try to correct the interference by one or more of the following measures:

- Reorient or relocate the receiving antenna.
- Increase the separation between the equipment and receiver.
- Connect the equipment into an outlet on a circuit different from that to which the receiver is connected.
- Consult the dealer or an experienced radio/TV technician for help.

This device complies with part 15 of the FCC rules. Operation is subject to the following two conditions (1) this device may not cause harmful interference, and (2) this device must accept any interference received, including interference that may cause undesired operation

Additional Warnings & Precautions

- **WARNING:** To reduce the risk of fire or electric shock, do not expose this apparatus to rain, moisture, dripping, or splashing.
- **CAUTION:** Use of controls or adjustments or performance of procedures other than those specified may result in personal injury.
- **WARNING:** Changes or modifications to this unit not expressly approved by the party responsible for compliance could void the user's authority to operate the equipment.
- **CAUTION:** Danger of explosion if battery is incorrectly replaced. Replace only with the same or equivalent type.
- Lithium batteries, like all rechargeable batteries, are recyclable and should be recycled or disposed of according to state and local guidelines. They should never be disposed of in normal household waste, and they should never be incinerated, as they might explode. Contact your local government for disposal or recycling practices in your area.
- **WARNING:** Shock hazard - Do Not Open.
- Battery shall not be exposed to excessive heat such as sunshine, fire, or the like.
Keep new and used batteries away from children. If the battery compartment does not close securely, stop using the product and keep it away from children.
- If you think batteries might have been swallowed or placed inside any part of the body, seek immediate medical attention.
- Do not mix old and new batteries.
- Completely replace all old batteries with new ones.
- Do not mix alkaline, standard (carbon-zinc), or rechargeable (ni-cad, ni-mh, etc) batteries.
- Batteries should be recycled or disposed of as per state and local guidelines.
- **WARNING:** This product may contain chemicals known to the State of California to cause birth defects, or other reproductive harm (California Prop 65). Wash hands after handling.
- This product meets and complies with all Federal regulations.

Table of Contents

FAA Registration – 4

- Which UAS Must Be Registered?
- Who Can Register?
- What Do You Need to Register?
- Additional Info

Sky Rider Falcon Pro – 5

- Features
- Includes

Orientation – 6

- Overview
- Remote Control

Camera – 8

- Attach Camera
- Functions

Batteries & Charging – 10

- Battery Charging Procedure
- Remote Control Battery Installation

Pre-Flight Calibration – 13

- Craft/Remote Link
- When You're Done Flying...

Trim Adjustment – 15

- Setting Trim & Countering Drift

Flying Tips & Features – 17

- Tips for Safe Operation
- Speed Setting
- Flips & Tricks
- Headless Mode
- Auto-Reverse
- Factory Default Settings

Troubleshooting – 20

Repair – 21

- Rotor Replacement

Parts – 22

- Parts Replacement
- Parts List

Company Information – 24

- Contact Information
- International Support
- Warranty

FAA Registration

As of December 21, 2015, the U.S. Federal Aviation Administration (FAA) has mandated that all Unmanned Aircraft Systems (UAS) of a certain weight must be registered with the FAA before flying outdoors. This includes aircraft commonly referred to as drones, quadcopters, Unmanned Aerial Vehicles (UAV), and the like.

The Online Registration fee is \$5, but will be credited back to your account if the registration is completed within the first 30 days of ownership. Once completed, the registration is valid for 3 years.

WHICH UAS MUST BE REGISTERED?

The Online Registration requirement applies to all UAS that weigh between 0.55 lbs (250g) and 55 lbs (25kg).

The Sky Rider Falcon Pro meets this requirement, and must be registered, with the Registration Number permanently affixed to the craft.

WHO CAN REGISTER?

- Anyone 13 years of age or older. A person who does not meet this age requirement must have their UAS registered by someone 13 years of age or older.
- A US citizen or legal permanent resident.

WHAT DO YOU NEED TO REGISTER?

When registering online, you will need:

- A valid email address
- A Credit or Debit Card
- A physical and mailing address (if different from physical address).

ADDITIONAL INFO

For the latest information on the FAA and the registration process, visit the web links listed below.

- **FAA Home Page** - <http://www.faa.gov/>
- **UAS Registration Page** - <http://www.faa.gov/uas/registration/>
- **UAS Registration FAQs** - <http://www.faa.gov/uas/registration/faqs/>

Sky Rider Falcon Pro

FEATURES

- 360° flips & tricks
- 2 speed settings
- 6-axis gyroscope
- .3 MP Camera (photo & video) with SD card slot
- Control distance: up to 150 feet
- Headless Mode
- Auto-Reverse
- LED navigation lights
- Operating time: 6-8 minutes
- Charge time: 60-80 minutes

INCLUDES

- 2.4 GHz remote control: requires 6 AA batteries (not included)
- Built-in rechargeable lithium polymer battery
- USB cable for battery recharge
- 4GB SD card
- Screwdriver
- 4 replacement rotors
- User's guide & warranty



Orientation

OVERVIEW

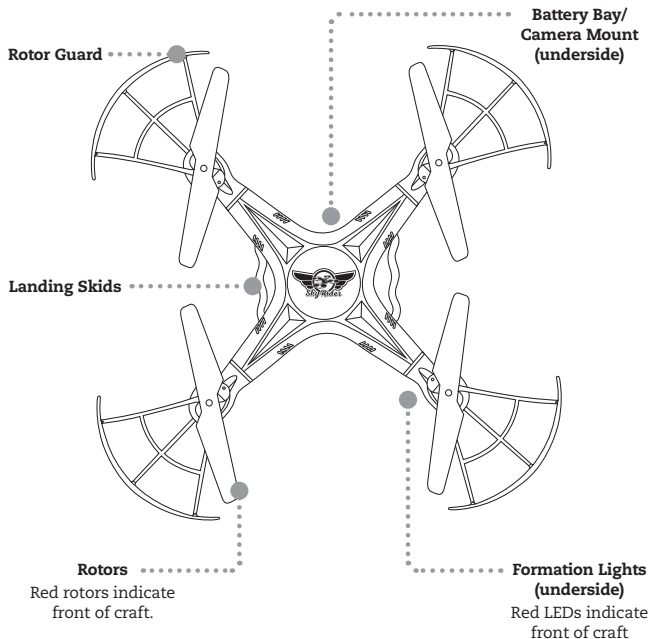

REMOTE CONTROL

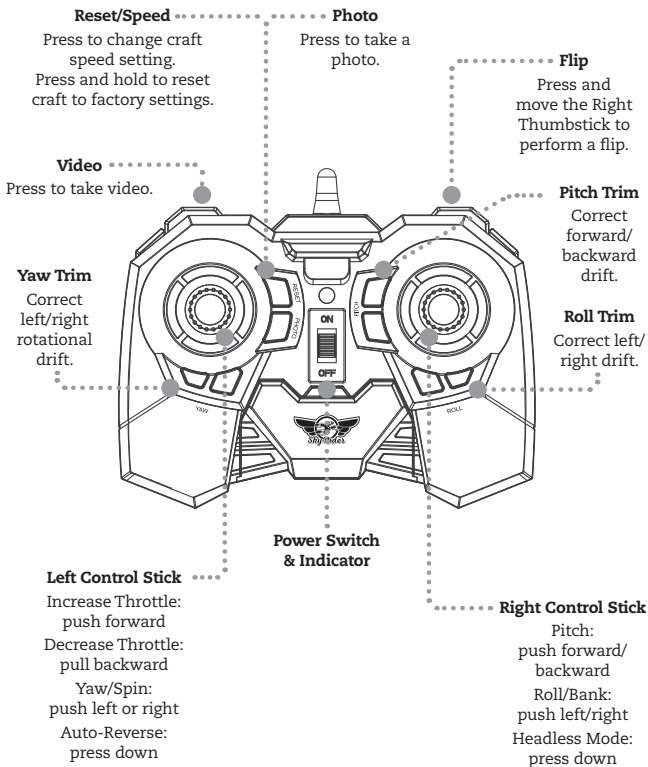

Camera

ATTACH CAMERA

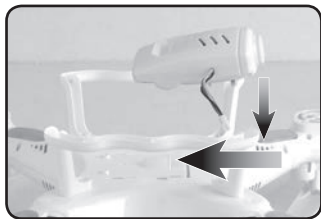

Mount the camera to the battery door by aligning the tab on the camera to the slot on the battery door.

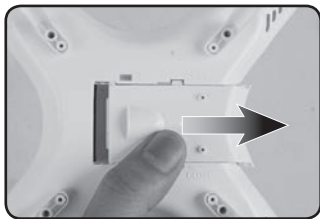

Open the battery door with the camera attached to access the inside of the door.

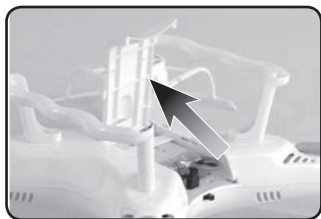

Tighten the camera to the door using the included screws and screwdriver. Close the door when complete.



Attach the camera's power cable to the plug on the body.

Be sure to match the plugs correctly or damage may occur.

FUNCTIONS

Make sure the remote and the craft have been successfully paired (indicated by a red light on the remote) before attempting to use the camera.

VIDEO

To record video, press the **Video button** on the remote. The indicator light will turn green for as long as the camera is recording. Press the video button again to stop recording video, the light will turn back to red.

PHOTOS

To take a single image, press the **Photo button** once. The indicator light will turn from red to green, then back to red.

Press and hold the **Photo button** to take a 3 photo burst. The indicator light will flicker green 3 times, then switch back to red.

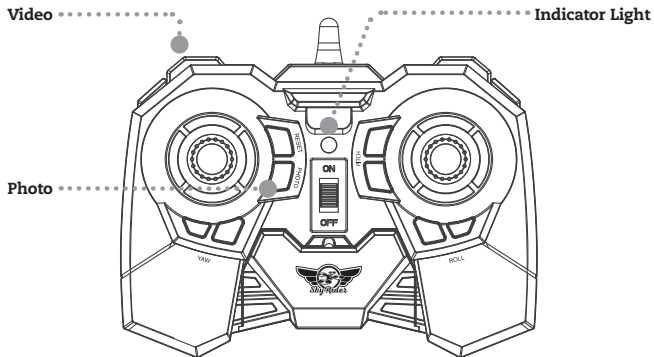

Batteries & Charging

BATTERY CHARGING PROCEDURE

The craft's lithium-polymer (Li-Po) battery must be charged before the unit can be flown. Before charging, be sure the craft and remote control are powered off. Failure to do so may result in injury.

STEP 1

Make sure the craft is powered OFF, then remove the battery cover.



STEP 2

Disconnect the power plugs connecting the battery to the craft. **It is strongly recommended to remove the battery when charging.** This will reduce the chance of damage or injury.



STEP 3

Attach the plug on the battery to the plug on the charging cable.

Be sure to match the plugs correctly or damage may occur.

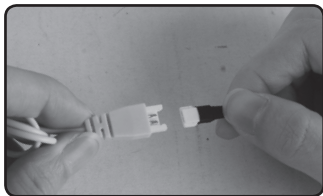

STEP 4

Plug the charging cable into the USB port of a powered ON computer or USB power adapter (not included). The battery will now charge.



AC/DC Charger Status

LIGHT	STATUS
Red Light ON	Charging
Red Light OFF	Ready

STEP 5

When charging is complete, reinstall the battery in its bay, reconnect the power plugs from the battery to the craft, and close the battery cover.

Be sure to match the plugs correctly or damage may occur.



REMINDER:

DO NOT CHARGE BATTERIES OVERNIGHT.

DO NOT LEAVE BATTERIES UNATTENDED WHILE CHARGING.

Batteries & Charging

REMOTE CONTROL BATTERY INSTALLATION

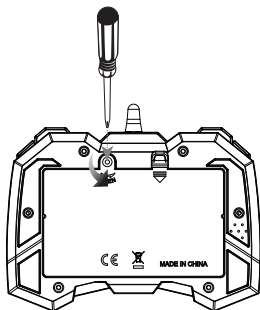

Use screwdriver (not included)
and remove battery cover.

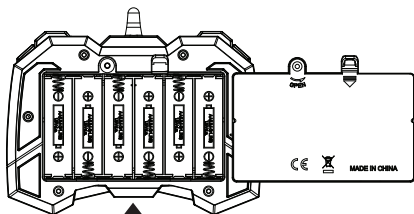

Insert 6 x AA Batteries
(not included).

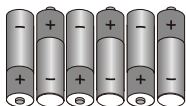

6 x AA
Batteries

Pre-Flight Calibration

CRAFT/REMOTE LINK

Before flying, the craft and the remote must be linked together, and the gyroscopes on the craft must be allowed to calibrate to ensure smooth and level flight.

Begin with the craft and remote powered OFF.

STEP 1

Place the craft on a flat and level surface.

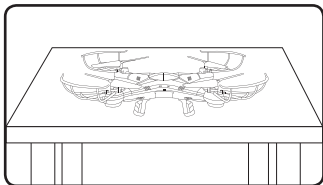

STEP 2

Power the craft ON. The LED formation lights will blink in unison as the craft searches for a signal from the remote.

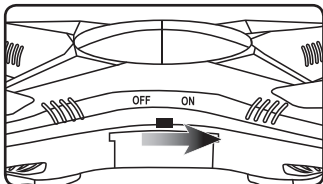

STEP 3

Power the remote control ON. The light on the remote will blink as it searches for the signal from the craft. An audible chime will sound when the remote and the craft have successfully linked with each other.

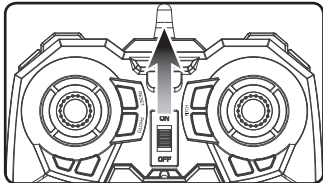

Pre-Flight Calibration

STEP 4

Push the Left Control Stick directly forward, wait for a chime to sound, then pull the stick directly backward, and wait for a second chime.

When this last chime has sounded, the craft is calibrated and ready to fly.

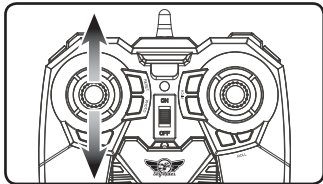

STEP 5

Attempt a stable hover, low to the surface you started on. If you notice a tendency to drift, you may need to adjust the trim controls to fine tune the handling (see Trim Adjustment, pg.15).

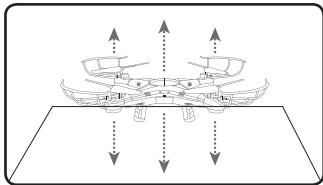

WHEN YOU'RE DONE FLYING...

After safely landing, keep the throttle in the lowest position (OFF) and wait for the rotors to stop spinning. **Power OFF the remote first.** This will ensure that no signals are accidentally sent to the craft, reducing the chance of injury. After this is done, it is safe to pick up and power OFF the craft.

Trim Adjustment

SETTING TRIM & COUNTERING DRIFT

Even after the craft is calibrated, it may show a tendency to drift while airborne. Adjusting the trim will help counter this effect and allow you to better control the craft. To avoid potential damage, adjust the trim while in a stable hover, and do not make any sudden movements with the flight controls. Adjust one trim setting at a time to avoid confusion.

Remember, the red LEDs /red rotors indicate the front of the craft.

While adjusting the trim will help with drift, it is not guaranteed to eliminate it entirely. Physical, mechanical, and environmental factors (ex: a gust of wind) may still influence the craft's direction and flight..

DRIFT TYPE

Craft **yaws/spins** in place.

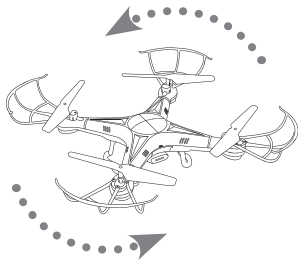

SOLUTION

Adjust **Yaw Trim**.

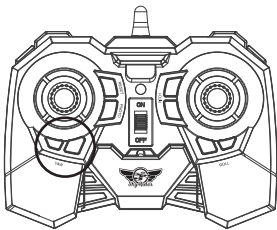

Trim Adjustment

DRIFT TYPE

Craft banks/rolls
left or right.

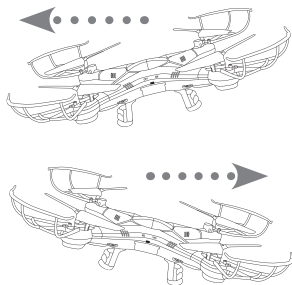

SOLUTION

Adjust Roll Trim.

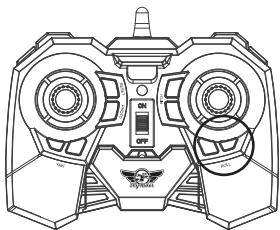

Craft pitches/angles
forward or backward.

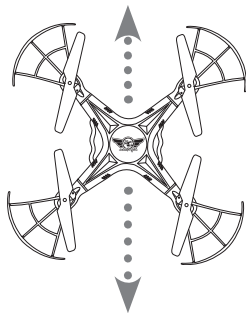

Adjust Pitch Trim.

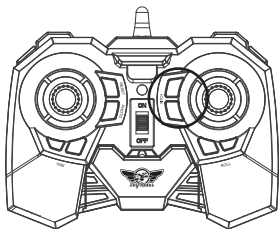

Flying Tips & Features

TIPS FOR SAFE OPERATION

- Only fly in large, open spaces, such as a field or a very large indoor area, free of obstacles like power lines, trees, ceiling fans, etc.
- When flying indoors, avoid walls and ceilings, as the craft will be drawn towards them if closer than 2 to 3 feet.
- Stand behind the craft when first taking off, so that it and you are facing the same “forward” direction. This will make it easier to determine which direction it is flying. Also, remember that the blue LED lights/red rotors indicate the front of the craft.
- Practice basic flight operations like take off, hovering, and landing.
- Flying inside, at low speed and low to the ground will reduce the chance of turbulence that can negatively affect the stable flight of the craft.
- Novice pilots should move the controls slowly and deliberately, using one control at a time, to get used to the craft’s flying characteristics. Next, try combining the pitch and roll controls (forward/backward and left/right on the Right Control Stick) to fly the craft similar to the way an airplane flies. After mastering this, try the yaw controls (left/right on the left thumbstick) to spin the craft in place and perform more complex maneuvers.
- If anything obstructs the rotors for any reason, throttle down IMMEDIATELY and safely clear the obstruction. Check for possible damage before flying again.

SPEED SETTING

The craft has two speed settings for the responsiveness of the flight controls. The default setting is slower and intended for novice pilots. The higher setting allows for faster, more precise control and is intended more experienced pilots.

Change the speed setting with a short press of the **Reset button**. A chime will sound to indicate the change.

NOTE: A long press of the Reset button will restore the factory default settings. Be careful not to do this while the craft is in flight. See page 21 for more information.

Flying Tips & Features

FLIPS & TRICKS

Before attempting any stunts, be sure that there is ample clear space around the craft, ideally 9 to 10 ft. in every direction. It is not recommended to attempt to flip around or through any obstacles, as this may result in unintended damage.

To perform a flip, follow the diagram below.

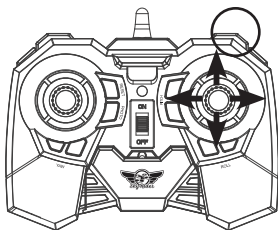

Press the **Flip button** then move the **Right Control Stick** in any direction.

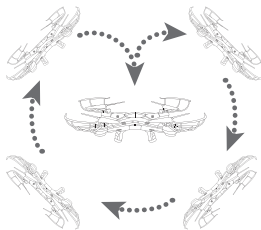

Craft will perform flip in the desired direction.

HEADLESS MODE

Headless Mode disables the default orientation of the craft, where the red LEDs and rotors indicate the front of the craft. Instead, the craft will reorient its “front” based on the first **Right Control Stick** input from the user. This can be useful if you become disoriented while flying, or cannot visually determine which direction is “true front”.

To activate Headless Mode, press the **Right Control Stick** once. Press again to deactivate Headless Mode. A chime will sound to indicate when Headless Mode is active or inactive.

AUTO-REVERSE

To enable Auto-Reverse, press the **Left Control Stick** once. The remote will emit a chime, and the craft will begin flying in the reverse of the direction it was originally flying. Throttle control will still function, but any directional change from the **Right Control Stick** will disable Auto-Reverse flight.

FACTORY DEFAULT SETTINGS

If the craft is experiencing difficulty flying or is behaving erratically, the craft and remote may need to have the factory default settings restored. **Do not attempt to do this while flying. Safely land the craft before attempting this procedure.**

Press and hold the Reset button for 2-3 seconds. The formation lights will begin blinking, when they have stopped blinking and are solid again the factory reset is complete and the craft is ready to fly.

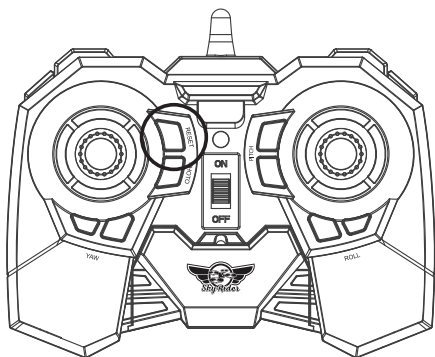

Factory Reset

Troubleshooting

If you are experiencing problems using or flying the hexacopter, consult this table.

PROBLEM	POSSIBLE CAUSES	SOLUTION
Craft is unresponsive	<ul style="list-style-type: none">• No power to remote or craft• Poor contact between power plugs• Craft is out of receiver range	<ul style="list-style-type: none">• Check remote batteries, replace if needed• Check craft's battery, be sure it is fully charged• Be sure the power plugs are firmly connected• Be sure the remote has an unobstructed line of sight to the craft• Remain within the remote's 150 ft. range
Craft flies erratically	<ul style="list-style-type: none">• Gyroscopes may be misaligned	<ul style="list-style-type: none">• Recalibrate gyroscopes (see next page)• Perform Pre-Flight Calibration again (see pg. 13)• Perform factory reset (see next page)
Craft drifts while in flight	<ul style="list-style-type: none">• Trim not set or needs adjustment	<ul style="list-style-type: none">• Adjust trim settings (see pg. 15)
Craft suffers from mechanical difficulty or vibrates excessively	<ul style="list-style-type: none">• Damage to body, rotors, or other major components	<ul style="list-style-type: none">• Check to make sure the craft has not taken significant damage• Replacement parts may be needed (see pg. 22)
Formation lights ON, but craft no longer responds to throttle inputs	<ul style="list-style-type: none">• Low battery power	<ul style="list-style-type: none">• Recharge the battery

Repair

REMINDER: Pilots are responsible for any damage caused by improper use.

ROTOR REPLACEMENT

The craft comes with 4 replacement rotors, to be used if the originals are broken or badly damaged.

To replace a rotor, use a small Phillips head screwdriver (included) and remove the screw connecting the rotor to the electric motor shaft. Remove the damaged rotor and replace it with a new one, then screw it back into place on the motor shaft, taking special care not to bend or break the shaft.

REMINDER: The rotors are marked **A** or **B** on the underside of the rotor. It is extremely important to use the correct rotor for replacement. Mismatching the rotor will cause the craft's flight to be erratic and difficult to control.

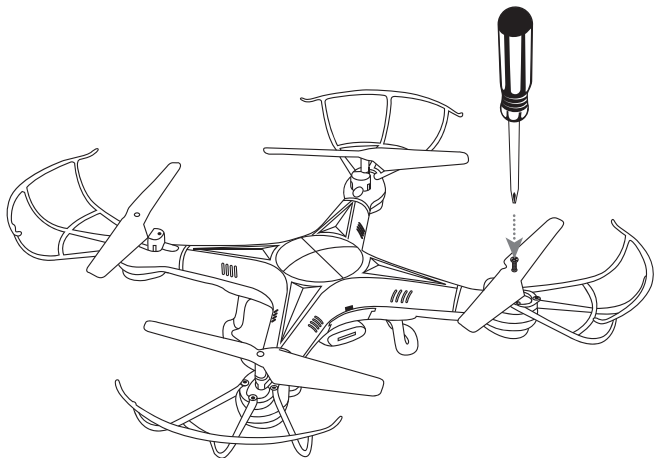

Parts

PARTS REPLACEMENT

If any major components of the craft are damaged beyond repair, use the contact information on the next page to order replacements.

The following parts are available for order.

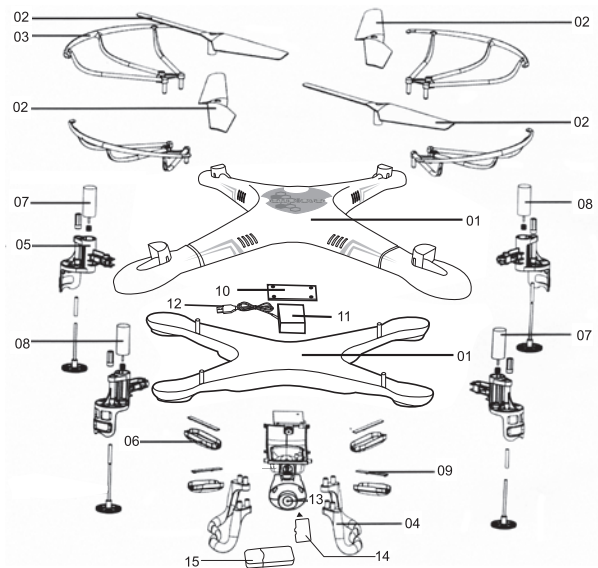

PARTS LIST

PART	NAME	QUANTITY
01	Body cover	1
02	Main blades	4
03	Protecting frames	4
04	Landing skids	2
05	Motorholder	4
06	Lampshades	4
07	Motor A	2
08	Motor B	2
09	Light boards	4
010	Receiver board	1
011	Battery	1
012	USB charging cable	1
013	Camera	1
014	Memory card	1
015	Card reader	1

Company Information

CONTACT INFORMATION

Website: www.gpx.com

Email Support: prodinfo@dpiinc.com

Email Parts: partsinfo@dpiinc.com

Phone Support: 1-888-999-4215

WARRANTY

See included 30 Day Warranty for warranty information. Warranty and the most up-to-date version of this User's Guide can also be found at: <http://gpx.com/drc376.html>

INTERNATIONAL SUPPORT

To download this User's Guide in English, Spanish, and French, or to get answers to frequently asked questions, visit the support section at: www.gpx.com

Para descargar este Manual del Usuario en inglés, español y francés, o para obtener respuestas a preguntas frecuentes, visite la sección de apoyo en: www.gpx.com

Pour télécharger ce guide de l'utilisateur en anglais, espagnol ou français, ou pour obtenir des réponses à des questions fréquemment posées, consultez la rubrique d'assistance sur: www.gpx.com



*Protect for Today
Sustain for Tomorrow*

Copyright © 2016 Digital Products International (DPI, Inc.) All other trademarks appearing herein are the property of their respective owners. Specifications are subject to change without notice.