

FCC

RF

TEST REPORT

ISSUED BY
Shenzhen BALUN Technology Co., Ltd.



FOR
Dynamic Bluetooth 4.0 Headphones

ISSUED TO
ARCTIC (HK) Ltd.

Unit 2304, Nina Tower 2, 8 Yeung Uk Road, Tsuen Wan, Hong Kong



Tested by:

Cao Shaodong
Cao Shaodong
(Engineer)

Date *Dec. 3, 2015*

Approved by:

Wei Yanqian
Wei Yanqian
(Chief Engineer)

Date *Dec. 3, 2015*

Report No.: BL-SZ15B0130-602

EUT Type: Dynamic Bluetooth 4.0 Headphones

Model Name: P604 Wireless

Brand Name: ARCTIC

Test Standard: 47 CFR Part 15 Subpart C

FCC ID: Z3AP604BT

Test conclusion: Pass

Test Date: Nov. 23, 2015 ~ Dec. 2, 2015

Date of Issue: Dec. 3, 2015

NOTE: This test report can be duplicated completely for the legal use with the approval of the applicant; it shall not be reproduced except in full, without the written approval of Shenzhen BALUN Technology Co., Ltd. BALUN Laboratory. Any objections should be raised within thirty days from the date of issue. To validate the report, please visit BALUN website.

Revision History

Version	Issue Date	Revisions
<u>Rev. 01</u>	<u>Dec. 3, 2015</u>	<u>Initial Issue</u>
_____	_____	_____

TABLE OF CONTENTS

1	ADMINISTRATIVE DATA (GENERAL INFORMATION)	5
1.1	Identification of the Testing Laboratory	5
1.2	Identification of the Responsible Testing Location	5
1.3	aboratory Condition	5
1.4	Announce	5
2	PRODUCT INFORMATION	7
2.1	Applicant	7
2.2	Manufacturer	7
2.3	Factory Information	7
2.4	General Description for Equipment under Test (EUT)	7
2.5	Ancillary Equipment	7
2.6	Technical Information	8
3	SUMMARY OF TEST RESULTS	9
3.1	Test Standards	9
3.2	Verdict	9
4	GENERAL TEST CONFIGURATIONS	10
4.1	Test Environments	10
4.2	Test Equipment List	10
4.3	Test Configurations	11
4.4	Description of Test Setup	11
4.4.1	For Antenna Port Test	11
4.4.2	For AC Power Supply Port Test	11
4.4.3	For Radiated Test (Below 30 MHz)	12
4.4.4	For Radiated Test (30 MHz-1 GHz)	12
4.4.5	For Radiated Test (Above 1 GHz)	13
4.5	Test Conditions	13

5	TEST ITEMS	14
5.1	Antenna Requirements.....	14
5.1.1	Standard Applicable	14
5.1.2	Antenna Anti-Replacement Construction	14
5.1.3	Antenna Gain	14
5.2	Output Power	15
5.2.1	Test Limit.....	15
5.2.2	Test Setup.....	15
5.2.3	Test Procedure.....	15
5.2.4	Test Result	15
5.3	6 dB Bandwidth	16
5.3.1	Limit.....	16
5.3.2	Test Setup.....	16
5.3.3	Test Procedure.....	16
5.3.4	Test Result	16
5.4	Conducted Spurious Emission	17
5.4.1	Limit.....	17
5.4.2	Test Setup.....	17
5.4.3	Test Procedure.....	17
5.4.4	Test Result	18
5.5	Conducted Emission	19
5.5.1	Limit.....	19
5.5.2	Test Setup.....	19
5.5.3	Test Procedure.....	19
5.5.4	Test Result	19
5.6	Radiated Spurious Emission	20
5.6.1	Limit.....	20
5.6.2	Test Setup.....	20
5.6.3	Test Procedure.....	20
5.6.4	Test Result	23
5.7	Band Edge	24
5.7.1	Limit.....	24

5.7.2	Test Setup.....	24
5.7.3	Test Procedure.....	24
5.7.4	Test Result.....	24
5.8	Power Spectral density (PSD).....	25
5.8.1	Limit.....	25
5.8.2	Test Setup.....	25
5.8.3	Test Procedure.....	25
5.8.4	Test Result.....	25
ANNEX A	TEST RESULT.....	26
A.1	Output Power.....	26
A.2	Bandwidth.....	28
A.3	Conducted Spurious Emissions.....	29
A.4	Conducted Emissions.....	32
A.5	Radiated Emission.....	34
A.6	Band Edge.....	42
A.7	Power Spectral Density (PSD).....	44
ANNEX B	TEST SETUP PHOTOS.....	45
ANNEX C	EUT EXTERNAL PHOTOS.....	45
ANNEX D	EUT INTERNAL PHOTOS.....	45

1 ADMINISTRATIVE DATA (GENERAL INFORMATION)

1.1 Identification of the Testing Laboratory

Company Name	Shenzhen BALUN Technology Co., Ltd.
Address	Block B, 1st FL, Baisha Science and Technology Park, Shahe Xi Road, Nanshan District, Shenzhen, Guangdong Province, P. R. China
Phone Number	+86 755 6685 0100
Fax Number	+86 755 6182 4271

1.2 Identification of the Responsible Testing Location

Test Location	Shenzhen BALUN Technology Co., Ltd.
Address	Block B, 1st FL, Baisha Science and Technology Park, Shahe Xi Road, Nanshan District, Shenzhen, Guangdong Province, P. R. China
Accreditation Certificate	<p>The laboratory has been listed by Industry Canada to perform electromagnetic emission measurements. The recognition numbers of test site are 11524A-1.</p> <p>The laboratory has been listed by US Federal Communications Commission to perform electromagnetic emission measurements. The recognition numbers of test site are 832625.</p> <p>The laboratory has met the requirements of the IAS Accreditation Criteria for Testing Laboratories (AC89), has demonstrated compliance with ISO/IEC Standard 17025:2005. The accreditation certificate number is TL-588.</p> <p>The laboratory is a testing organization accredited by China National Accreditation Service for Conformity Assessment (CNAS) according to ISO/IEC 17025. The accreditation certificate number is L6791.</p>
Description	All measurement facilities used to collect the measurement data are located at Block B, FL 1, Baisha Science and Technology Park, Shahe Xi Road, Nanshan District, Shenzhen, Guangdong Province, P. R. China 518055

1.3 Laboratory Condition

Ambient Temperature	20 to 25°C
Ambient Relative Humidity	45% - 55%
Ambient Pressure	100 kPa - 102 kPa

1.4 Announce

- (1) The test report reference to the report template version v1.1.
- (2) The test report is invalid if not marked with the signatures of the persons responsible for preparing and approving the test report.
- (3) The test report is invalid if there is any evidence and/or falsification.
- (4) The results documented in this report apply only to the tested sample, under the conditions and modes of operation as described herein.

- (5) This document may not be altered or revised in any way unless done so by BALUN and all revisions are duly noted in the revisions section.
- (6) Content of the test report, in part or in full, cannot be used for publicity and/or promotional purposes without prior written approval from the laboratory.

2 PRODUCT INFORMATION

2.1 Applicant

Applicant	ARCTIC (HK) Ltd.
Address	Unit 2304, Nina Tower 2, 8 Yeung Uk Road, Tsuen Wan, Hong Kong

2.2 Manufacturer

Manufacturer	ARCTIC (HK) Ltd.
Address	Unit 2304, Nina Tower 2, 8 Yeung Uk Road, Tsuen Wan, Hong Kong

2.3 Factory Information

Factory	Shenzhen Bada Sheng Electronic Co., Ltd.
Address	Blk 12, Foodstuff Ind, SongYuan Village, GuanLan town, 518110, ShenZhen, China

2.4 General Description for Equipment under Test (EUT)

EUT Type	Dynamic Bluetooth 4.0 Headphones
Model Name	P604 Wireless
Hardware Version	UN0018-V8.0
Software Version	UN0018-V8.0
Network and Wireless connectivity	Bluetooth 3.0, Bluetooth 4.0 Low Energy (BLE)

2.5 Ancillary Equipment

Ancillary Equipment 1	Battery	
	Brand Name	CEL
	Model No.	CELALB553545-PCM
	Serial No.	N/A
	Capacitance	850 mAh
	Rated Voltage	3.7 V
	Limit Charge Voltage	4.2 V
Ancillary Equipment 2	USB Cable	
	Length (Approx.)	84 cm

2.6 Technical Information

The requirement for the following technical information of the EUT was tested in this report:

Modulation Technology	FHSS
Modulation Type	GFSK
Transfer Rate	1 Mbps
Frequency Range	The frequency range used is 2402 MHz – 2480 MHz; The frequency block is 2400 MHz to 2483.5 MHz.
Number of channel	40 (at intervals of 2 MHz)
Tested Channel	0 (2402 MHz), 19 (2440 MHz), 39 (2480 MHz).
Antenna Type	PCB Antenna
Antenna Gain	-3 dBi
About the Product	The equipment is Dynamic Bluetooth 4.0 Headphones, it contains Bluetooth module operating at 2.4 GHz ISM band. Only the Bluetooth 4.0 Low Energy (BLE) was tested in this report.

3 SUMMARY OF TEST RESULTS

3.1 Test Standards

No.	Identity	Document Title
1	47 CFR Part 15, Subpart C (10-1-14 Edition)	Miscellaneous Wireless Communications Services
2	KDB Publication 558074 D01v03r03	Guidance for Performing Compliance Measurements on Digital Transmission Systems (DTS) Operating Under §15.247
3	ANSI C63.4-2014	American National Standard for Standard for Methods of Measurement of Radio-Noise Emissions from Low-Voltage Electrical and Electronic Equipment in the Range of 9 kHz to 40 GHz
4	ANSI C63.10-2013	American National Standard for Testing Unlicensed Wireless Devices

3.2 Verdict

No.	Description	FCC Part No.	Test Result	Verdict
1	Antenna Requirement	15.203 15.247(b)	Note 1	Pass
2	Output Power	15.247(b)	ANNEX A.1	Pass
3	6dB Bandwidth	15.247(a)	ANNEX A.2	Pass
4	Conducted Spurious Emission	15.247(d)	ANNEX A.3	Pass
5	Conducted Emission	15.207	ANNEX A.4	Pass
6	Radiated Spurious Emission	15.209 15.247(d)	ANNEX A.5	Pass
7	Band Edge	15.209 15.247(d)	ANNEX A.6	Pass
8	Power spectral density (PSD)	15.247(e)	ANNEX A.7	Pass
Note 1: Please refer to section 5.1				

4 GENERAL TEST CONFIGURATIONS

4.1 Test Environments

During the measurement, the normal environmental conditions were within the listed ranges:

Relative Humidity	45% - 55%	
Atmospheric Pressure	100 kPa -102 kPa	
Temperature	NT (Normal Temperature)	+22°C to +25°C
Working Voltage of the EUT	NV (Normal Voltage)	3.7 V

4.2 Test Equipment List

Description	Manufacturer	Model	Serial No.	Cal. Date	Cal. Due
Spectrum Analyzer	ROHDE&SCHWARZ	FSV-30	103118	2015.07.16	2016.07.15
Vector Signal Generator	ROHDE&SCHWARZ	SMBV100A	177746	2015.07.16	2016.07.15
Signal Generator	ROHDE&SCHWARZ	SMB100A	260592	2015.07.01	2016.06.30
Switch Unit with OSP-B157	ROHDE&SCHWARZ	OSP120	101270	2015.07.16	2016.07.15
Spectrum Analyzer	AGILENT	E4440A	MY45304434	2015.10.18	2016.10.17
EMI Receiver	ROHDE&SCHWARZ	ESRP	101036	2015.07.14	2016.07.13
LISN	SCHWARZBECK	NSLK 8127	8127-687	2015.07.14	2016.07.13
Bluetooth Tester	ROHDE&SCHWARZ	CBT	101005	2015.07.16	2016.07.15
Power Splitter	KMW	DCPD-LDC	1305003215	2015.07.01	2016.06.30
Power Sensor	ROHDE&SCHWARZ	NRP-Z21	103971	2015.07.21	2016.07.20
Attenuator (20 dB)	KMW	ZA-S1-201	110617091	--	--
Attenuator (6 dB)	KMW	ZA-S1-61	1305003189	--	--
DC Power Supply	ROHDE&SCHWARZ	HMP2020	018141664	2015.07.17	2016.07.16
Temperature Chamber	ANGELANTIONI SCIENCE	NTH64-40A	1310	2015.08.07	2016.08.06
Test Antenna-Loop(9 kHz-30 MHz)	SCHWARZBECK	FMZB 1519	1519-037	2015.07.22	2017.07.21
Test Antenna-Bi-Log(30 MHz-3 GHz)	SCHWARZBECK	VULB 9163	9163-624	2015.07.22	2017.07.21
Test Antenna-Horn(1-18 GHz)	SCHWARZBECK	BBHA 9120D	9120D-1148	2015.07.22	2017.07.21
Test Antenna-Horn(15-26.5 GHz)	SCHWARZBECK	BBHA 9170	9170-305	2015.07.22	2017.07.21
Anechoic Chamber	RAINFORD	9m*6m*6m	N/A	2015.02.28	2016.02.27
Shielded Enclosure	ChangNing	CN-130701	130703	--	--

4.3 Test Configurations

Test Configurations (TC) NO.	Description	
	Signal Description	Operating Frequency
Transmitter		
TC01	FHSS modulation, GFSK	Ch No. 0/ 2402 MHz
TC02	FHSS modulation, GFSK	Ch No. 19/ 2440 MHz
TC03	FHSS modulation, GFSK	Ch No. 39/ 2480 MHz

4.4 Description of Test Setup

4.4.1 For Antenna Port Test

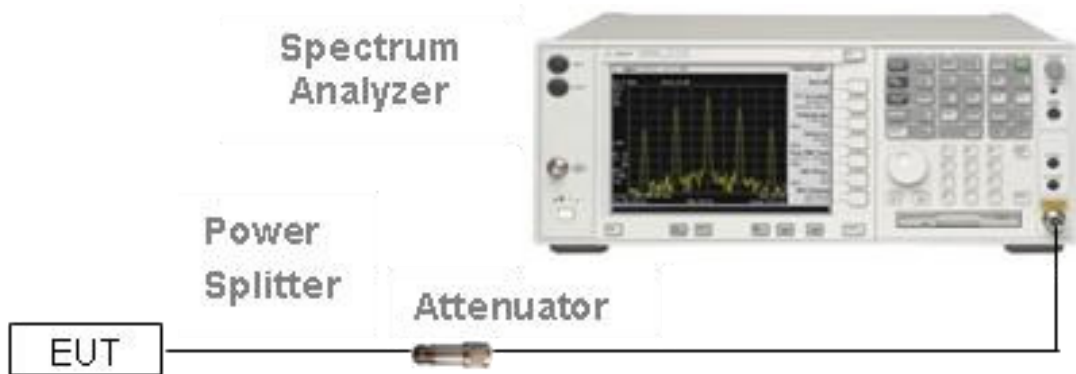

(Diagram 1)

4.4.2 For AC Power Supply Port Test

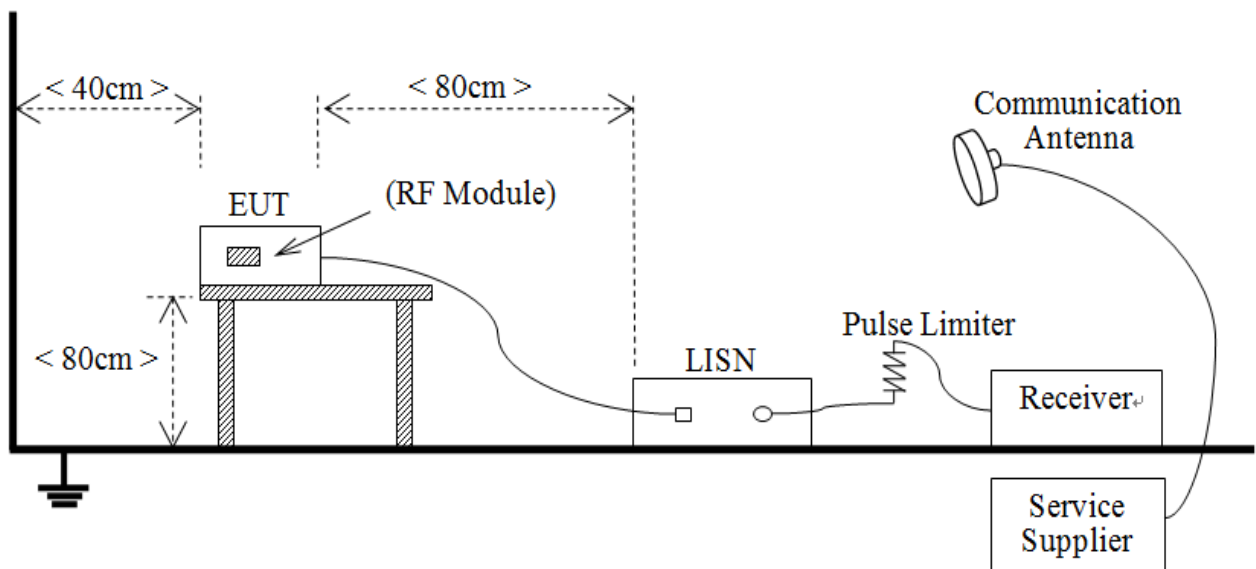

(Diagram 2)

4.4.3 For Radiated Test (Below 30 MHz)

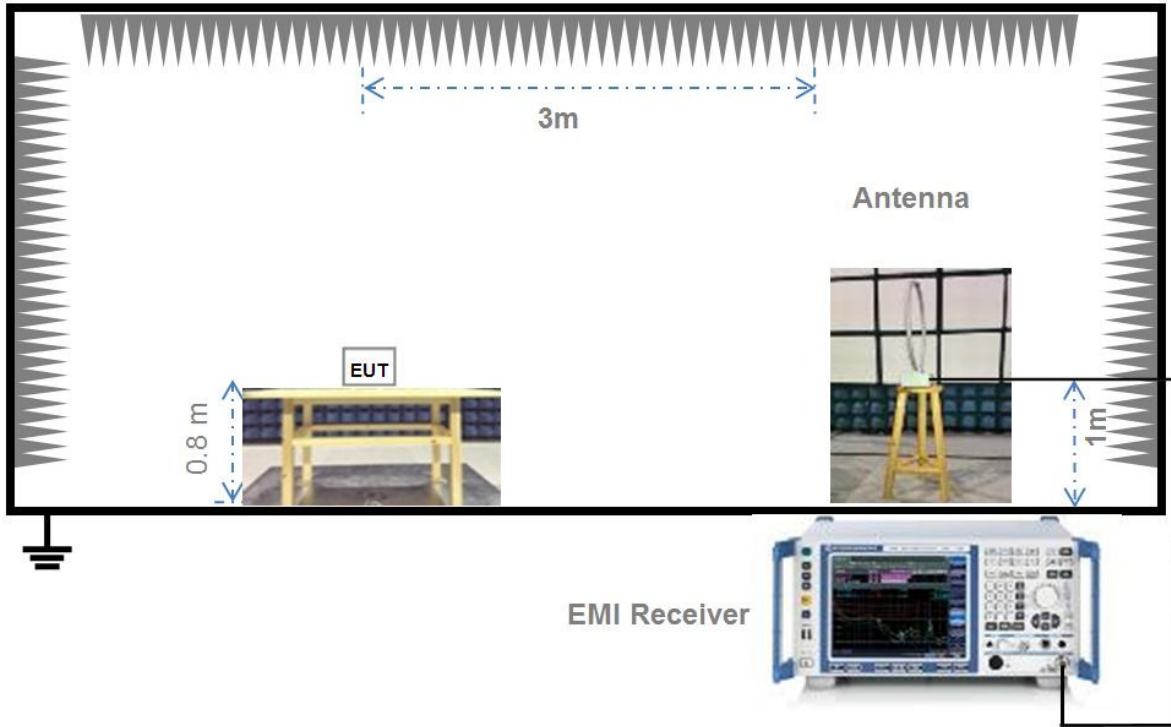

(Diagram 3)

4.4.4 For Radiated Test (30 MHz-1 GHz)

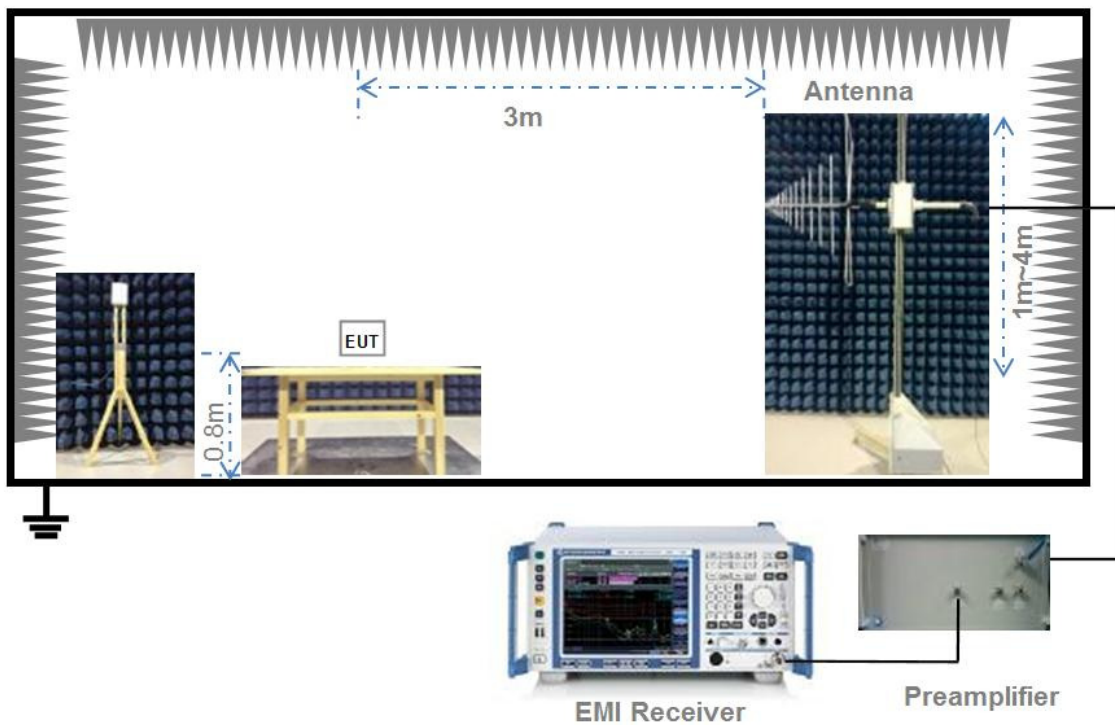

(Diagram 4)

4.4.5 For Radiated Test (Above 1 GHz)

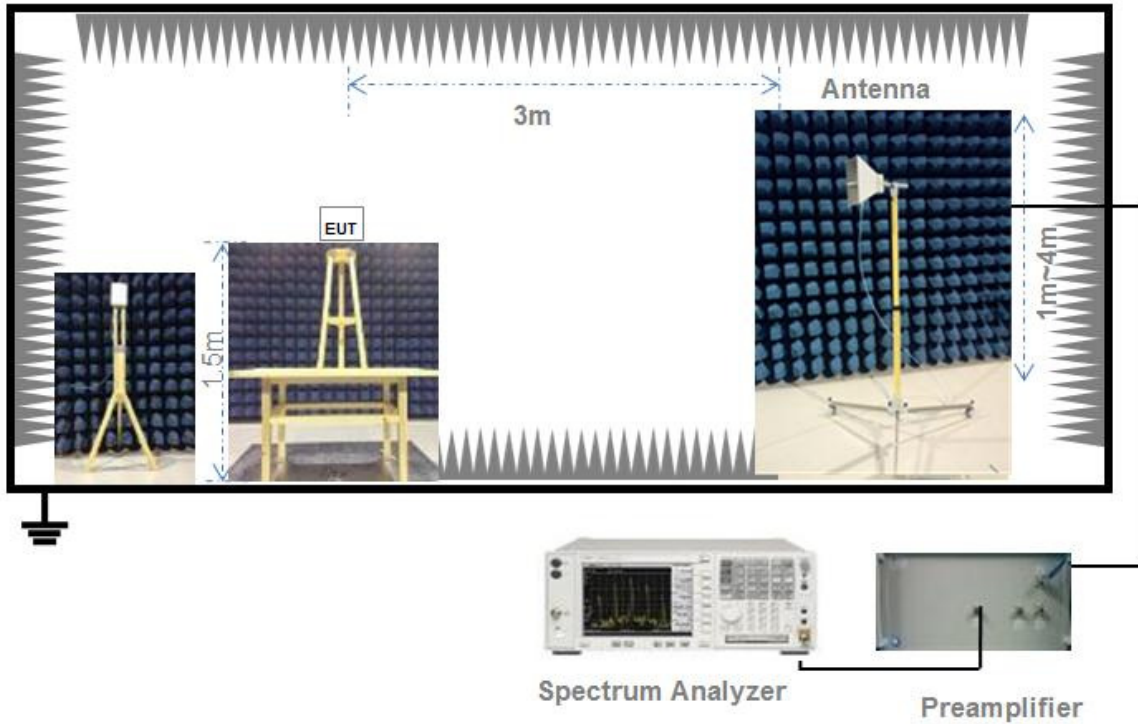

(Diagram 5)

4.5 Test Conditions

Test Case	Test Conditions		
	Test Env.	Test Setup ^{Note 1}	Test Configuration ^{Note 2}
Peak Output Power	NTNV	Test Setup 1	TC01~TC03
Occupied Bandwidth	NTNV	Test Setup 1	TC01~TC03
Conducted Spurious Emission	NTNV	Test Setup 1	TC01~TC03
Conducted Emission	NTNV	Test Setup 2	TC01~TC03
Radiated Spurious Emission	NTNV	Test Setup 3 Test Setup 4 Test Setup 5	TC01~TC03
Band Edge	NTNV	Test Setup 1	TC01, TC03
Power spectral density (PSD)	NTNV	Test Setup 2	TC01~TC03
Note:			
1. Please refer to section 4.4 for test setup details.			
2. Please refer to section 4.3 for test configuration details.			

5 TEST ITEMS

5.1 Antenna Requirements

5.1.1 Standard Applicable

FCC §15.203 & 15.247(b)

An intentional radiator shall be designed to ensure that no antenna other than that furnished by the responsible party shall be used with the device. The use of a permanently attached antenna or of an antenna that uses a unique coupling to the intentional radiator shall be considered sufficient to comply with the provisions of this section. The manufacturer may design the unit so that a broken antenna can be replaced by the user, but the use of a standard antenna jack or electrical connector is prohibited. This requirement does not apply to carrier current devices or to devices operated under the provisions of § 15.211, § 15.213, § 15.217, § 15.219, or § 15.221. Further, this requirement does not apply to intentional radiators that must be professionally installed, such as perimeter protection systems and some field disturbance sensors, or to other intentional radiators which, in accordance with § 15.31(d), must be measured at the installation site. However, the installer shall be responsible for ensuring that the proper antenna is employed so that the limits in this part are not exceeded.

If directional gain of transmitting antennas is greater than 6 dBi, the power shall be reduced by the same level in dB comparing to gain minus 6 dBi. For the fixed point-to-point operation, the power shall be reduced by one dB for every 3 dB that the directional gain of the antenna exceeds 6 dBi. The use of a permanently attached antenna or of an antenna that uses a unique coupling to the intentional radiator shall be considered sufficient to comply with the FCC rule.

5.1.2 Antenna Anti-Replacement Construction

The Antenna Anti-Replacement as following method:

Protected Method	Description
The antenna is An embedded-in	An embedded-in antenna design is used.

PCB Antenna

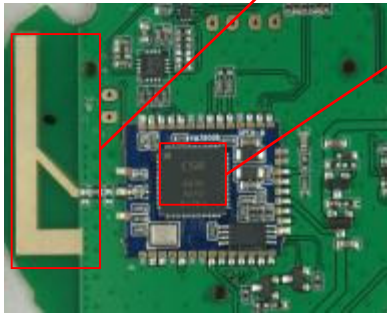
Reference Documents	Item
Photo	

5.1.3 Antenna Gain

The antenna peak gain of EUT is less than 6 dBi. Therefore, it is not necessary to reduce maximum peak output power limit.

5.2 Output Power

5.2.1 Test Limit

FCC § 15.247(b)

For systems using digital modulation in the 902-928 MHz, 2400-2483.5 MHz, and 5725-5850 MHz bands: 1 Watt. As an alternative to a peak power measurement, compliance with the one Watt limit can be based on a measurement of the maximum conducted output power. Maximum Conducted Output Power is defined as the total transmit power delivered to all antennas and antenna elements averaged across all symbols in the signaling alphabet when the transmitter is operating at its maximum power control level. Power must be summed across all antennas and antenna elements.

5.2.2 Test Setup

See section 4.4.1 for test setup description for the antenna port. The photo of test setup please refer to ANNEX B.

5.2.3 Test Procedure

Maximum peak conducted output power

This procedure shall be used when the measurement instrument has available a resolution bandwidth that is greater than the DTS bandwidth.

Set the RBW \geq DTS bandwidth.

Set VBW $\geq 3 \times$ RBW.

Set span $\geq 3 \times$ RBW

Sweep time = auto couple.

Detector = peak.

Trace mode = max hold.

Allow trace to fully stabilize.

Use peak marker function to determine the peak amplitude level.

Measurements of duty cycle

The zero-span mode on a spectrum analyzer or EMI receiver if the response time and spacing between bins on the sweep are sufficient to permit accurate measurements of the on and off times of the transmitted signal.

Set the center frequency of the instrument to the center frequency of the transmission.

Set RBW \geq OBW if possible; otherwise, set RBW to the largest available value.

Set VBW \geq RBW. Set detector = peak or average.

The zero-span measurement method shall not be used unless both RBW and VBW are $> 50/T$ and the number of sweep points across duration T exceeds 100. (For example, if VBW and/or RBW are limited to 3 MHz, then the zero-span method of measuring duty cycle shall not be used if $T \leq 16.7$ microseconds.)

5.2.4 Test Result

Please refer to ANNEX A.1.

5.36 dB Bandwidth

5.3.1 Limit

FCC §15.247(a)

Make the measurement with the spectrum analyzer's resolution bandwidth (RBW) = 100 kHz. In order to make an accurate measurement, set the span greater than RBW. The 6 dB bandwidth must be greater than 500 kHz.

5.3.2 Test Setup

See section 4.4.1 for test setup description for the antenna port. The photo of test setup please refer to ANNEX B.

5.3.3 Test Procedure

Use the following spectrum analyzer settings:

Set RBW = 100 kHz.

Set the video bandwidth (VBW) ≥ 3 RBW.

Detector = Peak.

Trace mode = max hold.

Sweep = auto couple.

Allow the trace to stabilize.

Measure the maximum width of the emission that is constrained by the frequencies associated with the two outermost amplitude points (upper and lower frequencies) that are attenuated by 6 dB relative to the maximum level measured in the fundamental emission.

5.3.4 Test Result

Please refer to ANNEX A.2.

5.4 Conducted Spurious Emission

5.4.1 Limit

FCC §15.247(d)

In any 100 kHz bandwidth outside the frequency band in which the spread spectrum or digitally modulated intentional radiator is operating, the radio frequency power that is produced by the intentional radiator shall be at least 20 dB below that in the 100 kHz bandwidth within the band that contains the highest level of the desired power, based on either an RF conducted or a radiated measurement.

5.4.2 Test Setup

See section 4.4.1 for test setup description for the antenna port. The photo of test setup please refer to ANNEX B.

5.4.3 Test Procedure

The DTS rules specify that in any 100 kHz bandwidth outside of the authorized frequency band, the power shall be attenuated according to the following conditions:

- a) If the maximum peak conducted output power procedure was used to demonstrate compliance as described in 9.1, then the peak output power measured in any 100 kHz bandwidth outside of the authorized frequency band shall be attenuated by at least 20 dB relative to the maximum in-band peak PSD level in 100 kHz (i.e., 20 dBc).
- b) If maximum conducted (average) output power was used to demonstrate compliance as described in 9.2, then the peak power in any 100 kHz bandwidth outside of the authorized frequency band shall be attenuated by at least 30 dB relative to the maximum in-band peak PSD level in 100 kHz (i.e., 30 dBc).
- c) In either case, attenuation to levels below the 15.209 general radiated emissions limits is not required.

The following procedures shall be used to demonstrate compliance to these limits. Note that these procedures can be used in either an antenna-port conducted or radiated test set-up. Radiated tests must conform to the test site requirements and utilize maximization procedures defined herein.

Reference level measurement

Establish a reference level by using the following procedure:

Set instrument center frequency to DTS channel center frequency.

Set the span to ≥ 1.5 times the DTS bandwidth.

Set the RBW = 100 kHz.

Set the VBW $\geq 3 \times$ RBW.

Detector = peak.

Sweep time = auto couple.

Trace mode = max hold.

Allow trace to fully stabilize.

Use the peak marker function to determine the maximum PSD level.

Emission level measurement

Use the following spectrum analyzer settings:

Span = wide enough to capture the peak level of the in-band emission and all spurious emissions (e.g., harmonics) from the lowest frequency generated in the EUT up through the 10th harmonic. Typically, several plots are required to cover this entire span.

Set the RBW = 100 kHz.

Set the VBW $\geq 3 \times$ RBW.

Detector = peak.

Sweep time = auto couple.

Trace mode = max hold.

Allow trace to fully stabilize.

Use the peak marker function to determine the maximum amplitude level.

Ensure that the amplitude of all unwanted emissions outside of the authorized frequency band (excluding restricted frequency bands) are attenuated by at least the minimum requirements specified in 11.1 a) or 11.1 b). Report the three highest emissions relative to the limit.

5.4.4 Test Result

Please refer to ANNEX A.3.

5.5 Conducted Emission

5.5.1 Limit

FCC §15.207

For an intentional radiator that is designed to be connected to the public utility (AC) power line, the radio frequency voltage that is conducted back onto the AC power line on any frequency within the band 150 kHz to 30 MHz shall not exceed the limits in the following table, as measured using a 50 μ H/50 Ω line impedance stabilization network (LISN).

Frequency range (MHz)	Conducted Limit (dB μ V)	
	Quai-peak	Average
0.15 - 0.50	66 to 56	56 to 46
0.50 - 5	56	46
0.50 - 30	60	50

5.5.2 Test Setup

See section 4.4.2 for test setup description for the AC power supply port. The photo of test setup please refer to ANNEX B.

5.5.3 Test Procedure

The maximum conducted interference is searched using Peak (PK), if the emission levels more than the AV and QP limits, and that have narrow margins from the AV and QP limits will be re-measured with AV and QP detectors. Tests for both L phase and N phase lines of the power mains connected to the EUT are performed. Refer to recorded points and plots below.

5.5.4 Test Result

Please refer to ANNEX A.4.

5.6 Radiated Spurious Emission

5.6.1 Limit

FCC §15.209&15.247(d)

Radiated emission outside the frequency band attenuation below the general limits specified in FCC section 15.209(a) is not required. In addition, radiated emissions which fall in the restricted bands, as defined in FCC section 15.205(a), must also comply with the radiated emission limits specified in FCC section 15.209(a).

According to FCC section 15.209 (a), except as provided elsewhere in this subpart, the emissions from an intentional radiator shall not exceed the field strength levels specified in the following table:

Frequency (MHz)	Field Strength ($\mu\text{V}/\text{m}$)	Measurement Distance (m)
0.009 - 0.490	2400/F(kHz)	300
0.490 - 1.705	24000/F(kHz)	30
1.705 - 30.0	30	30
30 - 88	100	3
88 - 216	150	3
216 - 960	200	3
Above 960	500	3

Note:

1. For Above 1000 MHz, the emission limit in this paragraph is based on measurement instrumentation employing an average detector, measurement using instrumentation with a peak detector function, corresponding to 20 dB above the maximum permitted average limit.
2. For above 1000 MHz, limit field strength of harmonics: 54 dBuV/m@3m (AV) and 74 dBuV/m@3m (PK).

5.6.2 Test Setup

See section 4.4.3-4.4.5 for test setup description for the antenna port. The photo of test setup please refer to ANNEX B.

5.6.3 Test Procedure

Since the emission limits are specified in terms of radiated field strength levels, measurements performed to demonstrate compliance have traditionally relied on a radiated test configuration. Radiated measurements remain the principal method for demonstrating compliance to the specified limits; however antenna-port conducted measurements are also now acceptable to demonstrate compliance (see below for details). When radiated measurements are utilized, test site requirements and procedures for maximizing and measuring radiated emissions that are described in ANSI C63.10 shall be followed.

Antenna-port conducted measurements may also be used as an alternative to radiated measurements for demonstrating compliance in the restricted frequency bands. If conducted measurements are performed, then proper impedance matching must be ensured and an additional radiated test for cabinet/case spurious emissions is required.

General Procedure for conducted measurements in restricted bands

- a) Measure the conducted output power (in dBm) using the detector specified (see guidance regarding measurement procedures for determining quasi-peak, peak, and average conducted output power, respectively).

- b) Add the maximum transmit antenna gain (in dBi) to the measured output power level to determine the EIRP level (see guidance on determining the applicable antenna gain)
- c) Add the appropriate maximum ground reflection factor to the EIRP level (6 dB for frequencies ≤ 30 MHz, 4.7 dB for frequencies between 30 MHz and 1000 MHz, inclusive and 0 dB for frequencies > 1000 MHz).
- d) For devices with multiple antenna-ports, measure the power of each individual chain and sum the EIRP of all chains in linear terms (e.g., Watts, mW).
- e) Convert the resultant EIRP level to an equivalent electric field strength using the following relationship:

$$E = \text{EIRP} - 20\log D + 104.8$$
 where:
 E = electric field strength in dBμV/m,
 EIRP = equivalent isotropic radiated power in dBm
 D = specified measurement distance in meters.
- f) Compare the resultant electric field strength level to the applicable limit.
- g) Perform radiated spurious emission test.

Quasi-Peak measurement procedure

The specifications for measurements using the CISPR quasi-peak detector can be found in Publication 16 of the International Special Committee on Radio Frequency Interference (CISPR) of the International Electrotechnical Commission.

As an alternative to CISPR quasi-peak measurement, compliance can be demonstrated to the applicable emission limits using a peak detector.

Peak power measurement procedure

Peak emission levels are measured by setting the instrument as follows:

- a) RBW = as specified in Table 1.
- b) VBW ≥ 3 x RBW.
- c) Detector = Peak.
- d) Sweep time = auto.
- e) Trace mode = max hold.
- f) Allow sweeps to continue until the trace stabilizes. (Note that the required measurement time may be longer for low duty cycle applications).

Table 1—RBW as a function of frequency

Frequency	RBW
9-150 kHz	200-300 Hz
0.15-30 MHz	9-10 kHz
30-1000 MHz	100-120 kHz
> 1000 MHz	1 MHz

If the peak-detected amplitude can be shown to comply with the average limit, then it is not necessary to perform a separate average measurement.

Trace averaging across on and off times of the EUT transmissions followed by duty cycle correction

If continuous transmission of the EUT (i.e., duty cycle ≥ 98 percent) cannot be achieved and the duty cycle is constant (i.e., duty cycle variations are less than ± 2 percent), then the following procedure shall be used:

- a) The EUT shall be configured to operate at the maximum achievable duty cycle.
- b) Measure the duty cycle, x , of the transmitter output signal as described in section 6.0.
- c) RBW = 1 MHz (unless otherwise specified).
- d) VBW $\geq 3 \times$ RBW.
- e) Detector = RMS, if $\text{span}/(\# \text{ of points in sweep}) \leq (\text{RBW}/2)$. Satisfying this condition may require increasing the number of points in the sweep or reducing the span. If this condition cannot be satisfied, then the detector mode shall be set to peak.
- f) Averaging type = power (i.e., RMS).
 - 1) As an alternative, the detector and averaging type may be set for linear voltage averaging.
 - 2) Some instruments require linear display mode in order to use linear voltage averaging. Log or dB averaging shall not be used.
- g) Sweep time = auto.
- h) Perform a trace average of at least 100 traces.
- i) A correction factor shall be added to the measurement results prior to comparing to the emission limit in order to compute the emission level that would have been measured had the test been performed at 100 percent duty cycle. The correction factor is computed as follows:
 - 1) If power averaging (RMS) mode was used in step f), then the applicable correction factor is $10 \log(1/x)$, where x is the duty cycle.
 - 2) If linear voltage averaging mode was used in step f), then the applicable correction factor is $20 \log(1/x)$, where x is the duty cycle.
 - 3) If a specific emission is demonstrated to be continuous (≥ 98 percent duty cycle) rather than turning on and off with the transmit cycle, then no duty cycle correction is required for that emission.

NOTE: Reduction of the measured emission amplitude levels to account for operational duty factor is not permitted. Compliance is based on emission levels occurring during transmission - not on an average across on and off times of the transmitter.

Determining the applicable transmit antenna gain

A conducted power measurement will determine the maximum output power associated with a restricted band emission; however, in order to determine the associated EIRP level, the gain of the transmitting antenna (in dBi) must be added to the measured output power (in dBm).

Since the out-of-band characteristics of the EUT transmit antenna will often be unknown, the use of a

conservative antenna gain value is necessary. Thus, when determining the EIRP based on the measured conducted power, the upper bound on antenna gain for a device with a single RF output shall be selected as the maximum in-band gain of the antenna across all operating bands, or 2 dBi, whichever is greater. However, for devices that operate in multiple frequency bands while using the same transmit antenna, the highest gain of the antenna within the operating band nearest in frequency to the restricted band emission being measured may be used in lieu of the overall highest gain when the emission is at a frequency that is within 20 percent of the nearest band edge frequency, but in no case shall a value less than 2 dBi be used.

See KDB 662911 for guidance on calculating the additional array gain term when determining the effective antenna gain for a EUT with multiple outputs occupying the same or overlapping frequency ranges in the same band.

Radiated spurious emission test

An additional consideration when performing conducted measurements of restricted band emissions is that unwanted emissions radiating from the EUT cabinet, control circuits, power leads, or intermediate circuit elements will likely go undetected in a conducted measurement configuration. To address this concern, a radiated test shall be performed to ensure that emissions emanating from the EUT cabinet (rather than the antenna port) also comply with the applicable limits.

For these cabinet radiated spurious emission measurements the EUT transmit antenna may be replaced with a termination matching the nominal impedance of the antenna. Procedures for performing radiated measurements are specified in ANSI C63.10. All detected emissions shall comply with the applicable limits.

The measurement frequency range is from 30MHz to the 10th harmonic of the fundamental frequency. The Turn Table is actuated to turn from 0° to 360°, and both horizontal and vertical polarizations of the Test Antenna are used to find the maximum radiated power. Mid channels on all channel bandwidth verified. Only the worst RB size/offset presented.

The power of the EUT transmitting frequency should be ignored.

All Spurious Emission tests were performed in X, Y, Z axis direction. And only the worst axis test condition was recorded in this test report.

Use the following spectrum analyzer settings:

Span = wide enough to fully capture the emission being measured

RBW = 1 MHz for $f \geq 1$ GHz, 100 kHz for $f < 1$ GHz

VBW \geq RBW

Sweep = auto

Detector function = peak

Trace = max hold

5.6.4 Test Result

Please refer to ANNEX A.5.

5.7 Band Edge

5.7.1 Limit

FCC §15.209&15.247(d)

In any 100 kHz bandwidth outside the frequency band in which the spread spectrum or digitally modulated intentional radiator is operating, the radio frequency power that is produced by the intentional radiator shall be at least 20 dB below that in the 100 kHz bandwidth within the band that contains the highest level of the desired power, based on either an RF conducted or a radiated measurement.

5.7.2 Test Setup

See section 4.4.1 for test setup description for the antenna port. The photo of test setup please refer to ANNEX B.

5.7.3 Test Procedure

The following procedures may be used to determine the peak or average field strength or power of an unwanted emission that is within 2 MHz of the authorized band edge. If a peak detector is utilized, use the procedure described in 13.2.1. Use the procedure described in 13.2.2 when using an average detector and the EUT can be configured to transmit continuously (i.e., duty cycle $\geq 98\%$). Use the procedure described in 13.2.3 when using an average detector and the EUT cannot be configured to transmit continuously but the duty cycle is constant (i.e., duty cycle variations are less than ± 2 percent). Use the procedure described in 13.2.4 when using an average detector for those cases where the EUT cannot be configured to transmit continuously and the duty cycle is not constant (duty cycle variations equal or exceed 2 percent).

When using a peak detector to measure unwanted emissions at or near the band edge (within 2 MHz of the authorized band), the following integration procedure can be used.

Set instrument center frequency to the frequency of the emission to be measured (must be within 2 MHz of the authorized band edge).

Set span to 2 MHz

RBW = 100 kHz.

VBW $\geq 3 \times$ RBW.

Detector = peak.

Sweep time = auto.

Trace mode = max hold.

Allow sweep to continue until the trace stabilizes (required measurement time may increase for low duty cycle applications)

Compute the power by integrating the spectrum over 1 MHz using the analyzer's band power measurement function with band limits set equal to the emission frequency (femission) ± 0.5 MHz. If the instrument does not have a band power function, then sum the amplitude levels (in power units) at 100 kHz intervals extending across the 1 MHz spectrum defined by femission ± 0.5 MHz.

5.7.4 Test Result

Please refer to ANNEX A.6.

5.8 Power Spectral density (PSD)

5.8.1 Limit

FCC §15.247(e)

The same method of determining the conducted output power shall be used to determine the power spectral density. If a peak output power is measured, then a peak power spectral density measurement is required. If an average output power is measured, then an average power spectral density measurement should be used.

5.8.2 Test Setup

See section 4.4.1 for test setup description for the antenna port. The photo of test setup please refer to ANNEX B.

5.8.3 Test Procedure

Set analyzer center frequency to DTS channel center frequency.

Set the span to 1.5 times the DTS bandwidth.

Set the RBW to: $3 \text{ kHz} \leq \text{RBW} \leq 100 \text{ kHz}$.

Set the VBW ≥ 3 RBW.

Detector = peak.

Sweep time = auto couple.

Trace mode = max hold.

Allow trace to fully stabilize.

Use the peak marker function to determine the maximum amplitude level within the RBW.

If measured value exceeds limit, reduce RBW (no less than 3 kHz) and repeat.

5.8.4 Test Result

Please refer to ANNEX A.7.

ANNEX A TEST RESULT

A.1 Output Power

Duty Cycle

Band	Duty Cycle (%)	T (ms)	1/T(kHz)
GFSK	0.63	0.4067	2.4588

Peak Power Test Data

Channel	Measured Output Peak Power		Limit		Verdict
	dBm	mW	dBm	mW	
Low	4.44	2.78	30	1000	Pass
Middle	6.20	4.17			Pass
High	7.26	5.32			Pass

Peak Power Test Plots

LOW CHANNEL

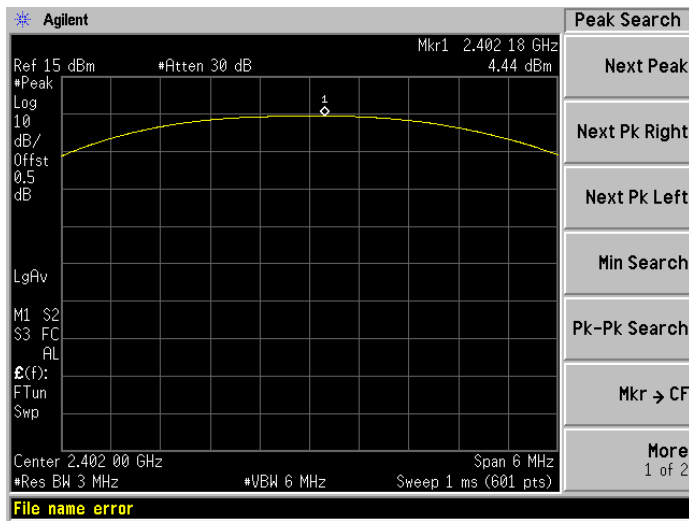

MIDDLE CHANNEL

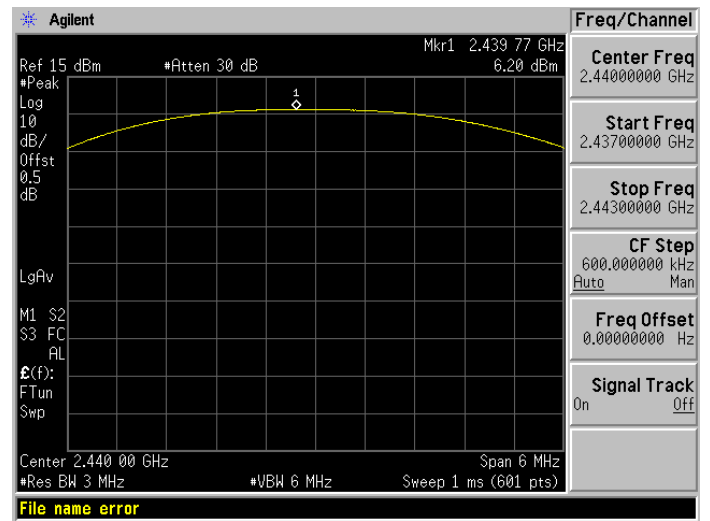

HIGH CHANNEL

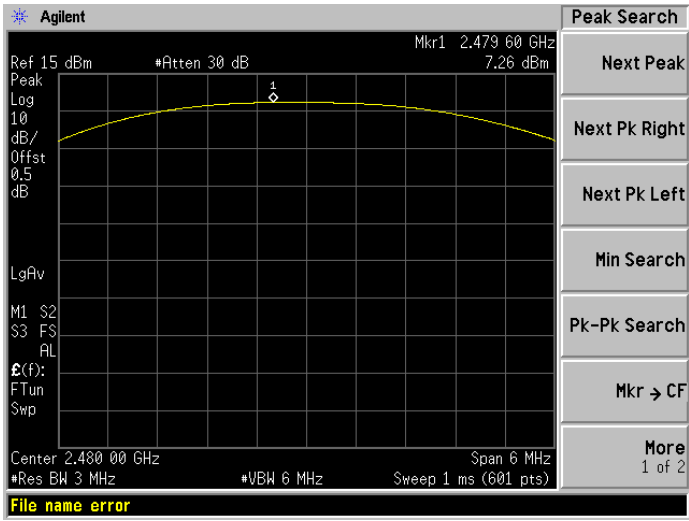

A.2 Bandwidth

Test Data

Channel	6 dB Bandwidth (kHz)	99% Bandwidth (MHz)	Limits (kHz)
Low Channel	707.168	1.0517	≥500
Middle Channel	699.907	1.0535	≥500
High Channel	698.944	1.0595	≥500

Test plots

LOW CHANNEL

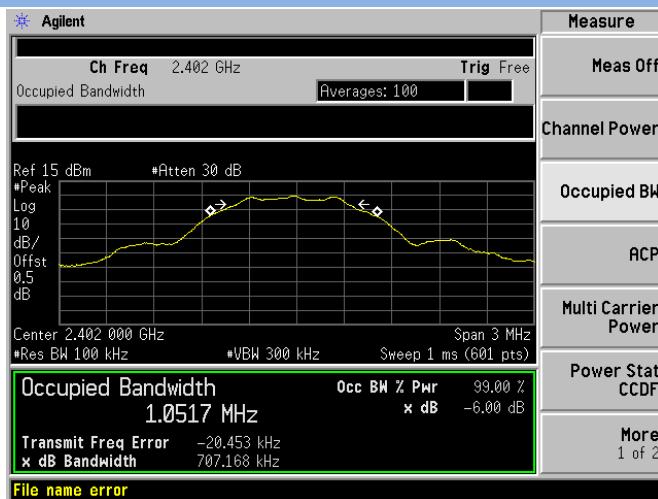

MIDDLE CHANNEL

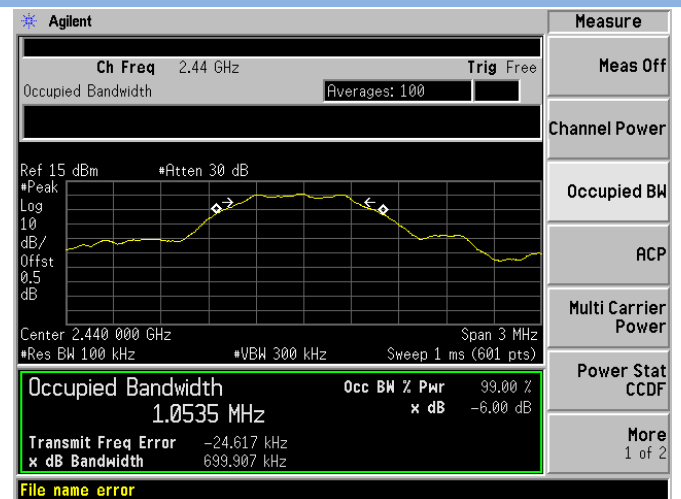

HIGH CHANNEL

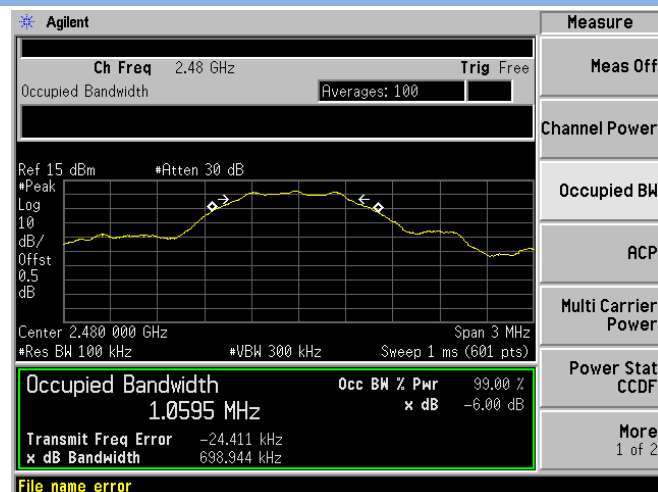

A.3 Conducted Spurious Emissions

Test Data

Channel	Measured Max. Out of Band Emission (dBm)	Limit (dBm)		Verdict
		Carrier Level	Calculated 20 dBc Limit	
Low Channel	-42.18	4.23	-15.77	Pass
Middle Channel	-44.67	5.99	-14.01	Pass
High Channel	-45.15	7.04	-12.96	Pass

Test Plots

LOW CHANNEL CARRIER LEVEL

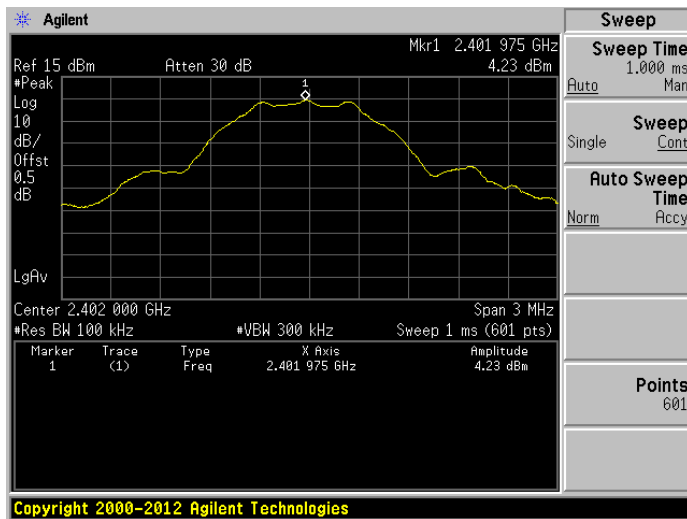

LOW CHANNEL, SPURIOUS 30 MHz ~ 3 GHz

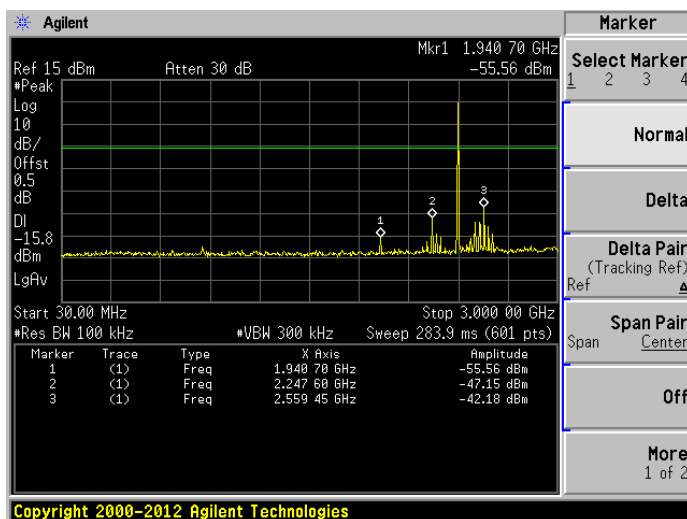

LOW CHANNEL, SPURIOUS 2 GHz ~ 25 GHz

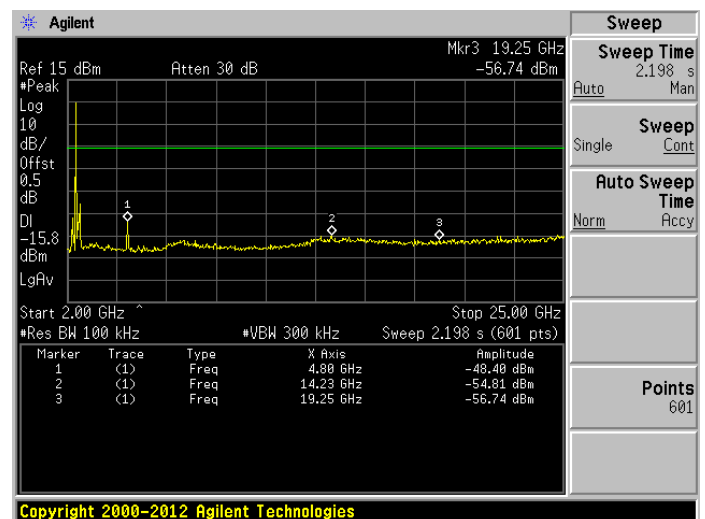

MIDDLE CHANNEL CARRIER LEVEL

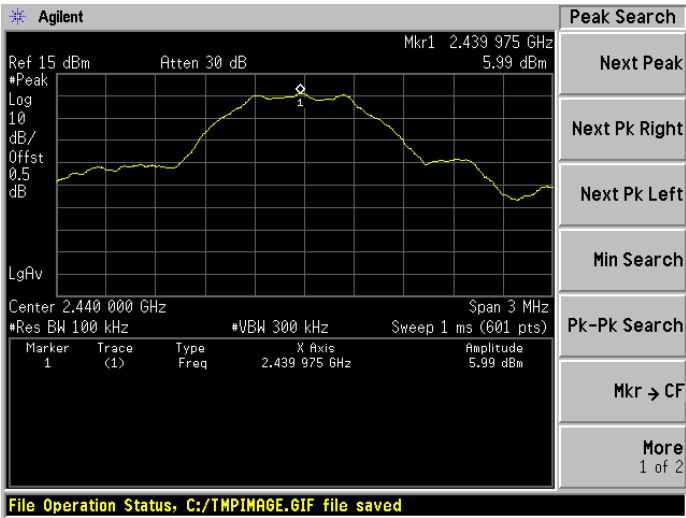

MIDDLE CHANNEL, SPURIOUS 30 MHz ~ 3 GHz

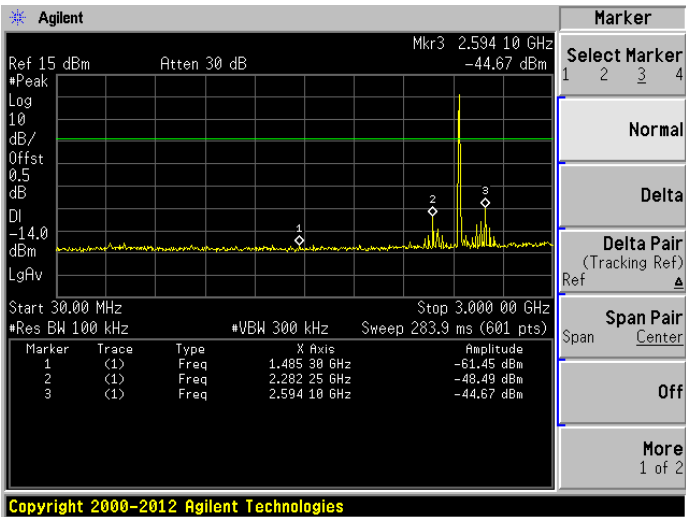

MIDDLE CHANNEL, SPURIOUS 2 GHz ~ 25 GHz

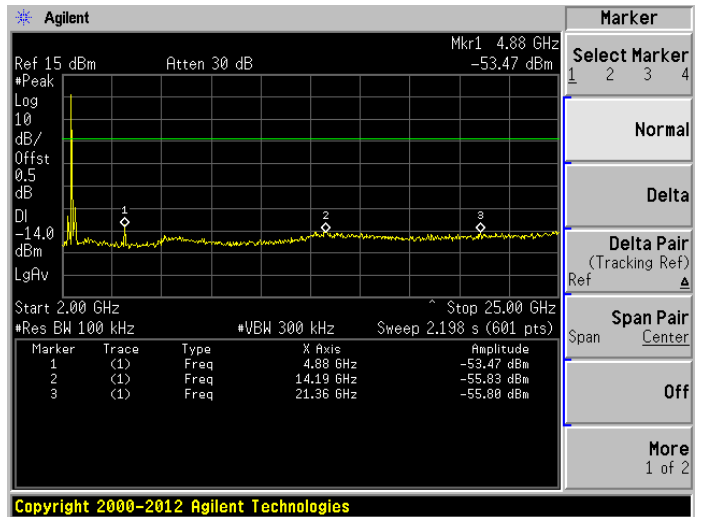

HIGH CHANNEL CARRIER LEVEL

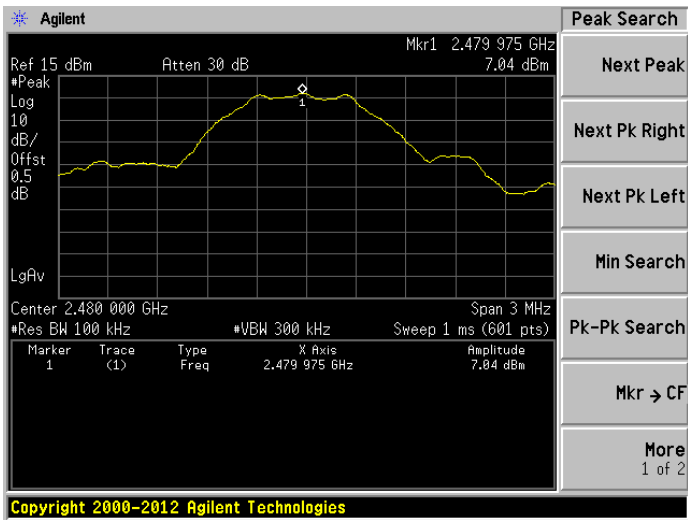

HIGH CHANNEL, SPURIOUS 30 MHz ~ 3GHz

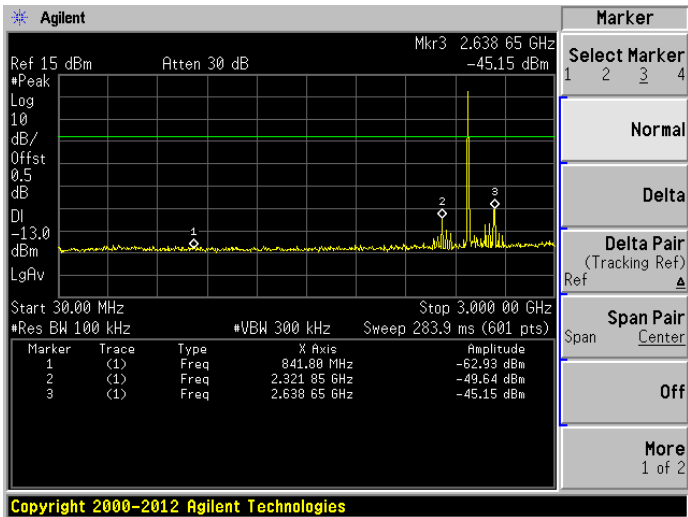

HIGH CHANNEL, SPURIOUS 2 GHz ~ 25 GHz

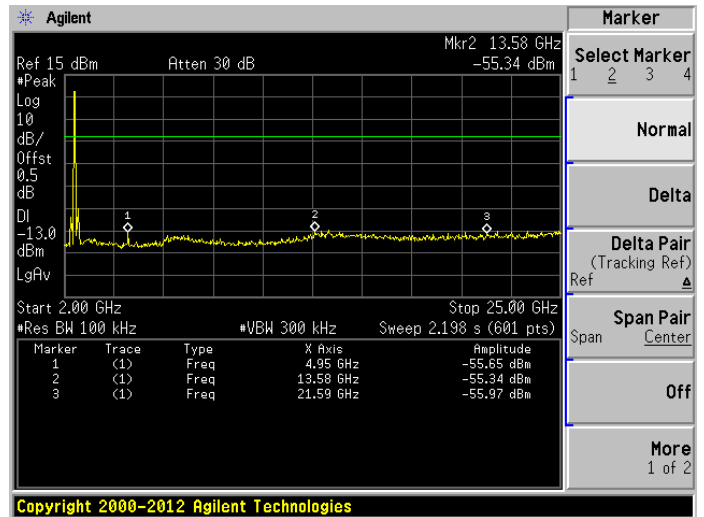

A.4 Conducted Emissions

Note: All configurations have been tested, only the worst configuration (GFSK High Channel) shown here.

Test Data and Test Plots

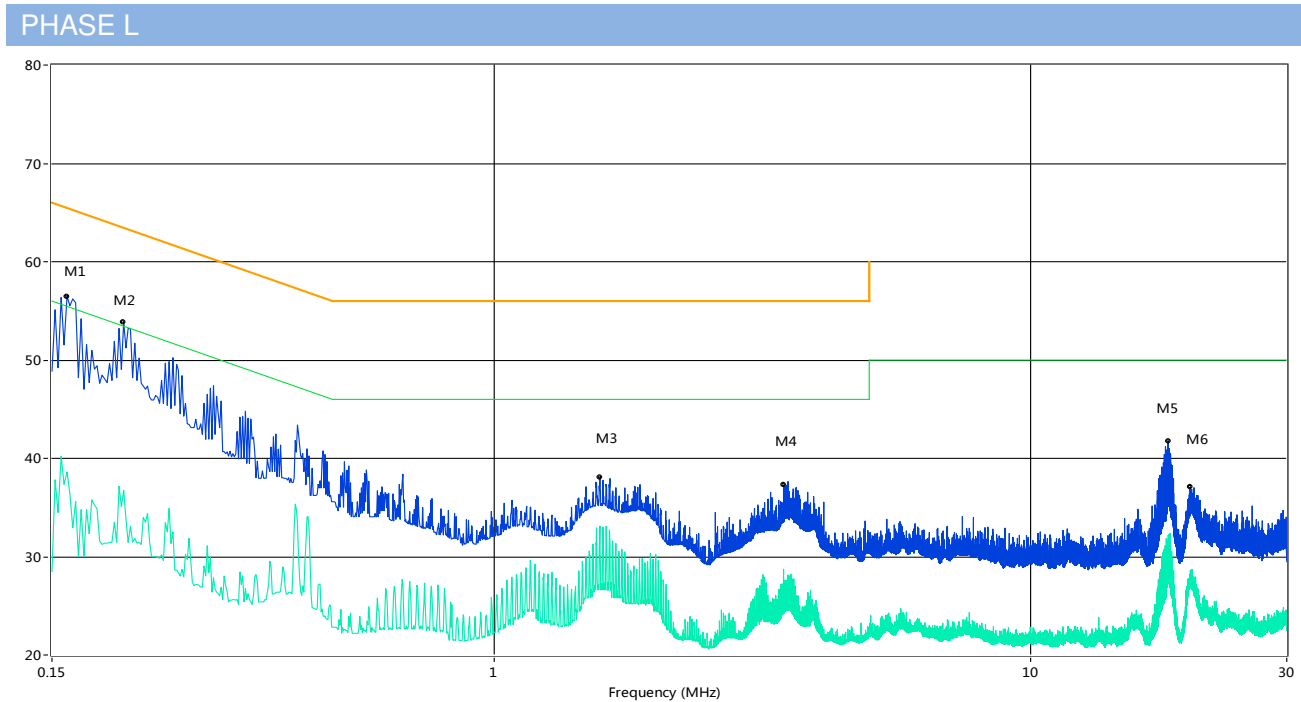

No.	Frequency (MHz)	Results (dBuV)	Factor (dB)	Limit (dBuV)	Margin (dB)	Detector	Line	Verdict
1	0.16	56.5	13.00	65.7	9.20	Peak	L Line	Pass
1**	0.16	38.6	13.00	55.7	17.10	AV	L Line	Pass
2	0.20	53.8	13.00	64.5	10.70	Peak	L Line	Pass
2**	0.20	36.8	13.00	54.5	17.70	AV	L Line	Pass
3	1.57	38.1	13.00	56.0	17.90	Peak	L Line	Pass
3**	1.57	33.1	13.00	46.0	12.90	AV	L Line	Pass
4	3.46	37.3	13.00	56.0	18.70	Peak	L Line	Pass
4**	3.46	28.7	13.00	46.0	17.30	AV	L Line	Pass
5	18.03	41.7	13.00	60.0	18.30	Peak	L Line	Pass
5**	18.03	30.9	13.00	50.0	19.10	AV	L Line	Pass
6	19.84	37.0	13.00	60.0	23.00	Peak	L Line	Pass
6**	19.84	27.5	13.00	50.0	22.50	AV	L Line	Pass

PHASE N

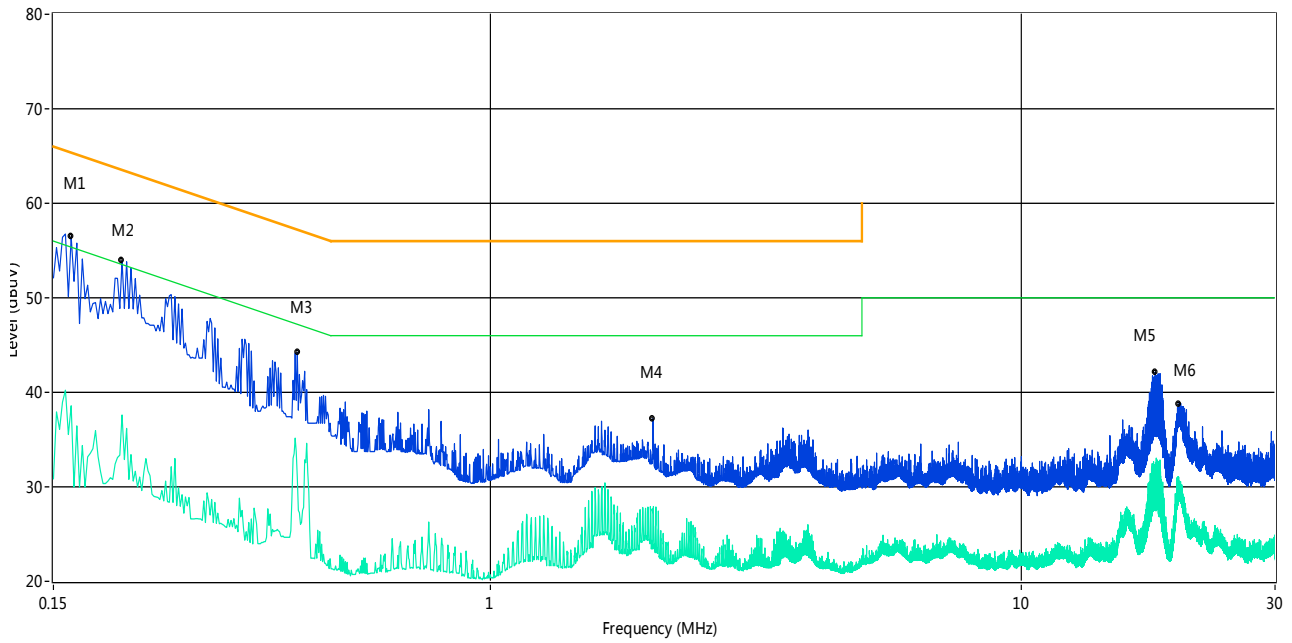

No.	Frequency (MHz)	Results (dBuV)	Factor (dB)	Limit (dBuV)	Margin (dB)	Detector	Line	Verdict
1	0.16	56.5	13.00	65.7	9.20	Peak	N Line	Pass
1**	0.16	38.6	13.00	55.7	17.10	AV	N Line	Pass
2	0.20	53.9	13.00	64.5	10.60	Peak	N Line	Pass
2**	0.20	37.6	13.00	54.5	16.90	AV	N Line	Pass
3	0.43	44.2	13.00	57.9	13.70	Peak	N Line	Pass
3**	0.43	31.0	13.00	47.9	16.90	AV	N Line	Pass
4	2.02	37.2	13.00	56.0	18.80	Peak	N Line	Pass
4**	2.02	27.7	13.00	46.0	18.30	AV	N Line	Pass
5	17.84	42.1	13.00	60.0	17.90	Peak	N Line	Pass
5**	17.84	31.7	13.00	50.0	18.30	AV	N Line	Pass
6	19.77	38.7	13.00	60.0	21.30	Peak	N Line	Pass
6**	19.77	29.3	13.00	50.0	20.70	AV	N Line	Pass

A.5 Radiated Emission

Antenna-port Conducted test data

$$E = \text{EIRP} - 20 \log D + 104.8$$

where:

E = electric field strength in dB μ V/m,

EIRP = equivalent isotropic radiated power in dBm

D = specified measurement distance in meters.

EIRP= Measure Conducted output power Value (dBm) + Maximum transmit antenna gain (dBi) + the appropriate maximum ground reflection factor (dB)

Note: Below 1GHz, all configure were tested but only the worst data (GFSK Low Channel)) was reported in this report.

The EIRP based on the measured conducted power, the upper bound on antenna gain for a device with a single RF output shall be selected as the maximum in-band gain of the antenna across all operating bands, or 2dBi, whichever is greater.

And the maximum in-band gain of the antenna is -3.0 dBi

Note 1: The frequency is fundamental signal which can be ignored.

Note 2: Which frequency is not within a restricted band, and its limit line is 20dB below the highest emission level.

Note 3: Average measurement was not performed if peak level went lower than the average limit.

Note 4: The harmonic (3th ,4th, 5th,...etc.) and other spurious are not reported, because those levels are lower than average limit line and background noise

Frequency (MHz)	Value (dBm)	Ground Reflection Factor (dB)	D(m)	Max gain(dBi)	Detector	E (dB μ V/m)	Limit (dB μ V/m)	Margin (dB)	Remark	Verdict
0.010645	-85.53	6	3	2	QP	17.73	81.25	63.52	Note 2	Pass
5.32	-68.06	6	3	2	QP	35.20	81.25	46.05	Note 2	Pass
30	-68.32	4.7	3	2	QP	33.64	81.25	47.61	Note 2	Pass
817.3	-80.96	4.7	3	2	QP	21.00	81.25	60.25	Note 2	Pass
4800	-44.83	0	3	2	PK	52.43	74.00	21.57	--	Pass
	-48.57		3	2	AV	48.69	54.00	5.31	--	Pass
14240	-45.22	0	3	2	PK	52.04	81.25	29.21	--	Pass
	N/A		3	2	AV	N/A	61.25	N/A	Note 3	Pass
2400	3.99	0	3	2	PK	101.25	N/A	N/A	Note 1	N/A
	0.25		3	2	AV	97.51	N/A	N/A		N/A

Test Plots

LOW CHANNEL, SPURIOUS 9 kHz ~ 150 kHz

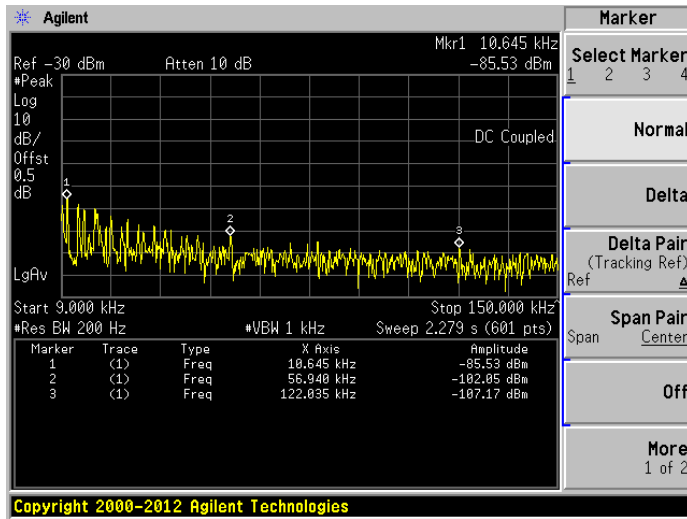

LOW CHANNEL, SPURIOUS 150 kHz ~ 30 MHz

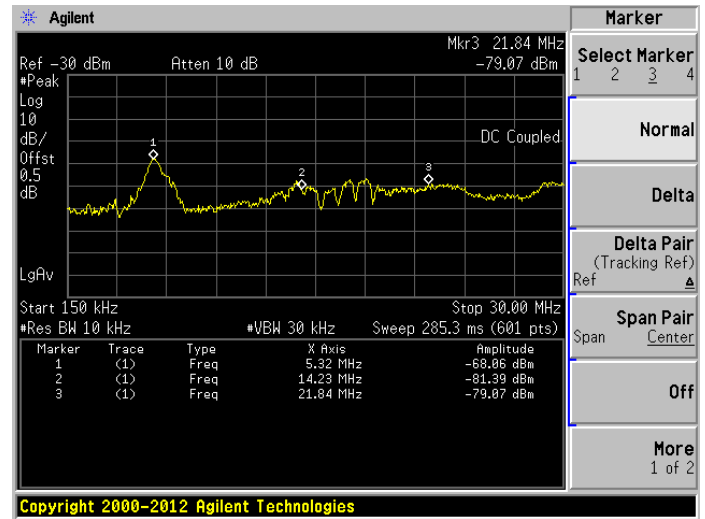

LOW CHANNEL, SPURIOUS 30 MHz ~ 1 GHz

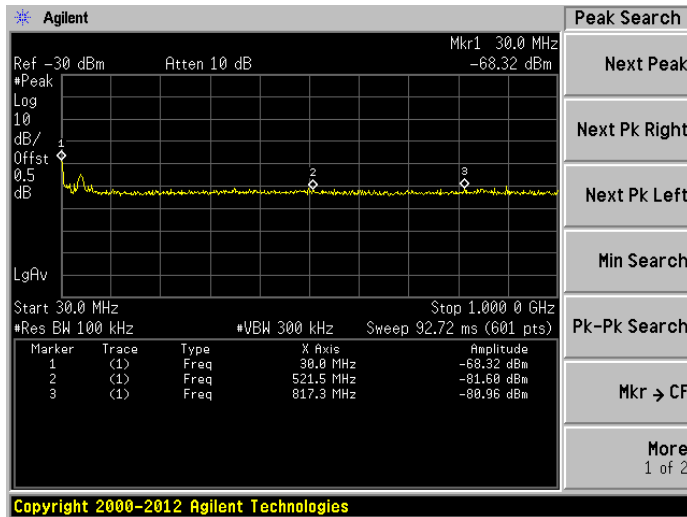

LOW CHANNEL, SPURIOUS 1 GHz ~ 25 GHz

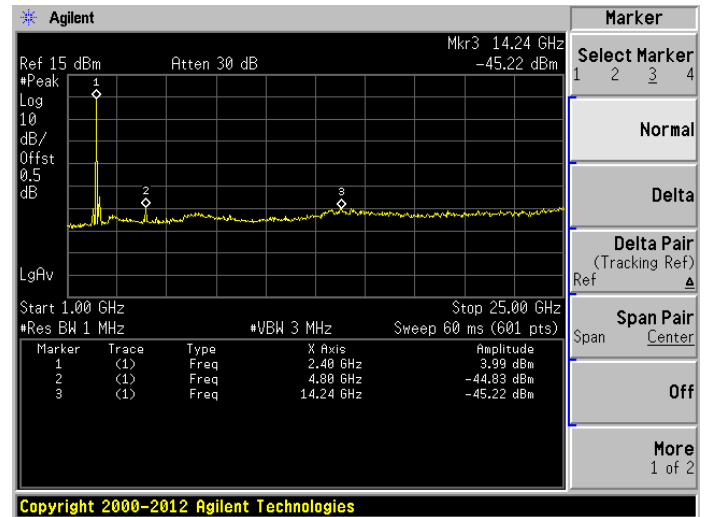

The EIRP based on the measured conducted power, the upper bound on antenna gain for a device with a single RF output shall be selected as the maximum in-band gain of the antenna across all operating bands, or 2dBi, whichever is greater.

And the maximum in-band gain of the antenna is -3.0 dBi

Note 1: The frequency is fundamental signal which can be ignored.

Note 2: Which frequency is not within a restricted band, and its limit line is 20dB below the highest emission level.

Note 3: Average measurement was not performed if peak level went lower than the average limit.

Note 4: The harmonic (3th ,4th, 5th,...etc.) and other spurious are not reported, because those levels are lower than average limit line and background noise

Frequency (MHz)	Value (dBm)	Ground Reflection Factor (dB)	D(m)	Max gain(dBi)	Detector	E (dBμV/m)	Limit (dBμV/m)	Margin (dB)	Remark	Verdict
4880	-47.21	0	3	2	PK	50.05	74.00	23.95	--	Pass
	-50.95		3	2	AV	46.31	54.00	7.69	--	Pass
14200	-44.72	0	3	2	PK	52.54	83.04	30.50	--	Pass
	N/A		3	2	AV	N/A	63.04	N/A	Note 3	Pass
2440	5.78	0	3	2	PK	103.04	N/A	N/A	Note 1	N/A
	2.04		3	2	AV	99.30	N/A	N/A		N/A

Test Plots

MIDDLE CHANNEL, SPURIOUS 1 GHz ~ 25 GHz

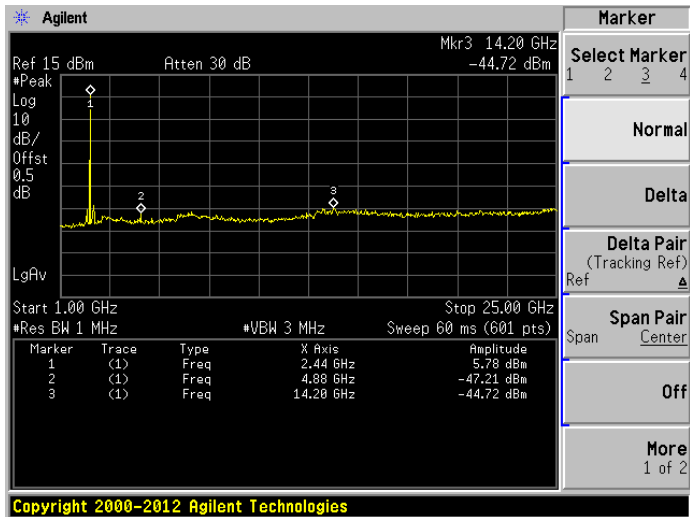

The EIRP based on the measured conducted power, the upper bound on antenna gain for a device with a single RF output shall be selected as the maximum in-band gain of the antenna across all operating bands, or 2dBi, whichever is greater.

And the maximum in-band gain of the antenna is -3.0 dBi

Note 1: The frequency is fundamental signal which can be ignored.

Note 2: Which frequency is not within a restricted band, and its limit line is 20dB below the highest emission level.

Note 3: Average measurement was not performed if peak level went lower than the average limit.

Note 4: The harmonic (3th ,4th , 5th,...etc.) and other spurious are not reported, because those levels are lower than average limit line and background noise

Frequency (MHz)	Value (dBm)	Ground Reflection Factor (dB)	D(m)	Max gain(dBi)	Detector	E (dBμV/m)	Limit (dBμV/m)	Margin (dB)	Remark	Verdict
4960	-48.12	0	3	2	PK	49.14	74.00	24.86	--	Pass
	-51.86		3	2	AV	45.40	54.00	8.60	--	Pass
14200	-44.57	0	3	2	PK	52.69	83.98	31.29	--	Pass
	N/A		3	2	AV	N/A	63.98	N/A	Note 3	Pass
2480	6.72	0	3	2	PK	103.98	N/A	N/A	Note 1	N/A
	2.98		3	2	AV	100.24	N/A	N/A		N/A

Test Plots

HIGH CHANNEL, SPURIOUS 1 GHz ~ 25 GHz

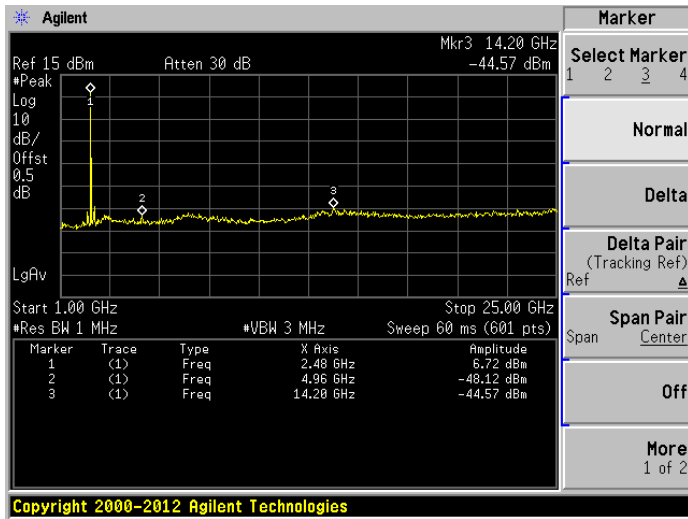

Cabinet Radiated spurious emission test

Note 1: The symbol of "--" in the table which means not application.

Note 2: For the test data above 1 GHz, according the ANSI C63.4-2014, where limits are specified for both average and peak (or quasi-peak) detector functions, if the peak (or quasi-peak) measured value complies with the average limit, it is unnecessary to perform an average measurement.

Note 3: The low frequency, which started from 9 kHz to 30 MHz, was pre-scanned and the result which was 20 dB lower than the limit line per 15.31(o) was not reported.

Note 4: All configure were tested but only the worst data (GFSK Low Channel)) was reported in this report.

30 MHz to 1 GHz, ANT V

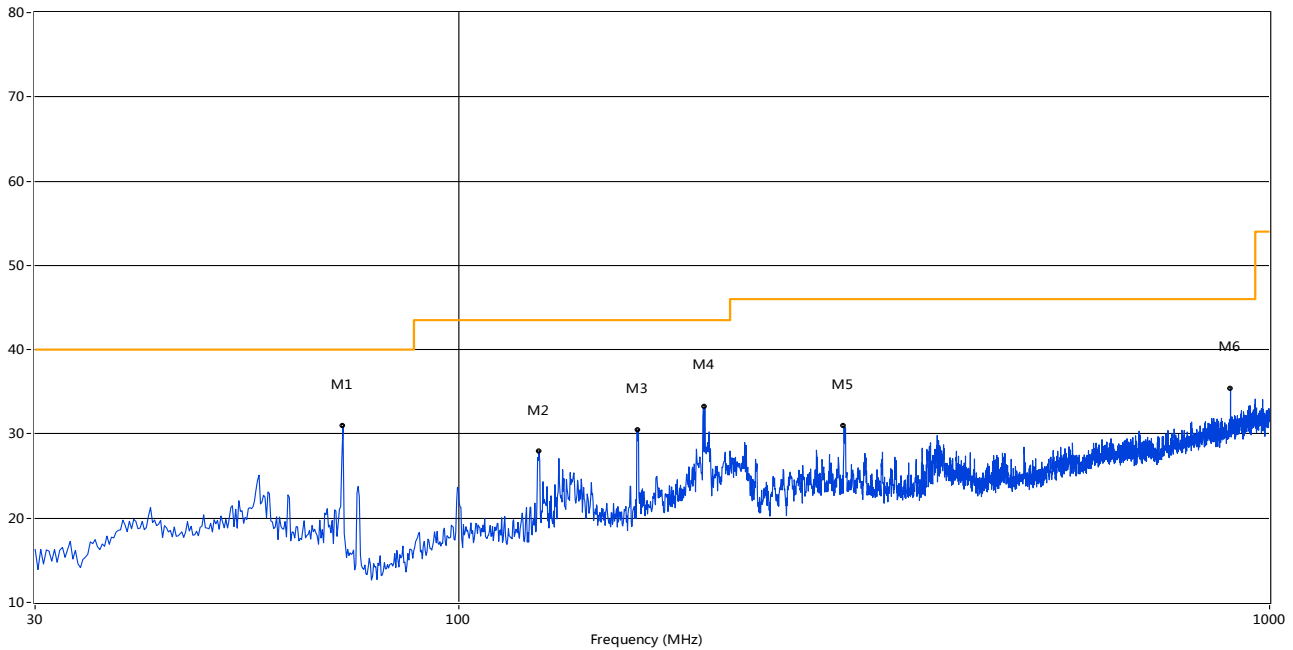

No.	Frequency (MHz)	Results (dBuV/m)	Factor (dB)	Limit (dBuV/m)	Margin (dB)	Detector	Table (o)	Height (cm)	ANT	Verdict
1	71.94	30.90	-23.54	40.0	9.10	Peak	80.70	100	Vertical	Pass
2	125.52	27.87	-22.52	43.5	15.63	Peak	116.10	100	Vertical	Pass
3	166.49	30.49	-22.87	43.5	13.01	Peak	326.40	100	Vertical	Pass
4	201.16	33.23	-20.22	43.5	10.27	Peak	181.70	100	Vertical	Pass
5	298.62	30.91	-17.68	46.0	15.09	Peak	95.80	100	Vertical	Pass
6	895.02	35.34	-5.74	46.0	10.66	Peak	141.20	100	Vertical	Pass

30 MHz to 1 GHz, ANT H

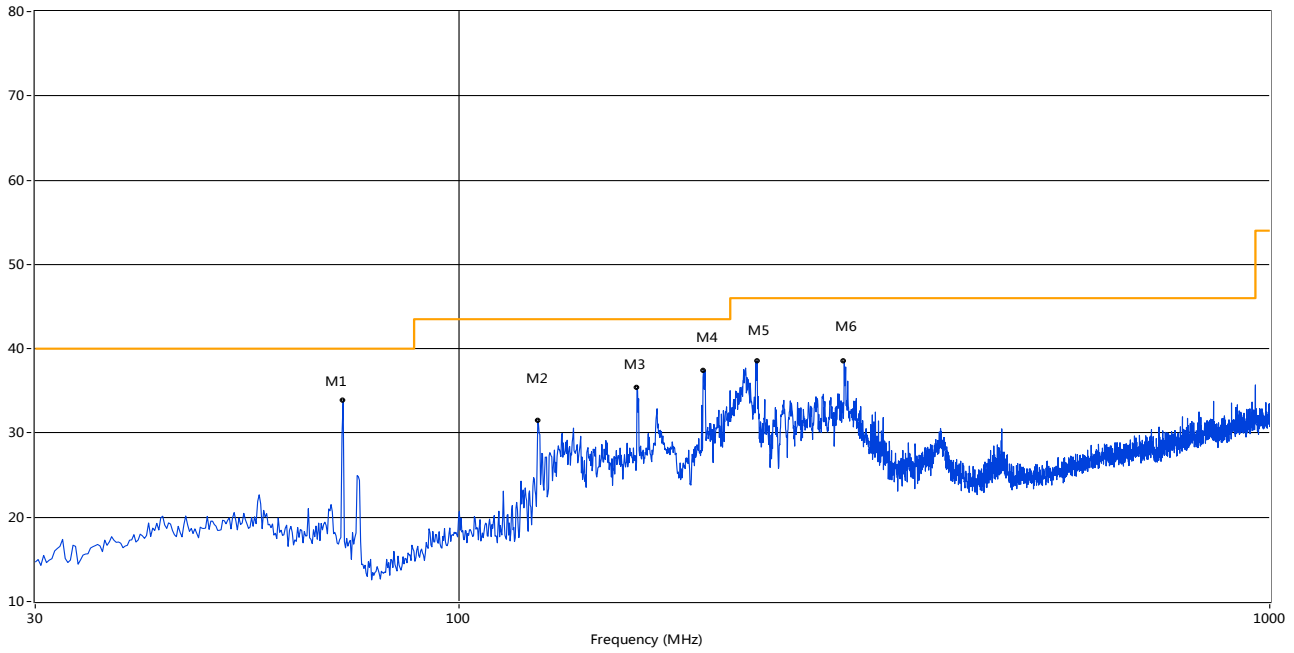

No.	Frequency (MHz)	Results (dBuV/m)	Factor (dB)	Limit (dBuV/m)	Margin (dB)	Detector	Table (o)	Height (cm)	ANT	Verdict
1	71.94	33.79	-23.54	40.0	6.21	Peak	12.50	100	Horizontal	Pass
2	125.04	31.43	-22.49	43.5	12.07	Peak	32.90	100	Horizontal	Pass
3	165.77	35.32	-22.91	43.5	8.18	Peak	52.80	100	Horizontal	Pass
4	200.44	37.40	-20.18	43.5	6.10	Peak	88.10	100	Horizontal	Pass
5	233.16	38.55	-19.51	46.0	7.45	Peak	32.90	100	Horizontal	Pass
6	298.62	38.47	-17.68	46.0	7.53	Peak	88.10	100	Horizontal	Pass

1 GHz to 25 GHz, ANT V

RE Test case_FCC 15C 1GHz-25GHz

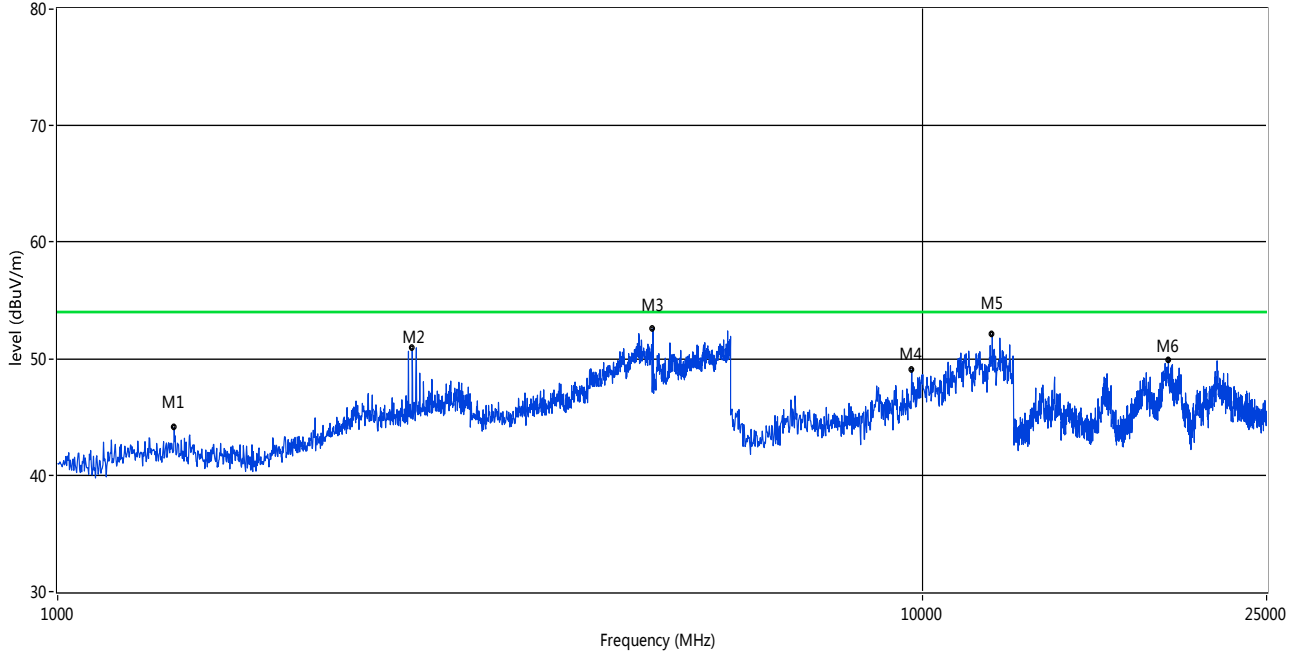

No.	Frequency (MHz)	Results (dBuV/m)	Factor (dB)	Limit (dBuV/m)	Margin (dB)	Detector	Table (o)	Height (cm)	ANT	Verdict
1	1363.64	44.07	-4.44	74.0	29.93	Peak	335.00	100	Vertical	Pass
2	2570.43	50.85	0.14	74.0	23.15	Peak	225.00	100	Vertical	Pass
3	4882.12	52.59	13.60	74.0	21.41	Peak	198.00	100	Vertical	Pass
4	9717.55	49.03	17.74	74.0	24.97	Peak	188.00	100	Vertical	Pass
5	12042.43	52.06	20.83	74.0	21.94	Peak	295.00	100	Vertical	Pass
6	19249.58	49.84	13.82	74.0	24.16	Peak	256.00	100	Vertical	Pass

1 GHz to 25 GHz, ANT H

RE Test case_FCC 15C 1GHz-25GHz

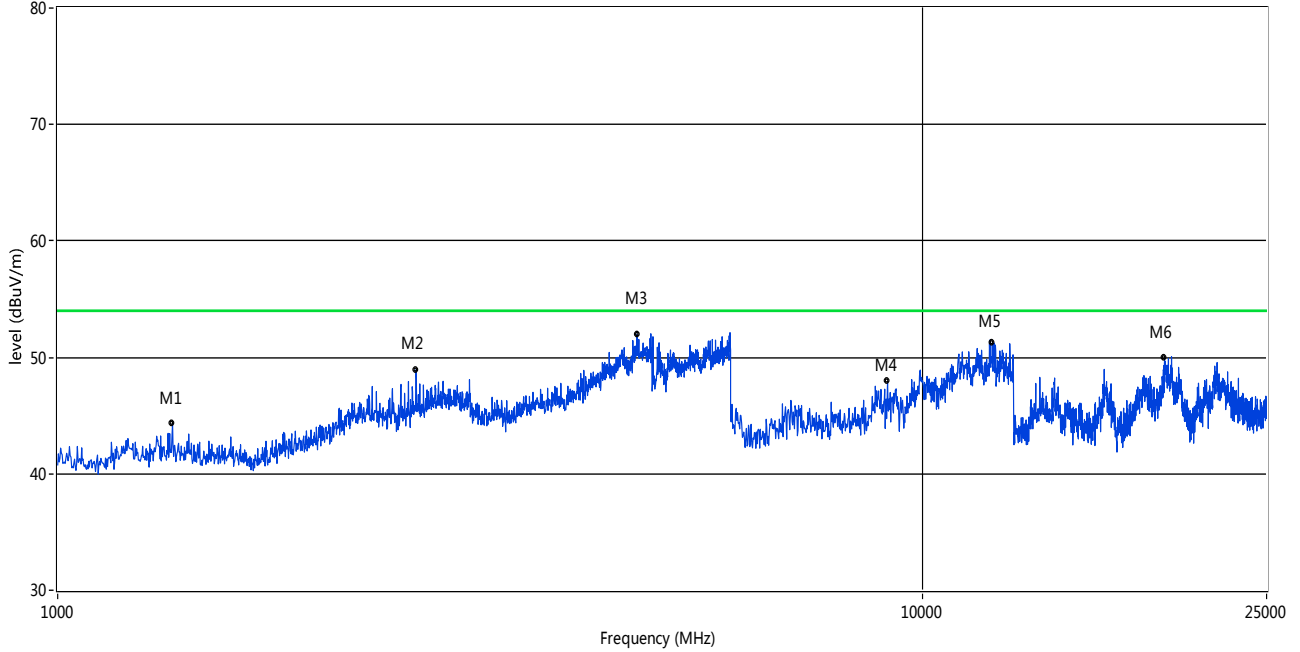

No.	Frequency (MHz)	Results (dBuV/m)	Factor (dB)	Limit (dBuV/m)	Margin (dB)	Detector	Table (o)	Height (cm)	ANT	Verdict
1	1357.64	44.37	-4.44	74.0	29.63	Peak	2.00	100	Horizontal	Pass
2	2596.40	48.94	0.54	74.0	25.06	Peak	323.00	100	Horizontal	Pass
3	4675.32	51.96	13.12	74.0	22.04	Peak	66.00	100	Horizontal	Pass
4	9111.07	47.91	17.02	74.0	26.09	Peak	319.00	100	Horizontal	Pass
5	12042.43	52.06	20.83	74.0	21.94	Peak	295.00	100	Horizontal	Pass
6	19049.92	49.92	13.57	74.0	24.08	Peak	138.00	100	Horizontal	Pass

A.6 Band Edge

Test Data

The lowest and highest channels are tested to verify the band edge emissions. Please refer to the following the plots for emissions values.

Test Data

Channel	Measured Max. Band Edge Emission (dBm)	Limit (dBm)		Verdict
		Carrier Level	Calculated 20 dBc Limit	
Low Channel	-36.11	4.23	-15.77	Pass
High Channel	-30.20	7.04	-12.96	Pass

Test Plots

LOW CHANNEL, Carrier level

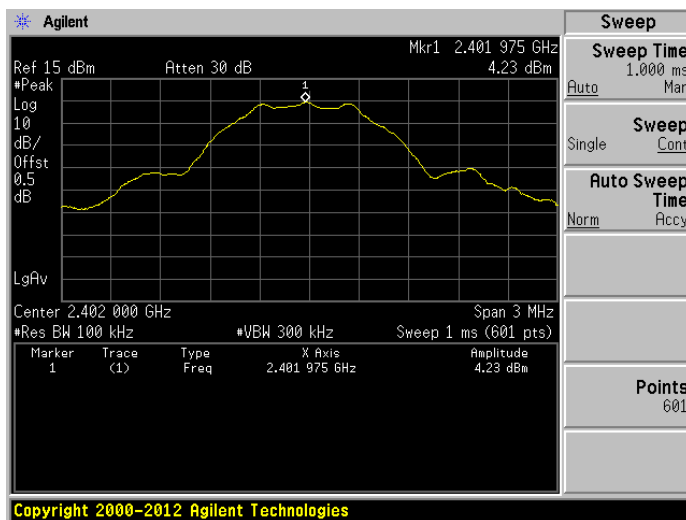

LOW CHANNEL, Reference level

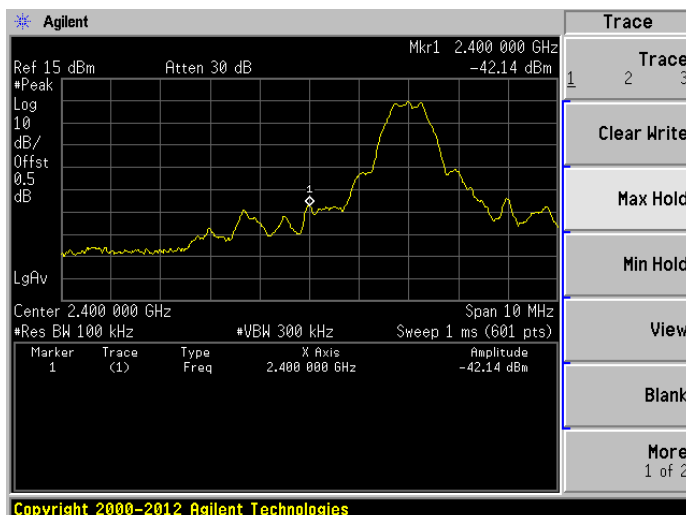

LOW CHANNEL, Band Edge

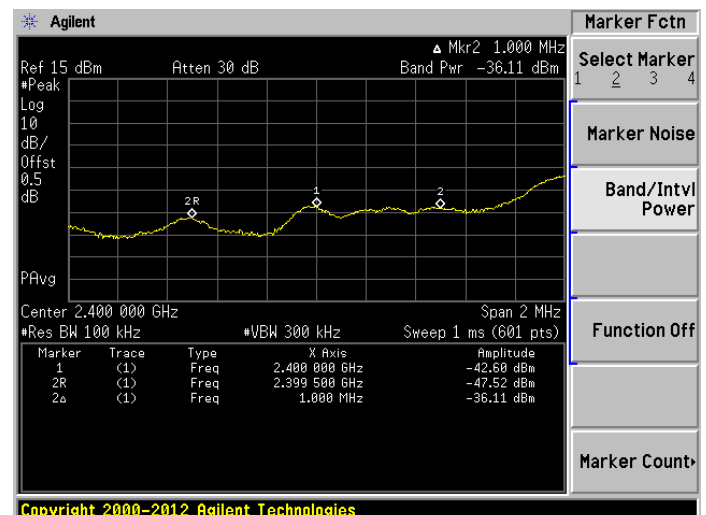

High CHANNEL, Carrier level

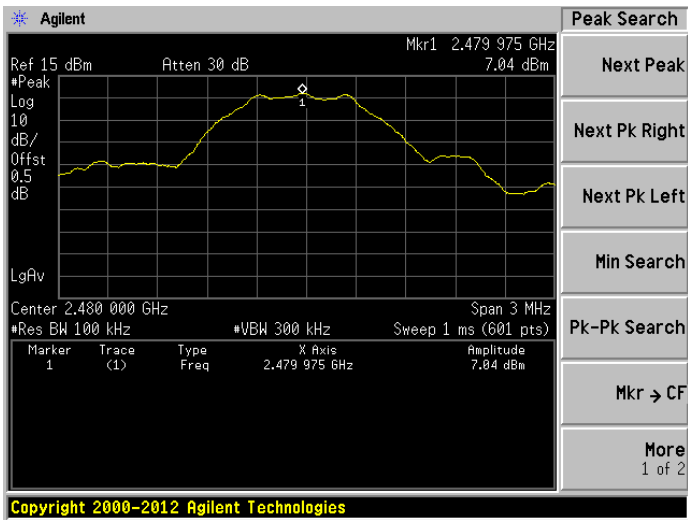

HIGH CHANNEL, Reference level

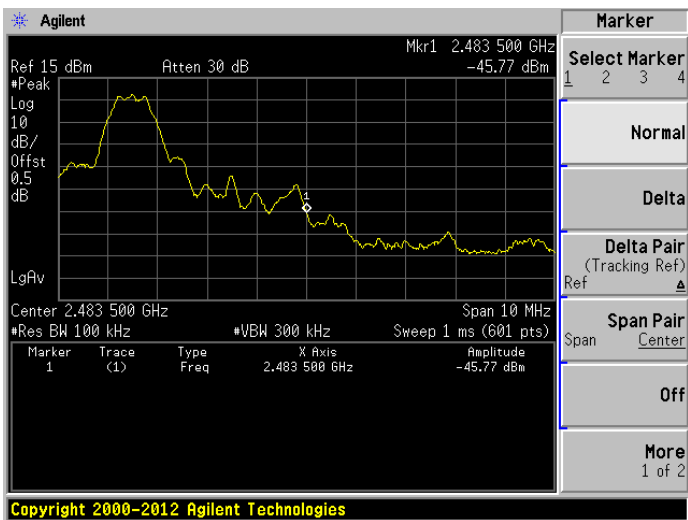

HIGH CHANNEL, Band Edge

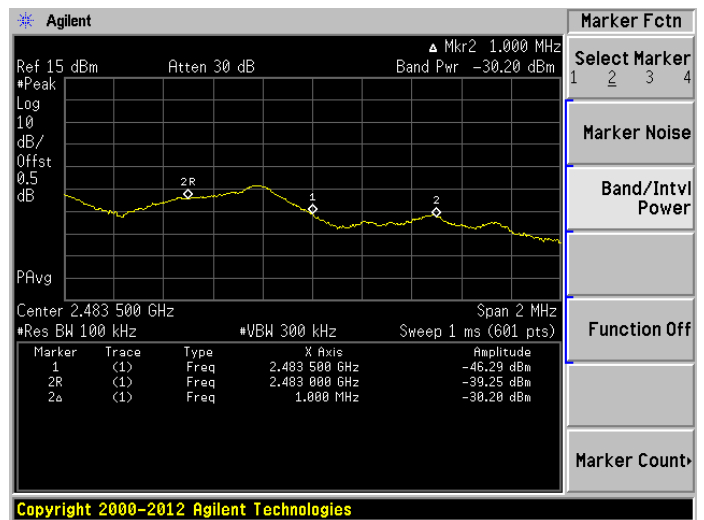

A.7 Power Spectral Density (PSD)

Test Data

Channel	Spectral power density (dBm/3kHz)	Limit (dBm/3kHz)	Verdict
Low Channel	-11.12	8	Pass
Middle Channel	-8.98	8	Pass
High Channel	-7.95	8	Pass

Test plots

LOW CHANNEL

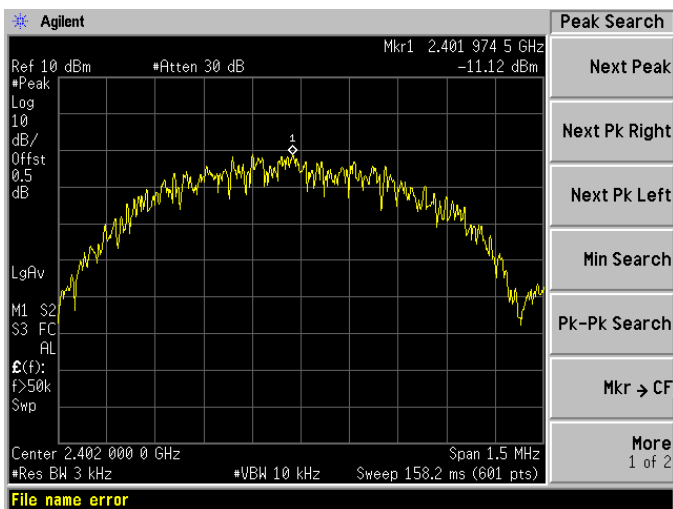

MIDDLE CHANNEL

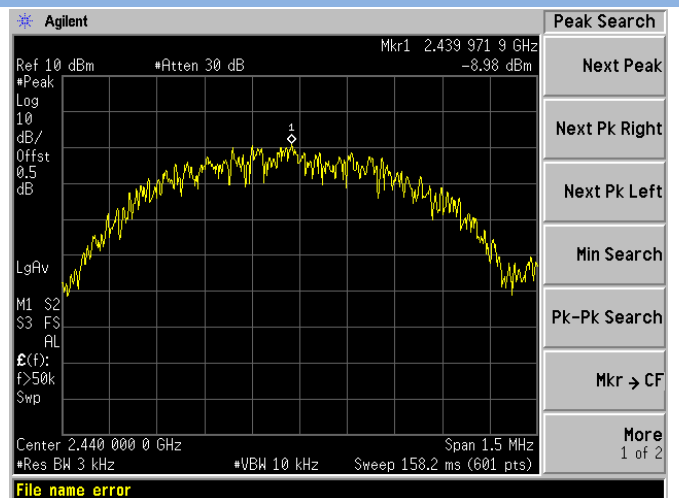

HIGH CHANNEL

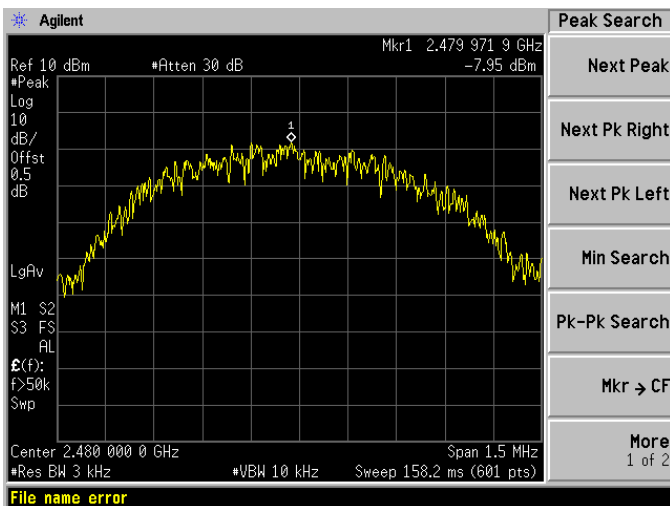

ANNEX B TEST SETUP PHOTOS

Please refer the document "BL-SZ15B0130-AR.PDF".

ANNEX C EUT EXTERNAL PHOTOS

Please refer the document "BL-SZ15B0130-AW.PDF".

ANNEX D EUT INTERNAL PHOTOS

Please refer the document "BL-SZ15B0130-AI.PDF".

--END OF REPORT--