



TEST REPORT

Report Reference No...... : **TRE1808019901** R/C.....: 79850

FCC ID..... : **Z36-MP802**

Applicant's name..... : **Raiing Medical Company**

Address.....: FL4-E BLDG.8, Changliu Rd. 738 Machikou Town, Changping Dist. 102200 Beijing, China

Manufacturer.....: Raiing Medical Company

Address.....: FL4-E BLDG.8, Changliu Rd. 738 Machikou Town, Changping Dist. 102200 Beijing, China

Test item description : Remote Patient Monitoring & Diagnostics System

Trade Mark: raiing

Model/Type reference.....: MP802

Listed Model(s): -

Standard : **FCC CFR Title 47 Part 15 Subpart C Section 15.247**

Date of receipt of test sample.....: Aug.28,2018

Date of testing.....: Aug.28,2018 ~ Sep.21,2018

Date of issue.....: Sep.25,2018

Result.....: **PASS**

Compiled by
(Position+Printed name+Signature) : File administrators Yueming Li *Yueming Li*

Supervised by
(Position+Printed name+Signature) : Project Engineer Tom Ouyang *Tom ouyang*

Approved by
(Position+Printed name+Signature) : RF Manager Hans Hu *Hans Hu*

Testing Laboratory Name : **Shenzhen Huatongwei International Inspection Co., Ltd.**

Address.....: 1/F, Bldg 3, Hongfa Hi-tech Industrial Park, Genyu Road, Tianliao, Gongming, Shenzhen, China

Shenzhen Huatongwei International Inspection Co., Ltd. All rights reserved.

This publication may be reproduced in whole or in part for non-commercial purposes as long as the Shenzhen Huatongwei International Inspection Co., Ltd. is acknowledged as copyright owner and source of the material. Shenzhen Huatongwei International Inspection Co., Ltd. takes no responsibility for and will not assume liability for damages resulting from the reader's interpretation of the reproduced material due to its placement and context.

The test report merely correspond to the test sample.

Contents

1.	<u>TEST STANDARDS AND REPORT VERSION</u>	3
1.1.	Test Standards	3
1.2.	Report version	3
2.	<u>TEST DESCRIPTION</u>	4
3.	<u>SUMMARY</u>	5
3.1.	Client Information	5
3.2.	Product Description	5
3.3.	Operation state	6
3.4.	EUT configuration	6
3.5.	Modifications	6
4.	<u>TEST ENVIRONMENT</u>	7
4.1.	Address of the test laboratory	7
4.2.	Test Facility	7
4.3.	Environmental conditions	8
4.4.	Statement of the measurement uncertainty	8
4.5.	Equipments Used during the Test	9
5.	<u>TEST CONDITIONS AND RESULTS</u>	11
5.1.	Antenna Requirement	11
5.2.	Conducted Emissions (AC Main)	12
5.3.	Conducted Peak Output Power	15
5.4.	Power Spectral Density	16
5.5.	6dB bandwidth	18
5.6.	Restricted band	20
5.7.	Band edge and Spurious Emissions (conducted)	22
5.8.	Spurious Emissions (radiated)	27
6.	<u>TEST SETUP PHOTOS</u>	31
7.	<u>EXTERANAL AND INTERNAL PHOTOS</u>	32

1. TEST STANDARDS AND REPORT VERSION

1.1. Test Standards

The tests were performed according to following standards:

[FCC Rules Part 15.247](#): Frequency Hopping, Direct Spread Spectrum and Hybrid Systems that are in operation within the bands of 902-928 MHz, 2400-2483.5 MHz, and 5725-5850 MHz

[ANSI C63.10:2013](#): American National Standard for Testing Unlicensed Wireless Devices

[KDB 558074 D01 DTS Meas Guidance v05](#): Guidance for Performing Compliance Measurements on Digital Transmission Systems (DTS) Operating under §15.247

1.2. Report version

Revision No.	Date of issue	Description
N/A	2018-09-25	Original

2. TEST DESCRIPTION

Test Item	FCC Rule	Result	Test Engineer
Antenna requirement	15.203/15.247(c)	PASS	Xiaokang Tan
Line Conducted Emissions (AC Main)	15.207	PASS	Tony Duan
Conducted Peak Output Power	15.247(b)(3)	PASS	Xiaokang Tan
Power Spectral Density	15.247(e)	PASS	Xiaokang Tan
6dB Bandwidth	15.247(a)(2)	PASS	Xiaokang Tan
Restricted band	15.247(d)/15.205	PASS	Xiaokang Tan
Spurious Emissions	15.247(d)/15.209	PASS	Xiaokang Tan

Note: The measurement uncertainty is not included in the test result.

3. SUMMARY

3.1. Client Information

Applicant:	Raiing Medical Company
Address:	FL4-E BLDG.8, Changliu Rd. 738 Machikou Town, Changping Dist. 102200 Beijing, China
Manufacturer:	Raiing Medical Company
Address:	FL4-E BLDG.8, Changliu Rd. 738 Machikou Town, Changping Dist. 102200 Beijing, China

3.2. Product Description

Name of EUT:	Remote Patient Monitoring & Diagnostics System
Trade Mark:	raiing
Model No.:	MP802
Listed Model(s):	-
Power supply:	3.7 V
Hardware version:	01 .23
Software version:	00 .01
Bluetooth	
Version:	Supported BT4.0+BLE
Modulation:	GFSK
Operation frequency:	2402MHz~2480MHz
Channel number:	40
Channel separation:	2MHz
Antenna type:	Integral antenna
Antenna gain:	-0.5dBi

3.3. Operation state

➤ Test frequency list

According to section 15.31(m), regards to the operating frequency range over 10 MHz, must select three channel which were tested. the Lowest frequency, the middle frequency, and the highest frequency of channel were selected to perform the test, please see the above gray bottom.

Channel	Frequency (MHz)
00	2402
01	2404
⋮	⋮
19	2440
⋮	⋮
38	2478
39	2480

➤ Test mode

For RF test items
The engineering test program was provided and enabled to make EUT continuous transmit (duty cycle>98%).
For AC power line conducted emissions:
The EUT was set to connect with the Bluetooth instrument under large package sizes transmission.
For Radiated suprious emissions test item:
The engineering test program was provided and enabled to make EUT continuous transmit(duty cycle>98%). The EUT in each of three orthogonal axis emissions had been tested ,but only the worst case (X axis) data Recorded in the report.

3.4. EUT configuration

The following peripheral devices and interface cables were connected during the measurement:

- - supplied by the manufacturer
- - supplied by the lab

/	Manufacturer:	/
	Model No.:	/
/	Manufacturer:	/
	Model No.:	/

3.5. Modifications

No modifications were implemented to meet testing criteria.

4. TEST ENVIRONMENT

4.1. Address of the test laboratory

Laboratory: Shenzhen Huatongwei International Inspection Co., Ltd.

Address: 1/F, Bldg 3, Hongfa Hi-tech Industrial Park, Genyu Road, Tianliao, Gongming, Shenzhen, China

4.2. Test Facility

CNAS-Lab Code: L1225

Shenzhen Huatongwei International Inspection Co., Ltd. has been assessed and proved to be in compliance with CNAS-CL01 Accreditation Criteria for Testing and Calibration Laboratories (identical to ISO/IEC17025: 2005 General Requirements) for the Competence of Testing and Calibration Laboratories.

A2LA-Lab Cert. No.: 3902.01

Shenzhen Huatongwei International Inspection Co., Ltd. EMC Laboratory has been accredited by A2LA for technical competence in the field of electrical testing, and proved to be in compliance with ISO/IEC 17025: 2005 General Requirements for the Competence of Testing and Calibration Laboratories and any additional program requirements in the identified field of testing.

FCC-Registration No.: 762235

Shenzhen Huatongwei International Inspection Co., Ltd. EMC Laboratory has been registered and fully described in a report filed with the FCC (Federal Communications Commission). The acceptance letter from the FCC is maintained in our files.

IC-Registration No.:5377B-1

Two 3m Alternate Test Site of Shenzhen Huatongwei International Inspection Co., Ltd. has been registered by Certification and Engineering Bureau of Industry Canada for the performance of radiated measurements with Registration No.: 5377B-1.

ACA

Shenzhen Huatongwei International Inspection Co., Ltd. EMC Laboratory can also perform testing for the Australian C-Tick mark as a result of our A2LA accreditation.

4.3. Environmental conditions

During the measurement the environmental conditions were within the listed ranges:

Temperature:	15~35°C
Relative Humidity:	30~60 %
Air Pressure:	950~1050mba

4.4. Statement of the measurement uncertainty

The data and results referenced in this document are true and accurate. The reader is cautioned that there may be errors in calibration limits of the equipment and facilities. The measurement uncertainty was calculated for all measurements listed in this test report according to TR-100028-01 "Electromagnetic compatibility and Radio spectrum Matters (ERM); Uncertainties in the measurement of mobile radio equipment characteristics; Part 1" and TR-100028-02 "Electromagnetic compatibility and Radio spectrum Matters (ERM); Uncertainties in the measurement of mobile radio equipment characteristics; Part 2" and is documented in the Shenzhen Huatongwei International Inspection Co., Ltd. quality system according to ISO/IEC 17025. Furthermore, component and process variability of devices similar to that tested may result in additional deviation. The manufacturer has the sole responsibility of continued compliance of the device.

Here after the best measurement capability for Shenzhen Huatongwei International Inspection Co., Ltd. is reported:

Test Items	Measurement Uncertainty	Notes
Transmitter power conducted	0.57 dB	(1)
Transmitter power Radiated	2.20 dB	(1)
Conducted spurious emissions 9kHz~40GHz	1.60 dB	(1)
Radiated spurious emissions 9kHz~40GHz	2.20 dB	(1)
Conducted Emissions 9kHz~30MHz	3.39 dB	(1)
Radiated Emissions 30~1000MHz	4.24 dB	(1)
Radiated Emissions 1~18GHz	5.16 dB	(1)
Radiated Emissions 18~40GHz	5.54 dB	(1)

(1) This uncertainty represents an expanded uncertainty expressed at approximately the 95% confidence level using a coverage factor of k=1.96.

4.5. Equipments Used during the Test

Conducted Emissions						
Item	Test Equipment	Manufacturer	Model No.	Serial No.	Last Cal. (mm-dd-yy)	Next Cal. (mm-dd-yy)
1	EMI Test Receiver	R&S	ESCI	101247	11/11/2017	11/10/2018
2	Artificial Mains	SCHWARZBECK	NNLK 8121	573	11/11/2017	11/10/2018
3	2-Line V-Network	R&S	ESH3-Z5	100049	11/11/2017	11/10/2018
4	Pulse Limiter	R&S	ESH3-Z2	101488	11/11/2017	11/10/2018
5	RF Connection Cable	HUBER+SUHNER	EF400	N/A	11/21/2017	11/20/2018
6	Test Software	R&S	ES-K1	N/A	N/A	N/A

Radiated Emissions						
Item	Test Equipment	Manufacturer	Model No.	Serial No.	Last Cal. (mm-dd-yy)	Next Cal. (mm-dd-yy)
1	Semi-Anechoic Chamber	Albatross projects	SAC-3m-01	C11121	10/16/2016	10/15/2019
2	EMI Test Receiver	R&S	ESCI	100900	11/11/2017	11/10/2018
3	Loop Antenna	R&S	HFH2-Z2	100020	11/20/2017	11/19/2020
4	Ultra-Broadband Antenna	SCHWARZBECK	VULB9163	538	4/5/2017	4/4/2020
5	Horn Antenna	SCHWARZBECK	9120D	1011	3/27/2017	3/26/2020
6	Broadband Horn Antenna	SCHWARZBECK	BBHA9170	BBHA9170 472	3/27/2017	3/26/2020
7	Pre-amplifier	SCHWARZBECK	BBV 9743	9743-0022	10/18/2017	10/17/2018
8	Broadband Pre-amplifier	SCHWARZBECK	BBV 9718	9718-248	10/18/2017	10/17/2018
9	Spectrum Analyzer	R&S	FSP40	100597	11/11/2017	11/10/2018
10	RF Connection Cable	HUBER+SUHNER	RE-7-FL	N/A	11/21/2017	11/20/2018
11	RF Connection Cable	HUBER+SUHNER	RE-7-FH	N/A	11/21/2017	11/20/2018
12	Test Software	Audix	E3	N/A	N/A	N/A
13	Test Software	R&S	ES-K1	N/A	N/A	N/A
14	Turntable	Maturo Germany	TT2.0-1T	N/A	N/A	N/A
15	Antenna Mast	Maturo Germany	CAM-4.0-P-12	N/A	N/A	N/A

RF Conducted Test						
Item	Test Equipment	Manufacturer	Model No.	Serial No.	Last Cal. (mm-dd-yy)	Next Cal. (mm-dd-yy)
1	Spectrum Analyzer	R&S	FSV40	100048	11/11/2017	11/10/2018
2	EXA Signal Analyzer	Agilent	N9020A	184247	9/22/2018	9/21/2019
3	Power Meter	Anritsu	ML249A	N/A	9/22/2018	9/21/2019
4	OSP	R&S	OSP120	101317	N/A	N/A

5. TEST CONDITIONS AND RESULTS

5.1. Antenna Requirement

Requirement

FCC CFR Title 47 Part 15 Subpart C Section 15.203:

An intentional radiator shall be designed to ensure that no antenna other than that furnished by the responsible party shall be used with the device. The use of a permanently attached antenna or of an antenna that uses a unique coupling to the intentional radiator, the manufacturer may design the unit so that a broken antenna can be replaced by the user, but the use of a standard antenna jack or electrical connector is prohibited.

FCC CFR Title 47 Part 15 Subpart C Section 15.247(c) (1)(i):

(i) Systems operating in the 2400-2483.5 MHz band that is used exclusively for fixed. Point-to-point operations may employ transmitting antennas with directional gain greater than 6 dBi provided the maximum conducted output power of the intentional radiator is reduced by 1 dB for every 3 dB that the directional gain of the antenna exceeds 6 dBi.

TEST RESULTS

Passed **Not Applicable**

The directional gain of the antenna less than 6 dBi, please refer to the below antenna photo.

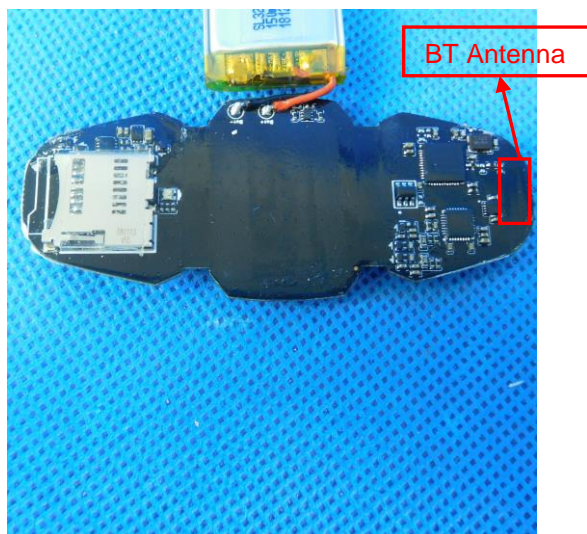

5.2. Conducted Emissions (AC Main)

LIMIT

FCC CFR Title 47 Part 15 Subpart C Section 15.207

Frequency range (MHz)	Limit (dBuV)	
	Quasi-peak	Average
0.15-0.5	66 to 56*	56 to 46*
0.5-5	56	46
5-30	60	50

* Decreases with the logarithm of the frequency.

TEST CONFIGURATION

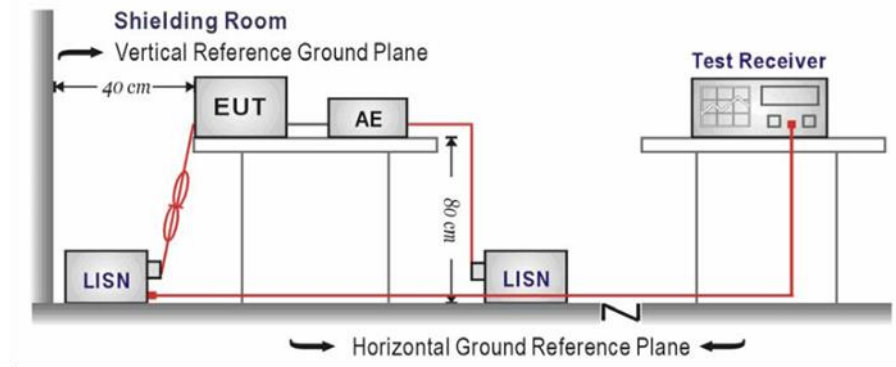

TEST PROCEDURE

1. The EUT was setup according to ANSI C63.10:2013 requirements.
2. The EUT was placed on a platform of nominal size, 1 m by 1.5 m, raised 80 cm above the conducting ground plane. The vertical conducting plane was located 40 cm to the rear of the EUT. All other surfaces of EUT were at least 80 cm from any other grounded conducting surface.
3. The EUT and simulators are connected to the main power through a line impedances stabilization network (LISN). The LISN provides a 50 ohm /50uH coupling impedance for the measuring equipment.
4. The peripheral devices are also connected to the main power through a LISN. (Please refer to the block diagram of the test setup and photographs)
5. Each current-carrying conductor of the EUT power cord, except the ground (safety) conductor, was individually connected through a LISN to the input power source.
6. The excess length of the power cord between the EUT and the LISN receptacle were folded back and forth at the center of the lead to form a bundle not exceeding 40 cm in length.
7. Conducted emissions were investigated over the frequency range from 0.15MHz to 30MHz using a receiver bandwidth of 9 kHz.
8. During the above scans, the emissions were maximized by cable manipulation.

TEST MODE:

Please refer to the clause 3.3

TEST RESULTS

Passed Not Applicable

Note:

- 1) Transd = Cable lose + Pulse Limiter Factor + Artificial Mains Factor
- 2) Margin = Limit - Level

Test Line:

L

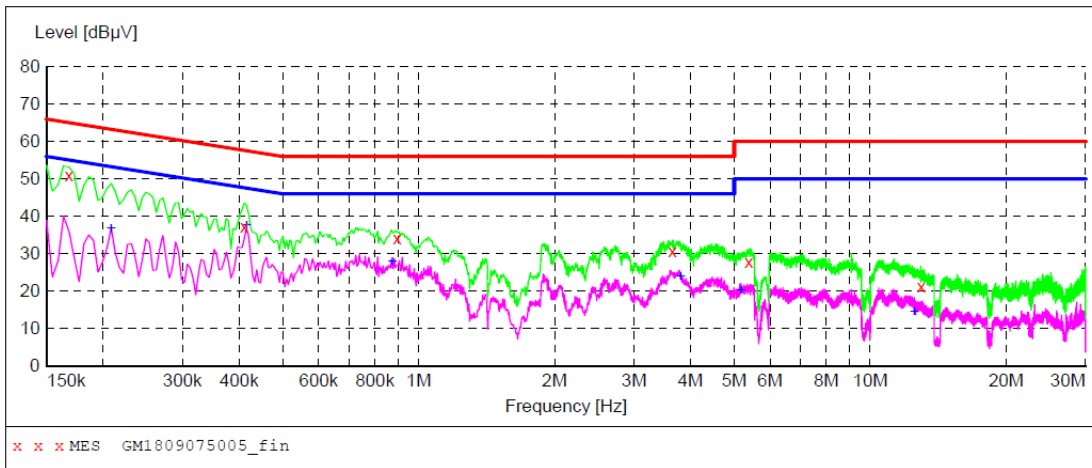

MEASUREMENT RESULT:

9/7/2018 9:17AM

Frequency MHz	Level dBµV	Transd dB	Limit dBµV	Margin dB	Detector	Line	PE
0.168000	51.10	10.1	65	14.0	QP	L1	???
0.411000	37.30	10.1	58	20.3	QP	L1	???
0.897000	34.20	9.9	56	21.8	QP	L1	???
3.642000	30.60	10.1	56	25.4	QP	L1	???
5.383500	27.80	10.1	60	32.2	QP	L1	???
12.970500	21.20	10.3	60	38.8	QP	L1	???

MEASUREMENT RESULT: "GM1809075005_fin2"

9/7/2018 9:17AM

Frequency MHz	Level dBµV	Transd dB	Limit dBµV	Margin dB	Detector	Line	PE
0.208500	36.70	10.2	53	16.6	AV	L1	???
0.415500	37.50	10.1	48	10.0	AV	L1	???
0.874500	27.90	9.9	46	18.1	AV	L1	???
3.808500	23.90	10.1	46	22.1	AV	L1	???
5.172000	20.10	10.1	50	29.9	AV	L1	???
12.534000	14.40	10.3	50	35.6	AV	L1	???

Test Line:

N

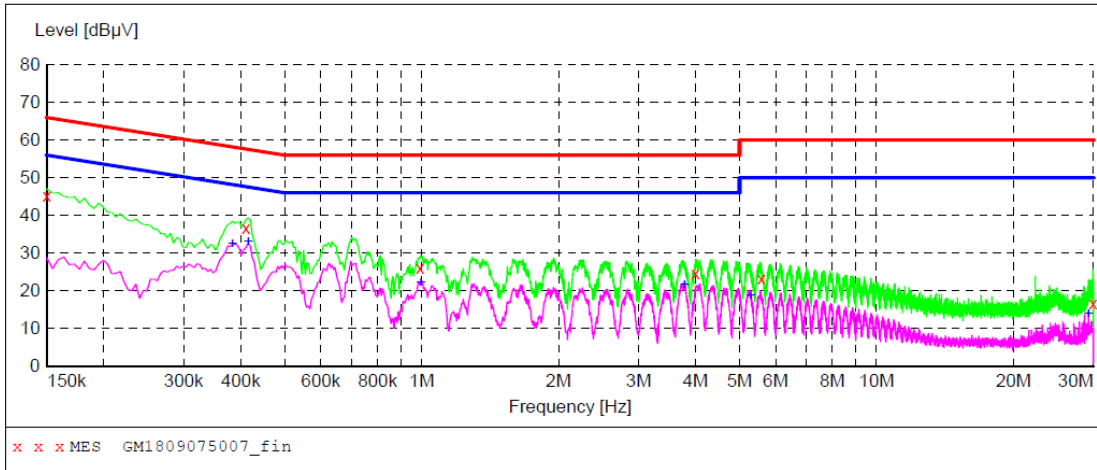

MEASUREMENT RESULT: "GM1809075007_fin"

9/7/2018 9:23AM

Frequency MHz	Level dBµV	Transd dB	Limit dBµV	Margin dB	Detector	Line	PE
0.150000	45.10	10.1	66	20.9	QP	N	???
0.411000	36.80	10.1	58	20.8	QP	N	???
0.991500	26.00	10.0	56	30.0	QP	N	???
4.002000	24.60	10.1	56	31.4	QP	N	???
5.581500	23.20	10.1	60	36.8	QP	N	???
29.931000	16.70	10.6	60	43.3	QP	N	???

MEASUREMENT RESULT: "GM1809075007_fin2"

9/7/2018 9:23AM

Frequency MHz	Level dBµV	Transd dB	Limit dBµV	Margin dB	Detector	Line	PE
0.384000	32.40	10.2	48	15.8	AV	N	???
0.415500	33.00	10.1	48	14.5	AV	N	???
0.996000	22.10	10.0	46	23.9	AV	N	???
3.786000	21.60	10.1	46	24.4	AV	N	???
5.289000	18.60	10.1	50	31.4	AV	N	???
29.233500	13.90	10.6	50	36.1	AV	N	???

5.3. Conducted Peak Output Power

LIMIT

FCC CFR Title 47 Part 15 Subpart C Section 15.247 (b)(3): 30 dBm

TEST CONFIGURATION

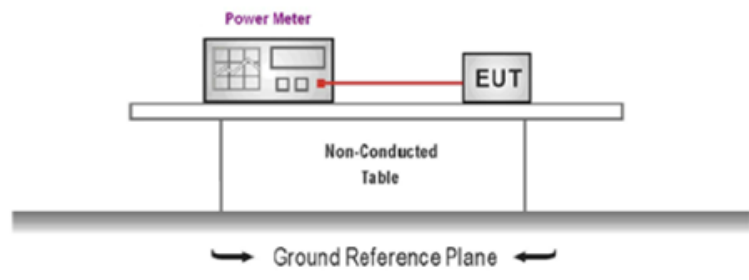

TEST PROCEDURE

1. The EUT was tested according to ANSI C63.10: 2013 and KDB 558074 D01 for compliance to FCC 47 CFR 15.247 requirements.
2. The maximum peak conducted output power may be measured using a broadband peak RF power meter.
3. The power meter shall have a video bandwidth that is greater than or equal to the DTS bandwidth and shall utilize a fast-responding diode detector.
4. Record the measurement data.

TEST MODE:

Please refer to the clause 3.3

TEST RESULTS

Passed Not Applicable

Type	Channel	Output power (dBm)	Limit (dBm)	Result
BT-BLE	00	1.76	≤30.00	Pass
	19	0.80		
	39	0.84		

5.4. Power Spectral Density

LIMIT

FCC CFR Title 47 Part 15 Subpart C Section 15.247 (e):

For digitally modulated systems, the power spectral density conducted from the intentional radiator to the antenna shall not be greater than 8 dBm in any 3 kHz band during any time interval of continuous transmission.

TEST CONFIGURATION

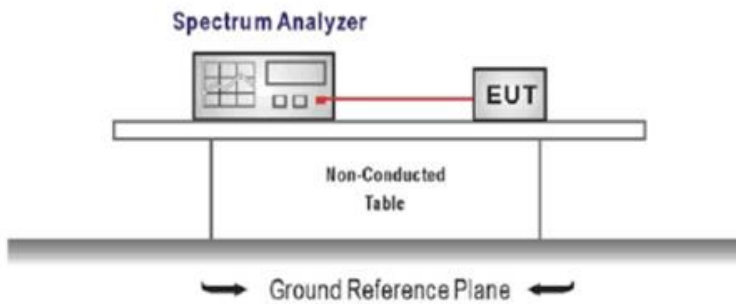

TEST PROCEDURE

1. Connect the antenna port(s) to the spectrum analyzer input,
2. Configure the spectrum analyzer as shown below:
 Center frequency=DTS channel center frequency
 Span =1.5 times the DTS bandwidth
 RBW = 3 kHz ≤ RBW ≤ 100 kHz, VBW ≥ 3 × RBW
 Sweep time = auto couple
 Detector = peak
 Trace mode = max hold
3. Place the radio in continuous transmit mode, allow the trace to stabilize, view the transmitter wave form on the spectrum analyzer.
4. Use the peak marker function to determine the maximum amplitude level within the RBW.
5. If measured value exceeds limit, reduce RBW (no less than 3 kHz) and repeat.

TEST MODE:

Please refer to the clause 3.3

TEST RESULTS

Passed **Not Applicable**

Type	Channel	Power Spectral Density(dBm/3KHz)	Limit (dBm/3KHz)	Result
BT-BLE	00	-11.17	≤8.00	Pass
	19	-14.52		
	39	-13.83		

Test plot as follows:

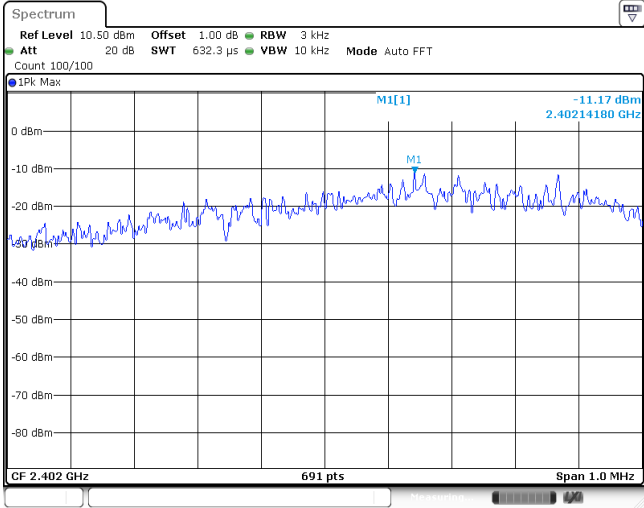
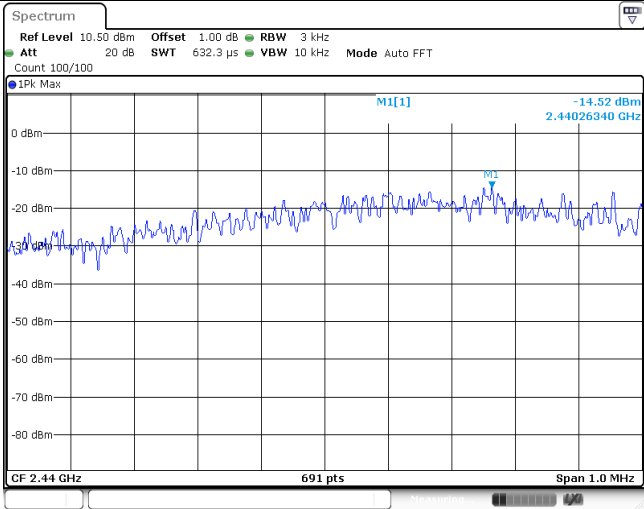
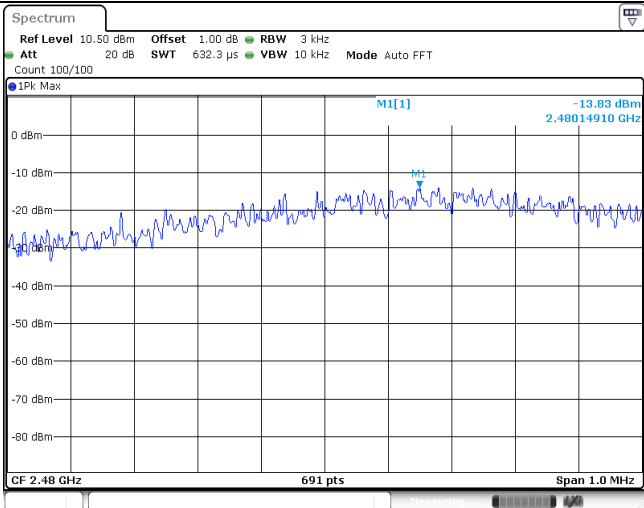
CH00	
CH19	
CH39	

5.5. 6dB bandwidth

LIMIT

FCC CFR Title 47 Part 15 Subpart C Section 15.247 (a)(2):

For digital modulation systems, the minimum 6 dB bandwidth shall be at least 500 kHz.

TEST CONFIGURATION

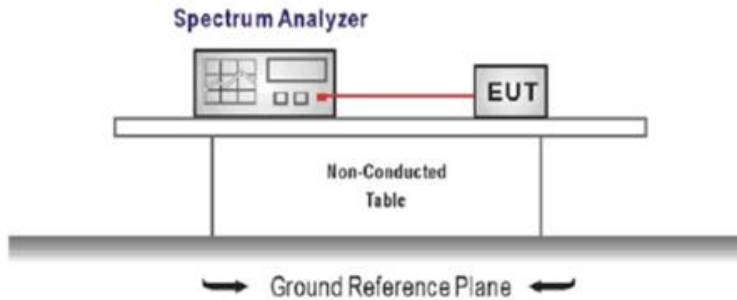

TEST PROCEDURE

1. Connect the antenna port(s) to the spectrum analyzer input.
2. Configure the spectrum analyzer as shown below (enter all losses between the transmitter output and the spectrum analyzer).
 Center Frequency =DTS channel center frequency
 Span=2 x DTS bandwidth
 RBW = 100 kHz, VBW ≥ 3 × RBW
 Sweep time= auto couple
 Detector = Peak
 Trace mode = max hold
3. Place the radio in continuous transmit mode, allow the trace to stabilize, view the transmitter waveform on the spectrum analyzer.
4. Measure the maximum width of the emission that is constrained by the frequencies associated with the two outermost amplitude points (upper and lower frequencies) that are attenuated by 6 dB relative to the maximum level measured in the fundamental emission, and record the pertinent measurements.

TEST MODE:

Please refer to the clause 3.3

TEST RESULTS

Passed Not Applicable

Type	Channel	6dB Bandwidth(MHz)	Limit (kHz)	Result
BT-BLE	00	0.89	≥500	Pass
	19	0.84		
	39	0.87		

Test plot as follows:

CH00

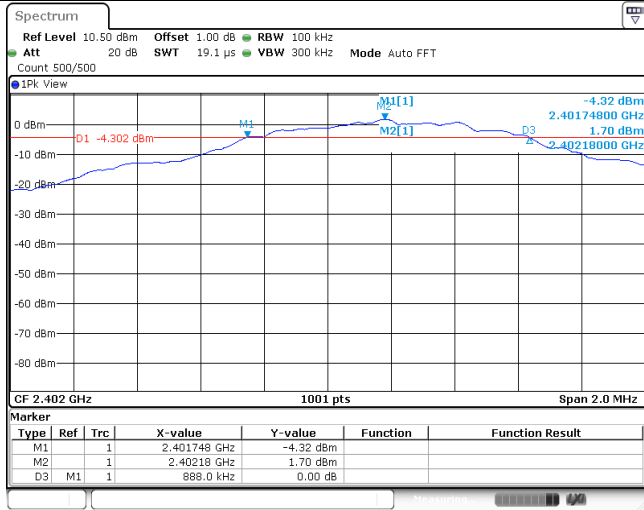

CH19

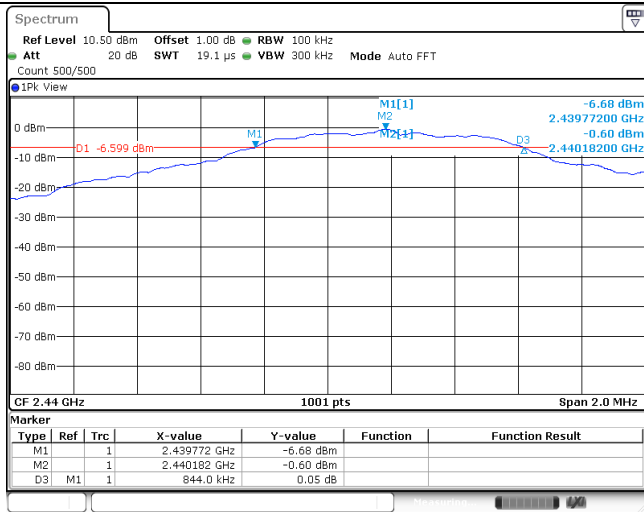

CH39

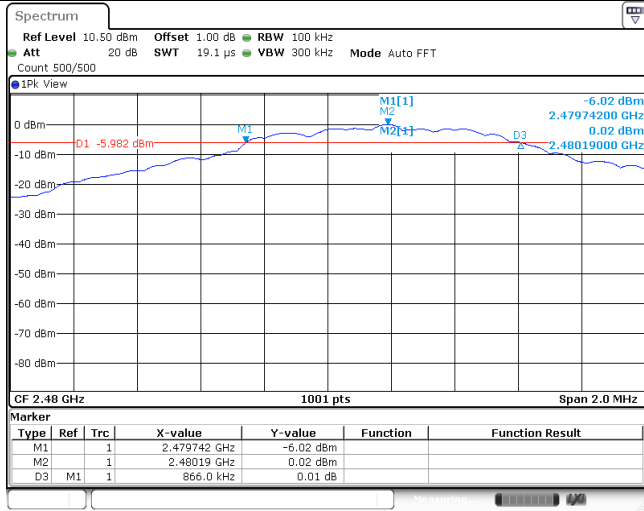

5.6. Restricted band

LIMIT

FCC CFR Title 47 Part 15 Subpart C Section 15.247 (d):

In any 100 kHz bandwidth outside the frequency band in which the spread spectrum or digitally modulated intentional radiator is operating, Radiated Emissions which fall in the restricted bands, as defined in §15.205(a), must also comply with the Radiated Emissions limits specified in §15.209(a) (see §15.205(c)).

TEST CONFIGURATION

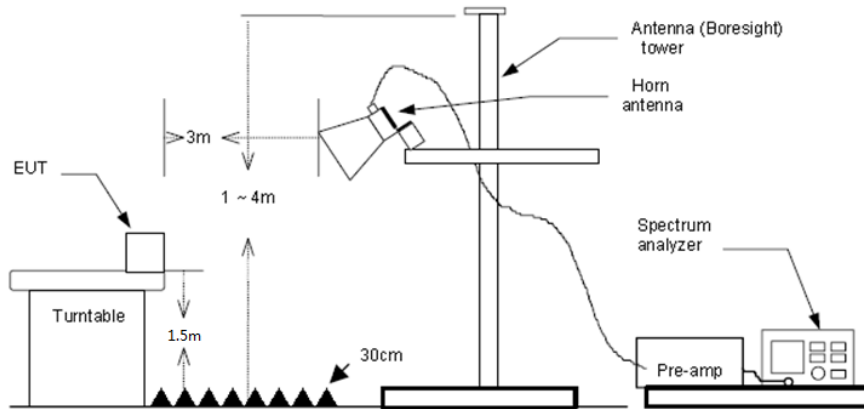

TEST PROCEDURE

1. The EUT was setup and tested according to ANSI C63.10:2013 for compliance to FCC 47CFR 15.247 requirements.
2. The EUT is placed on a turn table which is 1.5 meter above ground. The turn table is rotated 360 degrees to determine the position of the maximum emission level.
3. The EUT was positioned such that the distance from antenna to the EUT was 3 meters.
4. The antenna is scanned from 1 meter to 4 meters to find out the maximum emission level. This is repeated for both horizontal and vertical polarization of the antenna. In order to find the maximum emission, all of the interface cables were manipulated according to ANSI C63.10:2013 on radiated measurement.
5. The receiver set as follow:
 RBW=1MHz, VBW=3MHz Peak detector for Peak value.
 RBW=1MHz, VBW=3MHz RMS detector for Average value.

TEST MODE:

Please refer to the clause 3.3

TEST RESULTS

Passed Not Applicable

Note:

- 1) Final level= Read level + Antenna Factor+ Cable Loss- Preamp Factor
- 2) The peak level is lower than average limit(54 dBuV/m), this data is the too weak instrument of signal is unable to test.

Test channel					CH00				
Frequency (MHz)	Read Level (dBuV)	Antenna Factor (dB/m)	Cable Loss (dB)	Preamp Factor (dB)	Level (dBuV/m)	Limit Line (dBuV/m)	Over Limit (dB)	Polarization	Test value
2310.00	33.30	28.05	6.62	37.59	30.38	74.00	-43.62	Vertical	Peak
2343.59	35.97	27.88	6.68	37.59	32.94	74.00	-41.06	Vertical	Peak
2390.03	33.51	27.65	6.75	37.59	30.32	74.00	-43.68	Vertical	Peak
2310.00	33.32	28.05	6.62	37.59	30.40	74.00	-43.60	Horizontal	Peak
2356.26	34.65	27.82	6.70	37.59	31.58	74.00	-42.42	Horizontal	Peak
2390.03	32.77	27.65	6.75	37.59	29.58	74.00	-44.42	Horizontal	Peak
2310.00	26.55	28.05	6.62	37.59	23.63	54.00	-30.37	Vertical	Average
2319.52	30.21	28.00	6.64	37.59	27.26	54.00	-26.74	Vertical	Average
2390.03	27.18	27.65	6.75	37.59	23.99	54.00	-30.01	Vertical	Average
2310.00	26.25	28.05	6.62	37.59	23.33	54.00	-30.67	Horizontal	Average
2352.38	28.71	27.84	6.69	37.59	25.65	54.00	-28.35	Horizontal	Average
2390.03	24.58	27.65	6.75	37.59	21.39	54.00	-32.61	Horizontal	Average

Test channel					CH39				
Frequency (MHz)	Read Level (dBuV)	Antenna Factor (dB/m)	Cable Loss (dB)	Preamp Factor (dB)	Level (dBuV/m)	Limit Line (dBuV/m)	Over Limit (dB)	Polarization	Test value
2483.50	33.59	27.26	6.83	37.59	30.09	74.00	-43.91	Vertical	Peak
2492.25	36.65	27.23	6.83	37.59	33.12	74.00	-40.88	Vertical	Peak
2500.00	35.46	27.20	6.84	37.59	31.91	74.00	-42.09	Vertical	Peak
2483.50	33.27	27.26	6.83	37.59	29.77	74.00	-44.23	Horizontal	Peak
2495.88	34.33	27.22	6.84	37.59	30.80	74.00	-43.20	Horizontal	Peak
2500.00	31.71	27.20	6.84	37.59	28.16	74.00	-45.84	Horizontal	Peak
2483.50	26.09	27.26	6.83	37.59	22.59	54.00	-31.41	Vertical	Average
2496.08	29.58	27.22	6.84	37.59	26.05	54.00	-27.95	Vertical	Average
2500.00	25.90	27.20	6.84	37.59	22.35	54.00	-31.65	Vertical	Average
2483.50	24.94	27.26	6.83	37.59	21.44	54.00	-32.56	Horizontal	Average
2496.13	28.37	27.22	6.84	37.59	24.84	54.00	-29.16	Horizontal	Average
2500.00	23.98	27.20	6.84	37.59	20.43	54.00	-33.57	Horizontal	Average

5.7. Band edge and Spurious Emissions (conducted)

LIMIT

FCC CFR Title 47 Part 15 Subpart C Section 15.247 (d): In any 100 kHz bandwidth outside the frequency band in which the spread spectrum intentional radiator is operating, the radio frequency power that is produced by the intentional radiator shall be at least 20 dB below that in the 100 kHz bandwidth within the band that contains the highest level of the desired power, based on either an RF conducted or a radiated measurement.

TEST CONFIGURATION

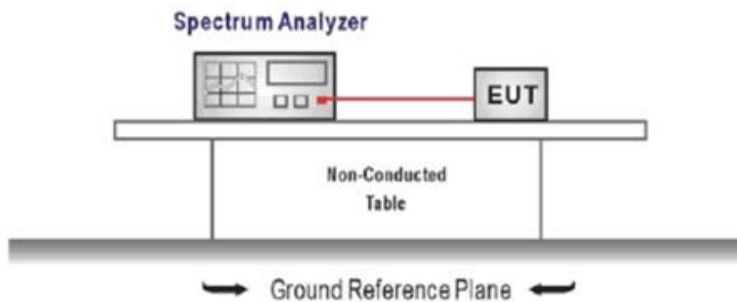

TEST PROCEDURE

1. Connect the antenna port(s) to the spectrum analyzer input.
2. Establish a reference level by using the following procedure
Center frequency=DTS channel center frequency
The span = 1.5 times the DTS bandwidth.
RBW = 100 kHz, VBW ≥ 3 x RBW
Detector = peak, Sweep time = auto couple, Trace mode = max hold
Allow trace to fully stabilize
Use the peak marker function to determine the maximum PSD level

Note that the channel found to contain the maximum PSD level can be used to establish the reference level.

3. Emission level measurement
Set the center frequency and span to encompass frequency range to be measured
RBW = 100 kHz, VBW ≥ 3 x RBW
Detector = peak, Sweep time = auto couple, Trace mode = max hold
Allow trace to fully stabilize
Use the peak marker function to determine the maximum amplitude level.
4. Place the radio in continuous transmit mode, allow the trace to stabilize, view the transmitter waveform on the spectrum analyzer.
5. Ensure that the amplitude of all unwanted emission outside of the authorized frequency band excluding restricted frequency bands) are attenuated by at least the minimum requirements specified (at least 20 dB relative to the maximum in-band peak PSD level in 100 kHz). Report the three highest emission relative to the limit.

TEST MODE:

Please refer to the clause 3.3

TEST RESULTS

Passed Not Applicable

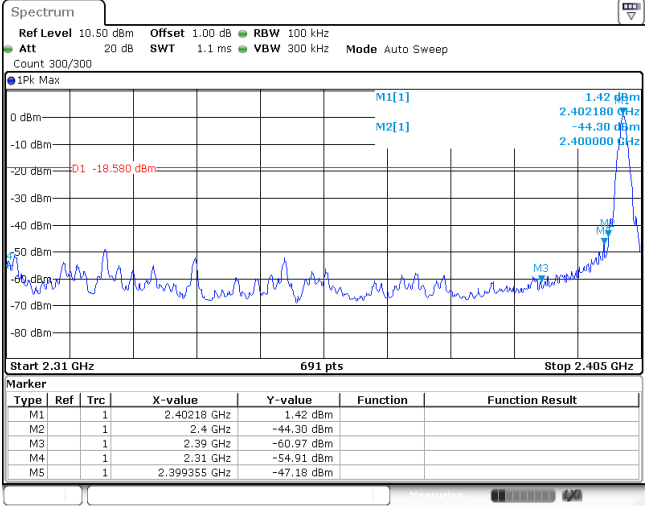
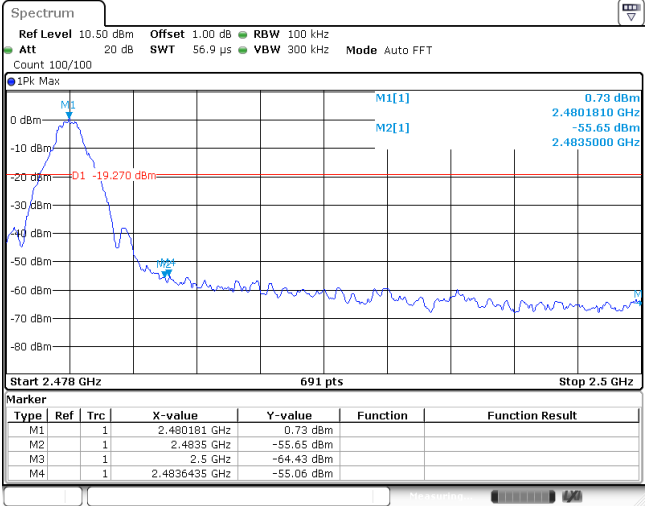
Test Item:	Band edge																																																
CH00	 <p>Spectrum Ref Level 10.50 dBm Offset 1.00 dB RBW 100 kHz Att 20 dB SWT 1.1 ms VBW 300 kHz Mode Auto Sweep Count 300/300</p> <p>1Pk Max</p> <p>M1[1] 1.42 dBm 2.402180 GHz M2[1] -44.30 dBm 2.402180 GHz M3 -60.97 dBm M4 -54.91 dBm M5 -47.18 dBm</p> <p>D1 -18.580 dBm</p> <p>Start 2.31 GHz 691 pts Stop 2.405 GHz</p> <table border="1"> <thead> <tr> <th>Marker</th> <th>Type</th> <th>Ref</th> <th>Trc</th> <th>X-value</th> <th>Y-value</th> <th>Function</th> <th>Function Result</th> </tr> </thead> <tbody> <tr> <td>M1</td> <td>1</td> <td></td> <td></td> <td>2.40218 GHz</td> <td>1.42 dBm</td> <td></td> <td></td> </tr> <tr> <td>M2</td> <td>1</td> <td></td> <td></td> <td>2.4 GHz</td> <td>-44.30 dBm</td> <td></td> <td></td> </tr> <tr> <td>M3</td> <td>1</td> <td></td> <td></td> <td>2.39 GHz</td> <td>-60.97 dBm</td> <td></td> <td></td> </tr> <tr> <td>M4</td> <td>1</td> <td></td> <td></td> <td>2.31 GHz</td> <td>-54.91 dBm</td> <td></td> <td></td> </tr> <tr> <td>M5</td> <td>1</td> <td></td> <td></td> <td>2.399355 GHz</td> <td>-47.18 dBm</td> <td></td> <td></td> </tr> </tbody> </table>	Marker	Type	Ref	Trc	X-value	Y-value	Function	Function Result	M1	1			2.40218 GHz	1.42 dBm			M2	1			2.4 GHz	-44.30 dBm			M3	1			2.39 GHz	-60.97 dBm			M4	1			2.31 GHz	-54.91 dBm			M5	1			2.399355 GHz	-47.18 dBm		
Marker	Type	Ref	Trc	X-value	Y-value	Function	Function Result																																										
M1	1			2.40218 GHz	1.42 dBm																																												
M2	1			2.4 GHz	-44.30 dBm																																												
M3	1			2.39 GHz	-60.97 dBm																																												
M4	1			2.31 GHz	-54.91 dBm																																												
M5	1			2.399355 GHz	-47.18 dBm																																												
CH39	 <p>Spectrum Ref Level 10.50 dBm Offset 1.00 dB RBW 100 kHz Att 20 dB SWT 56.9 μs VBW 300 kHz Mode Auto FFT Count 100/100</p> <p>1Pk Max</p> <p>M1[1] 0.73 dBm 2.480181 GHz M2[1] -55.65 dBm 2.480181 GHz M3 -64.43 dBm 2.4835000 GHz M4 -55.06 dBm</p> <p>D1 -19.270 dBm</p> <p>Start 2.478 GHz 691 pts Stop 2.5 GHz</p> <table border="1"> <thead> <tr> <th>Marker</th> <th>Type</th> <th>Ref</th> <th>Trc</th> <th>X-value</th> <th>Y-value</th> <th>Function</th> <th>Function Result</th> </tr> </thead> <tbody> <tr> <td>M1</td> <td>1</td> <td></td> <td></td> <td>2.480181 GHz</td> <td>0.73 dBm</td> <td></td> <td></td> </tr> <tr> <td>M2</td> <td>1</td> <td></td> <td></td> <td>2.4835 GHz</td> <td>-55.65 dBm</td> <td></td> <td></td> </tr> <tr> <td>M3</td> <td>1</td> <td></td> <td></td> <td>2.5 GHz</td> <td>-64.43 dBm</td> <td></td> <td></td> </tr> <tr> <td>M4</td> <td>1</td> <td></td> <td></td> <td>2.4836435 GHz</td> <td>-55.06 dBm</td> <td></td> <td></td> </tr> </tbody> </table>	Marker	Type	Ref	Trc	X-value	Y-value	Function	Function Result	M1	1			2.480181 GHz	0.73 dBm			M2	1			2.4835 GHz	-55.65 dBm			M3	1			2.5 GHz	-64.43 dBm			M4	1			2.4836435 GHz	-55.06 dBm										
Marker	Type	Ref	Trc	X-value	Y-value	Function	Function Result																																										
M1	1			2.480181 GHz	0.73 dBm																																												
M2	1			2.4835 GHz	-55.65 dBm																																												
M3	1			2.5 GHz	-64.43 dBm																																												
M4	1			2.4836435 GHz	-55.06 dBm																																												

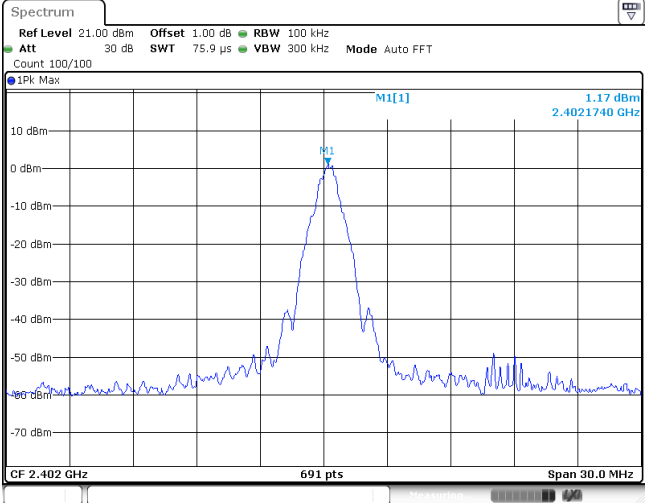
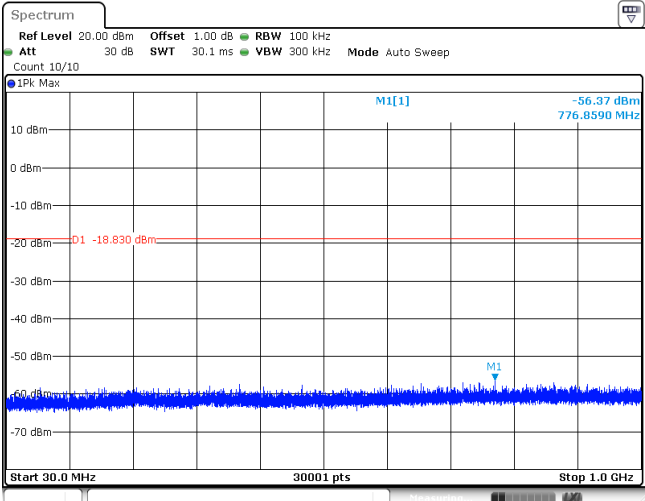
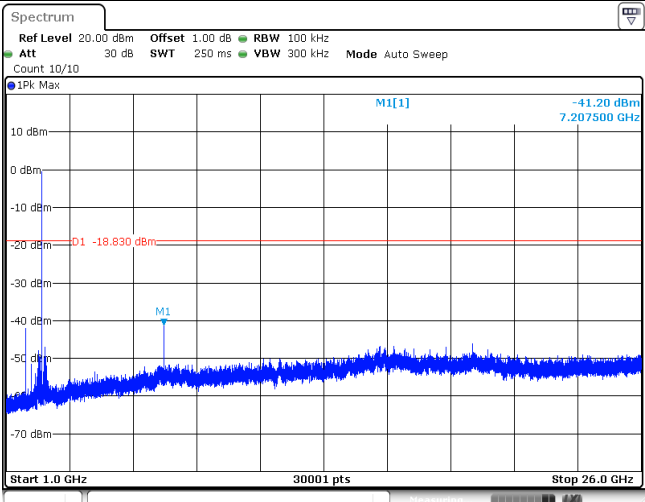
Test Item:	SE
CH00 Reference level	 <p>Spectrum</p> <p>Ref Level 21.00 dBm Offset 1.00 dB RBW 100 kHz Att 30 dB SWT 75.9 μs VBW 300 kHz Mode Auto FFT Count 100/100</p> <p>IPK Max</p> <p>M1[1] 1.17 dBm 2.4021740 GHz</p> <p>CF 2.402 GHz 691 pts Span 30.0 MHz</p>
CH00 30MHz~1000MHz	 <p>Spectrum</p> <p>Ref Level 20.00 dBm Offset 1.00 dB RBW 100 kHz Att 30 dB SWT 30.1 ms VBW 300 kHz Mode Auto Sweep Count 10/10</p> <p>IPK Max</p> <p>M1[1] -56.37 dBm 776.8590 MHz</p> <p>D1 -18.830 dBm</p> <p>Start 30.0 MHz 30001 pts Stop 1.0 GHz</p>
CH00 1GHz~26GHz	 <p>Spectrum</p> <p>Ref Level 20.00 dBm Offset 1.00 dB RBW 100 kHz Att 30 dB SWT 250 ms VBW 300 kHz Mode Auto Sweep Count 10/10</p> <p>IPK Max</p> <p>M1[1] -41.20 dBm 7.207500 GHz</p> <p>D1 -18.830 dBm</p> <p>Start 1.0 GHz 30001 pts Stop 26.0 GHz</p>

CH19
Reference level

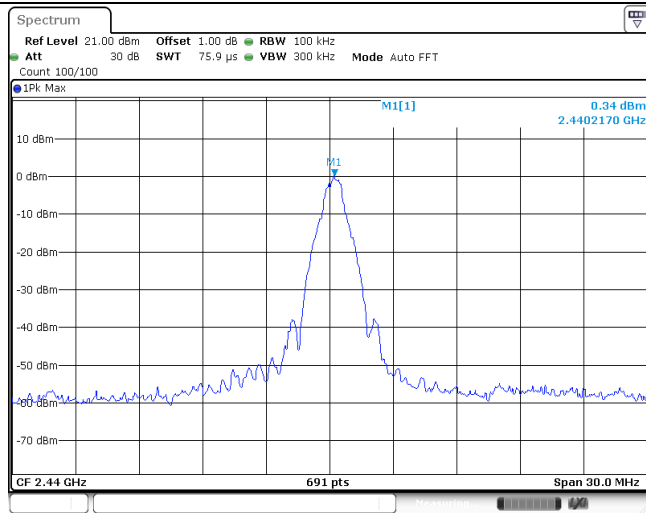

CH19
30MHz~1000MHz

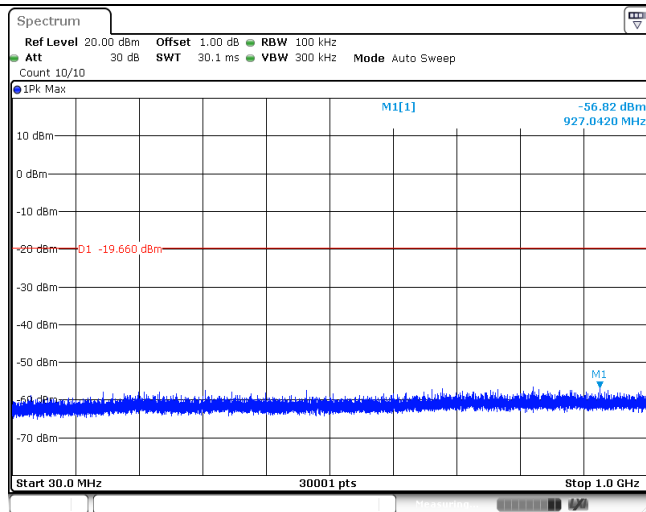

CH19
1GHz~26GHz

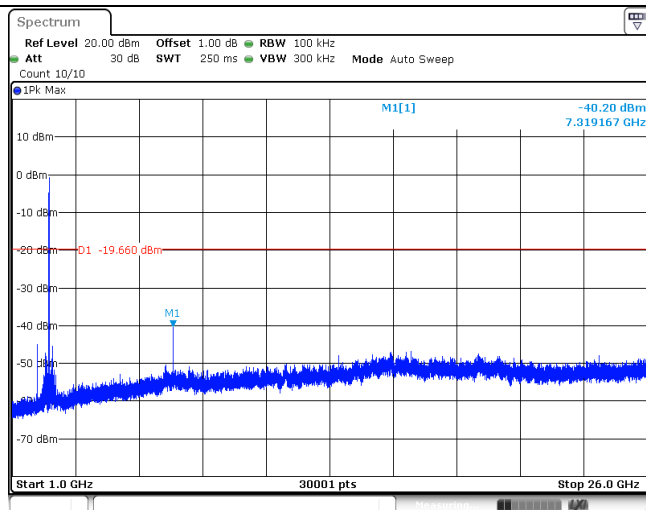

CH39
Reference level

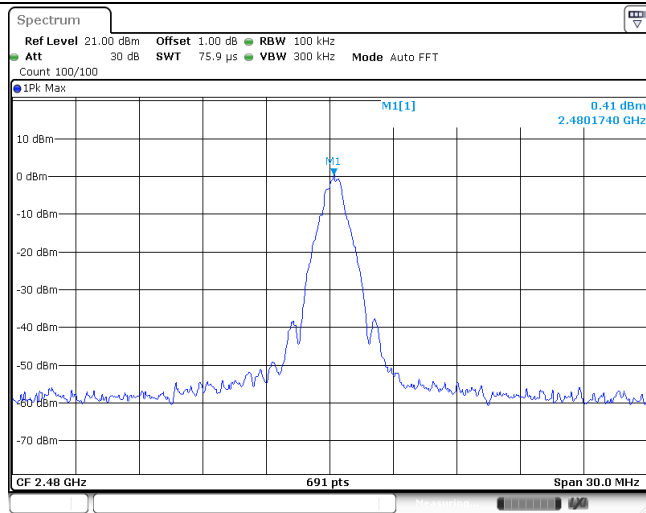

CH39
30MHz~1000MHz

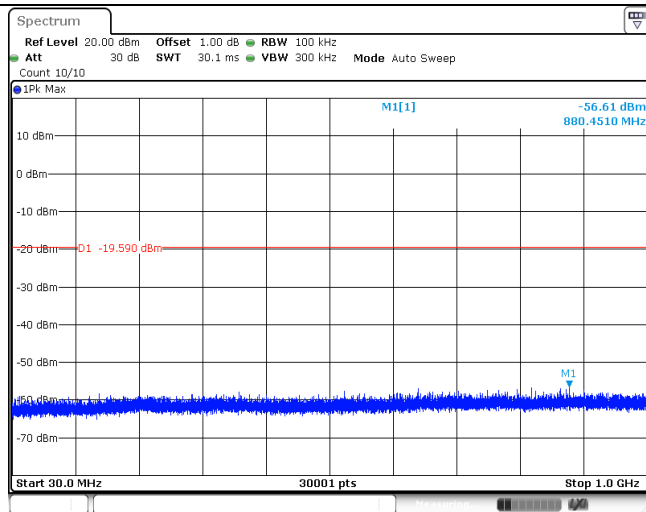

CH39
1GHz~26GHz

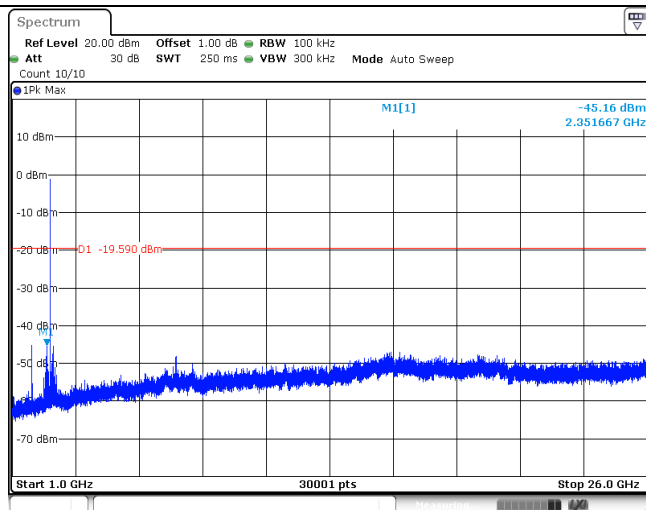

5.8. Spurious Emissions (radiated)

LIMIT

FCC CFR Title 47 Part 15 Subpart C Section 15.209

Frequency	Limit (dBuV/m @3m)	Value
30MHz~88MHz	40.00	Quasi-peak
88MHz~216MHz	43.50	Quasi-peak
216MHz~960MHz	46.00	Quasi-peak
960MHz~1GHz	54.00	Quasi-peak
Above 1GHz	54.00	Average
	74.00	Peak

TEST CONFIGURATION

- 9 kHz ~ 30 MHz

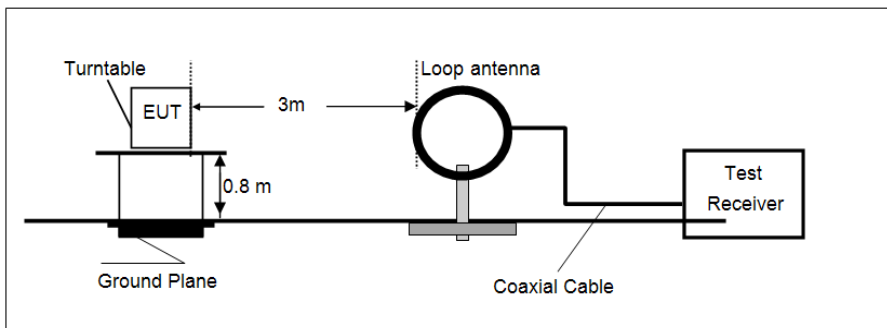

- 30 MHz ~ 1 GHz

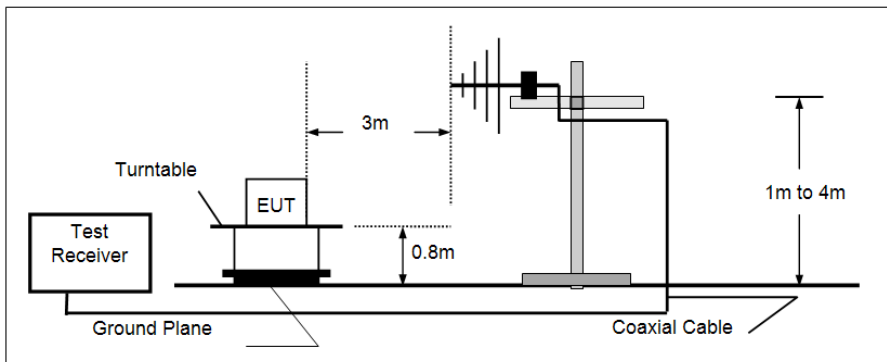

- Above 1 GHz

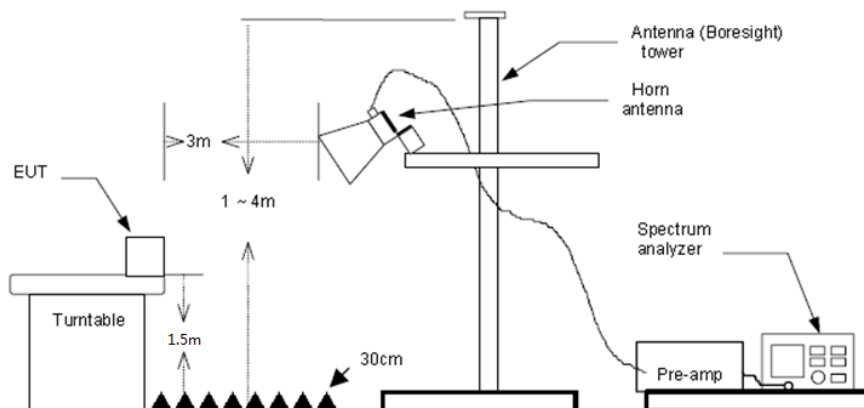

TEST PROCEDURE

1. The EUT was setup and tested according to ANSI C63.10:2013 for compliance to FCC 47CFR 15.247 requirements.
2. The EUT is placed on a turn table which is 0.8 meter above ground for below 1 GHz, and 1.5 m for above 1 GHz. The turn table is rotated 360 degrees to determine the position of the maximum emission level.
3. The EUT was set 3 meters from the receiving antenna, which was mounted on the top of a variable height antenna tower.
4. For each suspected emission, the EUT was arranged to its worst case and then tune the Antenna tower (from 1 m to 4 m) and turntable (from 0 degree to 360 degrees) to find the maximum reading. A pre-amp and a high pass filter are used for the test in order to get better signal level to comply with the guidelines.
5. Set to the maximum power setting and enable the EUT transmit continuously.
6. Use the following spectrum analyzer settings
 - (1) Span shall wide enough to fully capture the emission being measured;
 - (2) Below 1 GHz:
RBW=120 kHz, VBW=300 kHz, Sweep=auto, Detector function=peak, Trace=max hold;
If the emission level of the EUT measured by the peak detector is 3 dB lower than the applicable limit, the peak emission level will be reported. Otherwise, the emission measurement will be repeated using the quasi-peak detector and reported.
 - (3) From 1 GHz to 10th harmonic:
RBW=1MHz, VBW=3MHz Peak detector for Peak value.
RBW=1MHz, VBW=3MHz RMS detector for Average value.

TEST MODE:

Please refer to the clause 3.3

TEST RESULTS

Passed **Not Applicable**

Note:

- 1) Above 1GHz Final Level =Receiver Read level + Antenna Factor + Cable Loss – Preamplifier Factor
 - 2) The emission levels of other frequencies are very lower than the limit and not show in test report.
- **9 kHz ~ 30 MHz**
The EUT was pre-scanned the frequency band (9 kHz ~ 30 MHz), found the radiated level lower than the limit, so don't show on the report.
- **30 MHz ~ 1000 MHz**
Have pre-scan all modulation mode, found the BT-BLE mode CH39 which it was worst case, so only the worst case's data on the test report.

➤ 30 MHz ~ 1 GHz

Polarization: Vertical

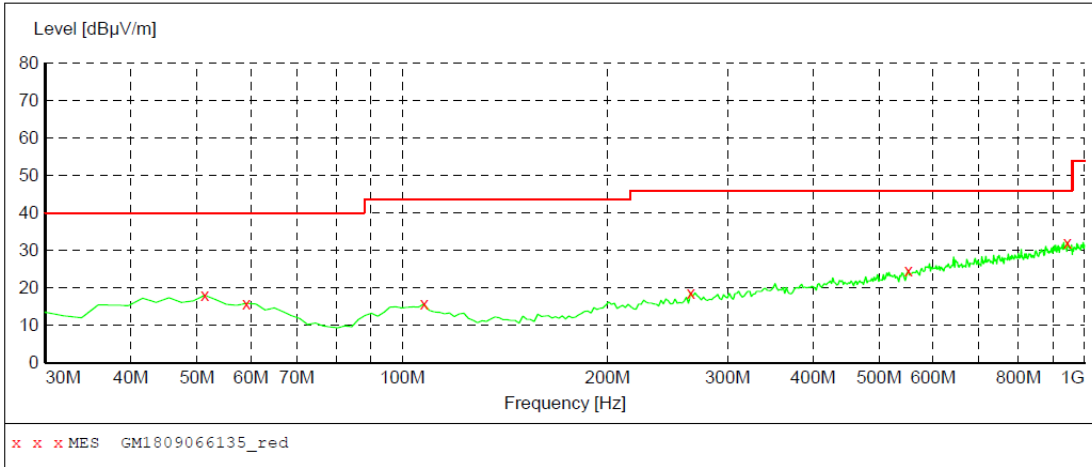

MEASUREMENT RESULT: "GM1809066135_red"

9/6/2018 10:13PM

Frequency MHz	Level dBµV/m	Transd dB	Limit dBµV/m	Margin dB	Det.	Height cm	Azimuth deg	Polarization
51.340000	18.00	-8.8	40.0	22.0	QP	100.0	257.00	VERTICAL
59.100000	15.90	-9.8	40.0	24.1	QP	100.0	215.00	VERTICAL
107.600000	15.70	-10.6	43.5	27.8	QP	100.0	286.00	VERTICAL
264.740000	18.80	-8.0	46.0	27.2	QP	100.0	131.00	VERTICAL
551.860000	24.70	-0.7	46.0	21.3	QP	100.0	89.00	VERTICAL
943.740000	32.20	7.2	46.0	13.8	QP	100.0	119.00	VERTICAL

Polarization: Horizontal

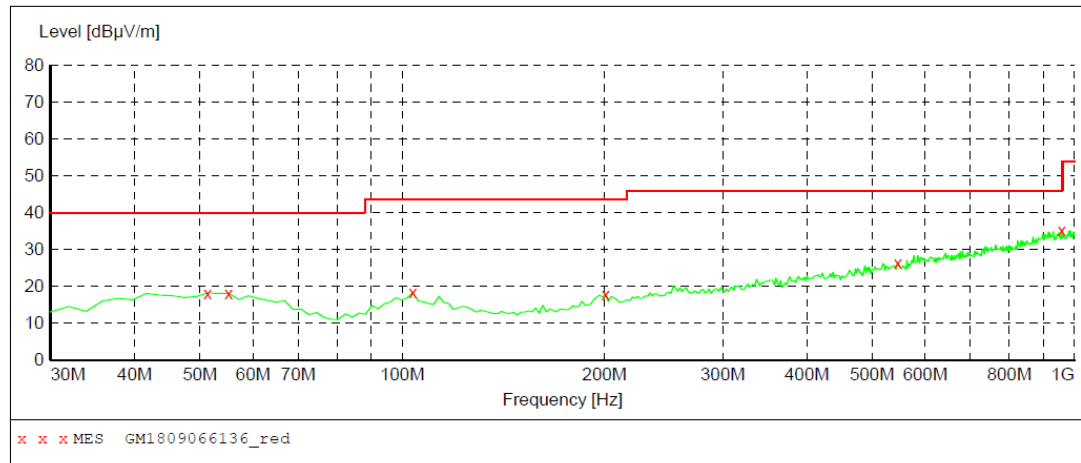

MEASUREMENT RESULT: "GM1809066136_red"

9/6/2018 10:17PM

Frequency MHz	Level dBµV/m	Transd dB	Limit dBµV/m	Margin dB	Det.	Height cm	Azimuth deg	Polarization
51.340000	18.20	-8.8	40.0	21.8	QP	300.0	225.00	HORIZONTAL
55.220000	18.10	-9.2	40.0	21.9	QP	100.0	332.00	HORIZONTAL
103.720000	18.40	-10.5	43.5	25.1	QP	300.0	11.00	HORIZONTAL
200.720000	17.90	-9.9	43.5	25.6	QP	100.0	152.00	HORIZONTAL
546.040000	26.40	-0.8	46.0	19.6	QP	300.0	312.00	HORIZONTAL
957.320000	35.20	7.3	46.0	10.8	QP	100.0	204.00	HORIZONTAL

➤ 1 GHz ~ 25 GHz

Test channel					CH00				
Frequency (MHz)	Read Level (dBuV)	Antenna Factor (dB/m)	Cable Loss (dB)	Preamp Factor (dB)	Level (dBuV/m)	Limit Line (dBuV/m)	Over Limit (dB)	Polarization	Test value
3184.25	38.32	28.80	7.70	37.41	37.41	74.00	-36.59	Vertical	Peak
3993.90	36.10	29.70	8.77	36.76	37.81	74.00	-36.19	Vertical	Peak
4809.50	35.74	31.58	9.55	35.72	41.15	74.00	-32.85	Vertical	Peak
8042.90	32.79	37.06	12.40	33.06	49.19	74.00	-24.81	Vertical	Peak
1746.25	34.69	25.29	5.86	37.35	28.49	74.00	-45.51	Horizontal	Peak
3342.04	34.70	28.20	7.89	37.27	33.52	74.00	-40.48	Horizontal	Peak
4809.50	38.72	31.58	9.55	35.72	44.13	74.00	-29.87	Horizontal	Peak
7209.02	32.80	36.21	11.87	33.51	47.37	74.00	-26.63	Horizontal	Peak

Test channel					CH19				
Frequency (MHz)	Read Level (dBuV)	Antenna Factor (dB/m)	Cable Loss (dB)	Preamp Factor (dB)	Level (dBuV/m)	Limit Line (dBuV/m)	Over Limit (dB)	Polarization	Test value
1533.65	36.16	25.49	5.38	37.11	29.92	74.00	-44.08	Vertical	Peak
2281.32	34.00	27.99	6.57	37.59	30.97	74.00	-43.03	Vertical	Peak
4883.52	33.99	31.43	9.59	35.58	39.43	74.00	-34.57	Vertical	Peak
8002.06	32.74	37.10	12.30	33.07	49.07	74.00	-24.93	Vertical	Peak
2218.32	33.91	27.61	6.47	37.60	30.39	74.00	-43.61	Horizontal	Peak
3096.33	34.53	28.79	7.60	37.49	33.43	74.00	-40.57	Horizontal	Peak
4883.52	37.78	31.43	9.59	35.58	43.22	74.00	-30.78	Horizontal	Peak
7489.60	32.06	36.12	12.36	33.04	47.50	74.00	-26.50	Horizontal	Peak

Test channel					CH39				
Frequency (MHz)	Read Level (dBuV)	Antenna Factor (dB/m)	Cable Loss (dB)	Preamp Factor (dB)	Level (dBuV/m)	Limit Line (dBuV/m)	Over Limit (dB)	Polarization	Test value
1257.47	36.22	26.24	4.76	37.19	30.03	74.00	-43.97	Vertical	Peak
2571.25	38.49	27.63	6.89	37.59	35.42	74.00	-38.58	Vertical	Peak
3057.17	36.83	28.72	7.55	37.53	35.57	74.00	-38.43	Vertical	Peak
7741.59	32.37	36.10	13.10	33.04	48.53	74.00	-25.47	Vertical	Peak
1638.59	35.71	25.02	5.65	37.23	29.15	74.00	-44.85	Horizontal	Peak
3120.06	37.32	28.80	7.62	37.47	36.27	74.00	-37.73	Horizontal	Peak
4958.68	34.31	31.46	9.64	35.45	39.96	74.00	-34.04	Horizontal	Peak
8063.40	32.70	37.04	12.45	33.05	49.14	74.00	-24.86	Horizontal	Peak

Remark:

1. Final Level = Receiver Read level + Antenna Factor + Cable Loss – Pre-amplifier Factor
2. The peak level is lower than average limit(54dBuV/m), this data is the too weak instrument of signal is unable to test.
3. The emission levels of other frequencies are very lower than the limit and not show in test report.

6. TEST SETUP PHOTOS

Conducted Emissions (AC Mains)



Radiated Emissions

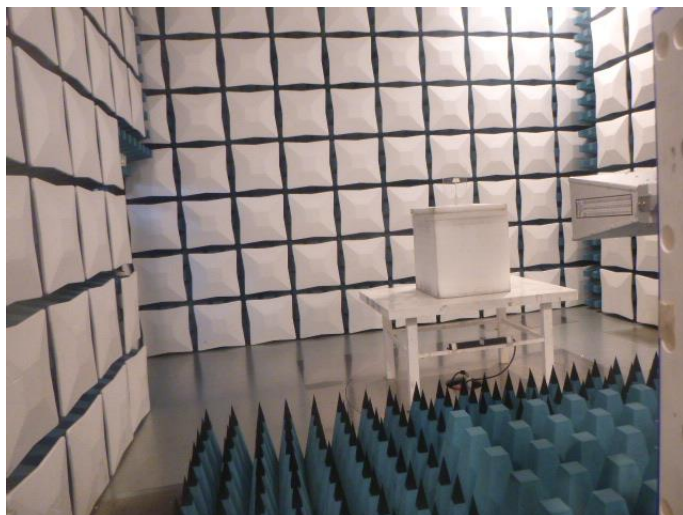

7. EXTERANAL AND INTERNAL PHOTOS

EXTERNAL PHOTO

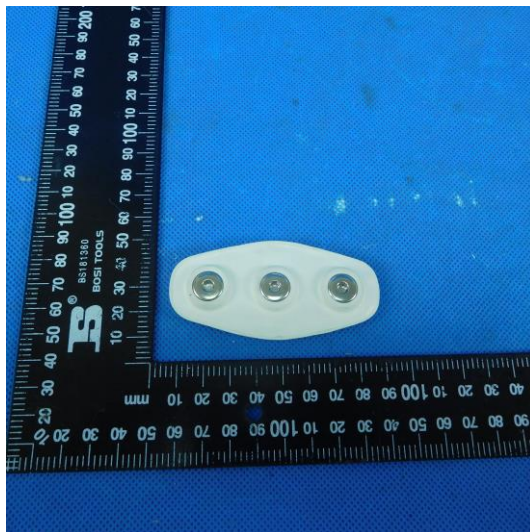
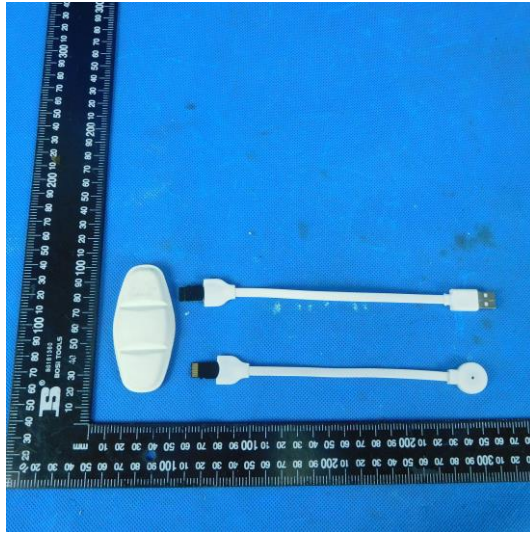

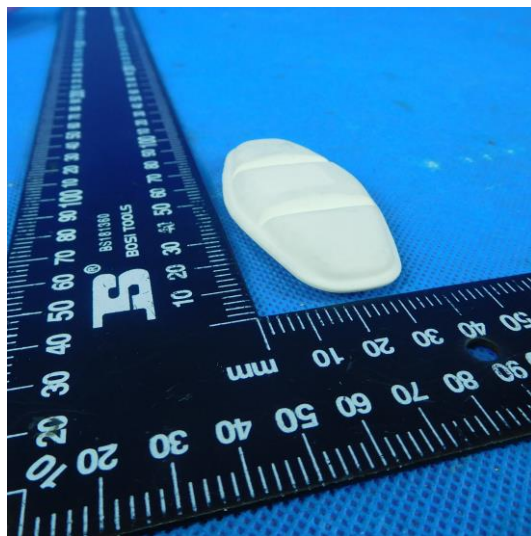
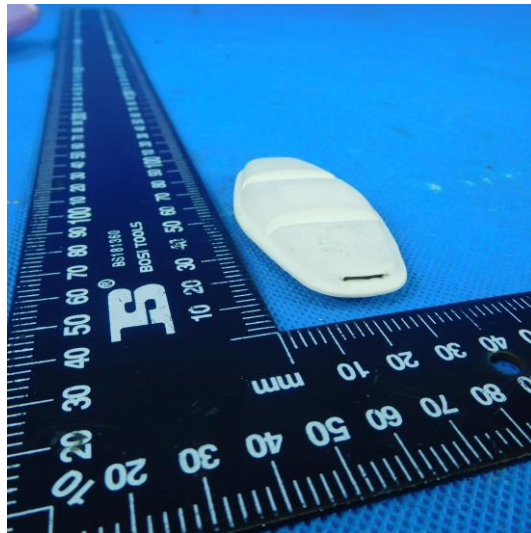

INTERNAL PHOTO

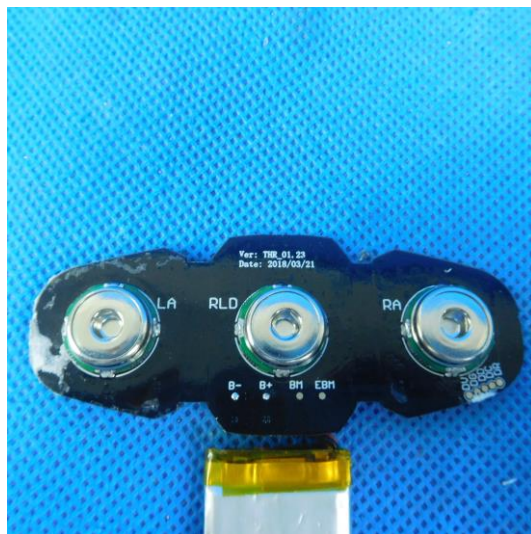
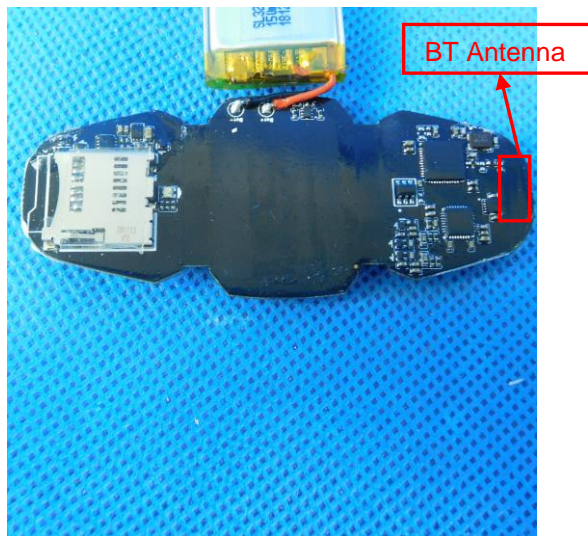
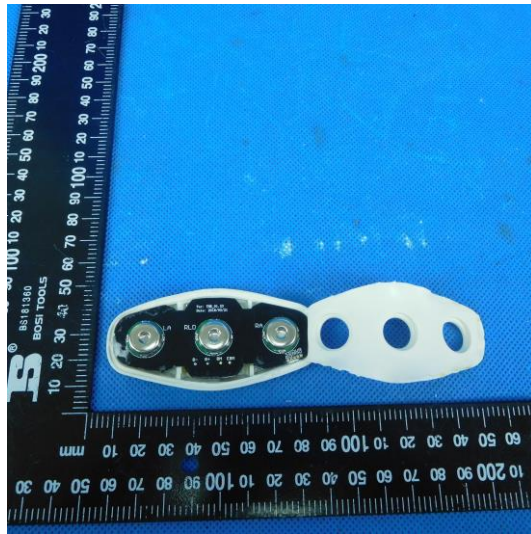

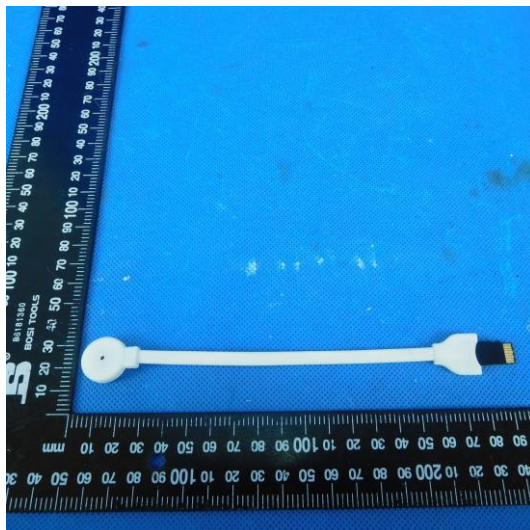
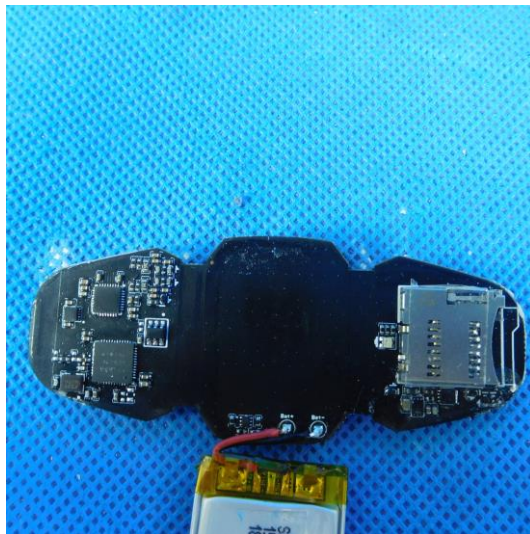
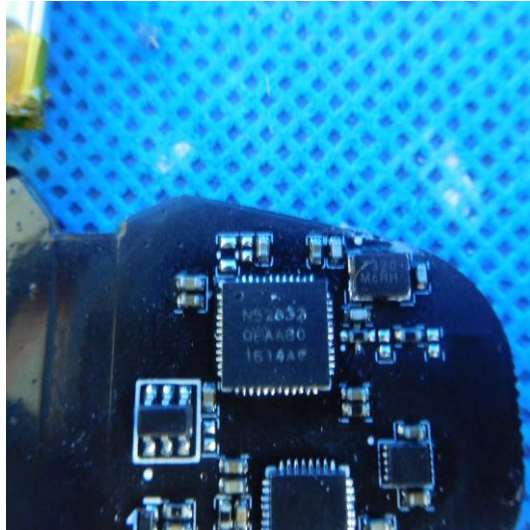

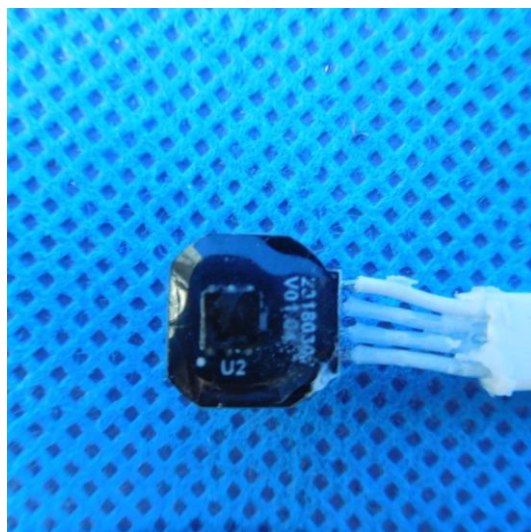
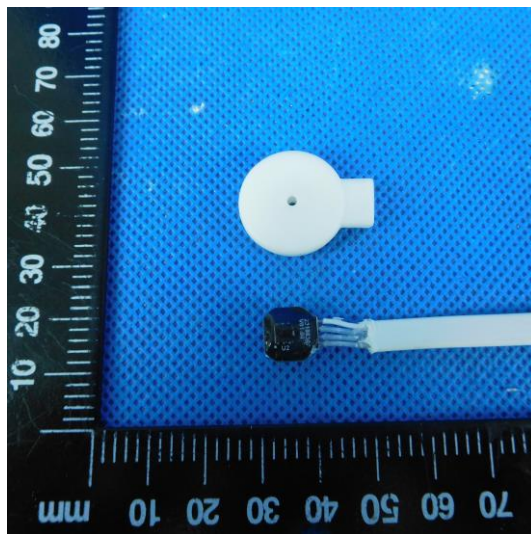
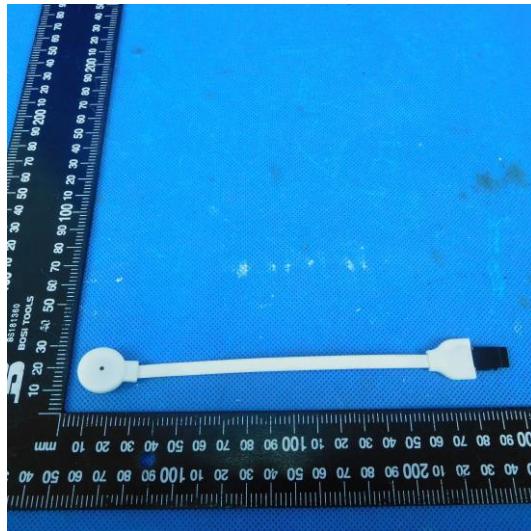

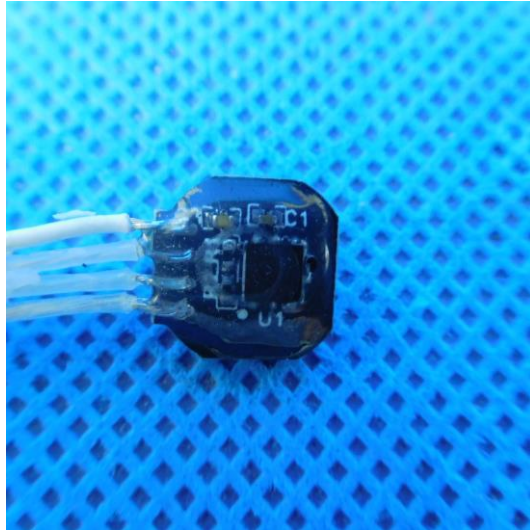

-----End of Report-----