

**SUBMITTAL  
APPLICATION  
REPORT**

**FOR  
GRANT OF CERTIFICATION**

FOR

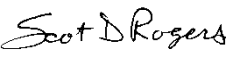
**Model: ARCFlex 802.11b/g/n Module  
Broadband Digital Transmission System  
2412-2462 MHz, 2422-2452 MHz (802.11n Mode)**

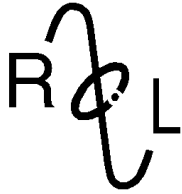
**FCC ID: Z2B-AFM1**

FOR

**ARC WIRELESS LLC**  
6330 N. Washington St., Unit 13  
Denver, CO 80216

**Test Report Number: 110826**

Authorized Signatory:   
Scot D. Rogers



**ROGERS LABS, INC.**

4405 West 259<sup>th</sup> Terrace  
 Louisburg, KS 66053  
 Phone / Fax (913) 837-3214

**Engineering Test Report  
 For  
 Grant of Certification Application**

FOR  
 CFR 47, PART 15C - Intentional Radiators  
 CFR 47 Paragraph 15.247  
 License Exempt Intentional Radiator

For

**ARC WIRELESS LLC**

6330 N. Washington St., Unit 13  
 Denver, CO 80216

Model: ARCFlex 802.11b/g/n Module  
 802.11 b/g/n Broadband Digital Transmission System  
 Frequency Range 2412-2462 MHz, 2422-2452 MHz (802.11n mode)  
 FCC ID#: Z2B-AFM1

Test Date: August 26, 2011

Certifying Engineer: *Scot D. Rogers*

Scot D. Rogers  
 Rogers Labs, Inc.  
 4405 West 259<sup>th</sup> Terrace  
 Louisburg, KS 66053  
 Telephone/Facsimile: (913) 837-3214

This report shall not be reproduced except in full, without the written approval of the laboratory.  
 This report must not be used by the client to claim product endorsement by NVLAP, NIST, or  
 any agency of the U.S. Government.



# Table Of Contents

**TABLE OF CONTENTS..... 3**

**FORWARD ..... 6**

**OPINION / INTERPRETATION OF RESULTS ..... 6**

**ENVIRONMENTAL CONDITIONS..... 6**

**EQUIPMENT TESTED..... 6**

**APPLICATION FOR CERTIFICATION..... 7**

**APPLICABLE STANDARDS & TEST PROCEDURES ..... 8**

**EQUIPMENT FUNCTION AND CONFIGURATION..... 8**

**Equipment Configuration.....9**

**TEST SITE LOCATIONS ..... 9**

**UNITS OF MEASUREMENTS ..... 9**

**TEST PROCEDURES..... 10**

**AC Line Conducted Emission Test Procedure .....10**

**Radiated Emission Test Procedure.....10**

**LIST OF TEST EQUIPMENT ..... 11**

**INTENTIONAL RADIATORS..... 12**

**Antenna Requirements .....12**

**Restricted Bands of Operation.....12**

        Radiated Emissions in Restricted Bands Data (Chip Antenna configuration)..... 13

        Radiated Emissions in Restricted Bands Data (Omni Antenna configuration) .....14

**Summary of Results for Radiated Emissions in Restricted Bands .....15**

**AC Line Conducted Emissions Procedure .....15**

        Figure 1 AC Line Conducted Emissions Line 1 (POE 1)..... 16

        Figure 2 AC Line Conducted Emissions Line 2 (POE 1)..... 16

        AC Line Conducted Emissions Data (Highest Emissions POE 1) .....17

        Figure 3 AC Line Conducted Emissions Line 1 (POE 2)..... 18



Figure 4 AC Line Conducted Emissions Line 2 (POE 2) .....18  
AC Line Conducted Emissions Data (Highest Emissions POE 2) .....19  
**Summary of Results for AC Line Conducted Emissions .....19**  
**General Radiated Emissions Procedure.....20**  
Figure 5 General Radiated Emissions taken at 1 meter in screen room (POE 1).....21  
Figure 6 General Radiated Emissions taken at 1 meter in screen room (POE 1).....21  
Figure 7 General Radiated Emissions taken at 1 meter in screen room (POE 1).....22  
Figure 8 General Radiated Emissions taken at 1 meter in screen room (POE 1).....22  
Figure 9 General Radiated Emissions taken at 1 meter in screen room (POE 1).....23  
Figure 10 General Radiated Emissions taken at 1 meter in screen room (POE 1).....23  
Figure 11 General Radiated Emissions taken at 1 meter in screen room (POE 1).....24  
Figure 12 General Radiated Emissions taken at 1 meter in screen room (POE 2).....24  
Figure 13 General Radiated Emissions taken at 1 meter in screen room (POE 2).....25  
Figure 14 General Radiated Emissions taken at 1 meter in screen room (POE 2).....25  
Figure 15 General Radiated Emissions taken at 1 meter in screen room (POE 2).....26  
Figure 16 General Radiated Emissions taken at 1 meter in screen room (POE 2).....26  
Figure 17 General Radiated Emissions taken at 1 meter in screen room (POE 2).....27  
Figure 18 General Radiated Emissions taken at 1 meter in screen room (POE 2).....27  
General Radiated Emissions from EUT Data (Chip Antenna Emissions) .....28  
General Radiated Emissions from EUT Data (5dBi Dipole Emissions).....29  
**Summary of Results for General Radiated Emissions .....30**  
**Operation in the Frequency Band of 2400 – 2483.5 MHz.....30**  
Figure 19 Plot of Antenna Port Emissions (Across Operational Band, 20MHz CCK Mode) .....31  
Figure 20 Plot of Antenna Port Emissions (Across Operational Band, 20MHz CCK Mode) .....31  
Figure 21 Plot of Antenna Port Emissions (Across Operational Band, 20MHz OFDM Mode).....32  
Figure 22 Plot of Antenna Port Emissions (Across Operational Band, 20MHz OFDM Mode).....32  
Figure 23 Plot of Antenna Port Emissions (Across Operational Band, 40MHz Mode).....33  
Figure 24 Plot of Antenna Port Emissions (Across Operational Band, 40MHz Mode).....33  
Figure 25 Plot of 6dB Band width (20 MHz Mode, CCK 2412 MHz).....34  
Figure 26 Plot of 6dB Band width (20 MHz Mode, CCK 2437 MHz).....34  
Figure 27 Plot of 6dB Band width (20 MHz Mode, CCK 2462 MHz).....35  
Figure 28 Plot of 6dB Band width (20 MHz Mode, OFDM 2412 MHz) .....35  
Figure 29 Plot of 6dB Band width (20 MHz Mode, OFDM 2437 MHz) .....36  
Figure 30 Plot of 6dB Band width (20 MHz Mode, OFDM 2462 MHz) .....36  
Figure 31 Plot of 6dB Band width (40 MHz Mode, 2422 MHz).....37  
Figure 32 Plot of 6dB Band width (40 MHz Mode, 2437 MHz).....37  
Figure 33 Plot of 6dB Band width (40 MHz Mode, 2452 MHz).....38  
Figure 34 Plot of Power Spectral Density (20 MHz Mode, CCK 2412 MHz) .....38  
Figure 35 Plot of Power Spectral Density (20 MHz Mode, CCK 2437 MHz) .....39  
Figure 36 Plot of Power Spectral Density (20 MHz Mode, CCK 2462 MHz) .....39



Figure 37 Plot of Power Spectral Density (20 MHz Mode, OFDM 2412 MHz).....40

Figure 38 Plot of Power Spectral Density (20 MHz Mode, OFDM 2437 MHz).....40

Figure 39 Plot of Power Spectral Density (20 MHz Mode, OFDM 2462 MHz).....41

Figure 40 Plot of Power Spectral Density (40 MHz Mode, 2422 MHz) .....41

Figure 41 Plot of Power Spectral Density (40 MHz Mode, 2437 MHz) .....42

Figure 42 Plot of Power Spectral Density (40 MHz Mode, 2452 MHz) .....42

Figure 43 Plot of Band Edge Compliance at Antenna port (20 CCK MHz).....43

Figure 44 Plot of Band Edge Compliance at Antenna port (20 CCK MHz).....43

Figure 45 Plot of Band Edge Compliance at Antenna port (20 OFDM MHz) .....44

Figure 46 Plot of Band Edge Compliance at Antenna port (20 OFDM MHz) .....44

Figure 47 Plot of Band Edge Compliance at Antenna port (40 MHz).....45

Figure 48 Plot of Band Edge Compliance at Antenna port (40 MHz).....45

Figure 49 Plot of Antenna port conducted emissions .....46

Figure 50 Plot of Antenna port conducted emissions .....46

Figure 51 Plot of Antenna port conducted emissions .....47

Figure 52 Plot of Antenna port conducted emissions .....47

Figure 53 Plot of Antenna port conducted emissions .....48

Figure 54 Plot of Antenna port conducted emissions .....48

**Transmitter Emissions Data.....49**

Transmitter Antenna Port Conducted Emissions Data Summary .....49

Transmitter Antenna Port Conducted Harmonic Emissions Data (20 MHz Channel).....49

Transmitter Antenna Port Conducted Harmonic Emissions Data (40 MHz Channel).....50

Transmitter Radiated Emission (Chip Antenna, Worst-case).....50

Transmitter Radiated Emission (5dBi Dipole, Worst-case).....51

Summary of Results for Transmitter Radiated Emissions of Intentional Radiator.....51

**STATEMENT OF MODIFICATIONS AND DEVIATIONS ..... 51**

**ANNEX..... 52**

**Annex A Measurement Uncertainty Calculations.....53**

**Annex B Rogers Labs Test Equipment List.....55**

**Annex C Rogers Qualifications .....56**

**Annex D FCC Site Registration Letter.....57**

**Annex E Industry Canada Site Registration Letter .....58**



## Forward

The following information is submitted for consideration in obtaining Grant of Certification for License Exempt Digital Transmission System Intentional Radiator operating under CFR 47 Paragraph 15.247.

Name of Applicant: ARC Wireless LLC  
6330 N. Washington St., Unit 13  
Denver, CO 80216

Model: ARCFlex 802.11b/g/n Module  
FCC I.D.: Z2B-AFM1                      FRN: 0014 43 1100  
Frequency Range: 2412-2462 MHz (802.11 b/g), 2422-2452 MHz (802.11n mode)  
Operating Power: 21.43 dBm, 0.140-Watts output power

## Opinion / Interpretation of Results

Tests Performed	Margin (dB)	Results
Emissions as per CFR 47 paragraphs 2 and 15.205	-1.1	Complies
Emissions as per CFR 47 paragraphs 2 and 15.207	-9.9	Complies
Emissions as per CFR 47 paragraphs 2 and 15.209	-2.6	Complies
Emissions as per CFR 47 paragraphs 2 and 15.247	-4.4	Complies

## Environmental Conditions

Ambient Temperature            24.9° C  
Relative Humidity                51%  
Atmospheric Pressure          1014.9 mb

## Equipment Tested

<u>Equipment</u>	<u>Model</u>	<u>FCC I.D.</u>
EUT	ARCFlex 802.11b/g/n Module	Z2B-AFM1
POE/AC Adapter	TL-240075	N/A
POE/AC Adapter	UBI-POE-24-1	0909-0001936
Test Fixture	ARC Wireless	N/A
Dell Studio XPS	921LBN1	N/A

<u>Antenna/Type</u>	<u>Model</u>	<u>Gain</u>
Dipole	XQZ-2400E-1	5 dBi
PCB Mounted Chip	N/A	1 dBi



## Application for Certification

- (1) Manufacturer: ARC Wireless LLC  
6330 N. Washington St., Unit 13  
Denver, CO 80216
- (2) Identification: Model: ARCFlex 802.11b/g/n Module  
FCC I.D.: Z2B-AFM1
- (3) Instruction Book:  
Refer to Exhibit for Instruction Manual.
- (4) Description of Circuit Functions:  
Refer to Exhibit of Operational Description.
- (5) Block Diagram with Frequencies:  
Refer to Exhibit of Operational Description.
- (6) Report of Measurements:  
Report of measurements follows in this Report.
- (7) Photographs: Construction, Component Placement, etc.:  
Refer to Exhibit for photographs of equipment.
- (8) List of Peripheral Equipment Necessary for operation. The equipment operates from power received from supporting equipment. Testing was performed with the EUT placed on test fixture powered from manufacturer supplied POE (Power Over Ethernet) adapter. The EUT requires placement into supporting circuitry for I/O connections. Two versions are offered PCB mounted Chip and u.fl connection port for authorized antennas. During testing, the EUT was connected to test support fixture, which was communicating to the CPU through network cable and power supplied from external POE adapter.
- (9) Transition Provisions of CFR47 15.37 are not requested.
- (10) Not Applicable. The unit is not a scanning receiver.
- (11) Not Applicable. The EUT does not operate in the 59 – 64 GHz frequency band.
- (12) The equipment is not software defined and this section is not applicable.



## Applicable Standards & Test Procedures

In accordance with the Federal Communications Code of Federal Regulations, dated October 1, 2010, Part 2, Subpart J, Paragraphs 2.907, 2.911, 2.913, 2.925, 2.926, 2.1031 through 2.1057, and applicable parts of paragraph 15, Part 15C Paragraph 15.247 the following information is submitted.

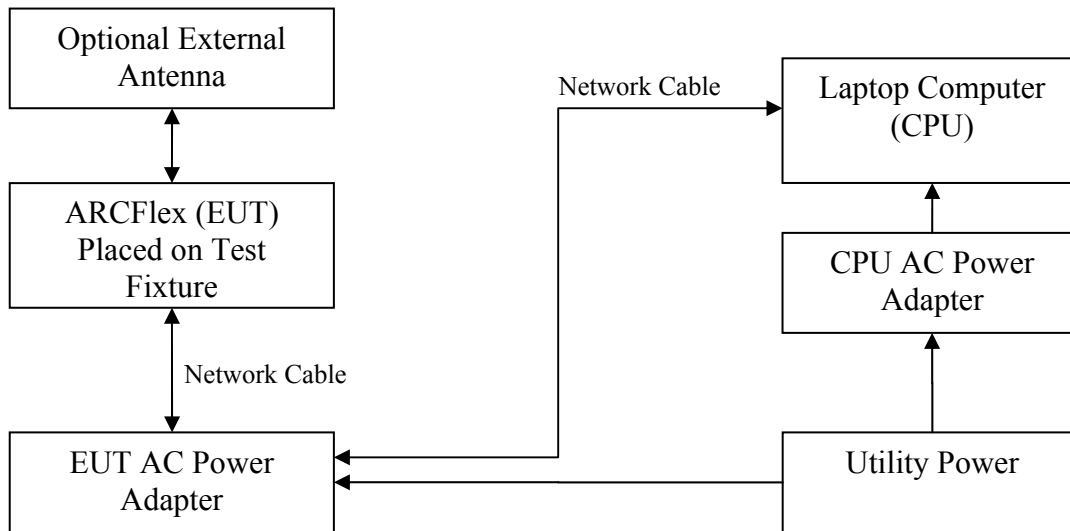
Test procedures used are the established Methods of Measurement of Radio-Noise Emissions as described in the ANSI C63.4-2009 Document, FCC documents KDB 662911 MIMO, DA00-1407 and DA00-705 and/or TIA/EIA 603-1. Testing for the AC line-conducted emissions were performed as defined in sections 7 and 13.1.3, testing of the radiated emissions was performed as defined in sections 8 and 13.1.4 of ANSI C63.4-2009. Testing of the intentional radiated emissions was performed as defined in section 13 of ANSI C63.4-2009.

## Equipment Function and Configuration

The EUT is a 2412-2462 MHz Single Input Single Output 802.11 b/g/n Digital Transmission System transmitter. The design offers two options for transmitter output, either a printed circuit board mounted chip antenna or u/fl provision for connection to authorized external antenna. The equipment is used to transmit data in applications offering broadband wireless connectivity. The equipment is marketed for use to incorporate a wireless link to exchange data information from one point to another. For testing purposes, the ARCFlex 802.11b/g/n Module was connected to the manufacturer supplied test fixture and POE power adapter. The test fixture was connected to the laptop and communicating over network interface allowing for operational control of the transmitter. The ARCFlex 802.11b/g/n Module receives power from the support test fixture, which was powered from supplied POE AC adapter. Two POE adapters were supplied for testing. The EUT offers connection port for authorized antennas and requires power supplied from external support circuitry. No other interfacing options are provided. For testing purposes, the ARCFlex 802.11b/g/n Module was powered from the POE power adapter and set to transmit in available data modes. Worst-case data presented in this report. The device is marketed for OEM use and professional installation. The antenna connection and options comply with the unique antenna connection requirements.



### Equipment Configuration



### Test Site Locations

**Conducted EMI**      The AC power line conducted emissions testing performed in a shielded screen room located at Rogers Labs, Inc., 4405 W. 259<sup>th</sup> Terrace, Louisburg, KS

**Radiated EMI**      The radiated emissions tests were performed at the 3 meters, Open Area Test Site (OATS) located at Rogers Labs, Inc., 4405 W. 259<sup>th</sup> Terrace, Louisburg, KS

**Site Registration**      Refer to Annex for Site Registration Letters

**NVLAP Accreditation**      Lab code 200087-0

### Units of Measurements

**Conducted EMI**      Data is in dB $\mu$ V; dB referenced to one microvolt

**Radiated EMI**      Data is in dB $\mu$ V/m; dB/m referenced to one microvolt per meter

Sample Calculation:

RFS = Radiated Field Strength, FSM = Field Strength Measured

A.F. = Receive antenna factor, Gain = amplification gains and/or cable losses

$RFS (dB\mu V/m @ 3m) = FSM (dB\mu V) + A.F. (dB) - Gain (dB)$

## Test Procedures

### ***AC Line Conducted Emission Test Procedure***

The EUT operates from DC power only. The EUT must be connected to support circuitry for power using approved AC adapter/POE for operation. For testing purposes, the manufacturer supplied test fixture and POE AC power adapter was used to power the EUT and system.

Testing for the AC line-conducted emissions testing was performed as defined in sections 7 and 13.1.3 of ANSI C63.4-2009. The test setup including the EUT was arranged in typical equipment configurations and placed on a 1 x 1.5-meter wooden bench, 0.8 meters high located in a screen room. The power lines of the system were isolated from the power source using a standard LISN with a 50- $\mu$ Hy choke. EMI was coupled to the spectrum analyzer through a 0.1  $\mu$ F capacitor internal to the LISN. The LISN was positioned on the floor beneath the wooden bench supporting the EUT. The power lines and cables were draped over the back edge of the table.

### ***Radiated Emission Test Procedure***

The EUT was placed on a rotating 1 x 1.5-meter wooden platform, 0.8 meters above the ground plane at a distance of 3 meters from the FSM antenna. Testing for the radiated emissions was performed as defined in sections 8 and 13.1.4 of ANSI C63.4-2009. EMI energy was maximized by equipment placement, raising and lowering the FSM antenna, changing the antenna polarization, and by rotating the turntable. Each emission was maximized before data was taken using a spectrum analyzer. Refer to photographs in the test setup exhibits for EUT placement during testing.

## List of Test Equipment

A Rohde and Schwarz ESU40 and/or Hewlett Packard 8591EM was used as the measuring device for the emissions testing of frequencies below 1 GHz. A Rohde and Schwarz ESU40 and/or Hewlett Packard 8562A Spectrum Analyzer was used as the measuring device for testing the emissions at frequencies above 1 GHz. The analyzer settings used are described in the following table. Refer to the appendix for a complete list of test equipment.

AC Line Conducted Emissions (0.150 -30 MHz)		
RBW	AVG. BW	Detector Function
9 kHz	30 kHz	Peak / Quasi Peak
Emissions (30-1000 MHz)		
RBW	AVG. BW	Detector Function
120 kHz	300 kHz	Peak / Quasi Peak
Emissions (Above 1000 MHz)		
RBW	Video BW	Detector Function
100 kHz	100 kHz	Peak
1 MHz	1 MHz	Peak / Average

<u>Equipment</u>	<u>Manufacturer</u>	<u>Model</u>	<u>Calibration Date</u>	<u>Due</u>
LISN	Comp. Design	FCC-LISN-2-MOD.CD	10/10	10/11
Antenna	ARA	BCD-235-B	10/10	10/11
Antenna	EMCO	3147	10/10	10/11
Antenna	EMCO	3143	5/11	5/12
Analyzer	HP	8591EM	5/11	5/12
Analyzer	HP	8562A	5/11	5/12
Analyzer	Rohde & Schwarz	ESU40	5/11	5/12



## **Intentional Radiators**

As per CFR47, Subpart C, paragraph 15.247 the following information is submitted.

### ***Antenna Requirements***

The EUT design incorporates either PCB mounted chip antenna or u.fl antenna connection port for use with authorized antenna systems only. The design is marketed for OEM and professional installation and use as described in accompanying documentation. The antenna connection point complies with the unique antenna connection requirements. The requirements of 15.203 are fulfilled; there are no deviations or exceptions to the specification.

### ***Restricted Bands of Operation***

Spurious emissions falling in the restricted frequency bands of operation were measured at a distance of three meters on the OATS. The EUT utilizes frequency, determining circuitry, which generates harmonics falling in the restricted bands. Emissions were measured at the OATS, using appropriate antennas or pyramidal horns, amplification stages, and a spectrum analyzer. No other significant emission was observed which fell into the restricted bands of operation.

**Radiated Emissions in Restricted Bands Data (Chip Antenna configuration)**

Frequency in MHz	Horizontal Peak (dBµV/m)	Horizontal Quasi-Peak (dBµV/m)	Horizontal Average (dBµV/m)	Vertical Peak (dBµV/m)	Vertical Quasi-Peak (dBµV/m)	Vertical Average (dBµV/m)	Limit @ 3m (dBµV/m)
115.2	38.3	33.9	N/A	37.6	32.4	N/A	43.5
115.4	38.1	33.2	N/A	37.0	32.3	N/A	43.5
118.4	37.9	33.1	N/A	36.9	32.5	N/A	43.5
119.0	37.6	33.1	N/A	36.6	32.3	N/A	43.5
123.2	37.8	32.1	N/A	41.0	28.4	N/A	43.5
125.0	43.2	40.1	N/A	37.4	33.8	N/A	43.5
129.5	37.5	32.0	N/A	32.6	27.4	N/A	43.5
131.0	37.7	32.5	N/A	32.5	27.5	N/A	43.5
136.0	37.8	32.3	N/A	31.5	26.2	N/A	43.5
150.6	42.1	37.6	N/A	31.8	26.8	N/A	43.5
250.0	44.6	43.4	N/A	43.8	42.6	N/A	46.0
1066.9	57.9	N/A	42.5	48.2	N/A	36.0	54.0
2390.0	54.5	N/A	44.6	57.7	N/A	47.1	54.0
2483.5	58.5	N/A	45.9	61.0	N/A	52.9	54.0
4824.0	55.3	N/A	42.6	55.6	N/A	42.9	54.0
4874.0	55.3	N/A	42.8	55.5	N/A	42.9	54.0
4924.0	54.0	N/A	16.6	16.1	N/A	42.6	54.0
7236.0	47.5	N/A	34.7	48.0	N/A	34.8	54.0
7311.0	44.8	N/A	32.1	45.2	N/A	33.1	54.0
7386.0	54.0	N/A	16.6	16.1	N/A	33.3	54.0
12060.0	48.7	N/A	35.9	48.6	N/A	35.9	54.0
12185.0	48.5	N/A	35.6	48.0	N/A	35.2	54.0
12310.0	47.8	N/A	35.1	48.7	N/A	35.5	54.0
14472.0	51.1	N/A	38.4	51.5	N/A	38.3	54.0
19296.0	53.9	N/A	41.2	54.1	N/A	41.3	54.0
19496.0	55.7	N/A	42.7	56.2	N/A	42.8	54.0
19696.0	55.1	N/A	42.4	55.0	N/A	42.4	54.0

Other emissions present had amplitudes at least 20 dB below the limit.

Quasi-Peak amplitude emissions are recorded above for frequency range of 30-1000 MHz.

Average amplitude emissions are recorded above for frequency range above 1000 MHz.

**Radiated Emissions in Restricted Bands Data (Omni Antenna configuration)**

Frequency in MHz	Horizontal Peak (dBµV/m)	Horizontal Quasi-Peak (dBµV/m)	Horizontal Average (dBµV/m)	Vertical Peak (dBµV/m)	Vertical Quasi-Peak (dBµV/m)	Vertical Average (dBµV/m)	Limit @ 3m (dBµV/m)
115.2	38.3	33.8	N/A	37.4	32.4	N/A	43.5
115.4	38.1	33.3	N/A	36.9	32.3	N/A	43.5
118.4	37.9	33.2	N/A	36.8	32.5	N/A	43.5
119.0	37.6	33.2	N/A	36.4	32.3	N/A	43.5
123.2	37.8	32.0	N/A	40.9	28.4	N/A	43.5
125.0	43.2	39.8	N/A	37.0	33.8	N/A	43.5
129.5	37.5	31.9	N/A	32.4	27.4	N/A	43.5
131.0	37.7	31.9	N/A	32.3	27.5	N/A	43.5
136.0	37.8	32.1	N/A	31.0	26.2	N/A	43.5
150.6	42.1	37.2	N/A	31.6	26.8	N/A	43.5
250.0	44.6	43.3	N/A	43.8	42.4	N/A	46.0
1066.9	57.9	N/A	42.3	48.2	N/A	35.9	54.0
2390.0	54.9	N/A	45.5	59.3	N/A	51.8	54.0
2483.5	58.8	N/A	49.4	56.8	N/A	51.6	54.0
4824.0	55.6	N/A	43.2	57.6	N/A	47.1	54.0
4874.0	56.4	N/A	43.8	58.1	N/A	48.2	54.0
4924.0	54.0	N/A	16.6	16.1	N/A	49.6	54.0
7236.0	48.4	N/A	35.4	49.1	N/A	37.4	54.0
7311.0	45.9	N/A	33.1	46.5	N/A	34.8	54.0
7386.0	54.0	N/A	16.6	16.1	N/A	33.7	54.0
12060.0	48.8	N/A	35.9	48.9	N/A	36.0	54.0
12185.0	47.9	N/A	35.4	48.8	N/A	35.9	54.0
12310.0	49.0	N/A	35.5	48.1	N/A	35.2	54.0
14472.0	51.1	N/A	38.4	51.0	N/A	38.3	54.0
19296.0	53.8	N/A	41.0	53.9	N/A	41.0	54.0
19496.0	55.3	N/A	42.4	55.5	N/A	42.4	54.0
19696.0	54.8	N/A	42.2	55.1	N/A	42.2	54.0

Other emissions present had amplitudes at least 20 dB below the limit.

Quasi-Peak amplitude emissions are recorded above for frequency range of 30-1000 MHz.

Average amplitude emissions are recorded above for frequency range above 1000 MHz.

## ***Summary of Results for Radiated Emissions in Restricted Bands***

The EUT demonstrated compliance with the radiated emissions requirements of CFR 47 Part 15C Intentional Radiators. The EUT demonstrated a minimum margin of -1.1 dB below the radiated emissions requirements in restricted frequency bands. Peak, Quasi-peak, and average amplitudes were checked for compliance with the regulations. Worst-case emissions are reported with other emissions found in the restricted frequency bands at least 20 dB below the requirements.

## ***AC Line Conducted Emissions Procedure***

The EUT was arranged in the test fixture emulating worst-case equipment configuration. This configuration was placed on a 1 x 1.5-meter wooden bench 80 cm above the conducting ground plane, floor of a screen room. The bench was positioned 40 cm away from the wall of the screen room. The LISN was positioned on the floor of the screen room 80-cm from the rear of the EUT. The manufacturer supplied POE power adapter was connected to the LISN. A second LISN was positioned on the floor of the screen room 80-cm from the rear of the supporting equipment of the EUT. All power cords except the EUT were then powered from the second LISN. EMI was coupled to the spectrum analyzer through a 0.1  $\mu$ F capacitor, internal to the LISN. Power line conducted emissions testing were carried out individually for each current carrying conductor of the EUT. The excess length of lead between the system and the LISN receptacle was folded back and forth to form a bundle not exceeding 40 cm in length. The screen room, conducting ground plane, analyzer, and LISN were bonded together to the protective earth ground. Preliminary testing was performed to identify the frequency of each radio frequency emission displaying the highest amplitude. The cables were repositioned to obtain maximum amplitude of measured EMI level. Once the worst-case configuration was identified, plots were made of the EMI from 0.15 MHz to 30 MHz then the data was recorded with maximum conducted emissions levels. Refer to figures one through four for plots of the EUT powered by POE adapter AC Power Line conducted emissions.

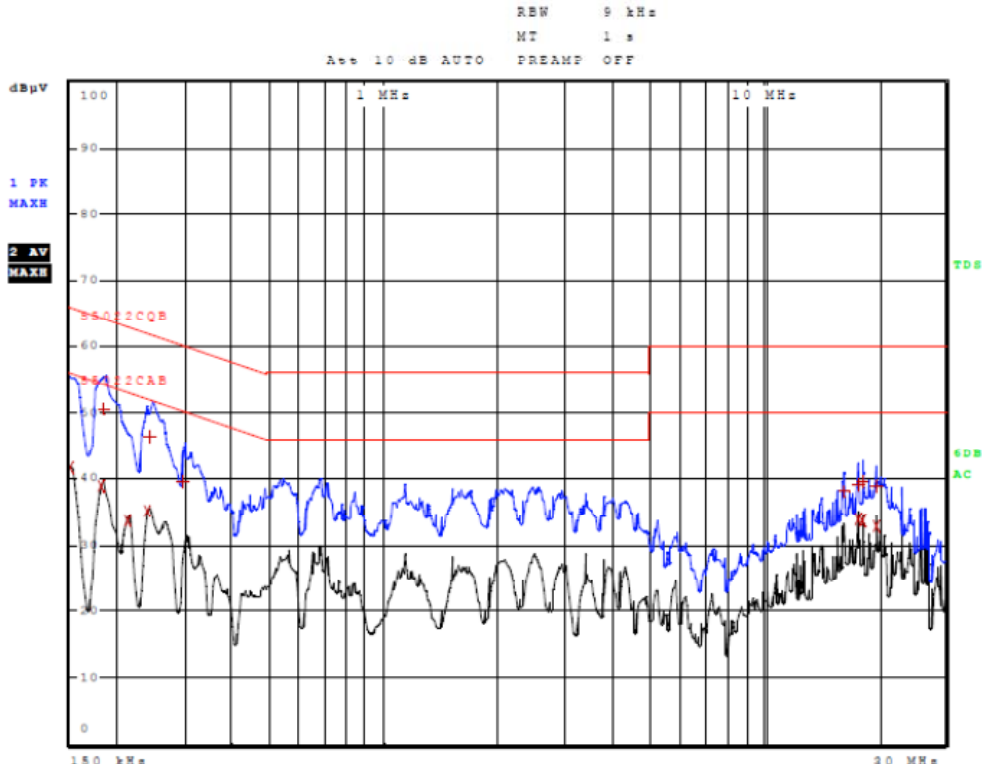


Figure 1 AC Line Conducted Emissions Line 1 (POE 1)

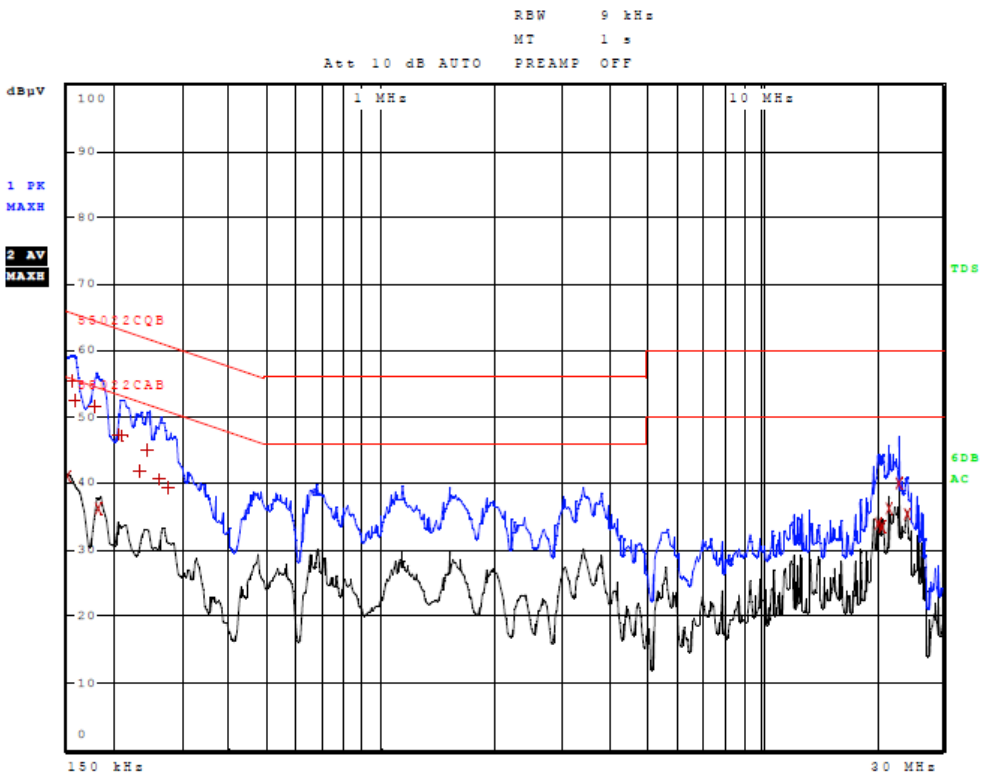


Figure 2 AC Line Conducted Emissions Line 2 (POE 1)





**AC Line Conducted Emissions Data (Highest Emissions POE 1)**

Line 1

Trace	Frequency	Level (dBµV)	Detector	Delta Limit/dB
2	150.000000000 kHz	41.69	Average	-14.31
1	150.000000000 kHz		Quasi Peak	
2	182.000000000 kHz	39.05	Average	-15.34
1	186.000000000 kHz	50.58	Quasi Peak	-13.64
2	214.000000000 kHz	33.67	Average	-19.38
2	242.000000000 kHz	35.18	Average	-16.84
1	246.000000000 kHz	46.28	Quasi Peak	-15.61
1	298.000000000 kHz	39.60	Quasi Peak	-20.69
1	16.232000000 MHz	38.13	Quasi Peak	-21.87
2	17.696000000 MHz	33.97	Average	-16.03
1	17.696000000 MHz	39.27	Quasi Peak	-20.73
1	18.244000000 MHz	39.65	Quasi Peak	-20.35
2	18.248000000 MHz	33.69	Average	-16.31
2	19.712000000 MHz	32.80	Average	-17.20

Line 2

Trace	Frequency	Level (dBµV)	Detector	Delta Limit/dB
2	150.000000000 kHz	41.03	Average	-14.97
1	154.000000000 kHz	55.43	Quasi Peak	-10.35
1	158.000000000 kHz	52.34	Quasi Peak	-13.23
1	178.000000000 kHz	51.66	Quasi Peak	-12.92
2	182.000000000 kHz	36.33	Average	-18.06
1	206.000000000 kHz	47.34	Quasi Peak	-16.02
1	210.000000000 kHz	47.22	Quasi Peak	-15.98
1	234.000000000 kHz	41.97	Quasi Peak	-20.33
1	246.000000000 kHz	45.00	Quasi Peak	-16.90
1	262.000000000 kHz	40.74	Quasi Peak	-20.63
1	278.000000000 kHz	39.31	Quasi Peak	-21.57
2	20.260000000 MHz	33.91	Average	-16.09
2	20.812000000 MHz	33.59	Average	-16.41
2	21.668000000 MHz	36.14	Average	-13.86
2	23.132000000 MHz	40.10	Average	-9.90
2	24.352000000 MHz	35.50	Average	-14.50

Other emissions present had amplitudes at least 20 dB below the limit.

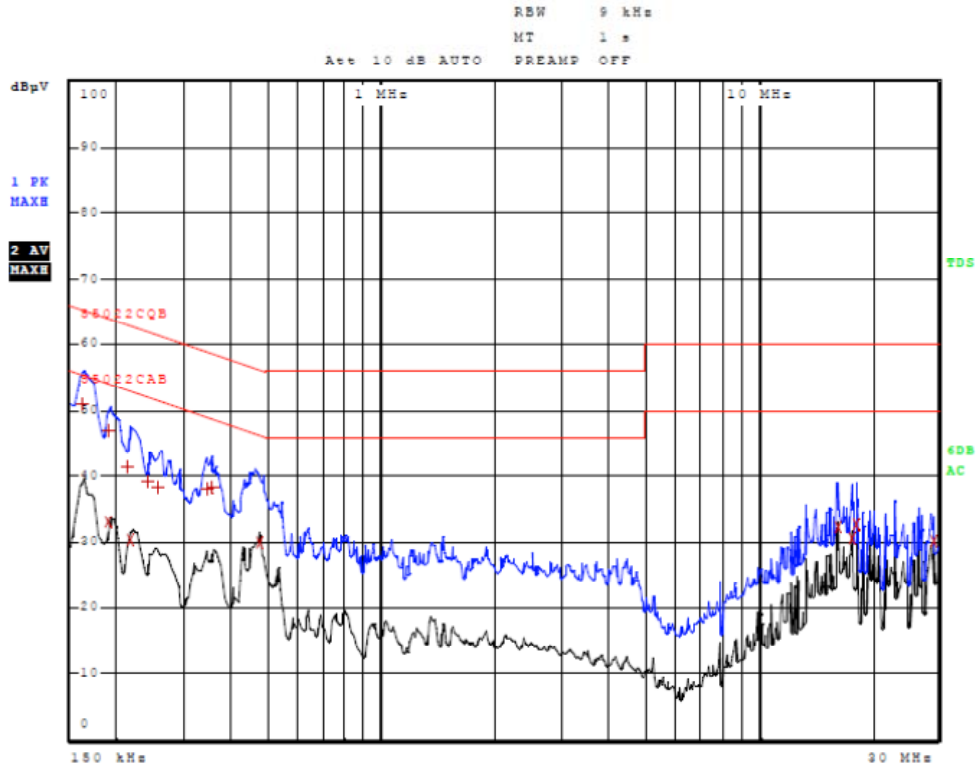


Figure 3 AC Line Conducted Emissions Line 1 (POE 2)

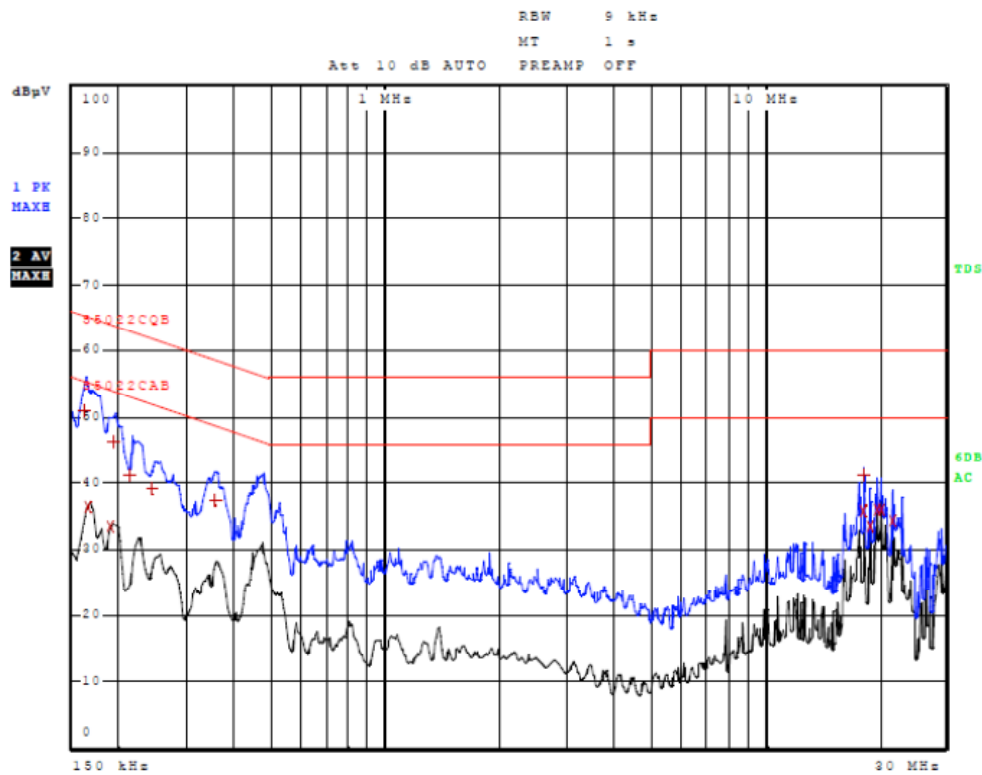


Figure 4 AC Line Conducted Emissions Line 2 (POE 2)



**AC Line Conducted Emissions Data (Highest Emissions POE 2)**

Line 1 (POE 2)

Trace	Frequency	Level (dBµV)	Detector	Delta Limit/dB
1	162.000000000 kHz	51.03	Quasi Peak	-14.33
2	190.000000000 kHz	33.18	Average	-20.86
1	190.000000000 kHz	47.03	Quasi Peak	-17.01
1	214.000000000 kHz	41.57	Quasi Peak	-21.48
2	218.000000000 kHz	30.30	Average	-22.59
1	242.000000000 kHz	39.16	Quasi Peak	-22.86
1	258.000000000 kHz	38.41	Quasi Peak	-23.09
1	342.000000000 kHz	38.23	Quasi Peak	-20.92
1	354.000000000 kHz	38.30	Quasi Peak	-20.56
2	474.000000000 kHz	29.97	Average	-16.47
2	16.228000000 MHz	32.25	Average	-17.75
2	17.692000000 MHz	30.55	Average	-19.45
2	18.244000000 MHz	32.61	Average	-17.39
2	29.240000000 MHz	30.22	Average	-19.78

Line 2 (POE 2)

Trace	Frequency	Level (dBµV)	Detector	Delta Limit/dB
1	162.000000000 kHz	50.88	Quasi Peak	-14.49
2	166.000000000 kHz	36.54	Average	-18.62
2	190.000000000 kHz	33.45	Average	-20.58
1	194.000000000 kHz	46.37	Quasi Peak	-17.49
1	214.000000000 kHz	41.31	Quasi Peak	-21.74
1	246.000000000 kHz	39.18	Quasi Peak	-22.71
1	354.000000000 kHz	37.51	Quasi Peak	-21.36
2	18.244000000 MHz	35.82	Average	-14.18
1	18.244000000 MHz	41.20	Quasi Peak	-18.80
2	18.916000000 MHz	33.59	Average	-16.41
2	19.708000000 MHz	35.97	Average	-14.03
2	20.260000000 MHz	36.01	Average	-13.99
2	21.664000000 MHz	34.39	Average	-15.61

Other emissions present had amplitudes at least 20 dB below the limit.

**Summary of Results for AC Line Conducted Emissions**

The EUT demonstrated compliance to the conducted emissions requirements of CFR47 Part 15C equipment. The EUT demonstrated minimum margin of -9.9 dB below the limit. Measurements were taken using the peak, quasi peak, and average, measurement function for each emissions amplitude and were below the limits stated in the specification. Other emissions were present with recorded data representing worst-case amplitudes.



### **General Radiated Emissions Procedure**

The EUT was arranged in a typical equipment configuration and operated through all available modes with worst-case data recorded. Preliminary testing was performed in a screen room with the EUT positioned 1 meter from the FSM. Radiated emissions measurements were performed to identify the frequencies, which produced the highest emissions. Plots were made of the radiated frequency spectrum from 30 MHz to 25,000 MHz for the preliminary testing. Refer to figures five through eleven for plots of the general radiated emissions spectrum (POE 1 configuration) taken in a screen room. Refer to figures twelve through eighteen for plots of the general radiated emissions spectrum (POE 2 configuration) taken in a screen room. Each radiated emission was then maximized at the OATS location before final radiated emissions measurements were performed. Final data was taken with the EUT located at the OATS at a distance of 3 meters between the EUT and the receiving antenna. The frequency spectrum from 30 MHz to 25,000 MHz was searched for general radiated emissions. Measured emission levels were maximized by EUT placement on the table, rotating the turntable through 360 degrees, varying the antenna height between 1 and 4 meters above the ground plane and changing antenna position between horizontal and vertical polarization. Antennas used were Broadband Biconical from 30 to 200 MHz, Biconilog from 30 to 1000 MHz, Log Periodic from 200 MHz to 1 GHz and or double Ridge or pyramidal horns and mixers from 1 GHz to 40 GHz, notch filters and appropriate amplifiers and external mixers were utilized.

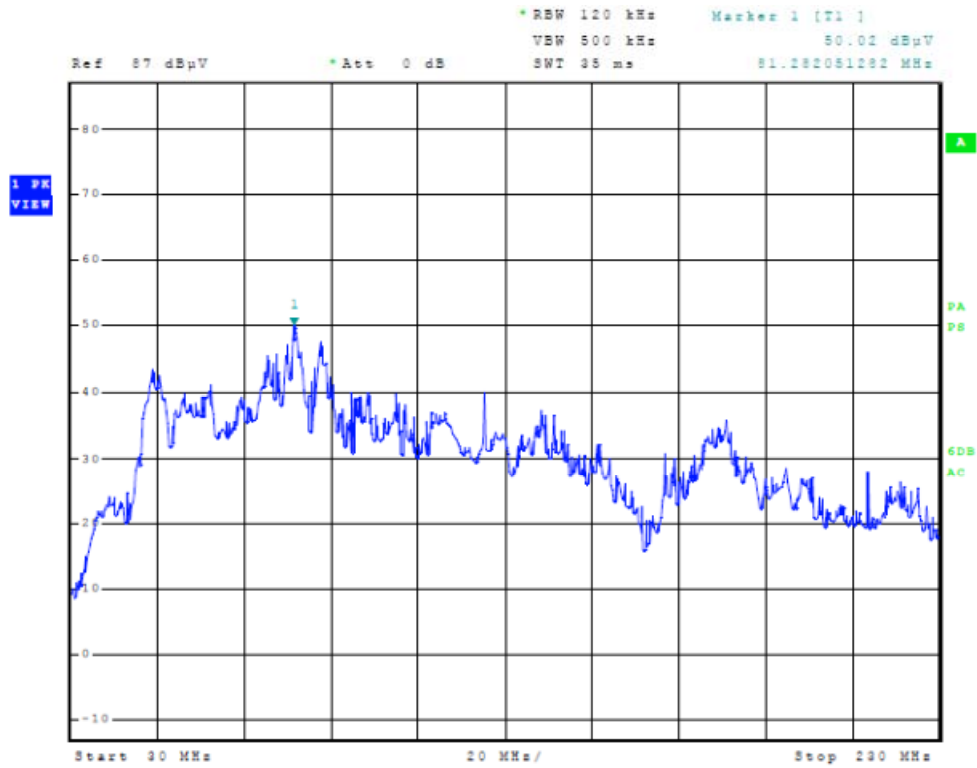


Figure 5 General Radiated Emissions taken at 1 meter in screen room (POE 1)

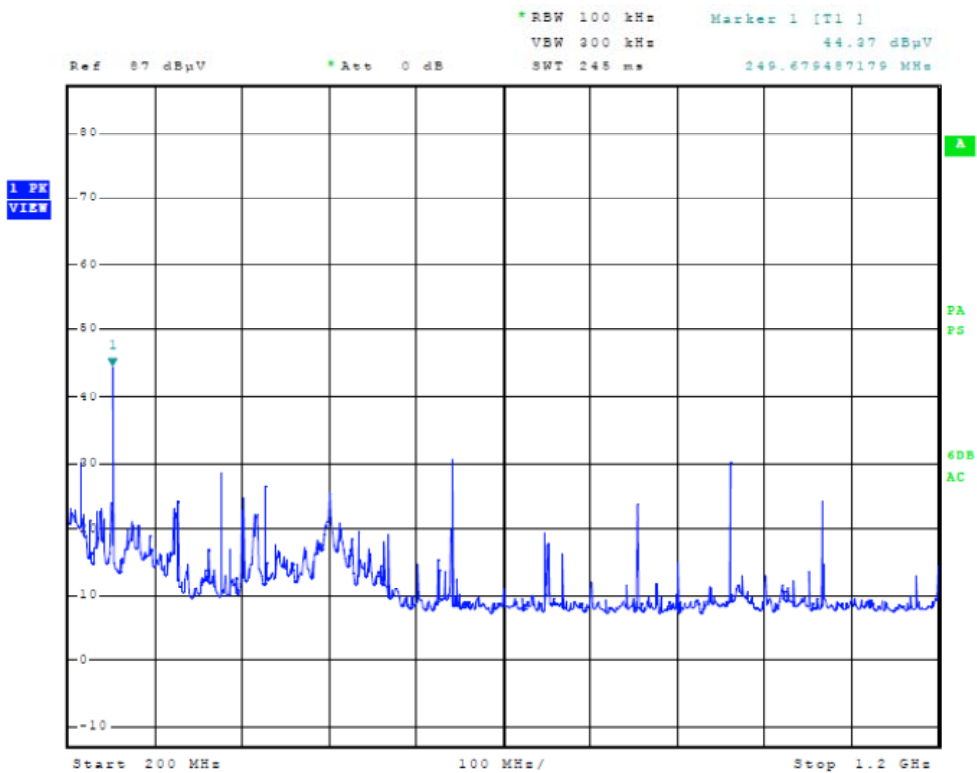


Figure 6 General Radiated Emissions taken at 1 meter in screen room (POE 1)

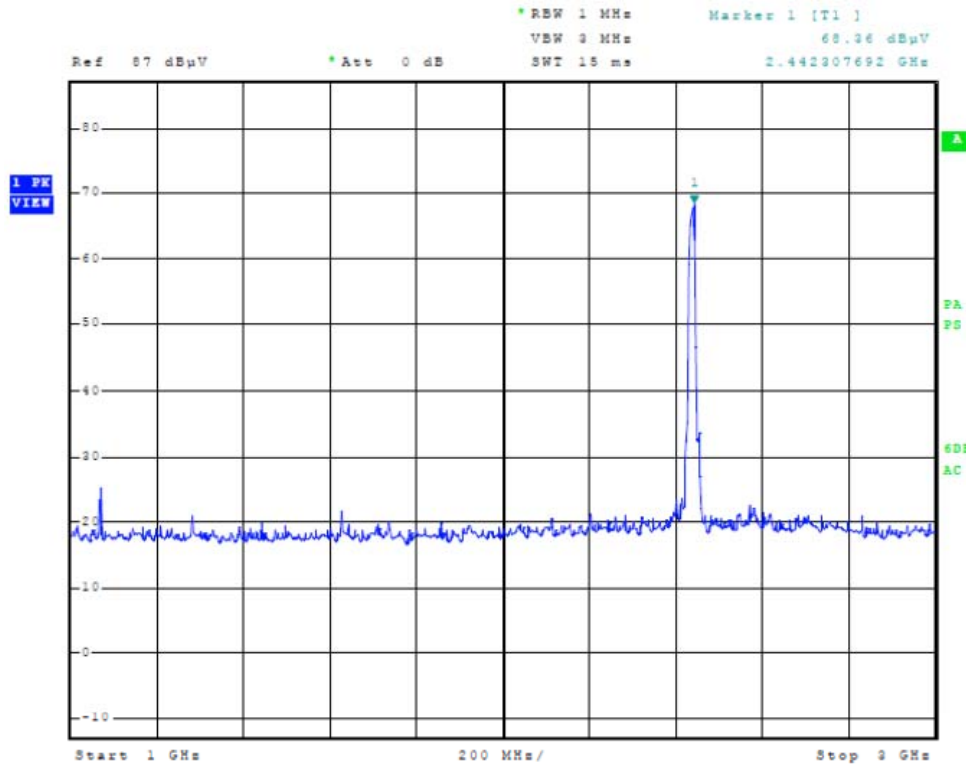


Figure 7 General Radiated Emissions taken at 1 meter in screen room (POE 1)

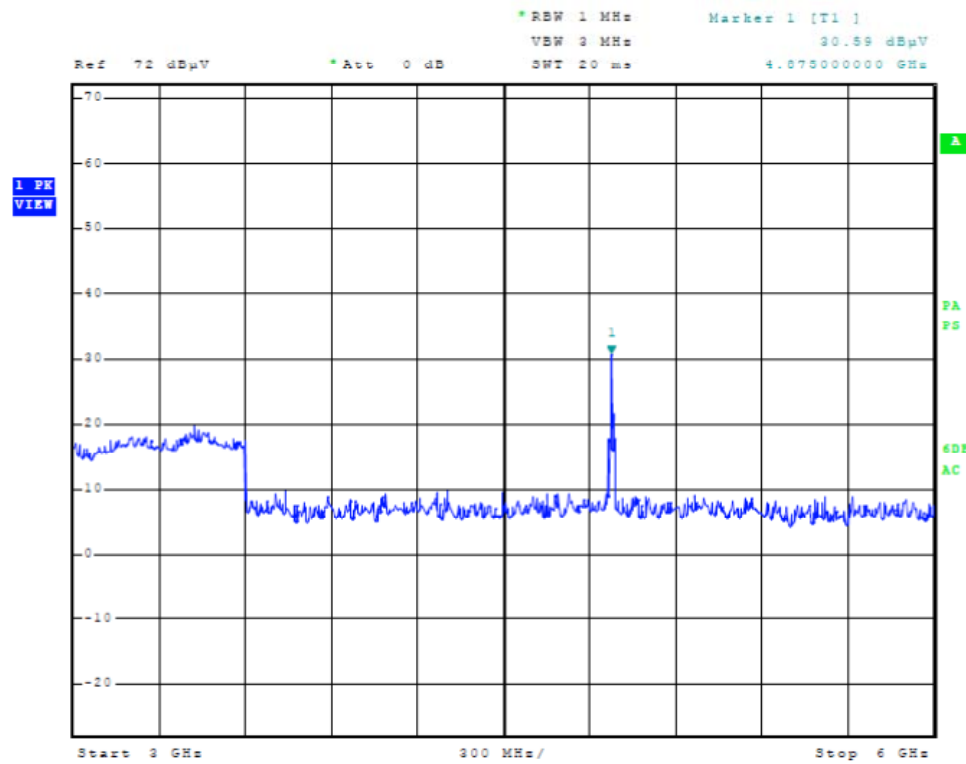
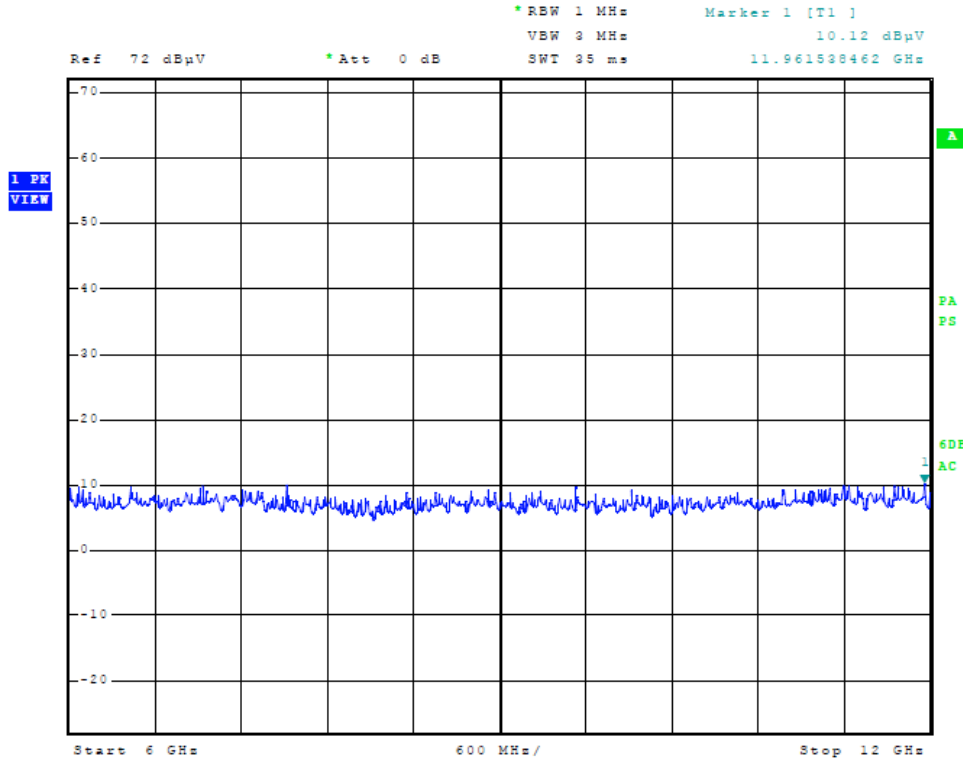
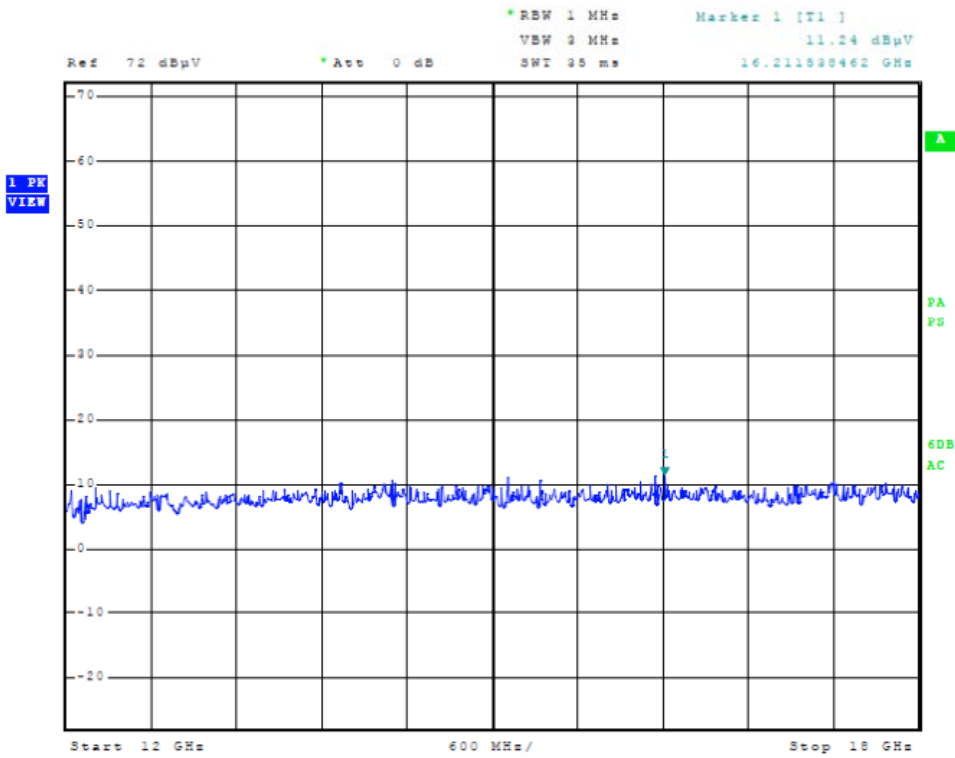


Figure 8 General Radiated Emissions taken at 1 meter in screen room (POE 1)



**Figure 9 General Radiated Emissions taken at 1 meter in screen room (POE 1)**



**Figure 10 General Radiated Emissions taken at 1 meter in screen room (POE 1)**



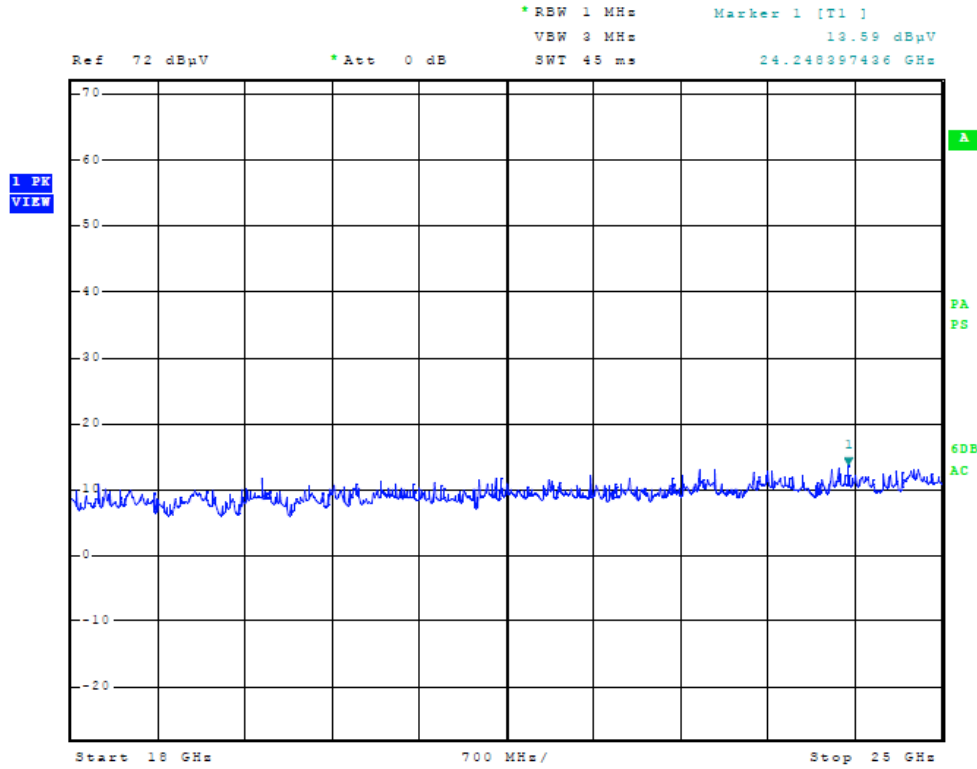


Figure 11 General Radiated Emissions taken at 1 meter in screen room (POE 1)

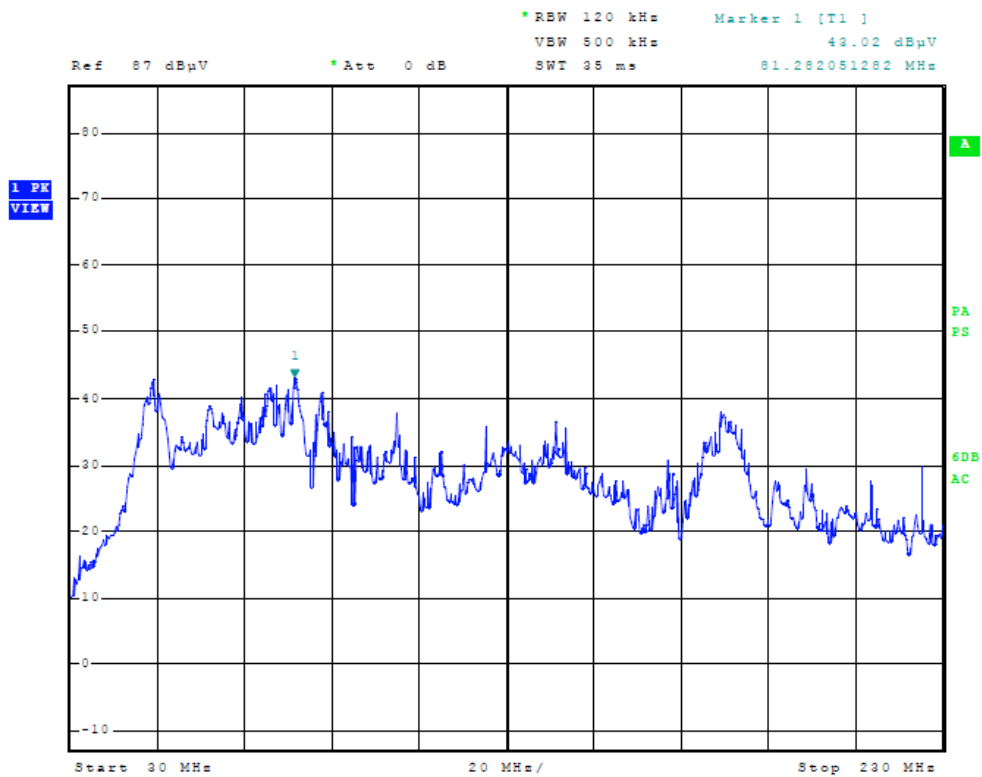
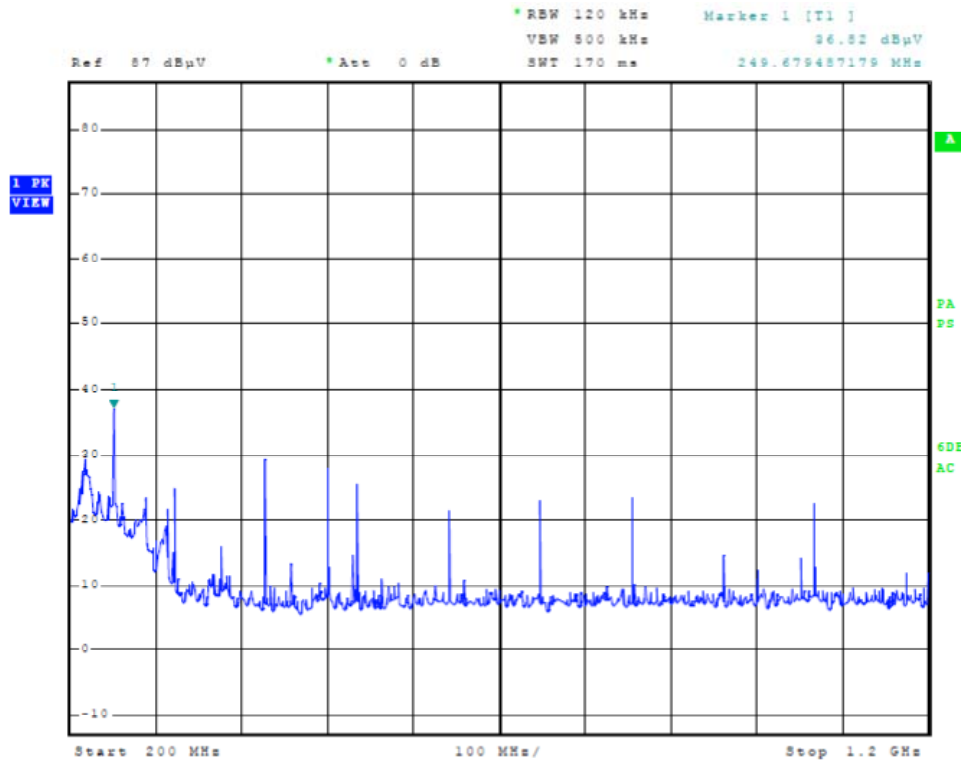
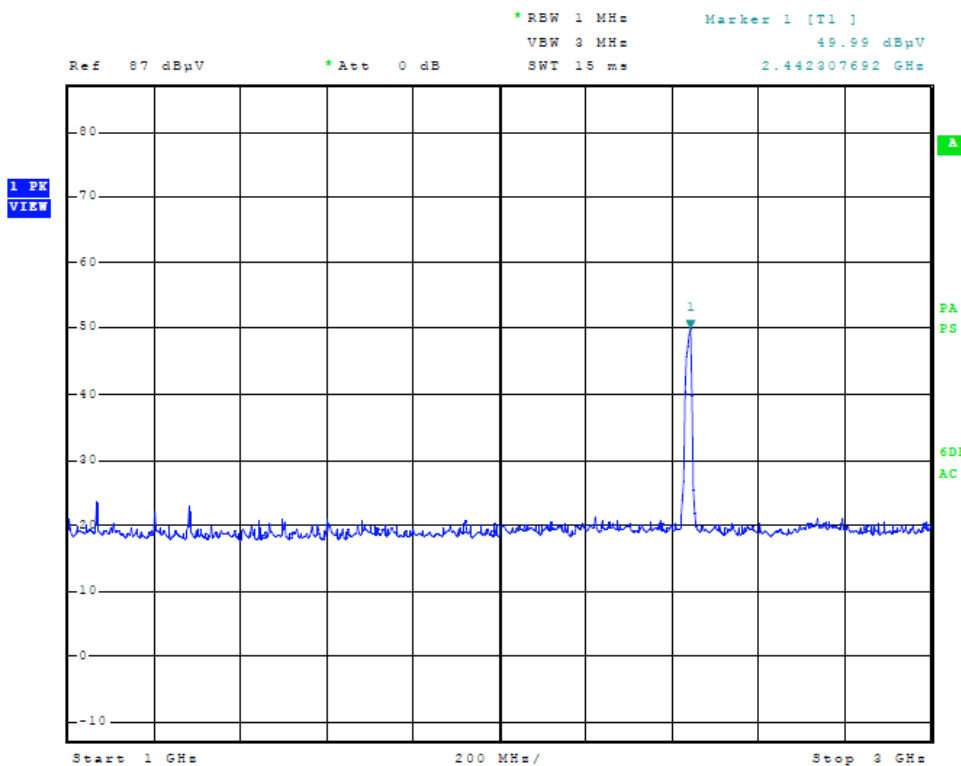


Figure 12 General Radiated Emissions taken at 1 meter in screen room (POE 2)





**Figure 13 General Radiated Emissions taken at 1 meter in screen room (POE 2)**



**Figure 14 General Radiated Emissions taken at 1 meter in screen room (POE 2)**

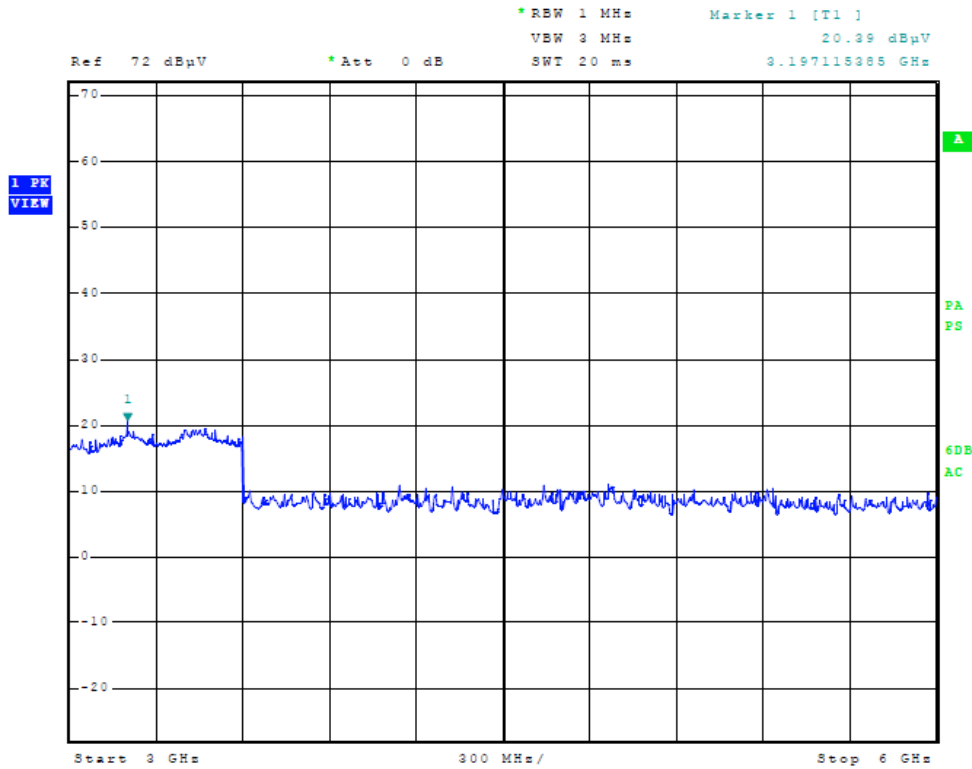


Figure 15 General Radiated Emissions taken at 1 meter in screen room (POE 2)

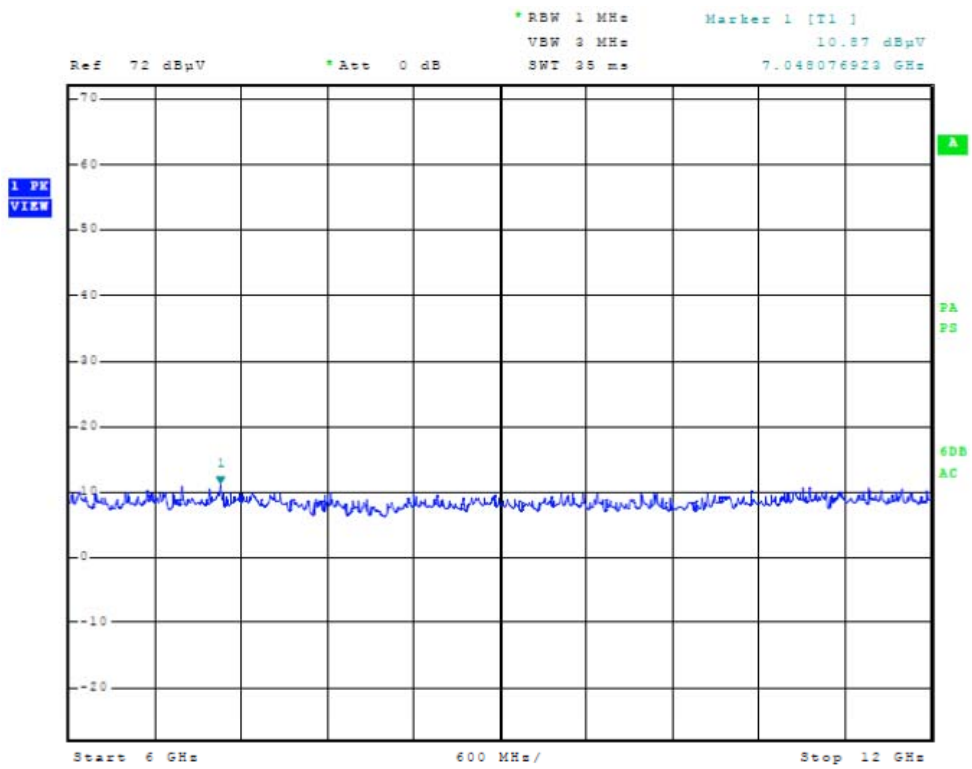


Figure 16 General Radiated Emissions taken at 1 meter in screen room (POE 2)

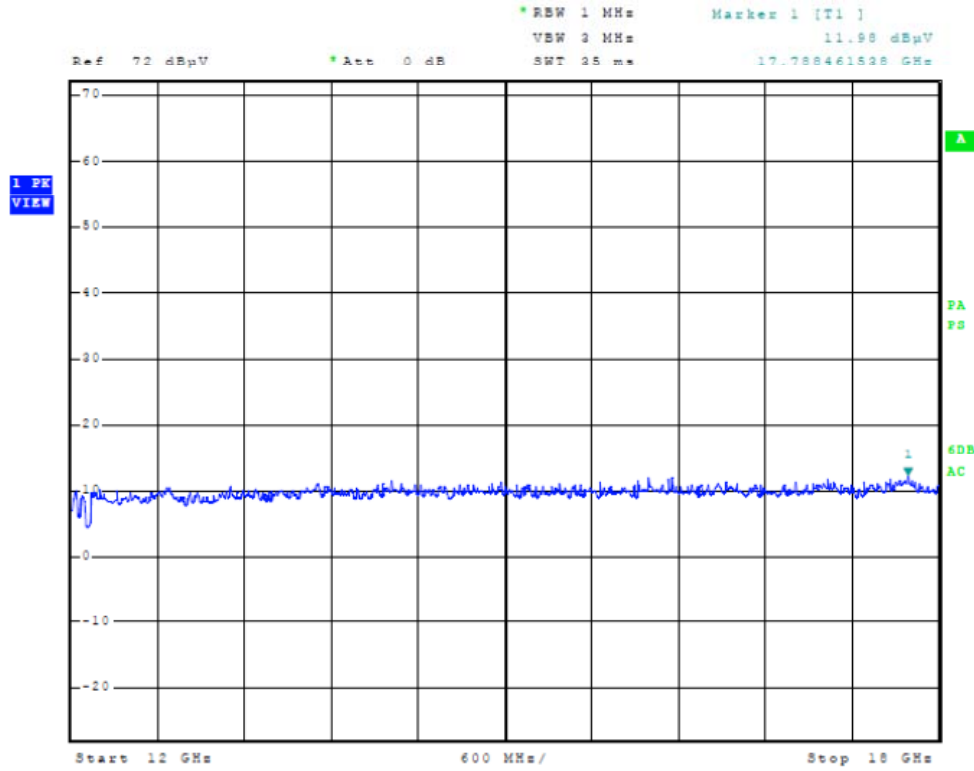


Figure 17 General Radiated Emissions taken at 1 meter in screen room (POE 2)

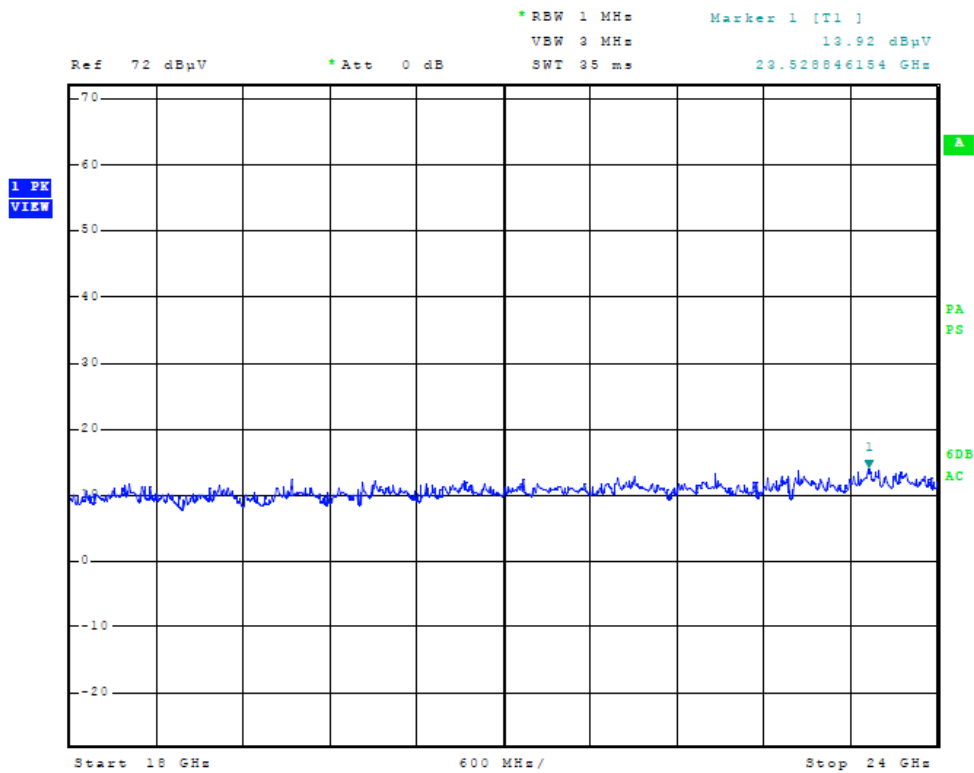


Figure 18 General Radiated Emissions taken at 1 meter in screen room (POE 2)



**General Radiated Emissions from EUT Data (Chip Antenna Emissions)**

Frequency in MHz	Horizontal Peak (dBµV/m)	Horizontal Quasi-Peak (dBµV/m)	Horizontal Average (dBµV/m)	Vertical Peak (dBµV/m)	Vertical Quasi-Peak (dBµV/m)	Vertical Average (dBµV/m)	Limit @ 3m (dBµV/m)
67.9	42.3	35.4	N/A	41.7	35.8	N/A	40.0
75.7	41.3	36.8	N/A	39.1	34.5	N/A	40.0
87.2	40.3	36.9	N/A	38.7	36.5	N/A	40.0
115.2	38.3	33.9	N/A	37.6	32.4	N/A	43.5
115.4	38.1	33.2	N/A	37.0	32.3	N/A	43.5
118.4	37.9	33.1	N/A	36.9	32.5	N/A	43.5
119.0	37.6	33.1	N/A	36.6	32.3	N/A	43.5
123.2	37.8	32.1	N/A	41.0	28.4	N/A	43.5
125.0	43.2	40.1	N/A	37.4	33.8	N/A	43.5
129.5	37.5	32.0	N/A	32.6	27.4	N/A	43.5
131.0	37.7	32.5	N/A	32.5	27.5	N/A	43.5
136.0	37.8	32.3	N/A	31.5	26.2	N/A	43.5
150.6	42.1	37.6	N/A	31.8	26.8	N/A	43.5
154.5	44.6	40.0	N/A	35.3	29.3	N/A	43.5
183.0	44.2	39.6	N/A	32.7	27.4	N/A	43.5
221.1	42.5	37.9	N/A	32.4	27.4	N/A	46.0
250.0	44.6	43.4	N/A	43.8	42.6	N/A	46.0
320.1	47.9	38.2	N/A	30.0	24.0	N/A	46.0
426.7	37.5	36.0	N/A	39.6	37.3	N/A	46.0
500.1	42.8	40.7	N/A	31.8	28.3	N/A	46.0
746.8	35.8	29.7	N/A	33.2	29.8	N/A	46.0
1066.9	57.9	N/A	42.5	48.2	N/A	36.0	54.0

Other emissions present had amplitudes at least 20 dB below the limit.

Quasi-Peak amplitude emissions are recorded above for frequency range of 30-1000 MHz.

Average amplitude emissions are recorded above for frequency range above 1000 MHz.



**General Radiated Emissions from EUT Data (5dBi Dipole Emissions)**

Frequency in MHz	Horizontal Peak (dBµV/m)	Horizontal Quasi-Peak (dBµV/m)	Horizontal Average (dBµV/m)	Vertical Peak (dBµV/m)	Vertical Quasi-Peak (dBµV/m)	Vertical Average (dBµV/m)	Limit @ 3m (dBµV/m)
67.9	42.3	35.3	N/A	41.5	35.8	N/A	40.0
75.7	41.3	36.6	N/A	38.9	34.5	N/A	40.0
87.2	40.3	36.8	N/A	38.7	36.2	N/A	40.0
115.2	38.3	33.8	N/A	37.4	32.4	N/A	43.5
115.4	38.1	33.3	N/A	36.9	32.3	N/A	43.5
118.4	37.9	33.2	N/A	36.8	32.5	N/A	43.5
119.0	37.6	33.2	N/A	36.4	32.3	N/A	43.5
123.2	37.8	32.0	N/A	40.9	28.4	N/A	43.5
125.0	43.2	39.8	N/A	37.0	33.8	N/A	43.5
129.5	37.5	31.9	N/A	32.4	27.4	N/A	43.5
131.0	37.7	31.9	N/A	32.3	27.5	N/A	43.5
136.0	37.8	32.1	N/A	31.0	26.2	N/A	43.5
150.6	42.1	37.2	N/A	31.6	26.8	N/A	43.5
154.5	44.6	39.7	N/A	35.0	29.3	N/A	43.5
183.0	44.2	39.5	N/A	32.5	27.4	N/A	43.5
221.1	42.5	37.7	N/A	32.3	27.4	N/A	46.0
250.0	44.6	43.3	N/A	43.8	42.4	N/A	46.0
320.1	47.9	38.2	N/A	30.0	24.7	N/A	46.0
426.7	37.5	36.1	N/A	39.6	36.5	N/A	46.0
500.1	42.8	40.6	N/A	31.8	28.1	N/A	46.0
746.8	35.8	29.8	N/A	33.2	29.5	N/A	46.0
1066.9	57.9	N/A	42.3	48.2	N/A	35.9	54.0

Other emissions present had amplitudes at least 20 dB below the limit.

Quasi-Peak amplitude emissions are recorded above for frequency range of 30-1000 MHz.

Average amplitude emissions are recorded above for frequency range above 1000 MHz.

**Summary of Results for General Radiated Emissions**

The EUT demonstrated compliance with the radiated emissions requirements of CFR47 Part 15C paragraph 15.209 Intentional Radiators. The EUT demonstrated a minimum margin of -2.6 dB below the requirements. Other emissions were present with amplitudes at least 20 dB below the Limits. Note: peak amplitudes measured for 1596.9 MHz – horizontal 36.4, vertical 34.2 dBμV.

**Operation in the Frequency Band of 2400 – 2483.5 MHz**

The power output and emissions were measured at the antenna port and on the OATS range in compliance with regulation. The equipment utilizes the internal antenna and external u.fl antenna connection ports for either transmit or receive. The EUT and test configurations were placed on a wooden turntable 0.8 meters above the ground plane at a distance of 3 meters from the FSM antenna. The peak and quasi-peak amplitude of the frequencies below 1000 MHz were measured using a spectrum analyzer. The peak and average amplitude of emissions above 1000 MHz including were measured using a spectrum analyzer. Data was recorded from the analyzer measurement result. . Antennas used for radiated emissions testing were Broadband Biconical from 30 to 200 MHz, Biconilog from 30 to 1000 MHz, Log Periodic from 200 MHz to 1 GHz and or double Ridge or pyramidal horns and mixers from 1 GHz to 60 GHz, notch filters, and appropriate amplifiers and external mixers were utilized. Plots were made of transmitter antenna port conducted performance taken in a screen room. Refer to figures nineteen through fifty-four showing plots of the EUT emissions performance displaying compliance with the specifications.

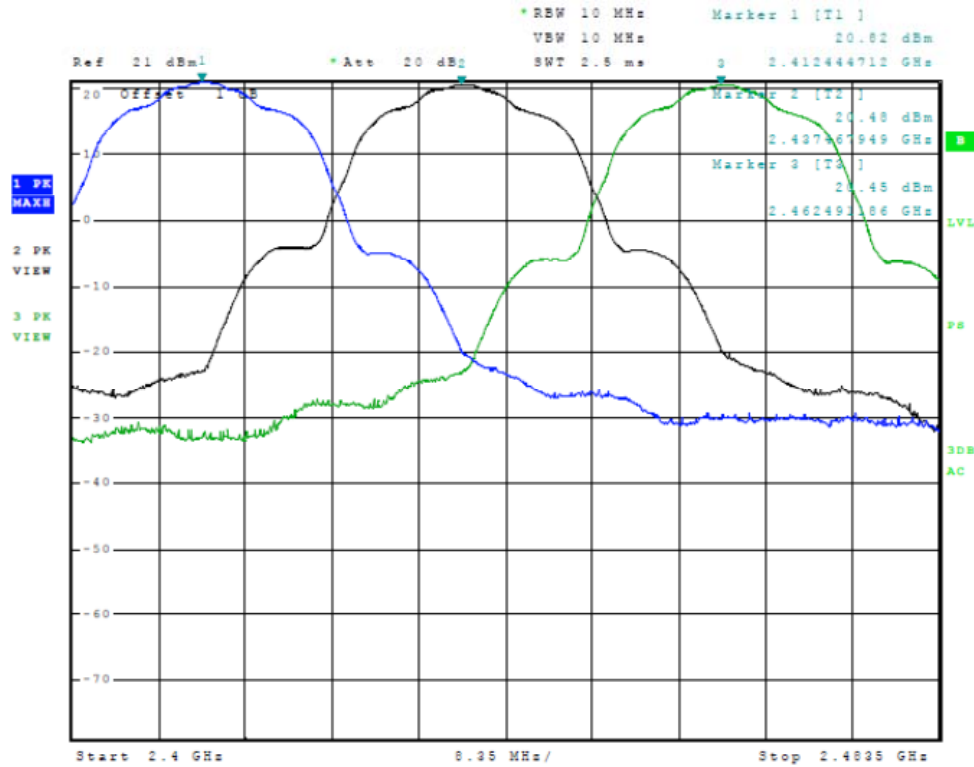


Figure 19 Plot of Antenna Port Emissions (Across Operational Band, 20MHz CCK Mode)

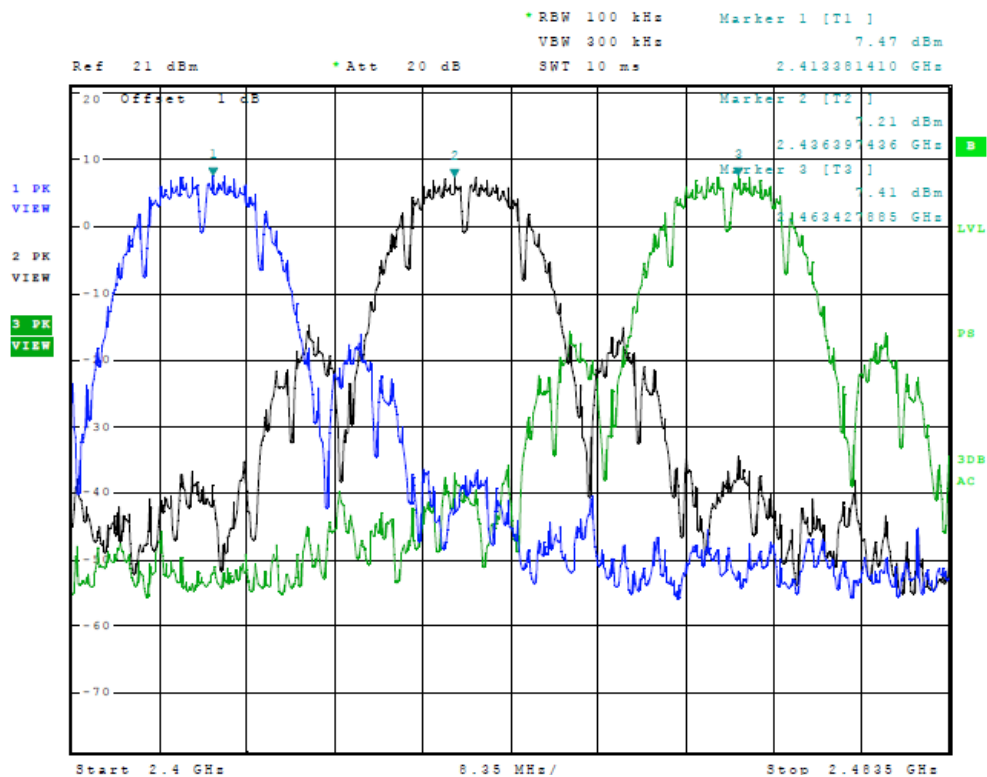


Figure 20 Plot of Antenna Port Emissions (Across Operational Band, 20MHz CCK Mode)

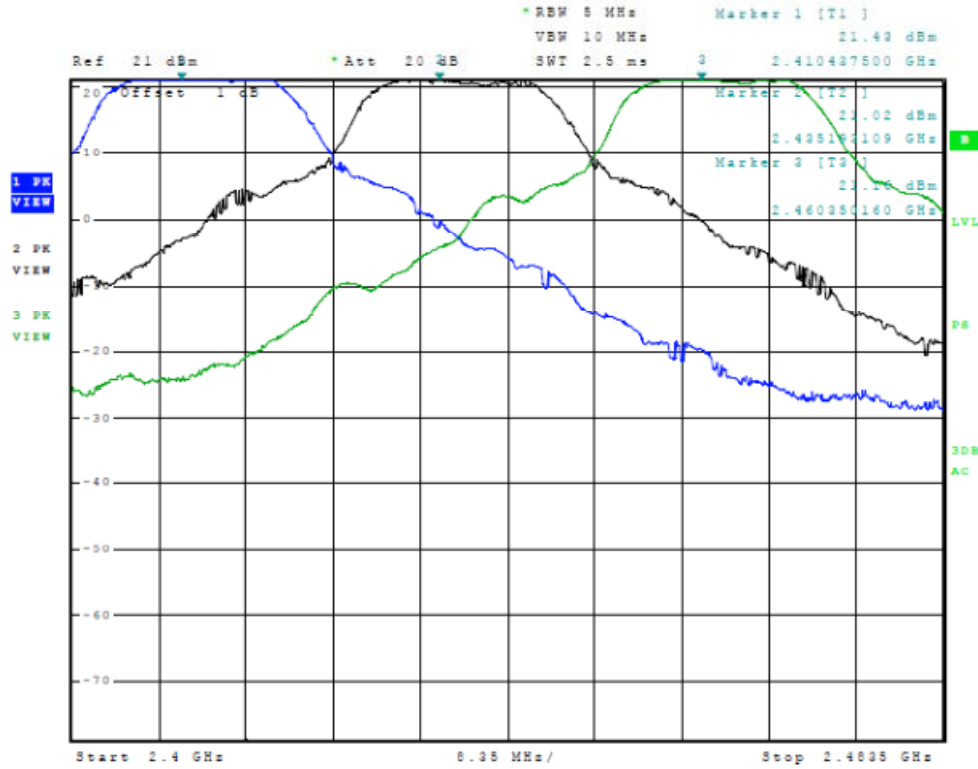


Figure 21 Plot of Antenna Port Emissions (Across Operational Band, 20MHz OFDM Mode)

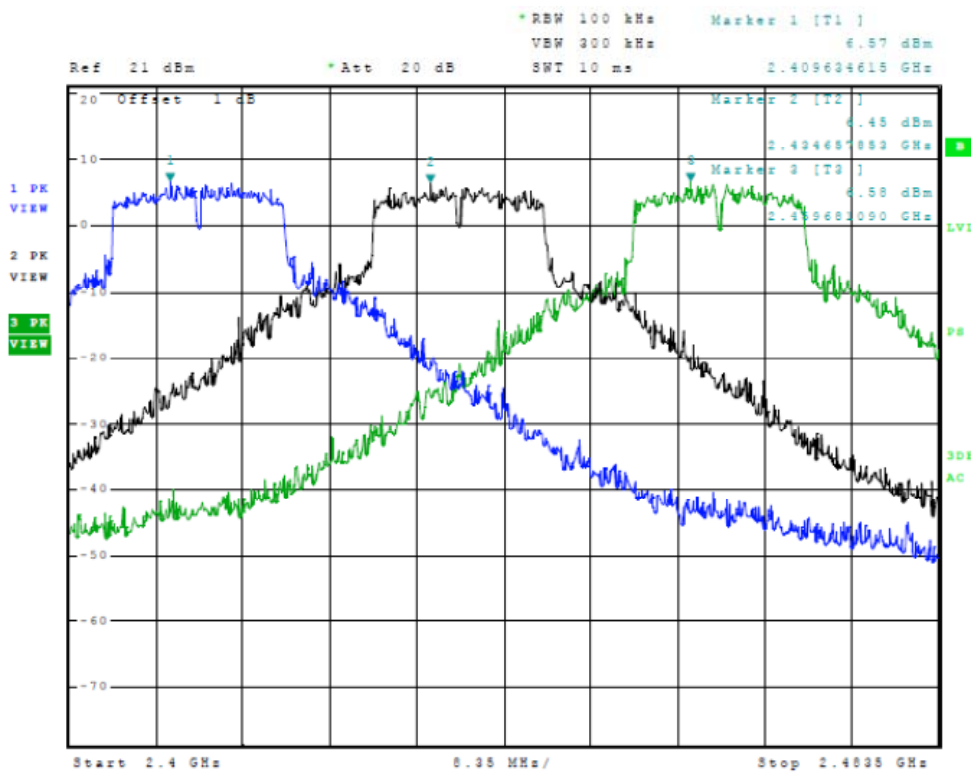


Figure 22 Plot of Antenna Port Emissions (Across Operational Band, 20MHz OFDM Mode)



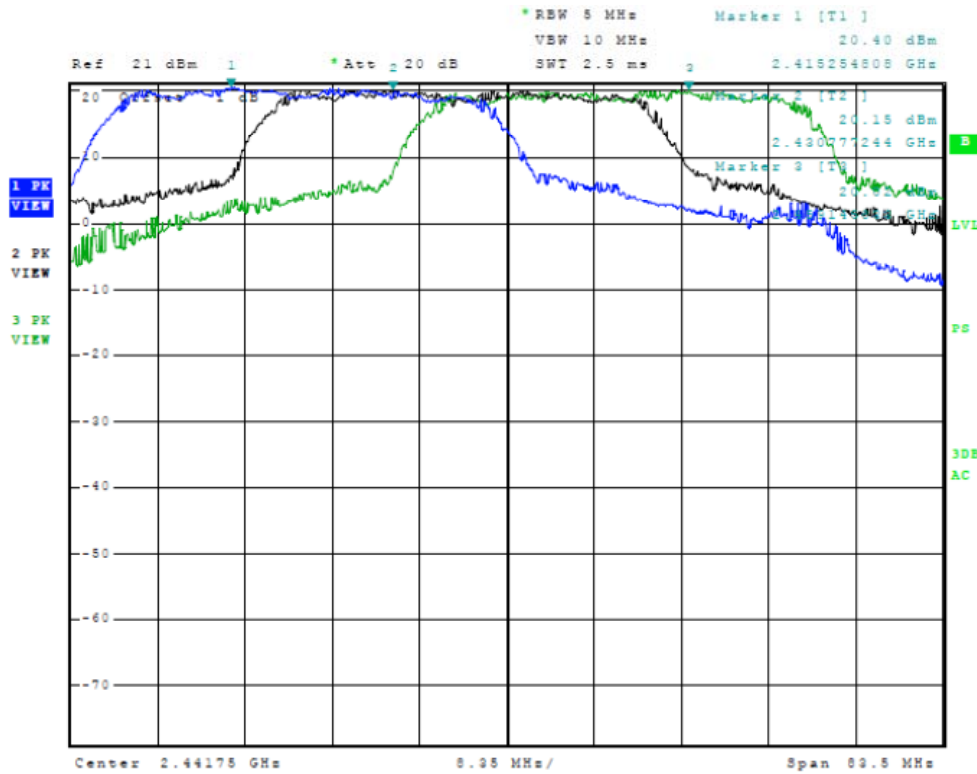


Figure 23 Plot of Antenna Port Emissions (Across Operational Band, 40MHz Mode)

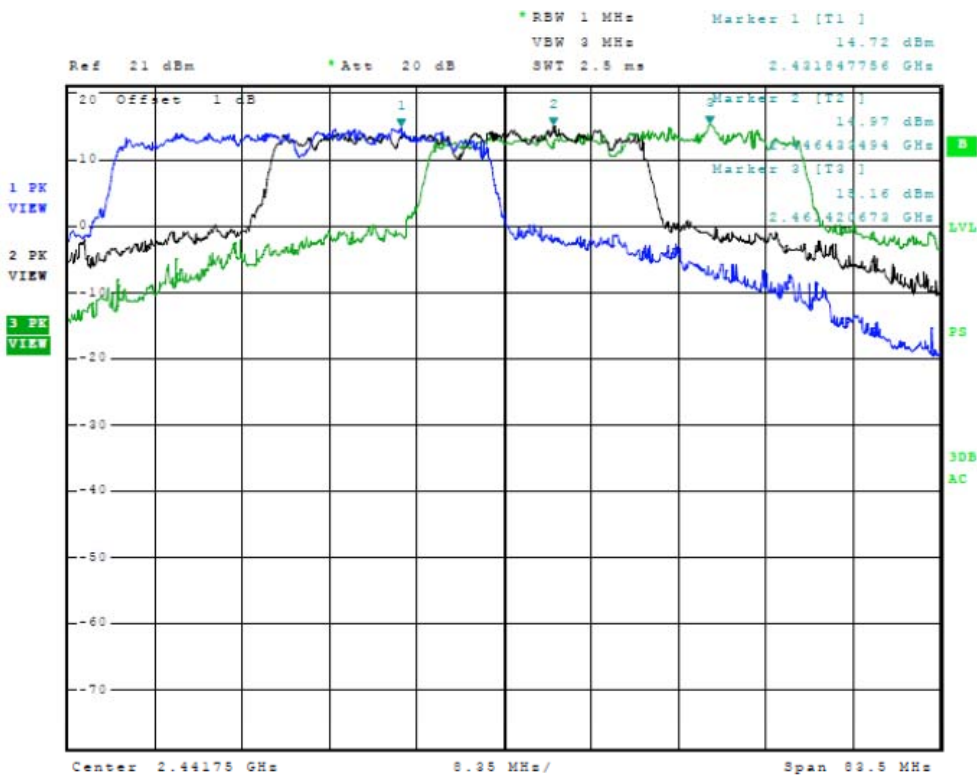
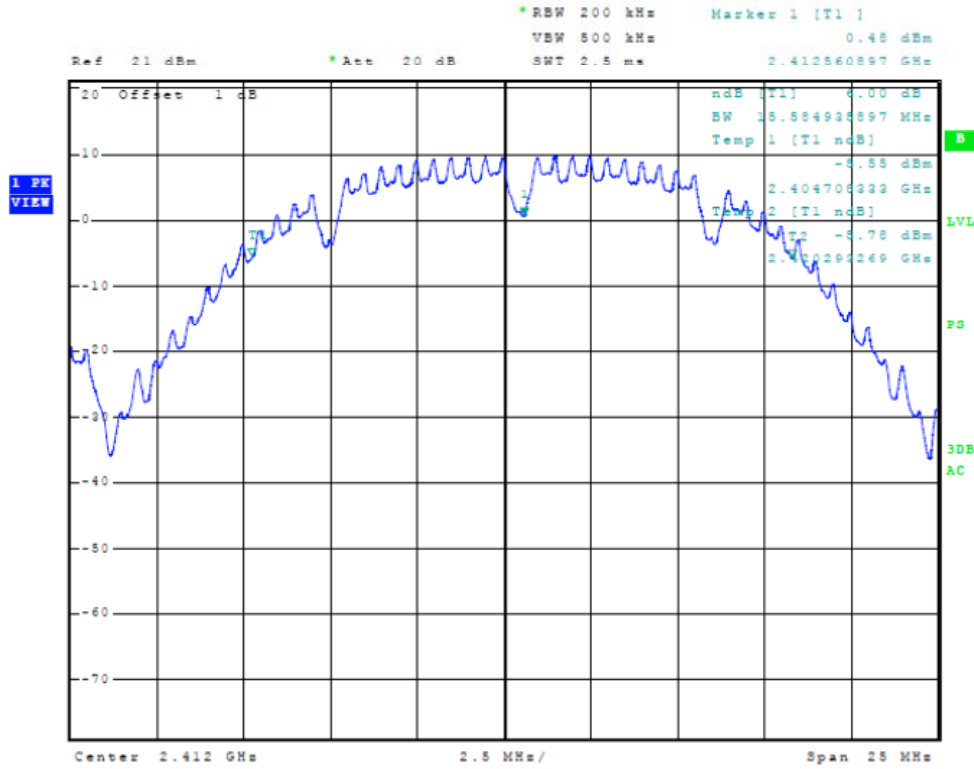
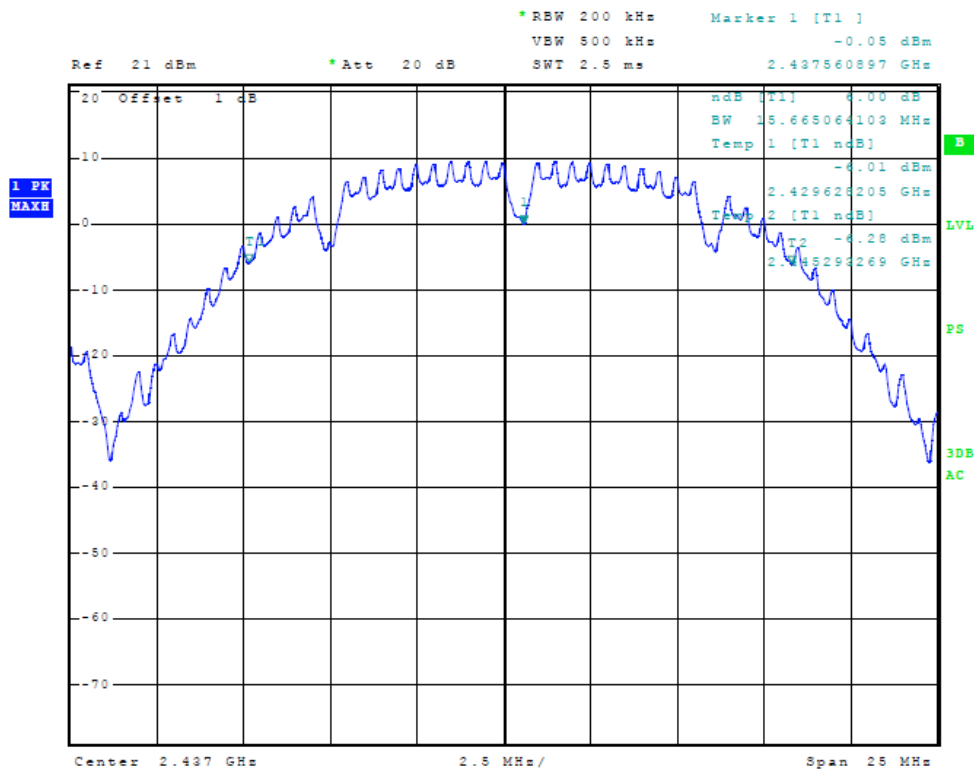


Figure 24 Plot of Antenna Port Emissions (Across Operational Band, 40MHz Mode)



**Figure 25 Plot of 6dB Band width (20 MHz Mode, CCK 2412 MHz)**



**Figure 26 Plot of 6dB Band width (20 MHz Mode, CCK 2437 MHz)**

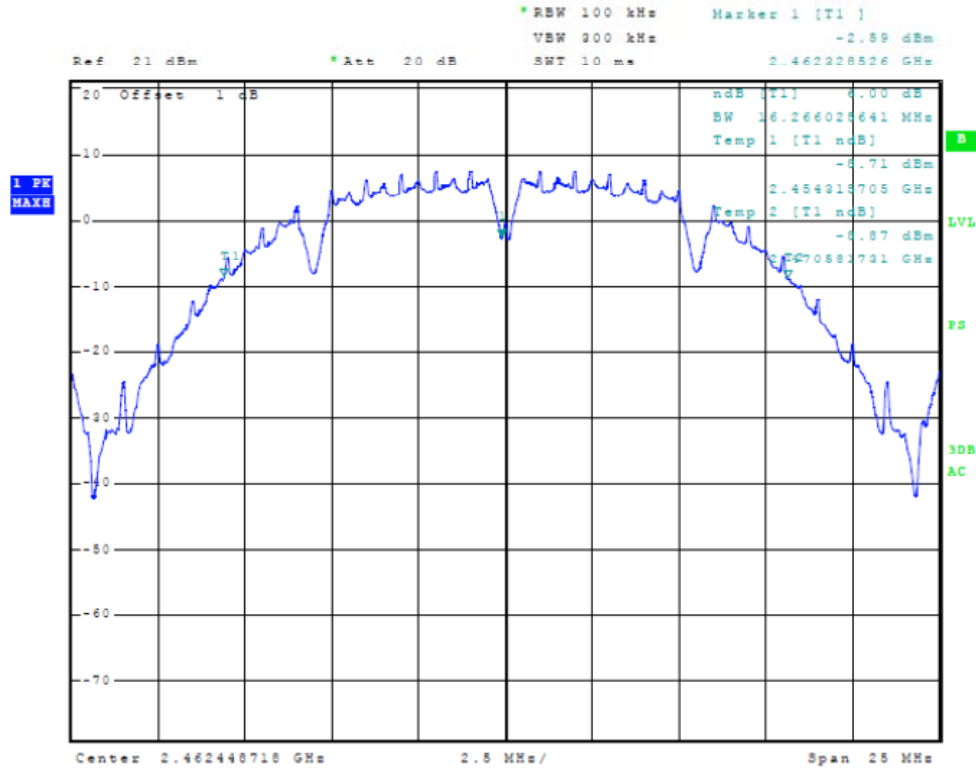


Figure 27 Plot of 6dB Band width (20 MHz Mode, CCK 2462 MHz)

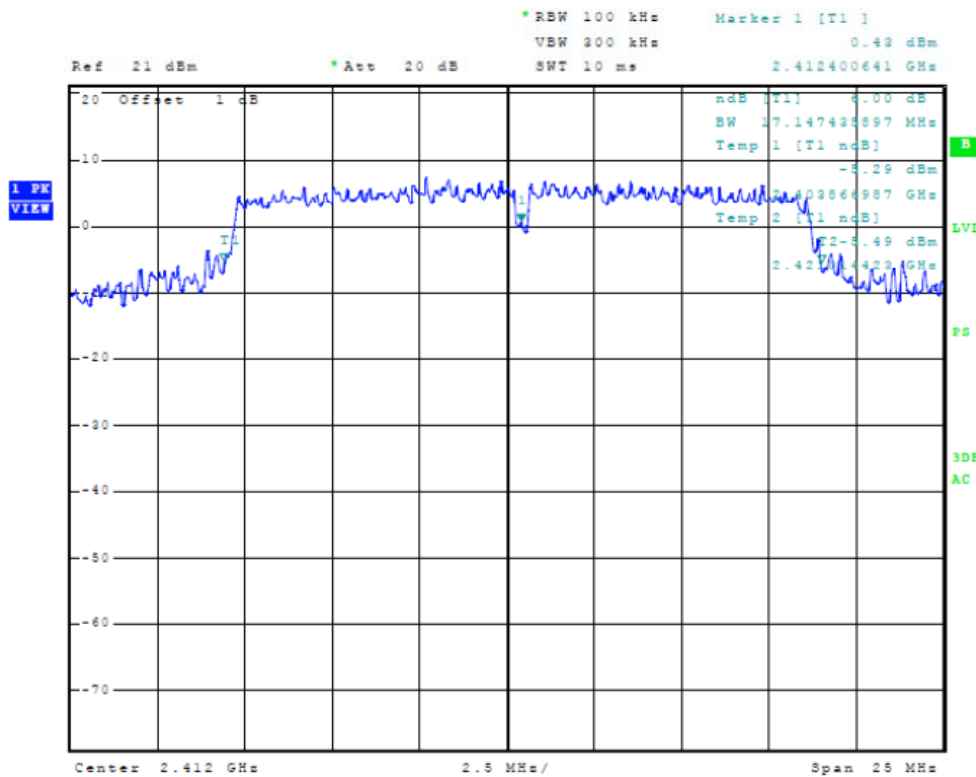


Figure 28 Plot of 6dB Band width (20 MHz Mode, OFDM 2412 MHz)

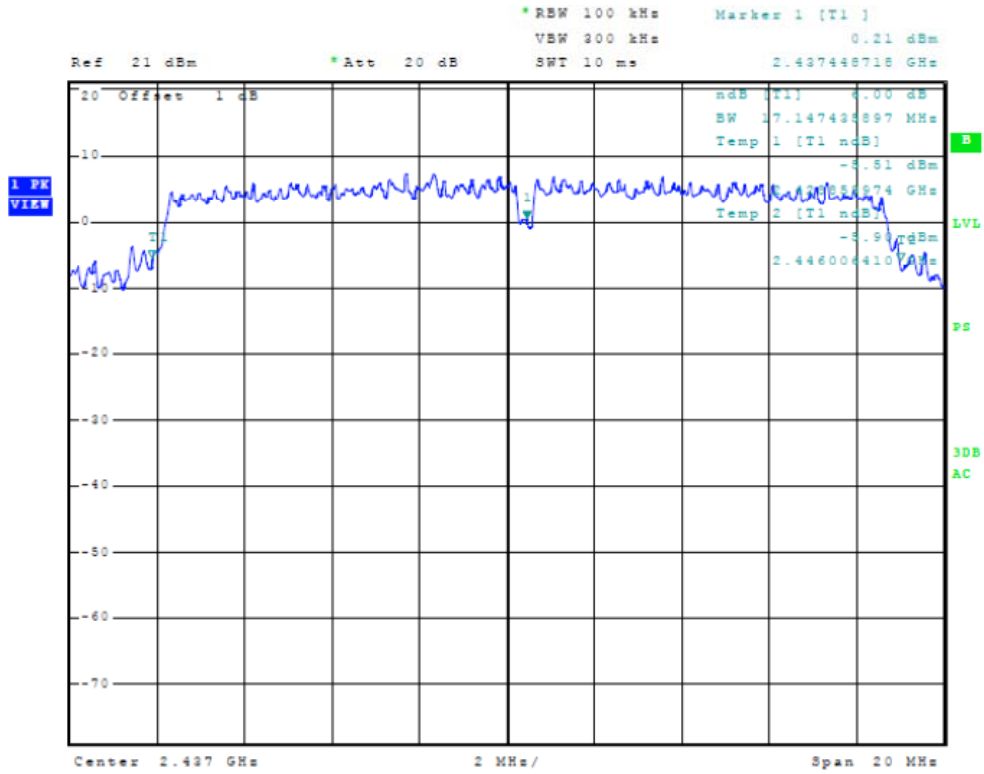


Figure 29 Plot of 6dB Band width (20 MHz Mode, OFDM 2437 MHz)

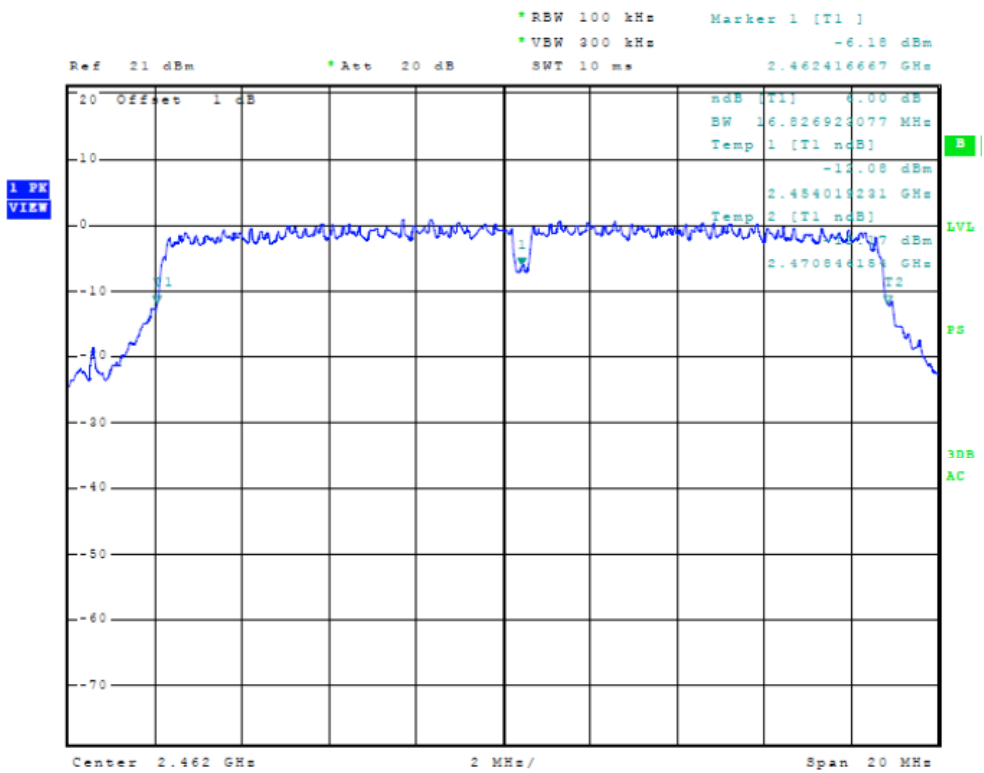


Figure 30 Plot of 6dB Band width (20 MHz Mode, OFDM 2462 MHz)

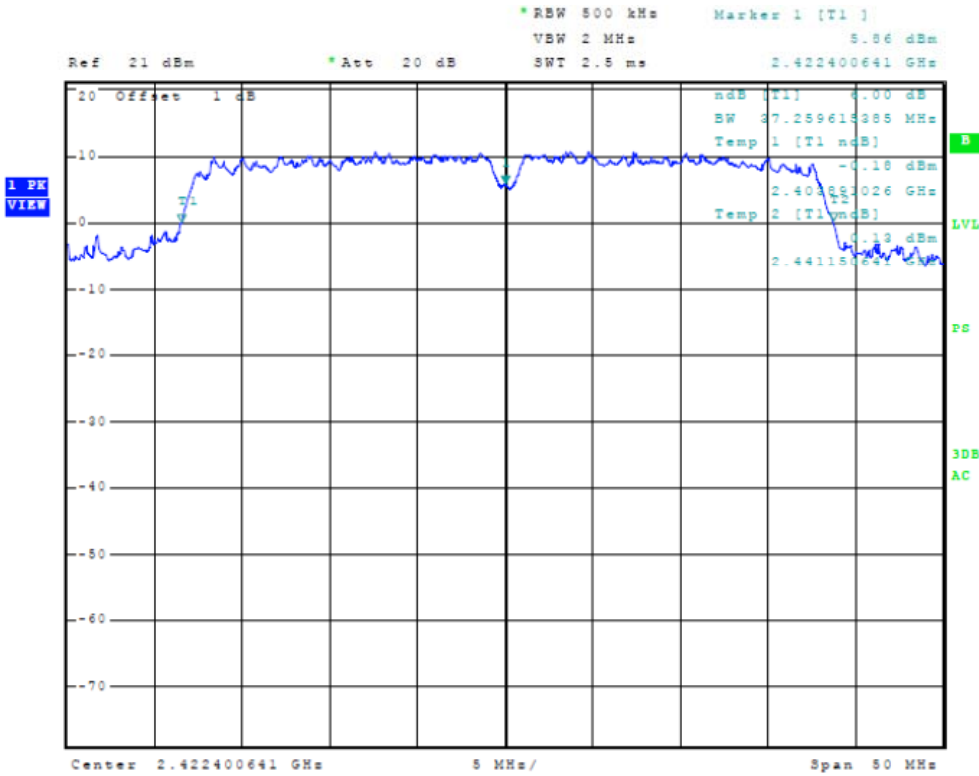


Figure 31 Plot of 6dB Band width (40 MHz Mode, 2422 MHz)

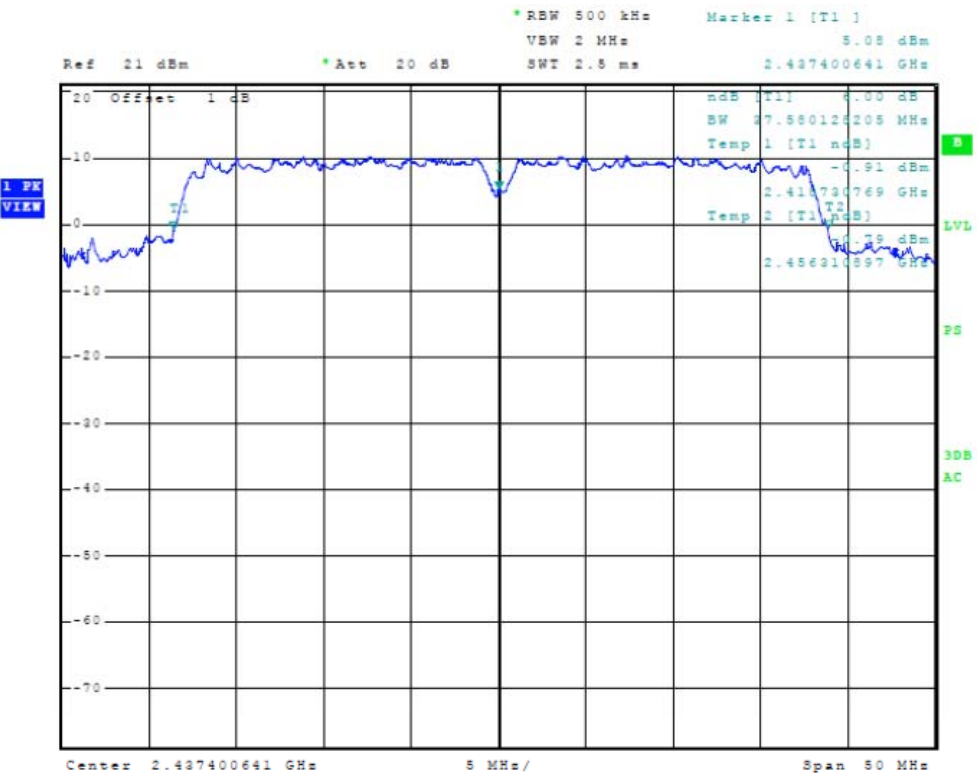


Figure 32 Plot of 6dB Band width (40 MHz Mode, 2437 MHz)

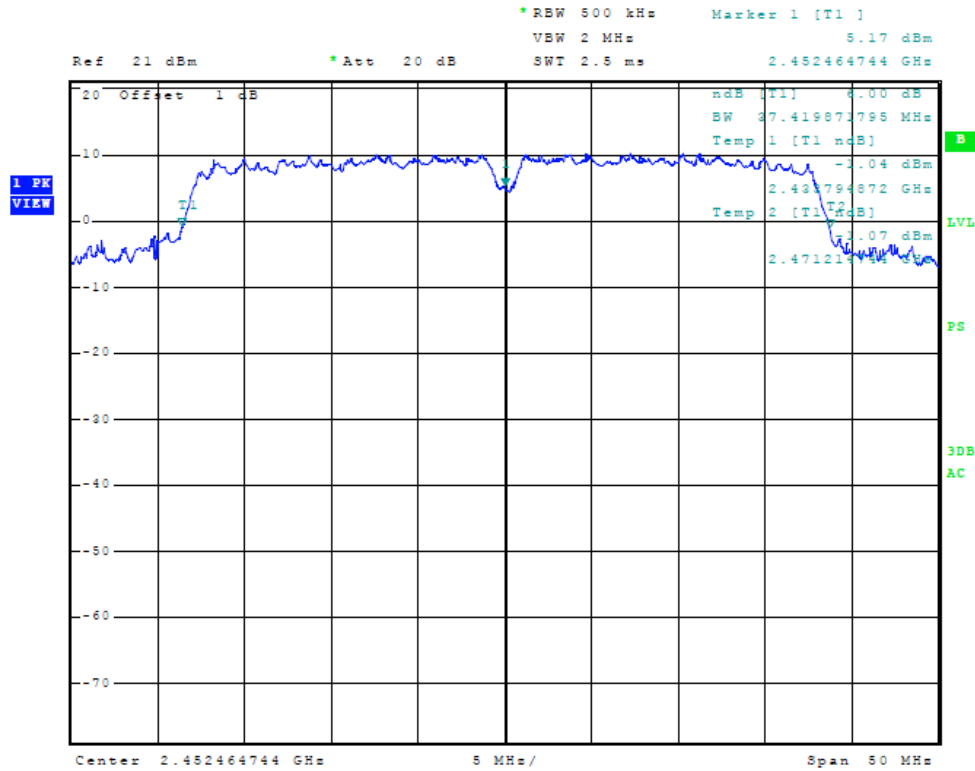


Figure 33 Plot of 6dB Band width (40 MHz Mode, 2452 MHz)

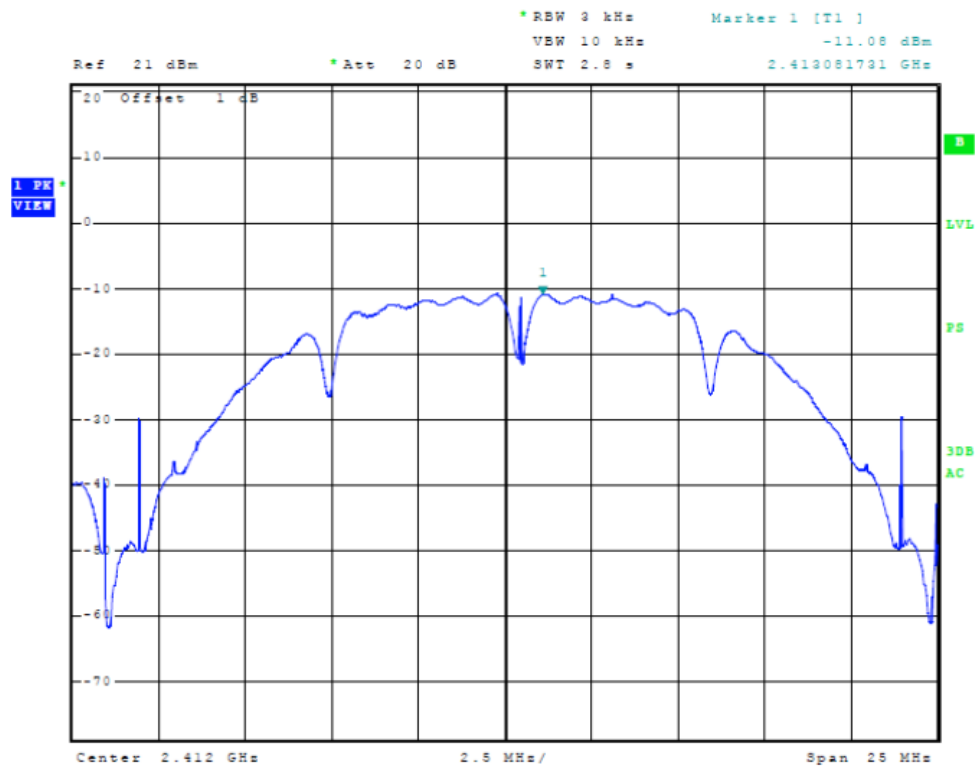
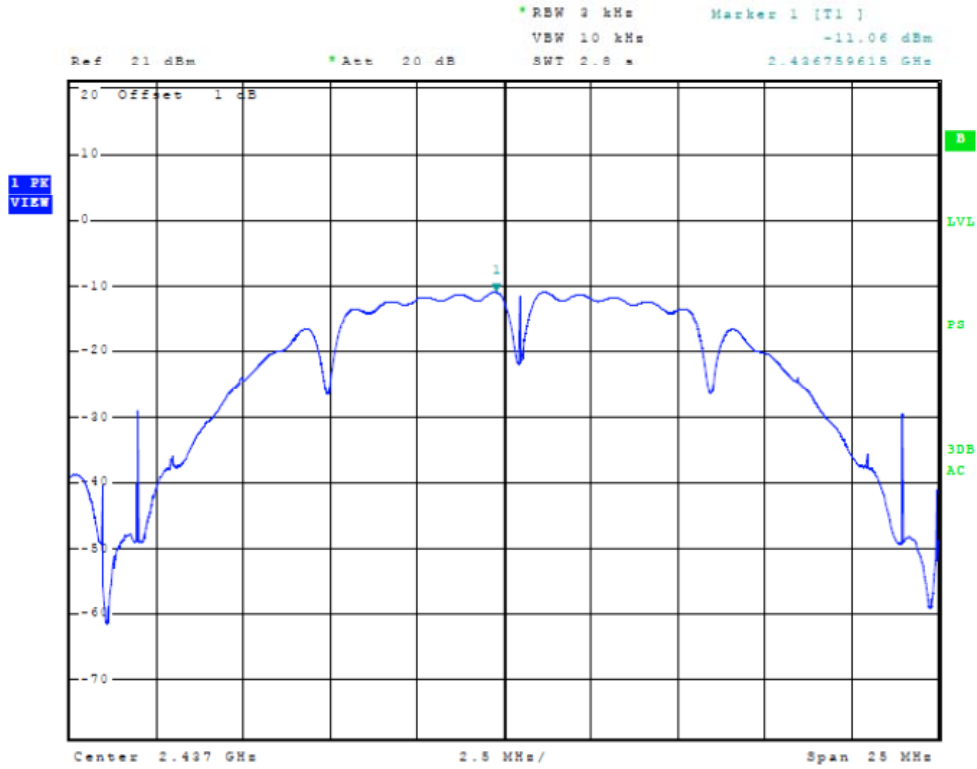
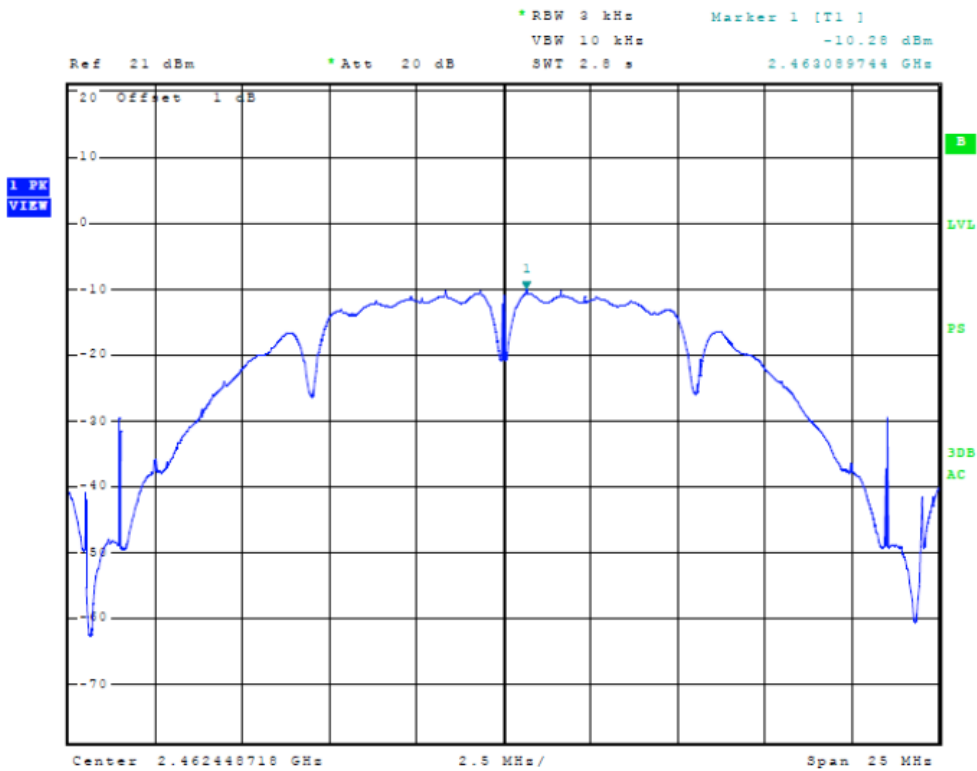


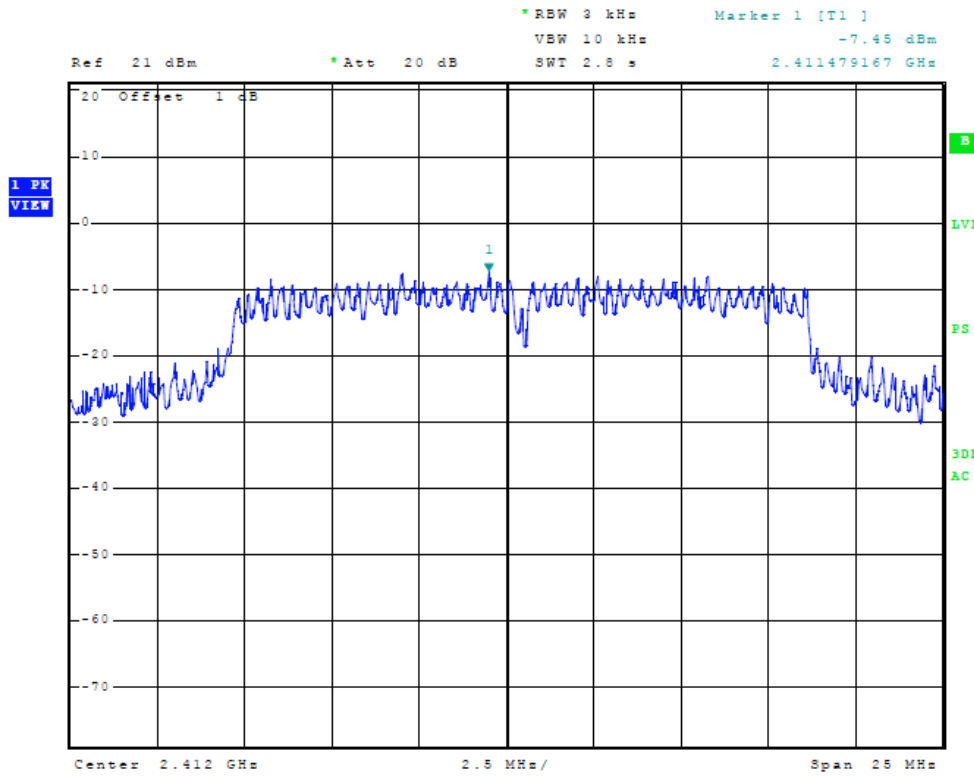
Figure 34 Plot of Power Spectral Density (20 MHz Mode, CCK 2412 MHz)



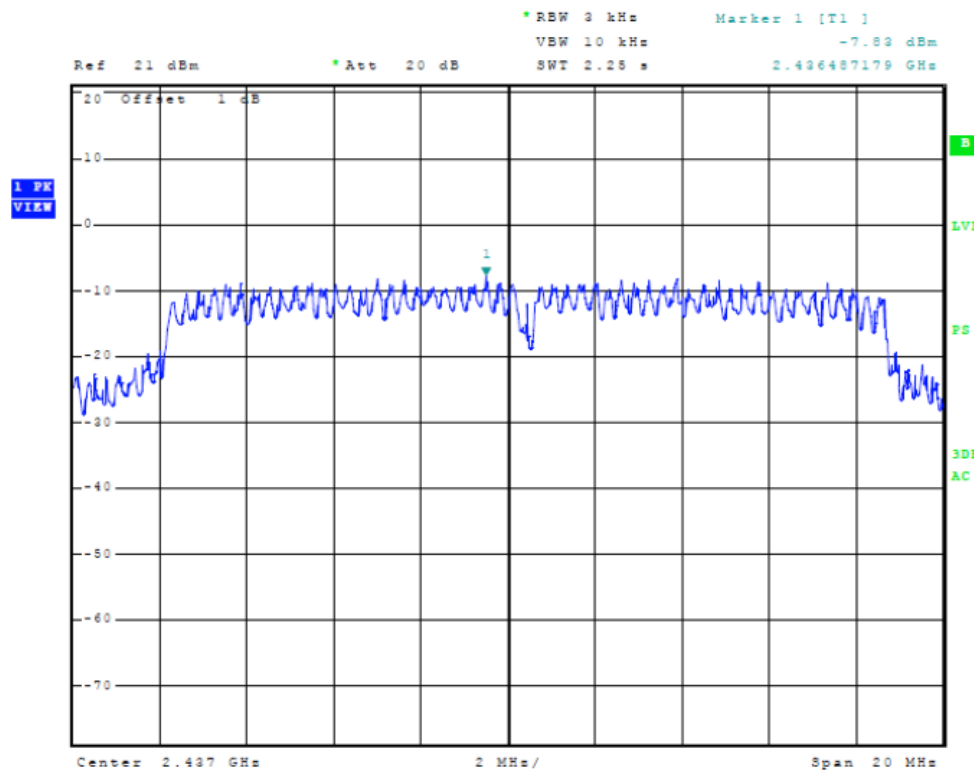
**Figure 35 Plot of Power Spectral Density (20 MHz Mode, CCK 2437 MHz)**



**Figure 36 Plot of Power Spectral Density (20 MHz Mode, CCK 2462 MHz)**

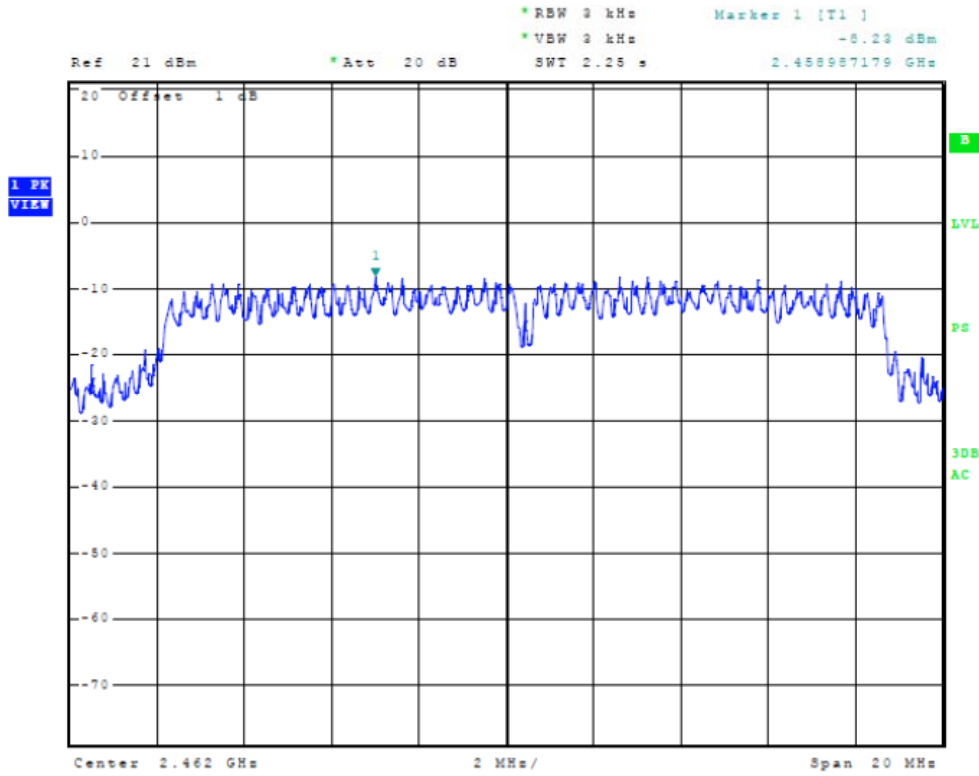


**Figure 37 Plot of Power Spectral Density (20 MHz Mode, OFDM 2412 MHz)**

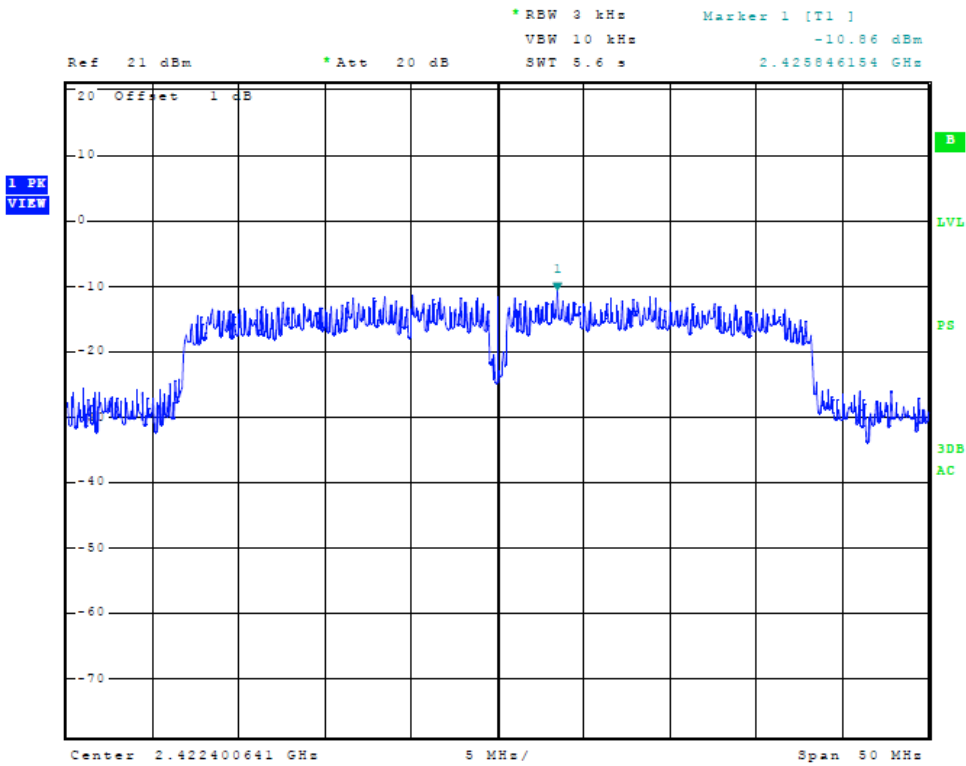


**Figure 38 Plot of Power Spectral Density (20 MHz Mode, OFDM 2437 MHz)**

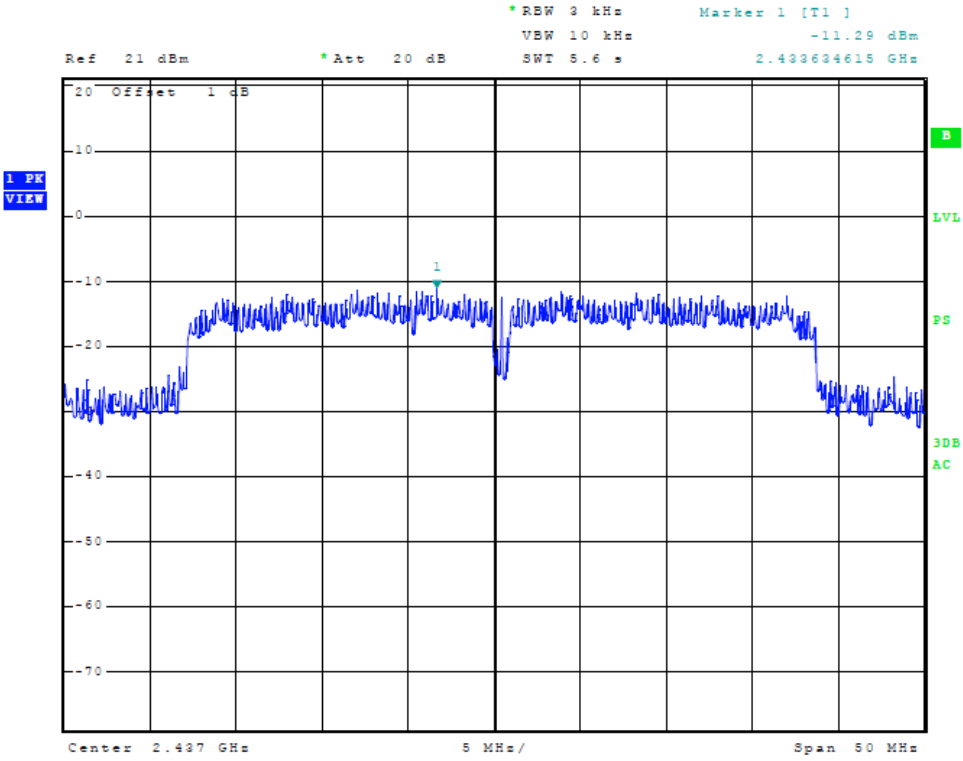




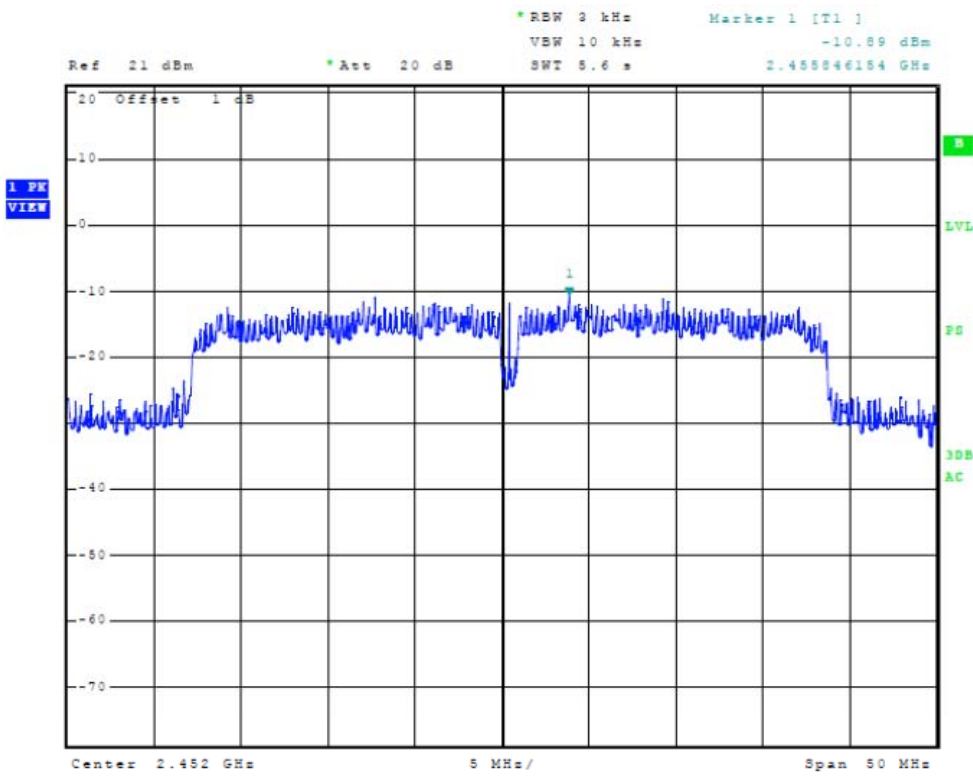
**Figure 39 Plot of Power Spectral Density (20 MHz Mode, OFDM 2462 MHz)**



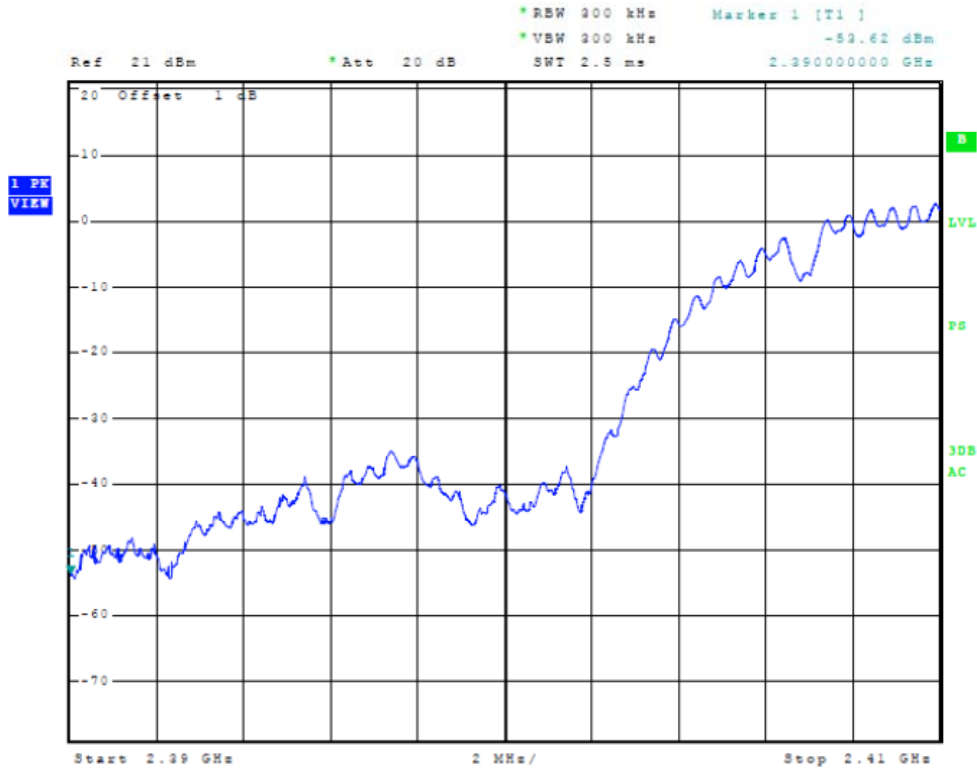
**Figure 40 Plot of Power Spectral Density (40 MHz Mode, 2422 MHz)**



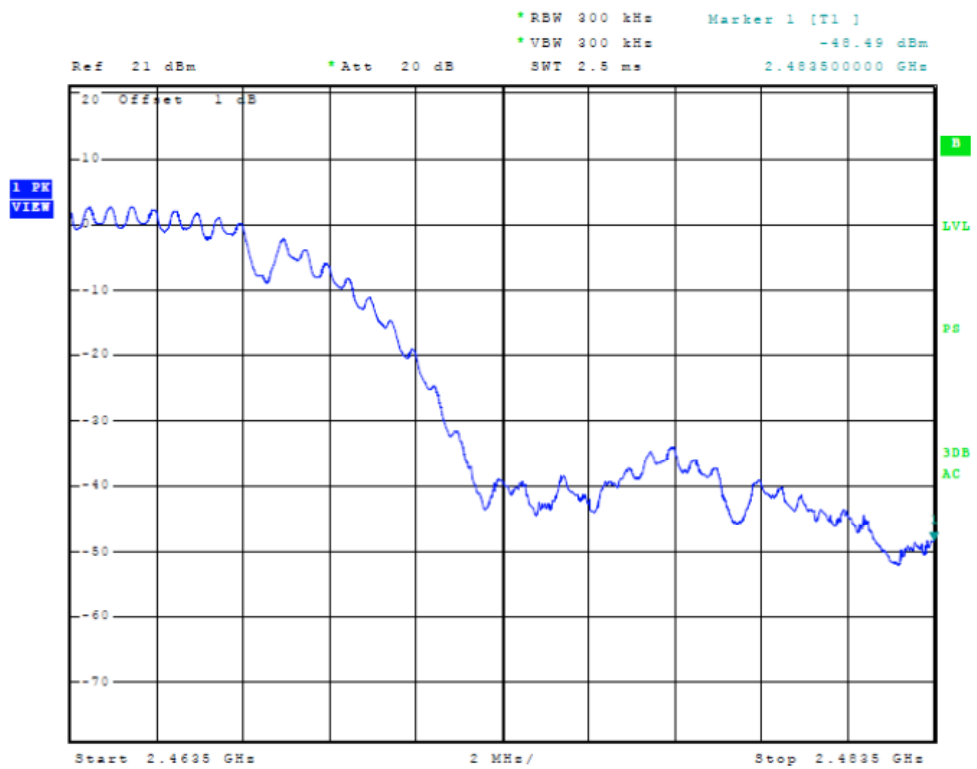
**Figure 41 Plot of Power Spectral Density (40 MHz Mode, 2437 MHz)**



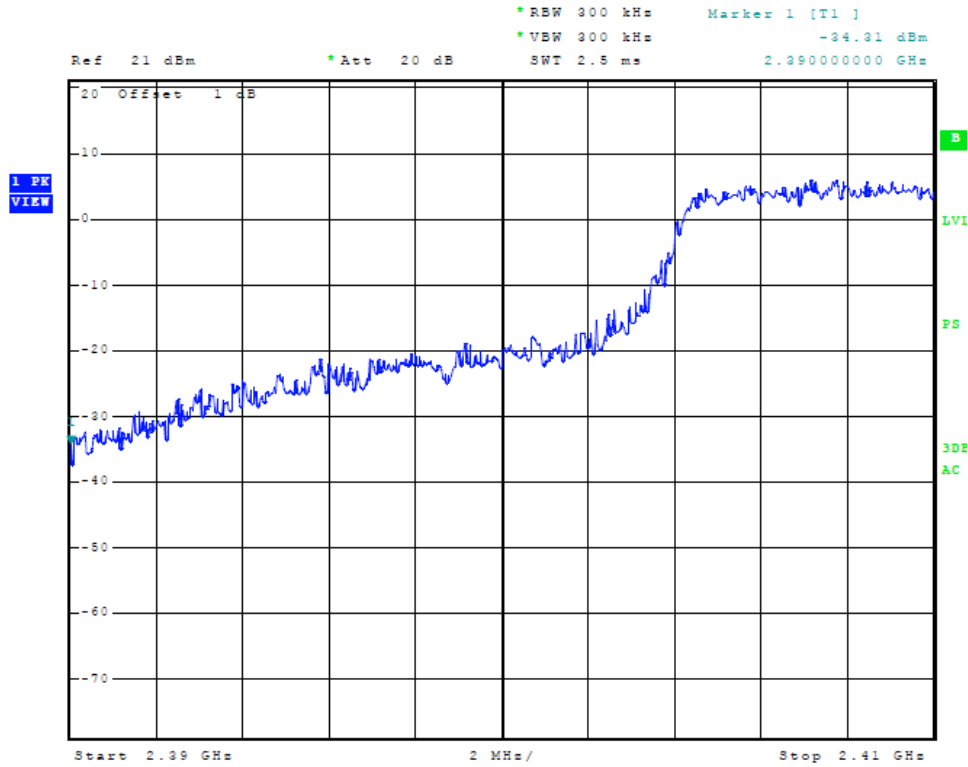
**Figure 42 Plot of Power Spectral Density (40 MHz Mode, 2452 MHz)**



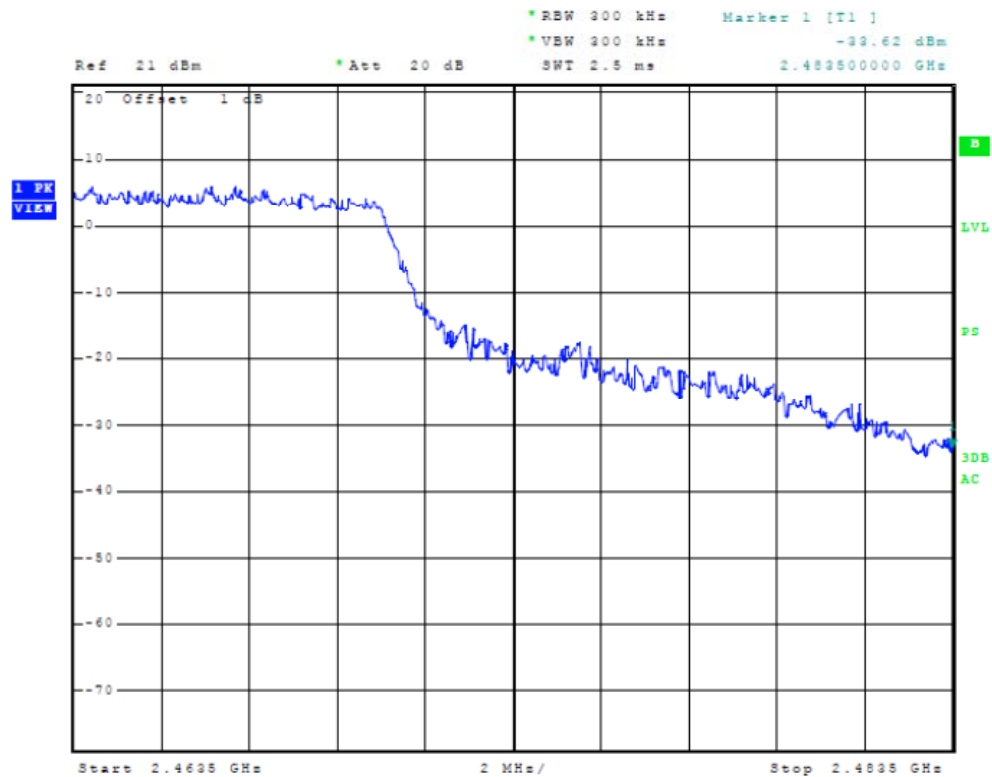
**Figure 43 Plot of Band Edge Compliance at Antenna port (20 CCK MHz)**



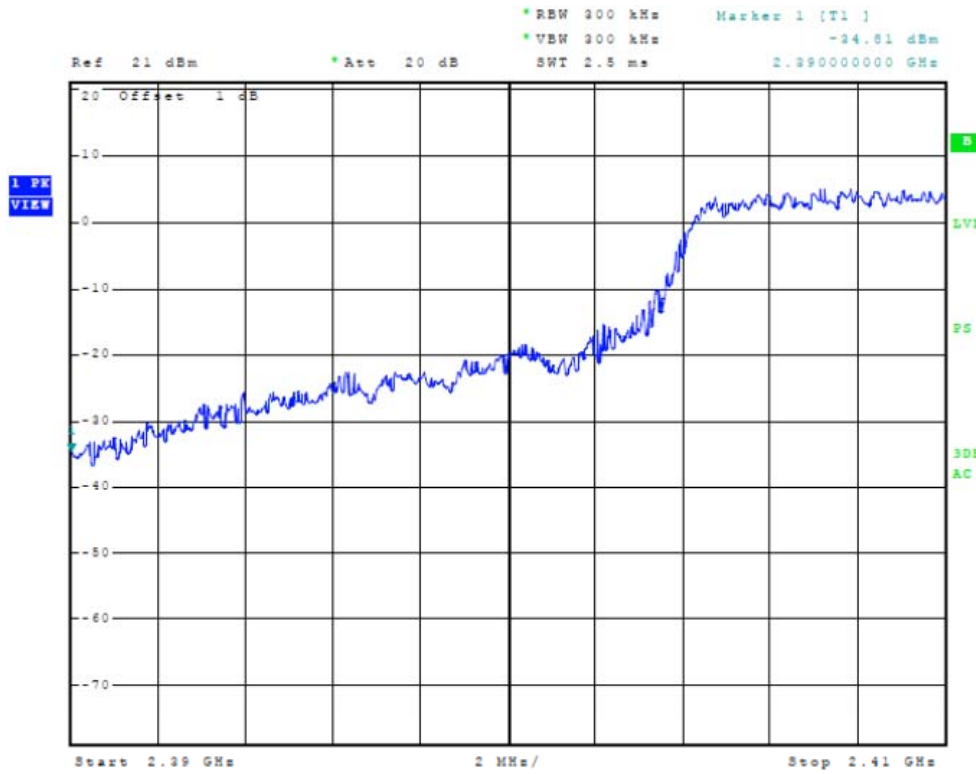
**Figure 44 Plot of Band Edge Compliance at Antenna port (20 CCK MHz)**



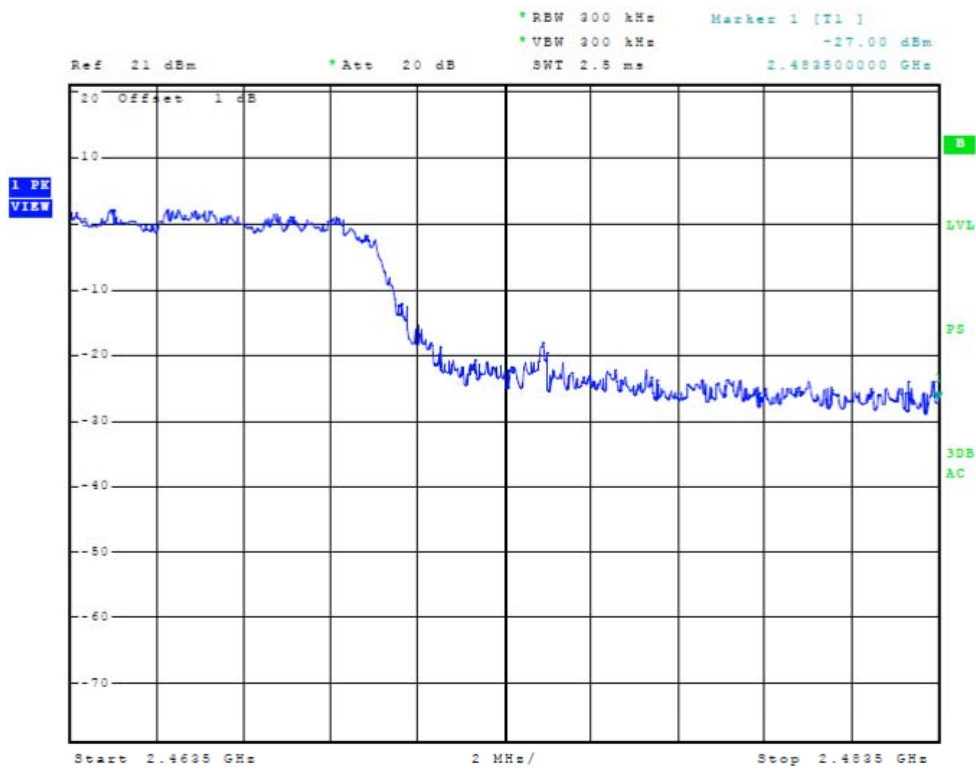
**Figure 45 Plot of Band Edge Compliance at Antenna port (20 OFDM MHz)**



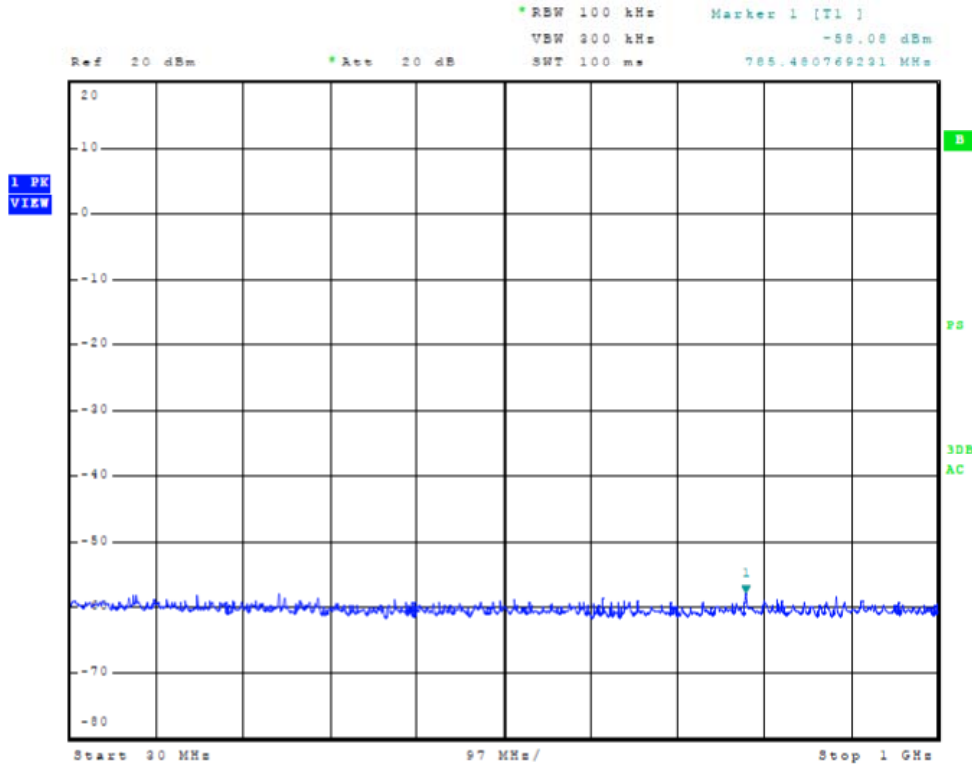
**Figure 46 Plot of Band Edge Compliance at Antenna port (20 OFDM MHz)**



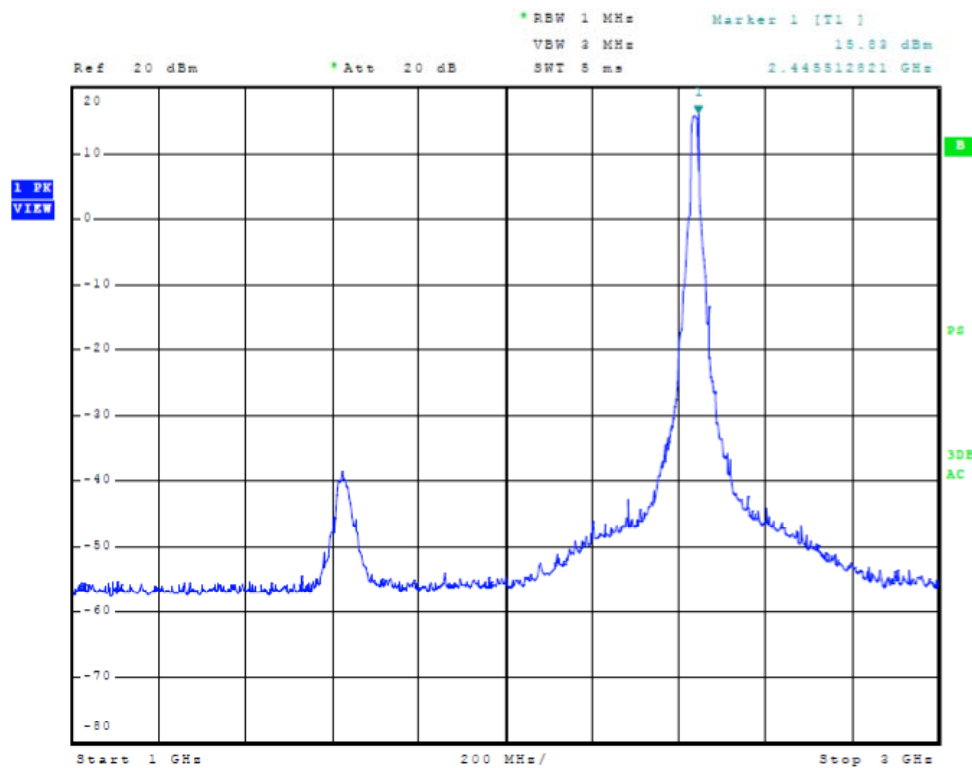
**Figure 47 Plot of Band Edge Compliance at Antenna port (40 MHz)**



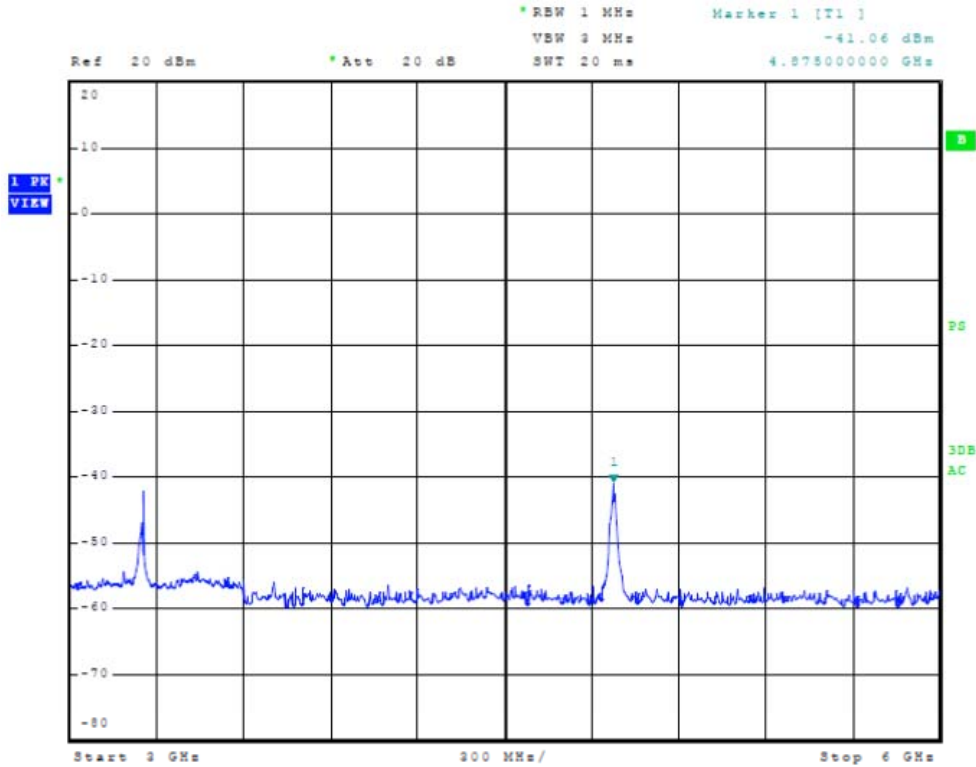
**Figure 48 Plot of Band Edge Compliance at Antenna port (40 MHz)**



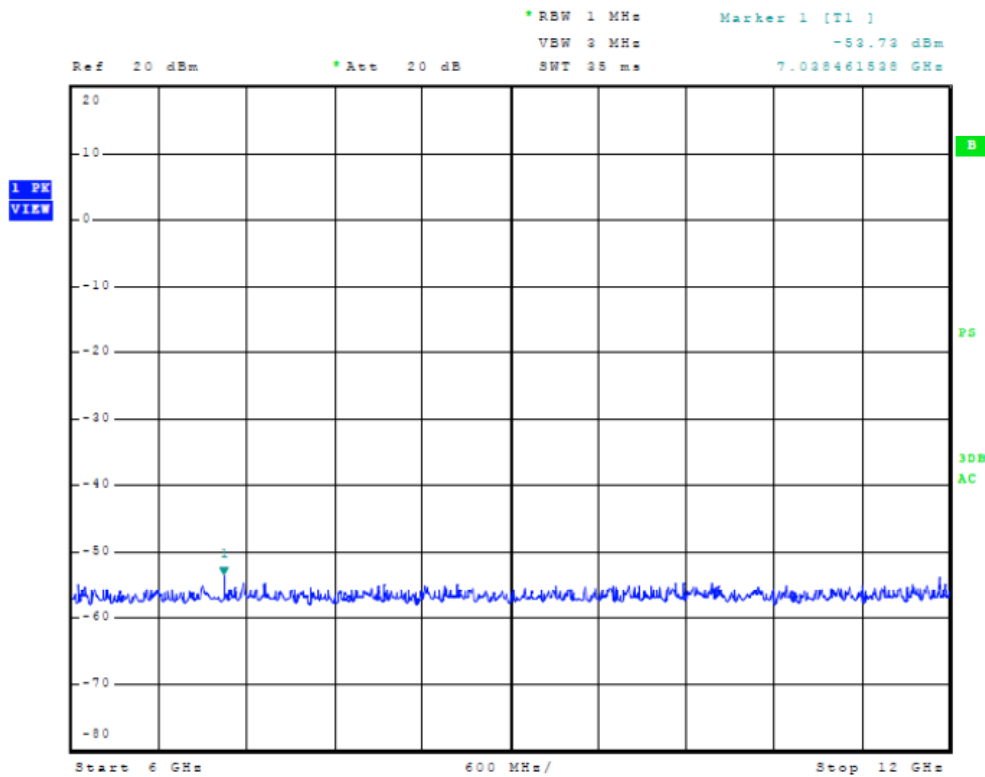
**Figure 49 Plot of Antenna port conducted emissions**



**Figure 50 Plot of Antenna port conducted emissions**



**Figure 51 Plot of Antenna port conducted emissions**



**Figure 52 Plot of Antenna port conducted emissions**

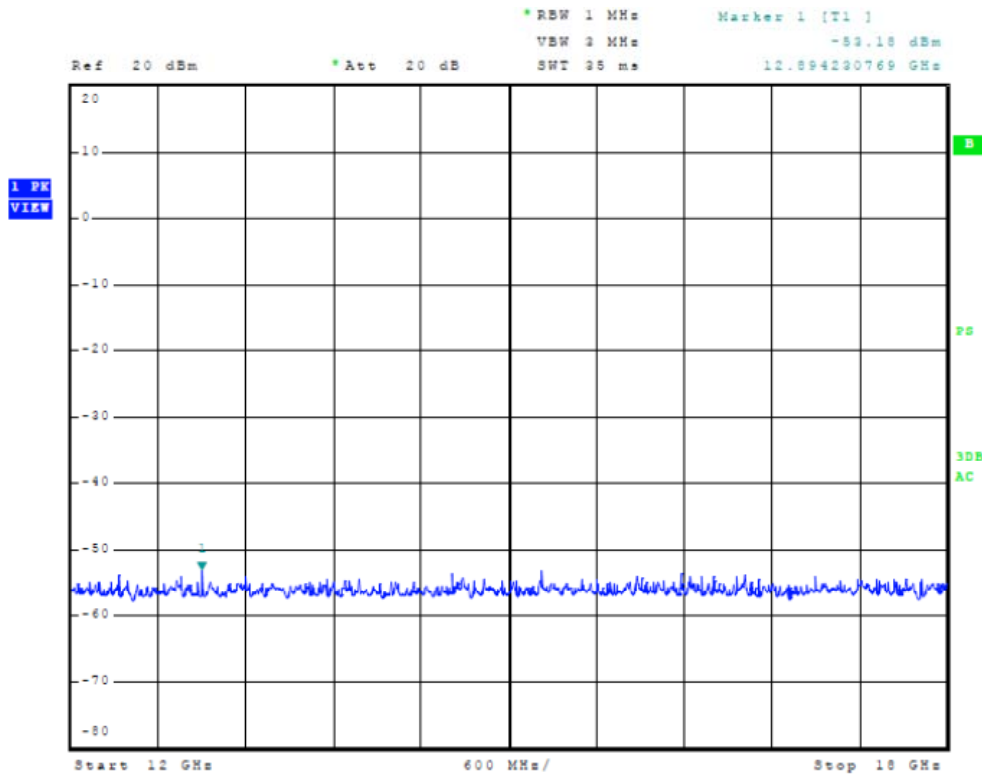


Figure 53 Plot of Antenna port conducted emissions

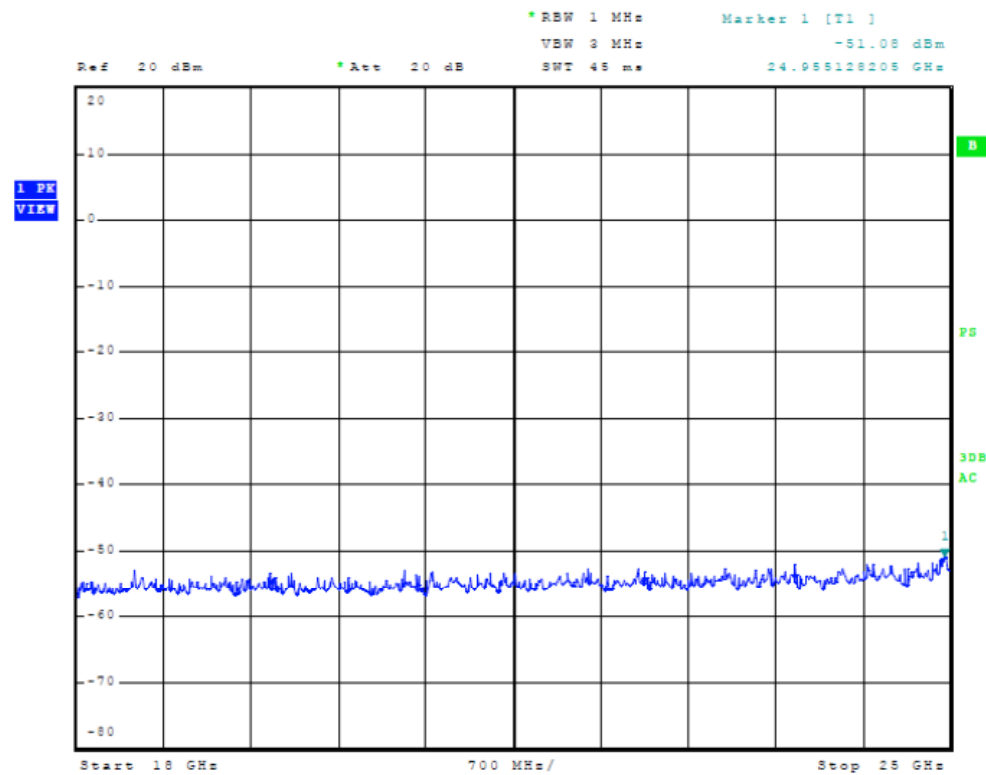


Figure 54 Plot of Antenna port conducted emissions





**Transmitter Emissions Data**

**Transmitter Antenna Port Conducted Emissions Data Summary**

Frequency MHz	Antenna Conducted Output Power dBm	Occupied Bandwidth kHz	Power Spectral Density dBm
20 MHz CCK			
2412.0	21.40	15,584.9	-11.08
2437.0	21.02	15,665.1	-11.06
2462.0	21.11	16,266.0	-10.28
20 MHz OFDM			
2412.0	21.43	17,147.4	-7.45
2437.0	21.02	17,147.4	-7.83
2462.0	21.16	16,826.9	-8.23
40MHz Mode			
2422.0	20.40	37,259.6	-10.86
2437.0	20.15	37,580.1	-11.29
2452.0	20.02	37,419.9	-10.89

**Transmitter Antenna Port Conducted Harmonic Emissions Data (20 MHz Channel)**

Channel MHz	Spurious Freq (MHz)	Measured Level (dBm)	Level Below Carrier (dB)
2412.0	4824.0	-39.01	-59.4
	7236.0	-56.32	-76.7
	9648.0	-54.10	-74.5
	12060.0	-57.71	-78.1
	14472.0	-57.79	-78.2
2437.0	4874.0	-38.09	-58.2
	7311.0	-56.38	-76.5
	9748.0	-55.12	-75.3
	12185.0	-57.65	-77.8
	14622.0	-57.79	-77.9
2462.0	4924.0	-38.01	-58.0
	7386.0	-55.42	-75.4
	9848.0	-53.06	-73.1
	12310.0	-57.41	-77.4
	14772.0	-55.97	-76.0

**Transmitter Antenna Port Conducted Harmonic Emissions Data (40 MHz Channel)**

Channel MHz	Spurious Freq (MHz)	Measured Level (dBm)	Level Below Carrier (dB)
2422.0	4844.0	-50.95	-71.4
	7266.0	-57.49	-77.9
	9688.0	-57.34	-77.7
	12110.0	-57.71	-78.1
	14532.0	-57.11	-77.5
2437.0	4874.0	-50.76	-70.9
	7311.0	-57.06	-77.2
	9748.0	-56.62	-76.8
	12185.0	-57.60	-77.8
	14622.0	-57.38	-77.5
2452.0	4904.0	-50.86	-70.9
	7356.0	-57.19	-77.2
	9808.0	-58.07	-78.1
	12260.0	-57.11	-77.1
	14712.0	-56.22	-76.2

**Transmitter Radiated Emission (Chip Antenna, Worst-case)**

Frequency in MHz	Horizontal Peak (dBμV/m)	Horizontal Average (dBμV/m)	Vertical Peak (dBμV/m)	Vertical Average (dBμV/m)	Limit @ 3m (dBμV/m)
2412.0	98.0	93.8	102.3	87.9	--
4824.0	55.3	42.6	55.6	42.9	54.0
7236.0	47.5	34.7	48.0	34.8	54.0
9648.0	44.9	32.1	45.4	32.6	54.0
12060.0	48.7	35.9	48.6	35.9	54.0
2437.0	98.5	94.3	102.4	98.0	--
4874.0	55.3	42.8	55.5	42.9	54.0
7311.0	44.8	32.1	45.2	33.1	54.0
9748.0	49.6	36.7	49.6	36.7	54.0
12185.0	48.5	35.6	48.0	35.2	54.0
2462.0	98.5	94.4	102.2	98.5	--
4924.0	54.7	42.5	54.4	42.6	54.0
7386.0	46.9	33.2	46.0	33.3	54.0
9848.0	50.0	36.2	48.9	36.2	54.0
12310.0	47.8	35.1	48.7	35.5	54.0

Other emissions present had amplitudes at least 20 dB below the limit.

Quasi-Peak amplitude emissions are recorded above for frequency range of 30-1000 MHz.

Average amplitude emissions are recorded above for frequency range above 1000 MHz.

**Transmitter Radiated Emission (5dBi Dipole, Worst-case)**

Frequency in MHz	Horizontal Peak (dBµV/m)	Horizontal Average (dBµV/m)	Vertical Peak (dBµV/m)	Vertical Average (dBµV/m)	Limit @ 3m (dBµV/m)
2412.0	100.5	96.2	115.1	111.1	--
4824.0	55.6	43.2	57.6	47.1	54.0
7236.0	48.4	35.4	49.1	37.4	54.0
9648.0	50.8	37.4	50.1	37.4	54.0
12060.0	48.8	35.9	48.9	36.0	54.0
2437.0	100.9	96.7	114.8	111.2	--
4874.0	56.4	43.8	58.1	48.2	54.0
7311.0	45.9	33.1	46.5	34.8	54.0
9748.0	48.4	35.2	48.0	35.2	54.0
12185.0	47.9	35.4	48.8	35.9	54.0
2462.0	99.6	96.2	115.0	110.9	--
4924.0	55.9	44.0	59.3	49.6	54.0
7386.0	46.9	34.1	46.7	33.7	54.0
9848.0	49.4	36.2	49.0	36.1	54.0
12310.0	49.0	35.5	48.1	35.2	54.0

Other emissions present had amplitudes at least 20 dB below the limit.

Quasi-Peak amplitude emissions are recorded above for frequency range of 30-1000 MHz.

Average amplitude emissions are recorded above for frequency range above 1000 MHz.

**Summary of Results for Transmitter Radiated Emissions of Intentional Radiator**

The EUT demonstrated compliance with the conducted and radiated emissions requirements of CFR47 Part 15.247. Conducted antenna port power of 21.43 dBm, 0.140 Watts was measured.

The EUT demonstrated a minimum harmonic radiated emission margin of -4.4 dB below the requirements. There are no other significantly measurable emissions in the restricted bands other than those recorded in this report. Other emissions were present with amplitudes at least 20 dB below the requirements. The specifications of 15.247 were met; there are no deviations or exceptions to the requirements.

**Statement of Modifications and Deviations**

No modifications to the EUT were required for the unit to demonstrate compliance with the CFR47 Part 15C emissions standards. There were no deviations to the specifications.



NVLAP Lab Code 200087-0

## Annex

- Annex A Measurement Uncertainty Calculations
- Annex B Rogers Labs Test Equipment List
- Annex C Rogers Qualifications
- Annex D FCC Site Registration Letter
- Annex E Industry Canada Site Registration Letter

## Annex A Measurement Uncertainty Calculations

### Radiated Emissions Measurement Uncertainty Calculation

Measurement of vertically polarized radiated field strength over the frequency range 30 MHz to 1 GHz on an open area test site at 3m and 10m includes following uncertainty:

Contribution	Probability Distribution	Uncertainty (dB)
Antenna factor calibration	normal (k = 2)	±0.58
Cable loss calibration	normal (k = 2)	±0.2
Receiver specification	rectangular	±1.0
Antenna directivity	rectangular	±0.1
Antenna factor variation with height	rectangular	±2.0
Antenna factor frequency interpolation	rectangular	±0.1
Measurement distance variation	rectangular	±0.2
Site Imperfections	rectangular	±1.5
Combined standard uncertainty $u_c(y)$ is		

$$U_c(y) = \pm \sqrt{\left[\frac{1.0}{2}\right]^2 + \left[\frac{0.2}{2}\right]^2 + \left[\frac{1.0^2 + 0.1^2 + 2.0^2 + 0.1^2 + 0.2^2 + 1.5^2}{3}\right]}$$

$$U_c(y) = \pm 1.6 \text{ dB}$$

It is probable that  $u_c(y) / s(q_k) > 3$ , where  $s(q_k)$  is estimated standard deviation from a sample of  $n$  readings unless the repeatability of the EUT is particularly poor, and a coverage factor of  $k = 2$  will ensure that the level of confidence will be approximately 95%, therefore:

$$s(q_k) = \sqrt{\frac{1}{(n-1)} \sum_{k=1}^n (q_k - \bar{q})^2}$$

$$U = 2 U_c(y) = 2 \times \pm 1.6 \text{ dB} = \pm 3.2 \text{ dB}$$

#### Notes:

- 1.1 Uncertainties for the antenna and cable were estimated, based on a normal probability distribution with  $k = 2$ .
- 1.2 The receiver uncertainty was obtained from the manufacturer's specification for which a rectangular distribution was assumed.
- 1.3 The antenna factor uncertainty does not take account of antenna directivity.
- 1.4 The antenna factor varies with height and since the height was not always the same in use as when the antenna was calibrated an additional uncertainty is added.
- 1.5 The uncertainty in the measurement distance is relatively small but has some effect on the received signal strength. The increase in measurement distance as the antenna height is increased is an inevitable consequence of the test method and is therefore not considered a contribution to uncertainty.
- 1.6 Site imperfections are difficult to quantify but may include the following contributions:
  - Unwanted reflections from adjacent objects.
  - Ground plane imperfections: reflection coefficient, flatness, and edge effects.
  - Losses or reflections from "transparent" cabins for the EUT or site coverings.
  - Earth currents in antenna cable (mainly effect Biconical antennas).



The specified limits for the difference between measured site attenuation and the theoretical value ( $\pm 4$  dB) were not included in total since the measurement of site attenuation includes uncertainty contributions already allowed for in this budget, such as antenna factor.

*Conducted Measurements Uncertainty Calculation*

Measurement of conducted emissions over the frequency range 9 kHz to 30 MHz includes following uncertainty:

Contribution	Probability Distribution	Uncertainty (dB)
Receiver specification	rectangular	$\pm 1.5$
LISN coupling specification	rectangular	$\pm 1.5$
Cable and input attenuator calibration	normal (k=2)	$\pm 0.5$
Combined standard uncertainty $u_c(y)$ is		

$$U_c(y) = \pm \sqrt{\left[\frac{0.5}{2}\right]^2 + \frac{1.5^2 + 1.5^2}{3}}$$

$$U_c(y) = \pm 1.2 \text{ dB}$$

As with radiated field strength uncertainty, it is probable that  $u_c(y) / s(q_k) > 3$  and a coverage factor of  $k = 2$  will suffice, therefore:

$$U = 2 U_c(y) = 2 \times \pm 1.2 \text{ dB} = \pm 2.4 \text{ dB}$$



**Annex B Rogers Labs Test Equipment List**

The test equipment is maintained in calibration and good operating condition. Use of this calibrated equipment ensures measurements are traceable to national standards.

List of Test Equipment	Calibration Date
Spectrum Analyzer: Rohde & Schwarz ESU40	5/11
Spectrum Analyzer: HP 8562A, HP Adapters: 11518, 11519, and 11520 Mixers: 11517A, 11970A, 11970K, 11970U, 11970V, 11970W	5/11
Spectrum Analyzer: HP 8591EM	5/11
Antenna: EMCO Biconilog Model: 3143	5/11
Antenna: Sunol Biconilog Model: JB6	10/10
Antenna: EMCO Log Periodic Model: 3147	10/10
Antenna: Antenna Research Biconical Model: BCD 235	10/10
LISN: Compliance Design Model: FCC-LISN-2.Mod.cd, 50 µHy/50 ohm/0.1 µf	10/10
R.F. Preamp CPPA-102	10/10
Attenuator: HP Model: HP11509A	10/10
Attenuator: Mini Circuits Model: CAT-3	10/10
Attenuator: Mini Circuits Model: CAT-3	10/10
Cable: Belden RG-58 (L1)	10/10
Cable: Belden RG-58 (L2)	10/10
Cable: Belden 8268 (L3)	10/10
Cable: Time Microwave: 4M-750HF290-750	10/10
Cable: Time Microwave: 10M-750HF290-750	10/10
Frequency Counter: Leader LDC825	2/11
Oscilloscope Scope: Tektronix 2230	2/11
Wattmeter: Bird 43 with Load Bird 8085	2/11
Power Supplies: Sorensen SRL 20-25, SRL 40-25, DCR 150, DCR 140	2/11
R.F. Generators: HP 606A, HP 8614A, HP 8640B	2/11
R.F. Power Amp 65W Model: 470-A-1010	2/11
R.F. Power Amp 50W M185- 10-501	2/11
R.F. Power Amp A.R. Model: 10W 1010M7	2/11
R.F. Power Amp EIN Model: A301	2/11
LISN: Compliance Eng. Model 240/20	2/11
LISN: Fischer Custom Communications Model: FCC-LISN-50-16-2-08	2/11
Antenna: EMCO Dipole Set 3121C	2/11
Antenna: C.D. B-101	2/11
Antenna: Solar 9229-1 & 9230-1	2/11
Antenna: EMCO 6509	2/11
Audio Oscillator: H.P. 201CD	2/11
Peavey Power Amp Model: IPS 801	2/11
ELGAR Model: 1751	2/11
ELGAR Model: TG 704A-3D	2/11
ESD Test Set 2010i	2/11
Fast Transient Burst Generator Model: EFT/B-101	2/11
Field Intensity Meter: EFM-018	2/11
KEYTEK Ecat Surge Generator	2/11
Shielded Room 5 M x 3 M x 3.0 M	



## **Annex C Rogers Qualifications**

***Scot D. Rogers, Engineer***

### **Rogers Labs, Inc.**

Mr. Rogers has approximately 17 years experience in the field of electronics. Engineering experience includes six years in the automated controls industry and remaining years working with the design, development and testing of radio communications and electronic equipment.

#### Positions Held

Systems Engineer: A/C Controls Mfg. Co., Inc. 6 Years

Electrical Engineer: Rogers Consulting Labs, Inc. 5 Years

Electrical Engineer: Rogers Labs, Inc. Current

#### Educational Background

- 1) Bachelor of Science Degree in Electrical Engineering from Kansas State University.
- 2) Bachelor of Science Degree in Business Administration Kansas State University.
- 3) Several Specialized Training courses and seminars pertaining to Microprocessors and Software programming.

Scot D. Rogers





NVLAP Lab Code 200087-0

**Annex D FCC Site Registration Letter**

**FEDERAL COMMUNICATIONS COMMISSION**

**Laboratory Division  
7435 Oakland Mills Road  
Columbia, MD 21046**

May 18, 2010

Registration Number: 90910

Rogers Labs, Inc.  
4405 West 259th Terrace,  
Louisburg, KS 66053

Attention: Scot Rogers,

Re: Measurement facility located at Louisburg  
~~3 & 10 meter site~~  
Date of Renewal: May 18, 2010

Dear Sir or Madam:

Your request for renewal of the registration of the subject measurement facility has been received. The information submitted has been placed in your file and the registration has been renewed. The name of your organization will remain on the list of facilities whose measurement data will be accepted in conjunction with applications for Certification under Parts 15 or 18 of the Commission's Rules. Please note that the file must be updated for any changes made to the facility and the registration must be renewed at least every three years.

Measurement facilities that have indicated that they are available to the public to perform measurement services on a fee basis may be found on the FCC website [www.fcc.gov](http://www.fcc.gov) under E-Filing, OET Equipment Authorization Electronic Filing, Test Firms.

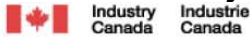
Sincerely,

Phyllis Farrish  
Industry Analyst



NVLAP Lab Code 200087-0

## Annex E Industry Canada Site Registration Letter



May 26, 2010

OUR FILE: 46405-3041  
Submission No: 140719

**Rogers Labs Inc.**  
4405 West 259<sup>th</sup> Terrace  
Louisburg, KY, 66053  
USA

**Attention:** Mr. Scot D. Rogers

Dear Sir/Madame:

The Bureau has received your application for the renewal of a 3/10m OATS. Be advised that the information received was satisfactory to Industry Canada. The following number(s) is now associated to the site(s) for which registration / renewal was sought (**3041A-1**). Please reference the appropriate site number in the body of test reports containing measurements performed on the site. In addition, please keep for your records the following information;

- Your primary code is: **3041**
- The company number associated to the site(s) located at the above address is: **3041A**

Furthermore, to obtain or renew a unique site number, the applicant shall demonstrate that the site has been accredited to ANSI C63.4-2003 or later. A scope of accreditation indicating the accreditation by a recognized accreditation body to ANSI C63.4-2003 or later shall be accepted. Please indicate in a letter the previous assigned site number if applicable and the type of site (example: 3 metre OATS or 3 metre chamber). If the test facility is not accredited to ANSI C63.4-2003 or later, the test facility shall submit test data demonstrating full compliance with the ANSI standard. The Bureau will evaluate the filing to determine if recognition shall be granted.

The frequency for re-validation of the test site and the information that is required to be filed or retained by the testing party shall comply with the requirements established by the accrediting organization. However, in all cases, test site re-validation shall occur on an interval not to exceed two years. There is no fee or form associated with an OATS filing. OATS submissions are encouraged to be submitted electronically to the Bureau using the following URL;

[http://strategis.ic.gc.ca/epic/internet/inceb-bhst.nsf/en/h\\_tt00052e.html](http://strategis.ic.gc.ca/epic/internet/inceb-bhst.nsf/en/h_tt00052e.html).

If you have any questions, you may contact the Bureau by e-mail at [certification.bureau@ic.gc.ca](mailto:certification.bureau@ic.gc.ca) Please reference our file and submission number above for all correspondence.

Yours sincerely,

Dalwinder Gill  
For: Wireless Laboratory Manager  
Certification and Engineering Bureau  
3701 Carling Ave., Building 94  
P.O. Box 11490, Station "H"  
Ottawa, Ontario K2H 8S2  
Email: dalwinder.gill@ic.gc.ca  
Tel. No. (613) 998-3363  
Fax. No. (613) 990-4752

Rogers Labs, Inc.  
4405 W. 259th Terrace  
Louisburg, KS 66053  
Phone/Fax: (913) 837-3214  
Revision 1

ARC Wireless LLC  
Model: ARCFlex 802.11bgn Module  
Test #: 110826  
Test to: CFR47 (15.247)  
File: ARC Wireless ARCFlex TstRpt 110826

SN: ENG1  
FCC ID#: Z2B-AFM1  
Date: September 27, 2011  
Page 58 of 58