



FCC TEST REPORT

REPORT NO.: RF110803E03A

MODEL NO.: R405G-A, ZGR304F

FCC ID: Z28-R405G-A

RECEIVED: Sep. 21, 2011

TESTED: Sep. 27 to Oct. 01 , 2011

ISSUED: Nov. 21, 2011

APPLICANT: ZUNIDATA SYSTEMS, INC.

ADDRESS: 4F-7, No.65, Gaotia 7th Rd, Zhubei City,
Hsinchu county 302, Taiwan

ISSUED BY: Bureau Veritas Consumer Products Services
(H.K.) Ltd., Taoyuan Branch Hsin Chu Laboratory

LAB ADDRESS : No. 81-1, Lu Liao Keng, 9th Ling,Wu Lung Tsuen,
Chiung Lin Hsiang, Hsin Chu Hsien 307, Taiwan

TEST LOCATION (1): No. 81-1, Lu Liao Keng, 9th Ling,Wu Lung Tsuen,
Chiung Lin Hsiang, Hsin Chu Hsien 307, Taiwan

TEST LOCATION (2): No. 49, Ln. 206, Wende Rd., Shangshan Tsuen,
Chiung Lin Hsiang, Hsin Chu Hsien 307, Taiwan

This test report consists of 79 pages in total. It may be duplicated completely for legal use with the approval of the applicant. It should not be reproduced except in full, without the written approval of our laboratory. The client should not use it to claim product certification, approval, or endorsement by TAF or any government agencies. The test results in the report only apply to the tested sample.





A D T

Table of Contents

RELEASE CONTROL RECORD.....	4
1. CERTIFICATION.....	5
2. SUMMARY OF TEST RESULTS.....	6
2.1 MEASUREMENT UNCERTAINTY	7
3. GENERAL INFORMATION	8
3.1 GENERAL DESCRIPTION OF EUT.....	8
3.2 DESCRIPTION OF TEST MODES.....	10
3.2.1 TEST MODE APPLICABILITY AND TESTED CHANNEL DETAIL	11
3.3 GENERAL DESCRIPTION OF APPLIED STANDARDS	14
3.4 DESCRIPTION OF SUPPORT UNITS.....	15
3.5 CONFIGURATION OF SYSTEM UNDER TEST	16
4. TEST TYPES AND RESULTS.....	17
4.1 CONDUCTED EMISSION MEASUREMENT	17
4.1.1 LIMITS OF CONDUCTED EMISSION MEASUREMENT.....	17
4.1.2 TEST INSTRUMENTS	17
4.1.3 TEST PROCEDURES.....	18
4.1.4 DEVIATION FROM TEST STANDARD	18
4.1.5 TEST SETUP	19
4.1.6 EUT OPERATING CONDITIONS.....	19
4.1.7 TEST RESULTS.....	20
4.2 RADIATED EMISSION MEASUREMENT	22
4.2.1 LIMITS OF RADIATED EMISSION MEASUREMENT.....	22
4.2.2 TEST INSTRUMENTS	23
4.2.3 TEST PROCEDURES.....	24
4.2.4 DEVIATION FROM TEST STANDARD	24
4.2.5 TEST SETUP	25
4.2.6 EUT OPERATING CONDITIONS.....	25
4.2.7 TEST RESULTS.....	26
4.3 6dB BANDWIDTH MEASUREMENT	55
4.3.1 LIMITS OF 6dB BANDWIDTH MEASUREMENT	55
4.3.2 TEST INSTRUMENTS	55
4.3.3 TEST PROCEDURE	55
4.3.4 DEVIATION FROM TEST STANDARD	55
4.3.5 TEST SETUP	55
4.3.6 EUT OPERATING CONDITIONS.....	55
4.3.7 TEST RESULTS.....	56
4.4 MAXIMUM PEAK OUTPUT POWER	60



A D T

4.4.1	LIMITS OF MAXIMUM PEAK OUTPUT POWER MEASUREMENT	60
4.4.2	INSTRUMENTS	60
4.4.3	TEST PROCEDURES.....	60
4.4.4	DEVIATION FROM TEST STANDARD	60
4.4.5	TEST SETUP	60
4.4.6	EUT OPERATING CONDITIONS.....	61
4.4.7	TEST RESULTS.....	62
4.5	POWER SPECTRAL DENSITY MEASUREMENT.....	63
4.5.1	LIMITS OF POWER SPECTRAL DENSITY MEASUREMENT	63
4.5.2	TEST INSTRUMENTS	63
4.5.3	TEST PROCEDURE	63
4.5.4	DEVIATION FROM TEST STANDARD	63
4.5.5	TEST SETUP	63
4.5.6	EUT OPERATING CONDITION	64
4.5.7	TEST RESULTS.....	65
4.6	CONDUCTED OUT-BAND EMISSION MEASUREMENT.....	69
4.6.1	LIMITS OF CONDUCTED OUT-BAND EMISSION MEASUREMENT	69
4.6.2	TEST INSTRUMENTS	69
4.6.3	TEST PROCEDURE	69
4.6.4	DEVIATION FROM TEST STANDARD	69
4.6.5	EUT OPERATING CONDITION	69
4.6.6	TEST RESULTS.....	69
5.	INFORMATION ON THE TESTING LABORATORIES	78
6.	APPENDIX A - MODIFICATIONS RECORDERS FOR ENGINEERING CHANGES TO THE EUT BY THE LAB	79



A D T

RELEASE CONTROL RECORD

ISSUE NO.	REASON FOR CHANGE	DATE ISSUED
RF110803E03A	Original release	Nov. 21, 2011



A D T

1. CERTIFICATION

PRODUCT: Wireless IEEE802.11b/g/n 300Mbps Gigabit Router

BRAND NAME: North Link, Zuni Data, Zuni Digital, Zuni Connect, ZUNI

MODEL NO.: R405G-A, ZGR304F

TEST SAMPLE: ENGINEERING SAMPLE

APPLICANT: ZUNIDATA SYSTEMS, INC.

TESTED: Sep. 27 to Oct. 01 , 2011

STANDARDS: FCC Part 15, Subpart C (Section 15.247)
ANSI C63.4-2003
ANSI C63.10-2009

The above equipment (Model: R405G-A) has been tested by **Bureau Veritas Consumer Products Services (H.K.) Ltd., Taoyuan Branch**, and found compliance with the requirement of the above standards. The test record, data evaluation & Equipment Under Test (EUT) configurations represented herein are true and accurate accounts of the measurements of the sample's EMC characteristics under the conditions specified in this report.

PREPARED BY : Elsie Hsu , **DATE:** Nov. 21, 2011
(Elsie Hsu, Specialist)

APPROVED BY : May Chen , **DATE:** Nov. 21, 2011
(May Chen, Deputy Manager)



A D T

2. SUMMARY OF TEST RESULTS

The EUT has been tested according to the following specifications:

APPLIED STANDARD: FCC Part 15, Subpart C			
Standard Section	Test Type and Limit	Result	Remark
15.207	AC Power Conducted Emission	PASS	Meet the requirement of limit. Minimum passing margin is -7.60dB at 0.396MHz
15.247(a)(2)	Spectrum Bandwidth of a Direct Sequence Spread Spectrum System Limit: min. 500kHz	PASS	Meet the requirement of limit.
15.247(b)	Maximum Peak Output Power Limit: max. 30dBm	PASS	Meet the requirement of limit.
15.247(d)	Radiated Emissions Limit: Table 15.209	PASS	Meet the requirement of limit. Minimum passing margin is -0.6dB at 4874.00MHz
15.247(e)	Power Spectral Density Limit: max. 8dBm	PASS	Meet the requirement of limit.
15.247(d)	Conducted Out-Band Emission Measurement Limit: 20dB less than the peak value of fundamental frequency	PASS	Meet the requirement of limit.
15.203	Antenna Requirement	PASS	No antenna connector is used.



A D T

2.1 MEASUREMENT UNCERTAINTY

Where relevant, the following measurement uncertainty levels have been estimated for tests performed on the EUT as specified in CISPR 16-4-2:

This uncertainty represents an expanded uncertainty expressed at approximately the 95% confidence level using a coverage factor of $k=2$.

Measurement	Value
Conducted emissions	2.45 dB
Radiated emissions (30MHz-1GHz)	3.81 dB
Radiated emissions (1GHz -18GHz)	2.19 dB
Radiated emissions (18GHz -40GHz)	2.56 dB



A D T

3. GENERAL INFORMATION

3.1 GENERAL DESCRIPTION OF EUT

PRODUCT	Wireless IEEE802.11b/g/n 300Mbps Gigabit Router
MODEL NO.	R405G-A, ZGR304F
FCC ID	Z28-R405G-A
POWER SUPPLY	DC 5V from power adapter
MODULATION TYPE	CCK, DQPSK, DBPSK for DSSS 64QAM, 16QAM, QPSK, BPSK for OFDM
MODULATION TECHNOLOGY	DSSS, OFDM
TRANSFER RATE	802.11b: up to 11Mbps 802.11g: up to 54Mbps 802.11n (20MHz): up to 130Mbps 802.11n (40MHz): up to 270Mbps
OPERATING FREQUENCY	2412MHz ~ 2462MHz
NUMBER OF CHANNEL	For 802.11b, 802.11g, 802.11n (20MHz) : 11 For 802.11n (40MHz) : 7
MAXIMUM OUTPUT POWER	802.11b: 61.7mW 802.11g: 218.8mW 802.11n (20MHz): 432.6mW 802.11n (40MHz): 442.9mW
ANTENNA TYPE	Please see NOTE
DATA CABLE	NA
I/O PORTS	LAN port x 4 WAN port x 1 USB port x 2 (Power only)
ASSOCIATED DEVICES	Adapter x 1

NOTE:

1. The EUT has two model names which are identical to each other in all aspects except for the following table:

Model Name	Brand	Description
R405G-A	North Link	For marketing requirement
	Zuni Data	
	Zuni Digital	
	Zuni Connect	
ZGR304F	ZUNI	

From the above models, model: **R405G-A** was selected as representative model for the test and its data was recorded in this report.

2. There are two antennas provided to this EUT, please refer to the following table:

Transmitter Circuit	Gain(dBi)	Antenna Type	Connector Type	Frequency range (GHz to GHz)
Chain(0)	2.86	PIFA	NA	2.4GHz ~ 2.5GHz
Chain(1)	4.17	PIFA	NA	2.4GHz ~ 2.5GHz

3. The EUT must be supplied with a power adapter as below table:

Brand	Model No.	Spec.
SIL	SSA-5W-05	AC I/P: 100~240V, 50/60Hz, 0.2A DC O/P: 5V, 1000mA DC Output cable: 1.8m, unshielded

4. The EUT is 2 * 2 spatial MIMO (2Tx & 2Rx) without beam forming function.
5. When the EUT operating in 802.11n, the software operation, which is defined by manufacturer, MCS (Modulation and Coding Schemes) from 0 to 15.
6. The above EUT information was declared by manufacturer and for more detailed features description, please refer to the manufacturer's specifications or user's manual.

3.2 DESCRIPTION OF TEST MODES

Eleven channels are provided for 802.11b, 802.11g, 802.11n (20MHz):

CHANNEL	FREQUENCY	CHANNEL	FREQUENCY
1	2412MHz	7	2442MHz
2	2417MHz	8	2447MHz
3	2422MHz	9	2452MHz
4	2427MHz	10	2457MHz
5	2432MHz	11	2462MHz
6	2437MHz		

Seven channels are provided for 802.11n (40MHz):

CHANNEL	FREQUENCY	CHANNEL	FREQUENCY
3	2422MHz	7	2442MHz
4	2427MHz	8	2447MHz
5	2432MHz	9	2452MHz
6	2437MHz		



A D T

3.2.1 TEST MODE APPLICABILITY AND TESTED CHANNEL DETAIL

EUT CONFIGURE MODE	APPLICABLE TO				DESCRIPTION
	PLC	RE < 1G	RE ≥ 1G	APCM	
	√	√	√	√	

Where **PLC**: Power Line Conducted Emission **RE < 1G**: Radiated Emission below 1GHz
RE ≥ 1G: Radiated Emission above 1GHz **APCM**: Antenna Port Conducted Measurement
OB: Conducted Out-Band Emission Measurement

ANTENNA COMBINATION MODE:

COMBINATION MODE	OPERATION MODE	TX CHAIN(0)	TX CHAIN(1)
A	802.11 b	√	
B	802.11 g	√	
C	802.11n(20MHz) for MCS0~7	√	
D	802.11n(20MHz) for MCS8~15	√	√
E	802.11n(40MHz) for MCS0~7	√	
F	802.11n(40MHz) for MCS8~15	√	√

Note:
 The above information was declared by manufacturer and for more detailed features description, please refer to the manufacturer's specifications or user's manual.
 2. Mode A, B, D, F and N the worst modes, were selected as representative mode for the report.

POWER LINE CONDUCTED EMISSION TEST:

- Pre-Scan has been conducted to determine the worst-case mode from all possible combinations between available modulations, data rates and antenna ports (if EUT with antenna diversity architecture).
- Following channel(s) was (were) selected for the final test as listed below.

MODE	AVAILABLE CHANNEL	TESTED CHANNEL	MODULATION TECHNOLOGY	MODULATION TYPE	DATA RATE (Mbps)	COMBINATION MODE
802.11n (20MHz)	1 to 11	1	OFDM	BPSK	6.5	D



RADIATED EMISSION TEST (BELOW 1 GHz):

- Pre-Scan has been conducted to determine the worst-case mode from all possible combinations between available modulations, data rates and antenna ports (if EUT with antenna diversity architecture).
- Following channel(s) was (were) selected for the final test as listed below.

MODE	AVAILABLE CHANNEL	TESTED CHANNEL	MODULATION TECHNOLOGY	MODULATION TYPE	DATA RATE (Mbps)	COMBINATION MODE
802.11n (20MHz)	1 to 11	1	OFDM	BPSK	6.5	D

RADIATED EMISSION TEST (ABOVE 1 GHz):

- Pre-Scan has been conducted to determine the worst-case mode from all possible combinations between available modulations, data rates and antenna ports (if EUT with antenna diversity architecture).
- Following channel(s) was (were) selected for the final test as listed below.

MODE	AVAILABLE CHANNEL	TESTED CHANNEL	MODULATION TECHNOLOGY	MODULATION TYPE	DATA RATE (Mbps)	COMBINATION MODE
802.11b	1 to 11	1, 6, 11	DSSS	DBPSK	1	A
802.11g	1 to 11	1, 6, 11	OFDM	BPSK	6	B
802.11n (20MHz)	1 to 11	1, 6, 11	OFDM	BPSK	6.5	D
802.11n (40MHz)	3 to 9	3, 6, 9	OFDM	BPSK	13.5	F

ANTENNA PORT CONDUCTED MEASUREMENT:

- This item includes all test value of each mode, but only includes spectrum plot of worst value of each mode.
- Pre-Scan has been conducted to determine the worst-case mode from all possible combinations between available modulations, data rates and antenna ports (if EUT with antenna diversity architecture).
- Following channel(s) was (were) selected for the final test as listed below.

MODE	AVAILABLE CHANNEL	TESTED CHANNEL	MODULATION TECHNOLOGY	MODULATION TYPE	DATA RATE (Mbps)	COMBINATION MODE
802.11b	1 to 11	1, 6, 11	DSSS	DBPSK	1	A
802.11g	1 to 11	1, 6, 11	OFDM	BPSK	6	B
802.11n (20MHz)	1 to 11	1, 6, 11	OFDM	BPSK	6.5	D
802.11n (40MHz)	3 to 9	3, 6, 9	OFDM	BPSK	13.5	F



A D T

CONDUCTED OUT-BAND EMISSION MEASUREMENT:

- Pre-Scan has been conducted to determine the worst-case mode from all possible combinations between available modulations, data rates and antenna ports (if EUT with antenna diversity architecture).
- Following channel(s) was (were) selected for the final test as listed below.

MODE	AVAILABLE CHANNEL	TESTED CHANNEL	MODULATION TECHNOLOGY	MODULATION TYPE	DATA RATE (Mbps)	COMBINATION MODE
802.11b	1 to 11	1, 11	DSSS	DBPSK	1	A
802.11g	1 to 11	1, 11	OFDM	BPSK	6	B
802.11n (20MHz)	1 to 11	1, 11	OFDM	BPSK	6.5	D
802.11n (40MHz)	3 to 9	3, 9	OFDM	BPSK	13.5	F

TEST CONDITION:

APPLICABLE TO	ENVIRONMENTAL CONDITIONS	INPUT POWER	TESTED BY
PLC	25deg. C, 68%RH	120Vac, 60Hz	Andy Ho
RE ³ 1G	32deg. C, 59%RH	120Vac, 60Hz	Rex Huang
RE<1G	25deg. C, 70%RH	120Vac, 60Hz	Nelson Teng
APCM	26deg. C, 63%RH	120Vac, 60Hz	Rex Huang

3.3 GENERAL DESCRIPTION OF APPLIED STANDARDS

The EUT is a RF product. According to the specifications of the manufacturer, it must comply with the requirements of the following standards:

FCC Part 15, Subpart C. (15.247)

ANSI C63.4-2003

ANSI C63.10-2009

All test items have been performed and recorded as per the above standards.

NOTE: The EUT has been verified to comply with the requirements of FCC Part 15, Subpart B, Class B (DoC). The test report has been issued separately.



A D T

3.4 DESCRIPTION OF SUPPORT UNITS

The EUT has been tested as an independent unit together with other necessary accessories or support units. The following support units or accessories were used to form a representative test configuration during the tests.

NO.	PRODUCT	BRAND	MODEL NO.	SERIAL NO.	FCC ID
1	NOTEBOOK COMPUTER	DELL	PP32LA	FSLB32S	FCC Doc
2	NOTEBOOK COMPUTER	DELL	PP32LA	GSLB32S	FCC Doc
3	HUB	ZyXEL	ES-116P	S060H02000215	FCC Doc

NO.	SIGNAL CABLE DESCRIPTION OF THE ABOVE SUPPORT UNITS
1	10m UTP cable x 1
2	10m UTP cable x 1
3	10m UTP cable x 1

NOTE: All power cords of the above support units are non shielded (1.8m).

3.5 CONFIGURATION OF SYSTEM UNDER TEST

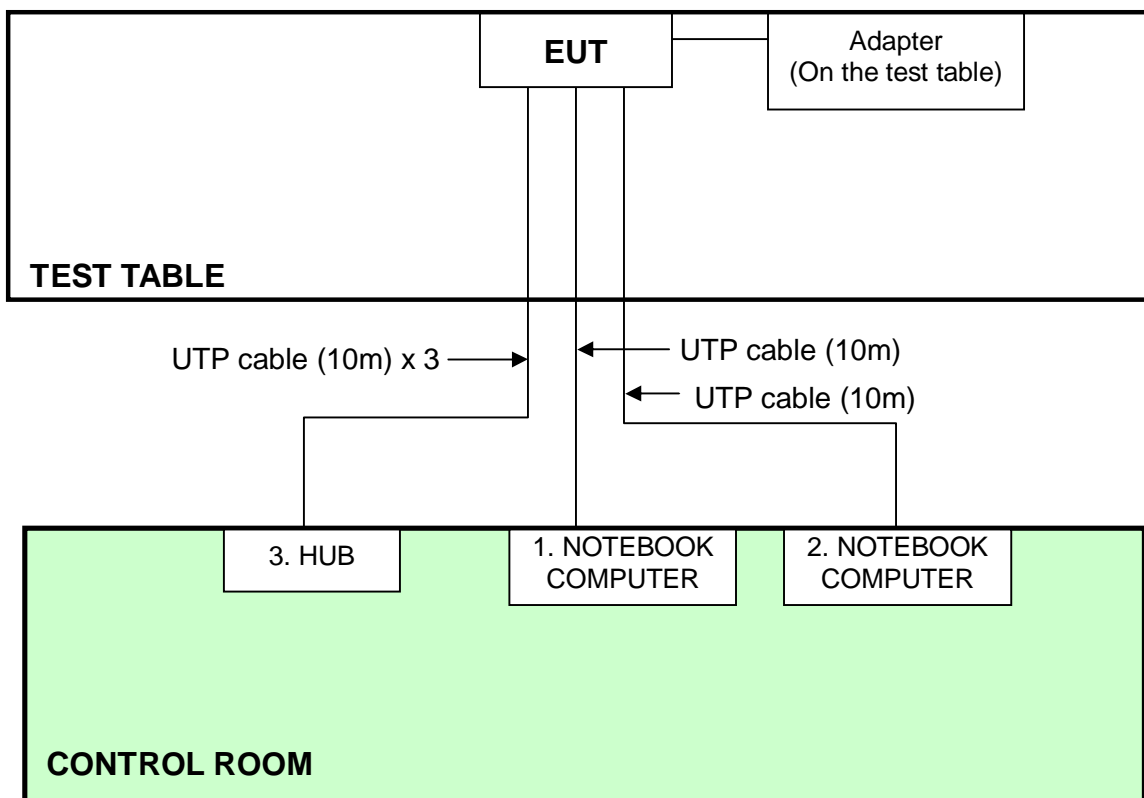

4. TEST TYPES AND RESULTS

4.1 CONDUCTED EMISSION MEASUREMENT

4.1.1 LIMITS OF CONDUCTED EMISSION MEASUREMENT

FREQUENCY OF EMISSION (MHz)	CONDUCTED LIMIT (dB μ V)	
	Quasi-peak	Average
0.15-0.5	66 to 56	56 to 46
0.5-5	56	46
5-30	60	50

- NOTE:**
1. The lower limit shall apply at the transition frequencies.
 2. The limit decreases in line with the logarithm of the frequency in the range of 0.15 to 0.50 MHz.
 3. All emanations from a class A/B digital device or system, including any network of conductors and apparatus connected thereto, shall not exceed the level of field strengths specified above.

4.1.2 TEST INSTRUMENTS

Test date: Oct. 04, 2011

DESCRIPTION & MANUFACTURER	MODEL NO.	SERIAL NO.	CALIBRATED DATE	CALIBRATED UNTIL
ROHDE & SCHWARZ Test Receiver	ESCS 30	100287	Mar. 02, 2011	Mar. 01, 2012
Line-Impedance Stabilization Network (for EUT)	NSLK 8127	8127-523	Sep. 20, 2011	Sep. 19, 2012
Line-Impedance Stabilization Network (for Peripheral)	ENV-216	100072	June 10, 2011	June 09, 2012
50 ohms Terminator	50	3	Nov. 03, 2010	Nov. 02, 2011
Software	BV ADT_Cond_V7.3.7	NA	NA	NA

Note:

1. The calibration interval of the above test instruments is 12 months and the calibrations are traceable to NML/ROC and NIST/USA.
2. The test was performed in Shielded Room No. A.
3. The VCCI Con A Registration No. is C-817.



A D T

4.1.3 TEST PROCEDURES

- a. The EUT was placed 0.4 meters from the conducting wall of the shielded room with EUT being connected to the power mains through a line impedance stabilization network (LISN). Other support units were connected to the power mains through another LISN. The two LISNs provide 50 ohm/ 50uH of coupling impedance for the measuring instrument.
- b. Both lines of the power mains connected to the EUT were checked for maximum conducted interference.
- c. The frequency range from 150kHz to 30MHz was searched. Emission levels under (Limit - 20dB) were not recorded.

4.1.4 DEVIATION FROM TEST STANDARD

No deviation

4.1.5 TEST SETUP

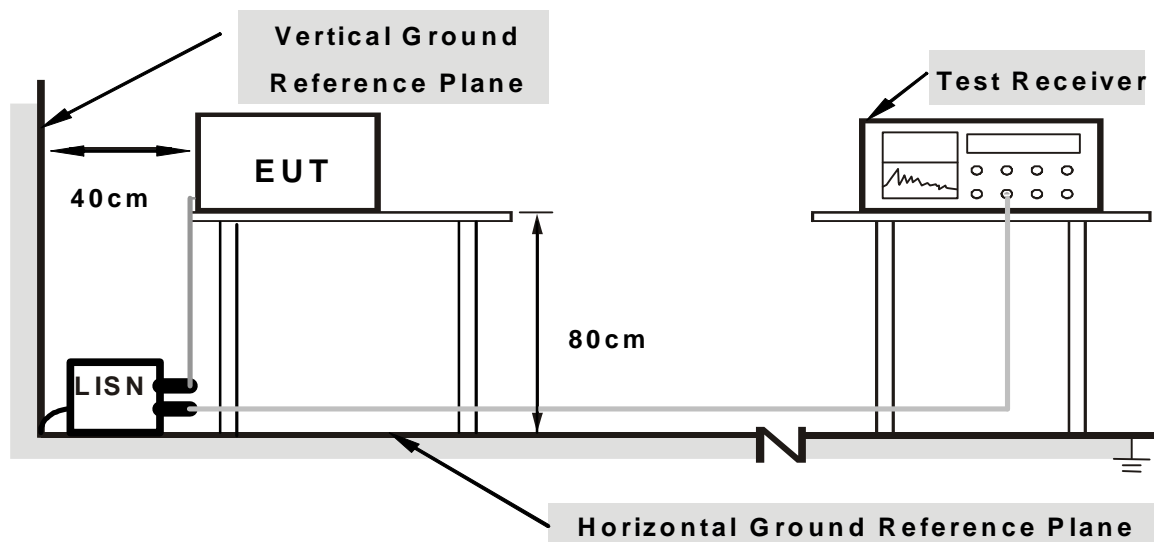

Note: 1. Support units were connected to second LISN.

2. Both of LISNs (AMN) are 80 cm from EUT and at least 80 from other units and other metal planes

For the actual test configuration, please refer to the related item – Photographs of the Test Configuration.

4.1.6 EUT OPERATING CONDITIONS

1. Turn on the power of all equipment.
2. The communication partner run test program “MP_TEST.exe” to enable EUT under transmission/receiving condition continuously at specific channel frequency.

4.1.7 TEST RESULTS

PHASE	Line (L)	6dB BANDWIDTH	9 kHz
--------------	----------	----------------------	-------

No	Freq. [MHz]	Corr. Factor (dB)	Reading Value [dB (uV)]		Emission Level [dB (uV)]		Limit [dB (uV)]		Margin (dB)	
			Q.P.	AV.	Q.P.	AV.	Q.P.	AV.	Q.P.	AV.
	1	0.396	0.08	47.44	40.26	47.52	40.34	57.93	47.93	-10.42
2	0.525	0.08	46.63	36.98	46.71	37.06	56.00	46.00	-9.29	-8.94
3	0.689	0.09	45.39	36.46	45.48	36.55	56.00	46.00	-10.52	-9.45
4	0.904	0.10	45.45	36.97	45.55	37.07	56.00	46.00	-10.45	-8.93
5	1.477	0.15	44.77	36.11	44.92	36.26	56.00	46.00	-11.08	-9.74
6	2.113	0.21	45.36	36.46	45.57	36.67	56.00	46.00	-10.43	-9.33
7	2.816	0.24	44.79	35.67	45.03	35.91	56.00	46.00	-10.97	-10.09
8	3.465	0.27	42.16	33.34	42.43	33.61	56.00	46.00	-13.57	-12.39
9	4.375	0.32	41.97	33.15	42.29	33.47	56.00	46.00	-13.71	-12.53

- REMARKS:**
1. Q.P. and AV. are abbreviations of quasi-peak and average individually.
 2. The emission levels of other frequencies were very low against the limit.
 3. Margin value = Emission level - Limit value
 4. Correction factor = Insertion loss + Cable loss
 5. Emission Level = Correction Factor + Reading Value.

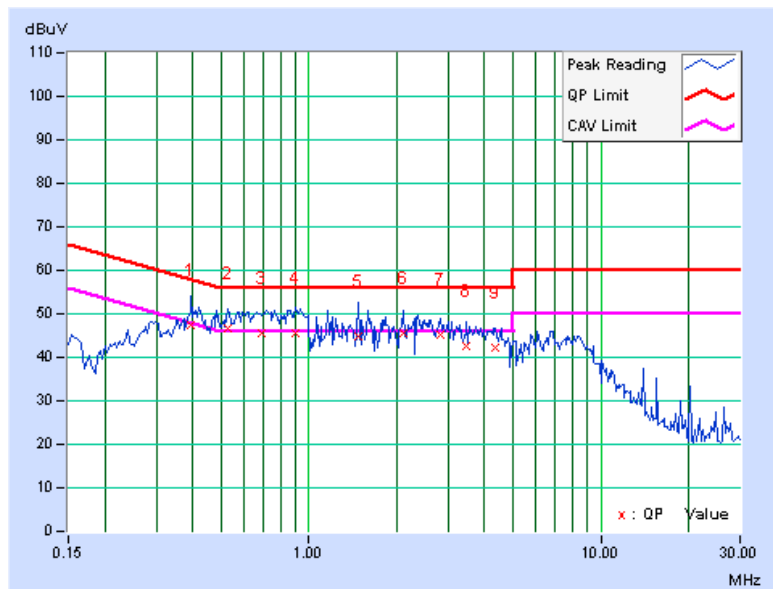

PHASE	Neutral (N)	6dB BANDWIDTH	9 kHz
--------------	-------------	----------------------	-------

No	Freq. [MHz]	Corr. Factor (dB)	Reading Value [dB (uV)]		Emission Level [dB (uV)]		Limit [dB (uV)]		Margin (dB)	
			Q.P.	AV.	Q.P.	AV.	Q.P.	AV.	Q.P.	AV.
			1	0.416	0.09	41.72	30.91	41.81	31.00	57.54
2	0.638	0.10	41.51	31.25	41.61	31.35	56.00	46.00	-14.39	-14.65
3	0.736	0.10	41.99	31.78	42.09	31.88	56.00	46.00	-13.91	-14.12
4	0.931	0.11	42.86	32.22	42.97	32.33	56.00	46.00	-13.03	-13.67
5	1.133	0.12	41.36	31.85	41.48	31.97	56.00	46.00	-14.52	-14.03
6	2.172	0.21	41.59	31.87	41.80	32.08	56.00	46.00	-14.20	-13.92
7	2.516	0.23	41.98	32.13	42.21	32.36	56.00	46.00	-13.79	-13.64
8	8.484	0.50	35.34	26.26	35.84	26.76	60.00	50.00	-24.16	-23.24

- REMARKS:**
1. Q.P. and AV. are abbreviations of quasi-peak and average individually.
 2. The emission levels of other frequencies were very low against the limit.
 3. Margin value = Emission level - Limit value
 4. Correction factor = Insertion loss + Cable loss
 5. Emission Level = Correction Factor + Reading Value.

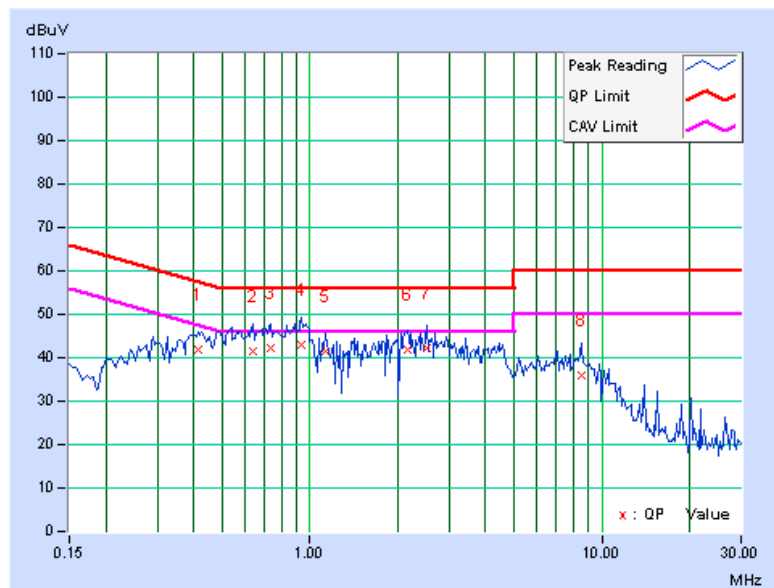

4.2 RADIATED EMISSION MEASUREMENT

4.2.1 LIMITS OF RADIATED EMISSION MEASUREMENT

Emissions radiated outside of the specified bands, shall be according to the general radiated limits in 15.209 as following:

Frequencies (MHz)	Field strength (microvolts/meter)	Measurement distance (meters)
0.009-0.490	2400/F(kHz)	300
0.490-1.705	24000/F(kHz)	30
1.705-30.0	30	30
30-88	100	3
88-216	150	3
216-960	200	3
Above 960	500	3

NOTE:

1. The lower limit shall apply at the transition frequencies.
2. Emission level (dBuV/m) = 20 log Emission level (uV/m).
3. As shown in 15.35(b), for frequencies above 1000MHz, the field strength limits are based on average detector, however, the peak field strength of any emission shall not exceed the maximum permitted average limits, specified above by more than 20dB under any condition of modulation.
4. Section 15.205 restricted bands of operation shall compliance with the limits in Section 15.209.



A D T

4.2.2 TEST INSTRUMENTS

Test date: Sep. 27 to Oct. 01, 2011

DESCRIPTION & MANUFACTURER	MODEL NO.	SERIAL NO.	CALIBRATED DATE	CALIBRATED UNTIL
Agilent Spectrum Analyzer	E4446A	MY48250254	July 12, 2011	July 11, 2012
Agilent Pre-Selector	N9039A	MY46520311	July 12, 2011	July 11, 2012
Agilent Signal Generator	N5181A	MY49060517	July 12, 2011	July 11, 2012
Mini-Circuits Pre-Amplifier	ZFL-1000VH2B	AMP-ZFL-03	Nov. 16, 2010	Nov. 15, 2011
Agilent Pre-Amplifier	8449B	3008A02578	July 04, 2011	July 03, 2012
Miteq Pre-Amplifier	AFS33-1800265 0-30-8P-44	881786	NA	NA
SCHWARZBECK Trilog Broadband Antenna	VULB 9168	9168-360	Apr. 14, 2011	Apr. 13, 2012
AISI Horn_Antenna	AIH.8018	0000320091110	Nov. 12, 2010	Nov. 11, 2011
SCHWARZBECK Horn_Antenna	BBHA 9170	9170-424	Oct. 08, 2010	Oct. 07, 2011
RF CABLE	NA	RF104-201 RF104-203 RF104-204	Dec. 27, 2010	Dec. 26, 2011
RF Cable	NA	CHGCAB_001	NA	NA
Software	ADT_Radiated_V8.7.05	NA	NA	NA
CT Antenna Tower & Turn Table	NA	NA	NA	NA

Note: 1. The calibration interval of the above test instruments is 12 months and the calibrations are traceable to NML/ROC and NIST/USA.

2. The horn antenna, preamplifier (model: 8449B) are used only for the measurement of emission frequency above 1GHz if tested.

3. The test was performed in 966 Chamber No. G.

4. The FCC Site Registration No. is 966073.

5. The VCCI Site Registration No. is G-137.

6. The CANADA Site Registration No. is IC 7450H-2.

4.2.3 TEST PROCEDURES

- a. The EUT was placed on the top of a rotating table 0.8 meters above the ground at 3 meters chamber room. The table was rotated 360 degrees to determine the position of the highest radiation.
- b. The EUT was set 3 meters away from the interference-receiving antenna, which was mounted on the top of a variable-height antenna tower.
- c. The height of antenna is varied from one meter to four meters above the ground to determine the maximum value of the field strength. Both horizontal and vertical polarizations of the antenna are set to make the measurement.
- d. For each suspected emission, the EUT was arranged to its worst case and then the antenna was tuned to heights from 1 meter to 4 meters and the rotatable table was turned from 0 degrees to 360 degrees to find the maximum reading.
- e. The test-receiver system was set to quasi-peak detect function and specified bandwidth with maximum hold mode when the test frequency is below 1 GHz.
- f. The test-receiver system was set to peak and average detect function and specified bandwidth with maximum hold mode when the test frequency is above 1 GHz. If the peak reading value also meets average limit, measurement with the average detector is unnecessary.

NOTE:

1. The resolution bandwidth and video bandwidth of test receiver/spectrum analyzer is 120kHz for Quasi-peak detection (QP) at frequency below 1GHz.
2. The resolution bandwidth of test receiver/spectrum analyzer is 1 MHz and the video bandwidth is 3 MHz for Peak detection (PK) at frequency above 1GHz.
3. The resolution bandwidth of test receiver/spectrum analyzer is 1 MHz and the video bandwidth is 10 Hz for Average detection (AV) at frequency above 1GHz.

4.2.4 DEVIATION FROM TEST STANDARD

No deviation

4.2.5 TEST SETUP

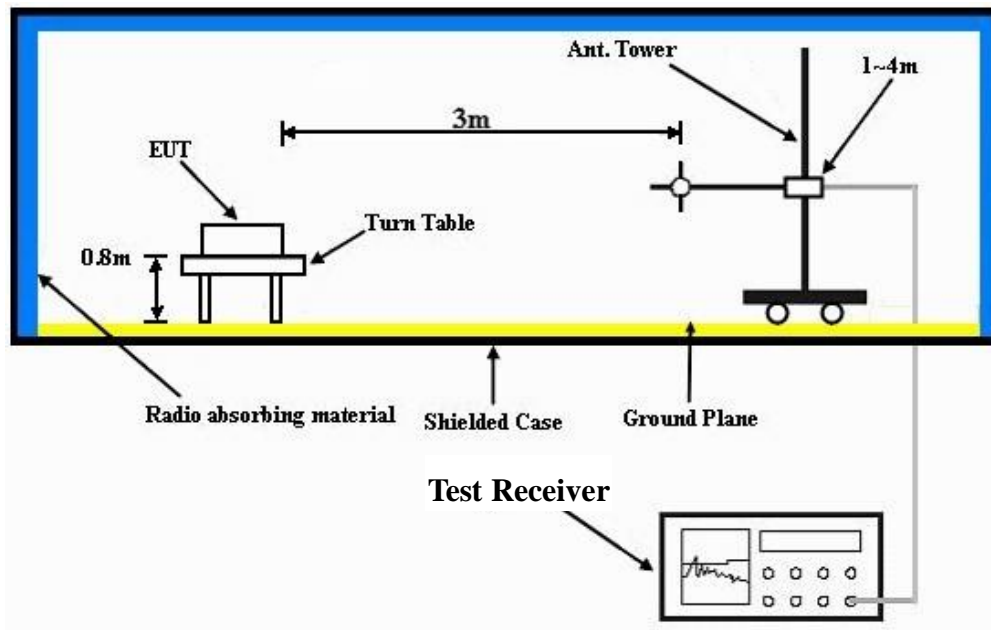

For the actual test configuration, please refer to the related item – Photographs of the Test Configuration.

4.2.6 EUT OPERATING CONDITIONS

Same as 4.1.6



A D T

4.2.7 TEST RESULTS

BELOW 1GHz WORST-CASE DATA : 802.11n (20MHz) OFDM MODULATION

EUT TEST CONDITION		MEASUREMENT DETAIL	
CHANNEL	Channel 1	FREQUENCY RANGE	Below 1000MHz
INPUT POWER	120Vac, 60 Hz	DETECTOR FUNCTION	Quasi-Peak
ENVIRONMENTAL CONDITIONS	27deg. C, 66%RH	TESTED BY	Nelson Teng

ANTENNA POLARITY & TEST DISTANCE: HORIZONTAL AT 3 M								
NO.	FREQ. (MHz)	EMISSION LEVEL (dBuV/m)	LIMIT (dBuV/m)	MARGIN (dB)	ANTENNA HEIGHT (m)	TABLE ANGLE (Degree)	RAW VALUE (dBuV)	CORRECTION FACTOR (dB/m)
1	123.32	30.1 QP	43.5	-13.4	1.25 H	105	17.22	12.92
2	157.42	36.9 QP	43.5	-6.6	1.25 H	261	22.24	14.68
3	270.99	33.4 QP	46.0	-12.6	1.00 H	264	19.38	14.06
4	362.53	38.7 QP	46.0	-7.3	1.00 H	127	22.01	16.73
5	543.72	36.5 QP	46.0	-9.5	1.50 H	30	15.57	20.89
6	799.98	36.6 QP	46.0	-9.4	1.25 H	165	11.41	25.18
ANTENNA POLARITY & TEST DISTANCE: VERTICAL AT 3 M								
NO.	FREQ. (MHz)	EMISSION LEVEL (dBuV/m)	LIMIT (dBuV/m)	MARGIN (dB)	ANTENNA HEIGHT (m)	TABLE ANGLE (Degree)	RAW VALUE (dBuV)	CORRECTION FACTOR (dB/m)
1	47.41	36.8 QP	40.0	-3.2	1.00 V	226	22.42	14.34
2	160.50	35.0 QP	43.5	-8.5	2.00 V	279	20.35	14.62
3	267.91	36.5 QP	46.0	-9.5	1.25 V	4	22.59	13.95
4	362.53	30.1 QP	46.0	-15.9	1.75 V	208	13.36	16.73
5	550.70	33.9 QP	46.0	-12.1	1.25 V	170	12.82	21.05
6	799.98	31.5 QP	46.0	-14.5	1.25 V	37	6.33	25.18

- REMARKS:**
1. Emission level (dBuV/m) = Raw Value (dBuV) + Correction Factor (dB/m).
 2. Correction Factor (dB/m) = Antenna Factor (dB/m) + Cable Factor (dB).
 3. The other emission levels were very low against the limit.
 4. Margin value = Emission level – Limit value.



A D T

ABOVE 1GHz WORST-CASE DATA

802.11b DSSS MODULATION

EUT TEST CONDITION		MEASUREMENT DETAIL	
CHANNEL	Channel 1	FREQUENCY RANGE	1 ~ 25GHz
INPUT POWER	120Vac, 60 Hz	DETECTOR FUNCTION	Peak (PK) Average (AV)
ENVIRONMENTAL CONDITIONS	22deg. C, 71%RH	TESTED BY	Rex Huang

ANTENNA POLARITY & TEST DISTANCE: HORIZONTAL AT 3 M

NO.	FREQ. (MHz)	EMISSION LEVEL (dBuV/m)	LIMIT (dBuV/m)	MARGIN (dB)	ANTENNA HEIGHT (m)	TABLE ANGLE (Degree)	RAW VALUE (dBuV)	CORRECTION FACTOR (dB/m)
1	2390.00	57.2 PK	74.0	-16.8	1.00 H	110	25.45	31.75
2	2390.00	44.6 AV	54.0	-9.4	1.00 H	110	12.85	31.75
3	*2412.00	105.7 PK			1.00 H	111	73.88	31.82
4	*2412.00	103.5 AV			1.00 H	111	71.68	31.82
5	4824.00	50.3 PK	74.0	-23.7	1.05 H	111	10.94	39.36
6	4824.00	42.6 AV	54.0	-11.4	1.05 H	111	3.24	39.36

ANTENNA POLARITY & TEST DISTANCE: VERTICAL AT 3 M

NO.	FREQ. (MHz)	EMISSION LEVEL (dBuV/m)	LIMIT (dBuV/m)	MARGIN (dB)	ANTENNA HEIGHT (m)	TABLE ANGLE (Degree)	RAW VALUE (dBuV)	CORRECTION FACTOR (dB/m)
1	2390.00	56.4 PK	74.0	-17.6	1.00 V	116	24.65	31.75
2	2390.00	43.9 AV	54.0	-10.1	1.00 V	116	12.15	31.75
3	*2412.00	97.4 PK			1.00 V	117	65.58	31.82
4	*2412.00	95.0 AV			1.00 V	117	63.18	31.82
5	4824.00	55.6 PK	74.0	-18.4	1.10 V	295	16.24	39.36
6	4824.00	52.7 AV	54.0	-1.3	1.10 V	295	13.34	39.36

- REMARKS:**
1. Emission level (dBuV/m) = Raw Value (dBuV) + Correction Factor (dB/m).
 2. Correction Factor (dB/m) = Antenna Factor (dB/m) + Cable Factor (dB).
 3. The other emission levels were very low against the limit.
 4. Margin value = Emission level – Limit value.
 5. “ * “: Fundamental frequency.



A D T

EUT TEST CONDITION		MEASUREMENT DETAIL	
CHANNEL	Channel 6	FREQUENCY RANGE	1 ~ 25GHz
INPUT POWER	120Vac, 60 Hz	DETECTOR FUNCTION	Peak (PK) Average (AV)
ENVIRONMENTAL CONDITIONS	22deg. C, 71%RH	TESTED BY	Rex Huang

ANTENNA POLARITY & TEST DISTANCE: HORIZONTAL AT 3 M								
NO.	FREQ. (MHz)	EMISSION LEVEL (dBuV/m)	LIMIT (dBuV/m)	MARGIN (dB)	ANTENNA HEIGHT (m)	TABLE ANGLE (Degree)	RAW VALUE (dBuV)	CORRECTION FACTOR (dB/m)
1	*2437.00	106.7 PK			1.00 H	110	74.78	31.92
2	*2437.00	104.7 AV			1.00 H	110	72.78	31.92
3	4874.00	51.9 PK	74.0	-22.1	1.00 H	111	12.40	39.50
4	4874.00	48.2 AV	54.0	-5.8	1.00 H	111	8.70	39.50
5	7311.00	54.4 PK	74.0	-19.6	1.00 H	113	7.52	46.88
6	7311.00	44.3 AV	54.0	-9.7	1.00 H	113	-2.58	46.88
ANTENNA POLARITY & TEST DISTANCE: VERTICAL AT 3 M								
NO.	FREQ. (MHz)	EMISSION LEVEL (dBuV/m)	LIMIT (dBuV/m)	MARGIN (dB)	ANTENNA HEIGHT (m)	TABLE ANGLE (Degree)	RAW VALUE (dBuV)	CORRECTION FACTOR (dB/m)
1	*2437.00	98.1 PK			1.00 V	116	66.18	31.92
2	*2437.00	95.8 AV			1.00 V	116	63.88	31.92
3	4874.00	56.2 PK	74.0	-17.8	1.06 V	275	16.70	39.50
4	4874.00	53.4 AV	54.0	-0.6	1.06 V	275	13.90	39.50
5	7311.00	55.4 PK	74.0	-18.6	1.22 V	328	8.52	46.88
6	7311.00	46.6 AV	54.0	-7.4	1.22 V	328	-0.28	46.88

- REMARKS:**
1. Emission level (dBuV/m) = Raw Value (dBuV) + Correction Factor (dB/m).
 2. Correction Factor (dB/m) = Antenna Factor (dB/m) + Cable Factor (dB).
 3. The other emission levels were very low against the limit.
 4. Margin value = Emission level – Limit value.
 5. “ * “: Fundamental frequency.



A D T

EUT TEST CONDITION		MEASUREMENT DETAIL	
CHANNEL	Channel 11	FREQUENCY RANGE	1 ~ 25GHz
INPUT POWER	120Vac, 60 Hz	DETECTOR FUNCTION	Peak (PK) Average (AV)
ENVIRONMENTAL CONDITIONS	22deg. C, 71%RH	TESTED BY	Rex Huang

ANTENNA POLARITY & TEST DISTANCE: HORIZONTAL AT 3 M

NO.	FREQ. (MHz)	EMISSION LEVEL (dBuV/m)	LIMIT (dBuV/m)	MARGIN (dB)	ANTENNA HEIGHT (m)	TABLE ANGLE (Degree)	RAW VALUE (dBuV)	CORRECTION FACTOR (dB/m)
1	*2462.00	107.7 PK			1.00 H	110	75.69	32.01
2	*2462.00	105.6 AV			1.00 H	110	73.59	32.01
3	2483.50	58.1 PK	74.0	-15.9	1.00 H	110	26.01	32.09
4	2483.50	47.2 AV	54.0	-6.8	1.00 H	110	15.11	32.09
5	4924.00	52.4 PK	74.0	-21.6	1.00 H	111	12.73	39.67
6	4924.00	48.8 AV	54.0	-5.2	1.00 H	111	9.13	39.67
7	7386.00	54.6 PK	74.0	-19.4	1.00 H	115	7.80	46.80
8	7386.00	44.1 AV	54.0	-9.9	1.00 H	115	-2.70	46.80

ANTENNA POLARITY & TEST DISTANCE: VERTICAL AT 3 M

NO.	FREQ. (MHz)	EMISSION LEVEL (dBuV/m)	LIMIT (dBuV/m)	MARGIN (dB)	ANTENNA HEIGHT (m)	TABLE ANGLE (Degree)	RAW VALUE (dBuV)	CORRECTION FACTOR (dB/m)
1	*2462.00	98.1 PK			1.00 V	117	66.09	32.01
2	*2462.00	95.7 AV			1.00 V	117	63.69	32.01
3	2483.50	56.0 PK	74.0	-18.0	1.00 V	116	23.91	32.09
4	2483.50	43.8 AV	54.0	-10.2	1.00 V	116	11.71	32.09
5	4924.00	55.0 PK	74.0	-19.0	1.03 V	297	15.33	39.67
6	4924.00	52.1 AV	54.0	-1.9	1.03 V	297	12.43	39.67
7	7386.00	55.2 PK	74.0	-18.8	1.22 V	329	8.40	46.80
8	7386.00	45.4 AV	54.0	-8.6	1.22 V	329	-1.40	46.80

- REMARKS:**
1. Emission level (dBuV/m) = Raw Value (dBuV) + Correction Factor (dB/m).
 2. Correction Factor (dB/m) = Antenna Factor (dB/m) + Cable Factor (dB).
 3. The other emission levels were very low against the limit.
 4. Margin value = Emission level – Limit value.
 5. “ * “: Fundamental frequency.



A D T

RESTRICTED BANDEDGE (802.11b MODE, CH1, HORIZONTAL)

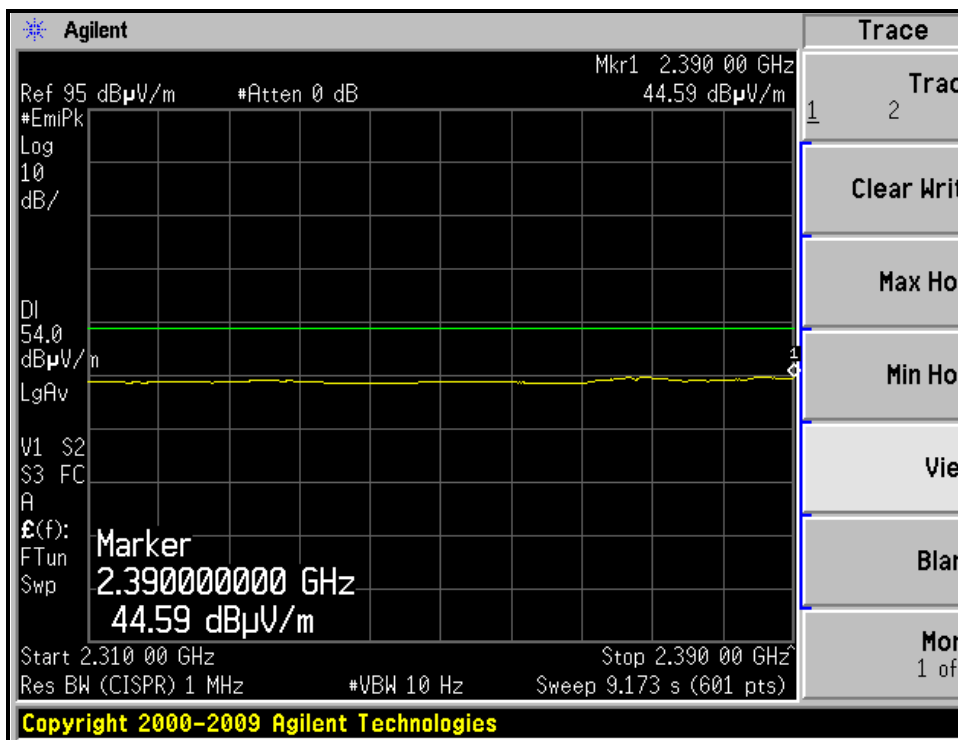
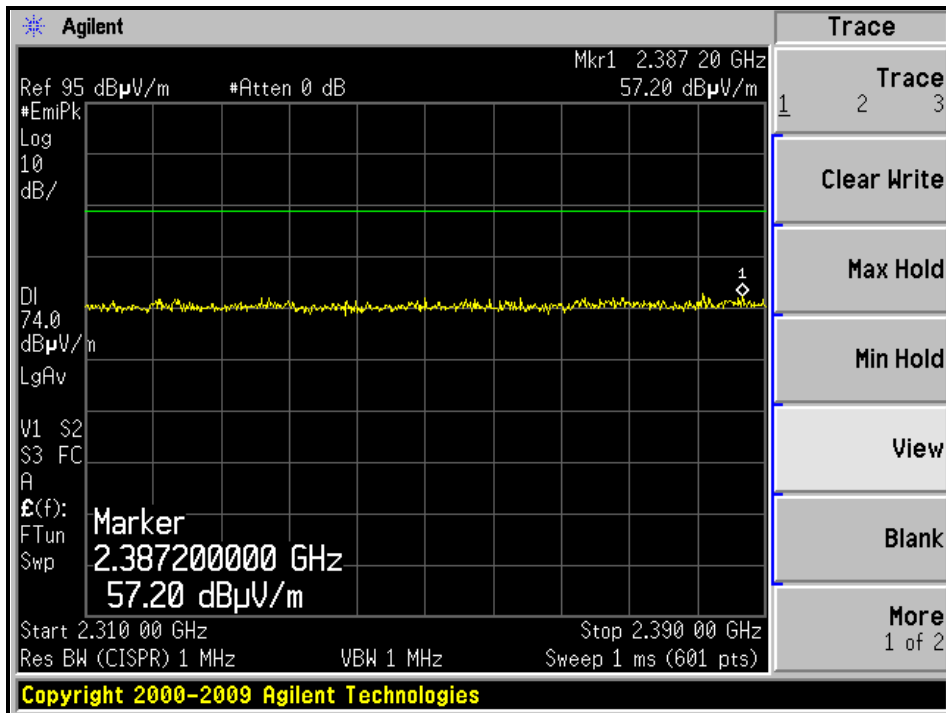



A D T

RESTRICTED BANDEDGE (802.11b MODE, CH1, VERTICAL)

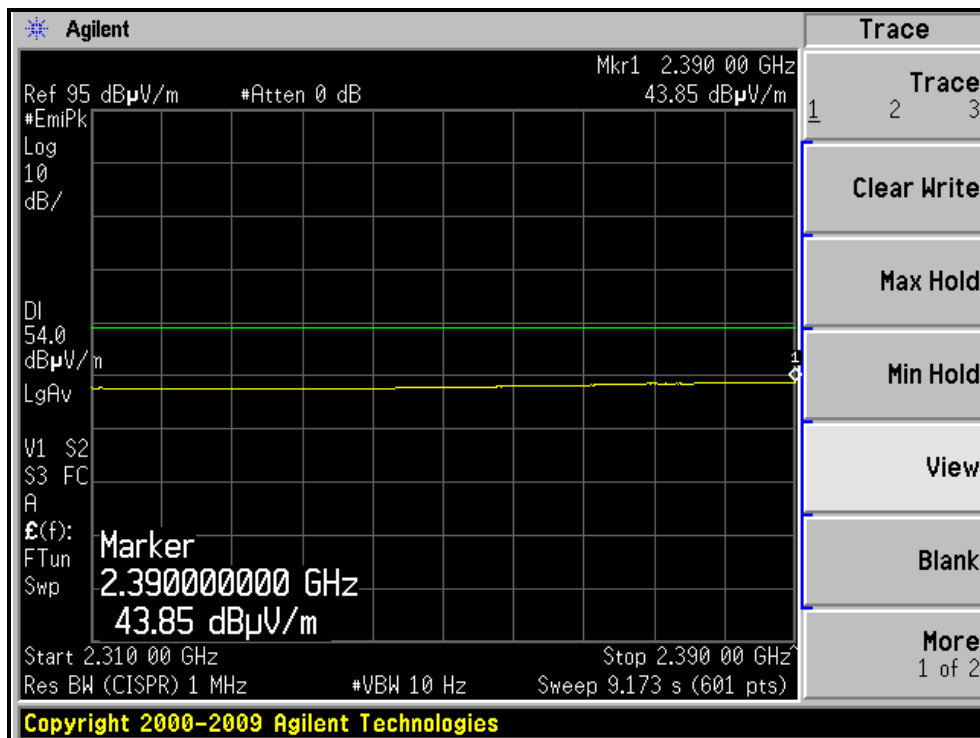
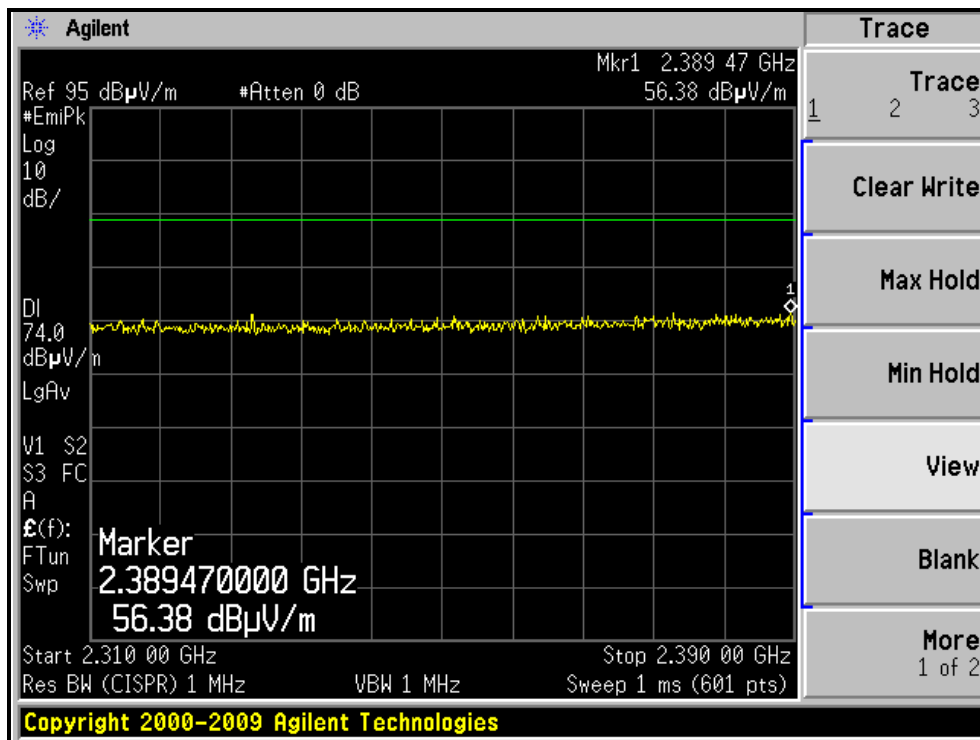

RESTRICTED BANDEDGE (802.11b MODE, CH11, HORIZONTAL)

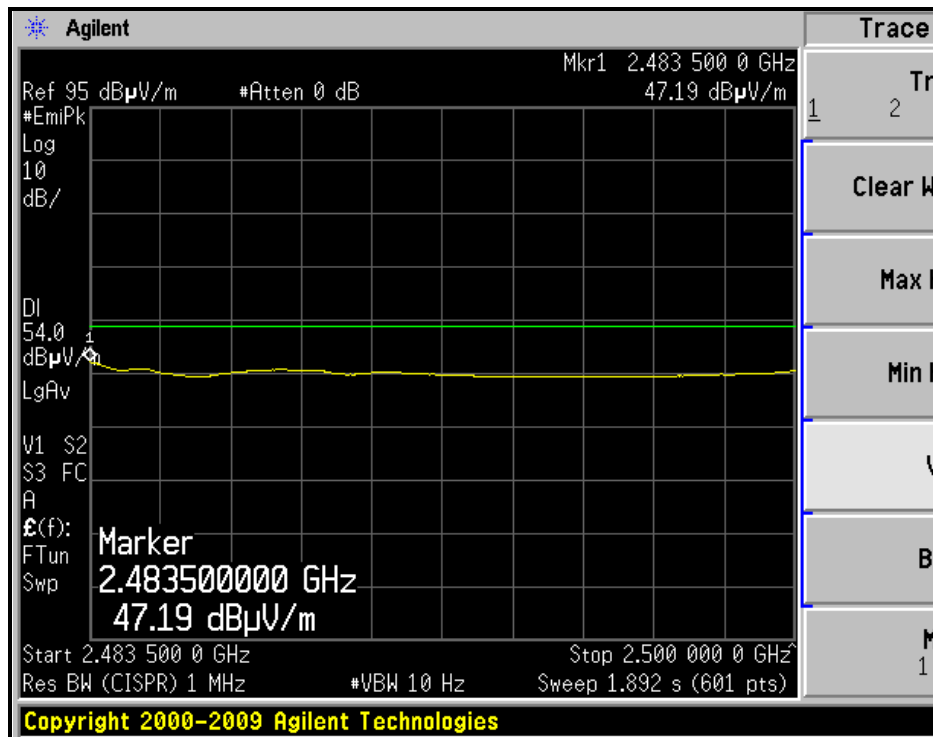
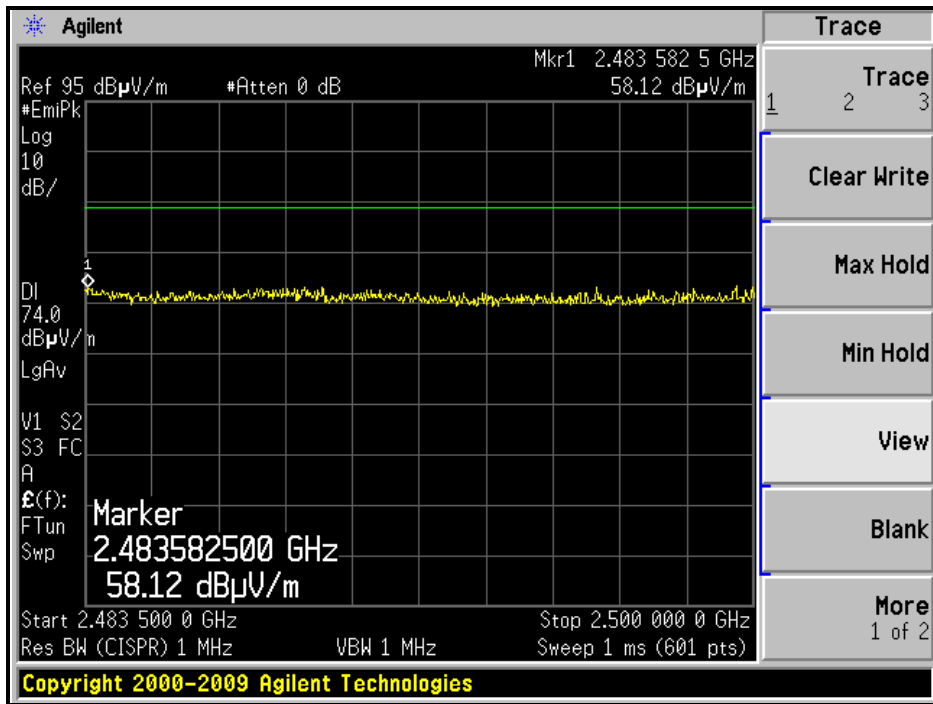

RESTRICTED BANDEDGE (802.11b MODE, CH11, VERTICAL)

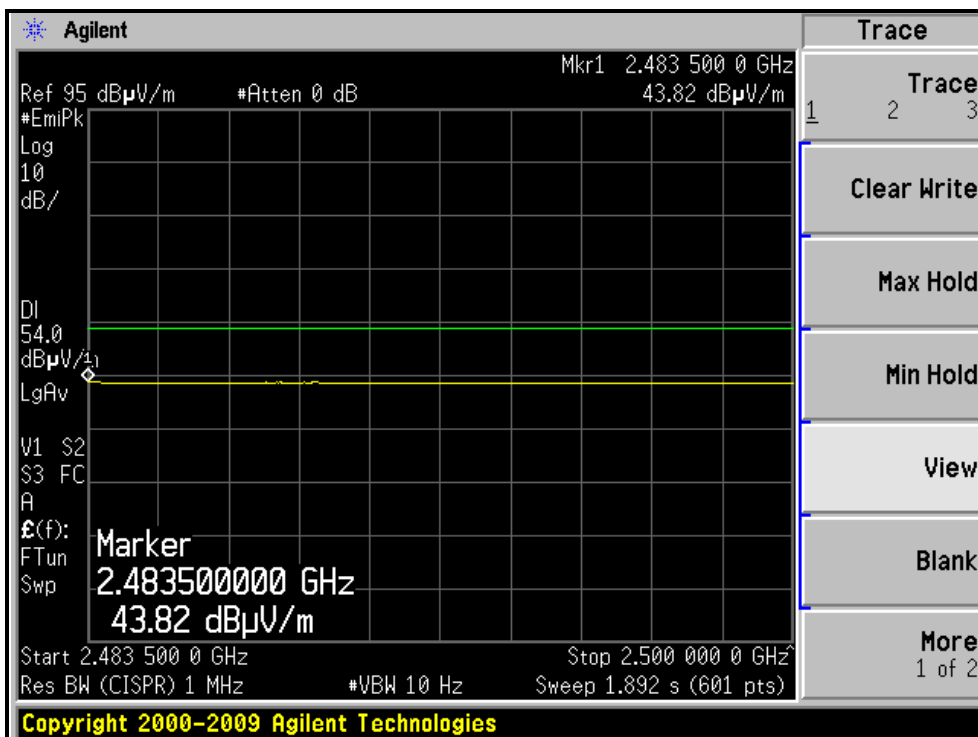
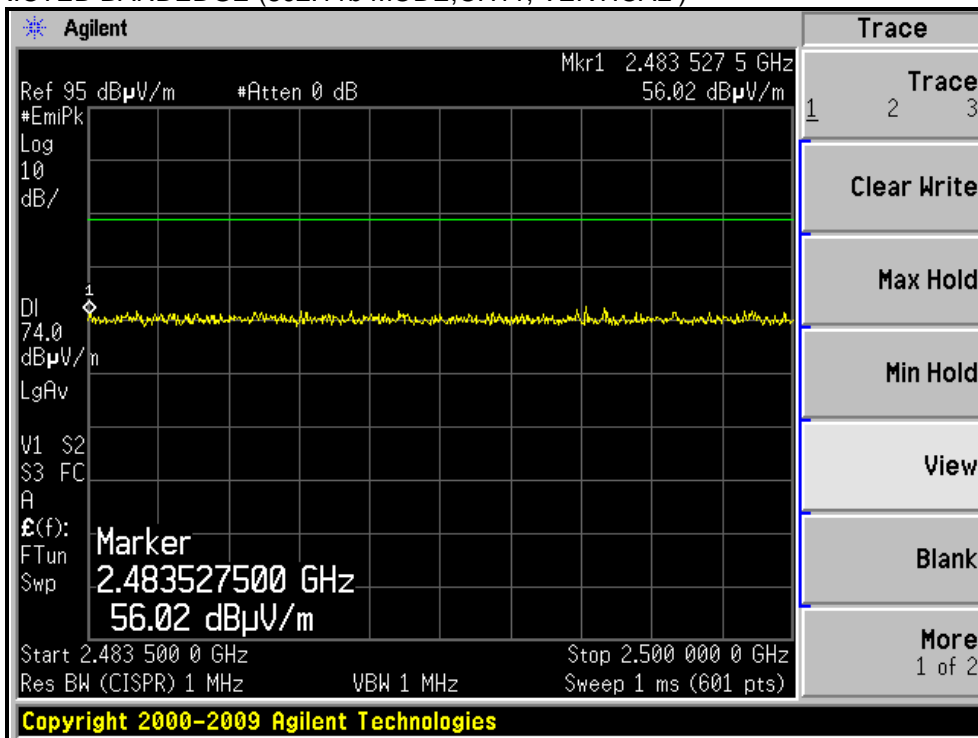



A D T

802.11g OFDM MODULATION

EUT TEST CONDITION		MEASUREMENT DETAIL	
CHANNEL	Channel 1	FREQUENCY RANGE	1 ~ 25GHz
INPUT POWER	120Vac, 60 Hz	DETECTOR FUNCTION	Peak (PK) Average (AV)
ENVIRONMENTAL CONDITIONS	22deg. C, 71%RH	TESTED BY	Rex Huang

ANTENNA POLARITY & TEST DISTANCE: HORIZONTAL AT 3 M

NO.	FREQ. (MHz)	EMISSION LEVEL (dBuV/m)	LIMIT (dBuV/m)	MARGIN (dB)	ANTENNA HEIGHT (m)	TABLE ANGLE (Degree)	RAW VALUE (dBuV)	CORRECTION FACTOR (dB/m)
1	2390.00	64.6 PK	74.0	-9.4	1.00 H	112	32.85	31.75
2	2390.00	49 AV	54.0	-5.0	1.00 H	112	17.25	31.75
3	*2412.00	107.6 PK			1.00 H	112	75.78	31.82
4	*2412.00	98.8 AV			1.00 H	112	66.98	31.82
5	4824.00	50.9 PK	74.0	-23.1	1.00 H	109	11.54	39.36
6	4824.00	38.5 AV	54.0	-15.5	1.00 H	109	-0.86	39.36

ANTENNA POLARITY & TEST DISTANCE: VERTICAL AT 3 M

NO.	FREQ. (MHz)	EMISSION LEVEL (dBuV/m)	LIMIT (dBuV/m)	MARGIN (dB)	ANTENNA HEIGHT (m)	TABLE ANGLE (Degree)	RAW VALUE (dBuV)	CORRECTION FACTOR (dB/m)
1	2390.00	57.2 PK	74.0	-16.8	1.00 V	117	25.45	31.75
2	2390.00	44.6 AV	54.0	-9.4	1.00 V	117	12.85	31.75
3	*2412.00	98.7 PK			1.00 V	117	66.88	31.82
4	*2412.00	89.8 AV			1.00 V	117	57.98	31.82
5	4824.00	56.8 PK	74.0	-17.2	1.07 V	298	17.44	39.36
6	4824.00	43.9 AV	54.0	-10.1	1.07 V	298	4.54	39.36

- REMARKS:**
1. Emission level (dBuV/m) = Raw Value (dBuV) + Correction Factor (dB/m).
 2. Correction Factor (dB/m) = Antenna Factor (dB/m) + Cable Factor (dB).
 3. The other emission levels were very low against the limit.
 4. Margin value = Emission level – Limit value.
 5. “ * “: Fundamental frequency.



A D T

EUT TEST CONDITION		MEASUREMENT DETAIL	
CHANNEL	Channel 6	FREQUENCY RANGE	1 ~ 25GHz
INPUT POWER	120Vac, 60 Hz	DETECTOR FUNCTION	Peak (PK) Average (AV)
ENVIRONMENTAL CONDITIONS	22deg. C, 71%RH	TESTED BY	Rex Huang

ANTENNA POLARITY & TEST DISTANCE: HORIZONTAL AT 3 M

NO.	FREQ. (MHz)	EMISSION LEVEL (dBuV/m)	LIMIT (dBuV/m)	MARGIN (dB)	ANTENNA HEIGHT (m)	TABLE ANGLE (Degree)	RAW VALUE (dBuV)	CORRECTION FACTOR (dB/m)
1	*2437.00	108.1 PK			1.00 H	110	76.18	31.92
2	*2437.00	99.2 AV			1.00 H	110	67.28	31.92
3	4874.00	53.2 PK	74.0	-20.8	1.00 H	110	13.70	39.50
4	4874.00	40.2 AV	54.0	-13.8	1.00 H	110	0.70	39.50
5	7311.00	55.6 PK	74.0	-18.4	1.00 H	114	8.72	46.88
6	7311.00	42.7 AV	54.0	-11.3	1.00 H	114	-4.18	46.88

ANTENNA POLARITY & TEST DISTANCE: VERTICAL AT 3 M

NO.	FREQ. (MHz)	EMISSION LEVEL (dBuV/m)	LIMIT (dBuV/m)	MARGIN (dB)	ANTENNA HEIGHT (m)	TABLE ANGLE (Degree)	RAW VALUE (dBuV)	CORRECTION FACTOR (dB/m)
1	*2437.00	99.0 PK			1.00 V	117	67.08	31.92
2	*2437.00	90.0 AV			1.00 V	117	58.08	31.92
3	4874.00	54.5 PK	74.0	-19.5	1.06 V	296	15.00	39.50
4	4874.00	43.3 AV	54.0	-10.7	1.06 V	296	3.80	39.50
5	7311.00	55.2 PK	74.0	-18.8	1.00 V	338	8.32	46.88
6	7311.00	42.5 AV	54.0	-11.5	1.00 V	338	-4.38	46.88

- REMARKS:**
1. Emission level (dBuV/m) = Raw Value (dBuV) + Correction Factor (dB/m).
 2. Correction Factor (dB/m) = Antenna Factor (dB/m) + Cable Factor (dB).
 3. The other emission levels were very low against the limit.
 4. Margin value = Emission level – Limit value.
 5. “ * ”: Fundamental frequency.



A D T

EUT TEST CONDITION		MEASUREMENT DETAIL	
CHANNEL	Channel 11	FREQUENCY RANGE	1 ~ 25GHz
INPUT POWER	120Vac, 60 Hz	DETECTOR FUNCTION	Peak (PK) Average (AV)
ENVIRONMENTAL CONDITIONS	22deg. C, 71%RH	TESTED BY	Rex Huang

ANTENNA POLARITY & TEST DISTANCE: HORIZONTAL AT 3 M

NO.	FREQ. (MHz)	EMISSION LEVEL (dBuV/m)	LIMIT (dBuV/m)	MARGIN (dB)	ANTENNA HEIGHT (m)	TABLE ANGLE (Degree)	RAW VALUE (dBuV)	CORRECTION FACTOR (dB/m)
1	*2462.00	108.0 PK			1.00 H	109	75.99	32.01
2	*2462.00	99.0 AV			1.00 H	109	66.99	32.01
3	2483.50	63.3 PK	74.0	-10.7	1.00 H	108	31.21	32.09
4	2483.50	48.5 AV	54.0	-5.5	1.00 H	108	16.41	32.09
5	4924.00	49.6 PK	74.0	-24.4	1.00 H	109	9.93	39.67
6	4924.00	37.6 AV	54.0	-16.4	1.00 H	109	-2.07	39.67
7	7386.00	53.7 PK	74.0	-20.3	1.00 H	103	6.90	46.80
8	7386.00	40.9 AV	54.0	-13.1	1.00 H	103	-5.90	46.80

ANTENNA POLARITY & TEST DISTANCE: VERTICAL AT 3 M

NO.	FREQ. (MHz)	EMISSION LEVEL (dBuV/m)	LIMIT (dBuV/m)	MARGIN (dB)	ANTENNA HEIGHT (m)	TABLE ANGLE (Degree)	RAW VALUE (dBuV)	CORRECTION FACTOR (dB/m)
1	*2462.00	97.9 PK			1.00 V	116	65.89	32.01
2	*2462.00	89.3 AV			1.00 V	116	57.29	32.01
3	2483.50	58.2 PK	74.0	-15.8	1.00 V	115	26.11	32.09
4	2483.50	44.3 AV	54.0	-9.7	1.00 V	115	12.21	32.09
5	4924.00	51.2 PK	74.0	-22.8	1.06 V	294	11.53	39.67
6	4924.00	40.6 AV	54.0	-13.4	1.06 V	294	0.93	39.67
7	7386.00	54.6 PK	74.0	-19.4	1.09 V	341	7.80	46.80
8	7386.00	41.7 AV	54.0	-12.3	1.09 V	341	-5.10	46.80

- REMARKS:**
1. Emission level (dBuV/m) = Raw Value (dBuV) + Correction Factor (dB/m).
 2. Correction Factor (dB/m) = Antenna Factor (dB/m) + Cable Factor (dB).
 3. The other emission levels were very low against the limit.
 4. Margin value = Emission level – Limit value.
 5. “ * “: Fundamental frequency.



A D T

RESTRICTED BANDEDGE (802.11g MODE, CH1, HORIZONTAL)

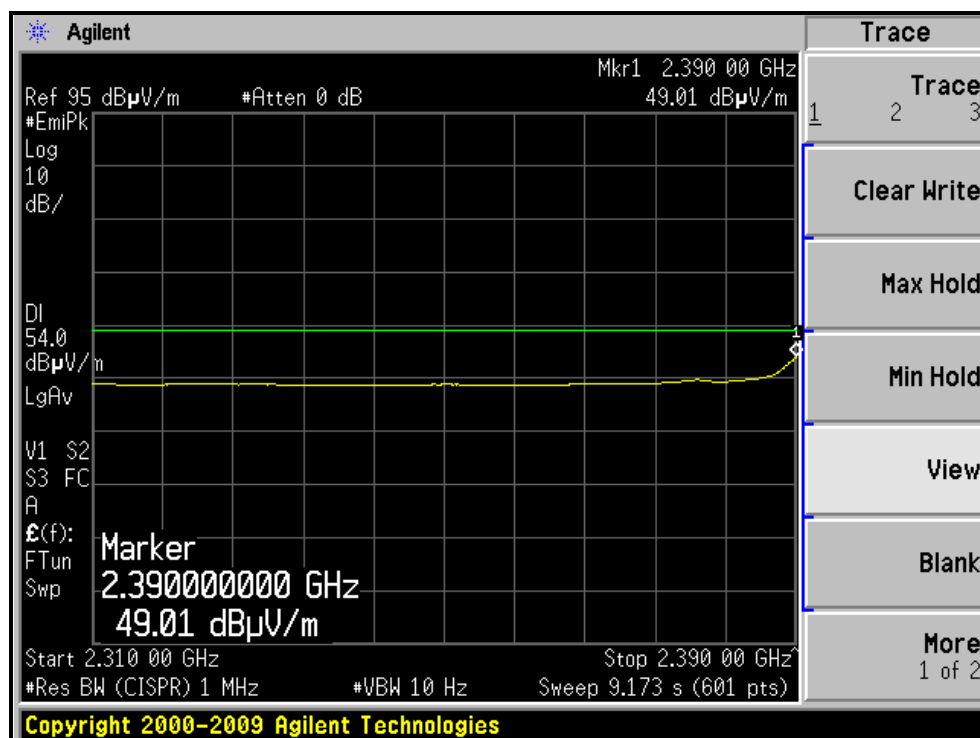
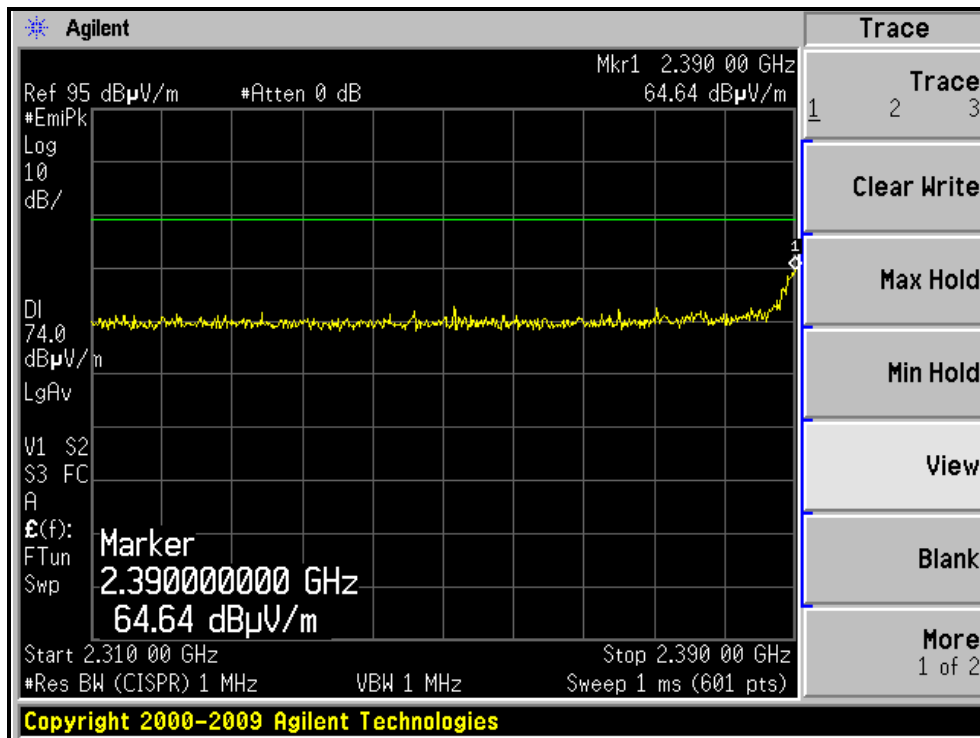



A D T

RESTRICTED BANDEDGE (802.11g MODE,CH1, VERTICAL)

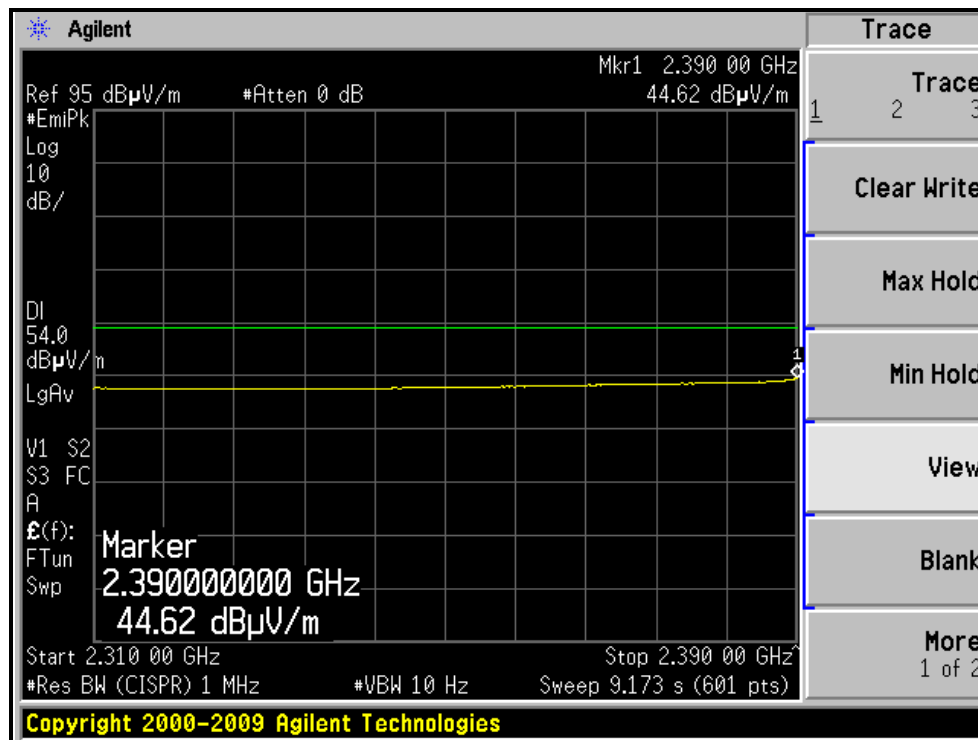
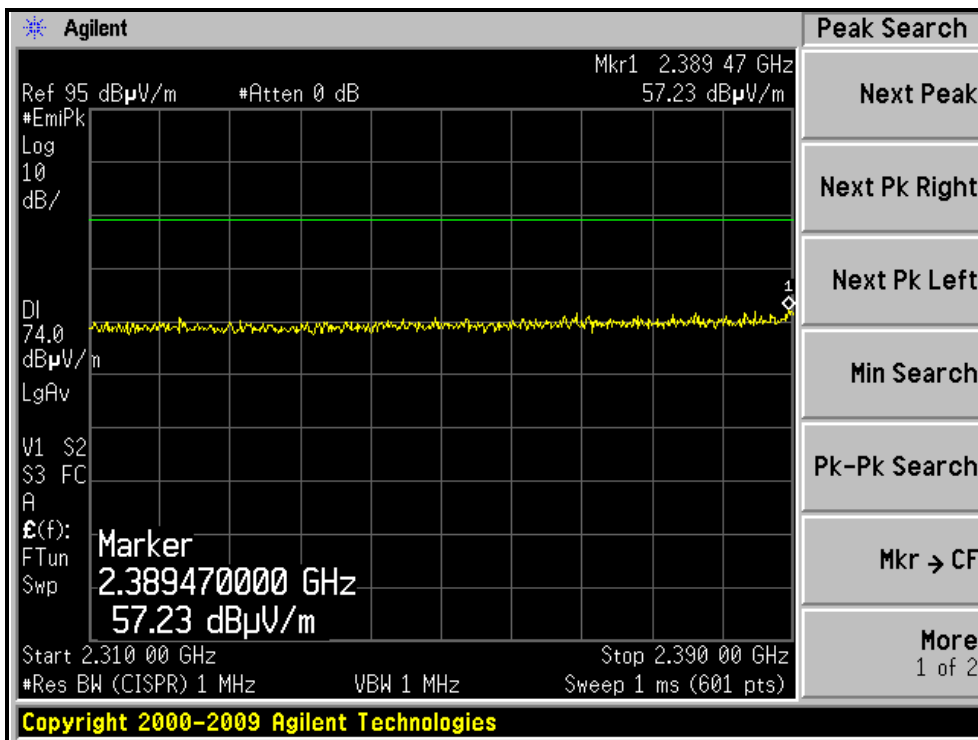



A D T

RESTRICTED BANDEDGE (802.11g MODE, CH11, HORIZONTAL)

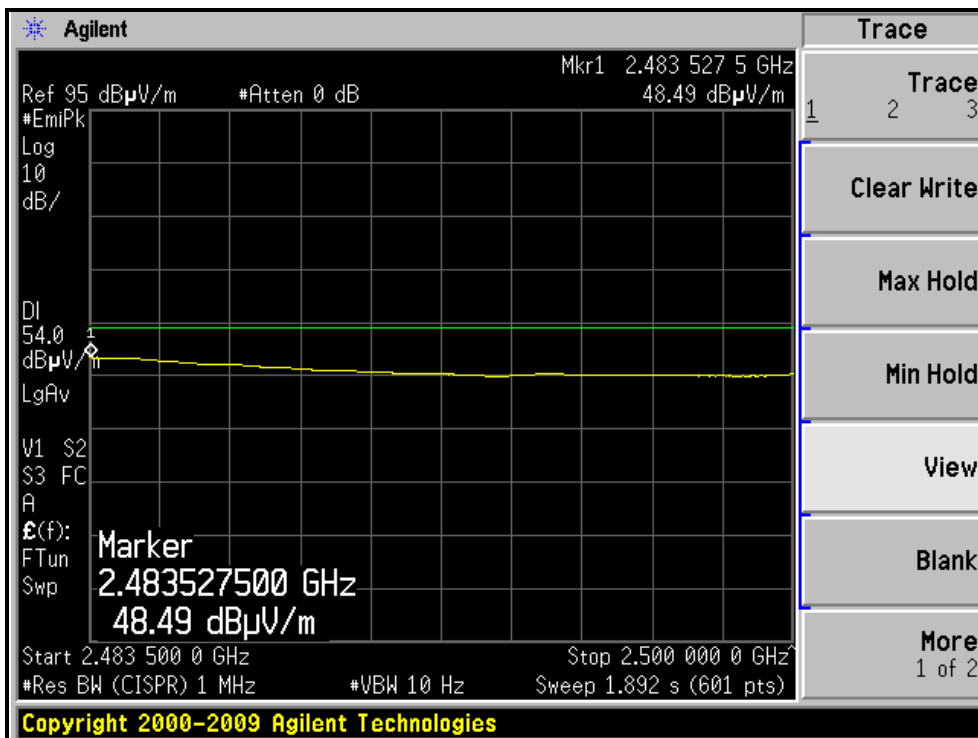
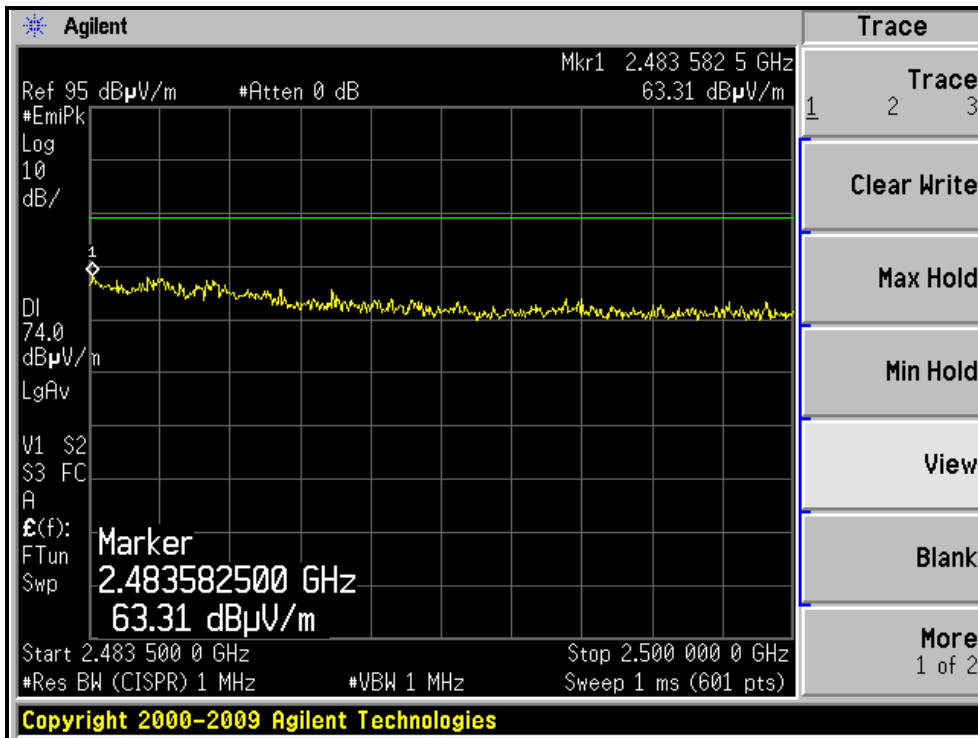

RESTRICTED BANDEDGE (802.11g MODE,CH11, VERTICAL)

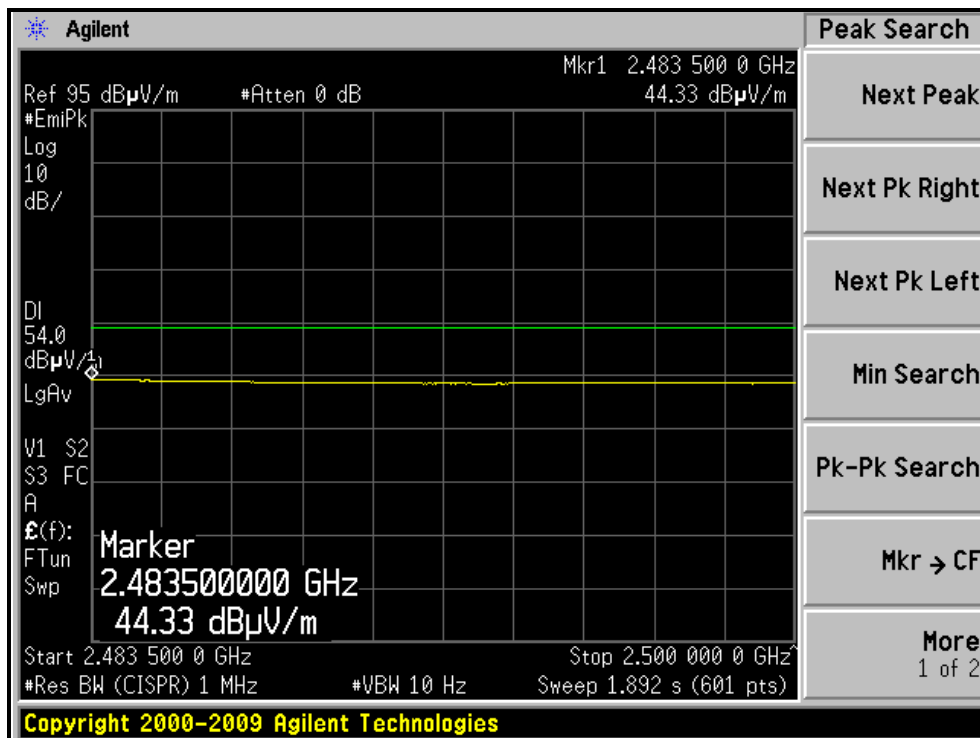
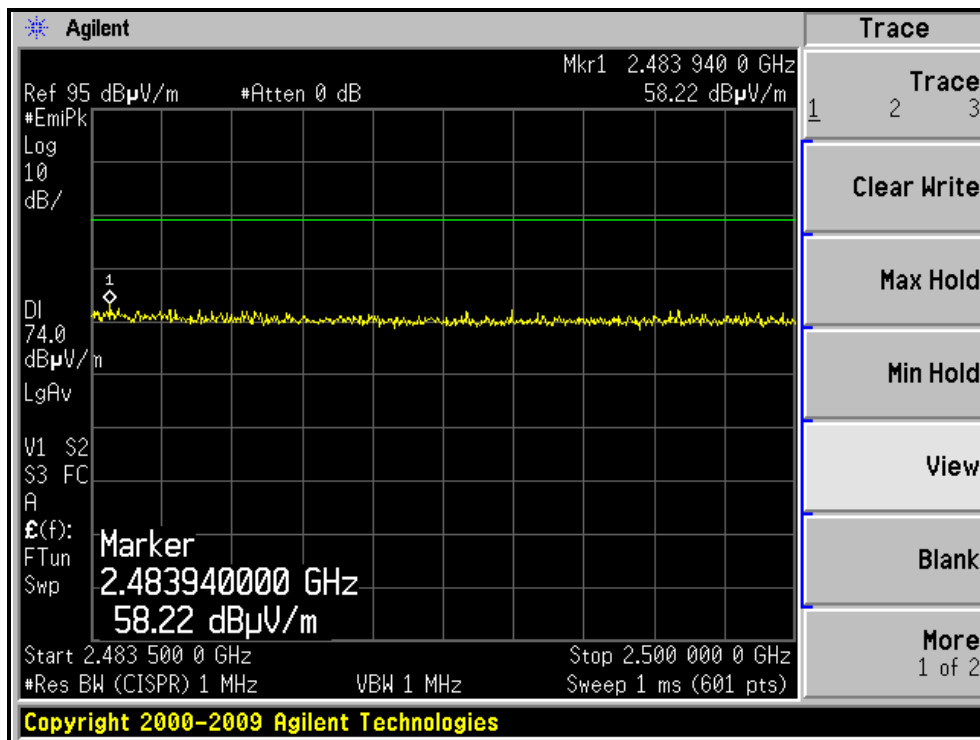



A D T

802.11n (20MHz) OFDM MODULATION

EUT TEST CONDITION		MEASUREMENT DETAIL	
CHANNEL	Channel 1	FREQUENCY RANGE	1 ~ 25GHz
INPUT POWER	120Vac, 60 Hz	DETECTOR FUNCTION	Peak (PK) Average (AV)
ENVIRONMENTAL CONDITIONS	22deg. C, 71%RH	TESTED BY	Rex Huang

ANTENNA POLARITY & TEST DISTANCE: HORIZONTAL AT 3 M

NO.	FREQ. (MHz)	EMISSION LEVEL (dBuV/m)	LIMIT (dBuV/m)	MARGIN (dB)	ANTENNA HEIGHT (m)	TABLE ANGLE (Degree)	RAW VALUE (dBuV)	CORRECTION FACTOR (dB/m)
1	2390.00	60.9 PK	74.0	-13.1	1.00 H	112	29.15	31.75
2	2390.00	47.5 AV	54.0	-6.5	1.00 H	112	15.75	31.75
3	*2412.00	109.4 PK			1.00 H	110	77.58	31.82
4	*2412.00	98.7 AV			1.00 H	110	66.88	31.82
5	4824.00	49.1 PK	74.0	-24.9	1.00 H	110	9.74	39.36
6	4824.00	37.4 AV	54.0	-16.6	1.00 H	110	-1.96	39.36

ANTENNA POLARITY & TEST DISTANCE: VERTICAL AT 3 M

NO.	FREQ. (MHz)	EMISSION LEVEL (dBuV/m)	LIMIT (dBuV/m)	MARGIN (dB)	ANTENNA HEIGHT (m)	TABLE ANGLE (Degree)	RAW VALUE (dBuV)	CORRECTION FACTOR (dB/m)
1	2390.00	56.9 PK	74.0	-17.1	1.00 V	34	25.15	31.75
2	2390.00	44.7 AV	54.0	-9.3	1.00 V	34	12.95	31.75
3	*2412.00	102.6 PK			1.00 V	33	70.78	31.82
4	*2412.00	92.2 AV			1.00 V	33	60.38	31.82
5	4824.00	51.9 PK	74.0	-22.1	1.00 V	246	12.54	39.36
6	4824.00	39.9 AV	54.0	-14.1	1.00 V	246	0.54	39.36

- REMARKS:**
1. Emission level (dBuV/m) = Raw Value (dBuV) + Correction Factor (dB/m).
 2. Correction Factor (dB/m) = Antenna Factor (dB/m) + Cable Factor (dB).
 3. The other emission levels were very low against the limit.
 4. Margin value = Emission level – Limit value.
 5. “ * “: Fundamental frequency.



A D T

EUT TEST CONDITION		MEASUREMENT DETAIL	
CHANNEL	Channel 6	FREQUENCY RANGE	1 ~ 25GHz
INPUT POWER	120Vac, 60 Hz	DETECTOR FUNCTION	Peak (PK) Average (AV)
ENVIRONMENTAL CONDITIONS	22deg. C, 71%RH	TESTED BY	Rex Huang

ANTENNA POLARITY & TEST DISTANCE: HORIZONTAL AT 3 M								
NO.	FREQ. (MHz)	EMISSION LEVEL (dBuV/m)	LIMIT (dBuV/m)	MARGIN (dB)	ANTENNA HEIGHT (m)	TABLE ANGLE (Degree)	RAW VALUE (dBuV)	CORRECTION FACTOR (dB/m)
1	*2437.00	109.4 PK			1.00 H	109	77.48	31.92
2	*2437.00	98.9 AV			1.00 H	109	66.98	31.92
3	4874.00	49.6 PK	74.0	-24.4	1.00 H	112	10.10	39.50
4	4874.00	37.5 AV	54.0	-16.5	1.00 H	112	-2.00	39.50
5	7311.00	54.1 PK	74.0	-19.9	1.00 H	80	7.22	46.88
6	7311.00	40.9 AV	54.0	-13.1	1.00 H	80	-5.98	46.88
ANTENNA POLARITY & TEST DISTANCE: VERTICAL AT 3 M								
NO.	FREQ. (MHz)	EMISSION LEVEL (dBuV/m)	LIMIT (dBuV/m)	MARGIN (dB)	ANTENNA HEIGHT (m)	TABLE ANGLE (Degree)	RAW VALUE (dBuV)	CORRECTION FACTOR (dB/m)
1	*2437.00	103.5 PK			1.00 V	34	71.58	31.92
2	*2437.00	92.7 AV			1.00 V	34	60.78	31.92
3	4874.00	51.2 PK	74.0	-22.8	1.00 V	245	11.70	39.50
4	4874.00	40.0 AV	54.0	-14.0	1.00 V	245	0.50	39.50
5	7311.00	53.6 PK	74.0	-20.4	1.00 V	340	6.72	46.88
6	7311.00	40.6 AV	54.0	-13.4	1.00 V	340	-6.28	46.88

- REMARKS:**
1. Emission level (dBuV/m) = Raw Value (dBuV) + Correction Factor (dB/m).
 2. Correction Factor (dB/m) = Antenna Factor (dB/m) + Cable Factor (dB).
 3. The other emission levels were very low against the limit.
 4. Margin value = Emission level – Limit value.
 5. “ * “: Fundamental frequency.



A D T

EUT TEST CONDITION		MEASUREMENT DETAIL	
CHANNEL	Channel 11	FREQUENCY RANGE	1 ~ 25GHz
INPUT POWER	120Vac, 60 Hz	DETECTOR FUNCTION	Peak (PK) Average (AV)
ENVIRONMENTAL CONDITIONS	22deg. C, 71%RH	TESTED BY	Rex Huang

ANTENNA POLARITY & TEST DISTANCE: HORIZONTAL AT 3 M

NO.	FREQ. (MHz)	EMISSION LEVEL (dBuV/m)	LIMIT (dBuV/m)	MARGIN (dB)	ANTENNA HEIGHT (m)	TABLE ANGLE (Degree)	RAW VALUE (dBuV)	CORRECTION FACTOR (dB/m)
1	*2462.00	110.1 PK			1.00 H	109	78.09	32.01
2	*2462.00	99.7 AV			1.00 H	109	67.69	32.01
3	2483.50	64.1 PK	74.0	-9.9	1.00 H	108	32.01	32.09
4	2483.50	50.1 AV	54.0	-3.9	1.00 H	108	18.01	32.09
5	4924.00	49.8 PK	74.0	-24.2	1.00 H	110	10.13	39.67
6	4924.00	37.7 AV	54.0	-16.3	1.00 H	110	-1.97	39.67
7	7386.00	53.8 PK	74.0	-20.2	1.00 H	74	7.00	46.80
8	7386.00	41.3 AV	54.0	-12.7	1.00 H	74	-5.50	46.80

ANTENNA POLARITY & TEST DISTANCE: VERTICAL AT 3 M

NO.	FREQ. (MHz)	EMISSION LEVEL (dBuV/m)	LIMIT (dBuV/m)	MARGIN (dB)	ANTENNA HEIGHT (m)	TABLE ANGLE (Degree)	RAW VALUE (dBuV)	CORRECTION FACTOR (dB/m)
1	*2462.00	103.9 PK			1.00 V	35	71.89	32.01
2	*2462.00	92.9 AV			1.00 V	35	60.89	32.01
3	2483.50	60.0 PK	74.0	-14.0	1.00 V	35	27.91	32.09
4	2483.50	45.8 AV	54.0	-8.2	1.00 V	35	13.71	32.09
5	4924.00	51.4 PK	74.0	-22.6	1.00 V	246	11.73	39.67
6	4924.00	39.3 AV	54.0	-14.7	1.00 V	246	-0.37	39.67
7	7386.00	54.8 PK	74.0	-19.2	1.00 V	339	8.00	46.80
8	7386.00	41.6 AV	54.0	-12.4	1.00 V	339	-5.20	46.80

- REMARKS:**
1. Emission level (dBuV/m) = Raw Value (dBuV) + Correction Factor (dB/m).
 2. Correction Factor (dB/m) = Antenna Factor (dB/m) + Cable Factor (dB).
 3. The other emission levels were very low against the limit.
 4. Margin value = Emission level – Limit value.
 5. “ * “: Fundamental frequency.



A D T

RESTRICTED BANDEDGE (802.11n (20MHz) MODE,CH1, HORIZONTAL)

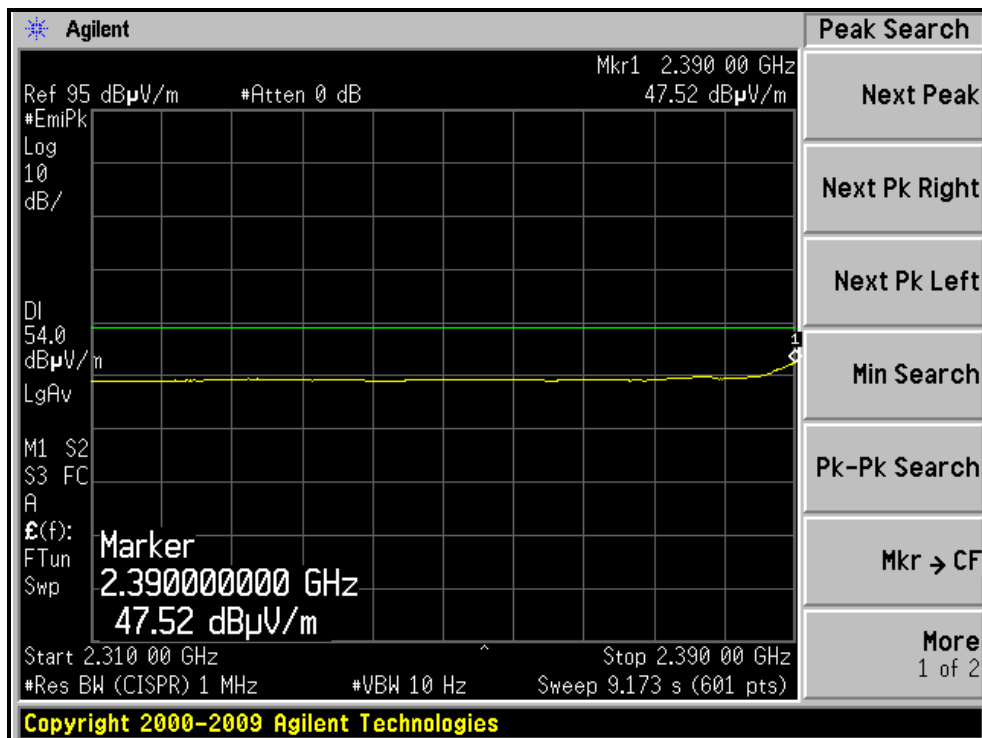
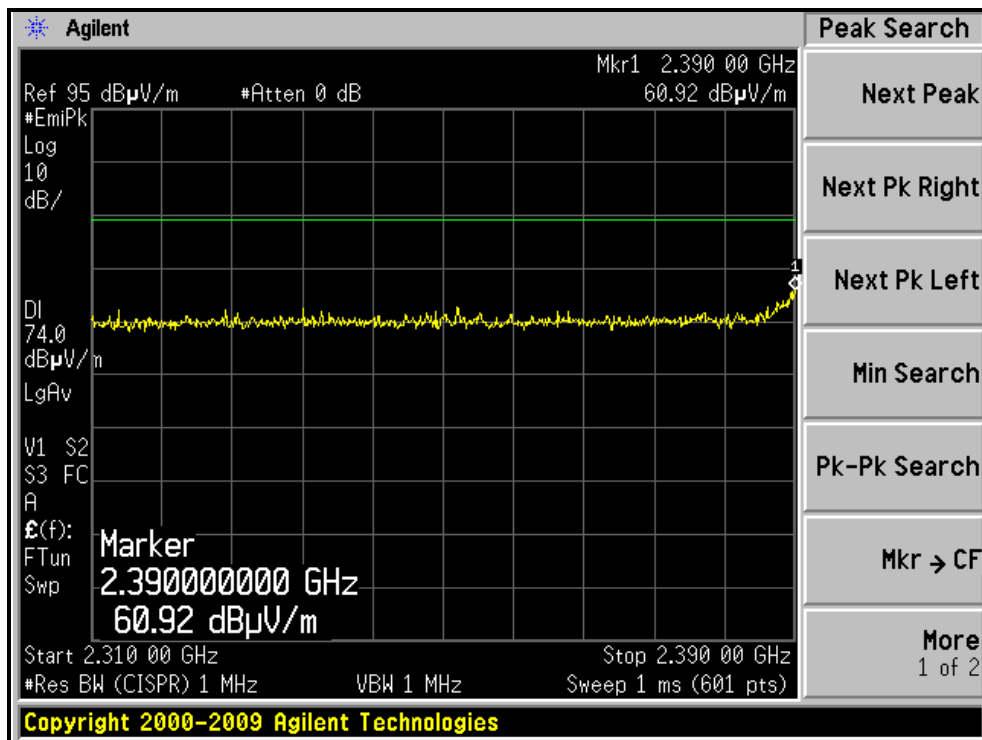



A D T

RESTRICTED BANDEDGE (802.11n (20MHz) MODE,CH1, VERTICAL)

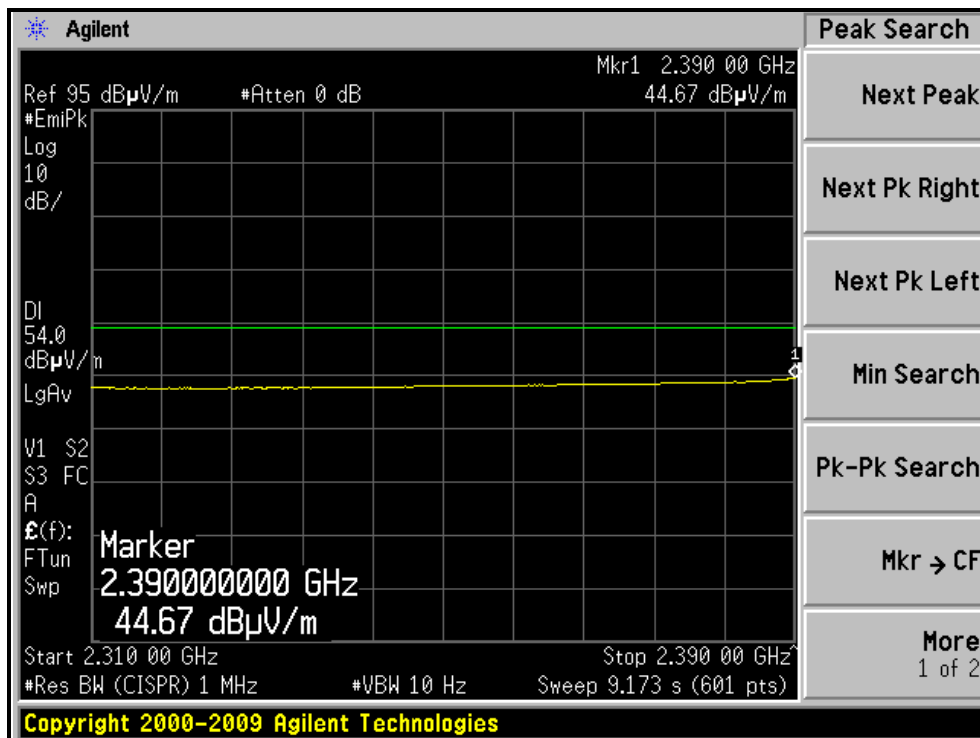
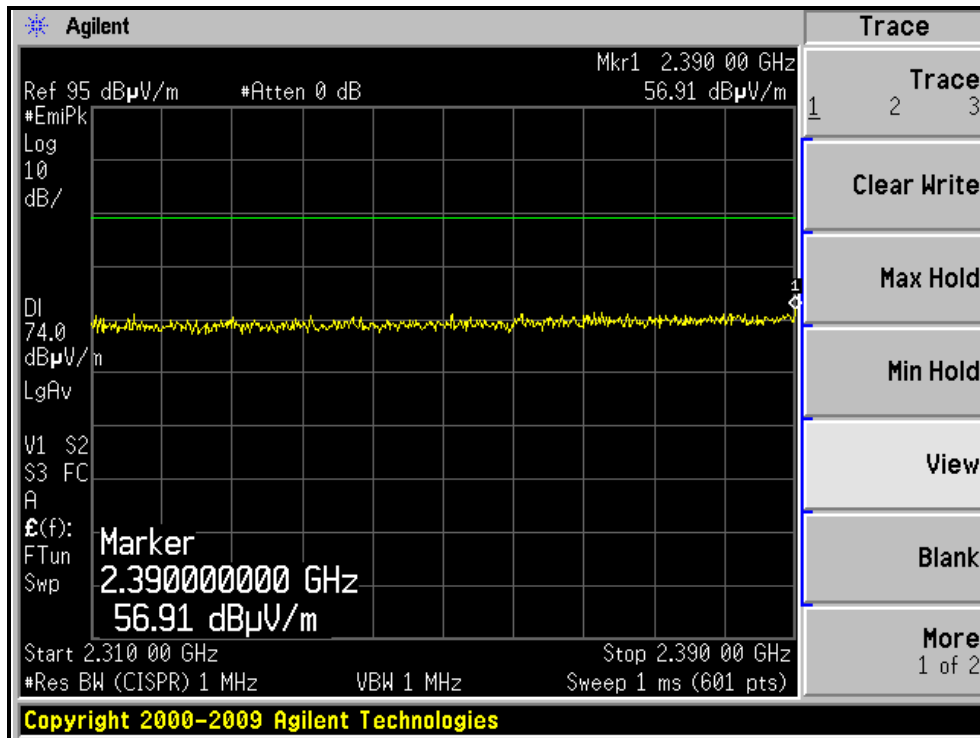



A D T

RESTRICTED BANDEDGE (802.11n (20MHz) MODE,CH11, HORIZONTAL)

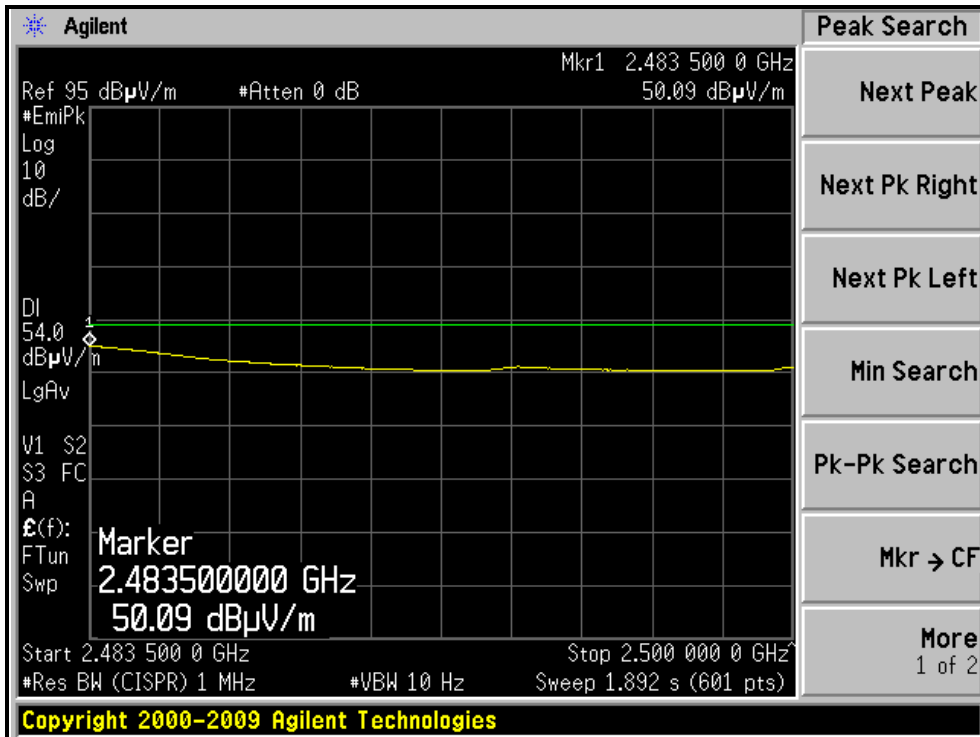
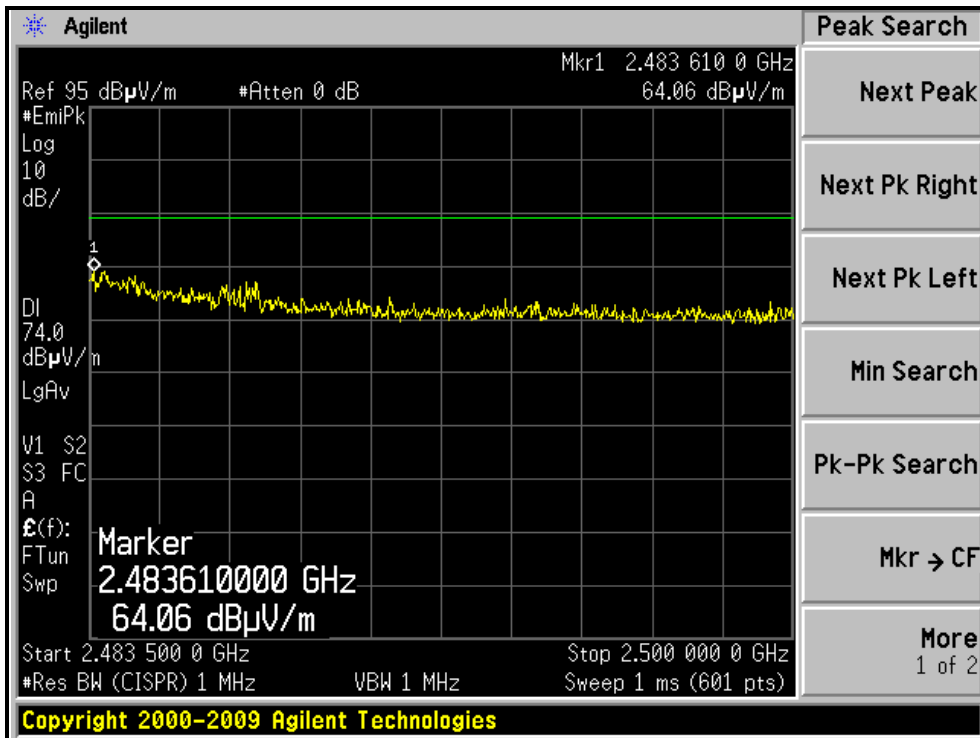



A D T

RESTRICTED BANDEDGE (802.11n (20MHz) MODE,CH11, VERTICAL)

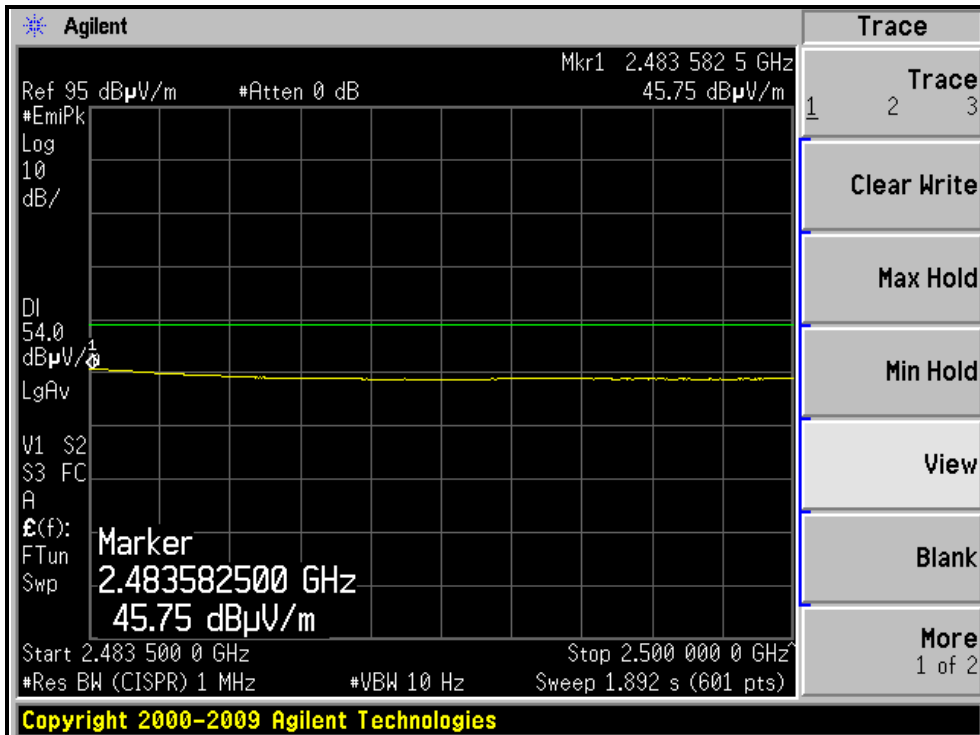
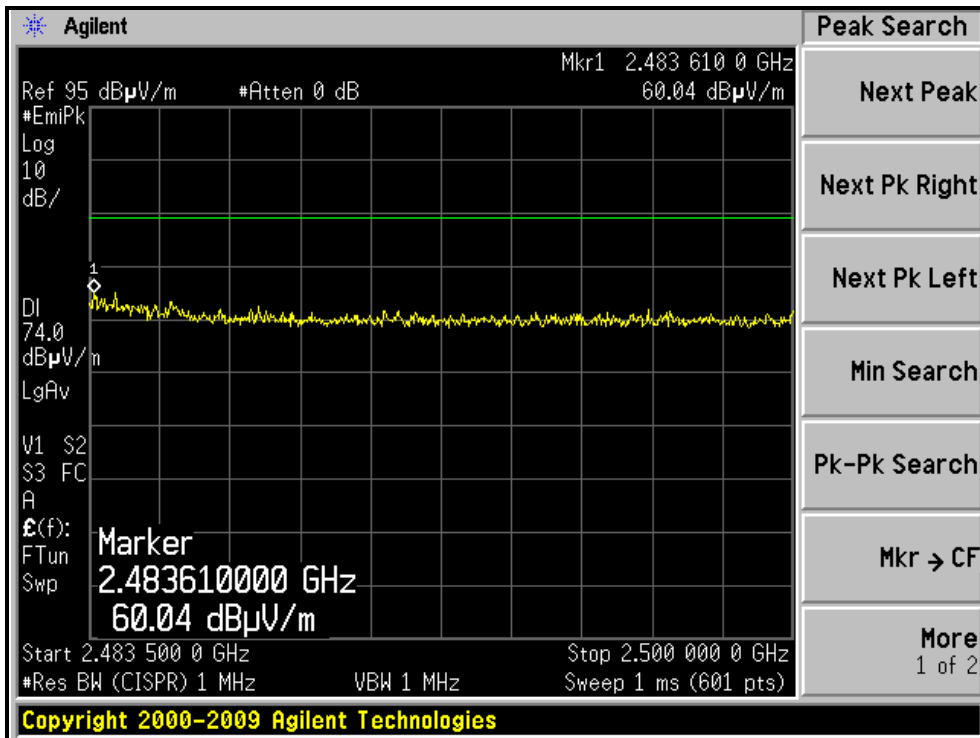

802.11n (40MHz) OFDM MODULATION

EUT TEST CONDITION		MEASUREMENT DETAIL	
CHANNEL	Channel 3	FREQUENCY RANGE	1 ~ 25GHz
INPUT POWER	120Vac, 60 Hz	DETECTOR FUNCTION	Peak (PK) Average (AV)
ENVIRONMENTAL CONDITIONS	22deg. C, 71%RH	TESTED BY	Rex Huang

ANTENNA POLARITY & TEST DISTANCE: HORIZONTAL AT 3 M								
NO.	FREQ. (MHz)	EMISSION LEVEL (dBuV/m)	LIMIT (dBuV/m)	MARGIN (dB)	ANTENNA HEIGHT (m)	TABLE ANGLE (Degree)	RAW VALUE (dBuV)	CORRECTION FACTOR (dB/m)
1	2390.00	62.5 PK	74.0	-11.5	1.00 H	110	30.75	31.75
2	2390.00	49.1 AV	54.0	-4.9	1.00 H	110	17.35	31.75
3	*2422.00	105.7 PK			1.00 H	110	73.84	31.86
4	*2422.00	95.6 AV			1.00 H	110	63.74	31.86
5	4844.00	48.5 PK	74.0	-25.5	1.00 H	109	9.08	39.42
6	4844.00	37.0 AV	54.0	-17.0	1.00 H	109	-2.42	39.42
7	7266.00	54.8 PK	74.0	-19.2	1.00 H	69	7.89	46.91
8	7266.00	42.5 AV	54.0	-11.5	1.00 H	69	-4.41	46.91
ANTENNA POLARITY & TEST DISTANCE: VERTICAL AT 3 M								
NO.	FREQ. (MHz)	EMISSION LEVEL (dBuV/m)	LIMIT (dBuV/m)	MARGIN (dB)	ANTENNA HEIGHT (m)	TABLE ANGLE (Degree)	RAW VALUE (dBuV)	CORRECTION FACTOR (dB/m)
1	2390.00	58.0 PK	74.0	-16.0	1.00 V	67	26.25	31.75
2	2390.00	45.0 AV	54.0	-9.0	1.00 V	67	13.25	31.75
3	*2422.00	99.5 PK			1.00 V	67	67.64	31.86
4	*2422.00	89.2 AV			1.00 V	67	57.34	31.86
5	4844.00	50.8 PK	74.0	-23.2	1.00 V	249	11.38	39.42
6	4844.00	39.8 AV	54.0	-14.2	1.00 V	249	0.38	39.42
7	7266.00	54.3 PK	74.0	-19.7	1.00 V	339	7.39	46.91
8	7266.00	40.9 AV	54.0	-13.1	1.00 V	339	-6.01	46.91

- REMARKS:**
1. Emission level (dBuV/m) = Raw Value (dBuV) + Correction Factor (dB/m).
 2. Correction Factor (dB/m) = Antenna Factor (dB/m) + Cable Factor (dB).
 3. The other emission levels were very low against the limit.
 4. Margin value = Emission level – Limit value.
 5. “ * “: Fundamental frequency.



A D T

EUT TEST CONDITION		MEASUREMENT DETAIL	
CHANNEL	Channel 6	FREQUENCY RANGE	1 ~ 25GHz
INPUT POWER	120Vac, 60 Hz	DETECTOR FUNCTION	Peak (PK) Average (AV)
ENVIRONMENTAL CONDITIONS	22deg. C, 71%RH	TESTED BY	Rex Huang

ANTENNA POLARITY & TEST DISTANCE: HORIZONTAL AT 3 M								
NO.	FREQ. (MHz)	EMISSION LEVEL (dBuV/m)	LIMIT (dBuV/m)	MARGIN (dB)	ANTENNA HEIGHT (m)	TABLE ANGLE (Degree)	RAW VALUE (dBuV)	CORRECTION FACTOR (dB/m)
1	*2437.00	105.8 PK			1.00 H	109	73.88	31.92
2	*2437.00	95.6 AV			1.00 H	109	63.68	31.92
3	4874.00	49.4 PK	74.0	-24.6	1.00 H	108	9.90	39.50
4	4874.00	37.1 AV	54.0	-16.9	1.00 H	108	-2.40	39.50
5	7311.00	54.2 PK	74.0	-19.8	1.00 H	75	7.32	46.88
6	7311.00	41.1 AV	54.0	-12.9	1.00 H	75	-5.78	46.88
ANTENNA POLARITY & TEST DISTANCE: VERTICAL AT 3 M								
NO.	FREQ. (MHz)	EMISSION LEVEL (dBuV/m)	LIMIT (dBuV/m)	MARGIN (dB)	ANTENNA HEIGHT (m)	TABLE ANGLE (Degree)	RAW VALUE (dBuV)	CORRECTION FACTOR (dB/m)
1	*2437.00	100.1 PK			1.00 V	67	68.18	31.92
2	*2437.00	89.5 AV			1.00 V	67	57.58	31.92
3	4874.00	53.2 PK	74.0	-20.8	1.00 V	245	13.70	39.50
4	4874.00	40.1 AV	54.0	-13.9	1.00 V	245	0.60	39.50
5	7311.00	53.5 PK	74.0	-20.5	1.00 V	340	6.62	46.88
6	7311.00	40.8 AV	54.0	-13.2	1.00 V	340	-6.08	46.88

- REMARKS:**
1. Emission level (dBuV/m) = Raw Value (dBuV) + Correction Factor (dB/m).
 2. Correction Factor (dB/m) = Antenna Factor (dB/m) + Cable Factor (dB).
 3. The other emission levels were very low against the limit.
 4. Margin value = Emission level – Limit value.
 5. “ * “: Fundamental frequency.



A D T

EUT TEST CONDITION		MEASUREMENT DETAIL	
CHANNEL	Channel 9	FREQUENCY RANGE	1 ~ 25GHz
INPUT POWER	120Vac, 60 Hz	DETECTOR FUNCTION	Peak (PK) Average (AV)
ENVIRONMENTAL CONDITIONS	22deg. C, 71%RH	TESTED BY	Rex Huang

ANTENNA POLARITY & TEST DISTANCE: HORIZONTAL AT 3 M

NO.	FREQ. (MHz)	EMISSION LEVEL (dBuV/m)	LIMIT (dBuV/m)	MARGIN (dB)	ANTENNA HEIGHT (m)	TABLE ANGLE (Degree)	RAW VALUE (dBuV)	CORRECTION FACTOR (dB/m)
1	*2452.00	106.7 PK			1.00 H	110	74.73	31.97
2	*2452.00	96.4 AV			1.00 H	110	64.43	31.97
3	2483.50	68.4 PK	74.0	-5.6	1.00 H	109	36.31	32.09
4	2483.50	52.0 AV	54.0	-2.0	1.00 H	109	19.91	32.09
5	4904.00	50.6 PK	74.0	-23.4	1.00 H	109	11.00	39.60
6	4904.00	38.1 AV	54.0	-15.9	1.00 H	109	-1.50	39.60
7	7356.00	55.2 PK	74.0	-18.8	1.00 H	81	8.37	46.83
8	7356.00	42.0 AV	54.0	-12.0	1.00 H	81	-4.83	46.83

ANTENNA POLARITY & TEST DISTANCE: VERTICAL AT 3 M

NO.	FREQ. (MHz)	EMISSION LEVEL (dBuV/m)	LIMIT (dBuV/m)	MARGIN (dB)	ANTENNA HEIGHT (m)	TABLE ANGLE (Degree)	RAW VALUE (dBuV)	CORRECTION FACTOR (dB/m)
1	*2452.00	100.4 PK			1.00 V	66	68.43	31.97
2	*2452.00	90.0 AV			1.00 V	66	58.03	31.97
3	2483.50	60.9 PK	74.0	-13.1	1.00 V	65	28.81	32.09
4	2483.50	47.7 AV	54.0	-6.3	1.00 V	65	15.61	32.09
5	4904.00	52.8 PK	74.0	-21.2	1.00 V	246	13.20	39.60
6	4904.00	40.8 AV	54.0	-13.2	1.00 V	246	1.20	39.60
7	7356.00	55.5 PK	74.0	-18.5	1.00 V	338	8.67	46.83
8	7356.00	42.2 AV	54.0	-11.8	1.00 V	338	-4.63	46.83

- REMARKS:**
1. Emission level (dBuV/m) = Raw Value (dBuV) + Correction Factor (dB/m).
 2. Correction Factor (dB/m) = Antenna Factor (dB/m) + Cable Factor (dB).
 3. The other emission levels were very low against the limit.
 4. Margin value = Emission level – Limit value.
 5. “ * “: Fundamental frequency.



A D T

RESTRICTED BANDEDGE (802.11n (40MHz) MODE,CH3, HORIZONTAL)

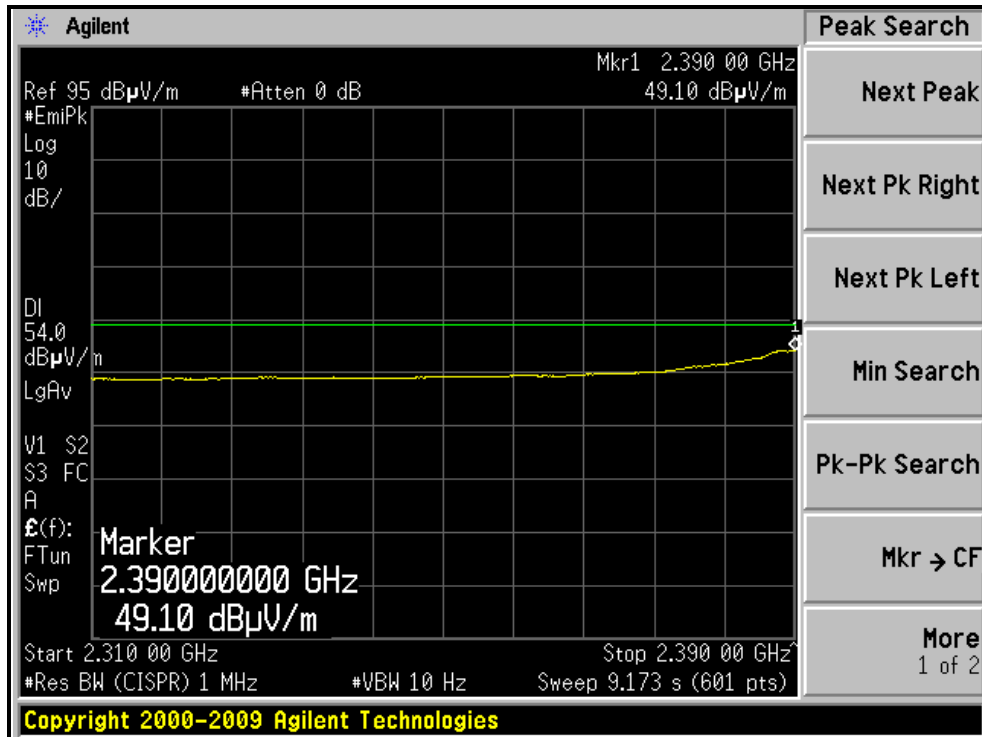
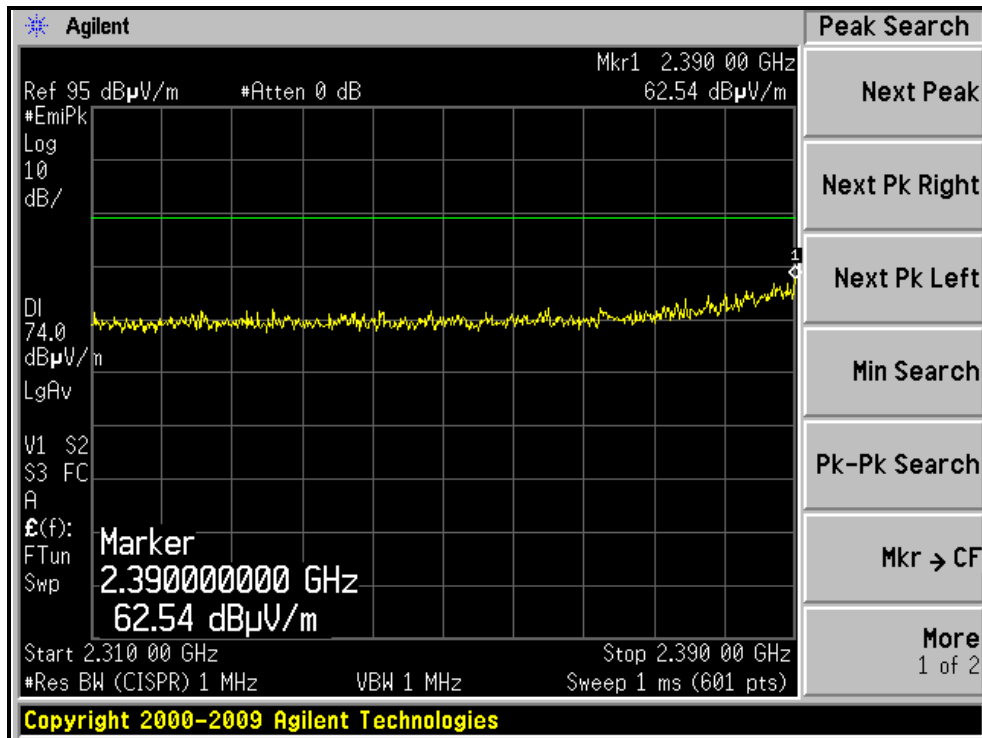



A D T

RESTRICTED BANDEDGE (802.11n (40MHz) MODE,CH3, VERTICAL)

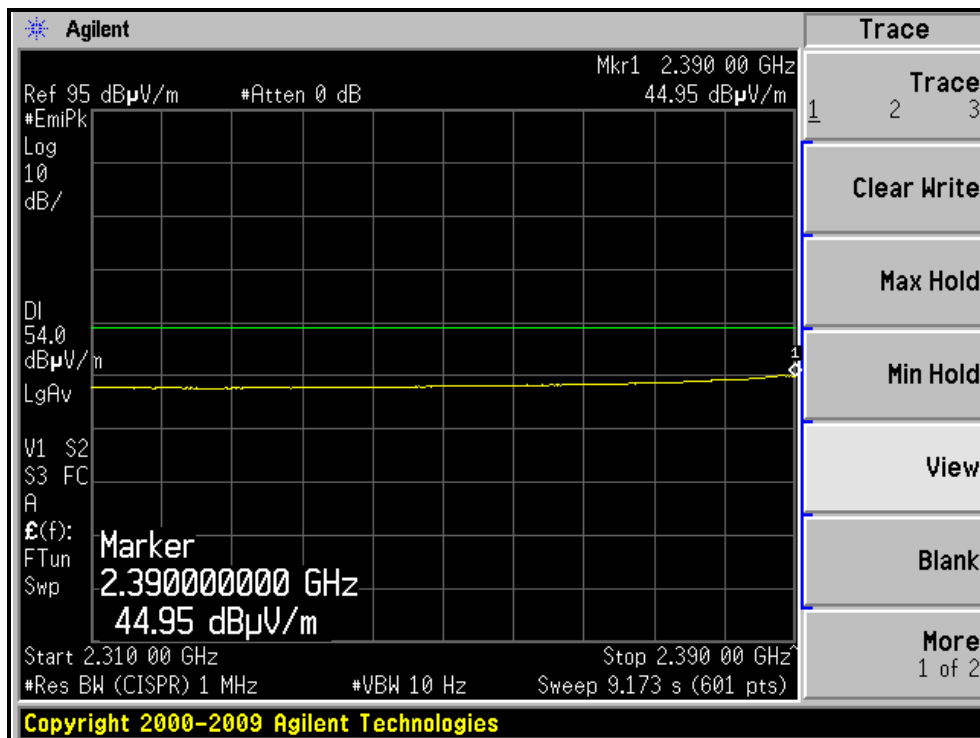
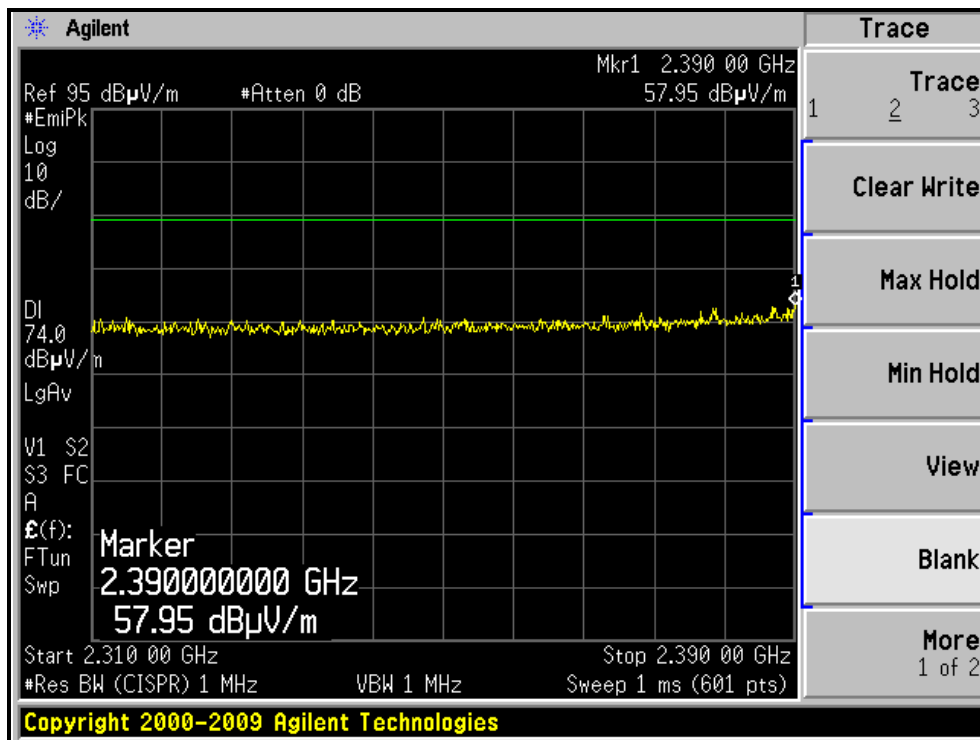



A D T

RESTRICTED BANDEDGE (802.11n (40MHz) MODE,CH9, HORIZONTAL)

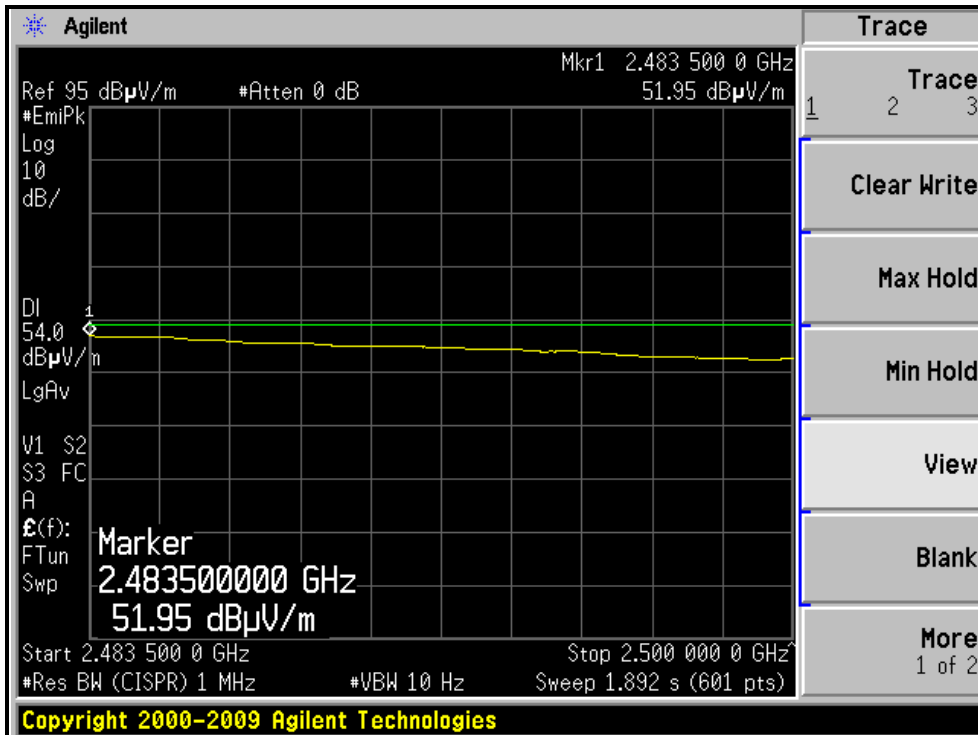
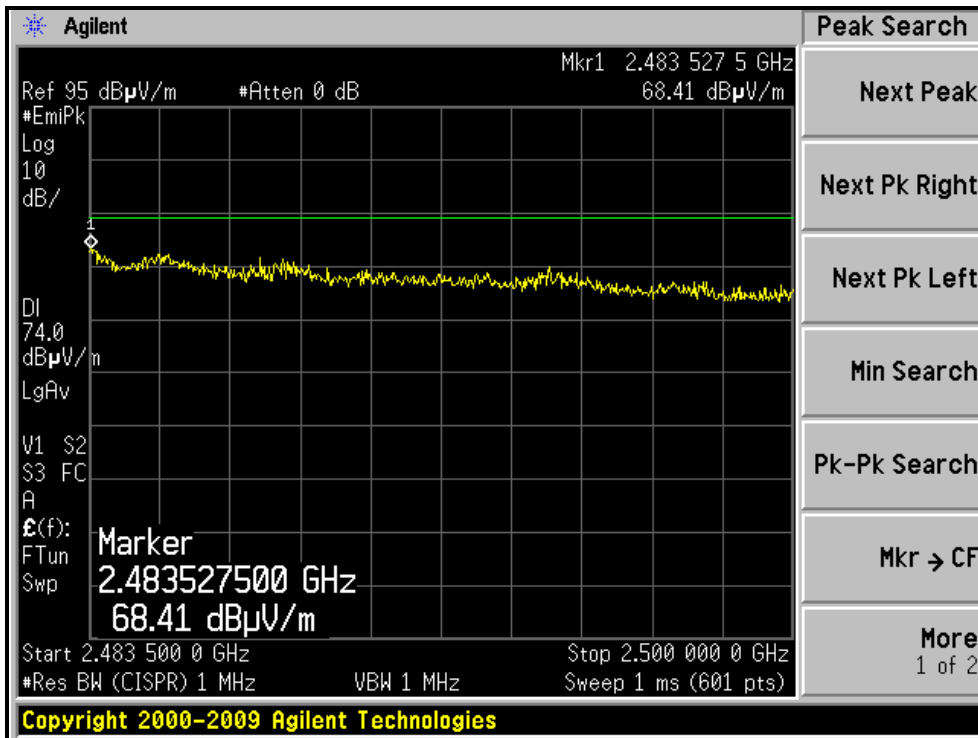

RESTRICTED BANDEDGE (802.11n (40MHz) MODE,CH9, VERTICAL)

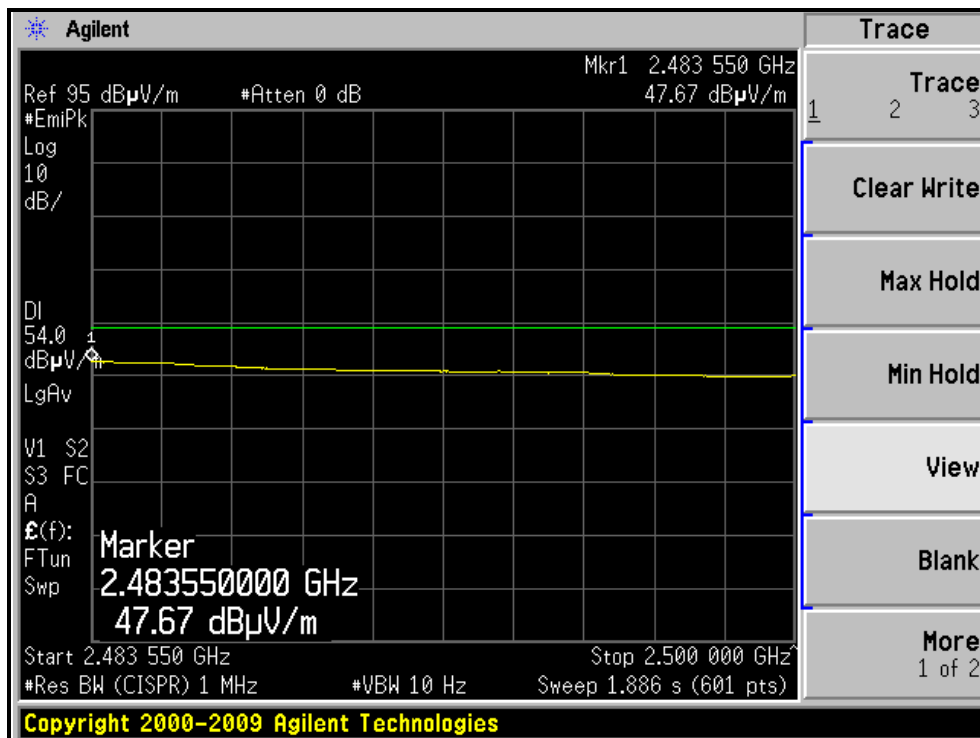
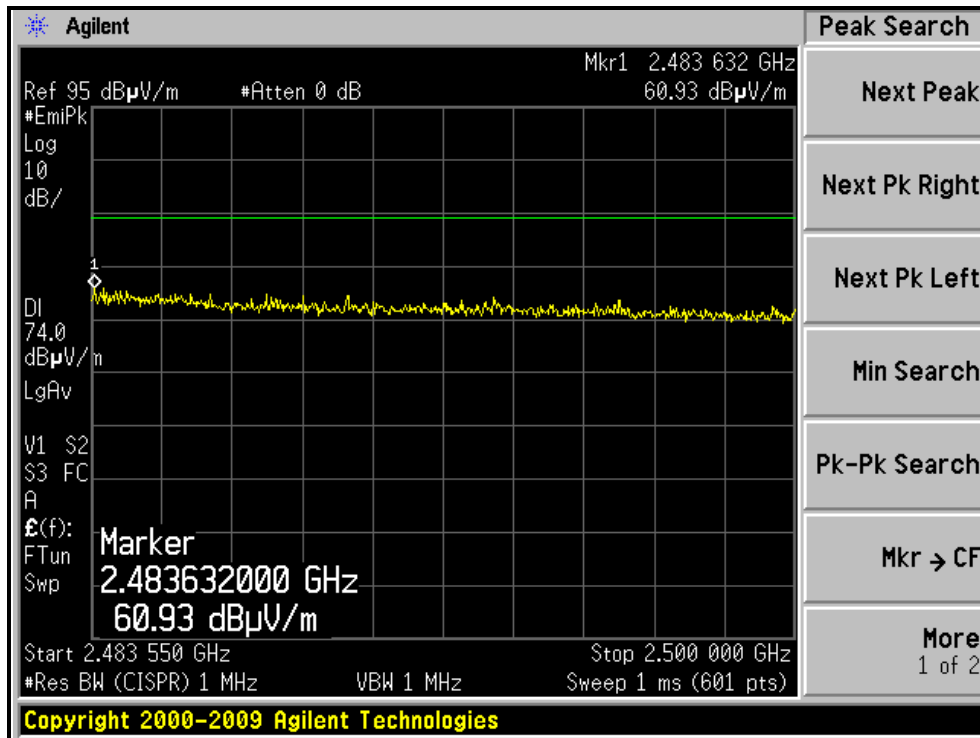

4.3 6dB BANDWIDTH MEASUREMENT

4.3.1 LIMITS OF 6dB BANDWIDTH MEASUREMENT

The minimum of 6dB Bandwidth Measurement is 0.5 MHz.

4.3.2 TEST INSTRUMENTS

Test date: Sep. 29, 2011

DESCRIPTION & MANUFACTURER	MODEL NO.	SERIAL NO.	CALIBRATED DATE	CALIBRATED UNTIL
R&S Spectrum Analyzer	FSP 40	100060	May 11, 2011	May 10, 2012

NOTE: The calibration interval of the above test instruments is 12 months and the calibrations are traceable to NML/ROC and NIST/USA.

4.3.3 TEST PROCEDURE

The transmitter output was connected to the spectrum analyzer through an attenuator. The bandwidth of the fundamental frequency was measured by spectrum analyzer with 100kHz RBW and 300kHz VBW. The 6dB bandwidth is defined as the total spectrum the power of which is higher than peak power minus 6dB.

4.3.4 DEVIATION FROM TEST STANDARD

No deviation

4.3.5 TEST SETUP



4.3.6 EUT OPERATING CONDITIONS

The software provided by client to enable the EUT under transmission condition continuously at lowest, middle and highest channel frequencies individually.

4.3.7 TEST RESULTS

802.11b DSSS MODULATION:

CHANNEL	CHANNEL FREQUENCY (MHz)	6dB BANDWIDTH (MHz)	MINIMUM LIMIT (MHz)	PASS / FAIL
1	2412	9.42	0.5	PASS
6	2437	10.04	0.5	PASS
11	2462	9.09	0.5	PASS

CH6

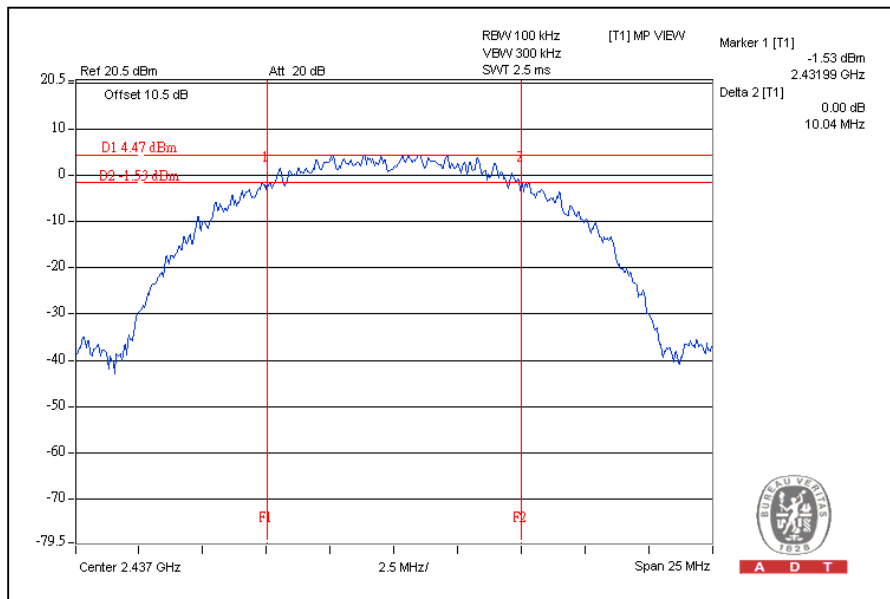



A D T

802.11g OFDM MODULATION:

CHANNEL	CHANNEL FREQUENCY (MHz)	6dB BANDWIDTH (MHz)	MINIMUM LIMIT (MHz)	PASS / FAIL
1	2412	16.61	0.5	PASS
6	2437	16.62	0.5	PASS
11	2462	16.62	0.5	PASS

CH11

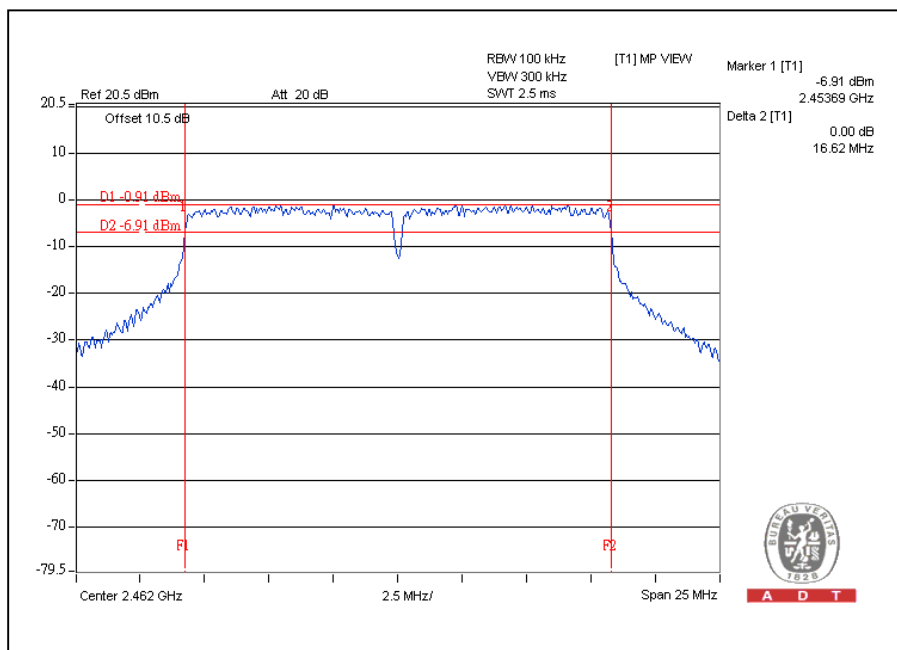



A D T

802.11n (20MHz) OFDM MODULATION:

CHANNEL	CHANNEL FREQUENCY (MHz)	6dB BANDWIDTH (MHz)		MINIMUM LIMIT (MHz)	PASS / FAIL
		CHAIN(0)	CHAIN(1)		
1	2412	17.87	17.78	0.5	PASS
6	2437	17.87	17.78	0.5	PASS
11	2462	17.85	17.81	0.5	PASS

For CHAIN(0)
CH6

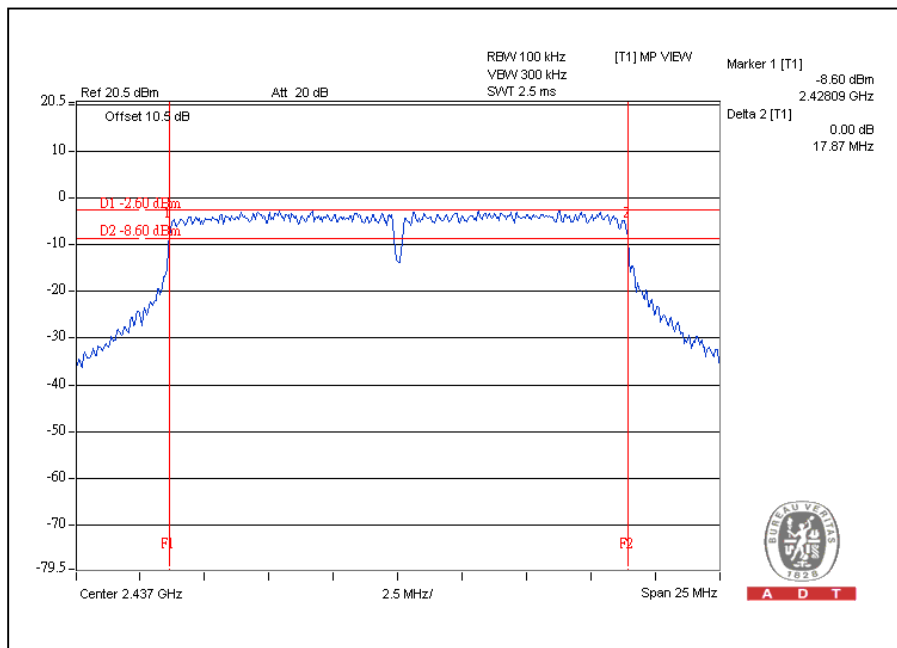



A D T

802.11n (40MHz) OFDM MODULATION:

CHANNEL	CHANNEL FREQUENCY (MHz)	6dB BANDWIDTH (MHz)		MINIMUM LIMIT (MHz)	PASS / FAIL
		CHAIN(0)	CHAIN(1)		
3	2422	36.62	36.51	0.5	PASS
6	2437	36.60	36.56	0.5	PASS
9	2452	36.60	36.57	0.5	PASS

For CHAIN(0)
CH3

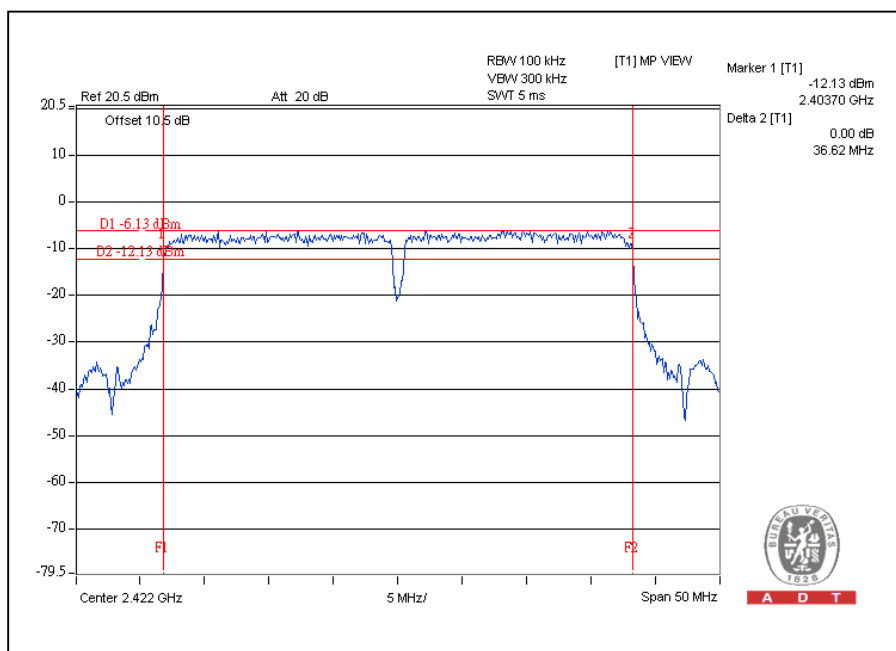

4.4 MAXIMUM PEAK OUTPUT POWER

4.4.1 LIMITS OF MAXIMUM PEAK OUTPUT POWER MEASUREMENT

The Maximum Peak Output Power Measurement is 30dBm.

4.4.2 INSTRUMENTS

Test date: Sep. 29, 2011

DESCRIPTION & MANUFACTURER	MODEL NO.	SERIAL NO.	CALIBRATED DATE	CALIBRATED UNTIL
Anritsu Power Meter	ML2495A	0824006	May 04, 2011	May 03, 2012
Pulse Power Sensor	MA2411B	0738172	May 03, 2011	May 02, 2012

NOTE: The calibration interval of the above test instruments is 12 months and the calibrations are traceable to NML/ROC and NIST/USA.

4.4.3 TEST PROCEDURES

1. The transmitter output was connected to the power meter through an attenuator; the bandwidth of the fundamental frequency was measured with the power meter.
2. Record the power level.

4.4.4 DEVIATION FROM TEST STANDARD

No deviation

4.4.5 TEST SETUP

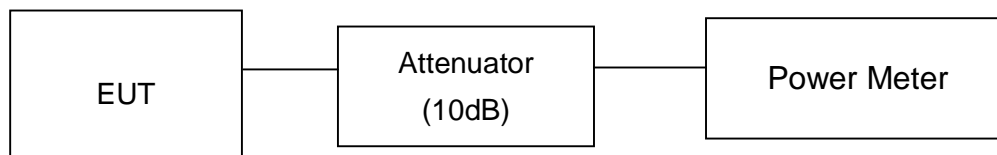

4.4.6 EUT OPERATING CONDITIONS

Same as Item 4.3.6

4.4.7 TEST RESULTS

802.11b DSSS MODULATION:

CHANNEL	CHANNEL FREQUENCY (MHz)	PEAK POWER OUTPUT (mW)	PEAK POWER OUTPUT (dBm)	PEAK POWER LIMIT (dBm)	PASS / FAIL
1	2412	51.3	17.1	30	PASS
6	2437	52.5	17.2	30	PASS
11	2462	61.7	17.9	30	PASS

802.11g OFDM MODULATION:

CHANNEL	CHANNEL FREQUENCY (MHz)	PEAK POWER OUTPUT (mW)	PEAK POWER OUTPUT (dBm)	PEAK POWER LIMIT (dBm)	PASS / FAIL
1	2412	218.8	23.4	30	PASS
6	2437	213.8	23.3	30	PASS
11	2462	218.8	23.4	30	PASS

802.11n (20MHz) OFDM MODULATION:

CHANNEL	CHANNEL FREQUENCY (MHz)	PEAK POWER OUTPUT (dBm)		TOTAL PEAK POWER (mW)	TOTAL PEAK POWER (dBm)	PEAK POWER LIMIT (dBm)	PASS / FAIL
		CHAIN(0)	CHAIN(1)				
1	2412	23.4	23.3	432.6	26.4	30	PASS
6	2437	23.2	23.2	417.9	26.2	30	PASS
11	2462	23.3	23.1	418.0	26.2	30	PASS

802.11n (40MHz) OFDM MODULATION:

CHANNEL	CHANNEL FREQUENCY (MHz)	PEAK POWER OUTPUT (dBm)		TOTAL PEAK POWER (mW)	TOTAL PEAK POWER (dBm)	PEAK POWER LIMIT (dBm)	PASS / FAIL
		CHAIN(0)	CHAIN(1)				
3	2422	23.5	23.3	437.7	26.4	30	PASS
6	2437	23.4	23.4	437.6	26.4	30	PASS
9	2452	23.3	23.6	442.9	26.5	30	PASS

4.5 POWER SPECTRAL DENSITY MEASUREMENT

4.5.1 LIMITS OF POWER SPECTRAL DENSITY MEASUREMENT

The Maximum of Power Spectral Density Measurement is 8dBm.

4.5.2 TEST INSTRUMENTS

Test date: Sep. 29, 2011

DESCRIPTION & MANUFACTURER	MODEL NO.	SERIAL NO.	CALIBRATED DATE	CALIBRATED UNTIL
R&S Spectrum Analyzer	FSP 40	100060	May 11, 2011	May 10, 2012

NOTE: The calibration interval of the above test instruments is 12 months and the calibrations are traceable to NML/ROC and NIST/USA.

4.5.3 TEST PROCEDURE

The transmitter output was connected to the spectrum analyzer through an attenuator, the bandwidth of the fundamental frequency was measured with the spectrum analyzer using 3kHz RBW and 30kHz VBW, set sweep time = span/3kHz. The power spectral density was measured and recorded. The sweep time is allowed to be longer than span/3kHz for a full response of the mixer in the spectrum analyzer.

4.5.4 DEVIATION FROM TEST STANDARD

No deviation

4.5.5 TEST SETUP

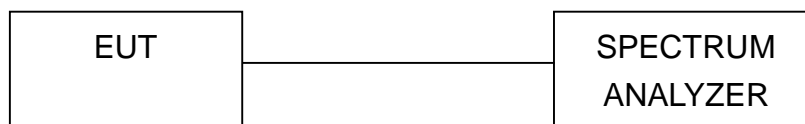

4.5.6 EUT OPERATING CONDITION

Same as Item 4.3.6



A D T

4.5.7 TEST RESULTS

802.11b DSSS MODULATION:

CHANNEL	CHANNEL FREQUENCY (MHz)	RF POWER LEVEL IN 3kHz BW (dBm)	MAXIMUM LIMIT (dBm)	PASS / FAIL
1	2412	-7.9	8	PASS
6	2437	-7.6	8	PASS
11	2462	-7.3	8	PASS

CH11

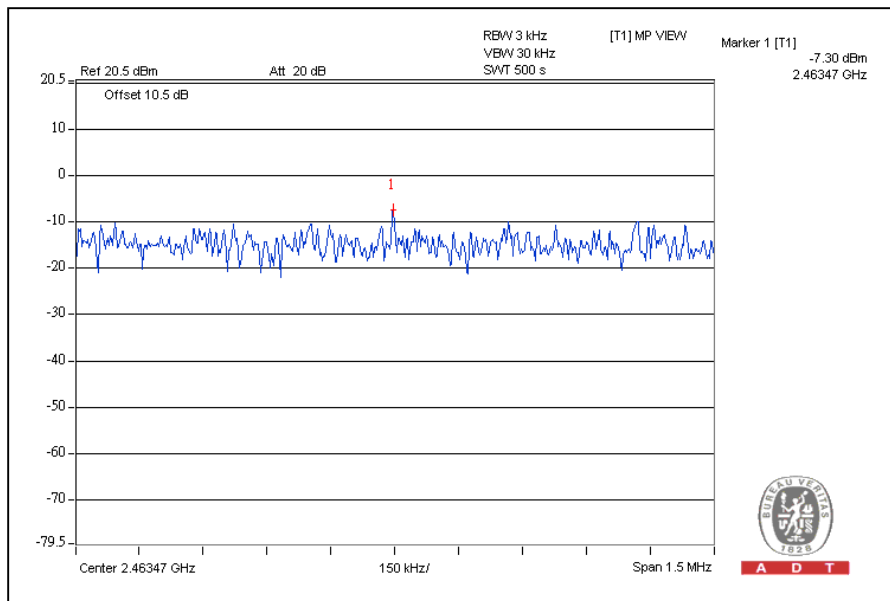



A D T

802.11g OFDM MODULATION:

CHANNEL	CHANNEL FREQUENCY (MHz)	RF POWER LEVEL IN 3kHz BW (dBm)	MAXIMUM LIMIT (dBm)	PASS / FAIL
1	2412	-14.6	8	PASS
6	2437	-14.9	8	PASS
11	2462	-15.4	8	PASS

CH1

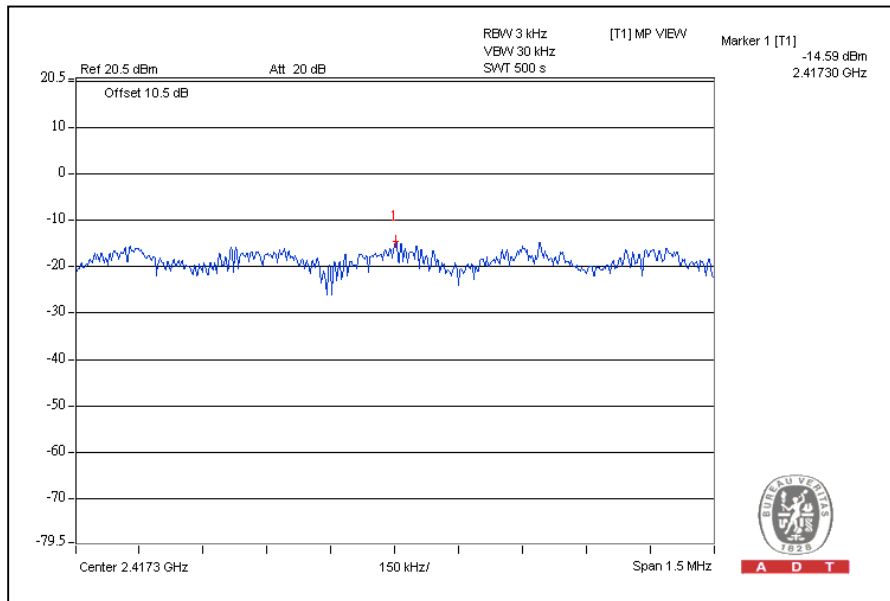



A D T

802.11n (20MHz) OFDM MODULATION:

CHANNEL	CHANNEL FREQUENCY (MHz)	RF POWER LEVEL IN 3kHz BW (dBm)		TOTAL POWER DENSITY (dBm)	MAXIMUM LIMIT (dBm)	PASS / FAIL
		CHAIN(0)	CHAIN(1)			
1	2412	-15.2	-15.4	-12.3	8	PASS
6	2437	-16.0	-15.5	-12.7	8	PASS
11	2462	-14.8	-15.4	-12.1	8	PASS

For CHAIN(0)
CH11

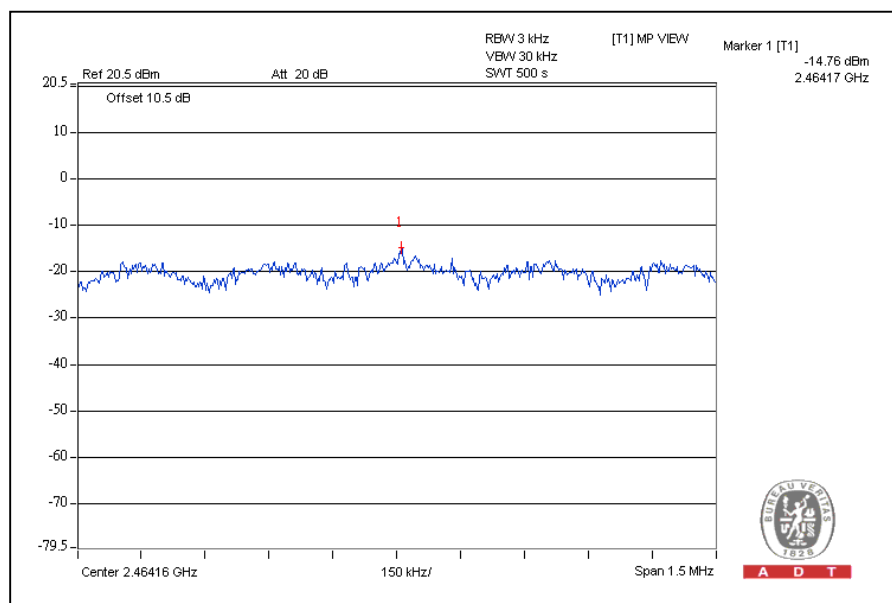



A D T

802.11n (40MHz) OFDM MODULATION:

CHANNEL	CHANNEL FREQUENCY (MHz)	RF POWER LEVEL IN 3kHz BW (dBm)		TOTAL POWER DENSITY (dBm)	MAXIMUM LIMIT (dBm)	PASS / FAIL
		CHAIN(0)	CHAIN(1)			
3	2422	-17.5	-18.6	-15.0	8	PASS
6	2437	-17.8	-18.8	-15.3	8	PASS
9	2452	-17.9	-18.8	-15.3	8	PASS

For CHAIN(0)
CH3

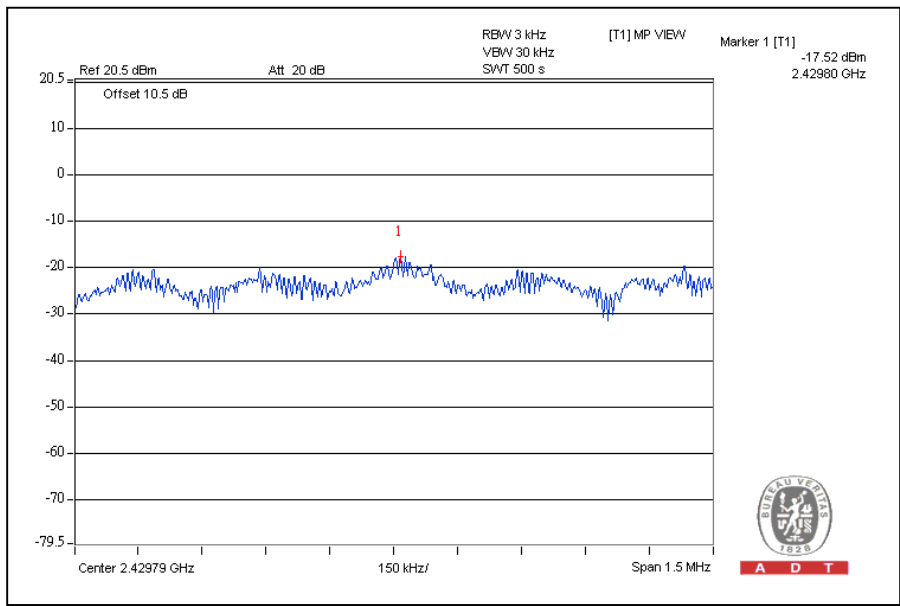

4.6 CONDUCTED OUT-BAND EMISSION MEASUREMENT

4.6.1 LIMITS OF CONDUCTED OUT-BAND EMISSION MEASUREMENT

Below -20dB of the highest emission level of operating band (in 100kHz Resolution Bandwidth).

4.6.2 TEST INSTRUMENTS

Test date: Sep. 29, 2011

DESCRIPTION & MANUFACTURER	MODEL NO.	SERIAL NO.	CALIBRATED DATE	CALIBRATED UNTIL
R&S Spectrum Analyzer	FSP 40	100060	May 11, 2011	May 10, 2012

NOTE: The calibration interval of the above test instruments is 12 months and the calibrations are traceable to NML/ROC and NIST/USA.

4.6.3 TEST PROCEDURE

The transmitter output was connected to the spectrum analyzer via a low loss cable. Set RBW of spectrum analyzer to 100kHz and VBW of spectrum analyzer to 300kHz with suitable frequency span including 100MHz or 200MHz bandwidth from band edge. The band edges was measured and recorded.

The spectrum plots (RBW = 100kHz, VBW = 300kHz) are attached on the following pages.

4.6.4 DEVIATION FROM TEST STANDARD

No deviation

4.6.5 EUT OPERATING CONDITION

Same as Item 4.3.6

4.6.6 TEST RESULTS

The spectrum plots are attached on the following images. D1 line indicates the highest level, and D2 line indicates the 20dB offset below D1. It shows compliance with the requirement in part 15.247(d).



A D T

Performing measurements: Measure and add 10 log(N) dB

802.11b DSSS MODULATION:

CH1

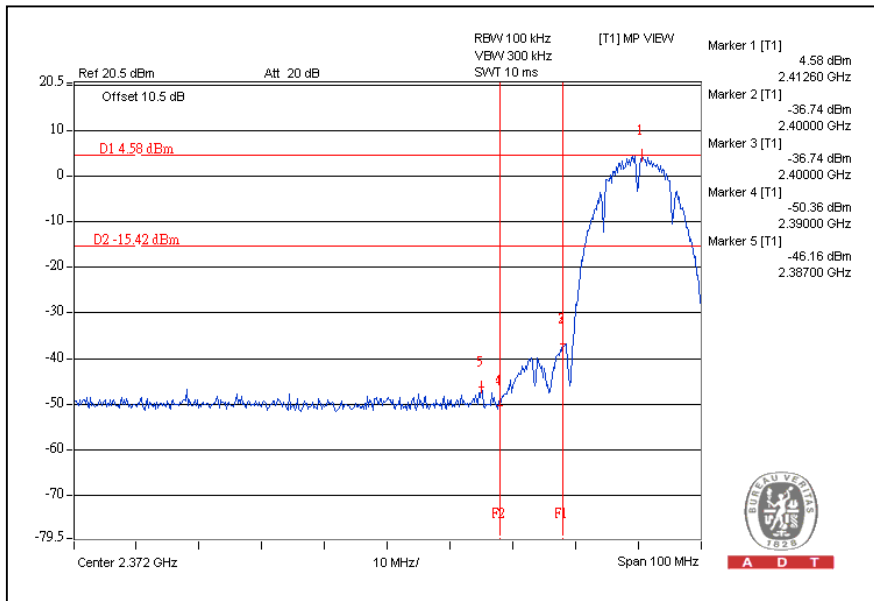

A D T

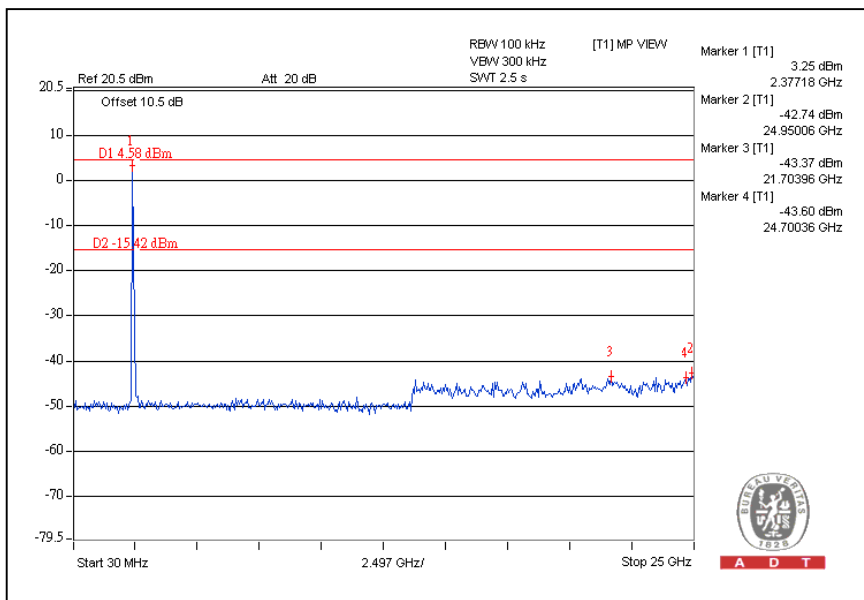

A D T



A D T

CH11

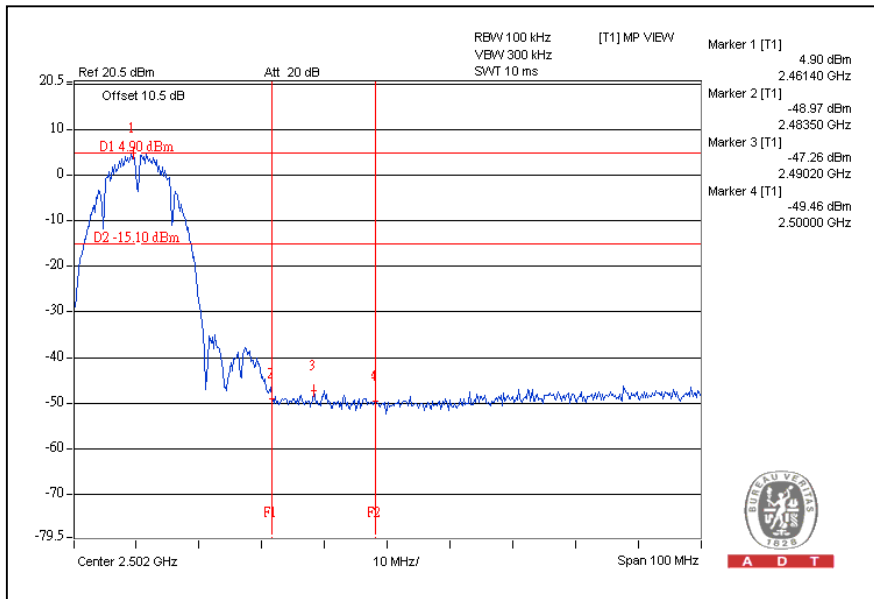

A D T

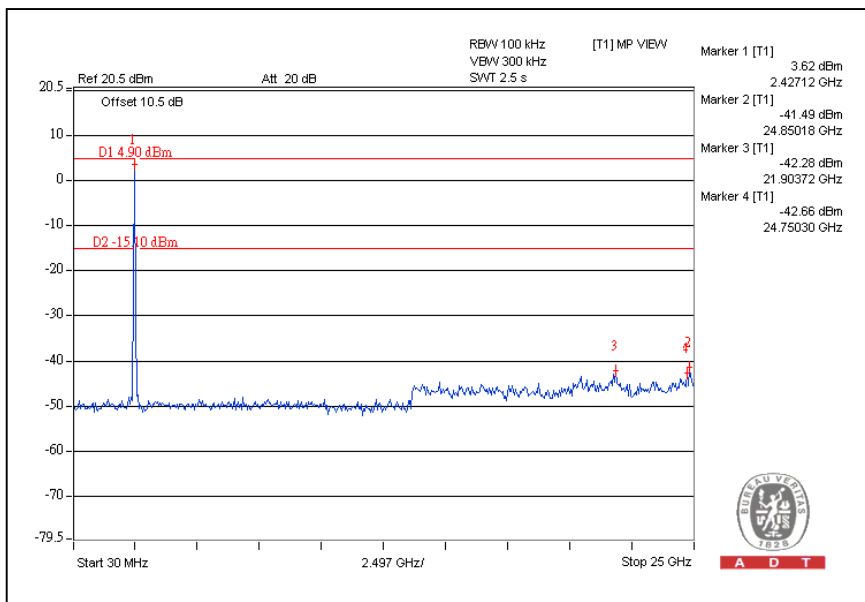

A D T



A D T

802.11g OFDM MODULATION:

CH1

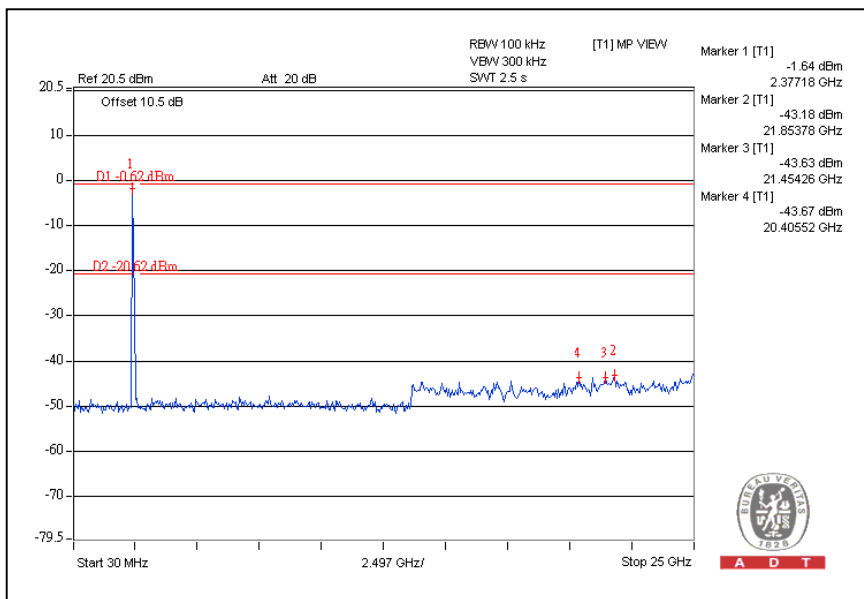
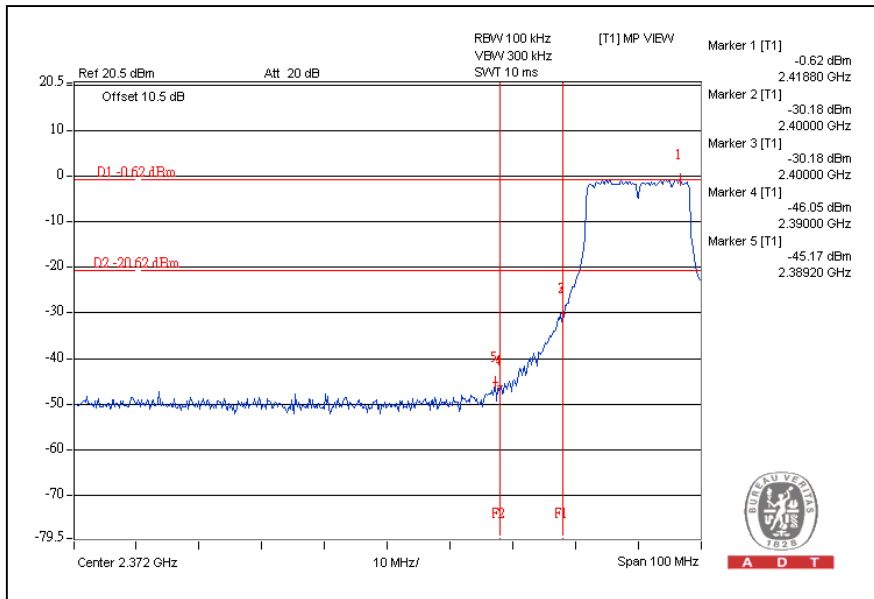



A D T

CH11

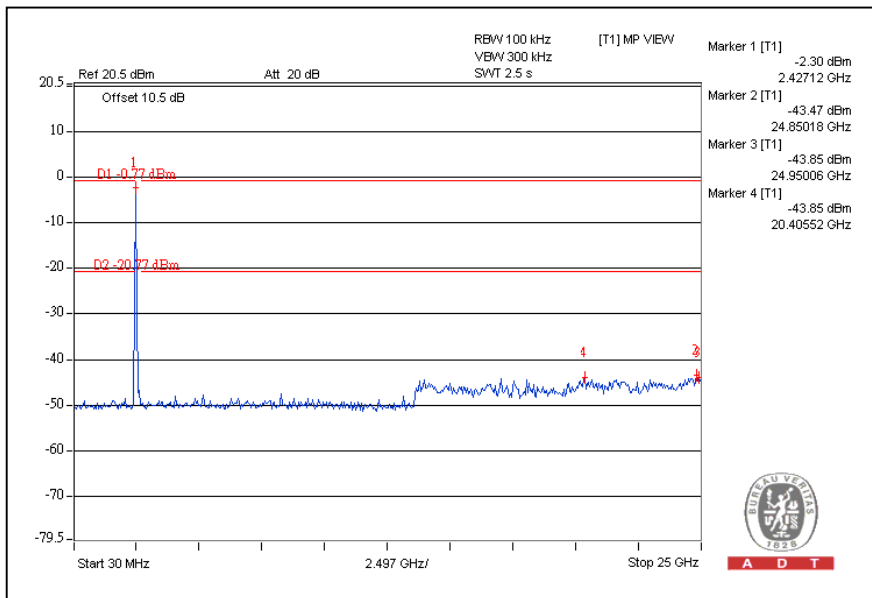
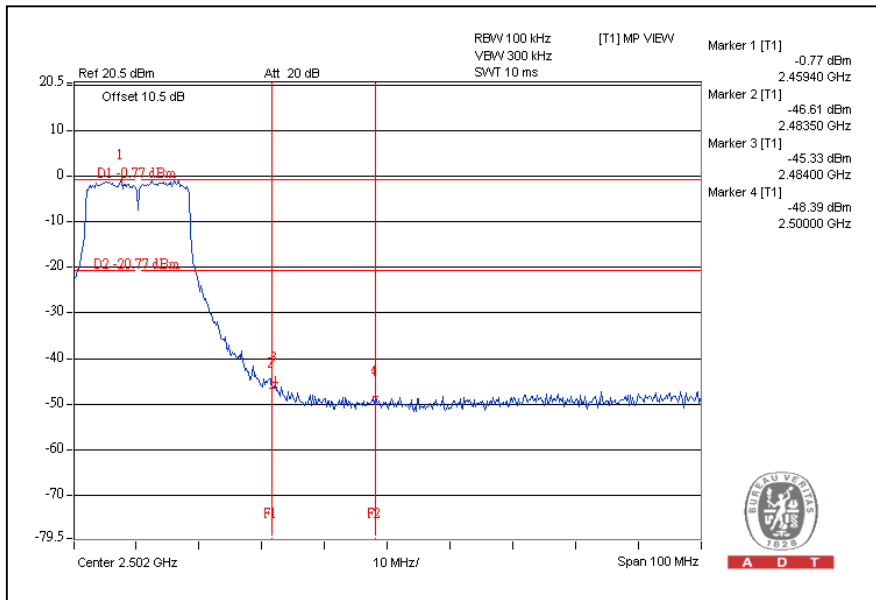

802.11n (20MHz) OFDM MODULATION:

CH1

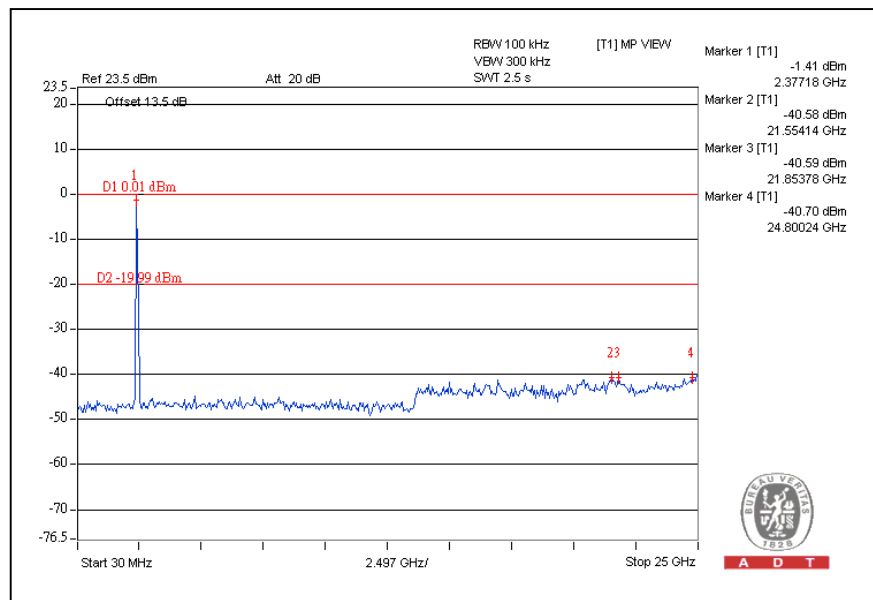
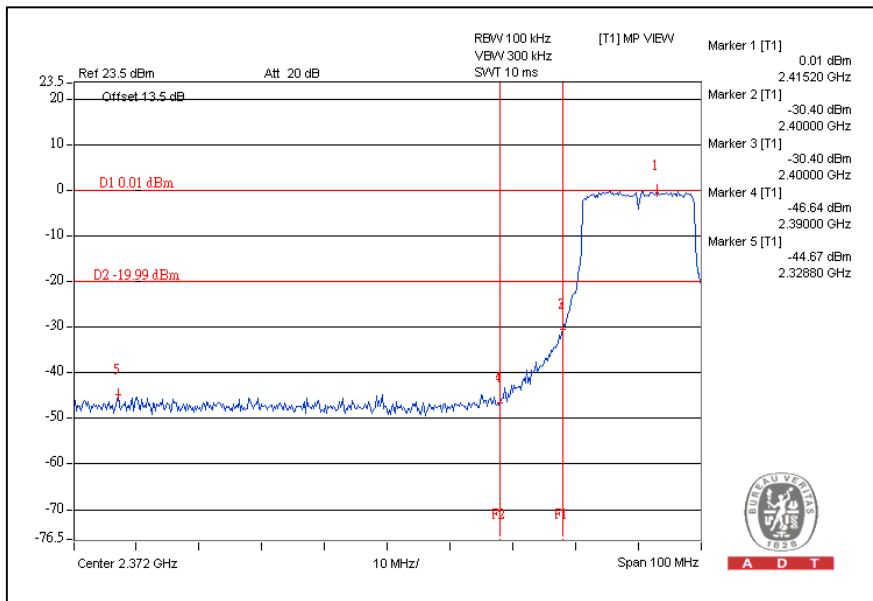



A D T

CH11

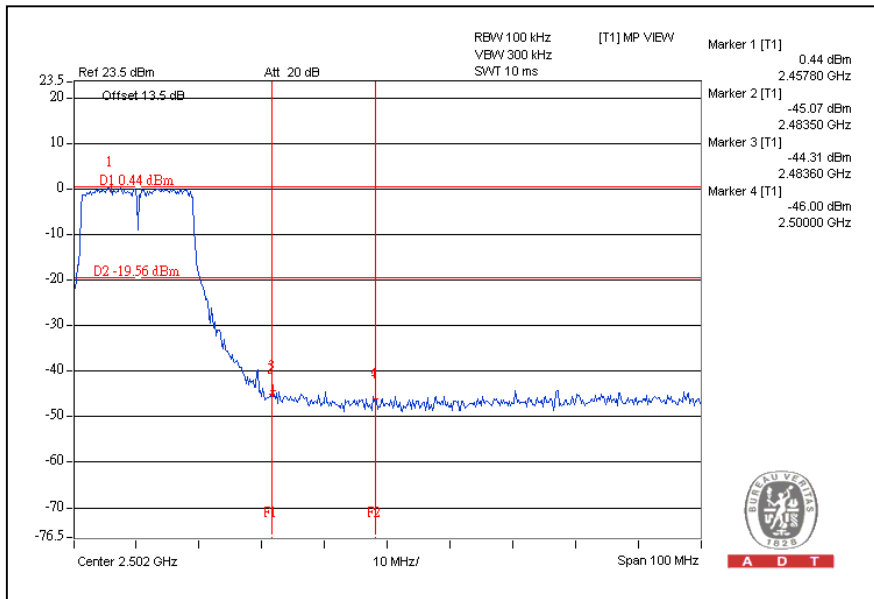

A D T

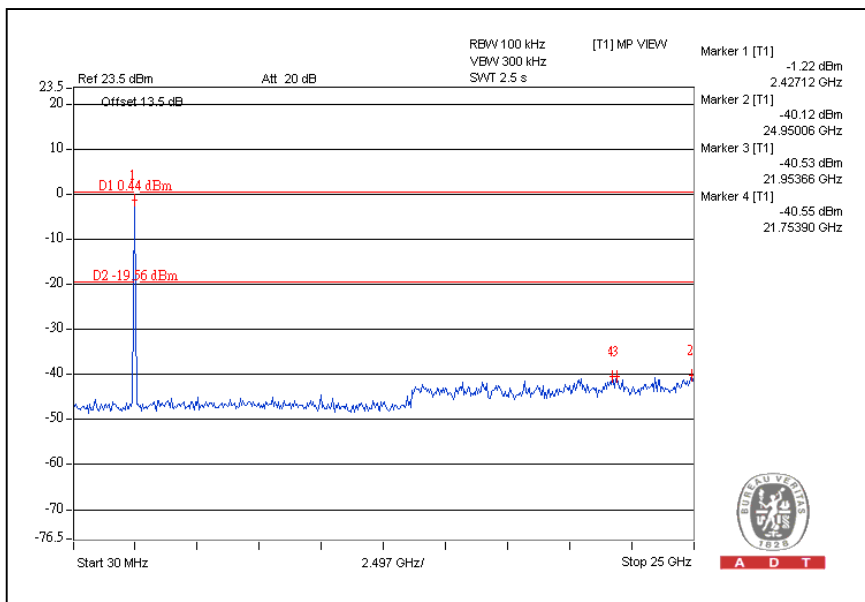

A D T

802.11n (40MHz) OFDM MODULATION:

CH3

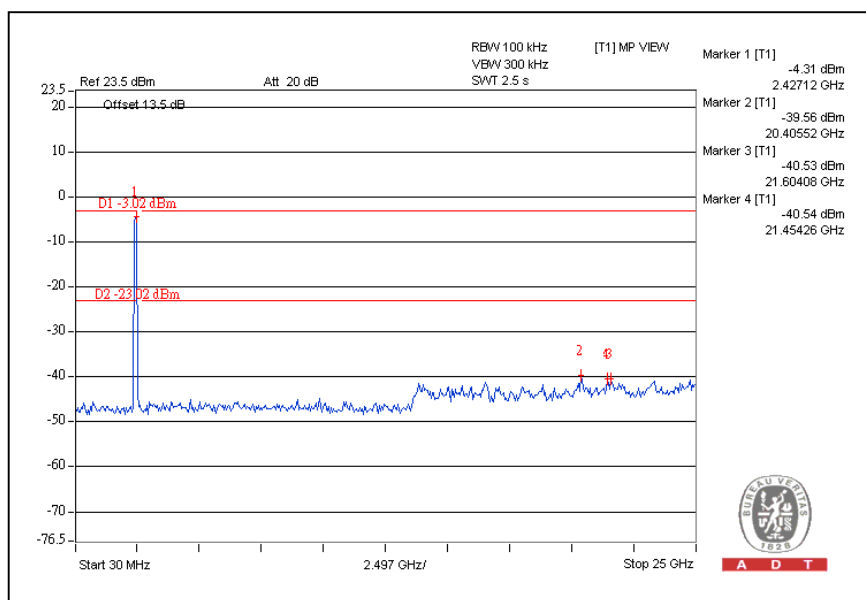
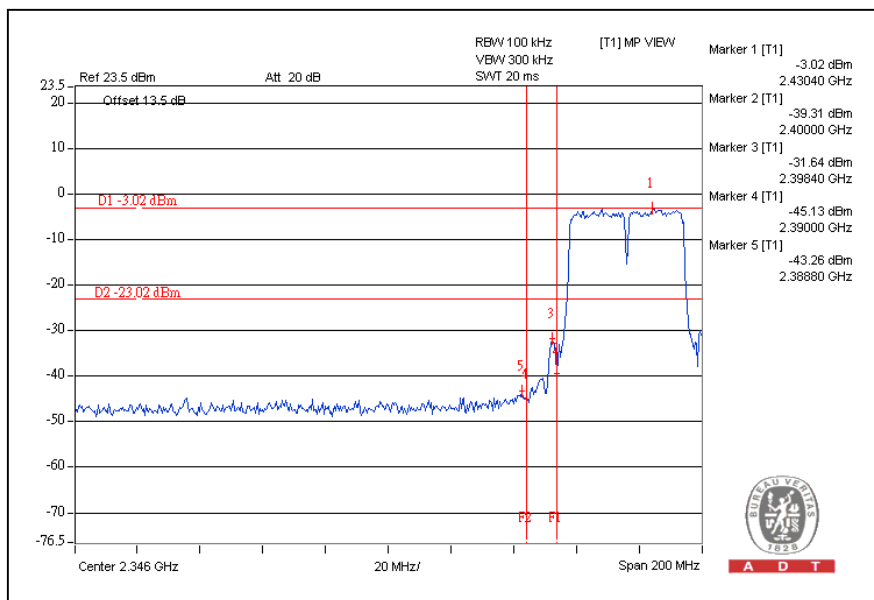



A D T

CH9

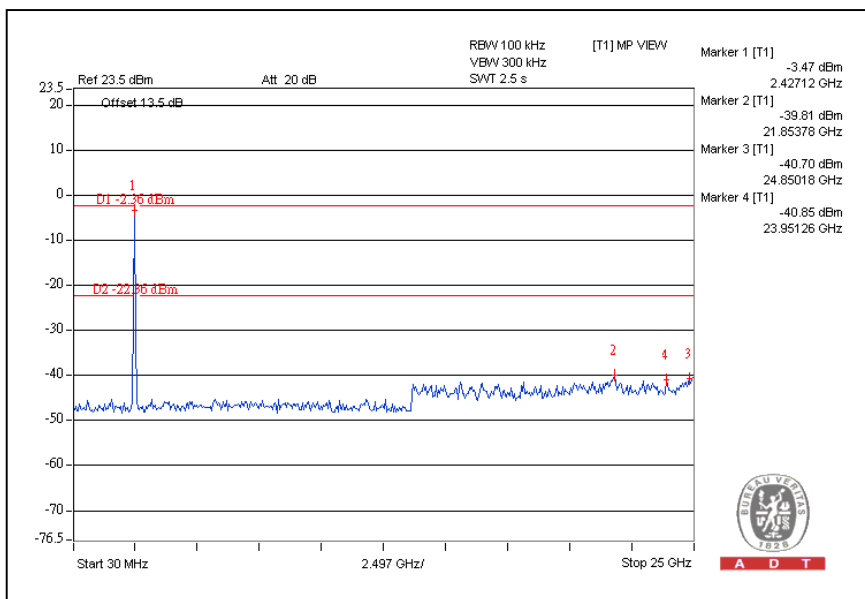
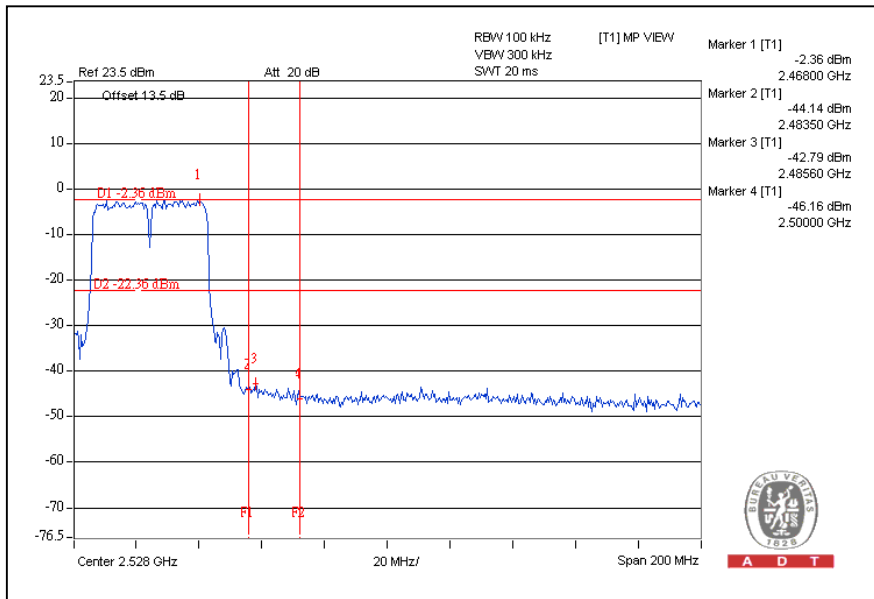



5. INFORMATION ON THE TESTING LABORATORIES

We, Bureau Veritas Consumer Products Services (H.K.) Ltd., Taoyuan Branch, were founded in 1988 to provide our best service in EMC, Radio, Telecom and Safety consultation. Our laboratories are accredited and approved according to ISO/IEC 17025.

Copies of accreditation and authorization certificates of our laboratories obtained from approval agencies can be downloaded from our web site:

www.adt.com.tw/index.5.phtml.

If you have any comments, please feel free to contact us at the following:

Linko EMC/RF Lab:

Tel: 886-2-26052180

Fax: 886-2-26052943

Hsin Chu EMC/RF Lab:

Tel: 886-3-5935343

Fax: 886-3-5935342

Hwa Ya EMC/RF/Safety Telecom Lab:

Tel: 886-3-3183232

Fax: 886-3-3185050

Email: service.adt@tw.bureauveritas.com

Web Site: www.adt.com.tw

The address and road map of all our labs can be found in our web site also



A D T

6.APPENDIX A - MODIFICATIONS RECORDERS FOR ENGINEERING CHANGES TO THE EUT BY THE LAB

No any modifications are made to the EUT by the lab during the test.

--- END ---