



中国认可
国际互认
检测
TESTING
CNAS L3193

TEST REPORT

Applicant Name : Grandstream Networks, Inc.
 Address : 126 Brookline Ave., 3rd Floor Boston, MA 02215, USA
 Report Number : SZ1220113-01811E-00
 FCC ID: YZZGXW4216V2

Test Standard (s)
 FCC PART 15B, CLASS B

Sample Description

Product Type: Analog IP Gateway
 Model No.: GXW4216 V2
 Trade Mark: GRANDSTREAM
 Date Received: 2022-01-13
 Date of Test: 2022-01-15 to 2022-01-17
 Report Date: 2022-01-19

Test Result:	Pass*
--------------	-------

* In the configuration tested, the EUT complied with the standards above.

Prepared and Checked By:

Approved By:

Amy Cao

Candy Li

Amy Cao
 EMC Engineer

Candy Li
 EMC Engineer

Note: This report may contain data that are not covered by the A2LA accreditation and are marked with an asterisk "★".

Shenzhen Accurate Technology Co., Ltd. is not responsible for the authenticity of any test data provided by the applicant. Data included from the applicant that may affect test results are marked with an asterisk "*". Customer model name, addresses, names, trademarks etc. are not considered data.

This report cannot be reproduced except in full, without prior written approval of the Company. Unless otherwise stated the results shown in this test report refer only to the sample(s) tested. This report is valid only with a valid digital signature. The digital signature may be available only under the Adobe software above version 7.0.

Shenzhen Accurate Technology Co., Ltd.

1/F., Building A, Changyuan New Material Port, Science & Industry Park, Nanshan District, Shenzhen, Guangdong, P.R. China

Tel: +86 755-26503290

Fax: +86 755-26503396

Web: www.atc-lab.com

TABLE OF CONTENTS

1. TEST RESULTS SUMMARY	4
2. GENERAL INFORMATION	5
2.1. Description of Device (EUT)	5
2.2. Test mode	5
2.3. General disclaimer	5
2.4. Accessory and Auxiliary Equipment and Cables	6
2.5. Description of Test Facility	6
2.6. Measurement Uncertainty	6
3. MEASURING DEVICE AND TEST EQUIPMENT	7
3.1. For Conducted Emission Test	7
3.2. For Radiated Emission Measurement	7
4. CONDUCTED EMISSION MEASUREMENT	8
4.1. Block Diagram of Test Setup	8
4.2. Power Line Conducted Emission Measurement Limits (Class B)	9
4.3. Test mode description	9
4.4. Manufacturer	9
4.5. Operating Condition of EUT	9
4.6. Test Procedure	10
4.7. Data Explain	10
4.8. Power Line Conducted Emission Measurement Results	10
5. RADIATED EMISSION MEASUREMENT	15
5.1. Block Diagram of Test Setup	15
5.2. Radiated Emission Limit (Class B)	16
5.3. Test mode description	17
5.4. Manufacturer	17
5.5. Operating Condition of EUT	17
5.6. Test Procedure	18
5.7. Data Sample	18
5.8. Radiated Emission Measurement Result	18

Test Report Declaration

Applicant : Grandstream Networks, Inc.
Manufacturer : Grandstream Networks, Inc.
Product : Analog IP Gateway
Model No. : GXW4216 V2
Trade Mark : GRANDSTREAM

Measurement Procedure Used:

FCC Rules and Regulations Part 15 Subpart B Class B ANSI C63.4: 2014

The device described above is tested by Shenzhen Accurate Technology Co., Ltd. to determine the maximum emission levels emanating from the device. The maximum emission levels are compared to the FCC Part 15 Subpart B Class B limits both radiated and conducted emissions. The measurement results are contained in this test report and Shenzhen Accurate Technology Co., Ltd. is assumed full responsibility for the accuracy and completeness of these measurements. Also, this report shows that the Equipment Under Test (EUT) is to be technically compliant with the FCC requirements.

This report applies to above tested sample only. This report shall not be reproduced in part without written approval of Shenzhen Accurate Technology Co., Ltd.

1. TEST RESULTS SUMMARY

Test Items	Test Standard	Test Results
Conducted Emission (150kHz-30MHz)	FCC Part 15 Subpart B Class B	Pass
Radiated Emission (30-1000MHz and Above 1GHz)	FCC Part 15 Subpart B Class B	Pass

2. GENERAL INFORMATION

2.1. Description of Device (EUT)

Product : Analog IP Gateway

Model No. : GXW4216 V2

Rating : AC 100-240V, 50/60Hz
(The DC output line length is 0.95 meters, AC input line length is 1.10 meters)

Adapter : Model: NBS65A120500M3
INPUT: 100-240V~,50/60Hz,1.5A
OUTPUT: 12V 5A

Remark(s) : The EUT highest operating frequency is 400MHz, the radiated emission measurement shall be made up to 2GHz

Applicant : Grandstream Networks, Inc.
Address : 126 Brookline Ave., 3rd Floor Boston, MA 02215, USA
Manufacturer : Grandstream Networks, Inc.
Address : 126 Brookline Ave., 3rd Floor Boston, MA 02215, USA
Sample Number : SZ1220113-01811E-EM-S1

2.2. Test mode

Test mode 1: Full Load (RJ11)
Test mode 2: Full Load (RJ21)

2.3. General disclaimer

1. Each test item follows test standard and with no deviation.
2. The test results presented in this report relate only to the object tested. The information supplied by the customer can affect the validity of results.

2.4. Accessory and Auxiliary Equipment and Cables

FXS Test Tool : Manufacturer: ASKPCB
Model: E239218
1200Mbps wireless : Manufacturer: HUAWEI
router Model: WS5100 12V0.5A

The Ethernet cable length is 8 meters, and the telephone line length is 3 meters, the Telco cable length is 1.4 meters.

2.5. Description of Test Facility

Name of Firm : Shenzhen Accurate Technology Co., Ltd.
Site Location : 1/F., Building A, Changyuan New Material Port, Science & Industry Park, Nanshan District, Shenzhen, Guangdong, P.R. China

2.6. Measurement Uncertainty

Radiated emission expanded uncertainty : $U=4.28dB, k=2$
(30MHz-1000MHz)
Radiated emission expanded uncertainty : $U=4.98dB, k=2$
(1GHz-18GHz)
Conduction Emission Expanded Uncertainty : $U=2.72dB, k=2$
(150kHz-30MHz)

3. MEASURING DEVICE AND TEST EQUIPMENT

3.1. For Conducted Emission Test

Item	Equipment	Manufacturer	Model No.	Serial No.	Calibration Date	Calibration Due Date
1.	Rohde& Schwarz	EMI Test Receiver	ESCI	100784	2021/12/13	2022/12/12
2.	Rohde & Schwarz	L.I.S.N.	ENV216	101314	2021/12/13	2022/12/12
3.	Unknown	RF Coaxial Cable	No.17	N0350	2021/12/14	2022/12/13
4.	Conducted Emission Test Software: e3 19821b (V9)					

3.2. For Radiated Emission Measurement

Item	Equipment	Manufacturer	Model No.	Serial No.	Calibration Date	Calibration Due Date
1.	Rohde& Schwarz	Test Receiver	ESR	102725	2021/12/13	2022/12/12
2.	Rohde&Schwarz	Spectrum Analyzer	FSV40	101949	2021/12/13	2022/12/12
3.	SONOMA INSTRUMENT	Amplifier	310 N	186131	2021/11/09	2022/11/08
4.	A.H. Systems, inc.	Preamplifier	PAM-0118P	135	2021/11/09	2022/11/08
5.	Schwarzbeck	Bilog Antenna	VULB9163	9163-323	2021/07/06	2024/07/05
6.	Schwarzbeck	Horn Antenna	BBHA9120D	9120D-1067	2020/01/05	2023/01/04
7.	Unknown	RF Coaxial Cable	No.10	N050	2021/12/14	2022/12/13
8.	Unknown	RF Coaxial Cable	No.11	N1000	2021/12/14	2022/12/13
9.	Unknown	RF Coaxial Cable	No.12	N040	2021/12/14	2022/12/13
10.	Unknown	RF Coaxial Cable	No.13	N300	2021/12/14	2022/12/13
11.	Unknown	RF Coaxial Cable	No.14	N800	2021/12/14	2022/12/13
12.	Unknown	RF Coaxial Cable	No.15	N600	2021/12/14	2022/12/13
13.	Radiated Emission Test Software: e3 19821b (V9)					

4. CONDUCTED EMISSION MEASUREMENT

4.1. Block Diagram of Test Setup

4.1.1. Block diagram of connection between the EUT and simulators

Test mode 1: Full Load (RJ11)

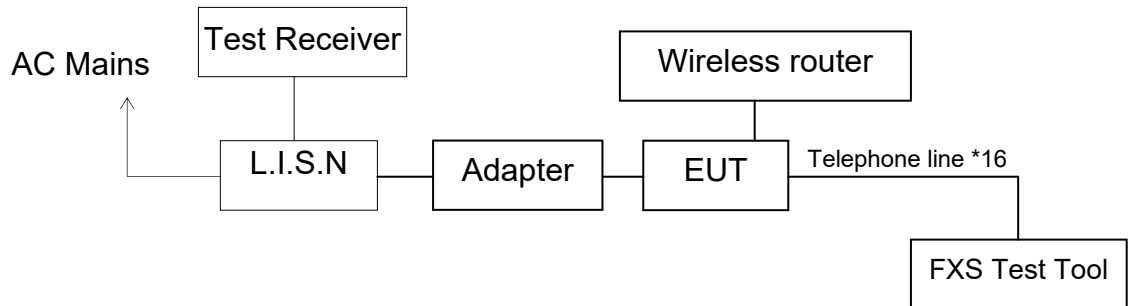

Test mode 2: Full Load (RJ21)

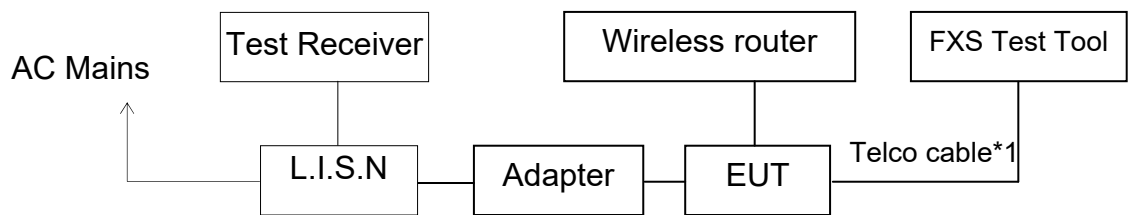

(EUT: Analog IP Gateway)

4.1.2. Test System Setup

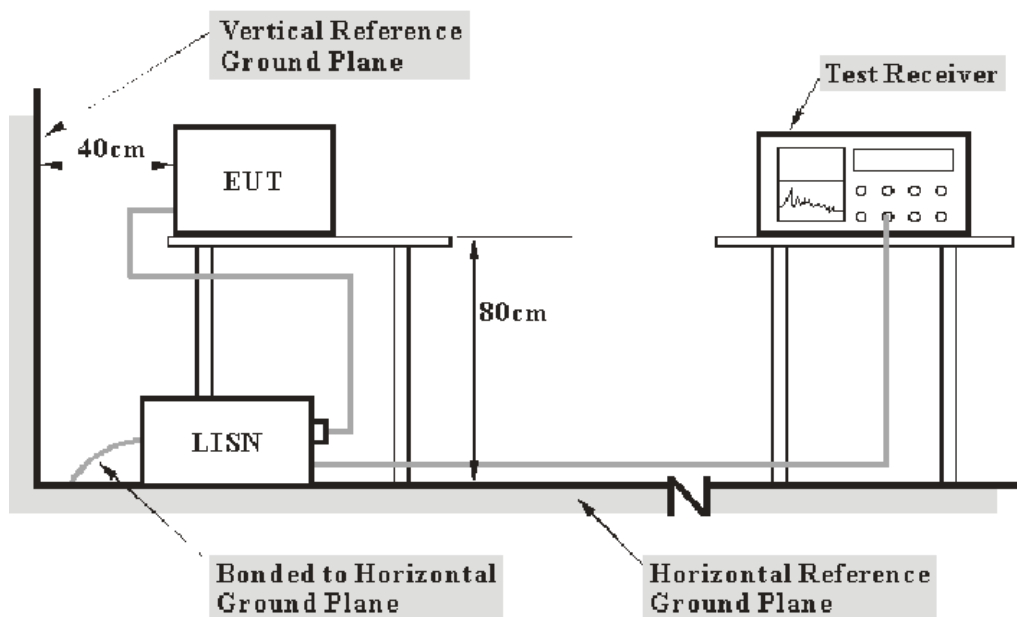

Note: 1. Support units were connected to second LISN.
 2. Both of LISNs (AMN) 80 cm from EUT and at the least 80 cm from other units and other metal planes support units.

4.2. Power Line Conducted Emission Measurement Limits (Class B)

Frequency (MHz)	Limit dB(μ V)	
	Quasi-peak Level	Average Level
0.15 - 0.50	66.0 – 56.0 *	56.0 – 46.0 *
0.50 - 5.00	56.0	46.0
5.00 - 30.00	60.0	50.0

NOTE1: The lower limit shall apply at the transition frequencies.
NOTE2: The limit decreases linearly with the logarithm of the frequency in the range 0.15MHz to 0.50MHz.

4.3. Test mode description

Test mode 1: Full Load (RJ11)

Test mode 2: Full Load (RJ21)

4.3.1. Environmental Conditions

Temperature : 23 °C

Relative Humidity : 54%

ATM Pressure : 101 kPa

The testing was performed by Bin Duan on 2022-01-15.

4.4. Manufacturer

The following equipments are installed on Power Line Conducted Emission Measurement to meet the commission requirement and operating regulations in a manner, which tends to maximize its emission characteristics in a normal application.

4.4.1. Analog IP Gateway (EUT)

Model Number : GXW4216 V2

Manufacturer : Grandstream Networks, Inc.

4.5. Operating Condition of EUT

4.5.1. Setup the EUT and simulator as shown as Section 4.1.

4.5.2. Turn on the power of all equipments.

4.5.3. Let the EUT work in test mode and measure it.

4.6. Test Procedure

The EUT is put on the plane 0.8m high above the ground by insulating support and is connected to the power mains through a line impedance stabilization network (L.I.S.N.). This provides a 50ohm coupling impedance for the EUT system. Please refer the block diagram of the test setup and photographs. Both sides of AC lines are checked to find out the maximum conducted emission. In order to find the maximum emission levels, the relative positions of equipment and all of the interface cables shall be changed according to ANSI C63.4: 2014 on Conducted Emission Measurement.

The bandwidth of test receiver is set at 9kHz.

The frequency range from 150kHz to 30MHz is checked.

4.7. Data Explain

Over limit = Level (dB μ V) - Limit (dB μ V)

4.8. Power Line Conducted Emission Measurement Results

PASS.

The frequency range from 150kHz to 30MHz is checked.

All data was recorded in the Quasi-peak and average detection mode.

The spectral diagrams are attached as below.

For test mode 1:

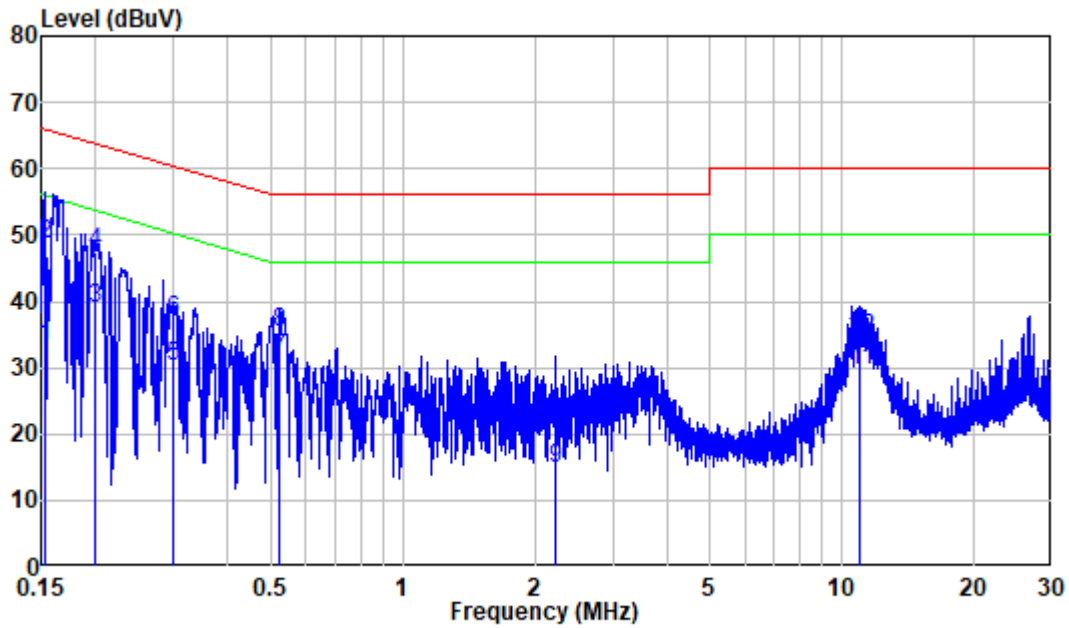

Site : Shielding Room
 Condition: Line
 Mode : FULL LOAD
 Model : GXW4216 V2
 Power : AC 120V 60Hz
 Note : RJ11 Port

	Freq	Factor	Read Level	Level	Limit Line	Over Limit	Remark
	MHz	dB	dBuV	dBuV	dBuV	dB	
1	0.153	9.80	23.52	33.32	55.82	-22.50	Average
2	0.153	9.80	38.78	48.58	65.82	-17.24	QP
3	0.200	9.80	29.23	39.03	53.62	-14.59	Average
4	0.200	9.80	37.54	47.34	63.62	-16.28	QP
5	0.301	9.80	20.38	30.18	50.22	-20.04	Average
6	0.301	9.80	27.21	37.01	60.22	-23.21	QP
7	0.521	9.81	21.48	31.29	46.00	-14.71	Average
8	0.521	9.81	25.64	35.45	56.00	-20.55	QP
9	2.216	9.82	4.85	14.67	46.00	-31.33	Average
10	2.216	9.82	11.52	21.34	56.00	-34.66	QP
11	10.977	9.91	19.66	29.57	50.00	-20.43	Average
12	10.977	9.91	24.45	34.36	60.00	-25.64	QP

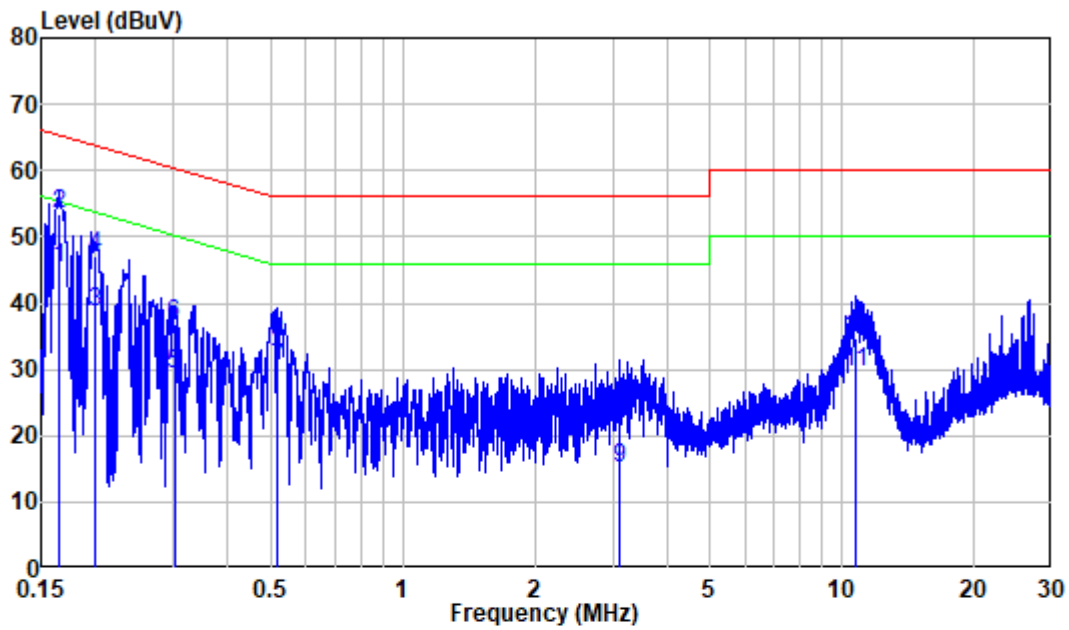

Site : Shielding Room
 Condition: Neutral
 Mode : FULL LOAD
 Model : GXW4216 V2
 Power : AC 120V 60Hz
 Note : RJ11 Port

	Freq	Factor	Read Level	Limit Level	Limit Line	Over Limit	Remark
	MHz	dB	dBuV	dBuV	dBuV	dB	
1	0.165	9.80	35.34	45.14	55.22	-10.08	Average
2	0.165	9.80	43.58	53.38	65.22	-11.84	QP
3	0.200	9.80	28.95	38.75	53.62	-14.87	Average
4	0.200	9.80	37.38	47.18	63.62	-16.44	QP
5	0.301	9.80	19.49	29.29	50.20	-20.91	Average
6	0.301	9.80	27.06	36.86	60.20	-23.34	QP
7	0.518	9.81	20.32	30.13	46.00	-15.87	Average
8	0.518	9.81	24.42	34.23	56.00	-21.77	QP
9	3.111	9.83	5.37	15.20	46.00	-30.80	Average
10	3.111	9.83	13.03	22.86	56.00	-33.14	QP
11	10.683	10.01	19.67	29.68	50.00	-20.32	Average
12	10.683	10.01	24.70	34.71	60.00	-25.29	QP

For test mode 2:

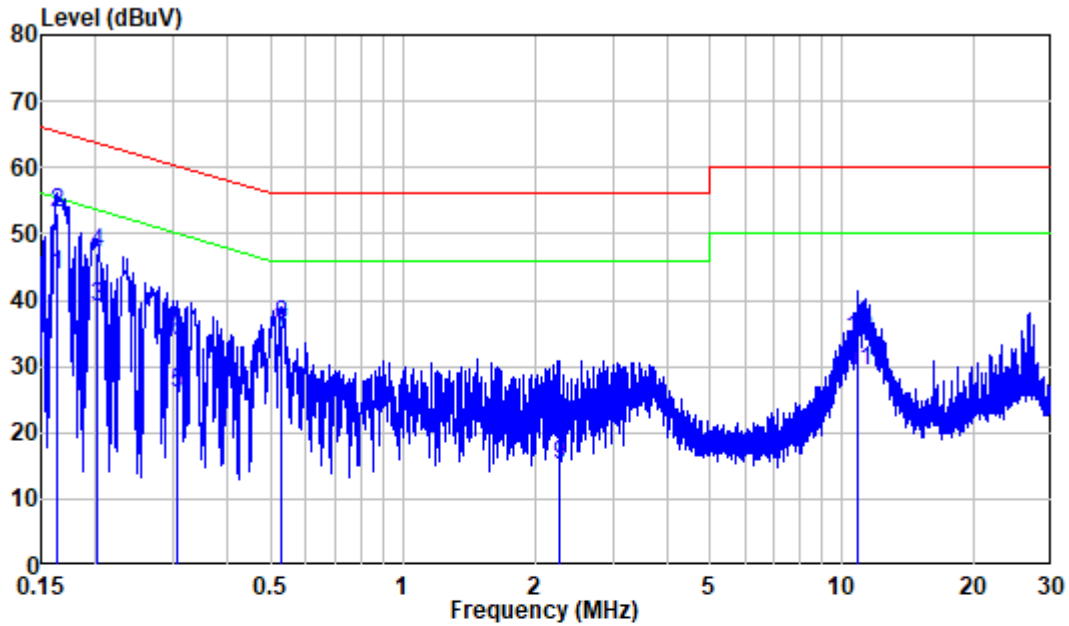

Site : Shielding Room
 Condition: Line
 Mode : FULL LOAD
 Model : GXW4216 V2
 Power : AC 120V 60Hz
 Note : RJ21 Port

	Freq	Factor	Read Level	Limit Level	Over Limit	Remark
	MHz	dB	dBuV	dBuV	dBuV	dB
1	0.163	9.87	33.99	43.86	55.33	-11.47 Average
2	0.163	9.87	43.12	52.99	65.33	-12.34 QP
3	0.201	9.80	29.23	39.03	53.57	-14.54 Average
4	0.201	9.80	37.42	47.22	63.57	-16.35 QP
5	0.308	9.80	16.17	25.97	50.04	-24.07 Average
6	0.308	9.80	24.07	33.87	60.04	-26.17 QP
7	0.527	9.81	25.31	35.12	46.00	-10.88 Average
8	0.527	9.81	26.46	36.27	56.00	-19.73 QP
9	2.268	9.92	5.03	14.95	46.00	-31.05 Average
10	2.268	9.92	11.14	21.06	56.00	-34.94 QP
11	10.891	10.09	19.07	29.16	50.00	-20.84 Average
12	10.891	10.09	23.91	34.00	60.00	-26.00 QP

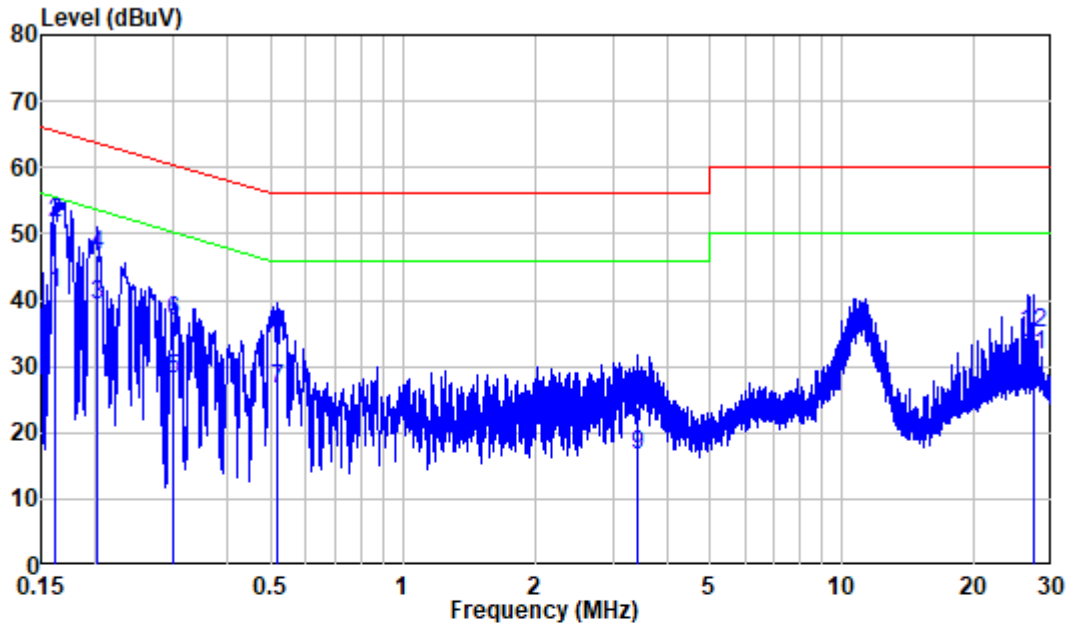

Site : Shielding Room
 Condition: Neutral
 Mode : FULL LOAD
 Model : GXW4216 V2
 Power : AC 120V 60Hz
 Note : RJ21 Port

	Freq	Factor	Read Level	Limit Level	Limit Line	Over Limit	Remark
	MHz	dB	dBuV	dBuV	dBuV	dB	
1	0.161	9.80	31.18	40.98	55.40	-14.42	Average
2	0.161	9.80	41.73	51.53	65.40	-13.87	QP
3	0.202	9.80	29.46	39.26	53.54	-14.28	Average
4	0.202	9.80	37.08	46.88	63.54	-16.66	QP
5	0.301	9.80	18.28	28.08	50.22	-22.14	Average
6	0.301	9.80	27.10	36.90	60.22	-23.32	QP
7	0.518	9.81	16.70	26.51	46.00	-19.49	Average
8	0.518	9.81	25.02	34.83	56.00	-21.17	QP
9	3.404	9.83	6.76	16.59	46.00	-29.41	Average
10	3.404	9.83	14.05	23.88	56.00	-32.12	QP
11	27.163	10.17	21.61	31.78	50.00	-18.22	Average
12	27.163	10.17	24.77	34.94	60.00	-25.06	QP

5. RADIATED EMISSION MEASUREMENT

5.1. Block Diagram of Test Setup

5.1.1. Block diagram of connection between the EUT and simulators

Test mode 1: Full Load (RJ11)

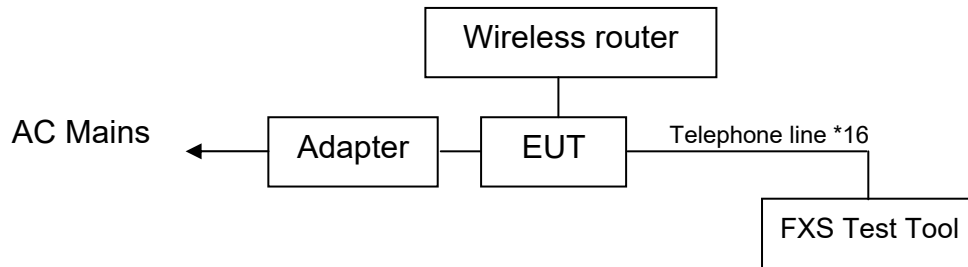

Test mode 2: Full Load (RJ21)

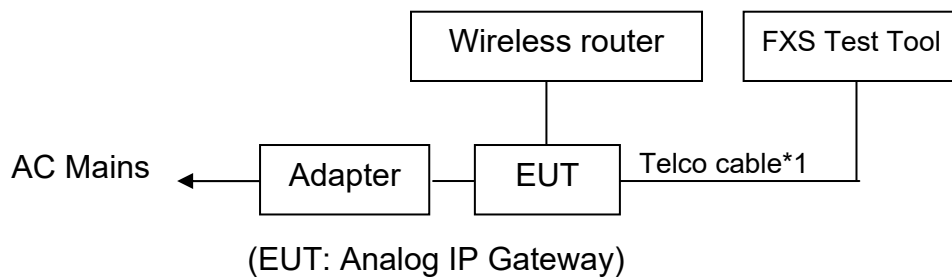

5.1.2. Test System Setup

Below 1GHz:

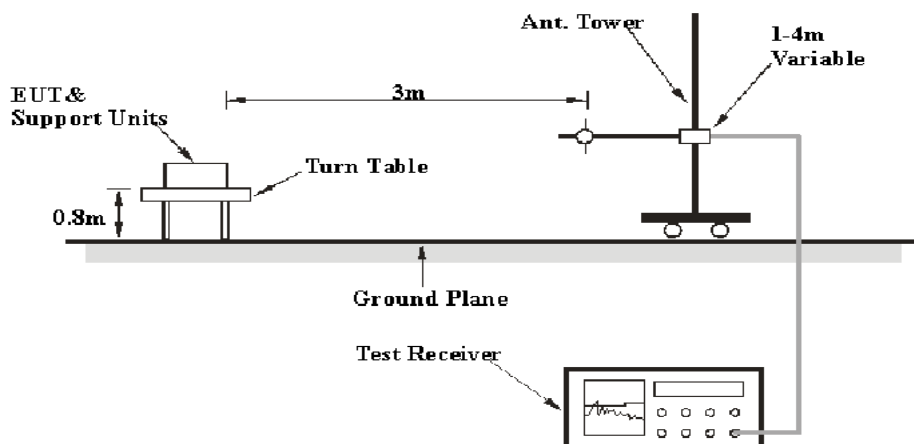

Above 1GHz:

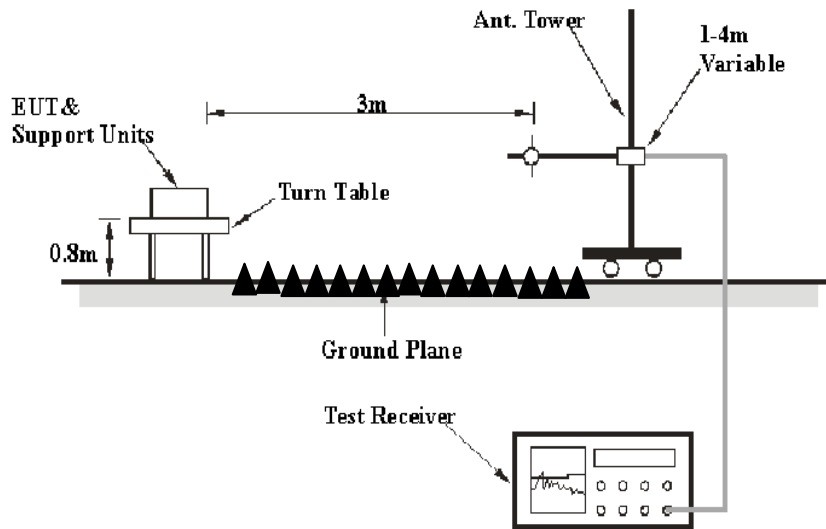

5.2. Radiated Emission Limit (Class B)

All emanations from a class B device or system, including any network of conductors and apparatus connected thereto, shall not exceed the level of field strengths specified below:

Below 1GHz:

Frequency MHz	Distance Meters	Field Strengths Limit	
		$\mu\text{V/m}$	$\text{dB}(\mu\text{V/m})$
30-88	3	100	40.0
88-216	3	150	43.5
216-960	3	200	46.0
960-1000	3	500	54.0

Remark:

- (1) Emission level $\text{dB}(\mu\text{V}) = 20 \log$ Emission level $\mu\text{V/m}$.
- (2) The smaller limit shall apply at the cross point between two frequency bands.
- (3) Distance is the distance in meters between the measuring instrument antenna and the closest point of any part of the device or system.

Above 1GHz:

Frequency MHz	Distance Meters	Field Strengths Limit($\text{dB}\mu\text{V/m}$)	
		Peak	Average
Above 1000MHz	3	74.0	54.0

5.3. Test mode description

Test mode 1: Full Load (RJ11)

Test mode 2: Full Load (RJ21)

5.3.1. Environmental Conditions

Temperature : 21 °C

Relative Humidity : 60 %

ATM Pressure : 101 kPa

The testing was performed by Chao Mo on 2022-01-17.

5.4. Manufacturer

The following equipments are installed on Radiated Emission Measurement to meet the commission requirement and operating regulations in a manner, which tends to maximize its emission characteristics in a normal application.

5.4.1. Analog IP Gateway (EUT)

Model Number : GXW4216 V2

Manufacturer : Grandstream Networks, Inc.

5.5. Operating Condition of EUT

5.5.1. Setup the EUT and simulator as shown as Section 5.1.

5.5.2. Turn on the power of all equipments.

5.5.3. Let the EUT work in test mode and measure it.

5.6. Test Procedure

The EUT and its simulators are placed on a turntable, which is 0.8 meter high above ground. The turntable can rotate 360 degrees to determine the position of the maximum emission level. EUT is set 3.0 meters away from the receiving antenna, which is mounted on an antenna tower. The antenna can be moved up and down between 1.0 meter and 4 meters to find out the maximum emission level. Broadband antenna (calibrated bilog antenna) is used as receiving antenna. Both horizontal and vertical polarizations of the antenna are set on measurement. In order to find the maximum emission levels, all of the interface cables must be manipulated according to ANSI C63.4: 2014 on radiated emission measurement.

The bandwidth of the Receiver is set at 9kHz in 9kHz-30MHz, 120 kHz in 30-1000MHz, and 1MHz for above 1GHz.

The frequency range from 30MHz to 2GHz is investigated.

Highest frequency generated or used in the device or on which the device operates or tunes (MHz)	Upper frequency of measurement range (MHz)
Below 1.705	30.
1.705–108	1000.
108–500	2000.
500–1000	5000.
Above 1000	5th harmonic of the highest frequency or 40 GHz, whichever is lower.

5.7. Data Sample

Over Limit (dB) = Level(dBµv/m) - Limit (dBµv/m)
 QP = Quasi-peak Reading

The “Over Limit” column of the following data tables indicates the degree of compliance with the applicable limit. For example, an over Limit of -7dB means the emission is 7dB below the limit.

5.8. Radiated Emission Measurement Result

PASS.

The frequency range from 30MHz to 2GHz is investigated.

The spectral diagrams are attached as below.

For test mode 1:

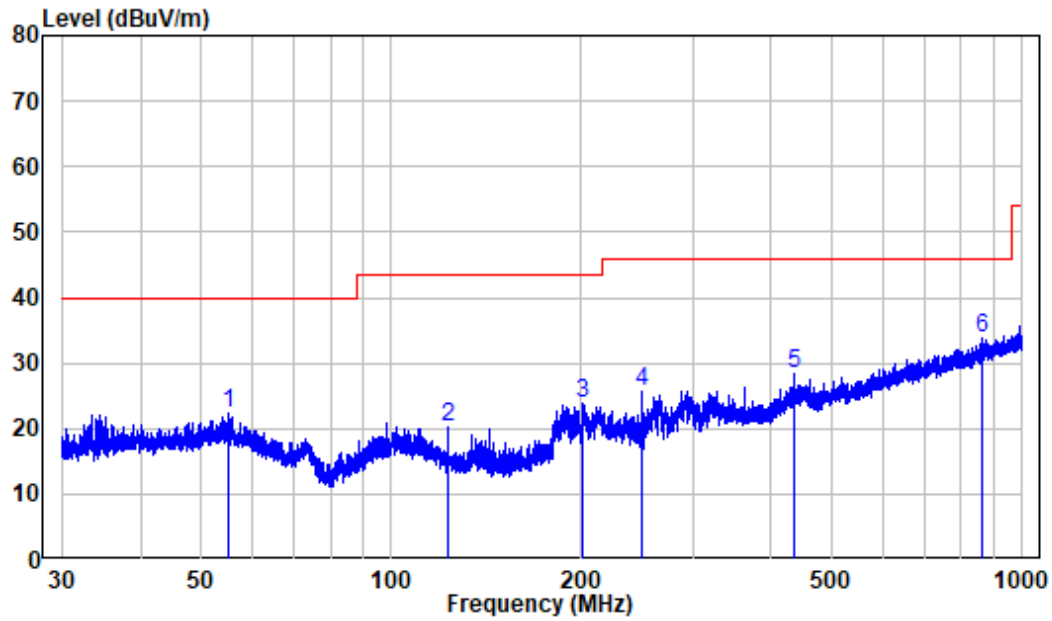

Site : chamber
 Condition: 3m HORIZONTAL
 Job No. : SZ1220113-01811E-EM
 Test Mode: FULL LOAD
 Note : RJ11

	Freq	Factor	Read Level	Level	Limit Line	Over Limit	Remark
	MHz	dB/m	dBuV	dBuV/m	dBuV/m	dB	
1	55.318	-10.25	32.52	22.27	40.00	-17.73	Peak
2	122.888	-14.05	34.17	20.12	43.50	-23.38	Peak
3	201.305	-11.51	35.21	23.70	43.50	-19.80	Peak
4	250.082	-10.75	36.36	25.61	46.00	-20.39	Peak
5	434.446	-5.72	34.13	28.41	46.00	-17.59	Peak
6	863.056	0.49	33.21	33.70	46.00	-12.30	Peak

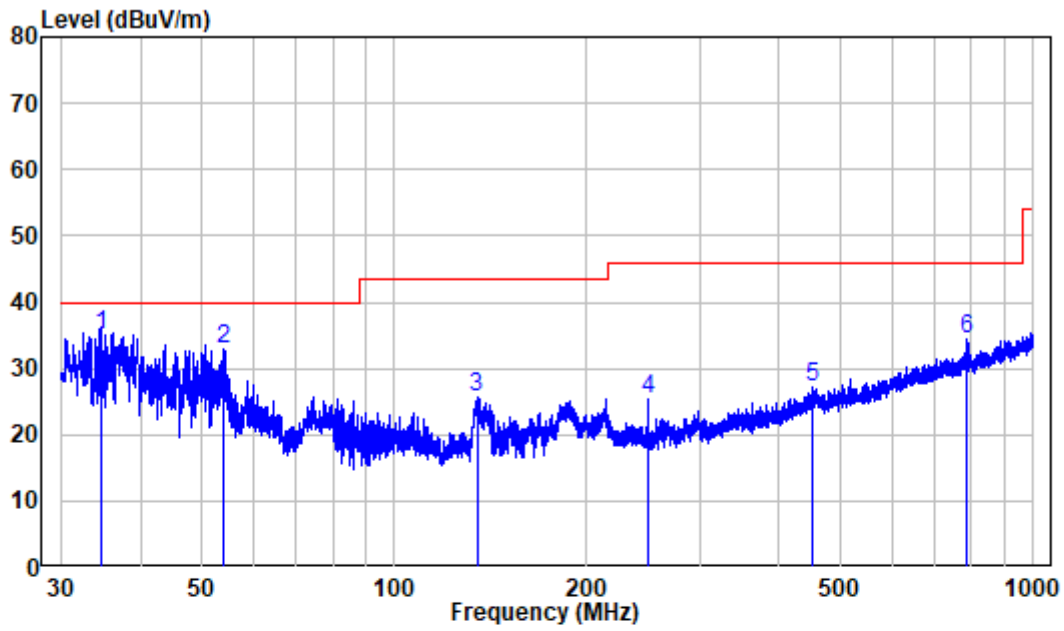

Site : chamber
 Condition: 3m VERTICAL
 Job No. : SZ1220113-01811E-EM
 Test Mode: FULL LOAD
 Note : RJ11

	Freq	Factor	Read Level	Limit Level	Limit Line	Over Limit	Remark
	MHz	dB/m	dBuV	dBuV/m	dBuV/m	dB	
1	34.639	-11.66	46.54	34.88	40.00	-5.12	QP
2	54.142	-10.34	43.37	33.03	40.00	-6.97	Peak
3	134.559	-15.00	40.69	25.69	43.50	-17.81	Peak
4	249.972	-10.74	36.13	25.39	46.00	-20.61	Peak
5	449.556	-5.63	32.92	27.29	46.00	-18.71	Peak
6	784.062	0.00	34.55	34.55	46.00	-11.45	Peak

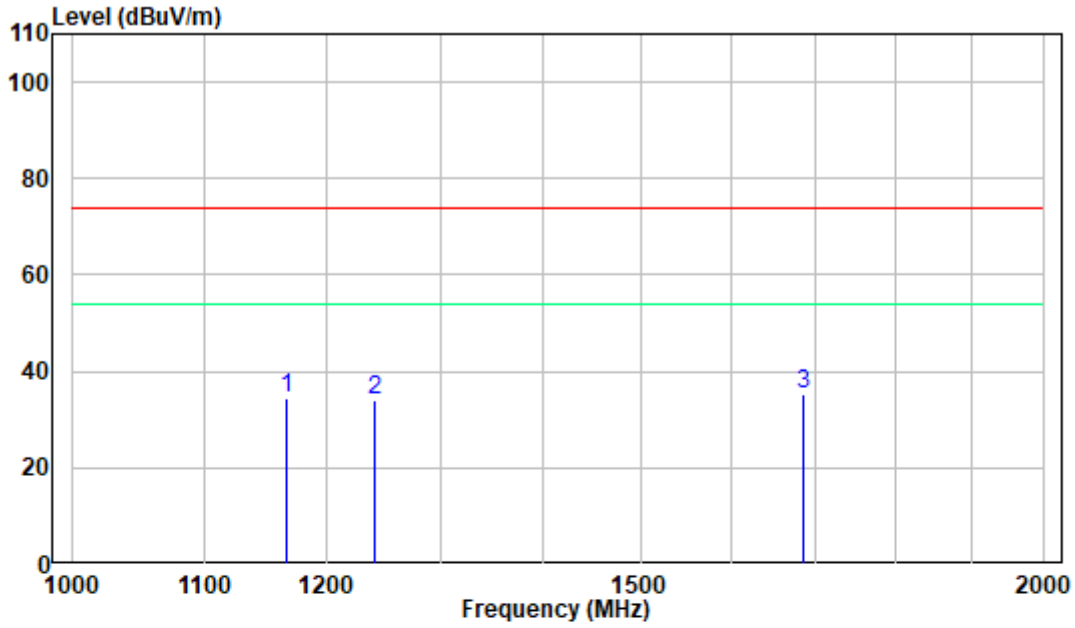

Site : chamber
 Condition: 3m HORIZONTAL
 Job No. : SZ1220113-01811E-EM
 Test Mode: FULL LOAD
 Note : RJ11

	Freq	Factor	Read Level	Read Level	Limit Line	Over Limit	Remark
	MHz	dB/m	dBuV	dBuV/m	dBuV/m	dB	
1	1165.000	-10.30	44.73	34.43	74.00	-39.57	Peak
2	1241.500	-10.13	43.97	33.84	74.00	-40.16	Peak
3	1685.250	-8.97	44.32	35.35	74.00	-38.65	Peak

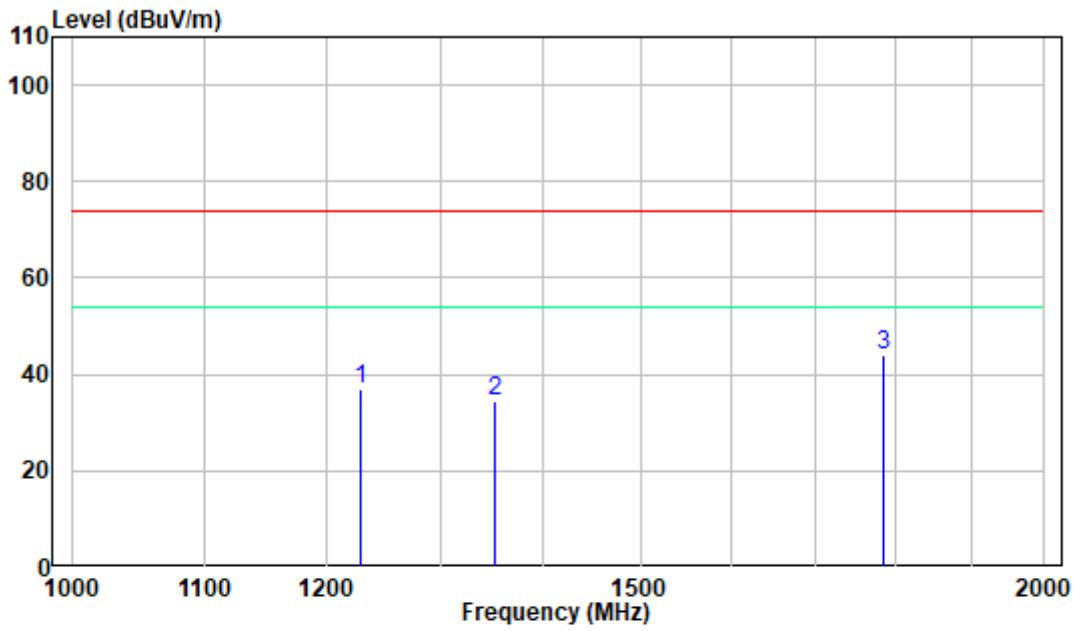

Site : chamber
 Condition: 3m VERTICAL
 Job No. : SZ1220113-01811E-EM
 Test Mode: FULL LOAD
 Note : RJ11

	Freq	Factor	Read Level	Limit Level	Over Limit	Remark
	MHz	dB/m	dBuV	dBuV/m	dBuV/m	dB
1	1229.000	-10.17	47.24	37.07	74.00	-36.93 Peak
2	1351.375	-10.01	44.33	34.32	74.00	-39.68 Peak
3	1783.000	-8.79	52.88	44.09	74.00	-29.91 Peak

For test mode 2:

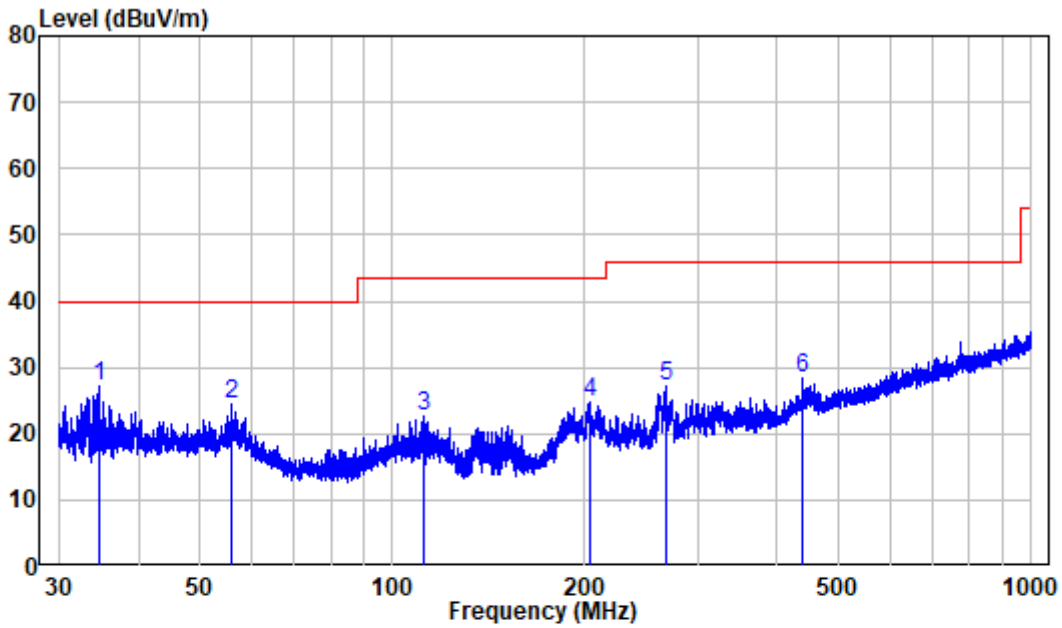

Site : chamber
 Condition: 3m HORIZONTAL
 Job No. : SZ1220113-01811E-EM
 Test Mode: FULL LOAD
 Note : RJ21

	Freq	Factor	Read Level	Limit Level	Limit Line	Over Limit	Remark
	MHz	dB/m	dBuV	dBuV/m	dBuV/m	dB	
1	34.654	-11.65	38.89	27.24	40.00	-12.76	Peak
2	55.976	-10.18	34.56	24.38	40.00	-15.62	Peak
3	111.591	-12.18	34.74	22.56	43.50	-20.94	Peak
4	203.434	-11.69	36.36	24.67	43.50	-18.83	Peak
5	267.898	-10.32	37.35	27.03	46.00	-18.97	Peak
6	437.503	-5.67	33.99	28.32	46.00	-17.68	Peak

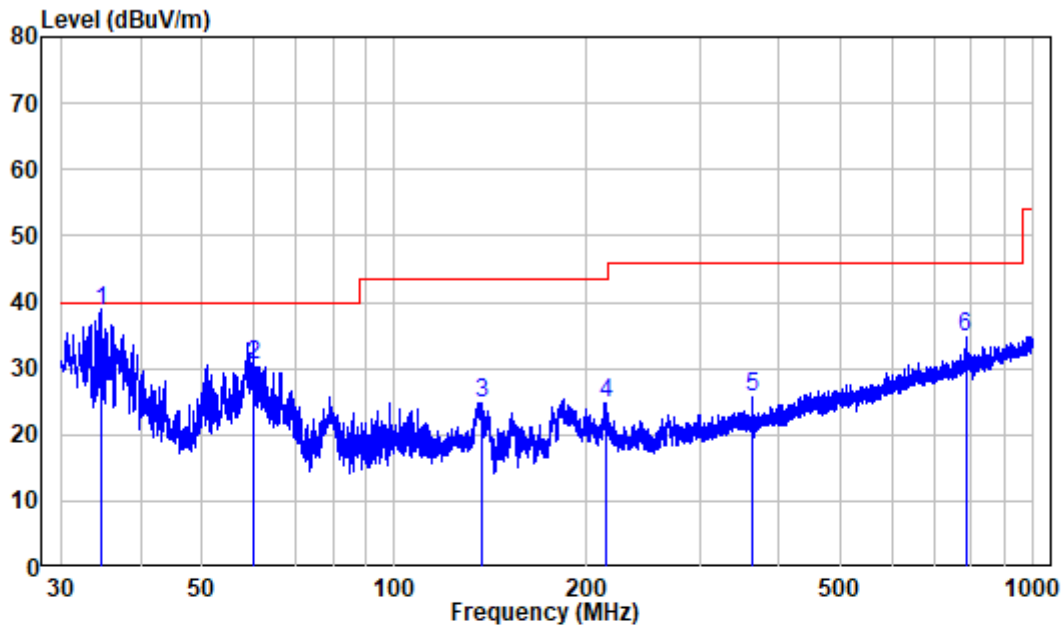

Site : chamber
 Condition: 3m VERTICAL
 Job No. : SZ1220113-01811E-EM
 Test Mode: FULL LOAD
 Note : RJ21

	Freq	Factor	Read Level	Limit Level	Limit Line	Over Limit	Remark
	MHz	dB/m	dBuV	dBuV/m	dBuV/m	dB	
1	34.623	-11.66	50.21	38.55	40.00	-1.45	QP
2	60.201	-10.70	41.25	30.55	40.00	-9.45	QP
3	136.879	-15.19	40.02	24.83	43.50	-18.67	Peak
4	214.702	-11.69	36.52	24.83	43.50	-18.67	Peak
5	362.031	-7.62	33.27	25.65	46.00	-20.35	Peak
6	783.718	0.01	34.85	34.86	46.00	-11.14	Peak

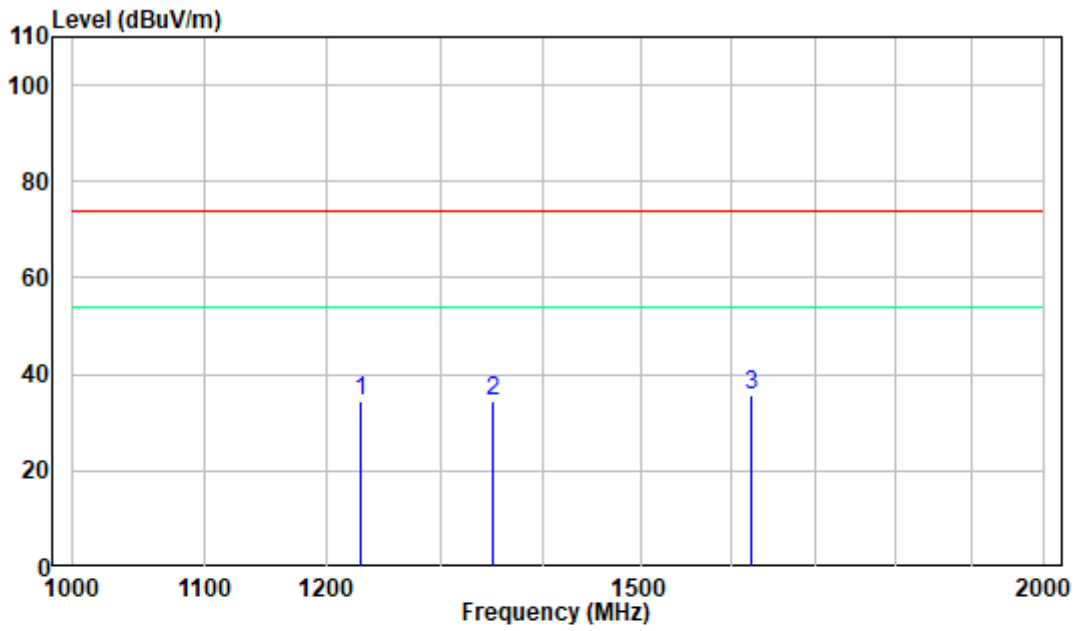

Site : chamber
 Condition: 3m HORIZONTAL
 Job No. : SZ1220113-01811E-EM
 Test Mode: FULL LOAD
 Note : RJ21

	Freq	Factor	Read Level	Limit Level	Over Limit	Remark
	MHz	dB/m	dBuV	dBuV/m	dBuV/m	dB
1	1229.125	-10.17	44.54	34.37	74.00	-39.63 Peak
2	1350.875	-10.01	44.44	34.43	74.00	-39.57 Peak
3	1623.375	-9.04	44.71	35.67	74.00	-38.33 Peak

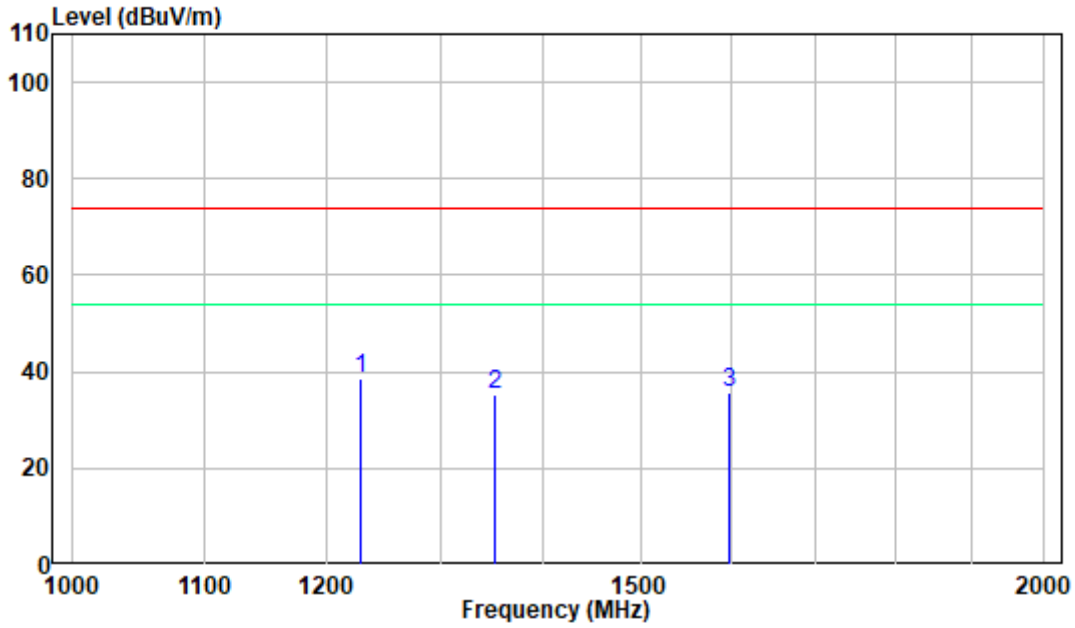

Site : chamber
 Condition: 3m VERTICAL
 Job No. : SZ1220113-01811E-EM
 Test Mode: FULL LOAD
 Note : RJ21

	Freq	Factor	Read Level	Limit Level	Over Limit	Remark
	MHz	dB/m	dBuV	dBuV/m	dBuV/m	dB
1	1229.125	-10.17	48.64	38.47	74.00	-35.53 Peak
2	1352.000	-10.01	45.17	35.16	74.00	-38.84 Peak
3	1597.000	-9.03	44.66	35.63	74.00	-38.37 Peak

Note 1:

Factor = Antenna factor (RX) + Cable Loss – Amplifier Factor

The other spurious emission which is in the noise floor level was not recorded.

Note 2: If the maximized peak measured value complies with the limit, then it is unnecessary to perform QP/Average measurement.

----- THE END OF TEST REPORT -----