

## EMI TEST REPORT

On Model Name: IP Camera

Model Number: GXV3601\_LL, GXV3601\_HD

Brand Name: Grandstream

Prepared for Grandstream Networks, INC

FCC ID Number: YZZGXV3601X

According to FCC 47 CFR Part 15, Subpart B

Test Report #: SHE-1108-10687-FCC

Prepared by: Sewen Guo

Reviewed by: Jawen Yin

QC Manager: Swall Zhang

Test Report Released by:

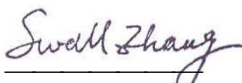
  
Swall Zhang

September 2, 2011

Date

## **Test Location**

*Tests performed in a Certified ANSI Semi-Anechoic Chamber and Shielded Room.*

*Test Site Location : Galanz*

*25 South Ronggui Rd., Shunde, Foshan,  
Guangdong, China*

*Tel : 86-757-23612785*

*Fax : 86-757-23612537*

## **Test Facility**

*The test facility was recognized, certified, or accredited by the following organizations:*

- *CNAL - LAB Code: L2244*

*Galanz EMC Laboratory has been assessed and in compliance with CNAL/AC01:2002 accreditation criteria for testing laboratories (identical to ISO/IEC 17025:2005 General Requirements) for the Competence of Testing Laboratories.*

- *FCC - Registration No.: 580210*

*Galanz EMC Laboratory has been registered and fully described in a report filed with the (FCC) Federal Communications Commission. The acceptance letter from the FCC was maintained in our files.*

# *Table of Contents*

---

<i>GOVERNMENT DISCLAIMER NOTICE</i> .....	2
<i>REPRODUCTION CLAUSE</i> .....	2
<i>OPINIONS AND INTERPRETATIONS</i> .....	2
<i>STATEMENT OF MEASUREMENT UNCERTAINTY</i> .....	2
<i>ADMINISTRATIVE DATA</i> .....	3
<i>EUT DESCRIPTION</i> .....	4
<i>EUT MODEL DERIVED</i> .....	5
<i>TEST SUMMARY</i> .....	6
<i>TEST MODE JUSTIFICATION</i> .....	7
<i>EUT EXERCISE SOFTWARE</i> .....	7
<i>EQUIPMENT MODIFICATION</i> .....	7
<i>EUT SAMPLE PHOTOS</i> .....	8
<i>TEST SYSTEM DETAILS</i> .....	16
<i>CONFIGURATION OF TESTED SYSTEM</i> .....	18
<i>ATTACHMENT 1 - CONDUCTED EMISSION TEST RESULTS</i> .....	19
<i>ATTACHMENT 2 - RADIATED EMISSION MEASUREMENT</i> .....	23

## List Attached Files

<i>Exhibit Type</i>	<i>File Description</i>	<i>File Name</i>
<i>Test Report</i>	<i>Test Report</i>	<i>YZZGXV3601X_Test report.pdf</i>
<i>Operation Description</i>	<i>Technical Description</i>	<i>YZZGXV3601X_operation description.pdf</i>
<i>External Photos</i>	<i>External Photos</i>	<i>YZZGXV3601X_External Photos</i>
<i>Internal Photos</i>	<i>Internal Photos</i>	<i>YZZGXV3601X_Internal Photos</i>
<i>Block Diagram</i>	<i>Block Diagram</i>	<i>YZZGXV3601X_Block Diagram.pdf</i>
<i>Schematics</i>	<i>Circuit Diagram</i>	<i>YZZGXV3601X_Schematics.pdf</i>
<i>ID Label/Location</i>	<i>Label and Location</i>	<i>YZZGXV3601X_Label &amp; Location.pdf</i>
<i>User Manual</i>	<i>User Manual</i>	<i>YZZGXV3601X_User Manual.pdf</i>
<i>Test setup photos</i>	<i>Test set-up photos</i>	<i>YZZGXV3601X_Test Set-up Photos</i>

### **Government Disclaimer Notice**

*When government drawing, specification, or other data are used for any purpose other than in connection with a definitely related government procurement operation, the United States Government thereby incurs no responsibility nor any obligation whatsoever; and the fact that the Government may have formulated, furnished, or in any way supplied the said drawing, specifications, or other data, is not to be regarded by implication or otherwise in any manner licensing the holder or any other person or corporation, or conveying any rights or permission to manufacture, use, or sell patented invention that may in any way be related thereto. This report must not be used to claim product endorsement by NVLAP or any agency of the U.S. Government.*

### **Reproduction Clause**

*Any reproduction of this document must be done in full. No single part of this document may be reproduced without permission from EMC Compliance Management Group.*

### **Opinions and Interpretations**

*This test report relates to the abovementioned equipment under test (EUT). Without the permission of EMC Compliance Management Group Test Lab this test report is not permitted to be duplicated in extracts. This test report does not entitle to carry any test mark on this or similar products. The manufacturer has sole responsibility of continued compliance of the device.*

### **Statement of Measurement Uncertainty**

*The data and results referenced in the document are true and accurate. The reader is cautioned that there may be errors within the calibration limits of the equipment and facilities that can account for a nominal measurement error. Furthermore, component and process variability of devices similar to that tested may result in additional deviation.*

## **Administrative Data**

*Test Sample* : *IP Camera*

*Model Numbers* : *GXV3601\_LL, GXV3601\_HD*

*Model Tested* : *GXV3601\_HD*

*Receipt Date* : *August 26, 2011*

*Date Tested* : *August 29, 2011 to August 30, 2011*

*Applicant* : *Grandstream Networks, INC*

*Address* : *5F, Bldg #1, No.2 Kefa Rd., Science & Technology Park, Shenzhen, China*

*Telephone* : *86-755-26014600*

*Fax* : *86-755-26014601*

*Manufacturer* : *Grandstream Networks, INC*

*Address* : *5F, Bldg #1, No.2 Kefa Rd., Science & Technology Park, Shenzhen, China*

*Telephone* : *86-755-26014600*

*Fax* : *86-755-26014601*

*Factory* : *Grandstream Networks, INC*

*Address* : *5F, Bldg #1, No.2 Kefa Rd., Science & Technology Park, Shenzhen, China*

*Telephone* : *86-755-26014600*

*Fax* : *86-755-26014601*

## **EUT Description**

*Grandstream Networks,INC., model tested GXV3601\_HD (referred to as the EUT in this report) is an IP Camera.*

*The EUT is an IP Camera and technical specifications of EUT as below:*

<b>Parameter</b>		<b>Range</b>
<i>Basic parameters</i>	<i>Rated voltage</i>	12VDC
	<i>Rated Current</i>	1.0A
<i>I/O Ports</i>	<i>NETWORK</i>	<i>10/100 Switch LAN port for connecting to Ethernet</i>
	<i>AUDIO IN</i>	<i>3.5mm port for audio input devices(microphone, pickup and etc.).</i>
	<i>AUDIO OUT</i>	<i>3.5mm port for audio output devices (speakers, and etc.).</i>
	<i>DC 12V</i>	<i>12V DC power jack;</i>
	<i>SD/MMC</i>	<i>SD card slot</i>
	<i>RESET</i>	<i>Press the Reset button for 6 seconds to perform a factory reset</i>
	<i>PINs</i>	<i>1 PTZ connector, Alarm In connector, and Alarm out connector</i>
	<i>POWER INDICATOR</i>	<i>The indicator will be solid green if the power is on.</i>
	<i>USB</i>	<i>USB connector for USB flash/hard drives</i>
<i>AC Adapter Informations</i>	<i>Input</i>	<i>100-240VAC 50/60Hz 0.3A</i>
	<i>Output</i>	<i>12VDC,1.0A,</i>
	<i>Model</i>	<i>SEF1200100A1BB</i>
	<i>Brand name</i>	<i>Mass Power</i>

**NOTE:** *For more detailed informations or features please refer to user's manual of EUT.*

## **EUT Model Derived**

Model of GXV3601\_LL and GXV3601\_HD are the same series of the products, they have the same circuit function. The differences between them are only CMOS sensor board and VOUT port and anything else are the same. For more details please see the following photos of difference descriptions.

### **Two CMOS sensor board view:**

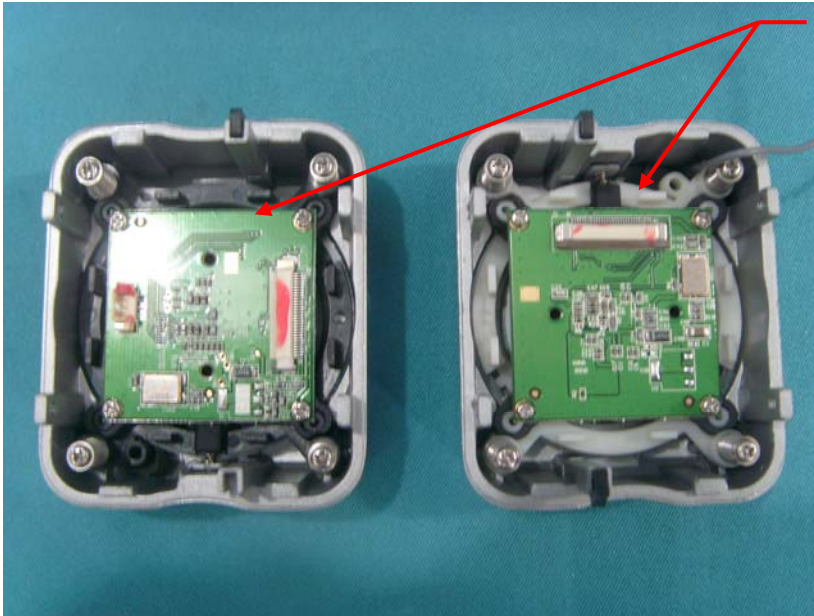

**Note :**  
Model of GXV3601\_LL and GXV3601\_HD have the similar CMOS sensor board, the difference between them only is video resolution.

### **Two mainboard view:**

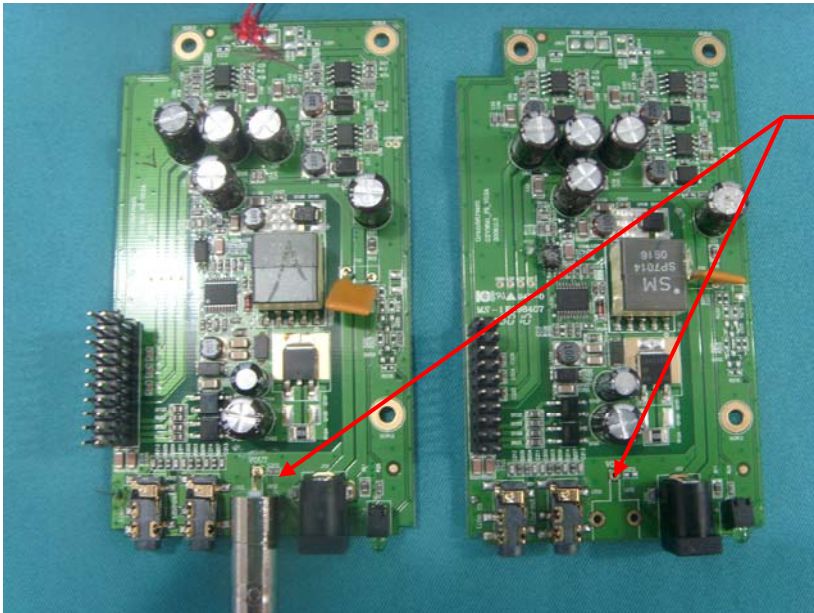

**Note :**  
The difference between these two mainboards is only the VOUT port; the model of GXV3601\_LL has a VOUT port, but GXV3601\_HD does not, and everything else is the same between these two PCBs.



The worst-case model of GXV3601\_HD has max video resolution,so it was chosen for the final testing.

### **Test Summary**

The electromagnetic compatibility requirements on model GXV3601\_HD for this test are stated below. All results listed in this report relate exclusively to this above-mentioned model as the equipment under test. This report confers no approval or endorsement upon any other component, host or subsystem used in the test set-up.

<b>Emission Tests</b>				
<b>Specifications</b>	<b>Description</b>	<b>Test Results</b>	<b>Test Point</b>	<b>Remark</b>
<i>FCC Part 15.107 ANSI C63.4 -2003</i>	<i>Conducted Emission</i>	<i>Passed</i>	<i>AC Input Port</i>	<i>Attachment 1</i>
<i>FCC Part 15.109 ANSI C63.4 -2003</i>	<i>Radiated Emission</i>	<i>Passed</i>	<i>Enclosure</i>	<i>Attachment 2</i>

### ***Test Mode Justification***

*The system was configured for testing in a typical fashion(as normally used by a typical user). for PoE mode, Let the EUT operated in PoE mode and measured it.*

### ***EUT Exercise Software***

*No test software support this test.*

### ***Equipment Modification***

*Any modifications installed previous to testing by Grandstream Networks, INC., will be incorporated in each production model sold or leased in United States.*

*There were no modifications installed by EMC Compliance Management Group test personnel.*

**EUT Sample Photos**

**EUT Model: GXV3601\_HD**



**EUT- Top View**



**EUT- Bottom View**



**EUT- Front View**



**EUT -Rear View**



***Lense View***



***Power Adaptor View(Manufacturer: Mass Power)***

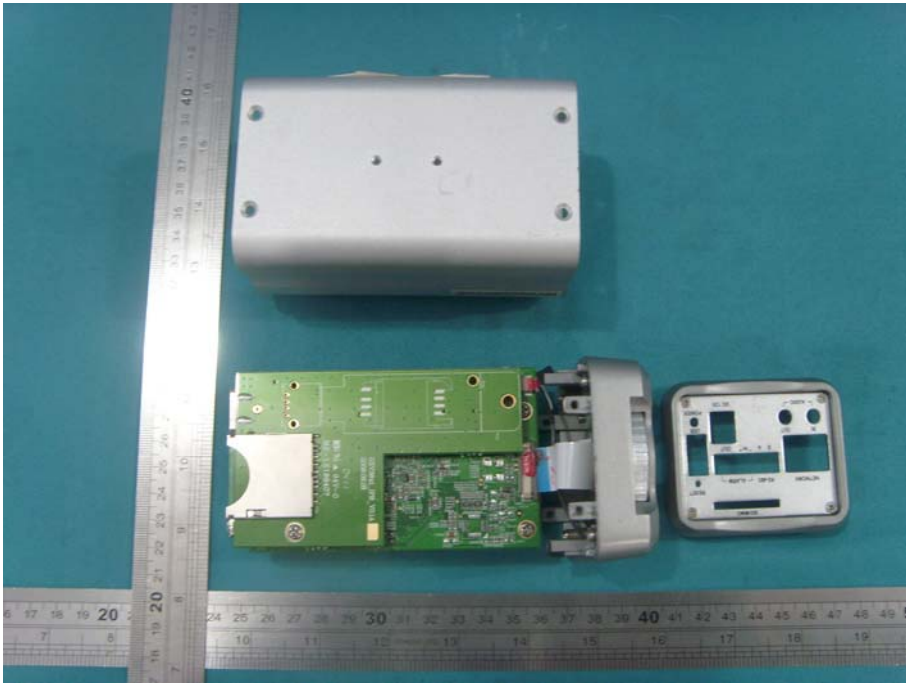

***Uncovered View***

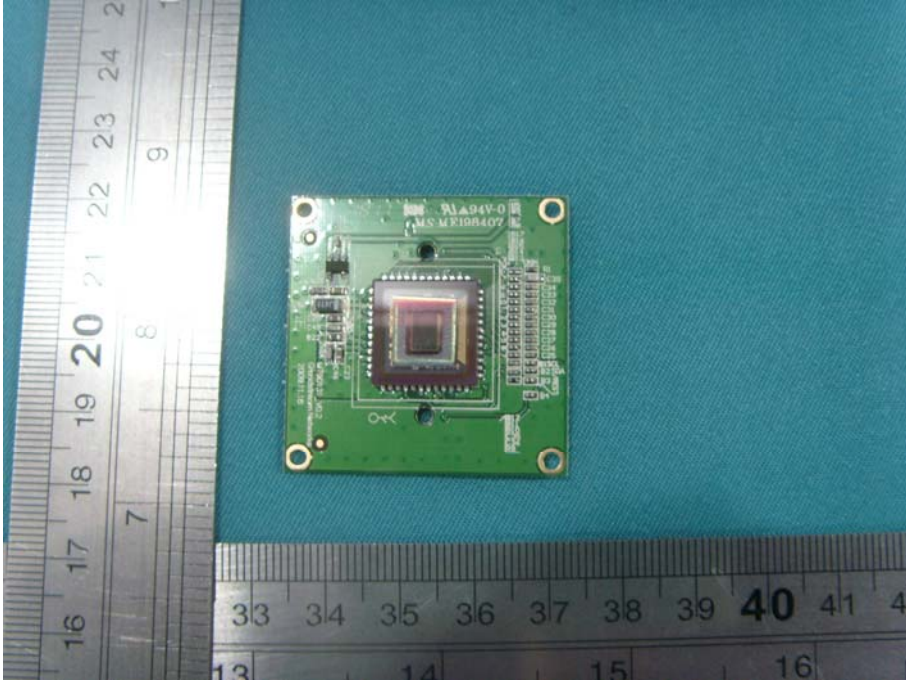

***CMOS Sensor Board Top View***

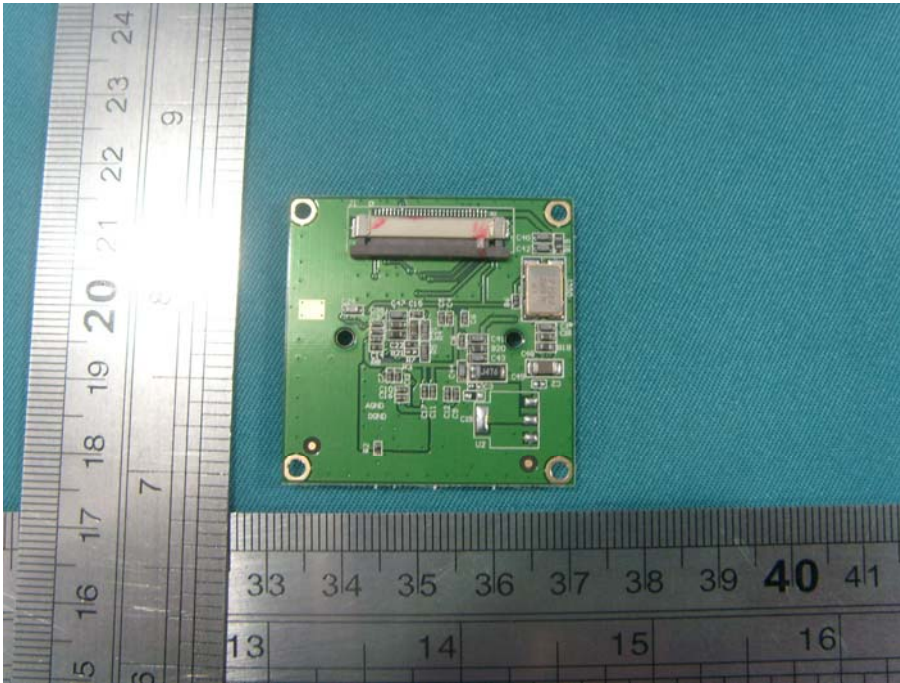

**CMOS Sensor Board Bottom View**

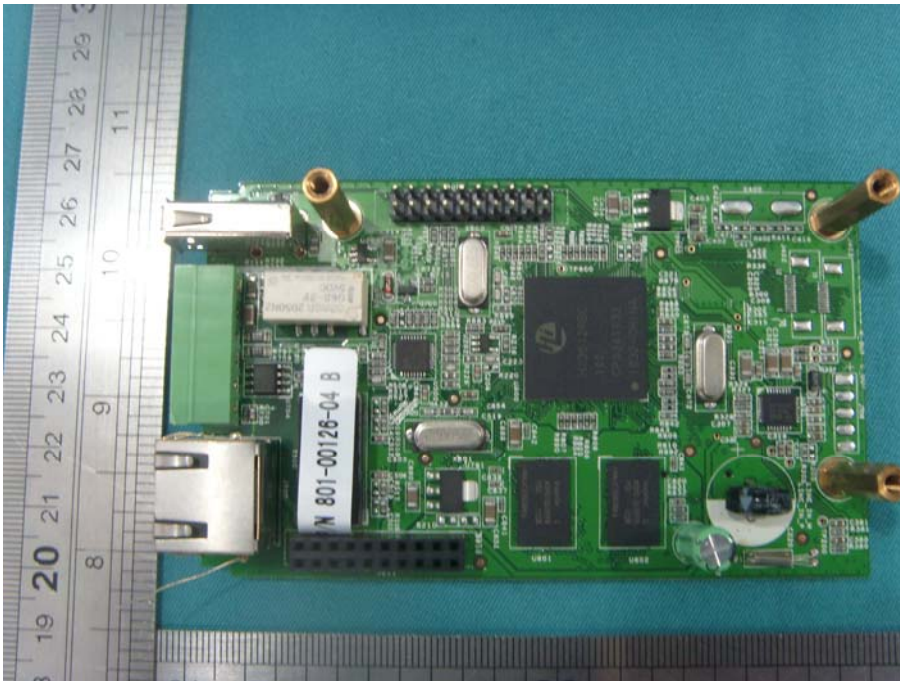

**Mainboard Top View**

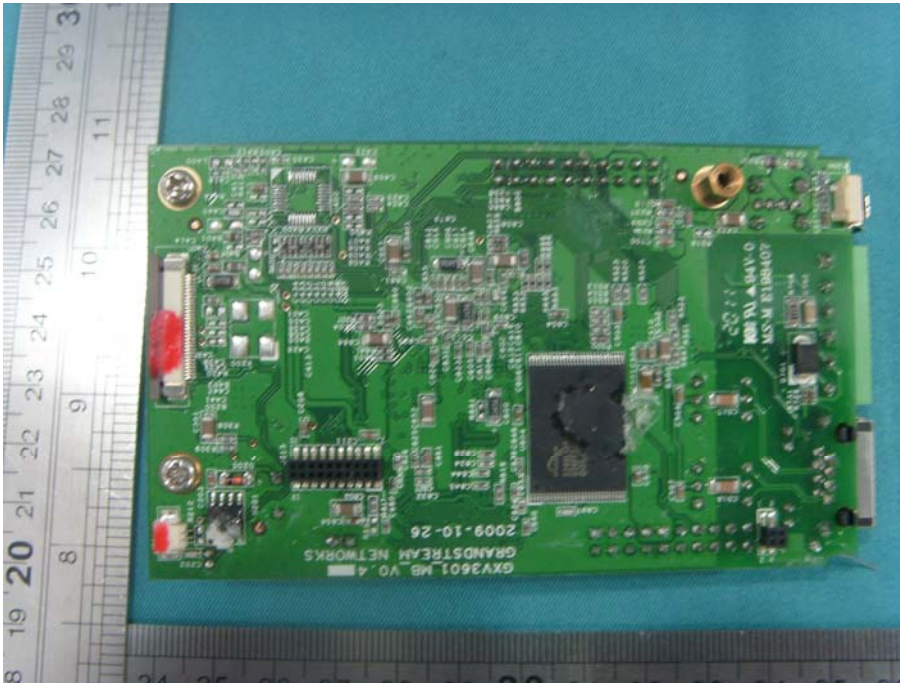

**Mainboard Bottom View**

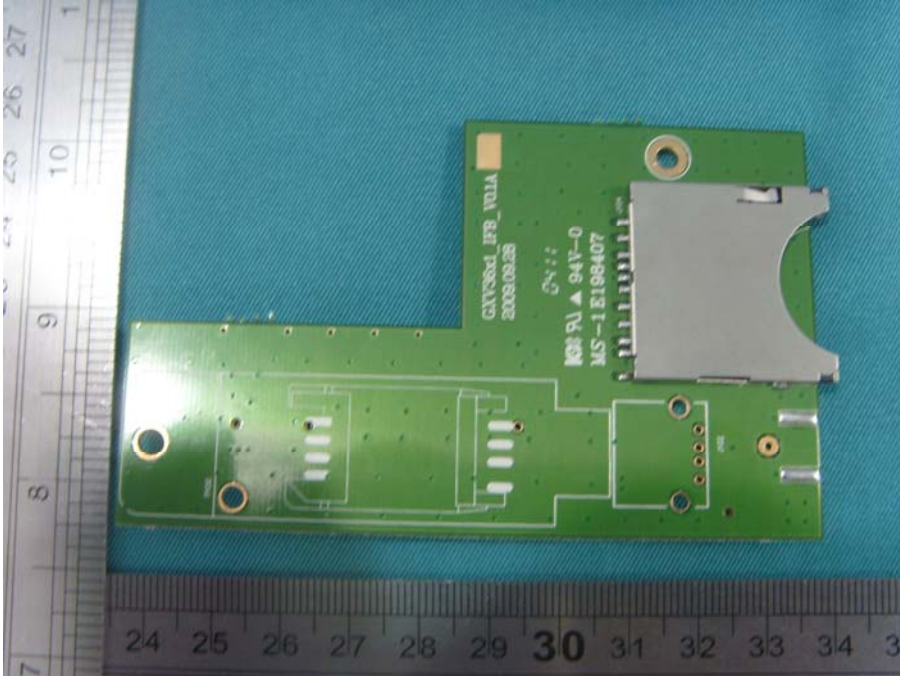

**SD Card Board Top View**



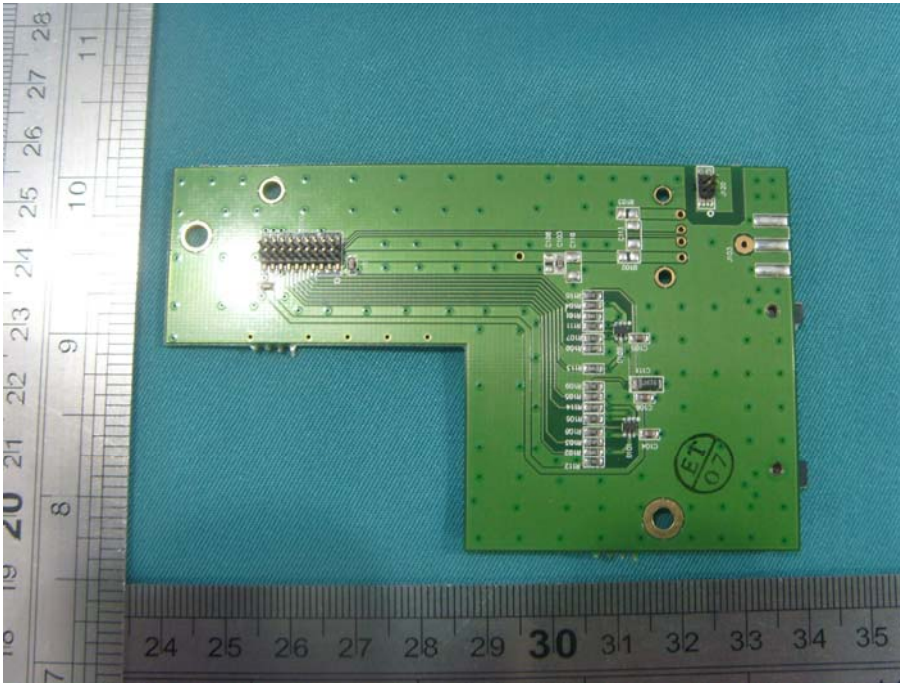

***SD Card Board Bottom View***

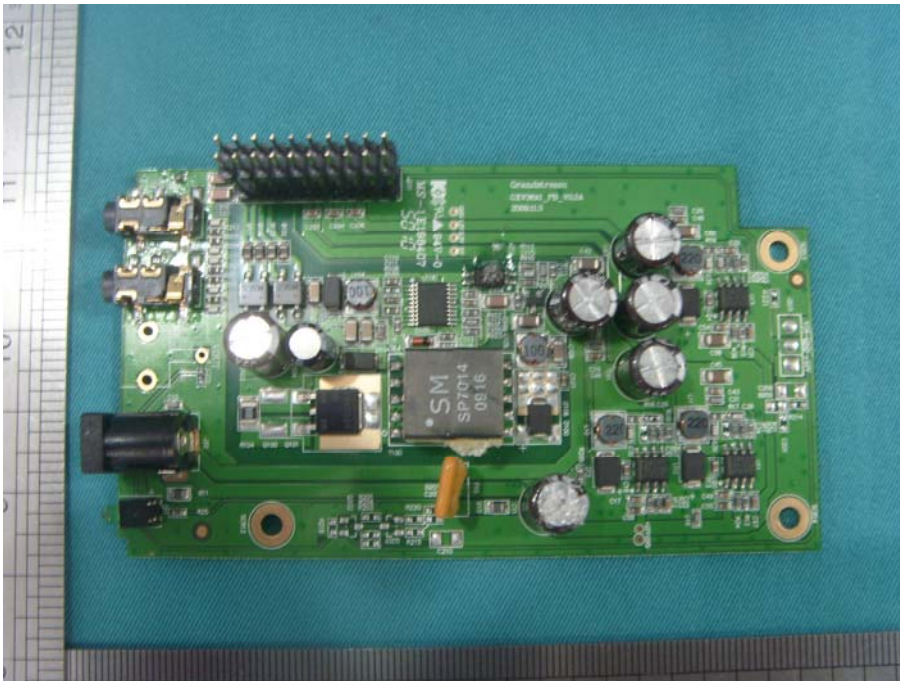

***Power Board Top View***

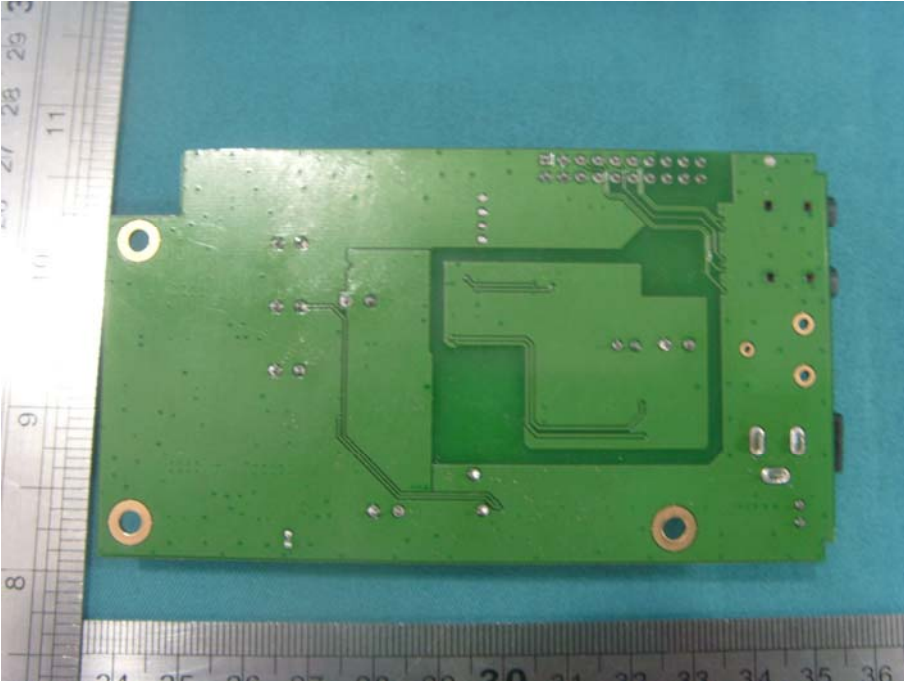

***Power Board Bottom View***

## Test System Details

<i>EUT</i>			
<b>Model Number:</b>	GXV3601_LL,GXV3601_HD		
<b>Model Tested:</b>	GXV3601_HD		
<b>Description:</b>	IP Camera		
<b>Input:</b>	AC 120V/60Hz		
<b>Manufacturer:</b>	Grandstream Networks, INC		
<i>Support Equipment</i>			
<i>Description</i>	<i>Model Number</i>	<i>Serial Number</i>	<i>Manufacturer</i>
Notebook PC	NC4000	CNU4122BCL	HP
AC Adapter Of Notebook PC	PPP009H	239427-003	HP
Mouse	MO32B0	23-033131	HP
Keyboard	SK-1788	N/A	LENOVO
Monitor	177V+	N/A	AOC

<i>Cable Description</i>					
<i>Description</i>	<i>From</i>	<i>To</i>	<i>Length (Meters)</i>	<i>Shielded (Y/N)</i>	<i>Ferrite (Y/N)</i>
<i>AC Adaptor Cord Of Notebook</i>	<i>AC Adaptor</i>	<i>Notebook PC</i>	<i>1.6</i>	<i>N</i>	<i>Y</i>
	<i>AC Plug</i>	<i>AC Adaptor</i>	<i>1.2</i>	<i>N</i>	<i>Y</i>
<i>Mouse Cord</i>	<i>Mouse</i>	<i>Notebook PC</i>	<i>1.2</i>	<i>N</i>	<i>Y</i>
<i>Keyboard Cord</i>	<i>keyboard</i>	<i>Notebook PC</i>	<i>1.2</i>	<i>N</i>	<i>Y</i>
<i>VGA cord</i>	<i>Notebook PC</i>	<i>Monitor</i>	<i>1.2</i>	<i>Y</i>	<i>Y</i>
<i>RJ-45 Cord</i>	<i>EUT</i>	<i>Notebook PC</i>	<i>&gt;3.0</i>	<i>Y</i>	<i>N</i>
<i>AC Adaptor Power Cord Of EUT</i>	<i>EUT</i>	<i>Plug</i>	<i>2.4</i>	<i>N</i>	<i>N</i>
<i>Note: The "EUT" means "IP CAMERA".</i>					

**NOTE:**

*The EUT has been tested as an independent unit together with other necessary accessories or support units. The above support units or accessories were used to form a representative test configuration during the test tests.*

## Configuration of Tested System

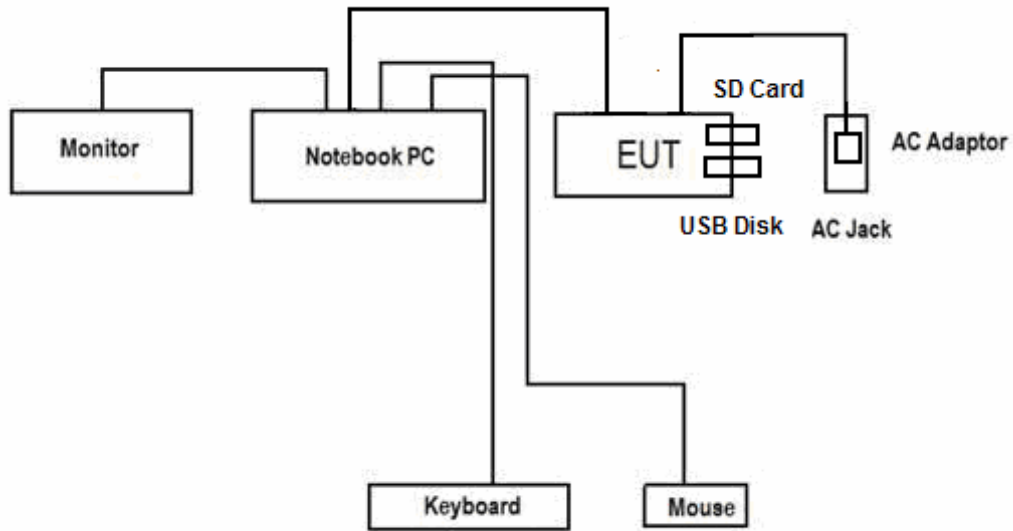

*Note : The same system configuration shall still apply to PoE mode when removed AC Adaptor of EUT.*

## ATTACHMENT 1 - CONDUCTED EMISSION TEST RESULTS

<b>CLIENT:</b>	Grandstream Networks, INC	<b>TEST STANDERD:</b>	FCC Part 15, Subpart B, Section 15.107
<b>MODEL NUMBERS:</b>	GXV3601_LL,GXV3601_HD	<b>PRODUCT:</b>	IP Camera
<b>MODEL TESTED:</b>	GXV3601_HD	<b>EUT DESIGNATION:</b>	Home or Office Use
<b>TEMPERATURE:</b>	23°C	<b>HUMIDITY:</b>	47%RH
<b>ATM PRESSURE:</b>	103kPa	<b>GROUNDING:</b>	None
<b>TESTED BY:</b>	Sewen Guo	<b>DATE OF TEST:</b>	August 29, 2011
<b>TEST REFERENCE:</b>	ANSI C63.4- 2003		
<b>TEST PROCEDURE:</b>	The EUT was set up according to the guidelines of ANSI C63.4-2003 for conducted emissions. The measurement was using a AMN on each line and an EMI receiver peak scan was made at the frequency measurement range. The six highest significant peaks were then marked, and these signals were then quasi-peaked and averaged.The frequency range investigated was from 150KHz to 30MHz.		
<b>DESCRIPTION OF TEST MODE</b>	Please refer to test mode justification.		
<b>TEST SET UP</b>	<p style="text-align: center;">EUT &amp; Support stand 80cm LISN Testreceive Ground plane</p>		
<b>TESTED RANGE:</b>	150kHz to 30MHz		
<b>TEST VOLTAGE:</b>	AC 120V/60Hz		
<b>RESULTS:</b>	The EUT meets the requirements of test reference for Conducted Emissions. The test results relate only to the equipment under test provided by client.		
<b>Changes or Modifications:</b>	There were no modifications installed by EMC Compliance Management Group test personnel.		
<b>M. UNCERTAINTY:</b>	Freq. $\pm 2 \times 10^{-7}$ x Center Freq., Amp $\pm 2.6$ dB		

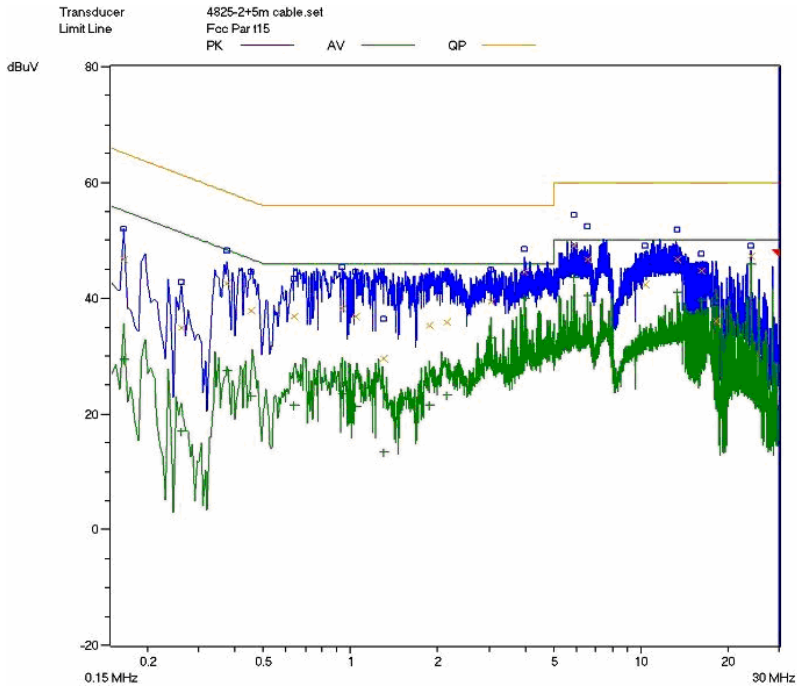

**Line L Conducted Emission Graph Of AC Mains**

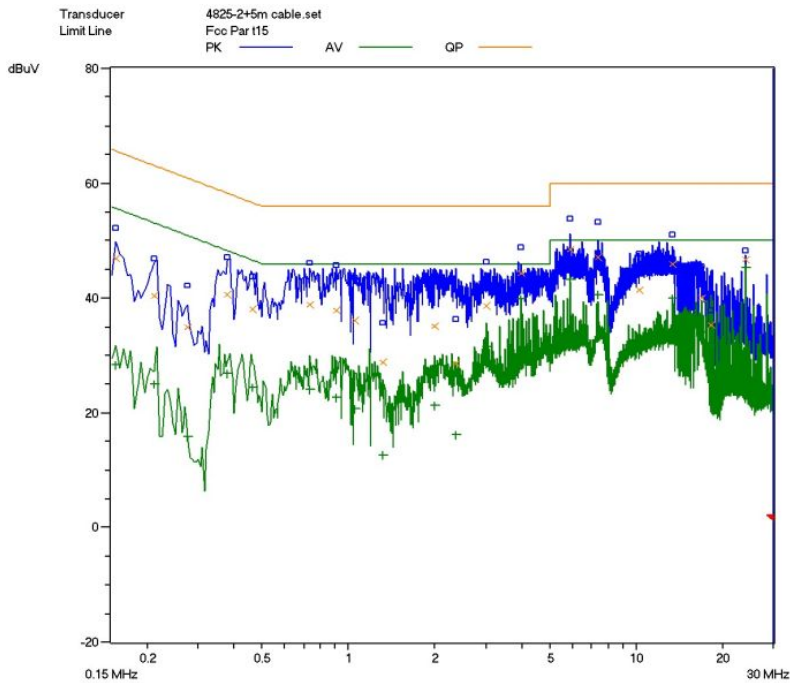

**Line N Conducted Emission Graph Of AC Mains**

**Test Data:**

Lines (L/N)	Frequency (MHz)	Corrected QP Level (dBuV)	Limits QP (dBuV)	Margin QP(dB)	Frequency (MHz)	Corrected AV Level (dBuV)	Limits AV (dBuV)	Margin QP(dB)
L	0.375	42.5	58.4	-15.9	0.375	27.5	48.4	-20.9
L	3.955	44.5	56.0	-11.5	3.955	40.1	46.0	-5.9
L	5.910	49.1	60.0	-10.9	5.910	43.5	50.0	-6.5
N	3.955	44.3	56.0	-11.7	3.955	39.9	46.0	-6.1
N	5.910	48.6	60.0	-11.4	5.910	43.3	50.0	-6.7
N	7.375	47.2	60.0	-12.7	7.375	40.5	50.0	-9.5

**Note :**

- 1) All readings are using a bandwidth of 9 kHz, with a 500 ms sweep time. A video filter was not use.
- 2) "QP" means "Quasi-Peak" values, "AV" means "Average" values.
- 3) The other reading are too low against official limits that are not be recorded.

**Test Equipment List:**

Test Equipment	Model No.	Manufacturer	Serial No.	Last Cal.	Cal. Interval
Receiver	SMR4503	SCHAFFNER	11725	2011.07.08	2012.07.08
Line impedance stabilization network	4825/2	ETS	1161	2011.07.08	2012.07.08

Note: All testing were performed using internationally recognized standards. All test instruments were calibrated.

SIGNED BY: \_\_\_\_\_

ENGINEER

REVIEWED BY: \_\_\_\_\_

SENIOR ENGINEER





***Conducted Emission Test Set-up***

## ATTACHMENT 2 - RADIATED EMISSION MEASUREMENT

<b>CLIENT:</b>	Grandstream Networks, INC	<b>TEST STANDERD:</b>	FCC Part 15, Subpart B, Section 15.109
<b>MODEL NUMBERS:</b>	GXV3601_LL, GXV3601_HD	<b>PRODUCT:</b>	IP Camera
<b>EUT MODEL:</b>	GXV3601_HD	<b>EUT DESIGNATION:</b>	Home or Office Use
<b>TEMPERATURE:</b>	23°C	<b>HUMIDITY:</b>	47%RH
<b>ATM PRESSURE:</b>	102.0kPa	<b>GROUNDING:</b>	None
<b>TESTED BY:</b>	Sewen Guo	<b>DATE OF TEST:</b>	August 30, 2011
<b>TEST REFERENCE:</b>	ANSI C63.4- 2003		
<b>TEST PROCEDURE:</b>	<p>The EUT was set up according to the guidelines of ANSI C63.4-2003 for radiated emissions.</p> <p>An EMI receiver peak scan was made at the frequency measurement range (pre-scan) in an Anechoic chamber. signal discrimination was then performed and the significant peaks marked. these peaks were then quasi-peaked in the frequency range of 30 MHz to 1GHz and average and peak in the frequency range of 1GHz to 2GHz at an anechoic chamber.</p> <p>The following data lists the significant emission frequencies, measured levels, correction factors (including cable and antenna correction factors), and the corrected readings against the limits. Explanation of the Correction Factor are given as follows:</p> <p>FS= RA + AF + CF - AG</p> <p>Where: FS = Field Strength</p> <p>RA = Receiver Amplitude</p> <p>AF = Antenna Factor</p> <p>CF = Cable Attenuation Factor</p> <p>AG = Amplifier Gain</p>		
<b>TEST MODE:</b>	Please refer to test mode justification		
<b>TESTED RANGE:</b>	30MHz to 2,000MHz		
<b>TEST VOLTAGE:</b>	AC 120V/60Hz		
<b>RESULTS:</b>	The EUT meet the requirements of test reference for radiated emissions. The test results relate only to the equipment under test provided by client.		

Continue on to next page...

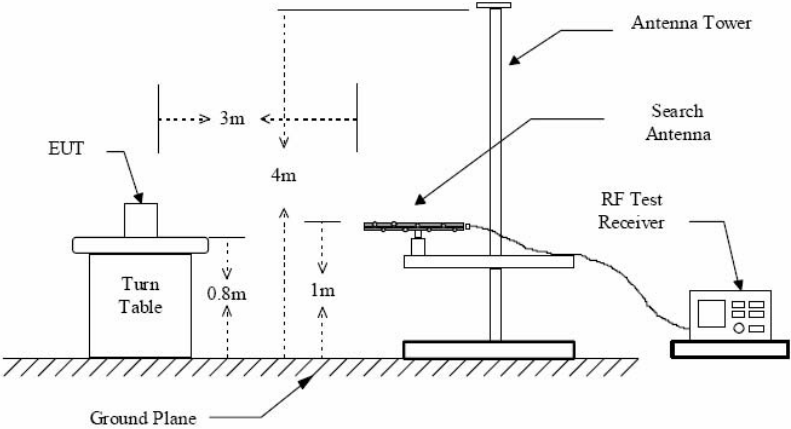
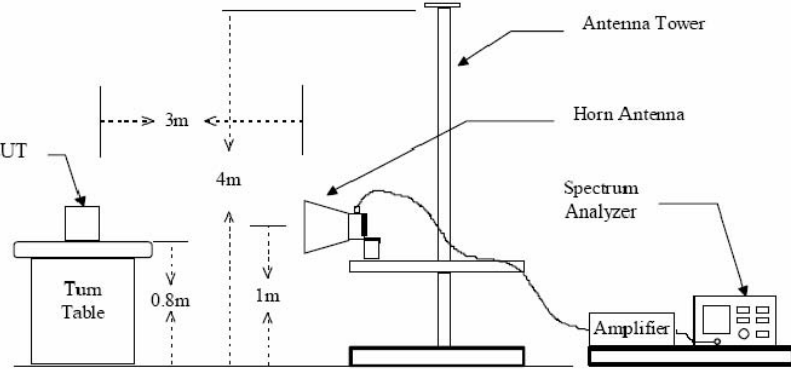
<p><b>TEST SET-UP</b></p>	<p style="text-align: center;">Figure 1 : Frequencies measured below 1 GHz configuration</p>  <p style="text-align: center;">Figure 2 : Frequencies measured above 1 GHz configuration</p> 
	<p><b>CHANGES OR MODIFICATIONS:</b> There were no modifications installed by EMC Compliance Management Group. test personnel.</p> <p><b>M. UNCERTAINTY:</b> Freq. <math>\pm 2 \times 10^{-7} \times</math> Center Freq., Amp <math>\pm 2.6</math> dB</p>

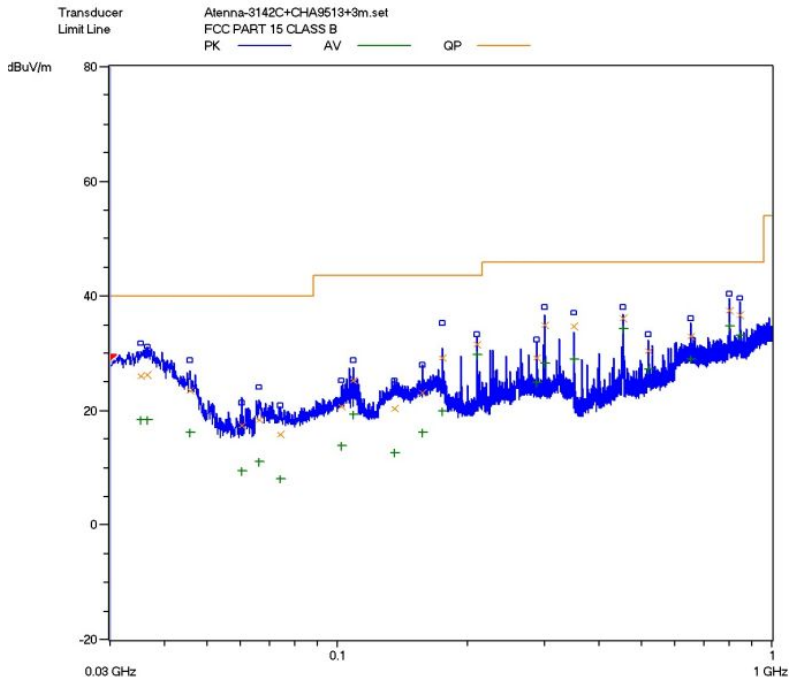

**Horizontal Radiated Emission Test Plot**

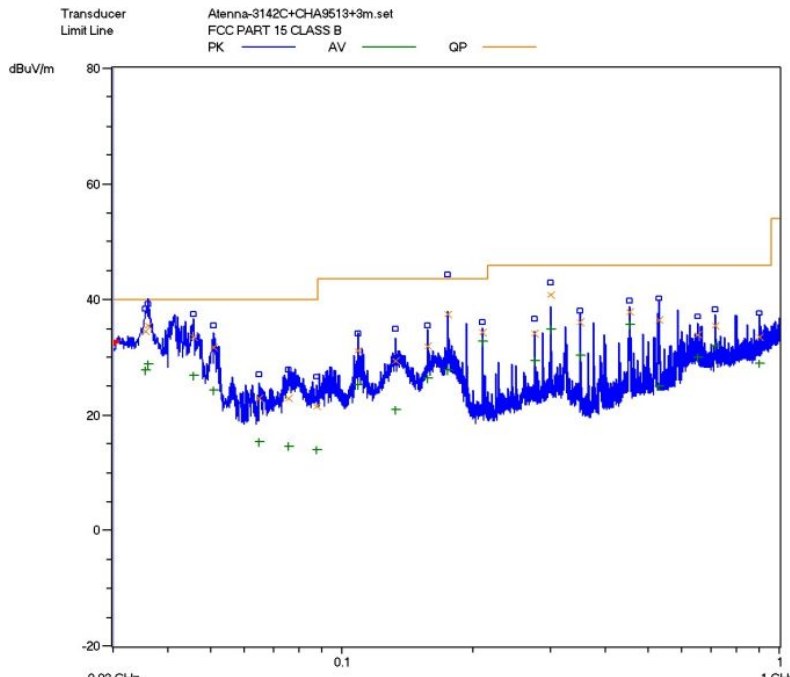

**Vertical Radiated Emission Test Plot**

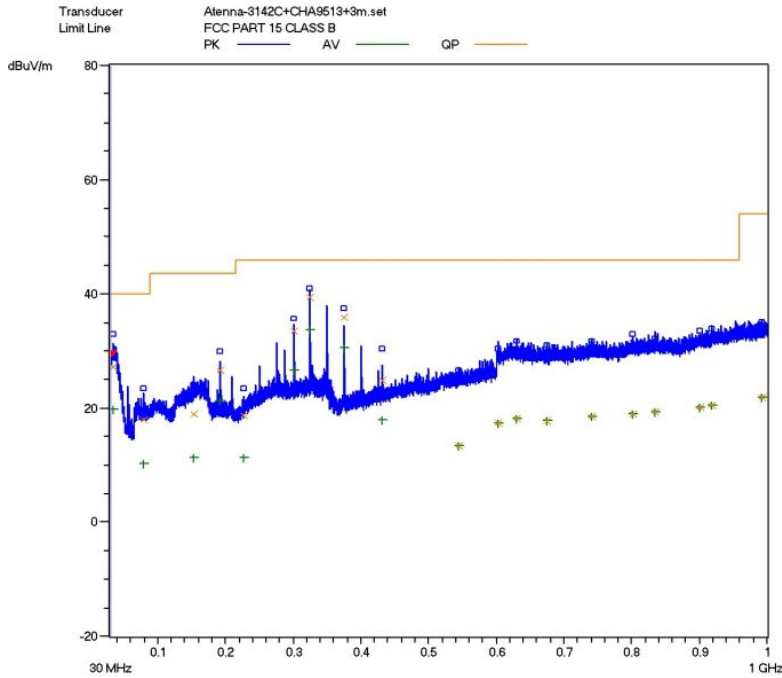

**Horizontal Radiated Emission Test Plot At PoE Mode**

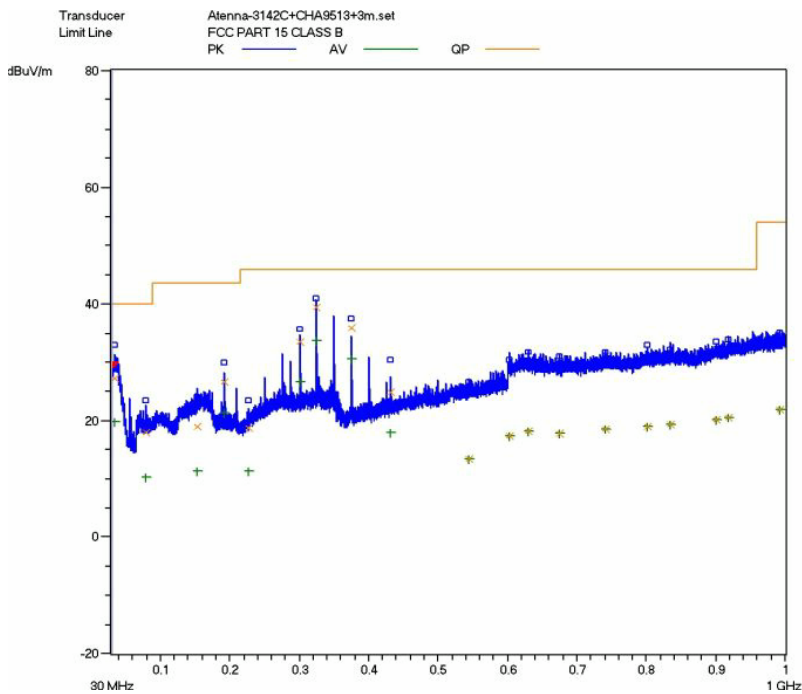

**Vertical Radiated Emission Test Plot At PoE Mode**

**Test Data:**

**Below 1GHz:**

Frequency (MHz)	Cable Loss (dB)	Antenna Factor (dB)	Preamp Factor (dB)	Reading Level QP (dBuV/m)	Emission Level (dBuV/m)	Limit (dBuV/m)	Margin (dB)
<b>Horizontal</b>							
209.840	0.12	7.8	/	23.68	31.6	43.5	-11.9
300.000	0.16	13.3	/	21.44	34.9	46.0	-11.1
350.000	0.16	13.8	/	20.84	34.8	46.0	-11.2
454.800	0.20	16.8	/	19	36.0	46.0	-10.0
799.920	0.39	22.2	/	14.91	37.5	46.0	-8.5
844.560	0.42	22.5	/	13.78	36.7	46.0	-9.3
<b>Vertical</b>							
35.600	0.02	18.4	/	16.08	34.5	40.0	-5.5
35.920	0.02	18.4	/	16.98	35.4	40.0	-4.6
45.760	0.02	11.9	/	21.58	33.5	40.0	-6.5
174.880	0.02	7.8	/	29.68	37.5	43.5	-6.0
300.000	0.16	13.3	/	27.34	40.8	46.0	-5.2
454.800	0.2	16.8	/	20.9	37.9	46.0	-8.1

**Note:**

- a) All readings are quasi-peak unless stated otherwise, using a QPA bandwidth of 120kHz, with a 60 s sweep time. A video filter was not used.
- b) The field strength is calculated by adding the Antenna Factor, Cable Factor & Preamplifier. The basic equation with a sample calculation is as follows: Emission Level = Reading Level + Antenna Factor + Cable Loss - Preamplifier Factor.
- c) The other emission levels are 20dB below the official limits that are not reported.

**Above 1GHz:**

Frequency (MHz)	Cable Loss (dB)	Antenna Factor (dB)	Preamplifier Factor (dB)	Reading Level (dBuV/m)	Emission Level (dBuV/m)	Limit (dBuV/m)	Margin (dB)	Antenna Polarization (H/V)
<b>Peak Measurement</b>								
1.056	1.41	23.9	-33.6	-1.59	57.32	74	-16.68	H
1.190	1.45	25.0	-33.6	-8.27	51.78	74	-22.22	H
1.320	1.50	25.6	-33.6	-7.08	53.62	74	-20.38	H
1.584	1.75	26.7	-33	-3.37	58.32	74	-15.68	V
1.592	1.75	26.7	-33	-9.35	52.70	74	-21.3	V
1.856	1.93	27.3	-33	-28.53	34.30	74	-39.7	V
<b>Average Measurement</b>								
1.056	1.41	23.9	-33.6	-9.75	49.16	54	-4.84	H
1.190	1.45	25.0	-33.6	-14.04	46.01	54	-7.99	H
1.320	1.50	25.6	-33.6	-13.9	46.80	54	-7.2	H
1.584	1.75	26.7	-33	-15.44	46.61	54	-7.39	V
1.592	1.75	26.7	-33	-28.56	33.49	54	-20.51	V
1.728	1.88	27.2	-33	-18.13	44.55	54	-9.45	V

**Note:**

- a) The field strength is calculated by adding the Antenna Factor, Cable Factor & Preamplifier. The basic equation with a sample calculation is as follows: Emission Level = Reading Level + Antenna Factor + Cable Loss - Preamplifier Factor.
- b) The limits shown are based on Peak value and Average value detector above 1GHz, the bandwidth of Test Receiver was set at 1MHz above 1GHz.
- c) The other emission levels are 20dB below the official limits that are not reported.

**PoE Mode/Below 1GHz:**

Frequency (MHz)	Cable Loss (dB)	Antenna Factor (dB)	Preamp Factor (dB)	Reading Level QP (dBuV/m)	Emission Level (dBuV/m)	Limit (dBuV/m)	Margin (dB)
<b>Horizontal</b>							
34.720	0.02	18.0	/	9.28	27.3	40.0	-12.7
192.400	0.10	6.2	/	20.3	26.6	43.5	-16.9
300.000	0.16	13.3	/	20.04	33.5	46.0	-12.5
325.040	0.16	13.5	/	25.74	39.4	46.0	-6.6
375.040	0.16	13.8	/	21.94	35.9	46.0	-10.1
432.000	0.20	15.5	/	9.3	25.0	46.0	-21.0
<b>Vertical</b>							
40.320	0.02	16.8	/	13.68	30.5	40.0	-9.5
174.880	0.02	7.8	/	19.88	27.7	43.5	-15.8
192.400	0.10	6.2	/	25	31.3	43.5	-12.2
300.000	0.16	13.3	/	13.74	27.2	46.0	-18.8
325.040	0.16	13.5	/	17.64	31.3	46.0	-14.7
375.040	0.16	13.8	/	13.64	27.6	46.0	-18.4

**Note:**

- a) All readings are quasi-peak unless stated otherwise, using a QPA bandwidth of 120kHz, with a 60 s sweep time. A video filter was not used.
- b) The field strength is calculated by adding the Antenna Factor, Cable Factor & Preamplifier. The basic equation with a sample calculation is as follows: Emission Level = Reading Level + Antenna Factor + Cable Loss - Preamplifier Factor.
- c) The other emission levels are 20dB below the official limits that are not reported.



**PoE Mode/Above 1GHz:**

Frequency (MHz)	Cable Loss (dB)	Antenna Factor (dB)	Preamplifier Factor (dB)	Reading Level (dBuV/m)	Emission Level (dBuV/m)	Limit (dBuV/m)	Margin (dB)	Antenna Polarization (H/V)
<b>Peak Measurement</b>								
1.056	1.41	23.9	-33.6	-1.59	57.32	74	-16.68	H
1.190	1.45	25.0	-33.6	-8.27	51.78	74	-22.22	H
1.320	1.50	25.6	-33.6	-7.08	53.62	74	-20.38	H
1.584	1.75	26.7	-33	-3.37	58.32	74	-15.68	V
1.592	1.75	26.7	-33	-9.35	52.70	74	-21.3	V
1.856	1.93	27.3	-33	-28.53	34.30	74	-39.7	V
<b>Average Measurement</b>								
1.056	1.41	23.9	-33.6	-9.75	49.16	54	-4.84	H
1.190	1.45	25.0	-33.6	-14.04	46.01	54	-7.99	H
1.320	1.50	25.6	-33.6	-13.9	46.80	54	-7.2	H
1.584	1.75	26.7	-33	-15.44	46.61	54	-7.39	V
1.592	1.75	26.7	-33	-28.56	33.49	54	-20.51	V
1.728	1.88	27.2	-33	-18.13	44.55	54	-9.45	V

**Note:**

- a) The field strength is calculated by adding the Antenna Factor, Cable Factor & Preamplifier. The basic equation with a sample calculation is as follows: Emission Level = Reading Level + Antenna Factor + Cable Loss - Preamplifier Factor.
- b) The limits shown are based on Peak value and Average value detector above 1GHz, the bandwidth of Test Receiver was set at 1MHz above 1GHz.
- c) The other emission levels are 20dB below the official limits that are not reported.

**Test Equipment List:**

<i>Test Equipment</i>	<i>Model No.</i>	<i>Manufacturer</i>	<i>Serial No.</i>	<i>Last Cal.</i>	<i>Cal. Due</i>
<i>Receiver</i>	<i>SMR4503</i>	<i>SCHAFFNER</i>	<i>11725</i>	<i>2011.07.08</i>	<i>2012.07.07</i>
<i>Double-ridged Wave guide horn</i>	<i>3115</i>	<i>ETS</i>	<i>6587</i>	<i>2011.08.02</i>	<i>2012.08.01</i>
<i>Microwave system amplifier</i>	<i>83017A</i>	<i>Agilent</i>	<i>MY39500438</i>	<i>2011.07.11</i>	<i>2012.07.10</i>
<i>Biconilog Antenna</i>	<i>3142C</i>	<i>ETS</i>	<i>00042672</i>	<i>2010.09.28</i>	<i>2011.09.27</i>
<i>Band-pass Filter</i>	<i>BRM50702</i>	<i>Micro-Tronic</i>	<i>S/N-030</i>	<i>2010.11.30</i>	<i>2011.11.29</i>
<i>Spectrum Analyzer</i>	<i>FSP30</i>	<i>R&amp;S</i>	<i>100755</i>	<i>2010.11.30</i>	<i>2011.11.29</i>
<i>Note: All testing were performed using internationally recognized standards. All test instruments were calibrated.</i>					

SIGNED BY:   
 \_\_\_\_\_  
 ENGINEER

REVIEWED BY:   
 \_\_\_\_\_  
 SENIOR ENGINEER

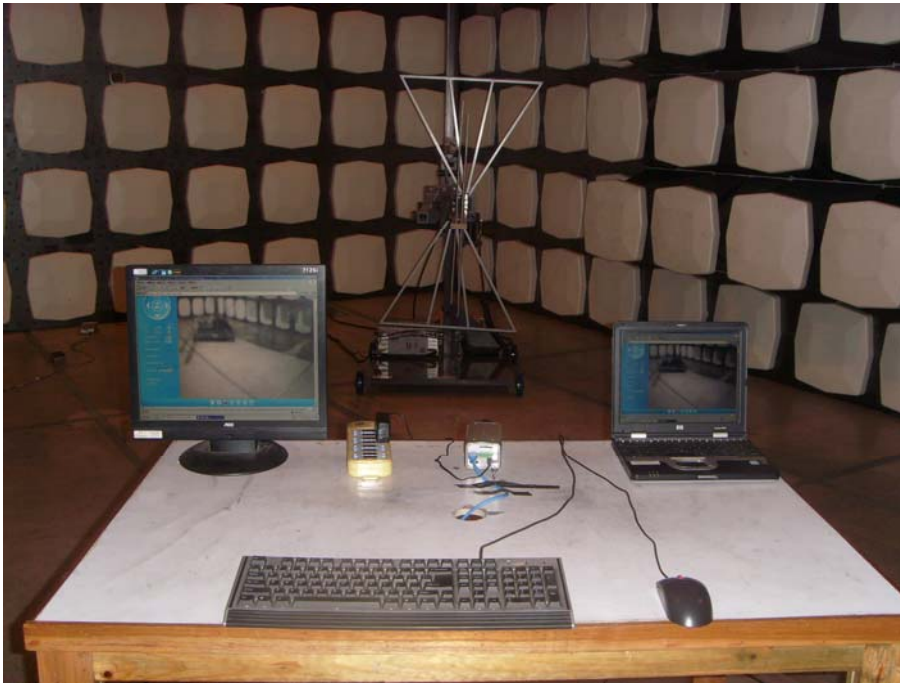

***Radiated Emission Test Set-up(Below 1GHz)***



***Radiated Emission Test Set-up(Above 1GHz)***