



Ke Mei Ou Lab Corp.

E506, 5th Floor, No.39 Keji Middle 2nd Rd, Science & Technology Park, Nanshan District, Shenzhen, P. R. China
Tel: + 86 755 83642690 Fax: + 86 755 83297077
www.kmolab.com

FCC TEST REPORT

Under:
FCC Part 15, Class B

Prepared For:

Grandstream Networks, Inc.

4th Floor, Rainbow Technology Building #16 New West Rd, Nanshan Science & Technology Park
(North District), Shenzhen, China 518057

FCC ID: YZZGXV3500

EUT: IP Video Codec

Model: GXV3500

February 18, 2016

Issue Date:

Extension Report

Report Type:

Eric Guo

Test Engineer: Eric Guo

Apollo Liu

Review By: Apollo Liu / Manager

The test report consists 23 pages in total. It may be duplicated completely for legal use with the allowance of the applicant. It shall not be reproduced except in full, without the written approval of Ke Mei Ou Laboratory Corporation. The test result in the report only applied to the tested sample.

TABLE OF CONTENTS

1. General Information	3
1. 1 Notes.....	3
1. 2 Testing Laboratory.....	3
1. 3 Details of Applicant.....	3
1. 4 Application Details	3
1. 5 Test Item	3
1. 6 Test Standards.....	3
2. Technical Test.....	4
2. 1 Summary of Test Results	4
2. 2 Measurement Uncertainty.....	4
3. Modifications	4
4. Conducted Power Line Test.....	5
4. 1 Test Equipment.....	5
4. 2 Test Procedure	5
4. 3 Test Setup	5
4. 4 Configuration of The EUT.....	6
4. 5 EUT Operating Condition.....	7
4. 6 Conducted Power Line Emission Limits	7
4. 7 Conducted Power Line Test Result.....	8
5. Radiated Emission Test.....	10
5. 1 Test Equipment.....	10
5. 2 Test Procedure	10
5. 3 Radiated Test Setup	10
5. 4 Configuration of The EUT.....	11
5. 5 EUT Operating Condition.....	11
5. 6 Radiated Emission Limit	11
5. 7 Radiated Emission Test Result.....	12
6. Photo of Testing.....	15
6.1 Emission test view.....	15
6.2 Photograph - EUT.....	17
7. FCC ID Label.....	22
8. Test Equipment.....	23

1. General Information

1.1 Notes

The test results of this report relate exclusively to the test item specified in 1.5. The KMO Lab does not assume responsibility for any conclusions and generalizations drawn from the test results with regard to other specimens or samples of the type of the equipment represented by the test item. The test report may only be reproduced or published in full. Reproduction or publication of extracts from the report requires the prior written approval of the KMO Lab.

1.2 Testing Laboratory

Ke Mei Ou Laboratory Co., Ltd.

ANSI-ASQ National Accreditation Board/ACLASS ISO/IEC 17025 Accredited Lab for telecommunication standards. The Registration Number is AT-1532. The testing quality system meets with ISO/IEC-17025 requirements, This approval results is accepted by MRA of ILAC.

FCC Test Site Registration Number: 962205

IC Test Site Registration Number: 4986A-2

Internet: www.kmolab.com

1.3 Details of Applicant

Name : Grandstream Networks, Inc.

Address : 4th Floor, Rainbow Technology Building #16 New West Rd, Nanshan Science & Technology Park
(North District), Shenzhen, China 518057

1.4 Application Details

Date of Receipt of Application : January 7, 2016
Date of Receipt of Test Item : January 7, 2016
Date of Test : January 20~February 18, 2016

1.5 Test Item

Manufacturer : Same as applicant
Address : Same as applicant
Trade Name : Grandstream
Model No.(Base) : GXV3500
Model No.(Extension) : N/A
Description : IP Video Codec

Additional Information

Product Type : N/A
Radio Type : N/A
Power Type : DC 12.0V/0.5A(Adapter model:F06US1200050A)
DC 12.0V/0.5A(Adapter model:NBS05B120050VU)
Modulation : N/A
Data Modulation : N/A
Data Rate (Mbps) : N/A
Frequency Range : N/A
Channel Number : N/A
Antenna : N/A

1.6 Test Standards

FCC Part 15, Class B

Note: All radiated measurements were made in all three orthogonal planes. The values reported are the maximum values.

2. Technical Test

2.1 Summary of Test Results

The EUT has been tested according to the following specifications:

Standard	Test Type	Result	Notes
FCC Part 15, Paragraph 15.107	Conducted Test	PASS	Complies
FCC Part 15, Paragraph 15.109	Radiated Test	PASS	Complies

2.2 Measurement Uncertainty

Where relevant, the following measurement uncertainty levels have been estimated for tests performed on the EUT as specified in CISPR 16-4-2:

Measurement	Frequency	Uncertainty
Conducted emissions	0.15MHz~30MHz	1.72
Radiated emissions	30MHz ~ 300MHz	3.88
Radiated emissions	300MHz ~1000MHz	3.86
Radiated emissions	1000MHz ~18000MHz	5.28

This uncertainty represents an expanded uncertainty expressed at approximately the 95% confidence level using a coverage factor of k=2.

Consistent with industry standard (e.g. CISPR 22: 2006, clause 11, Measurement Uncertainty) determining compliance with the limits shall be base on the results of the compliance measurement. Consequently the measure emissions being less than the maximum allowed emission result in this be a compliant test or passing test.

The acceptable measurement uncertainty value without requiring revision of the compliance statement is base on conducted and radiated emissions being less than U_{CISPR} which is 3.6dB and 5.2dB respectively. KMO values (called U_{Lab} in CISPR 16-4-2) is less than U_{CISPR} as shown in the table above. Therefore, MU need not be considered for compliance.

3. Modifications

This product is an extension of original report under FCC ID: YZZGXV3500

The applicant declare that the reasons for this Class II permissive change as below:

*Add two power adapter (Model: F06US1200050A / NBS05B120050VU) and has the same electrical specification with original power adapter

Anything else are the same as before.

4. Conducted Power Line Test

4.1 Test Equipment

Please refer to Section 8 this report.

4.2 Test Procedure

The EUT and simulators are connected to the main power through a line impedance stabilization network (L.I.S.N.). This provides a 50 ohm/50uH coupling impedance for the measuring equipment. The peripheral devices are also connected to the main power through a LISN that provides a 50ohm/50uH coupling impedance with 50ohm termination.

Both sides of A.C. line are checked for maximum conducted interference. In order to find the maximum emission., the relative positions of equipment and all of the interface cables must be changed according to ANSI C63.4:2014 on conducted measurement. Conducted emissions were invested over the frequency range from 0.15MHz to 30MHz using a receiver bandwidth of 9kHz.

4.3 Test Setup

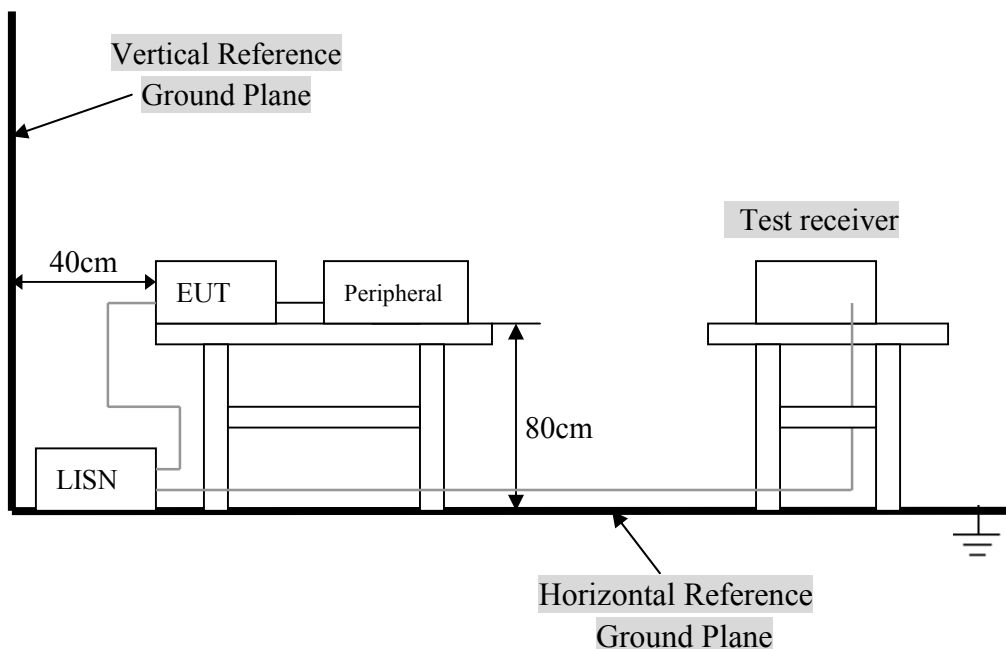

For the actual test configuration, Please refer to the related items – Photos of Testing.

4.4 Configuration of The EUT

The EUT was configured according to ANSI C63.4:2014. All interface ports were connected to the appropriate peripherals. All peripherals and cables are listed below.

A. EUT

Device	Manufacturer	Model #	FCC ID
IP Video Codec	Same as applicant	GXV3500	YZZGXV3500

B. Internal Devices

Device	Manufacturer	Model #	FCCID / DoC
N/A			

C. Peripherals

Device	Manufacturer	Model # Serial #	FCC ID/ DoC	Cable
Notebook	DELL	PP10L	DoC	1.5m unshielded power cord
Color TV Pattern Generator	FLUKE	PM5418	Doc	1.5m unshielded power cord
Mini TV	KONGSONIC	KTFT-7020	Ver	1.2m unshielded data cable.

4.5 EUT Operating Condition

Operating condition is according to ANSI C63.4:2014.

- A. Setup the EUT and simulators as shown on follow.
- B. Enable RF signal and confirm EUT active.
- A. Modulate output capacity of EUT up to specification.

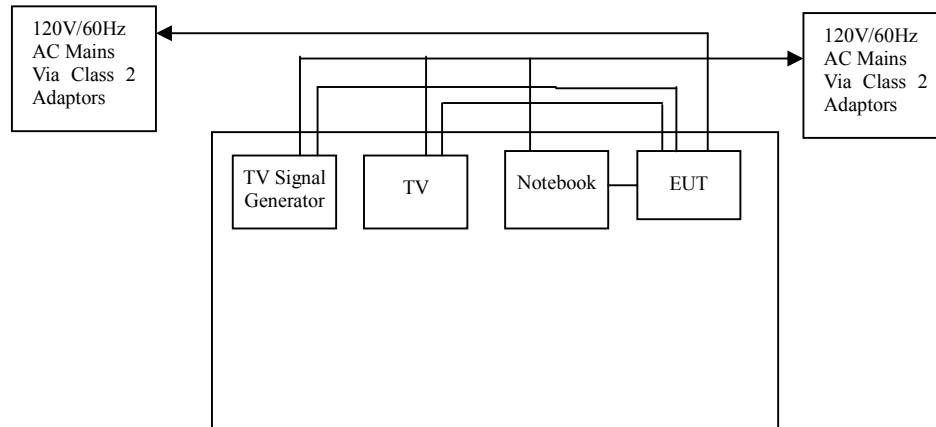

4.6 Conducted Power Line Emission Limits

Frequency Range (MHz)	Class A QP/AV (dBuV)	Class B QP/AV (dBuV)
0.15 – 0.5	79/66	66 –56/56 –46
0.5 – 5.0	73/60	56/46
5.0 – 30	73/60	60/50

Note: In the above table, the tighter limit applies at the band edges.

4.7 Conducted Power Line Test Result

Product	: IP Video Codec	Test Mode	: Normal Link / Auto
Test Item	: Conducted Emission Data	Temperature	: 25 °C
Test Voltage	: DC 12V	Humidity	: 56%RH
Test Result	: PASS	Adapter Model	:

The frequency spectrum from 0.15 MHz to 30 MHz was investigated. All readings are quasi -peak values with a resolution bandwidth of 9 KHz.

- Temperature : 26 °C
- Humidity : 53 % RH

Adapter model: F06US1200050A

FCC 15 Class B										
Frequency (MHz)	Read Level (dBuV)		Factor (dB)	Emission (dBuV)		Line/Neutral	Limit (dBuV)		Margin (dBuV)	
	QP	AV		QP	AV		QP	AV	QP	AV
0.150	43.69	28.12	10.30	53.99	38.42	Line	66.00	56.00	-12.01	-17.58
0.158	41.26	25.59	10.30	51.56	35.89	Neutral	65.57	55.57	-14.01	-19.68
0.170	40.83	25.95	10.30	51.13	36.25	Line	64.96	54.96	-13.83	-18.71
0.178	39.15	24.22	10.30	49.45	34.52	Neutral	64.58	54.58	-15.13	-20.06
0.190	38.39	24.11	10.30	48.69	34.41	Line	64.04	54.04	-15.35	-19.63
0.206	36.28	26.21	10.30	46.58	36.51	Neutral	63.37	53.37	-16.79	-16.86
0.534	33.74	24.82	10.40	44.14	35.22	Line	56.00	46.00	-11.86	-10.78
0.530	31.86	22.65	10.40	42.26	33.05	Neutral	56.00	46.00	-13.74	-12.95

FCC 15 Class B

Note: NF = No Significant Peak was Found.

Adapter model: NBS05B120050VU

FCC 15 Class B										
Frequency (MHz)	Read Level (dBuV)		Factor (dB)	Emission (dBuV)		Line/Neutral	Limit (dBuV)		Margin (dBuV)	
	QP	AV		QP	AV		QP	AV	QP	AV
0.154	37.58	23.15	10.30	47.88	33.45	Line	65.78	55.78	-17.90	-22.33
0.154	35.76	22.35	10.30	46.06	32.65	Neutral	65.78	55.78	-19.72	-23.13
0.174	35.48	22.86	10.30	45.78	33.16	Line	64.77	54.77	-18.99	-21.61
0.162	36.54	23.33	10.30	46.84	33.63	Neutral	65.36	55.36	-18.52	-21.73
0.182	35.16	22.39	10.30	45.46	32.69	Line	64.39	54.39	-18.93	-21.70
0.174	34.29	22.16	10.30	44.59	32.46	Neutral	64.77	54.77	-20.18	-22.31

FCC 15 Class B

Note: NF = No Significant Peak was Found.

Note:

- 1.Uncertainty in conducted emission measured is <+/-2dB.
- 2.The emission levels of other frequencies were very low against the limit.
- 3.All Reading Levels are Quasi-Peak and Average value.
- 4.Emission = Meter Reading + Factor; Factor = Insertion Loss + Cable Loss.
- 5.Margin Value = Emission Level - Limit Value.

Conducted Emission

FCC 15.107

Test Specification: LINE&NEUTRAL

Comment:

Adapter model: F06US1200050A

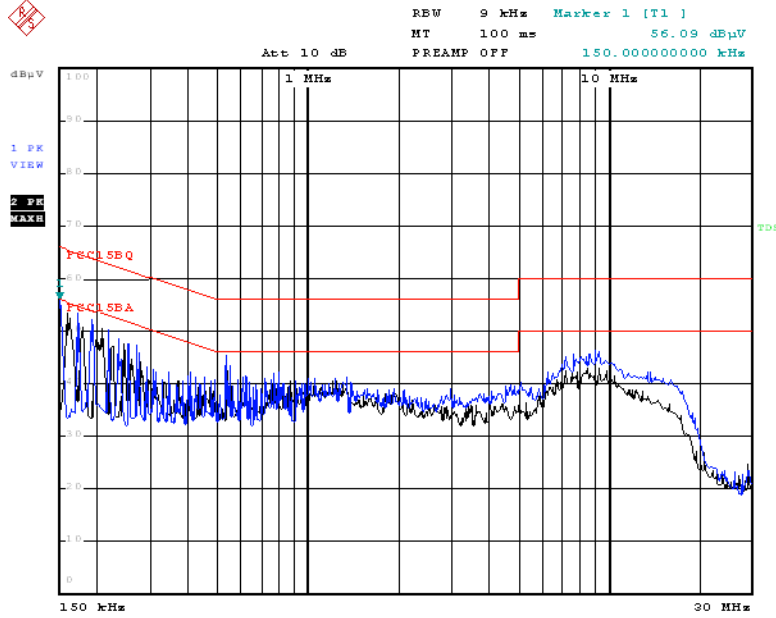

Date: 21. JAN. 2016 09:41:42

Adapter model: NBS05B120050VU

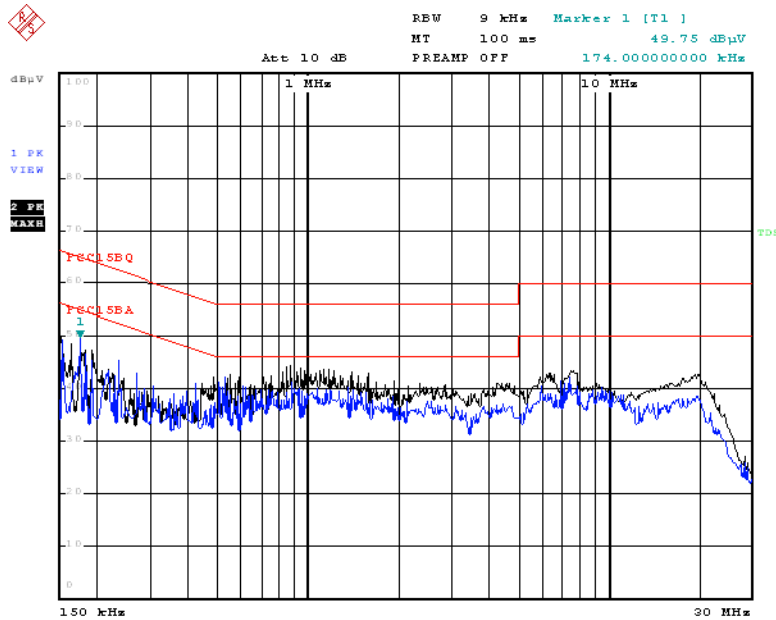

Date: 21. JAN. 2016 09:47:31

5. Radiated Emission Test

5.1 Test Equipment

Please refer to Section 8 this report.

5.2 Test Procedure

1. The EUT was tested according to ANSI C63.4:2014.
2. The EUT, peripherals were put on the turntable which table size is 1m x 1.5 m, table high 0.8 m, and which is 1.5 m high for above 1 GHz. All set up is according to ANSI C63.4:2014 .
3. The frequency spectrum from 9 kHz to 25 GHz was investigated. All readings from 9 kHz to 150 kHz are quasi-peak values with a resolution bandwidth of 200 Hz. All readings from 150 kHz to 30 MHz are quasi-peak values with a resolution bandwidth of 9 KHz. All readings from 30 MHz to 1 GHz are quasi-peak values with a resolution bandwidth of 120 KHz. All readings are above 1 GHz , peak values with a resolution bandwidth of 1 MHz . Measurements were made at 3 meters.
4. The emissions from the EUT were measured continuously at every azimuth by rotating the turntable. The Receiving antenna high is varied from 1 m to 4 m high to find the maximum emission for each frequency. Emissions below 30MHz were measured with a loop antenna while emission above 30MHz were measured using a broadband E-field antenna.
5. Maximizing procedure was performed on the six (6) highest emissions to ensure EUT compliance is with all installation combinations. All data was recorded in the peak detection mode. Quasi-peak readings was performed only when an emission was found to be marginal (within -4 dB of specification limit), and are distinguished with a "QP" in the data table.
6. Each emission was to be maximized by changing the polarization of receiving antenna both horizontal and vertical. In order to find out the max. emission, the relative positions of this transmitter(EUT) was rotated through three orthogonal axes according to the requirements in Section 8 and 13 of ANSI C63.4:2014

5.3 Radiated Test Setup

For Frequencies below 30 MHz

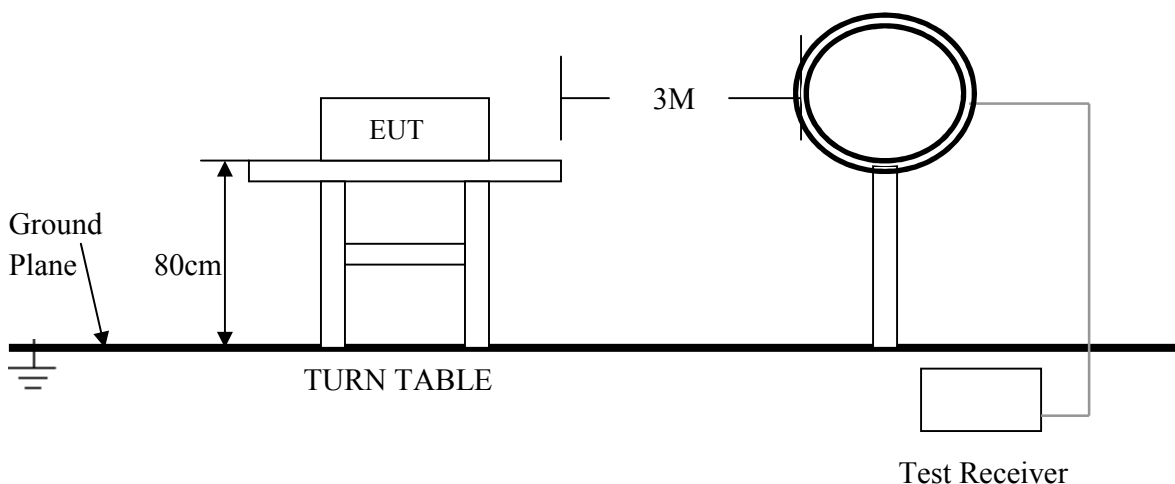

For the actual test configuration , please refer to the related items – Photos of Testing

For Frequencies above 30 MHz

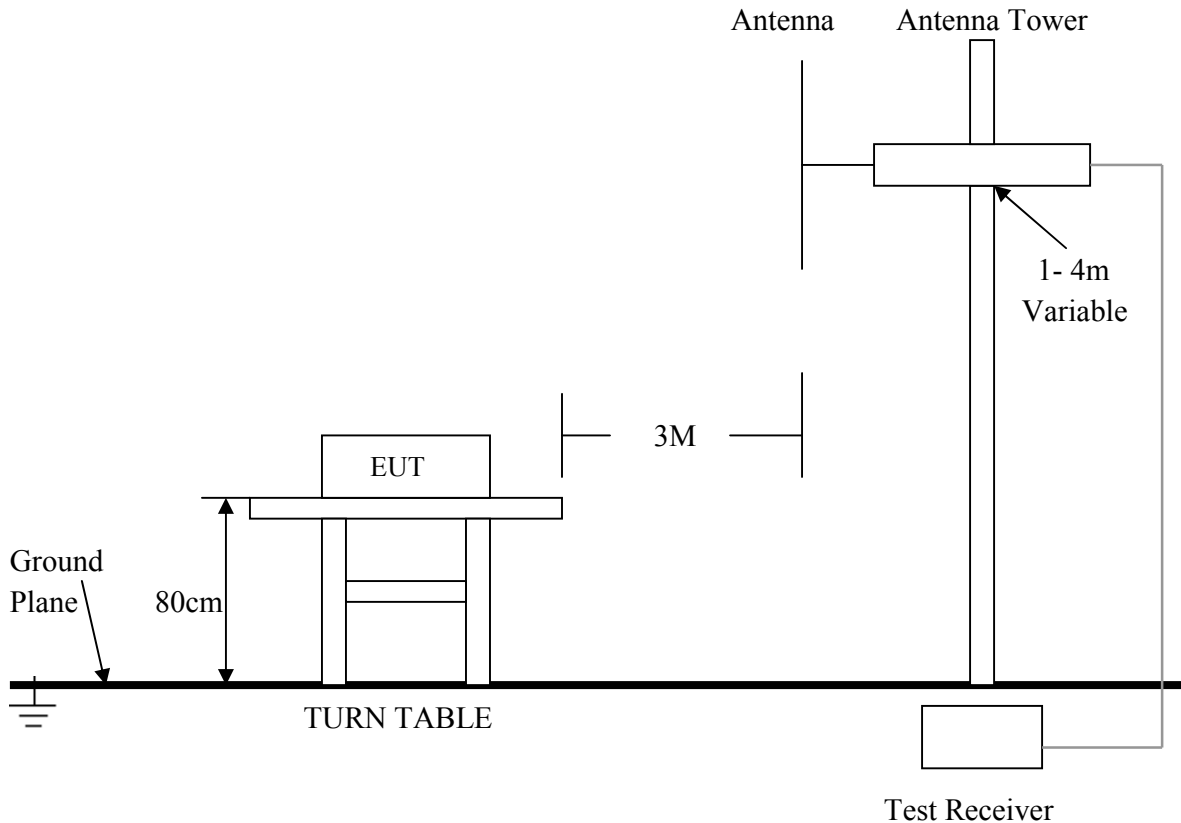

For the actual test configuration , please refer to the related items – Photos of Testing

5.4 Configuration of The EUT

Same as section 4.4 of this report

5.5 EUT Operating Condition

Same as section 4.5 of this report

5.6 Radiated Emission Limit

All emission from a digital device, including any network of conductors and apparatus connected thereto, shall not exceed the level of field strength specified below:

Frequencies in restricted band are complied to limit on Paragraph 15.109.

Frequency (MHz)	Distance (m)	Field Strength (dBuV/m)
30 - 88	3	40.0
88 - 216	3	43.5
216 - 960	3	46.0
Above 960	3	54.0

Note:

1. In the emission tables above, the tighter limit applies at the band edges.
2. Distance refers to the distance between measuring instrument, antenna, and the closest point of any part of the device or system.
3. The lower limit shall apply at the transition frequencies.

5.7 Radiated Emission Test Result

Product	: IP Video Codec	Test Mode	: Normal Link / Auto
Test Item	: Fundamental Radiated Emission Data	Temperature	: 25 °C
Test Voltage	: DC 12V	Humidity	: 56%RH
Test Result	: PASS	Model	:

For Frequency below 30MHz

Freq. (MHz)	Emission (dBuV/m) QP Detector	HORIZ / VERT	Limits (dBuV/m)	Margin (dB)
N/A				
N/A				
N/A				
N/A				
N/A				
N/A				

- Note:**
- (1) All Readings below 1GHz are Quasi-Peak, above are performed with peak and/or average measurements as necessary.
 - (2) "N/A" remark, if no specific emissions from the EUT are recorded (ie: margin>20dB from the applicable limit) and considered that's already beyond the background noise floor.
 - (3) Emission Level = Reading Level + Probe Factor + Cable Loss.

For Frequency from 30MHz to 1GHz

Adapter model: F06US1200050A

FCC 15 Class B						
Frequency (MHz)	Read Level (dBuV)	Factor (dB)	Emission (dBuV/m)	Horiz./ Vert.	Limit (dBuV/m)	Margin (dB)
250.040	19.75	14.93	34.68	Horiz./	46.0	-11.32
250.000	16.69	14.93	31.62	Vert.	46.0	-14.38
375.000	16.46	17.13	33.58	Horiz./	46.0	-12.42
375.000	22.37	17.13	39.49	Vert.	46.0	-6.51
797.120	9.61	26.96	36.56	Horiz./	46.0	-9.44
517.480	14.77	17.29	32.06	Vert.	46.0	-13.94

Adapter model: NBS05B120050VU

FCC 15 Class B						
Frequency (MHz)	Read Level (dBuV)	Factor (dB)	Emission (dBuV/m)	Horiz./ Vert.	Limit (dBuV/m)	Margin (dB)
250.000	22.55	14.93	37.48	Horiz./	46.0	-8.52
64.760	20.65	11.50	32.14	Vert.	40.0	-7.86
475.000	13.51	20.12	33.62	Horiz./	46.0	-12.38
66.320	20.29	11.50	31.78	Vert.	40.0	-8.22
517.680	12.85	17.29	30.14	Horiz./	46.0	-15.86
250.000	17.43	14.93	32.36	Vert.	46.0	-13.64

- Note:**
- (1) All Readings below 1GHz are Quasi-Peak, above are performed with peak and/or average measurements as necessary.
 - (2) "N/A" remark, if no specific emissions from the EUT are recorded (ie: margin>20dB from the applicable limit) and considered that's already beyond the background noise floor.
 - (3) Emission Level = Reading Level + Probe Factor + Cable Loss.

Frequency above 1 GHz

FCC 15 Class B										
Frequency (MHz)	Read Level(dBuV)		Factor (dB)	Emission(dBuV/m)		Horiz./Vert.	Limit (dBuV/m)		Margin(dB)	
	PK	AV		PK	AV		PK	AV	PK	AV
	1000.140	35.34		27.29	14.93		50.27	42.22	Horiz./	74.0
1000.140	34.32	32.52	11.50	45.81	44.01	Vert.	74.0	54.0	-28.19	-9.99
1498.320	31.39	19.44	20.12	51.5	39.55	Horiz./	74.0	54.0	-22.50	-14.45
1498.320	36.92	28.01	11.50	48.41	39.5	Vert.	74.0	54.0	-25.59	-14.50
-						Horiz./	74.0	54.0	-	-
-						Vert.	74.0	54.0	-	-
FCC 15 Class B										

- Note:**
- (1) All Readings below 1GHz are Quasi-Peak, above are performed with peak and/or average measurements as necessary.
 - (2) Emission Level = Reading Level + Probe Factor + Cable Loss.

Radiated Emission
FCC 15.109
For Frequency from 30MHz to 1GHz
Adapter model: F06US1200050A

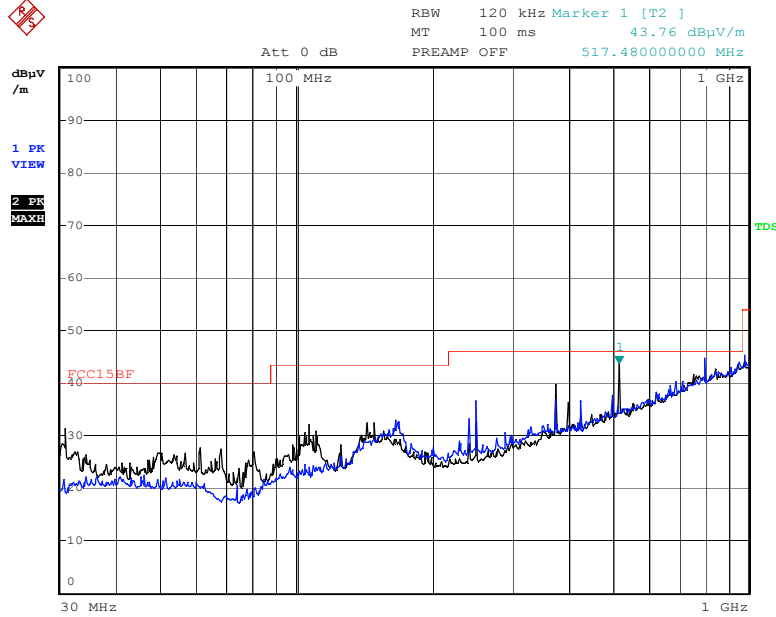

Date: 20.JAN.2016 16:59:53

Adapter model: NBS05B120050VU

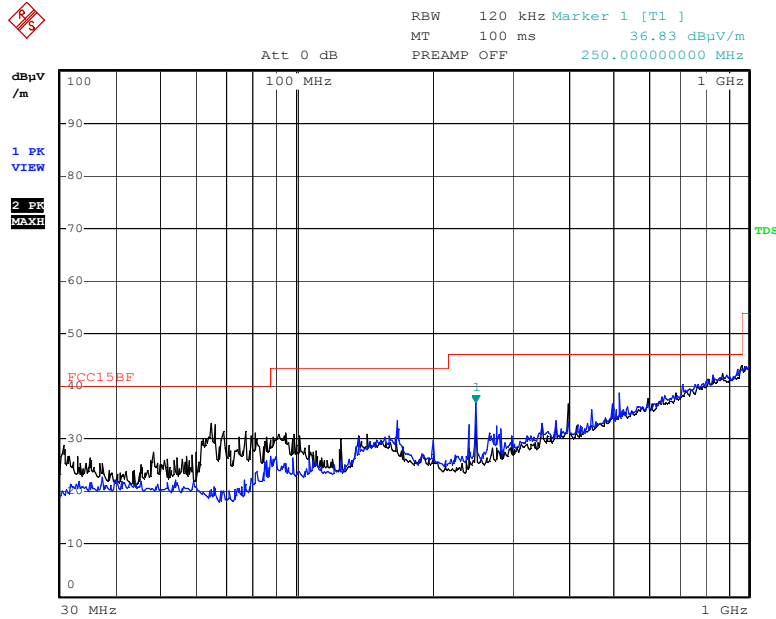

Date: 21.JAN.2016 09:17:03

6. Photo of Testing

6.1 Emission test view



Radiated Emission test view (Frequency from 30MHz to 1GHz)



Radiated Emission test view (Frequency above 1GHz)

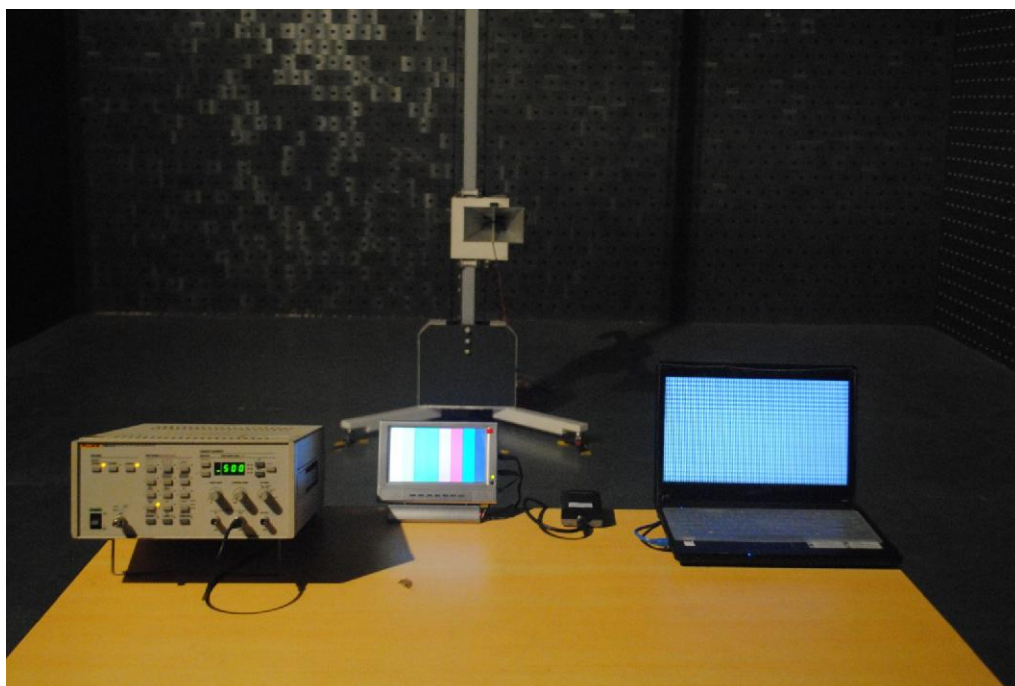

6.2 Photograph - EUT

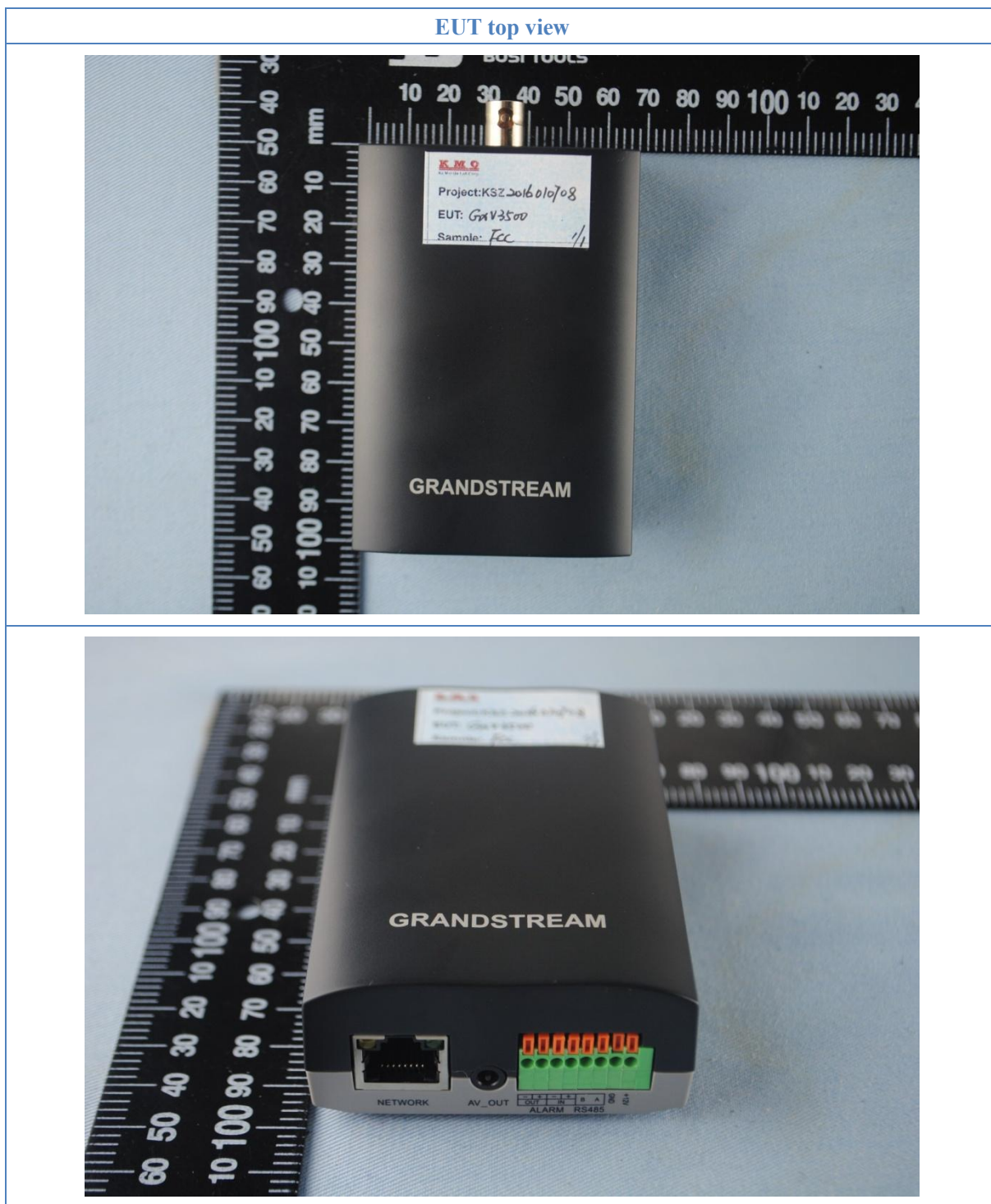



EUT bottom view

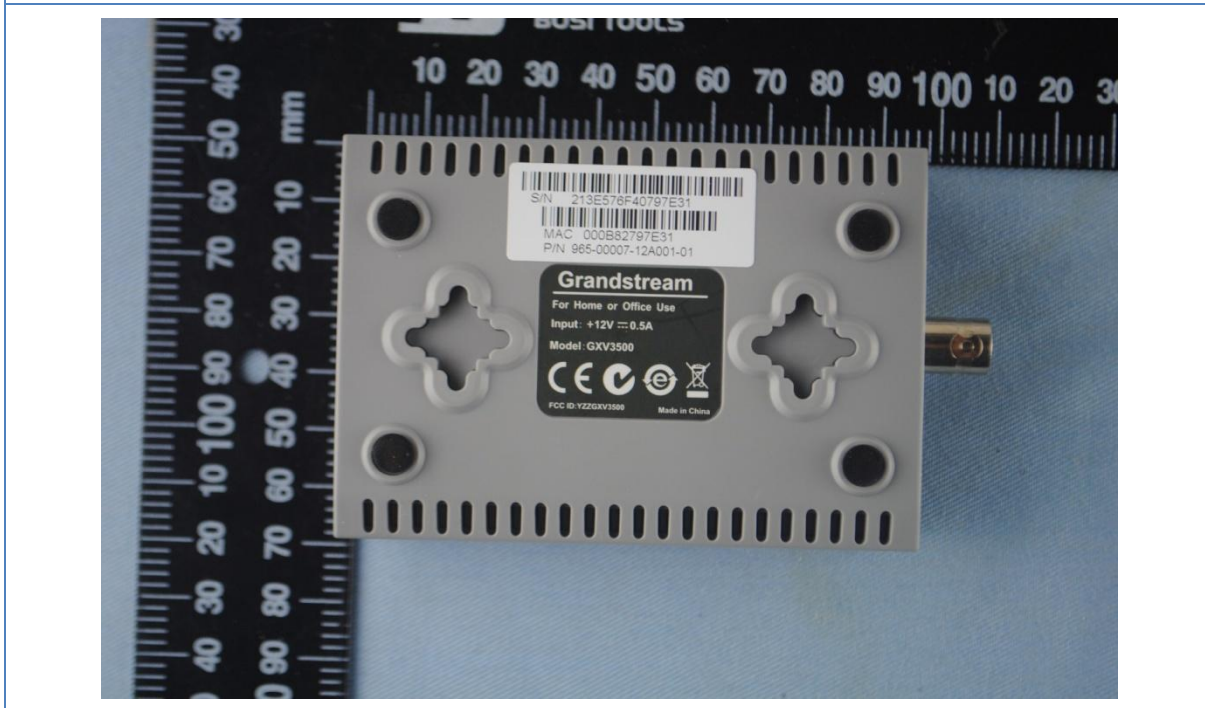

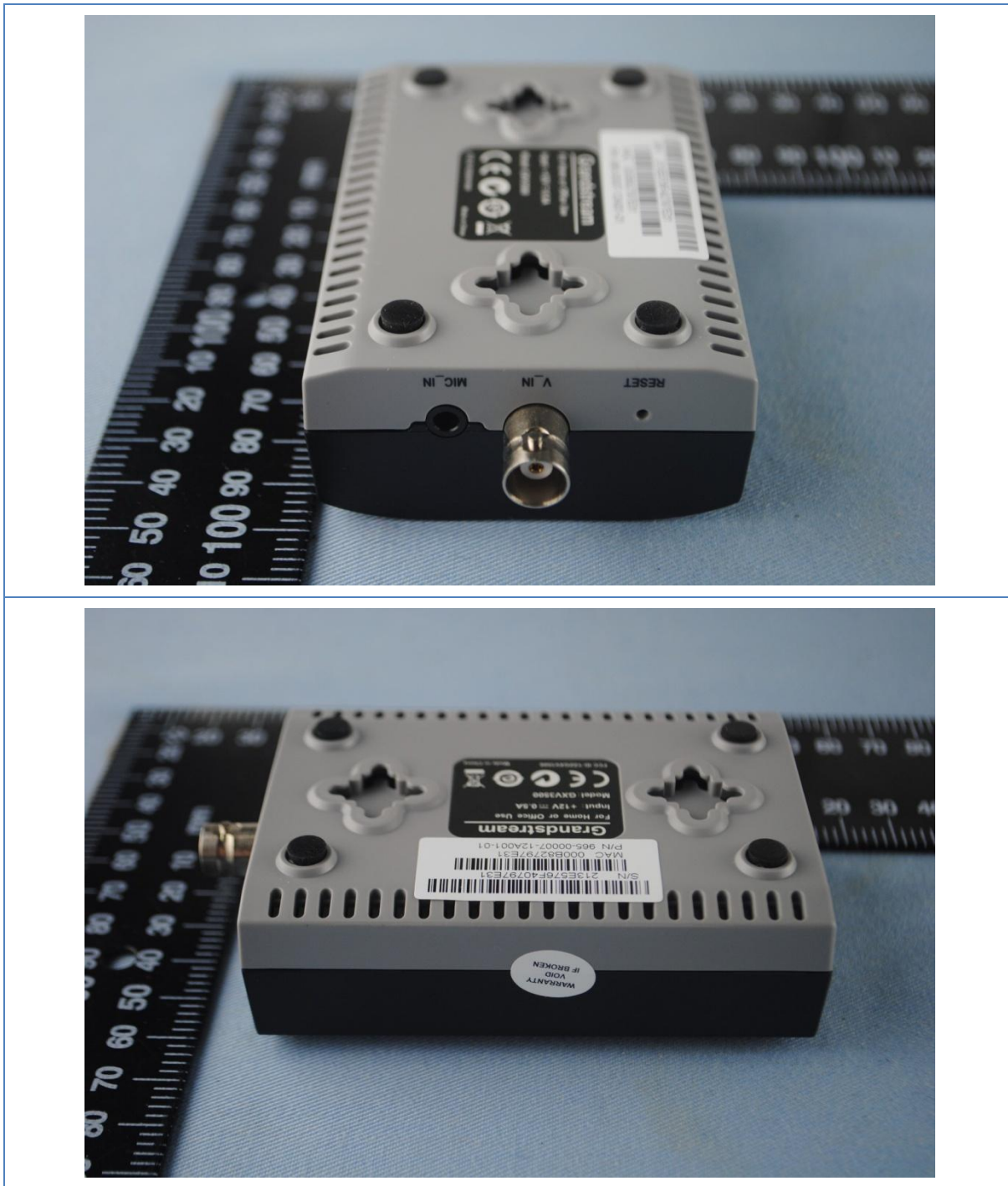

Adapter top view sunlight

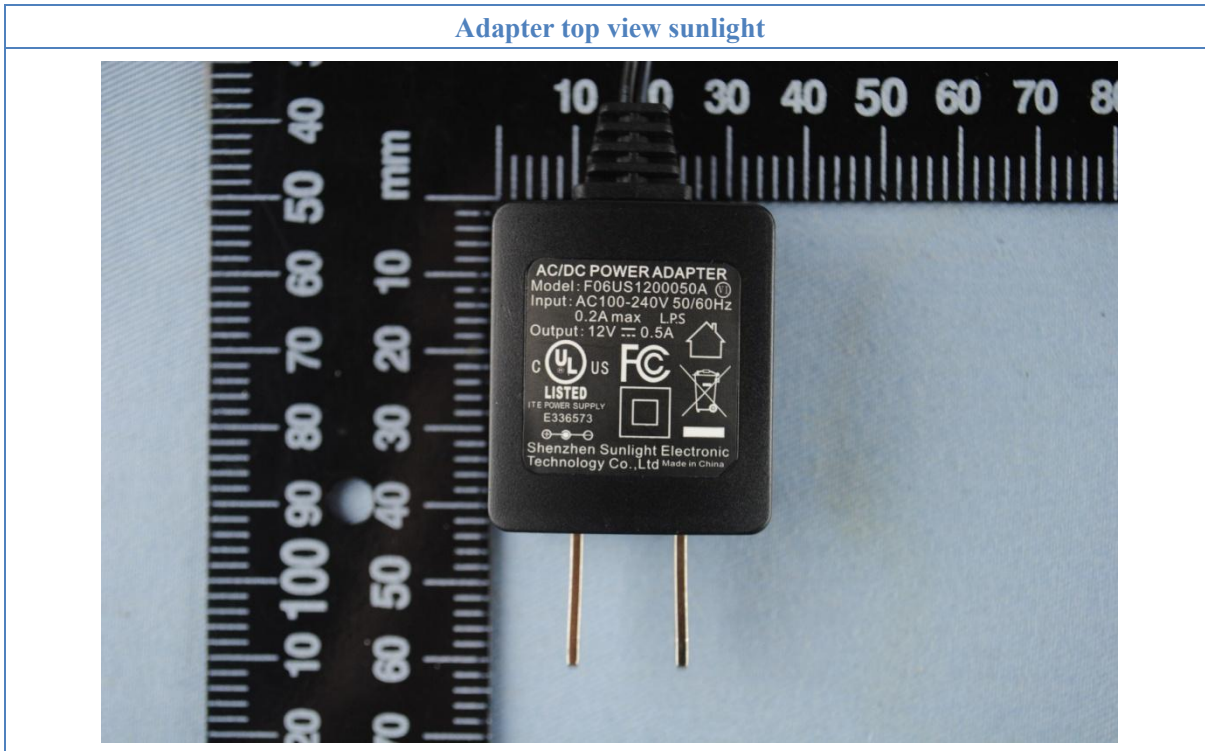

Adapter side view



Adapter top view mass

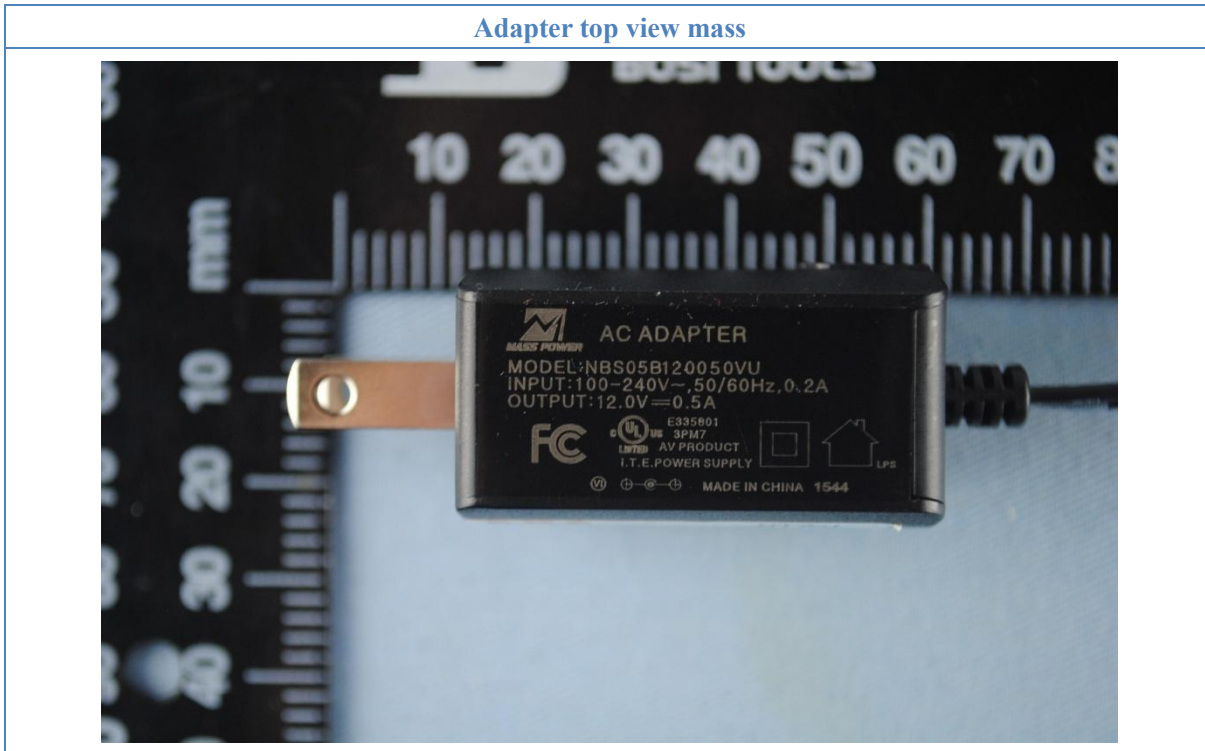

Adapter side view



7. FCC ID Label

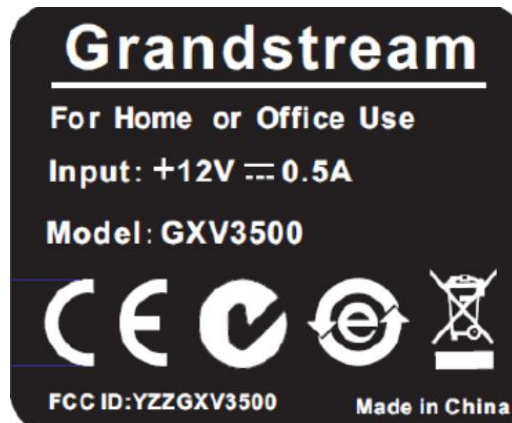

The following note shall be conspicuously placed in the users manual: **“Operation is subject to the following two conditions: (1) this device may not cause interference, and (2) this device must accept any interference, including interference that may cause undesired operation of this device.”**

The Label must not be a stick-on paper label. The Label on these products must be permanently affixed to the product and readily visible at the time of purchase and must last the expected lifetime of the equipment not be readily detachable.

Proposed Label Location on EUT

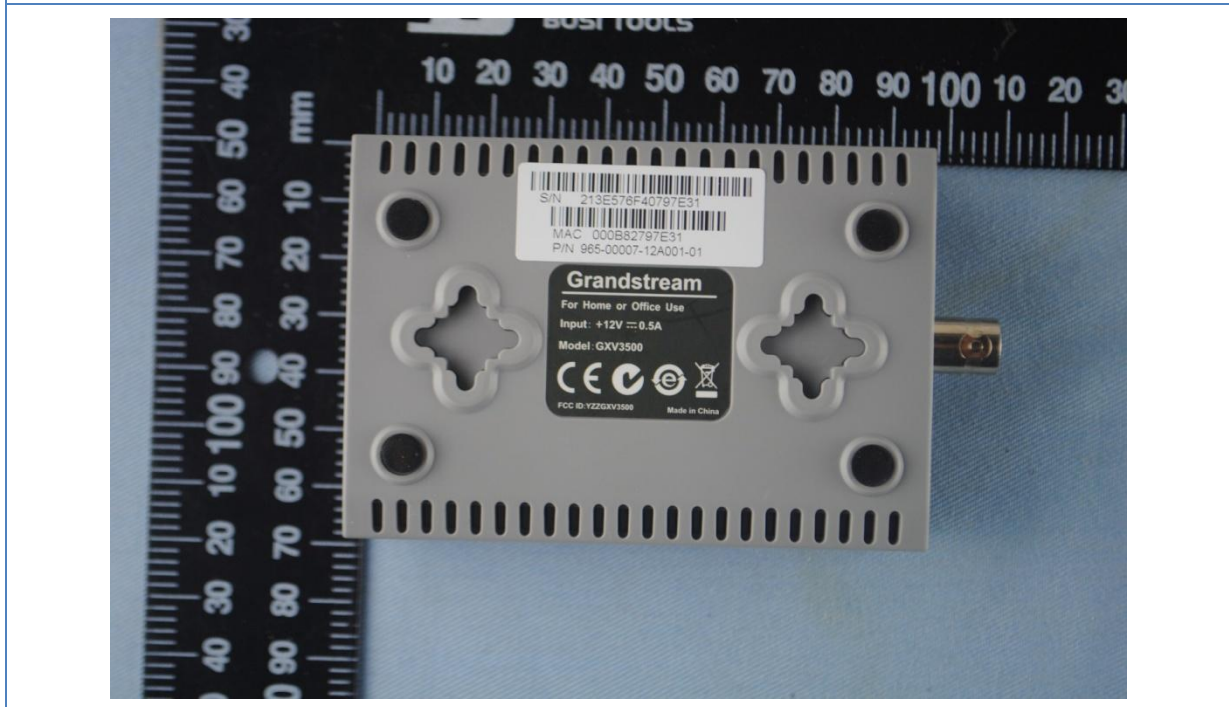

8. Test Equipment

The following test equipments were used during the radiated & conducted emission test:

Equipment/ Facilities	Manufacturer	Model #	Serial No.	Due Date
Turntable	Innco systems GmbH	CT-0801	KMO-SZ114	NCR
Antenna Tower	Innco systems GmbH	MM4000-PP	KMO-SZ115	NCR
Controller	Innco systems GmbH	CO2000	KMO-SZ116	NCR
Pre-Amplifier	Agilent	87405C	KMO-SZ155	Dec.6, 2016
Pre-Amplifier	Com-Power	PAM-840	KMO-SZ156	Dec.6, 2016
Horn Antenna	Com-Power	AH-840	KMO-SZ157	Dec.6, 2016
EMI Test Receiver	Rohde & Schwarz	ESPI7	KMO-SZ002	June 27, 2016
Spectrum Analyzer	Rohde & Schwarz	FSP40	KMO-SZ003	June 27, 2016
Signal Generator	FLUKE	PM5418+Y/C	KMO-SZ020	May 27, 2016
Loop Antenna	Rohde & Schwarz	HFH2-Z2	KMO-SZ004	August 19, 2018
Trilog-Super Broadband Antenna	SCHWARZBECK	VULB9161	KMO-SZ005	August 27, 2018
Trilog-Super Broadband Antenna	SCHWARZBECK	VULB9161	KMO-SZ006	August 19, 2018
Broad-Band Horn Antenna	SCHWARZBECK	BBHA 9120D	KMO-SZ007	August 19, 2018
Broad-Band Horn Antenna	SCHWARZBECK	BBHA 9120D	KMO-SZ008	August 19, 2018
AMN	Rohde & Schwarz	ESH3-Z5	KMO-SZ009	June 27, 2016
Pulse Limiter	SCHWARZBECK	VTSD 9561-F	KMO-SZ077	Nov.29, 2016
ISN	SCHWARZBECK	NTFM 8158 CAT3	KMO-SZ070	Nov.19, 2016
ISN	SCHWARZBECK	NTFM 8158 CAT5	KMO-SZ071	Nov.19, 2016
ISN	SCHWARZBECK	NTFM 8158 CAT6	KMO-SZ072	Nov.19, 2016
KMO Shielded Room	KMO	KMO-001	KMO-SZ036	NCR
Coaxial Cable with N-Connectors	SCHWARZBECK	AK9515H	KMO-SZ037	Sep.18, 2016
AC Power Source / Analyzer	Agilent	6813B	KMO-SZ166	July 22, 2016
Power Meter	Rohde & Schwarz	OSP-B157	KMO-HK015	Nov.6, 2016
Digital Radio Communication Tester	Rohde & Schwarz	CMD60	KMO-SZ169	April 10, 2016
Universal Radio Communication Tester	Rohde & Schwarz	CMU200	KMO-SZ170	April 10, 2016
Regulatory Test System 30 MHz to 40 GHz	Rohde & Schwarz	TS8997	KMO-HK015	Nov.6, 2016
Program Control Telephone Exchanger	Excelltel	CDX8000-M	KMO-SZ221	NCR
3m Anechoic Chamber	KMO	KMO-3AC	KMO-3AC-1	Nov.12, 2016
Temperature Chamber	TABAI	PSL-4GTW	N/A	Feb.10, 2017