



TEST REPORT

APPLICANT : Grandstream Networks, Inc.

PRODUCT NAME : IP Multimedia Phone

MODEL NAME : GXV3380

BRAND NAME : GRANDSTREAM

FCC ID : YZZGXV3380

STANDARD(S) : 47 CFR Part 15 Subpart E

RECEIPT DATE : 2019-04-12

TEST DATE : 2019-05-06

ISSUE DATE : 2019-06-11

Edited by: Zeng Xiaoying
Zeng Xiaoying (Rapporteur)

Approved by: Peng Huarui
Peng Huarui (Supervisor)

NOTE: This document is issued by MORLAB, the test report shall not be reproduced except in full without prior written permission of the company. The test results apply only to the particular sample(s) tested and to the specific tests carried out which is available on request for validation and information confirmed at our website.





DIRECTORY

| | |
|--|-----------|
| 1. Technical Information | 4 |
| 1.1. Applicant and Manufacturer Information | 4 |
| 1.2. Companion Equipment(Master) Description | 4 |
| 1.3. Equipment Under Test (EUT) Description | 4 |
| 1.4. The channel number and frequency of EUT | 6 |
| 1.5. Test Standards and Results | 7 |
| 1.6. Environmental Conditions | 7 |
| 2. 47 CFR Part 15E Requirements | 8 |
| 2.1. Transmit Power Control (TPC) and Dynamic Frequency Selection (DFS) | 8 |
| Annex A The waveform of the radar | 24 |
| Annex B Test Uncertainty | 27 |
| Annex C Testing Laboratory Information | 28 |



| Change History | | |
|-----------------------|-------------|--------------------------|
| Version | Date | Reason for change |
| 1.0 | 2019-06-11 | First edition |
| | | |



1. Technical Information

Note: Provide by applicant.

1.1. Applicant and Manufacturer Information

| | |
|------------------------------|---|
| Applicant: | Grandstream Networks, Inc. |
| Applicant Address: | 126 Brookline Ave., 3rd Floor Boston, MA 02215, USA |
| Manufacturer: | Grandstream Networks, Inc. |
| Manufacturer Address: | 126 Brookline Ave., 3rd Floor Boston, MA 02215, USA |

1.2. Companion Equipment(Master) Description

| | |
|----------------------|-------------|
| Product Name: | Router |
| Manufacturer: | Cisco |
| FCC ID: | LDK102091 |
| Serial No: | FGL1848X9S5 |
| Antenna Gain: | 2.1 dBi |

1.3. Equipment Under Test (EUT) Description

| | |
|-----------------------------------|---|
| Product Name: | IP Multimedia Phone |
| Serial No: | (N/A, marked #1 by test site) |
| Hardware Version: | V1.6 |
| Software Version: | 1.0.0.10 |
| Modulation Type: | OFDM |
| Modulation Mode: | 802.11a, 802.11n(HT20), 802.11n(HT40) 802.11ac(VHT20), 802.11ac(VHT40), 802.11ac(VHT80), |
| Operating Frequency Range: | 5.180 GHz- 5.240 GHz; 5.260 GHz -5.320 GHz ; 5.500 GHz -5.720 GHz ; 5.745GHz- 5.825GHz |
| Channel Number: | Refer to 1.4 |
| Antenna Type: | PCB Antenna |
| Antenna Gain: | 5.0 dBi |



| | | |
|-------------------------------|---------------|-------------------------------|
| Accessory Information: | AC Adapter1 | |
| | Brand Name: | FRECOM |
| | Model No.: | F18W8-120150SPAUY |
| | Serial No.: | (N/A, marked #1 by test site) |
| | Rated Output: | 12V=1.5A |
| | Rated Input: | 100-240V ~ 50/60Hz 0.6A |
| | AC Adapter2 | |
| | Brand Name: | SUNLIGHT |
| | Model No.: | H18US1200150A |
| | Serial No.: | (N/A, marked #1 by test site) |
| | Rated Output: | 12V=1.5A |
| | Rated Input: | 100-240V ~ 50/60Hz 0.8A |

Note 1: The product provides two adapters, which are shipped randomly. Both of the two adaptors were tested, only the worst test result(Adapter2) were recorded in the test report.

Note 2: For a more detailed description, please refer to Specification or User’s Manual supplied by the applicant and/or manufacturer.

1.4. The channel number and frequency of EUT

| Frequency Range: 5180MHz-5240MHz | | | | |
|----------------------------------|------------|-----------------|------------|-----------------|
| Bandwidth | Channel | Frequency (MHz) | Channel | Frequency (MHz) |
| 20MHz | 36 | 5180 | 40 | 5200 |
| | 44 | 5220 | 48 | 5240 |
| 40MHz | 38 | 5190 | 46 | 5230 |
| 80MHz | 42 | 5210 | | |
| Frequency Range: 5260MHz-5320MHz | | | | |
| Bandwidth | Channel | Frequency (MHz) | Channel | Frequency (MHz) |
| 20MHz | 52 | 5260 | 56 | 5280 |
| | 60 | 5300 | 64 | 5320 |
| 40MHz | 54 | 5270 | 62 | 5310 |
| 80MHz | 58 | 5290 | | |
| Frequency Range: 5500MHz-5720MHz | | | | |
| Bandwidth | Channel | Frequency (MHz) | Channel | Frequency (MHz) |
| 20MHz | 100 | 5500 | 105 | 5520 |
| | | | 108 | 5540 |
| | | | 116 | 5580 |
| | | | 124 | 5620 |
| | | | 132 | 5660 |
| | | | 140 | 144 |
| 40MHz | 102 | 5510 | 110 | 5550 |
| | | | 118 | 5590 |
| | | | 134 | 142 |
| 80MHz | 106 | 5530 | 122 | 5610 |
| | 138 | 5690 | | |
| Frequency Range: 5745-5825MHz | | | | |
| Bandwidth | Channel | Frequency (MHz) | Channel | Frequency (MHz) |
| 20MHz | 149 | 5745 | 153 | 5765 |
| | 157 | 5785 | 161 | 5805 |
| | 165 | 5825 | | |
| 40MHz | 151 | 5775 | 159 | 5795 |
| 80MHz | 155 | 5775 | | |

Note 1: The black bold channels were selected for test.



1.5. Test Standards and Results

The objective of the report is to perform testing according to 47 CFR Part 15 Subpart E (U-NII band) for the EUT FCC ID Certification:

| No | Identity | Document Title |
|----|---------------------------------|-------------------------|
| 1 | 47 CFR Part 15 (5-1-14 Edition) | Radio Frequency Devices |

Test detailed items/section required by FCC rules and results are as below:

| No. | Section | Description | Test Date | Test Engineer | Result |
|---|-----------|-------------|--------------|---------------|--------|
| 1 | 15.407(h) | TPC and DFS | May 06, 2019 | Wang Meng | PASS |
| <p>Note2: The DFS section for U-NII band is applicable to this report, the other test items are documented in a separate report.</p> <p>Note3: These RF tests were performed according to the method of measurements prescribed in KDB 905462 D02 UNII DFS Compliance Procedures New Rules v02.</p> | | | | | |

1.6. Environmental Conditions

During the measurement, the environmental conditions were within the listed ranges:

| | |
|-----------------------------|---------|
| Temperature (°C): | 15 - 35 |
| Relative Humidity (%): | 30 -60 |
| Atmospheric Pressure (kPa): | 86-106 |



2.47 CFR Part 15E Requirements

2.1. Transmit Power Control (TPC) and Dynamic Frequency Selection (DFS)

2.1.1. Requirement

According to FCC section 15.407(h), (1) Transmit power control (TPC). U-NII devices operating in the 5.25-5.35 GHz band and the 5.47-5.725 GHz band shall employ a TPC mechanism. The U-NII device is required to have the capability to operate at least 6 dB below the mean EIRP value of 30 dBm. A TPC mechanism is not required for systems with an e.i.r.p. of less than 500 mW.(2) Radar Detection Function of Dynamic Frequency Selection (DFS). U-NII devices operating with any part of its 26 dB emission bandwidth in the 5.25-5.35 GHz and 5.47-5.725 GHz bands shall employ a DFS radar detection mechanism to detect the presence of radar systems and to avoid co-channel operation with radar systems. Operators shall only use equipment with a DFS mechanism that is turned on when operating in these bands. The device must sense for radar signals at 100 percent of its emission bandwidth. The minimum DFS detection threshold for devices with a maximum e.i.r.p. of 200 mW to 1 W is -64 dBm. For devices that operate with less than 200 mW e.i.r.p. and a power spectral density of less than 10 dBm in a 1 MHz band, the minimum detection threshold is -62 dBm. The detection threshold is the received power averaged over 1 microsecond referenced to a 0 dBi antenna. For the initial channel setting, the manufacturers shall be permitted to provide for either random channel selection or manual channel selection.

A U-NII network will employ a DFS function to detect signals from radar systems and to avoid co-channel operation with these systems. This applies to the 5250-5350 MHz and/or 5470-5725 MHz bands.1

Within the context of the operation of the DFS function, a U-NII device will operate in either Master Mode or Client Mode. U-NII devices operating in Client Mode can only operate in a network controlled by a U-NII device operating in Master Mode.2

Tables 1 and 2 shown below summarize the information contained in sections 5.1.1 and 5.1.2.

Table 1: Applicability of DFS Requirements Prior to Use of a Channel

| Requirement | Operational Mode | | |
|---------------------------------|------------------|--------------------------------|-----------------------------|
| | Master | Client Without Radar Detection | Client With Radar Detection |
| Non-Occupancy Period | Yes | Not required | Yes |
| DFS Detection Threshold | Yes | Not required | Yes |
| Channel Availability Check Time | Yes | Not required | Not required |
| U-NII Detection Bandwidth | Yes | Not required | Yes |



Table 2: Applicability of DFS requirements during normal operation

| Requirement | Operational Mode | |
|-----------------------------------|------------------|--------------------------------|
| | Master | Client Without Radar Detection |
| DFS Detection Threshold | Yes | Not required |
| Channel Closing Transmission Time | Yes | Yes |
| Channel Move Time | Yes | Yes |
| U-NII Detection Bandwidth | Yes | Not required |

| Additional requirements for devices with multiple bandwidth modes | Master Device or Client with Radar Detection | Client Without Radar Detection |
|---|--|--|
| U-NII Detection Bandwidth and Statistical Performance Check | All BW modes must be tested | Not required |
| Channel Move Time and Channel Closing Transmission Time | Test using widest BW mode available | Test using the widest BW mode available for the link |
| All other tests | Any single BW mode | Not required |
| Note: Frequencies selected for statistical performance check (Section 7.8.4) should include several frequencies within the radar detection bandwidth and frequencies near the edge of the radar detection bandwidth. For 802.11 devices it is suggested to select frequencies in each of the bonded 20 MHz channels and the channel center frequency. | | |

The operational behavior and individual DFS requirements that are associated with these modes are as follows:

Master Devices

- a) The Master Device will use DFS in order to detect Radar Waveforms with received signal strength above the DFS Detection Threshold in the 5250 – 5350 MHz and 5470 – 5725 MHz bands. DFS is not required in the 5150 – 5250 MHz or 5725 – 5825 MHz bands.
- b) Before initiating a network on a Channel, the Master Device will perform a Channel Availability Check for specified time duration (Channel Availability Check Time) to ensure that there is no radar system operating on the Channel, using DFS described under subsection a) above.
- c) The Master Device initiates a U-NII network by transmitting control signals that will enable other U-NII devices to Associate with the Master Device.
- d) During normal operation, the Master Device will monitor the Channel (In-Service Monitoring) to ensure that there is no radar system operating on the Channel, using DFS described under a).
- e) If the Master Device has detected a Radar Waveform during In-Service Monitoring as described under d), the Operating Channel of the U-NII network is no longer an Available Channel. The Master Device will instruct all associated Client Device(s) to stop transmitting on this Channel within the Channel Move Time. The transmissions during the Channel Move Time will be limited to the Channel Closing Transmission Time.



f) Once the Master Device has detected a Radar Waveform it will not utilize the Channel for the duration of the Non-Occupancy Period. 3

g) If the Master Device delegates the In-Service Monitoring to a Client Device, then the combination will be tested to the requirements described under d) through f) above.

Client Devices

a) A Client Device will not transmit before having received appropriate control signals from a Master Device.

b) A Client Device will stop all its transmissions whenever instructed by a Master Device to which it is associated and will meet the Channel Move Time and Channel Closing Transmission Time requirements. The Client Device will not resume any transmissions until it has again received control signals from a Master Device.

c) If a Client Device is performing In-Service Monitoring and detects a Radar Waveform above the DFS Detection Threshold, it will inform the Master Device. This is equivalent to the Master Device detecting the Radar Waveform and d) through f) of section 5.1.1 apply.

d) Irrespective of Client Device or Master Device detection the Channel Move Time and Channel Closing Transmission Time requirements remain the same.

e) The client test frequency must be monitored to ensure no transmission of any type has occurred for 30 minutes. Note: If the client moves with the master, the device is considered compliant if nothing appears in the client non-occupancy period test. For devices that shut down (rather than moving channels), no beacons should appear.

DFS Detection Thresholds

Table 3 below provides the DFS Detection Thresholds for Master Devices as well as Client Devices incorporating In-Service Monitoring.

Table 3: DFS Detection Thresholds for Master Devices and Client Devices with Radar Detection

| Maximum Transmit Power | Value (See Notes 1, 2, and 3) |
|--|-------------------------------|
| EIRP ≥ 200 milliwatt | -64 dBm |
| EIRP < 200 milliwatt and power spectral density < 10 dBm/MHz | -62 dBm |
| EIRP < 200 milliwatt that do not meet the power spectral density requirement | -64 dBm |
| <p>Note 1: This is the level at the input of the receiver assuming a 0 dBi receive antenna.</p> <p>Note 2: Throughout these test procedures an additional 1 dB has been added to the amplitude of the test transmission waveforms to account for variations in measurement equipment. This will ensure that the test signal is at or above the detection threshold level to trigger a DFS response.</p> <p>Note3: EIRP is based on the highest antenna gain. For MIMO devices refer to KDB Publication 662911 D01.</p> | |

Response Requirements

Table 4 provides the response requirements for Master and Client Devices incorporating DFS.

Table 4: DFS Response Requirement Values

| Parameter | Value |
|-----------------------------------|--|
| Non-occupancy period | Minimum 30 minutes |
| Channel Availability Check Time | 60 seconds |
| Channel Move Time | 10 seconds See Note 1. |
| Channel Closing Transmission Time | 200 milliseconds + an aggregate of 60 milliseconds over remaining 10 second period. See Notes 1 and 2. |
| U-NII Detection Bandwidth | Minimum 100% of the U-NII 99% transmission power bandwidth. See Note 3. |

Note 1: Channel Move Time and the Channel Closing Transmission Time should be performed with Radar Type 0. The measurement timing begins at the end of the Radar Type 0 burst.

Note 2: The Channel Closing Transmission Time is comprised of 200 milliseconds starting at the beginning of the Channel Move Time plus any additional intermittent control signals required to facilitate a Channel move (an aggregate of 60 milliseconds) during the remainder of the 10 second period. The aggregate duration of control signals will not count quiet periods in between transmissions.

Note 3: During the U-NII Detection Bandwidth detection test, radar type 0 should be used. For each frequency step the minimum percentage of detection is 90 percent. Measurements are performed with no data traffic.

2.1.2. Test Description

According to Section 7.2 of KDB 905462 D02 V01R01

1. Setup for Master with injection at the Master

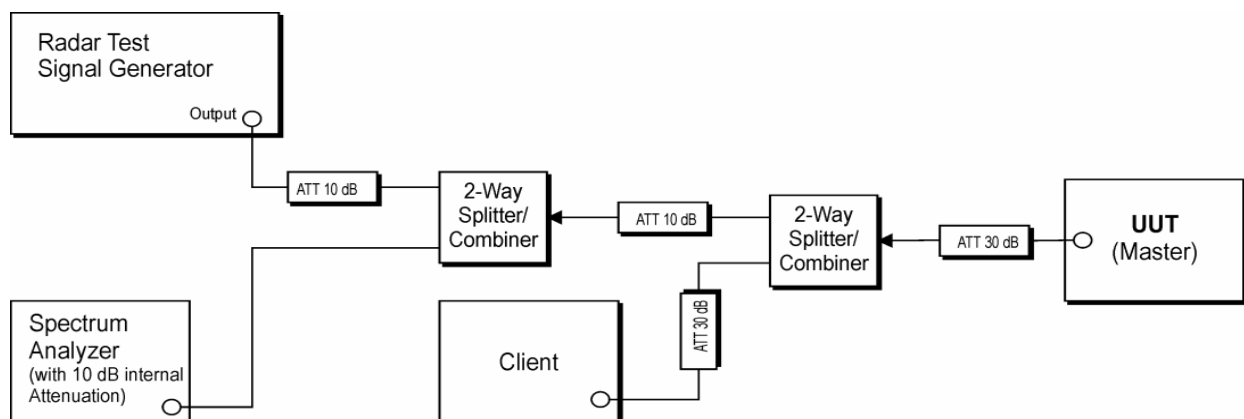

(Example Conducted Setup where UUT is a Master and Radar Test Waveforms are injected into the Master)

2. Setup for Client with injection at the Master

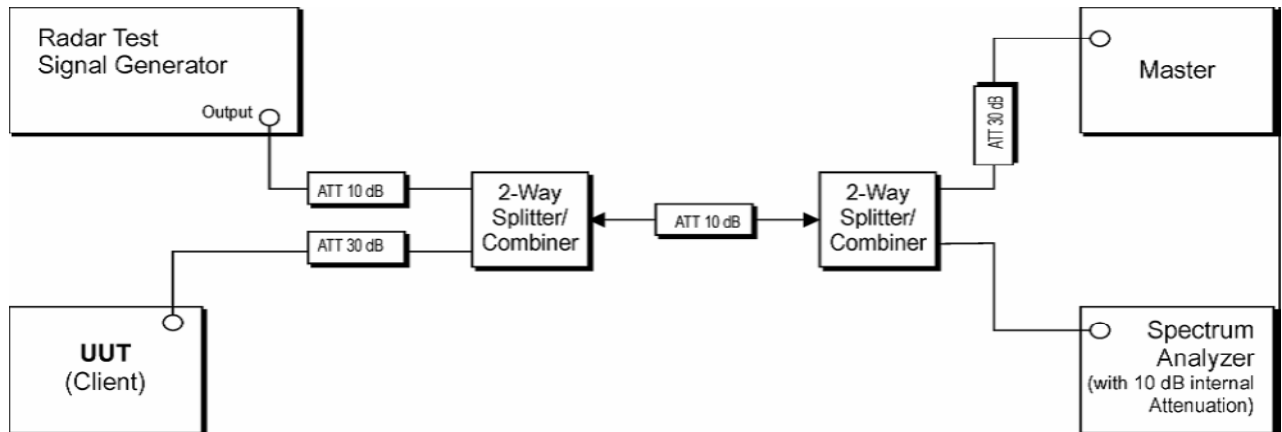

(Example Conducted Setup where UUT is a Client and Radar Test Waveforms are injected into the Master)

3. Setup for Client with injection at the Client

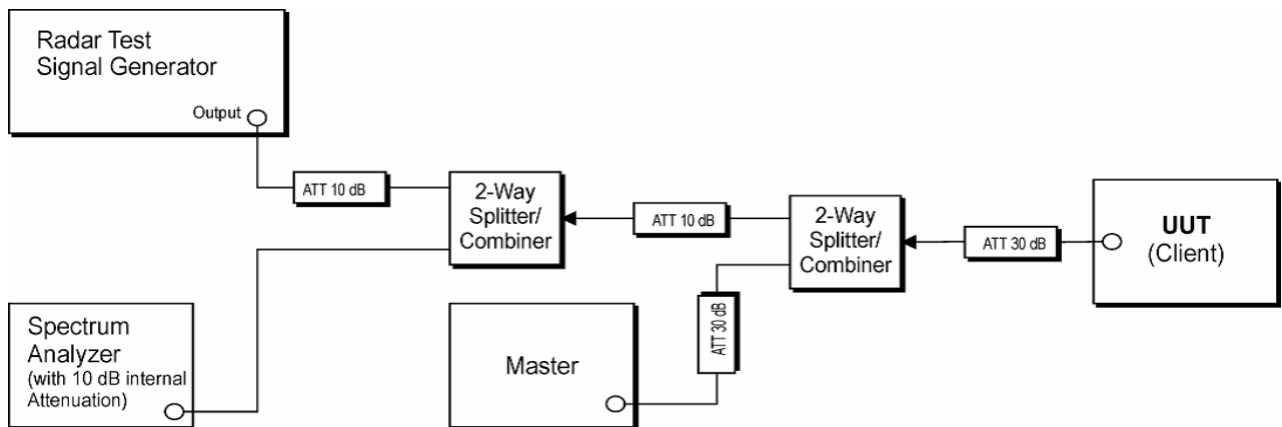

(Example Conducted Setup where UUT is a Client and Radar Test Waveforms are injected into the Client)



2.1.3. Test Result

a. Test sequence and Channel loading between Master and Client

| Test Channel | Frequency(MHz) | Payload |
|--------------|----------------|---------|
| 62 | 5310 | 40.13% |

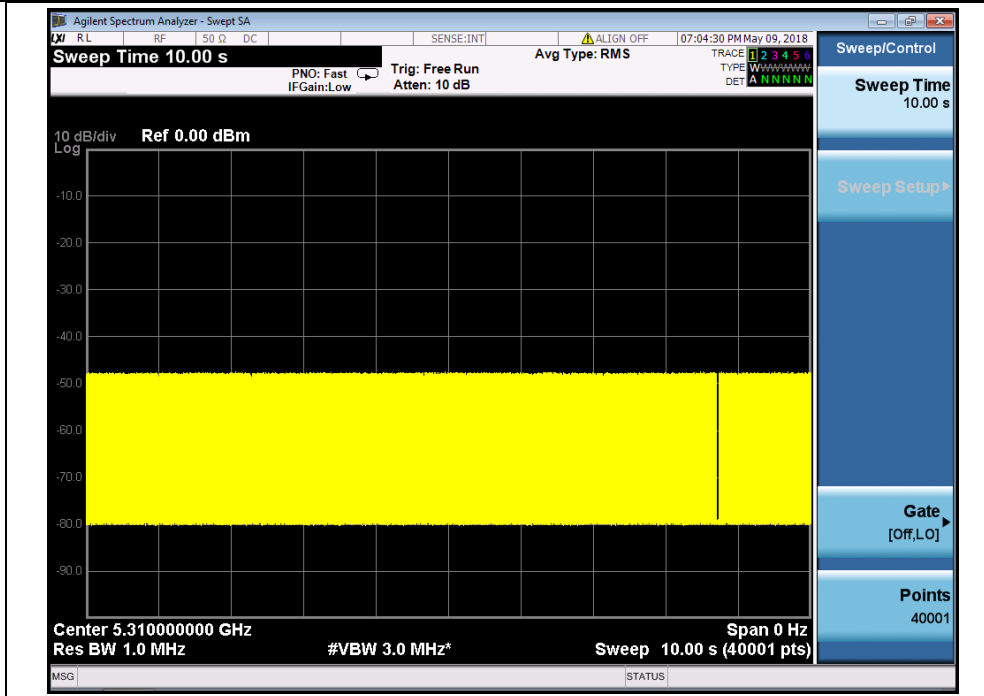

(Test sequence)

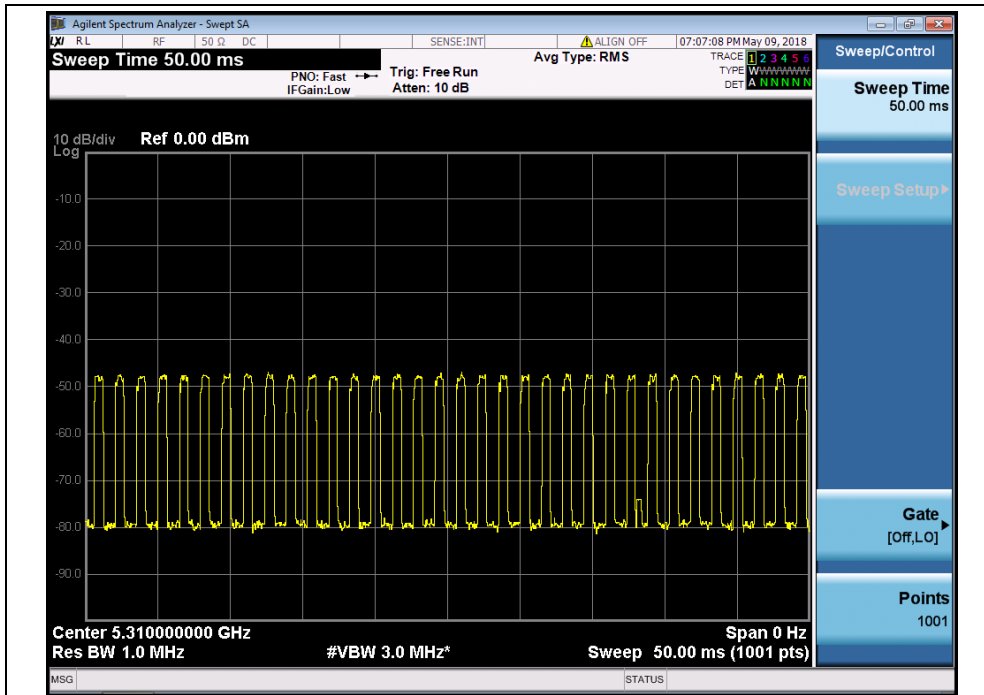

(Payload)



b. Radar Test Waveforms are injected into the Master:

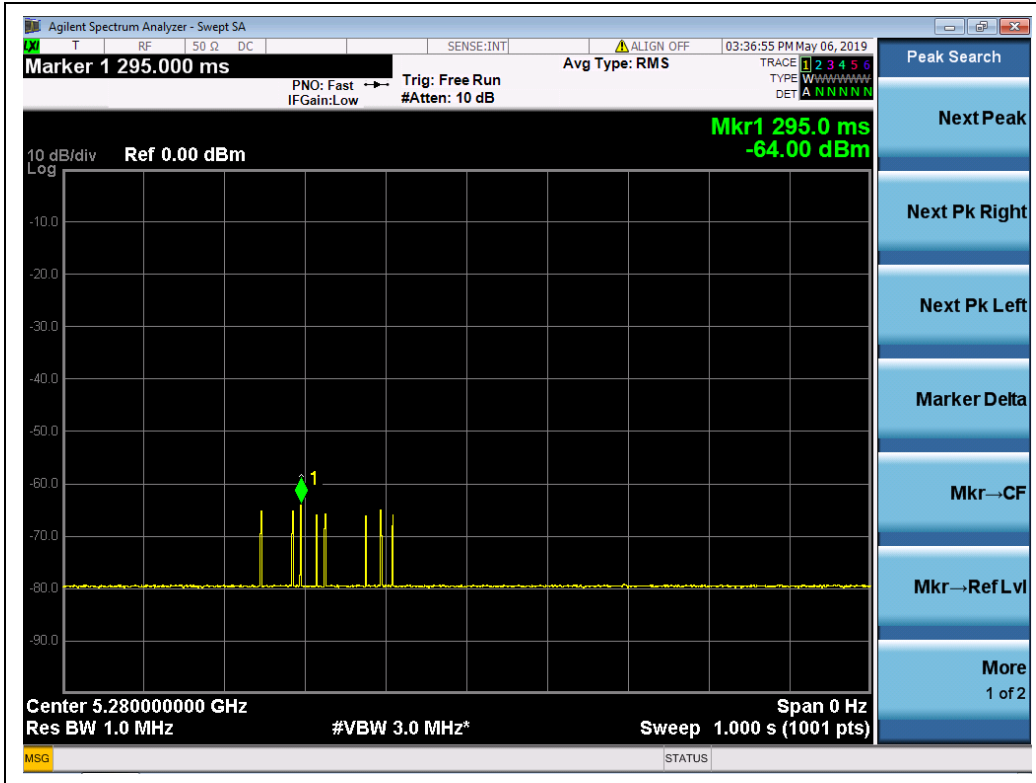

**c. EUT is a Client Device Without Radar Detection :**

| Channel & Bandwidth | Requirement | Operational Mode | Test Result | Limit | Verdict |
|--------------------------------|-----------------------------------|--------------------------------|-------------|-------|---------|
| | | Client Without Radar Detection | | | |
| 802.11 a 5240MHz | Channel Move Time | Yes | 0.634s | <10s | PASS |
| | Channel Closing Transmission Time | Yes | 0.002s | <1s | PASS |
| 802.11 a 5280MHz | Channel Move Time | Yes | 0.631s | <10s | PASS |
| | Channel Closing Transmission Time | Yes | 0.008s | <1s | PASS |
| 802.11 a 5500MHz | Channel Move Time | Yes | 0.696 s | <10s | PASS |
| | Channel Closing Transmission Time | Yes | 0.005s | <1s | PASS |
| 802.11 ac(VHT80) 5210MHz | Channel Move Time | Yes | 0.730s | <10s | PASS |
| | Channel Closing Transmission Time | Yes | 0.006s | <1s | PASS |
| 802.11 ac(VHT80) 5290MHz | Channel Move Time | Yes | 0.660s | <10s | PASS |
| | Channel Closing Transmission Time | Yes | 0.004s | <1s | PASS |
| 802.11 ac(VHT80) 5690MHz | Channel Move Time | Yes | 0.623s | <10s | PASS |
| | Channel Closing Transmission Time | Yes | 0.007s | <1s | PASS |



Test Plots

Note: T0 denotes the start time of the Radar single transmitted, T1 denotes the end time of the Radar single transmit end. T2 denotes the data transmission time of 200ms from T1. T3 denotes the end of the Channel Move Time, the time of T3 from T1 is less than 12s.

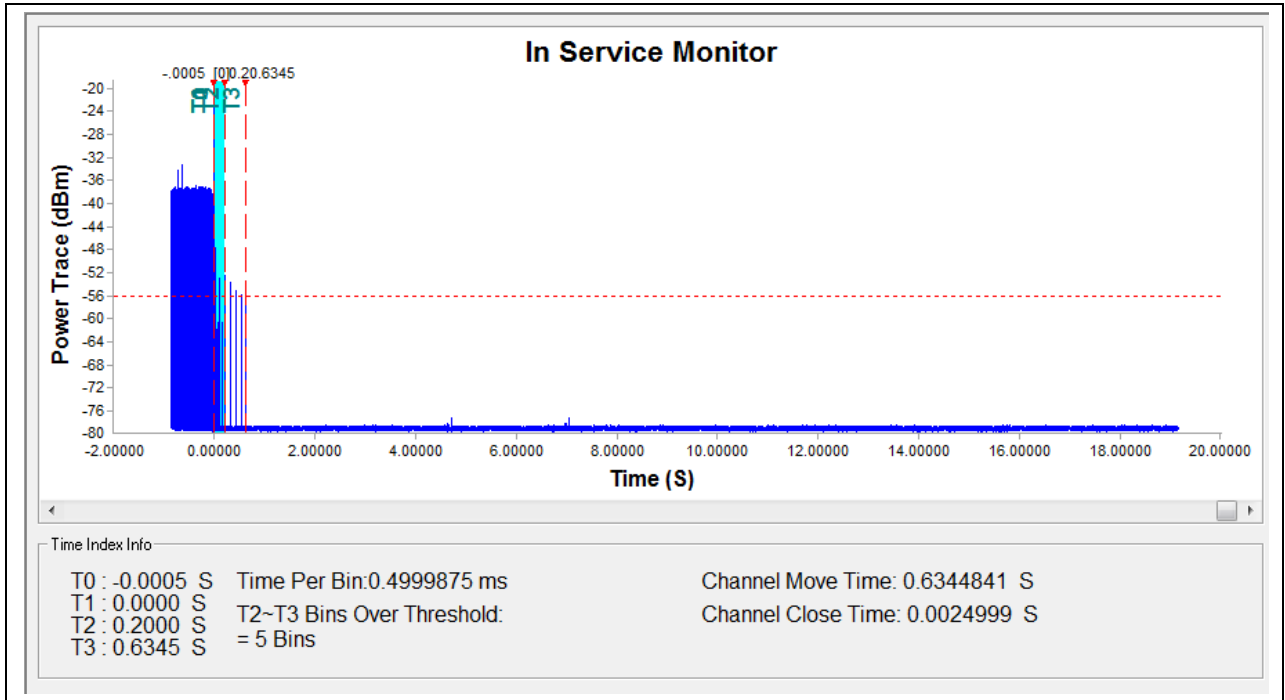

(5240MHz, 802.11a)

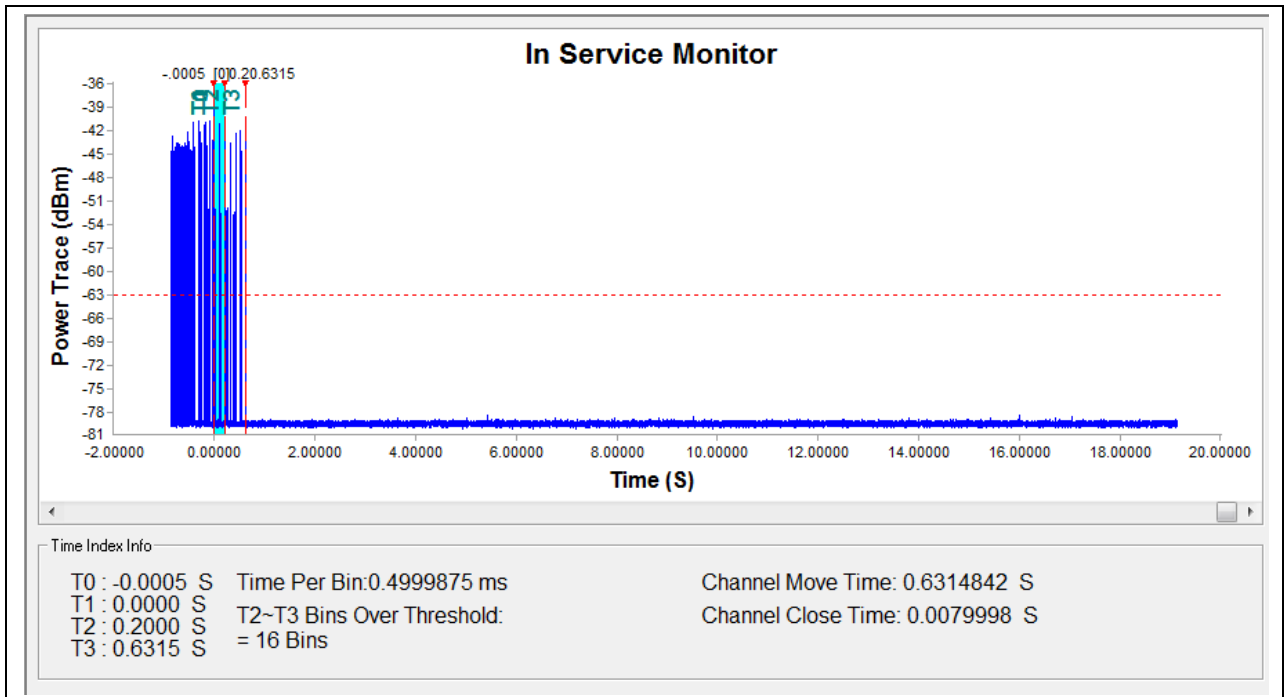

(5280MHz, 802.11a)

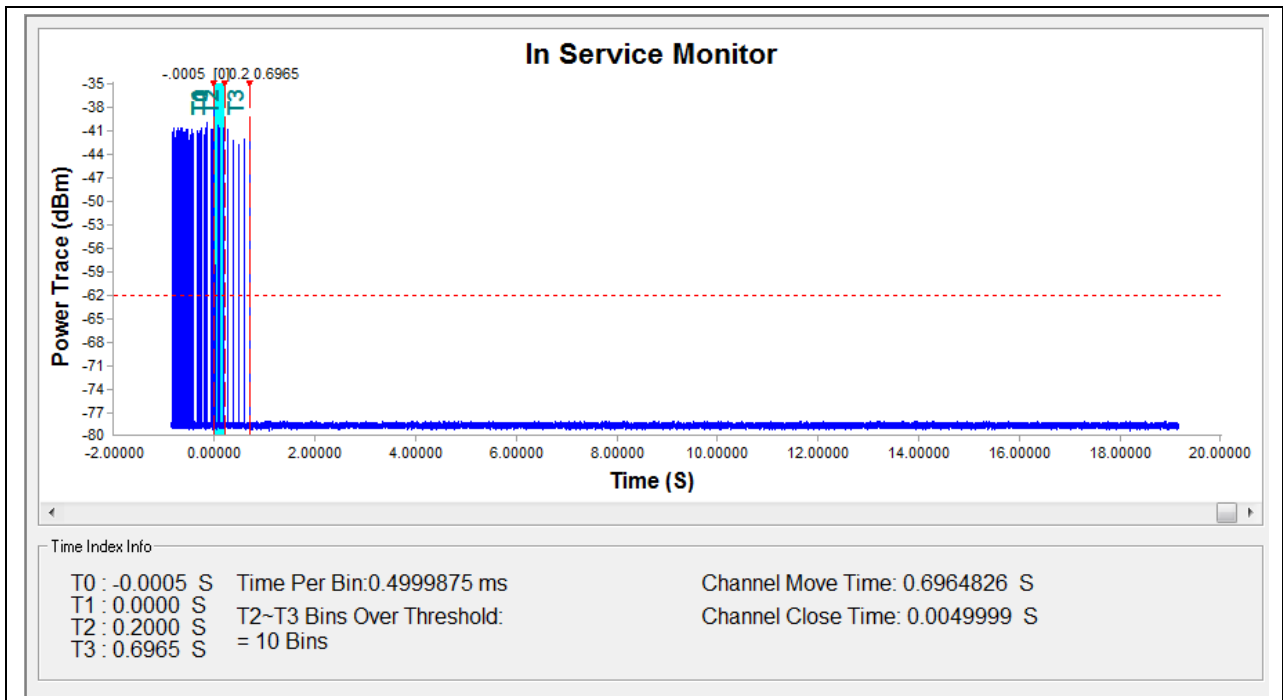

(5500MHz, 802.11a)

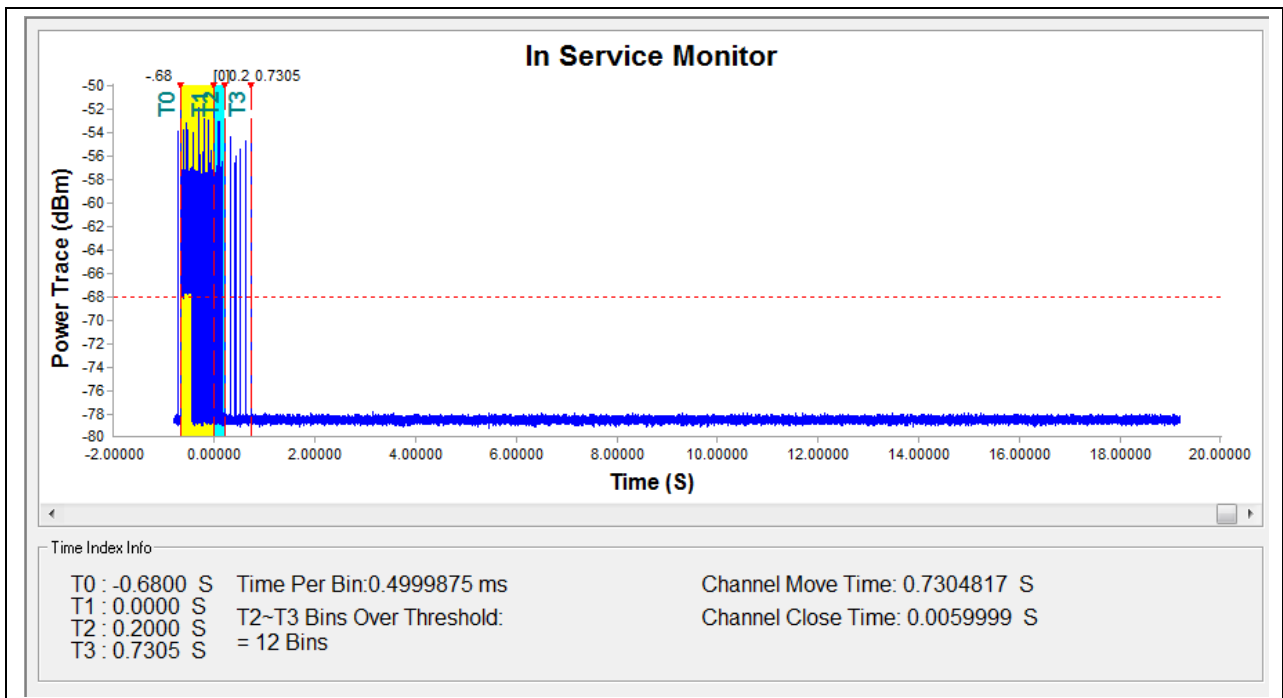

(5210MHz, 802.11ac (VHT80))

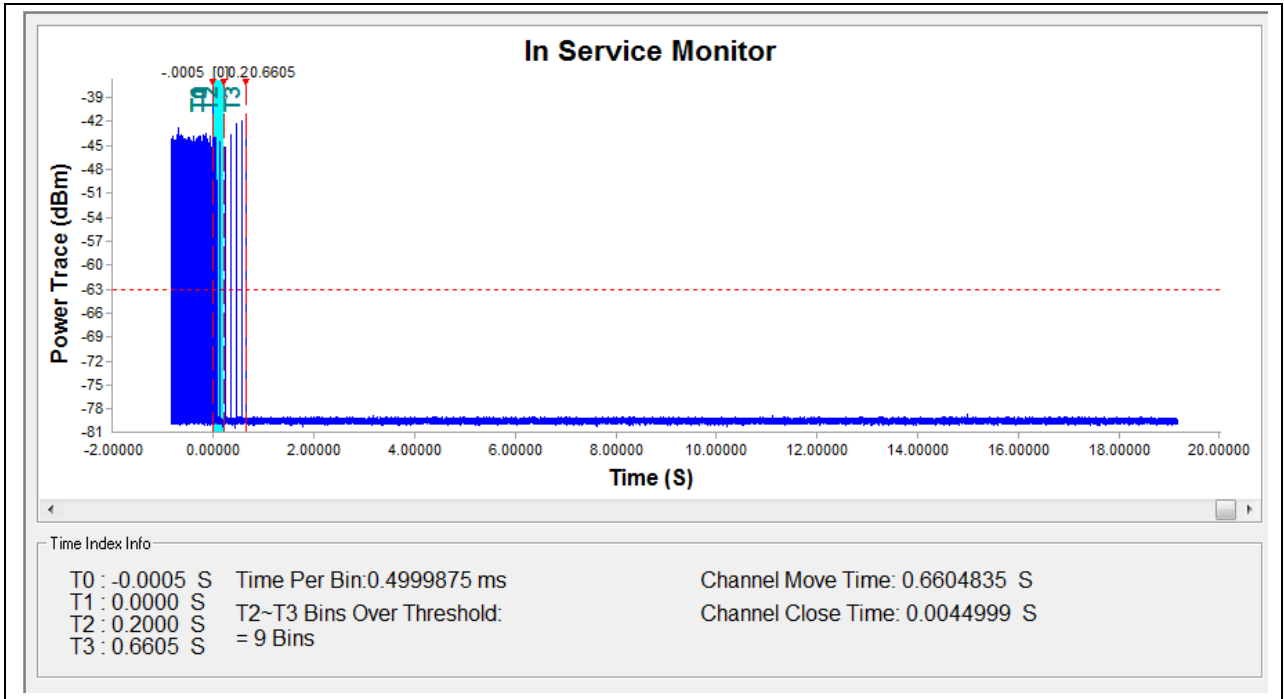

(5290MHz, 802.11ac (VHT80))

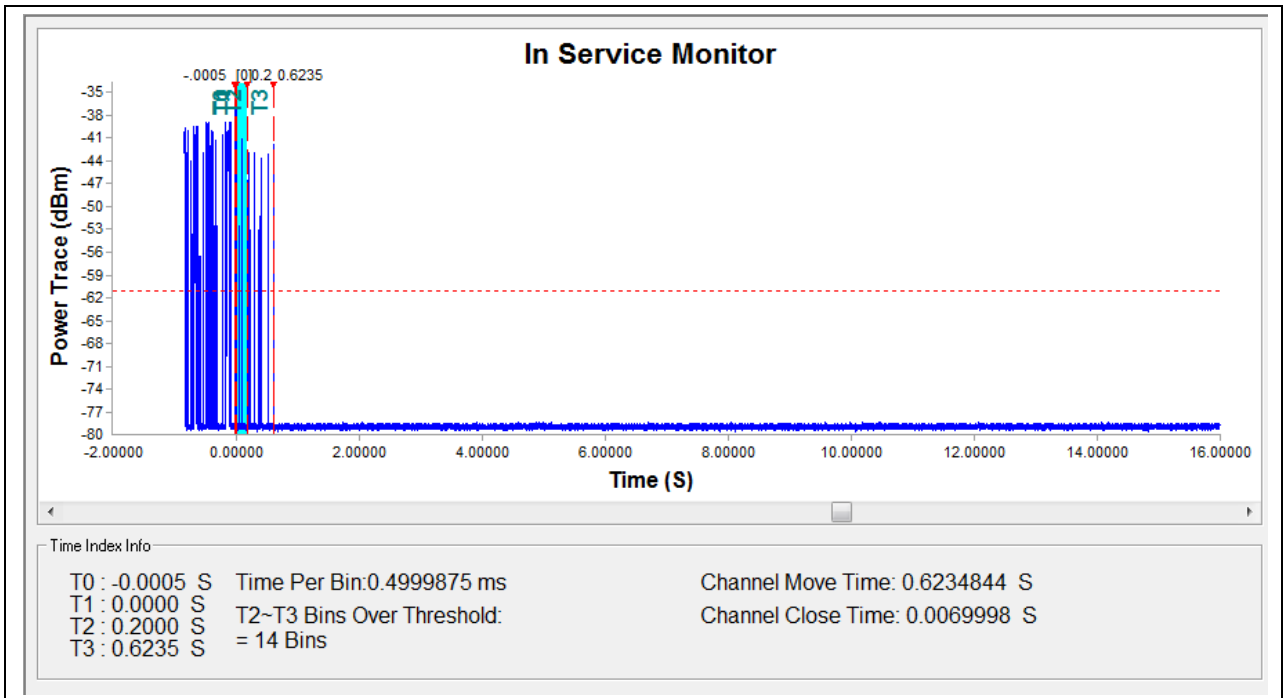

(5690MHz, 802.11ac (VHT80))



d. Time per bin

| Channel | Frequency (MHz) | Time Per Bin (ms) |
|---------|-----------------|-------------------|
| 49 | 5240 | 0.50 |
| 56 | 5280 | 0.50 |
| 100 | 5500 | 0.50 |
| 42 | 5210 | 0.50 |
| 58 | 5290 | 0.50 |
| 138 | 5690 | 0.50 |

Test Plot

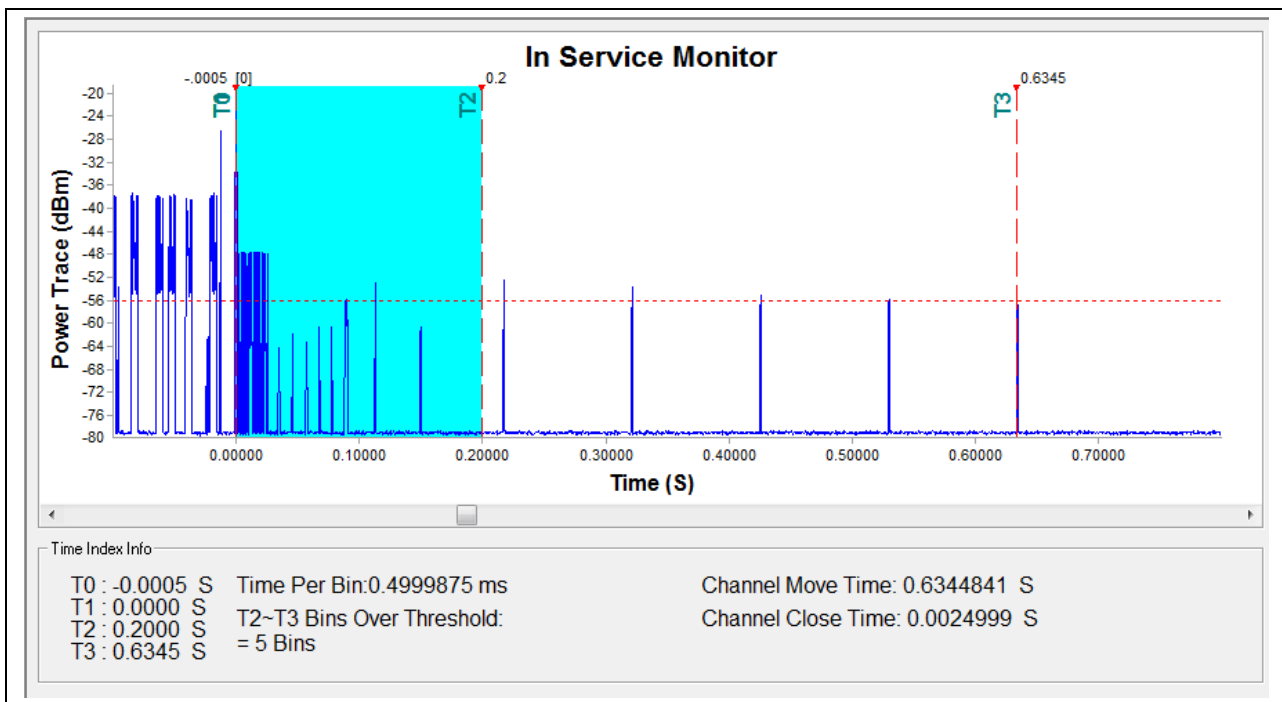

(5240MHz, 802.11a)

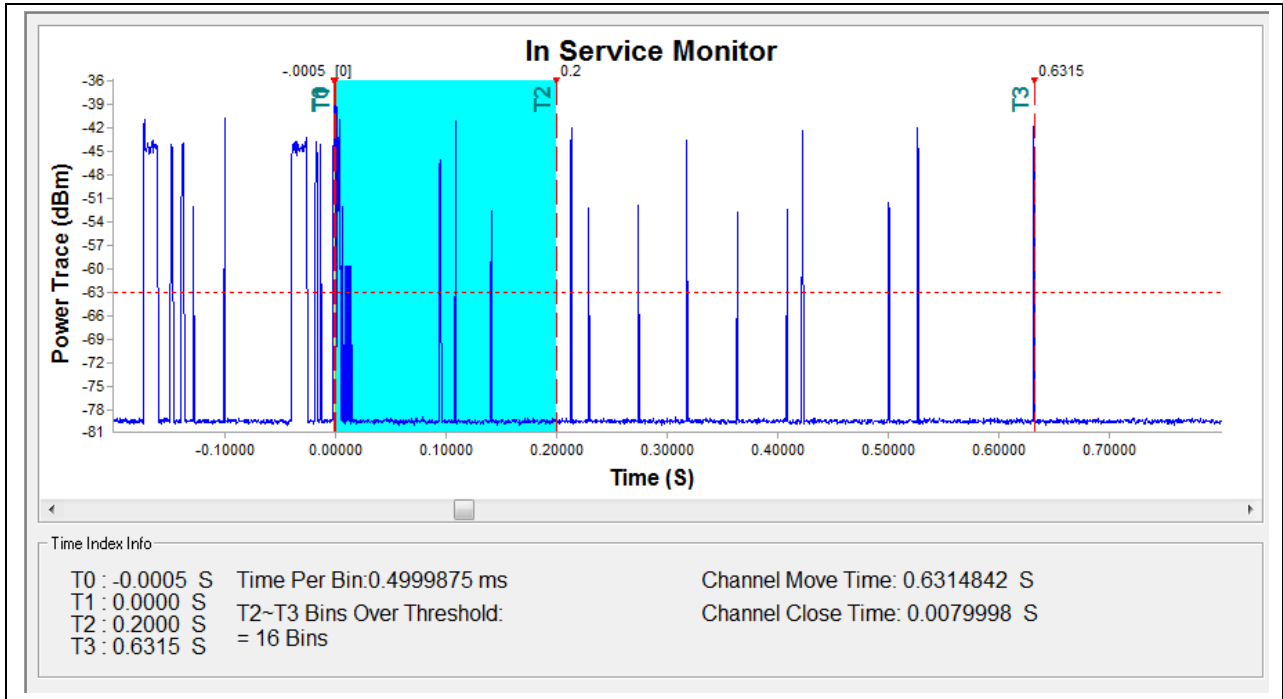

(5280MHz, 802.11a)

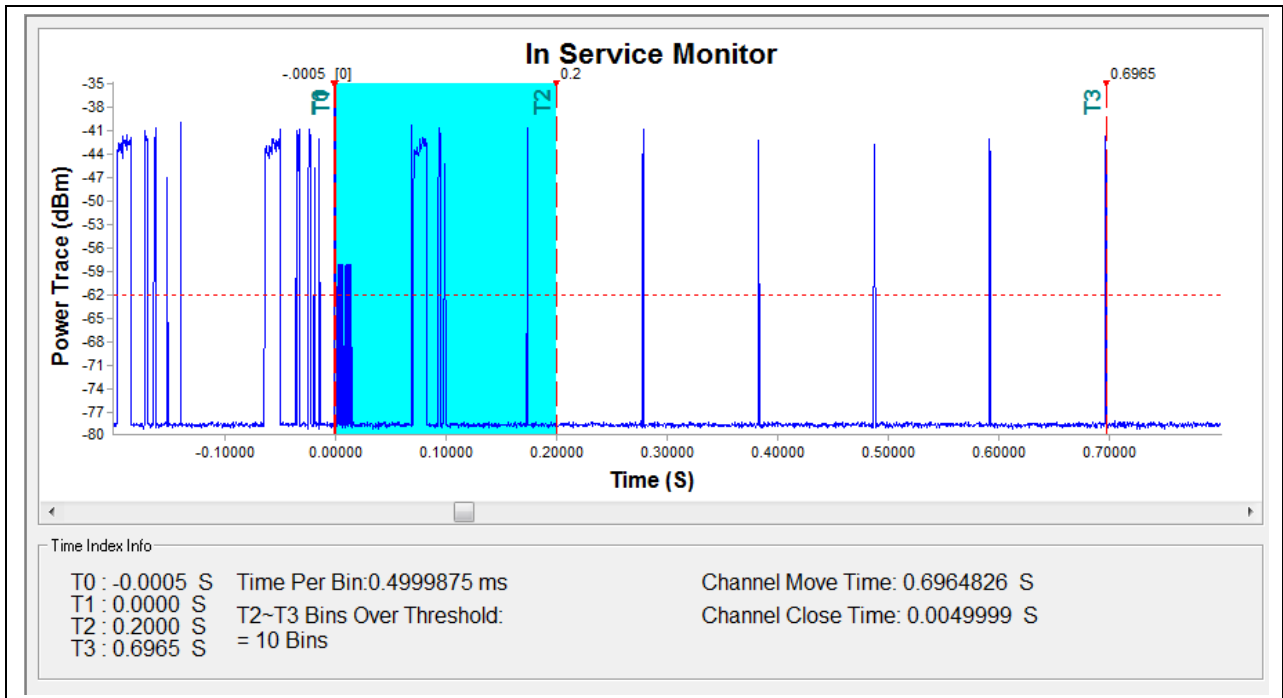

(5500MHz, 802.11a)

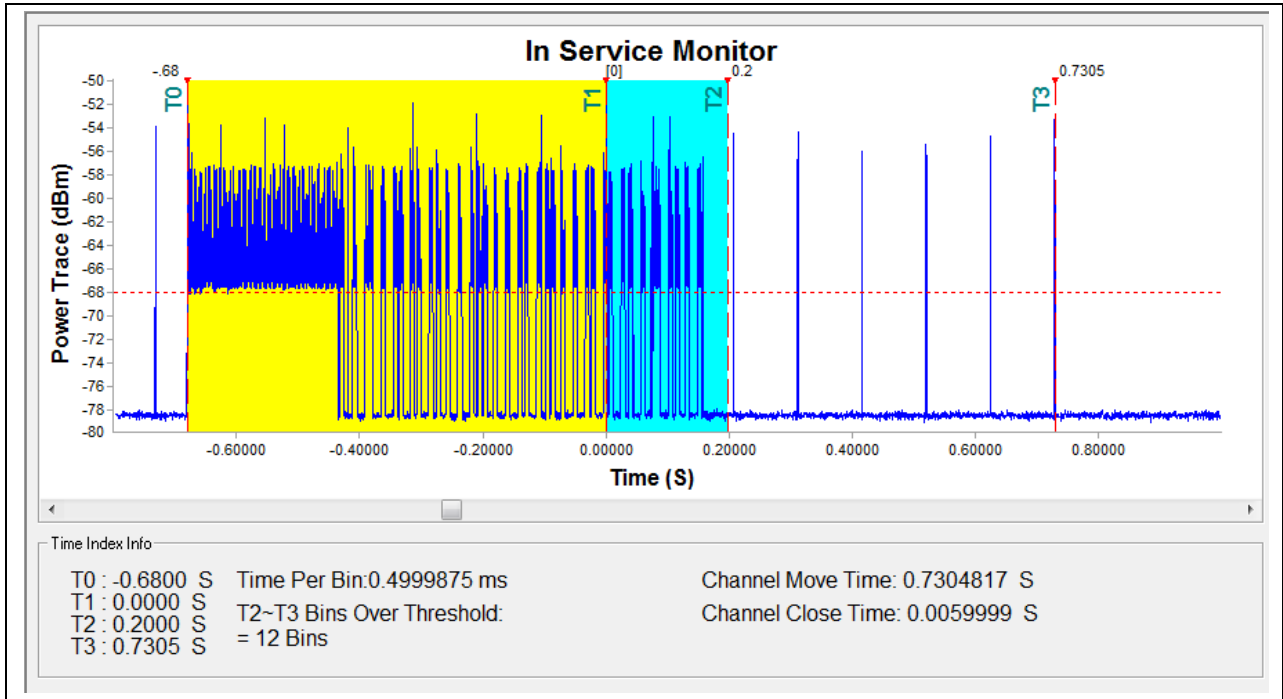

(5210MHz, 802.11ac (VHT80))

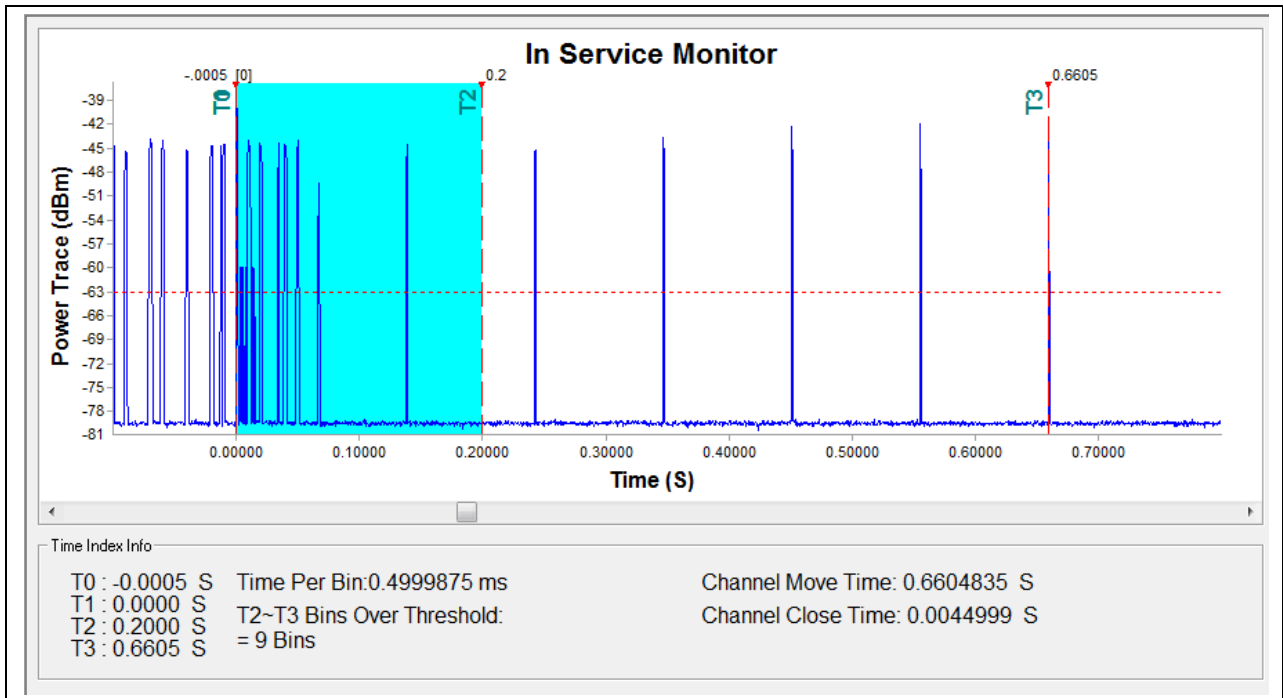

(5290MHz, 802.11ac (VHT80))

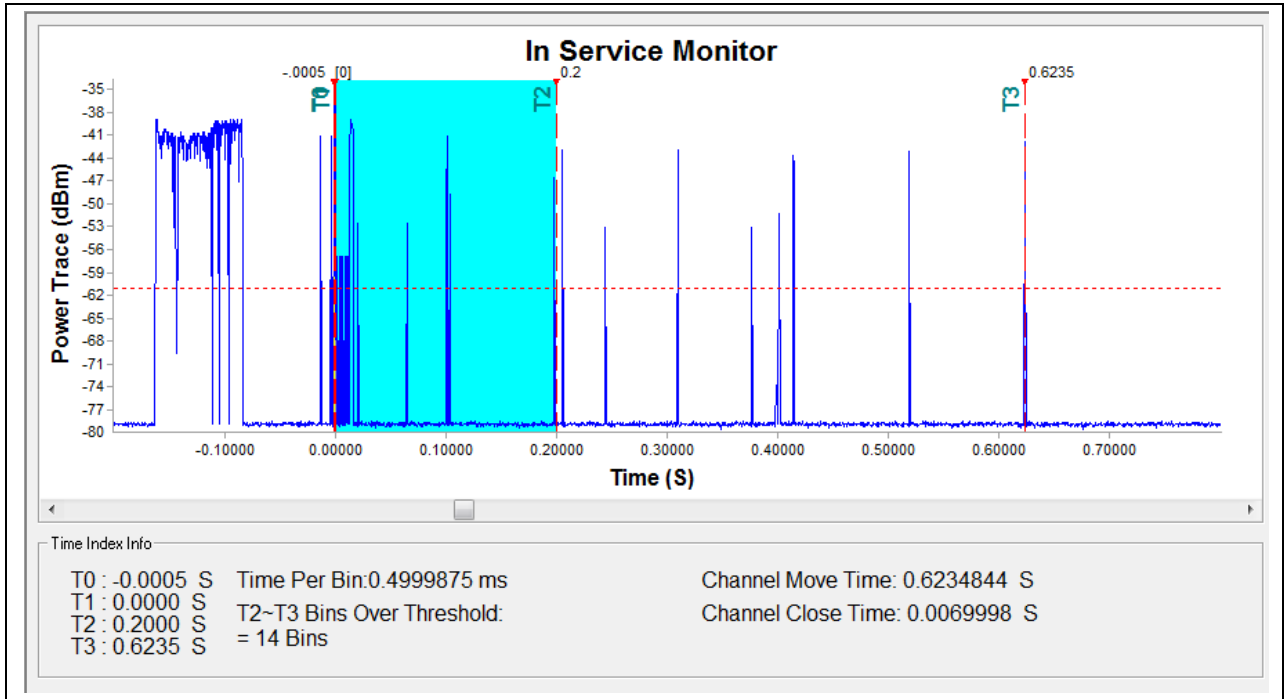

(5690MHz, 802.11ac (VHT80))



verification of Non-occupancy time

The sweep time is 2.1ks(35min) which is able to meet the requirements of Non-occupancy time.

| Channel & Bandwidth | Test Result | Limit | Verdict |
|---------------------|-------------|--------|---------|
| 802.11 a 5580MHz | 35min | ≥30min | PASS |

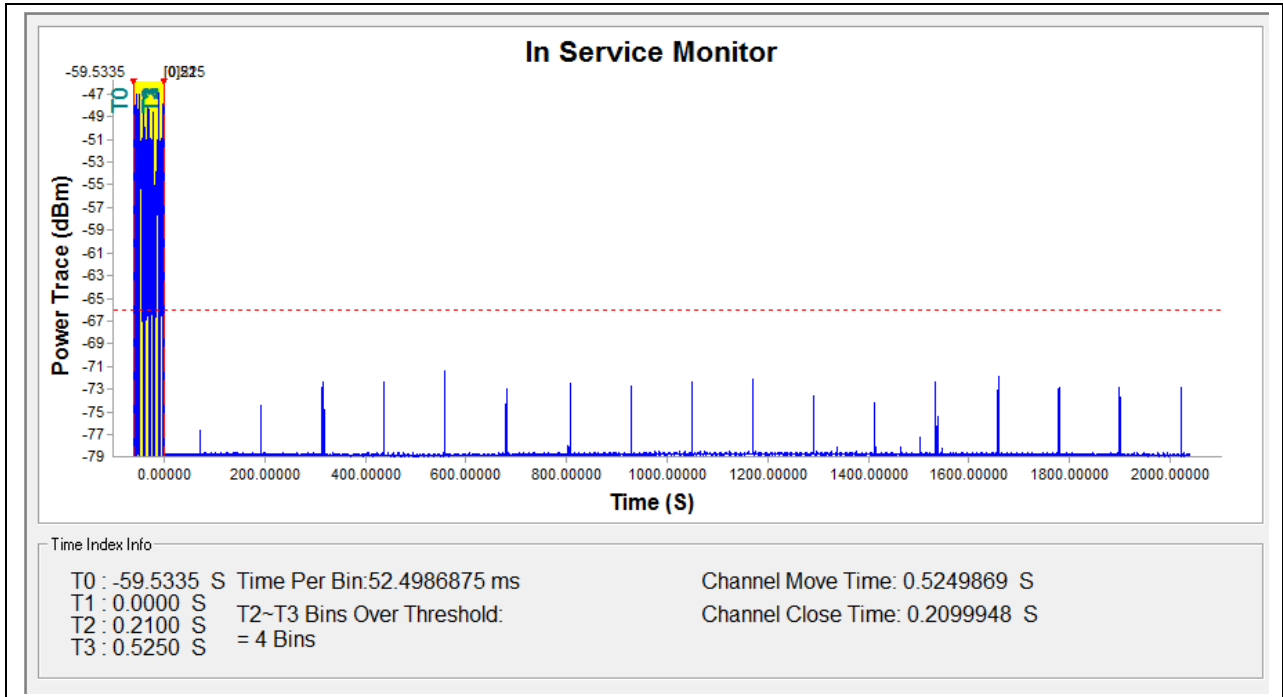

(Non-occupancy time, 5580MHz, 802.11a)

Annex A The waveform of the radar



(Type 0)

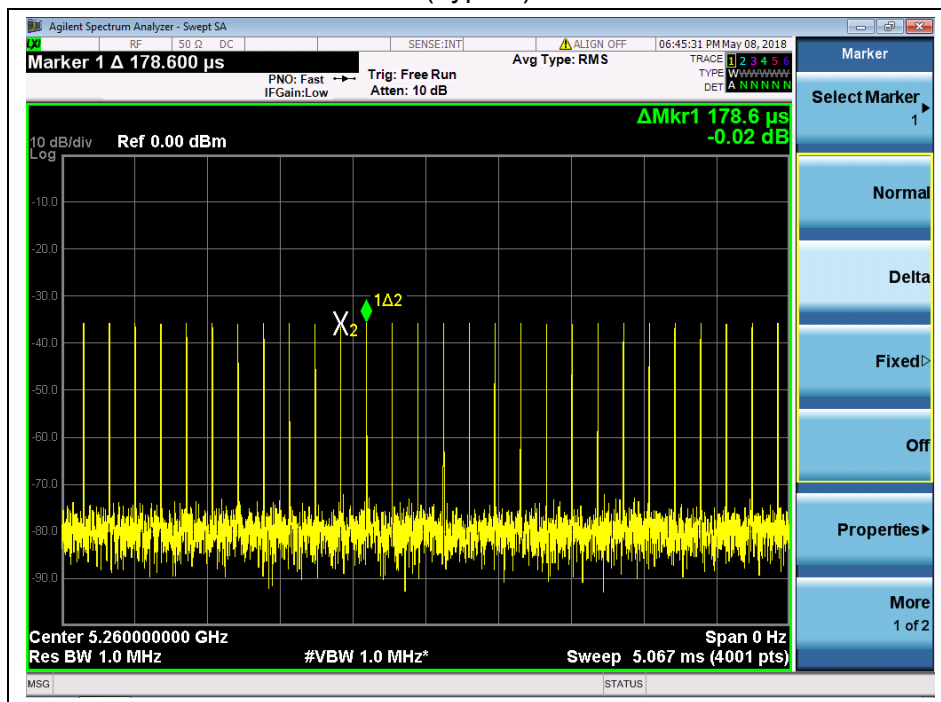

(Type 1)

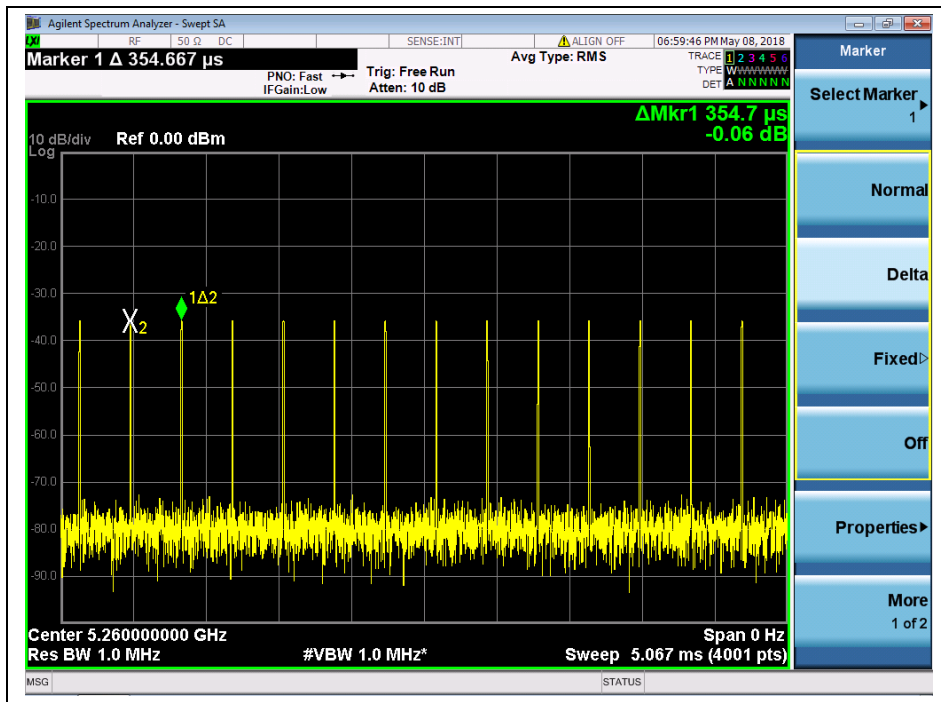

(Type 2)

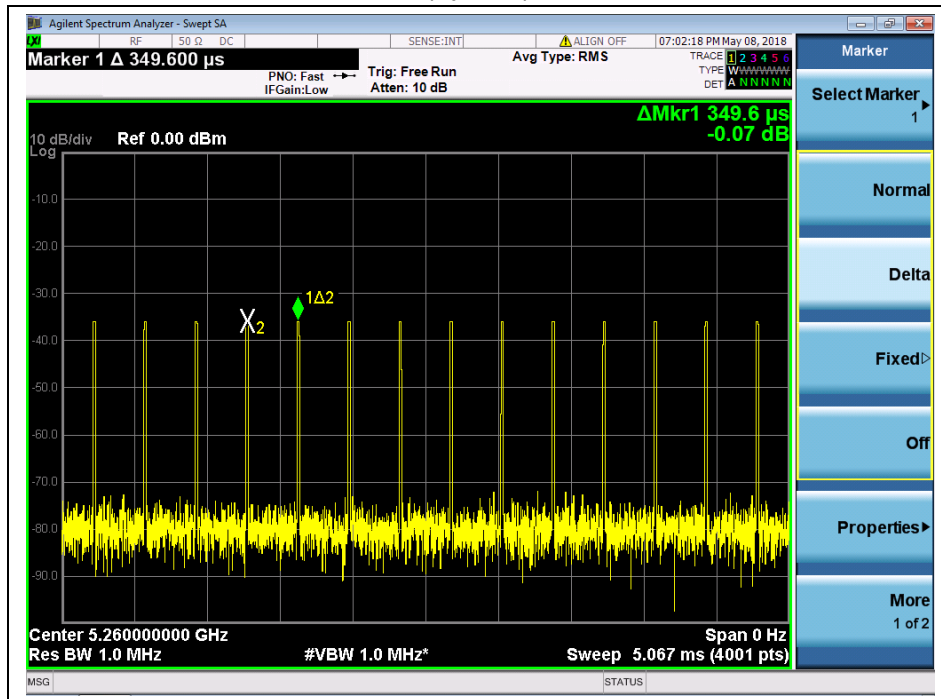

(Type 3)

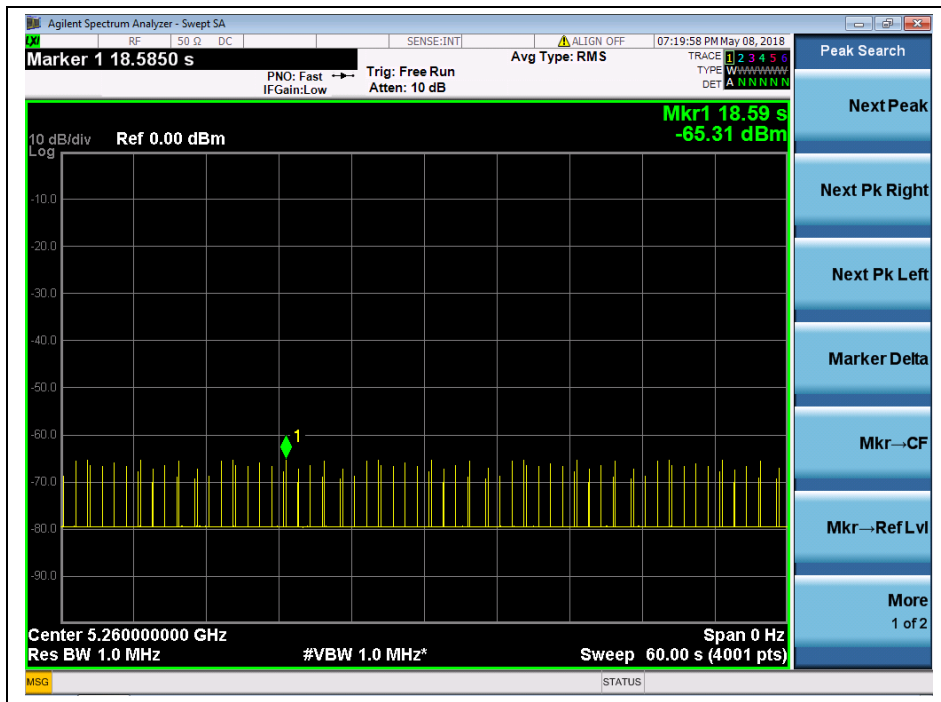

(Type 4)

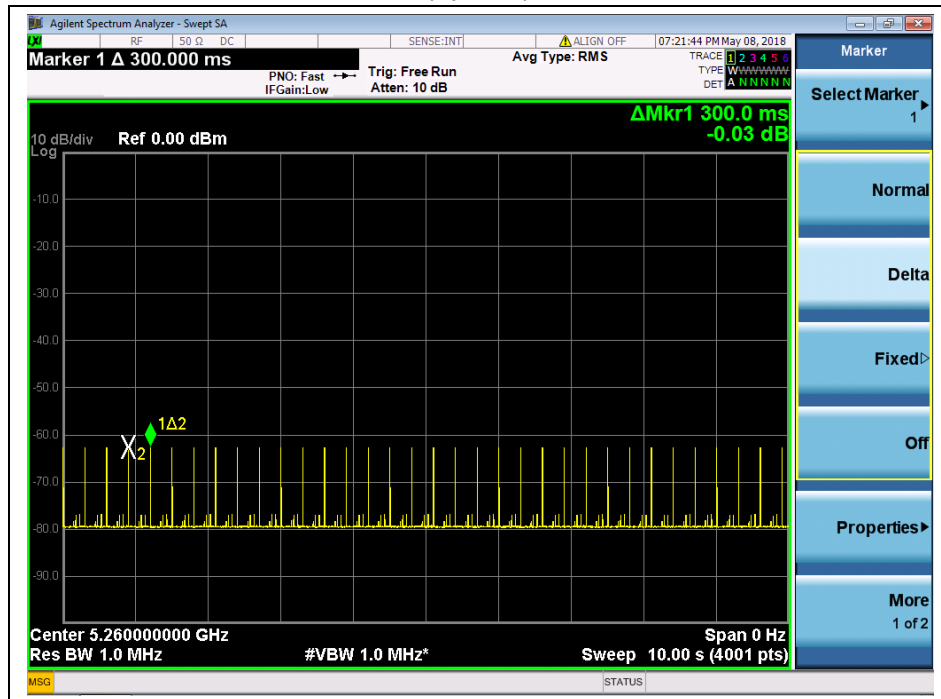

(Type 5)



Annex B Test Uncertainty

Where relevant, the following measurement uncertainty levels have been estimated for test performed on the EUT as specified in CISPR 16-1-2:

| Test items | Uncertainty |
|--------------------|-------------|
| Bandwidth | ±5% |
| Conducted Emission | ±2.44dB |

This uncertainty represent an expanded uncertainty expressed at approximately the 95% confidence level using a coverage factor of k=2



Annex C Testing Laboratory Information

1. Identification of the Responsible Testing Laboratory

| | |
|----------------------------|--|
| Laboratory Name: | Shenzhen Morlab Communications Technology Co., Ltd. Morlab Laboratory |
| Laboratory Address: | FL.3, Building A, FeiYang Science Park, No.8 LongChang Road, Block 67, BaoAn District, ShenZhen, GuangDong Province, P. R. China |
| Telephone: | +86 755 36698555 |
| Facsimile: | +86 755 36698525 |

2. Identification of the Responsible Testing Location

| | |
|-----------------|--|
| Name: | Shenzhen Morlab Communications Technology Co., Ltd. Morlab Laboratory |
| Address: | FL.3, Building A, FeiYang Science Park, No.8 LongChang Road, Block 67, BaoAn District, ShenZhen, GuangDong Province, P. R. China |

3. Facilities and Accreditations

All measurement facilities used to collect the measurement data are located at FL.3, Building A, FeiYang Science Park, Block 67, BaoAn District, Shenzhen, 518101 P. R. China. The test site is constructed in conformance with the requirements of ANSI C63.10-2013 and CISPR Publication 22; the FCC designation number is CN1192, the test firm registration number is 226174.



4. Test Equipments Utilized

4.1 Conducted Test Equipments

| Equipment Name | Serial No. | Type | Manufacturer | Cal. Date | Cal. Due |
|-----------------------------|------------|-----------|--------------|------------|------------|
| Power Splitter | NW521 | 1506A | Weinschel | 2019.04.09 | 2020.04.08 |
| Attenuator 1 | (N/A.) | 10dB | Resnet | 2019.04.09 | 2020.04.08 |
| Attenuator 2 | (N/A.) | 3dB | Resnet | 2019.04.09 | 2020.04.08 |
| EXA Signal Analyzer | MY53470836 | N9010A | Agilent | 2019.04.09 | 2020.04.08 |
| MXG Vector Signal Generator | Angilent | N5182B | MY53050961 | 2019.04.09 | 2020.04.08 |
| RF cable (30MHz-26GHz) | CB01 | RF01 | Morlab | N/A | N/A |
| Coaxial cable | CB02 | RF02 | Morlab | N/A | N/A |
| SMA connector | CN01 | RF03 | HUBER-SUHNER | N/A | N/A |
| Computer | T430i | Think Pad | Lenovo | N/A | N/A |

————— END OF REPORT —————