

EMI TEST REPORT

On Model Name: IP Phone

Model Number: GXP1450

Brand Name: Grandstream

Prepared for Grandstream Networks, INC

FCC ID Number: YZZGXP1450

According to FCC 47 CFR Part 15, Subpart B

Test Report #: SHE-1110-10704-FCC

Prepared by: Sewen Guo

Reviewed by: Jawen Yin

QC Manager: Swall Zhang

Test Report Released by:

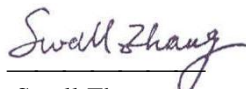
Swall Zhang

December 16, 2011

Date

Test Location

Tests performed in a Certified ANSI Semi-Anechoic Chamber and Shielded Room.

*Test Site Location : Galanz
25 South Ronggui Rd., Shunde,
Foshan, Guangdong, China*

Tel : (86)-757-23612785

Fax : (86)-757-23612537

Test Facility

The test facility was recognized, certified, or accredited by the following organizations:

- *CNAL - LAB Code: L2244
Galanz EMC Laboratory has been assessed and in compliance with CNAL/AC01:2002 accreditation criteria for testing laboratories (identical to ISO/IEC 17025:2005 General Requirements) for the Competence of Testing Laboratories.*
- *FCC - Registration No.: 580210
Galanz EMC Laboratory has been registered and fully described in a report filed with the (FCC) Federal Communications Commission. The acceptance letter from the FCC was maintained in our files.*

Table of Contents

<i>GOVERNMENT DISCLAIMER NOTICE</i>	2
<i>REPRODUCTION CLAUSE</i>	2
<i>OPINIONS AND INTERPRETATIONS</i>	2
<i>STATEMENT OF MEASUREMENT UNCERTAINTY</i>	2
<i>ADMINISTRATIVE DATA</i>	3
<i>EUT DESCRIPTION</i>	4
<i>TEST SUMMARY</i>	5
<i>TEST MODE JUSTIFICATION</i>	6
<i>EUT EXERCISE SOFTWARE</i>	6
<i>EQUIPMENT MODIFICATION</i>	6
<i>EUT SAMPLE PHOTOS</i>	7
<i>TEST SYSTEM DETAILS</i>	12
<i>ATTACHMENT 1 - CONDUCTED EMISSION TEST RESULTS</i>	17
<i>ATTACHMENT 2 - RADIATED EMISSION MEASUREMENT</i>	24

List Attached Files

<i>Exhibit Type</i>	<i>File Description</i>	<i>File Name</i>
<i>Test Report</i>	<i>Test Report</i>	<i>YZZGXP1450 _Test report.pdf</i>
<i>Operation Description</i>	<i>Technical Description</i>	<i>YZZGXP1450_operation description.pdf</i>
<i>External Photos</i>	<i>External Photos</i>	<i>YZZGXP1450_External Photos</i>
<i>Internal Photos</i>	<i>Internal Photos</i>	<i>YZZGXP1450_Internal Photos</i>
<i>Block Diagram</i>	<i>Block Diagram</i>	<i>YZZGXP1450_Block Diagram.pdf</i>
<i>Schematics</i>	<i>Circuit Diagram</i>	<i>YZZGXP1450 _Schematics.pdf</i>
<i>ID Label/Location</i>	<i>Label and Location</i>	<i>YZZGXP1450 _Label & Location.pdf</i>
<i>User Manual</i>	<i>User Manual</i>	<i>YZZGXP1450 _User Manual.pdf</i>
<i>Test setup photos</i>	<i>Test setup photos</i>	<i>YZZGXP1450 _Test Setup Photos</i>

Government Disclaimer Notice

When government drawing, specification, or other data are used for any purpose other than in connection with a definitely related government procurement operation, the United States Government thereby incurs no responsibility nor any obligation whatsoever; and the fact that the Government may have formulated, furnished, or in any way supplied the said drawing, specifications, or other data, is not to be regarded by implication or otherwise in any manner licensing the holder or any other person or corporation, or conveying any rights or permission to manufacture, use, or sell patented invention that may in any way be related thereto. This report must not be used to claim product endorsement by NVLAP or any agency of the U.S. Government.

Reproduction Clause

Any reproduction of this document must be done in full. No single part of this document may be reproduced without permission from ECMG Electronic Technical Testing Corp(Shenzhen).

Opinions and Interpretations

This test report relates to the abovementioned equipment under test (EUT). Without the permission of ECMG Electronic Technical Testing Corp(Shenzhen). Test Lab this test report is not permitted to be duplicated in extracts. This test report does not entitle to carry any test mark on this or similar products. The manufacturer has sole responsibility of continued compliance of the device.

Statement of Measurement Uncertainty

The data and results referenced in the document are true and accurate. The reader is cautioned that there may be errors within the calibration limits of the equipment and facilities that can account for a nominal measurement error. Furthermore, component and process variability of devices similar to that tested may result in additional deviation.

Administrative Data

Test Sample : *IP Phone*

Model Numbers : *GXP1450*

Model Tested : *GXP1450*

Receipt Date : *October 11, 2011*

Date Tested : *October 14, 2011 to October 26, 2011*

Applicant : *Grandstream Networks, INC*

Address : *5F, Bldg #1, No.2 Kefa Rd., Science & Technology Park, Shenzhen, China*

Telephone : *(86)-755-26014600*

Fax : *(86)-755-26014601*

Manufacturer : *Grandstream Networks, INC*

Address : *5F, Bldg #1, No.2 Kefa Rd., Science & Technology Park, Shenzhen, China*

Telephone : *(86)-755-26014600*

Fax : *(86)-755-26014601*

Factory : *Grandstream Networks, INC*

Address : *5F, Bldg #1, No.2 Kefa Rd., Science & Technology Park, Shenzhen, China*

Telephone : *(86)-755-26014600*

Fax : *(86)-755-26014601*

EUT Description

Grandstream Networks, INC., model tested GXP1450 (referred to as the EUT in this report) is an IP Phone. Technical specifications of the EUT are as below:

Parameter		Range
Basic parameters	Rated voltage	5VDC
	Rated Current	0.8A
I/O Ports	LAN Port	10/100Mbps RJ-45 port for LAN (uplink) connection. Supports PoE (802.3af).
	PC Port	10/100Mbps RJ-45 ports for PC (downlink) connection
	Power Jack	5V DC power port; UL Certified
	Headset Jack	RJ9
	Headset Jack	RJ22 headset jack and 2.5 mm earphone jack
Adapter #1	Input	100-240VAC, 50/60Hz 0.15A
	Output	5VDC, 800mA
	Model	SCF0500080A1BA
	Brand name	Mass
Adapter #2	Input	100-240VAC, 50/60Hz 0.2A
	Output	5VDC, 800mA
	Model	AK00G-0500080UW
	Brand name	All-Key(AK)
Adapter #3	Input	100-240VAC 50/60Hz 0.2A
	Output	5VDC, 800mA
	Model	SWN006S050080U1
	Brand name	Swtec

NOTE: For more detailed informations or features please refer to user's manual of EUT.

Test Summary

The Electromagnetic Compatibility requirements on model GXP1450 for this test are stated below. All results listed in this report relate exclusively to this above-mentioned model as the Equipment under Test. This report confers no approval or endorsement upon any other component, host or subsystem used in the test set-up.

Emission Tests				
Specifications	Description	Test Results	Test Point	Remark
<i>FCC Part 15.107 ANSI C63.4 -2003</i>	<i>Conducted Emission</i>	<i>Passed</i>	<i>AC Input Port</i>	<i>Attachment 1</i>
<i>FCC Part 15.109 ANSI C63.4 -2003</i>	<i>Radiated Emission</i>	<i>Passed</i>	<i>Enclosure</i>	<i>Attachment 2</i>

Test Mode Justification

Pre-scan has been conducted to determine the worst-case modes from all possible combinations between available operational modes. The following modes were chosen for final test as described below.

IP Call mode:

Connected the EUT's LAN port to another an IP Phone by a RJ-45 cable and established a call communication between them. Then connected a notebook PC to the EUT's PC port by another a RJ-45 cable and ping "192.168.0.166 -t" to EUT and measured it.

PoE Mode:

Removed AC/DC adaptor of the EUT, Let the EUT operated in PoE mode and measured it.

EUT Exercise Software

No test software support this test.

Equipment Modification

Any modifications installed previous to testing by Grandstream Networks, INC. will be incorporated in each production model sold or leased in United States.

There were no modifications installed by ECMG Electronic Technical Testing Corp(Shenzhen). test personnel.

EUT Sample Photos

EUT Model: GXP1450



EUT- Front View



EUT- Rear View



RJ-45 Cable View



Support View



Adaptor #1 View(Manufacturer: Mass Power)



Adaptor #2 View(Manufacturer: All-Key(AK))



Adaptor #3 View(Manufacturer: Swtec)

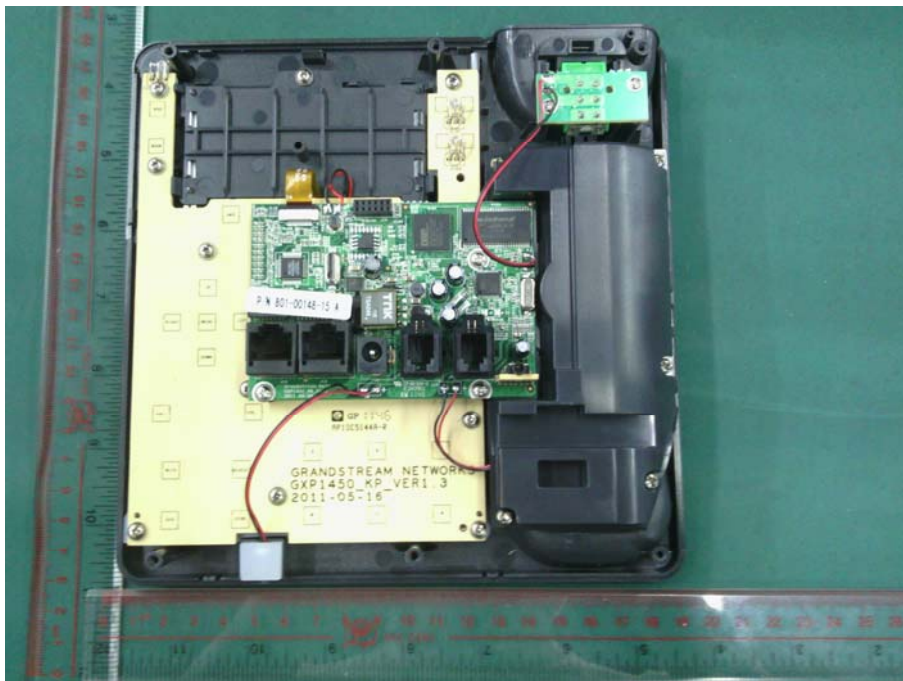

Uncovered View



Mainboard Top View



Mainboard Bottom View

Test System Details

<i>EUT</i>			
Model Number:	<i>GXP1450</i>		
Model Tested:	<i>GXP1450</i>		
Description:	<i>IP Phone</i>		
Input:	<i>AC 120V/60Hz</i>		
Manufacturer:	<i>Grandstream Networks, INC</i>		
<i>Support Equipment</i>			
<i>Description</i>	<i>Model Number</i>	<i>Serial Number</i>	<i>Manufacturer</i>
<i>Notebook PC</i>	<i>NC4000</i>	<i>CNU4122BCL</i>	<i>HP</i>
<i>Adapter Of Notebook PC</i>	<i>PPP009H</i>	<i>239427-003</i>	<i>HP</i>
<i>Mouse</i>	<i>MO32B0</i>	<i>23-033131</i>	<i>HP</i>
<i>Keyboard</i>	<i>SK-1788</i>	<i>N/A</i>	<i>LENOVO</i>
<i>Monitor</i>	<i>177V+</i>	<i>N/A</i>	<i>AOC</i>

Cable Description					
Description	From	To	Length (Meters)	Shielded (Y/N)	Ferrite (Y/N)
<i>Adapter Cord Of Notebook</i>	<i>AC Adapter</i>	<i>Notebook PC</i>	<i>1.6</i>	<i>N</i>	<i>Y</i>
	<i>AC Adapter</i>	<i>Plug</i>	<i>1.2</i>	<i>N</i>	<i>Y</i>
<i>Mouse cord</i>	<i>Mouse</i>	<i>Plug</i>	<i>1.2</i>	<i>N</i>	<i>Y</i>
<i>Keyboard cord</i>	<i>keyboard</i>	<i>Plug</i>	<i>1.2</i>	<i>N</i>	<i>Y</i>
<i>VGA cord</i>	<i>Notebook PC</i>	<i>Monitor</i>	<i>1.2</i>	<i>Y</i>	<i>Y</i>
<i>RJ-45 Cord #1</i>	<i>EUT</i>	<i>Notebook PC</i>	<i>1.5</i>	<i>N</i>	<i>N</i>
<i>RJ-45 Cord #2</i>	<i>EUT</i>	<i>Other IP Phone</i>	<i>>3.0</i>	<i>N</i>	<i>Y</i>
<i>Adapter cord of EUT</i>	<i>EUT</i>	<i>Plug</i>	<i>1.8</i>	<i>N</i>	<i>N</i>
<i>Note: The "EUT" means "IP Phone".</i>					

NOTE: The EUT has been tested as an independent unit together with other necessary accessories or support units. The above support units or accessories were used to form a representative test configuration during the test tests.

Configuration of Tested System

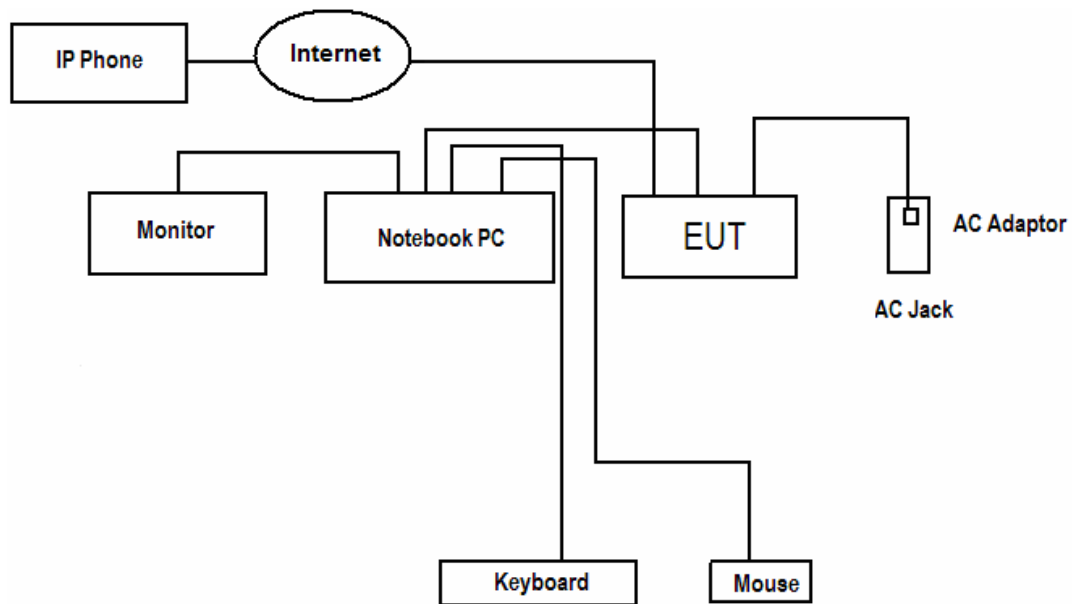

Note : The same system configuration shall still apply to PoE mode when removed AC Adaptor of EUT.

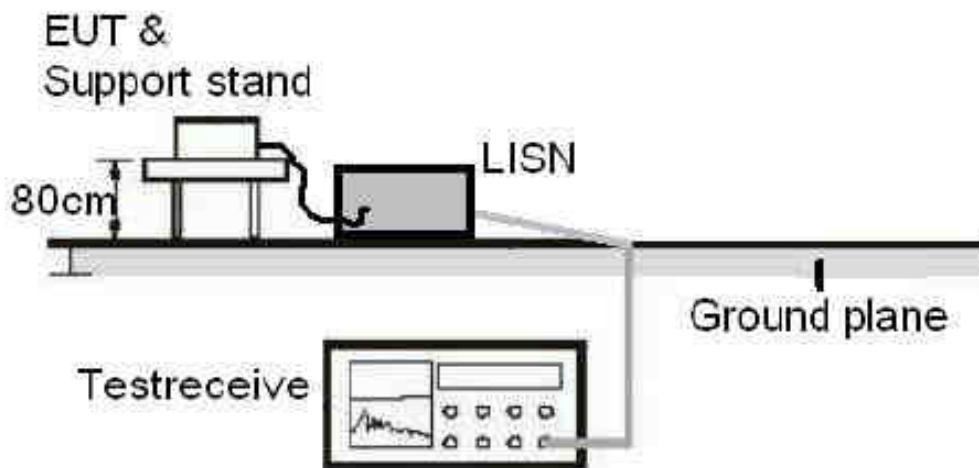

Conducted Emission Test Set-up Photograph

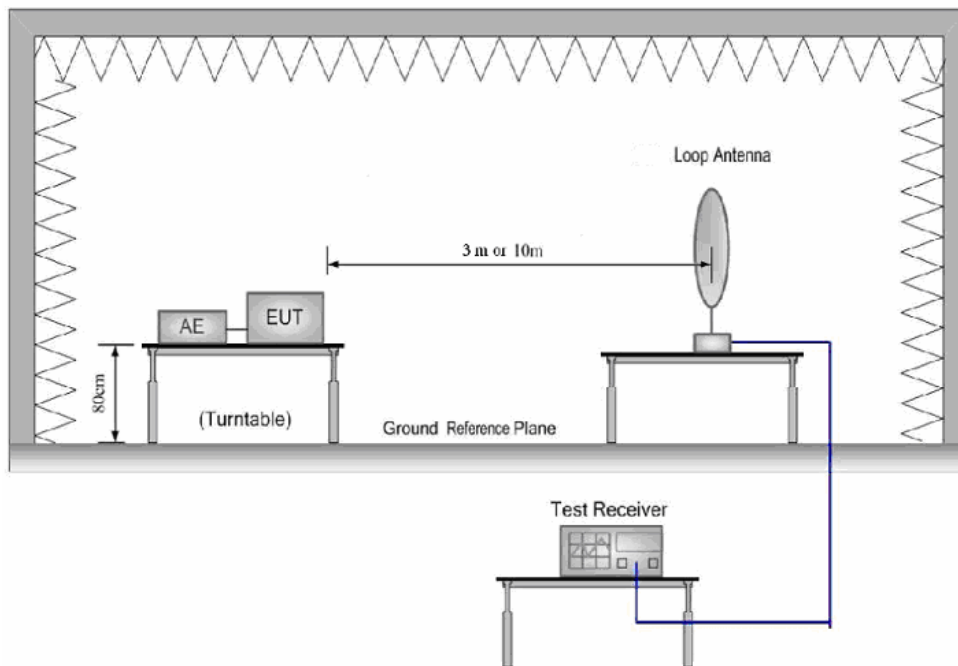

Radiated Emission Test Set-up Photograph(9KHz to 30MHz)

Figure 1 : Frequencies measured below 1 GHz configuration

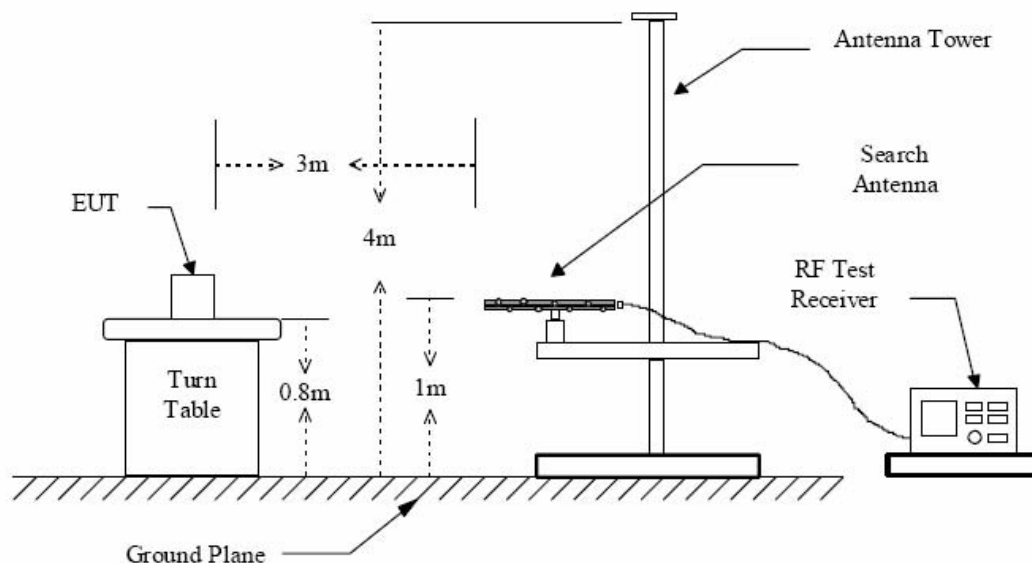
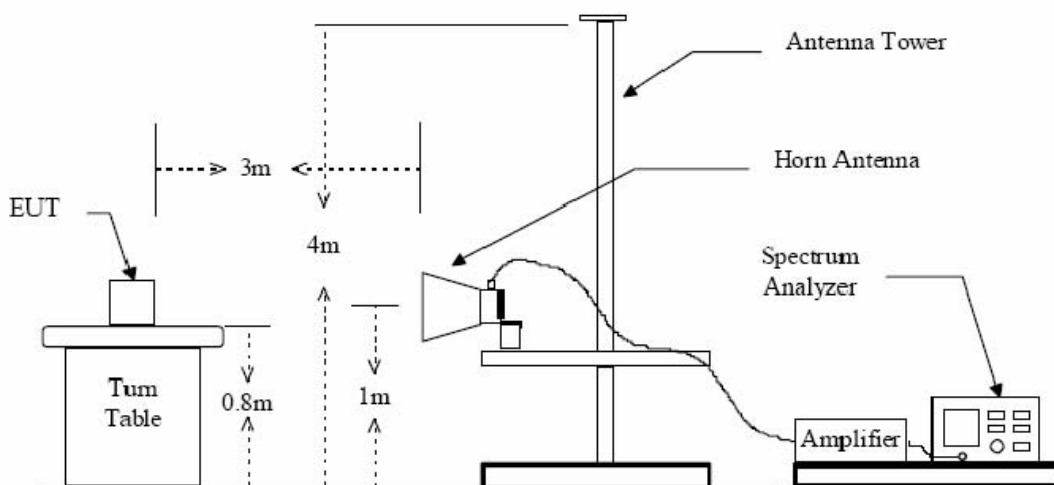

Figure 2 : Frequencies measured above 1 GHz configuration



ATTACHMENT 1 - CONDUCTED EMISSION TEST RESULTS

CLIENT:	Grandstream Networks, INC	TEST STANDERD:	FCC Part 15, Subpart B, Section 15.107
MODEL NUMBERS:	GXP1450	PRODUCT:	IP Phone
MODEL TESTED:	GXP1450	EUT DESIGNATION:	Home or Office
TEMPERATURE:	23°C	HUMIDITY:	51%
ATM PRESSURE:	103kPa	GROUNDING:	None
TESTED BY:	Sewen Guo	DATE OF TEST:	August 9, 2011
TEST REFERENCE:	ANSI C63.4- 2003		
TEST PROCEDURE:	The EUT was set up according to the guidelines of ANSI C63.4- 2003 for conducted emissions. The measurement was using a AMN on each line and an EMI receiver peak scan was made at the frequency measurement range. The six highest significant peaks were then marked, and these signals were then quasi-peaked and averaged. The frequency range investigated was from 150KHz to 30MHz.		
DESCRIPTION OF TEST MODE	Refer to test mode justification.		
TESTED RANGE:	150kHz to 30MHz		
TEST VOLTAGE:	AC 120V/60Hz		
RESULTS:	The EUT meets the requirements of test reference for Conducted Emissions. The test results relate only to the equipment under test provided by client.		
Changes or Modifications:	There were no modifications installed by ECMG Electronic Technical Testing Corp(Shenzhen). test personnel.		
M. UNCERTAINTY:	Freq. $\pm 2 \times 10^{-7}$ x Center Freq., Amp ± 2.6 dB		

**For IP Call Mode:
Adaptor #1: (Mass)**

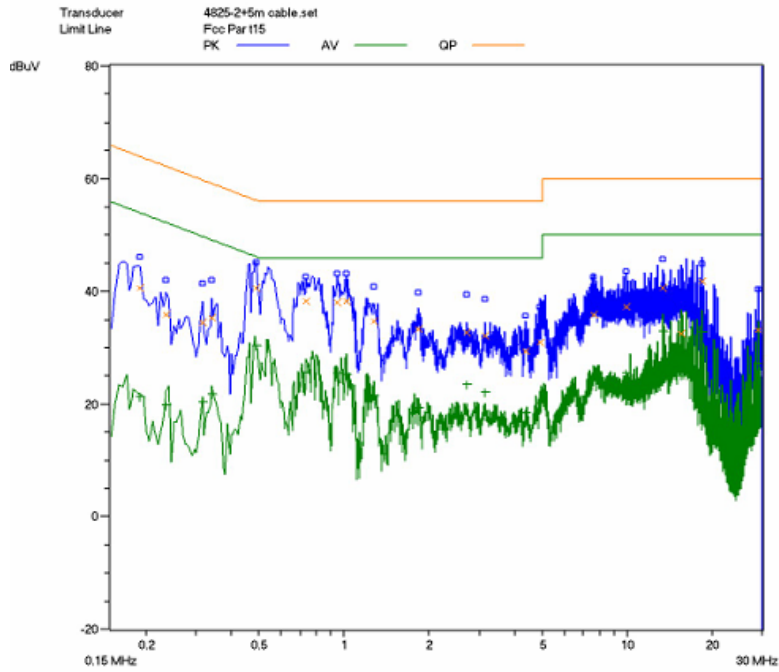

Line L Conducted Emission Graph -IP Call

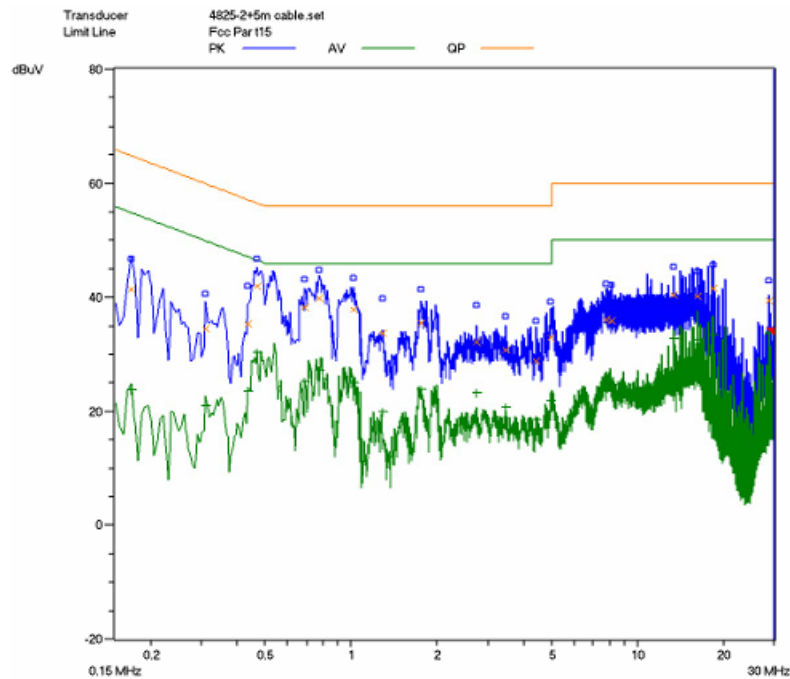

Line N Conducted Emission Graph -IP Call

Adaptor #2: (AK)

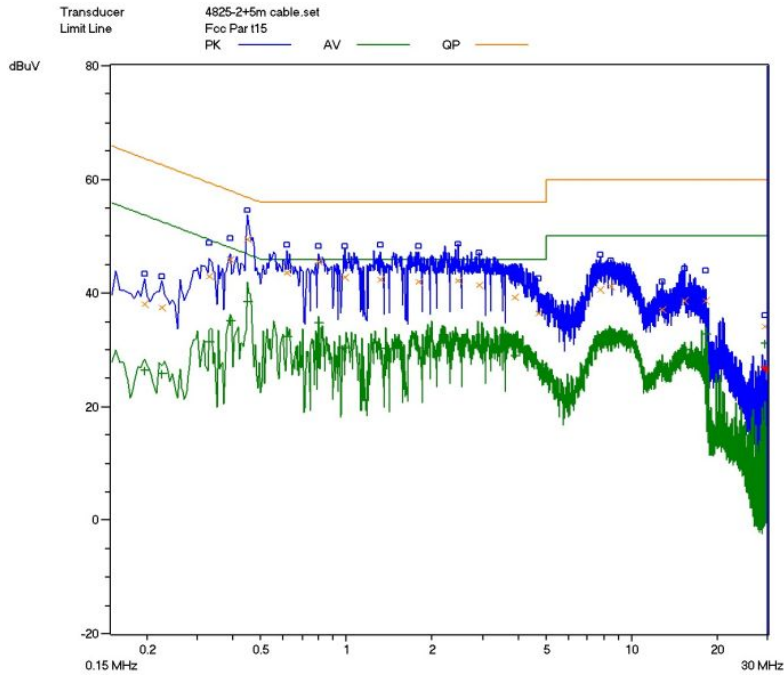

Line L Conducted Emission Graph -IP Call

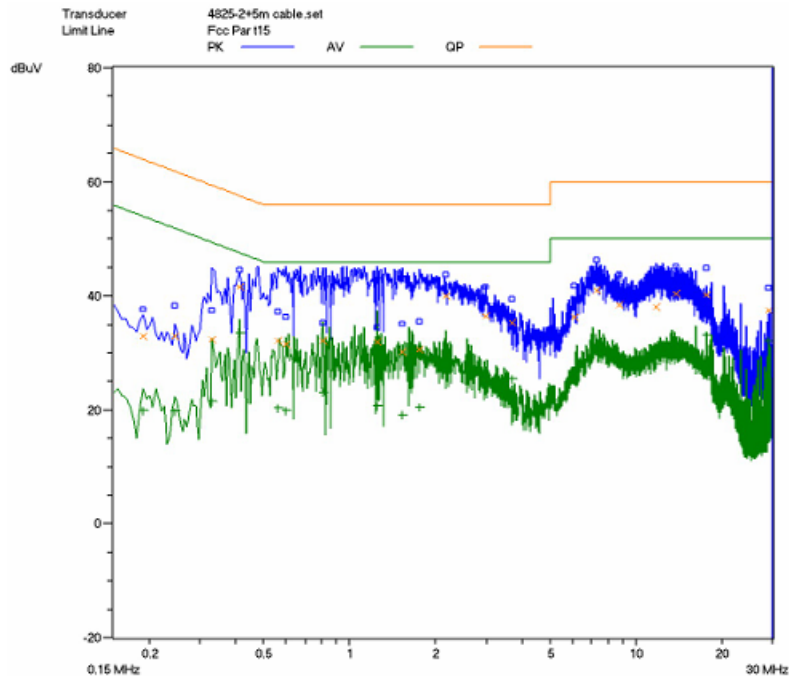

Line N Conducted Emission Graph -IP Call

Adaptor #3: (Swtec)

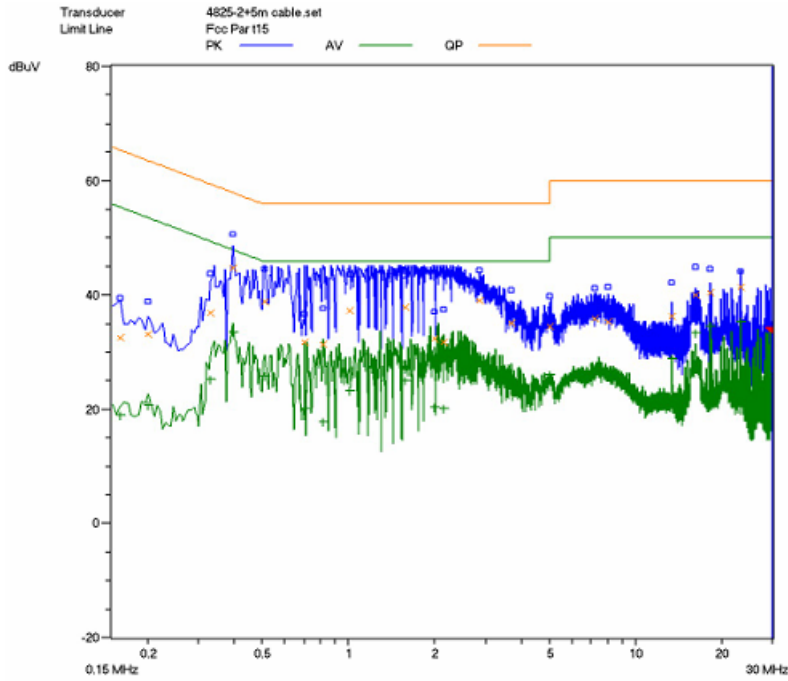

Line L Conducted Emission Graph -IP Call

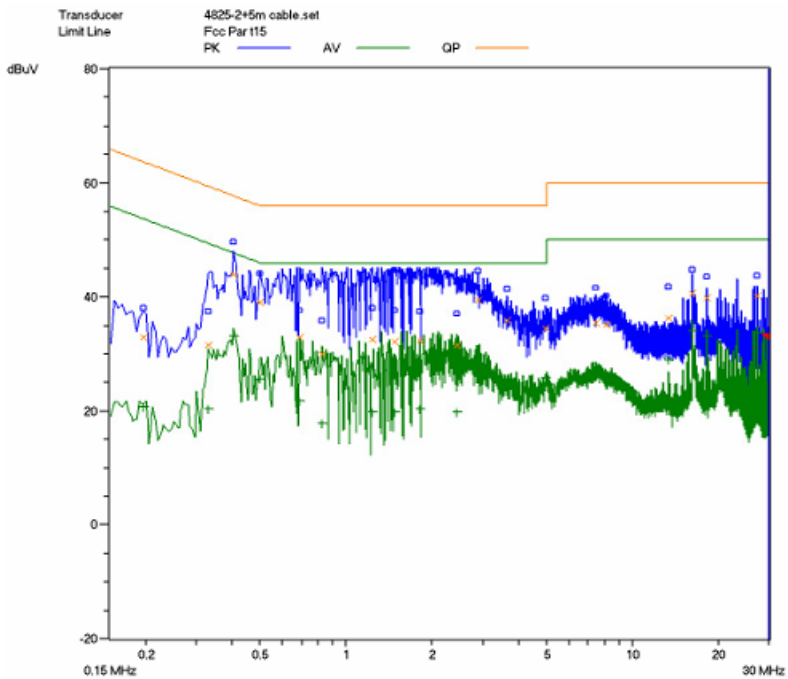

Line N Conducted Emission Graph -IP Call

Test Data:**Adaptor #1(Mass):**

Lines (L/N)	Frequency (MHz)	Corrected QP Level (dBuV)	Limits QP (dBuV)	Margin QP (dB)	Frequency (MHz)	Corrected AV Level (dBuV)	Limits AV (dBuV)	Margin QP (dB)
IP Call Mode								
L	0.1900	40.7	64.0	-23.3	0.1900	21.4	54.0	-32.6
L	0.4900	40.6	56.2	-15.6	0.4900	30.5	46.2	-15.7
L	0.7350	38.3	56.0	-17.7	0.7350	25.6	46.0	-20.4
N	0.1900	40.6	64.0	-23.4	0.1900	21.3	54.0	-32.7
N	0.4900	40.2	56.2	-16.0	0.4900	30.3	46.2	-15.9
N	0.7350	38.0	56.0	-18.0	0.7350	25.1	46.0	-20.9
<p>Note :</p> <p>1) All readings are using a bandwidth of 9 kHz, with a 500 ms sweep time. A video filter was not use.</p> <p>2) "QP" means "Quasi-Peak" values, "AV" means "Average" values.</p> <p>3) The other reading are too low against official limits that are not be recorded.</p>								

Adaptor #2(AK):

Lines (L/N)	Frequency (MHz)	Corrected QP Level (dBuV)	Limits QP (dBuV)	Margin QP (dB)	Frequency (MHz)	Corrected AV Level (dBuV)	Limits AV (dBuV)	Margin QP (dB)
IP Call Mode								
L	0.2200	33.5	62.8	-29.3	0.2200	20.8	52.8	-32.0
L	0.4250	35.0	57.3	-22.3	0.4250	26.3	47.3	-21.0
L	1.7900	40.7	56.0	-15.3	1.7900	29.9	46.0	-16.1
N	0.2200	33.1	62.8	-29.7	0.2200	20.2	52.8	-32.6
N	0.4250	34.6	57.3	-22.7	0.4250	26.1	47.3	-21.2
N	1.7900	40.2	56.0	-15.8	1.7900	29.7	46.0	-16.3
<p>Note :</p> <p>1) All readings are using a bandwidth of 9 kHz, with a 500 ms sweep time. A video filter was not use.</p> <p>2) "QP" means "Quasi-Peak" values, "AV" means "Average" values.</p> <p>3) The other reading are too low against official limits that are not be recorded.</p>								

Adaptor #3(Swtec):

Lines (L/N)	Frequency (MHz)	Corrected QP Level (dBuV)	Limits QP (dBuV)	Margin QP (dB)	Frequency (MHz)	Corrected AV Level (dBuV)	Limits AV (dBuV)	Margin QP (dB)
IP Call Mode								
L	0.3950	44.9	57.9	-13.0	0.3950	33.5	47.9	-14.4
L	0.5100	38.9	56.0	-17.1	0.5100	25.8	46.0	-20.2
L	2.8700	39.1	56.0	-16.9	2.8700	28.4	46.0	-17.6
N	0.3950	44.7	57.9	-13.2	0.3950	33.4	47.9	-14.5
N	0.5100	38.5	56.0	-17.5	0.5100	25.5	46.0	-20.5
N	2.8700	39.0	56.0	-17.0	2.8700	28.1	46.0	-17.9

Note :

4) All readings are using a bandwidth of 9 kHz, with a 500 ms sweep time. A video filter was not use.

5) "QP" means "Quasi-Peak" values, "AV" means "Average" values.

6) The other reading are too low against official limits that are not be recorded.

Test Equipment List:

Test Equipment	Model No.	Manufacturer	Serial No.	Last Cal.	Cal. Interval
Receiver	SMR4503	SCHAFFNER	11725	2011.07.08	2012.07.08
Line impedance stabilization network	4825/2	ETS	1161	2011.07.08	2012.07.08

Note: All testing were performed using internationally recognized standards. All test instruments were calibrated.

SIGNED BY: 

ENGINEER

REVIEWED BY: 

SENIOR ENGINEER



Conducted Emission Test Set-up

ATTACHMENT 2 – RADIATED EMISSION MEASUREMENT

CLIENT:	Grandstream Networks, INC	TEST STANDERD:	FCC Part 15,Subpart B, Section 15.109
MODEL NUMBERS:	GXP1450	PRODUCT:	IP Phone
EUT MODEL:	GXP1450	EUT DESIGNATION:	Home or Office
TEMPERATURE:	23°C	HUMIDITY:	49%RH
ATM PRESSURE:	103.0kPa	GROUNDING:	None
TESTED BY:	Sewen Guo	DATE OF TEST:	August 9, 2011
TEST REFERENCE:	ANSI C63.4- 2003		
TEST PROCEDURE:	<p>The EUT was set up according to the guidelines of ANSI C63.4- 2003 for radiated emissions. An EMI receiver peak scan was made at the frequency measurement range (pre-scan) in an Anechoic chamber.signal discrimination was then performed and the significant peaks marked.these peaks were then quasi-peaked in the frequency range of 30 MHz to 1GHz and average and peak in the frequency range of 1GHz to 3GHz at an anechoic chamber.</p> <p>The following data lists the significant emission frequencies, measured levels, correction factors (including cable and antenna correction factors), and the corrected readings against the limits. Explanation of the Correction Factor are given as follows:</p> <p>FS= RA + AF + CF - AG</p> <p>Where: FS = Field Strength</p> <p>RA = Receiver Amplitude</p> <p>AF = Antenna Factor</p> <p>CF = Cable Attenuation Factor</p> <p>AG = Amplifier Gain</p>		
TEST MODE	<p>For 9KHz to 30MHz:</p> <p>Pre-scan has been conducted to determine the worst-case modes from all possible combinations between available mode.Adapter #1(Mass) at IP Call mode was chosen for final test.</p> <p>For 30MHz to 2,000MHz:</p> <p>Adater #1(Mass) ,Adapter #2(AK),Adapter #3 at IP Call mode and PoE mode were selected for the final testing.</p>		
TESTED RANGE:	30MHz to 5GHz		
TEST VOLTAGE:	AC 120V/60Hz		
RESULTS:	The EUT meet the requirements of test reference for radiated emissions.The test results relate only to the equipment under test provided by client.		
CHANGES OR MODIFICATIONS:	There were no modifications installed by ECMG Electronic Technical Testing Corp(Shenzhen). Test personnel.		
M. UNCERTAINTY:	Freq. ± 2x10-7 x Center Freq., Amp ± 2.6 dB		

**For IP Call Mode:
Adaptor #1(Mass)**

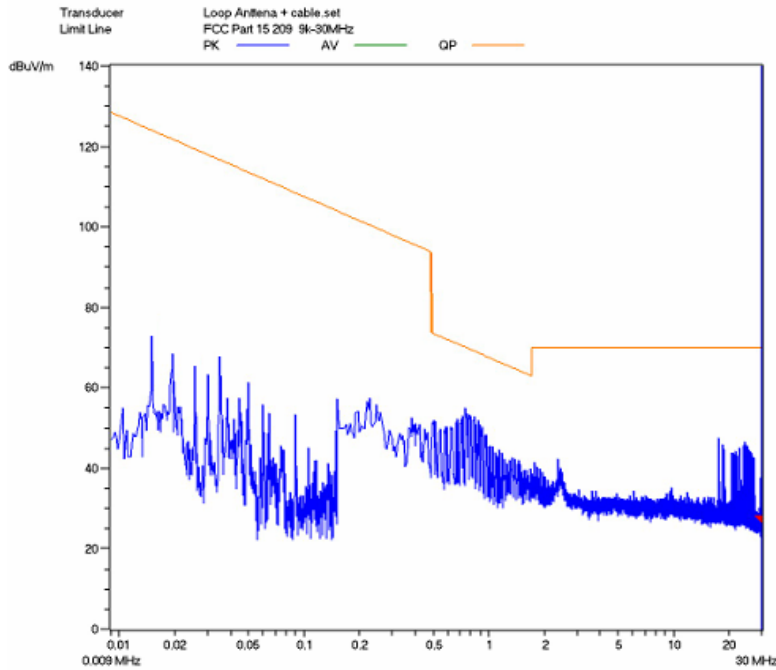

Radiated Filed Strength Emission Test Plot(9KHz-30MHz)

**For IP Call Mode:
Adaptor #1(Mass)**

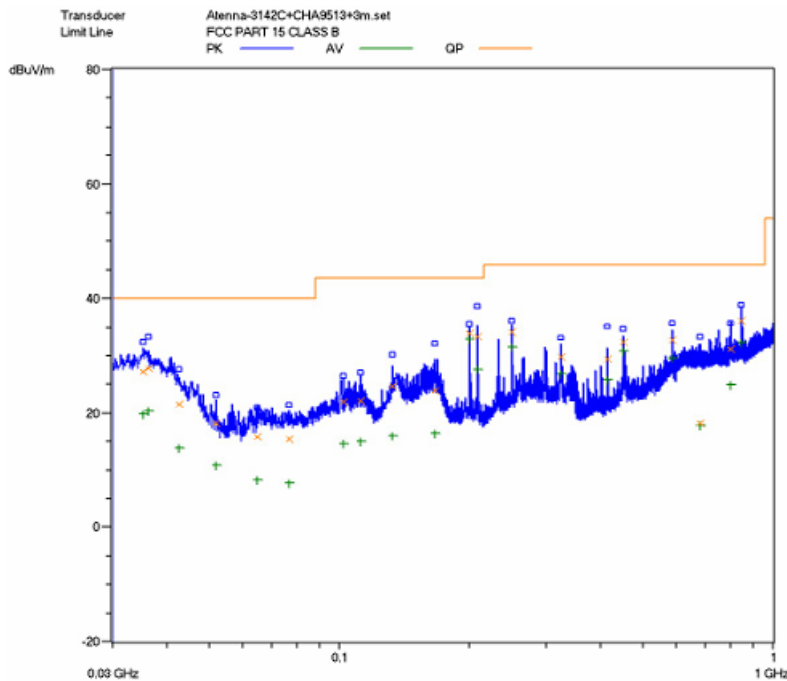

Horizontal:Radiated Emission Test Plot(30MHz-1000MHz)

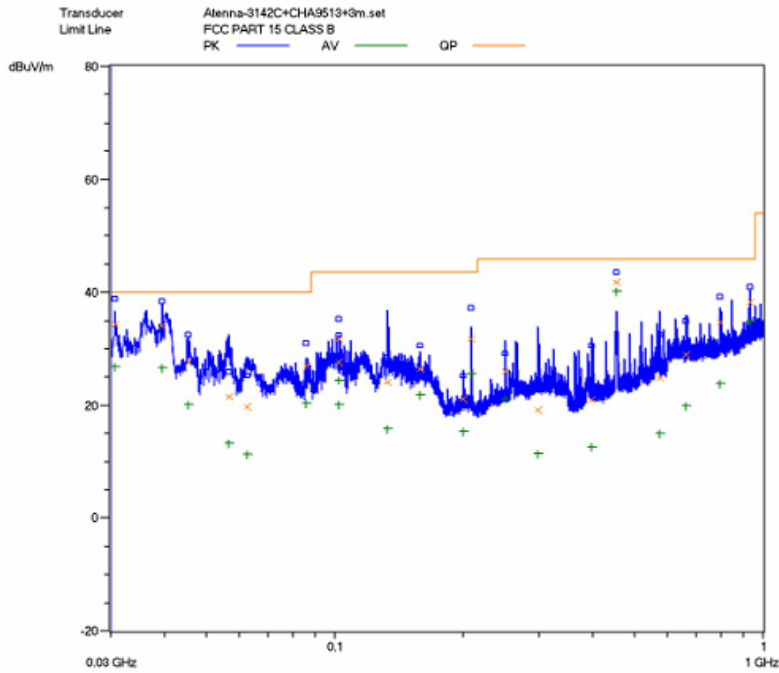

Vertical:Radiated Emission Test Plot(30MHz-1000MHz)

Adaptor #2:(AK)

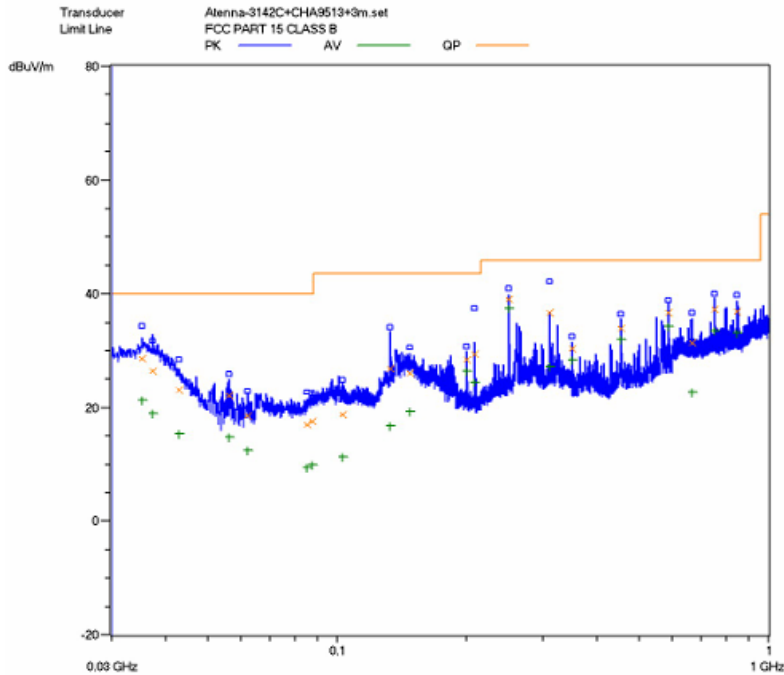

Horizontal:Radiated Emission Test Plot(30MHz-1000MHz)

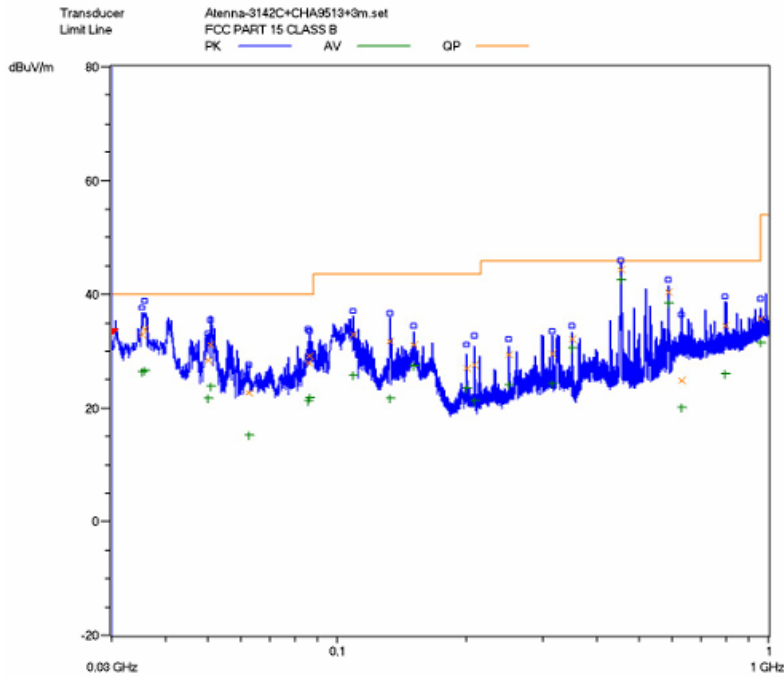

Adaptor #3:(Swtec)

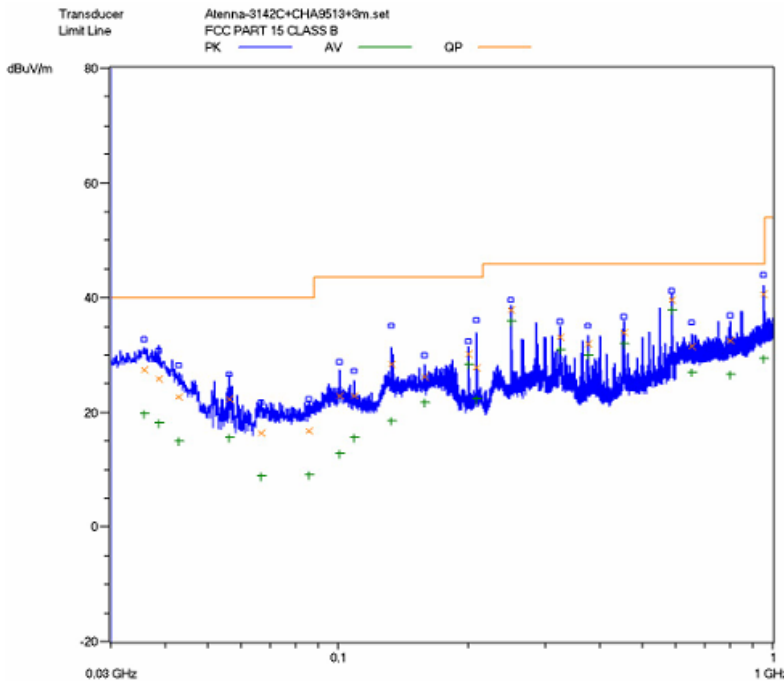

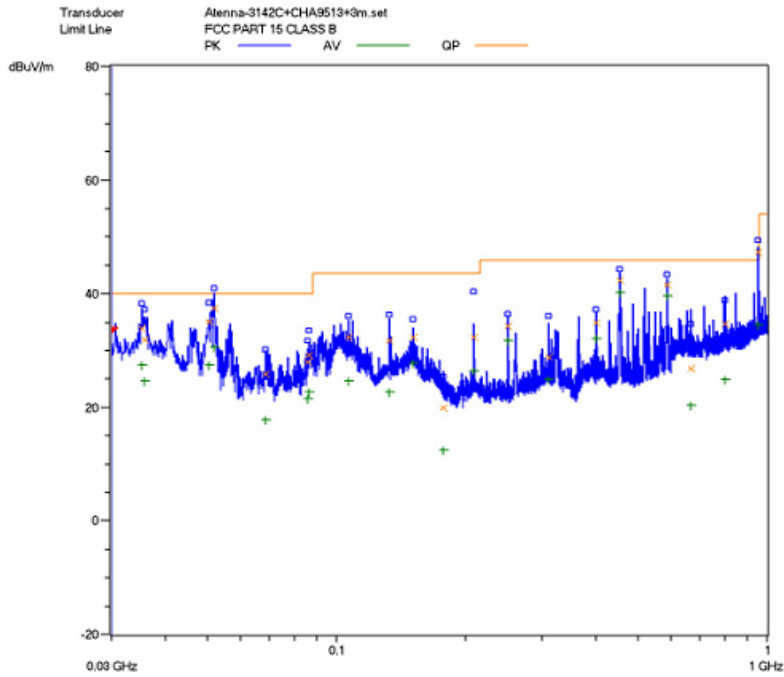

Vertical:Radiated Emission Test Plot(30MHz-1000MHz)

For PoE Mode:

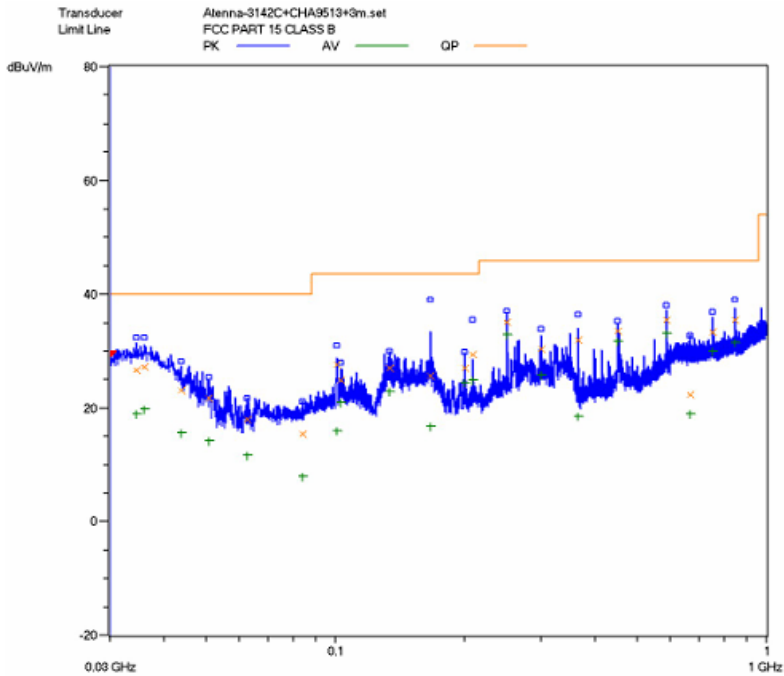

Horizontal:Radiated Emission Test Plot(30MHz-1000MHz)

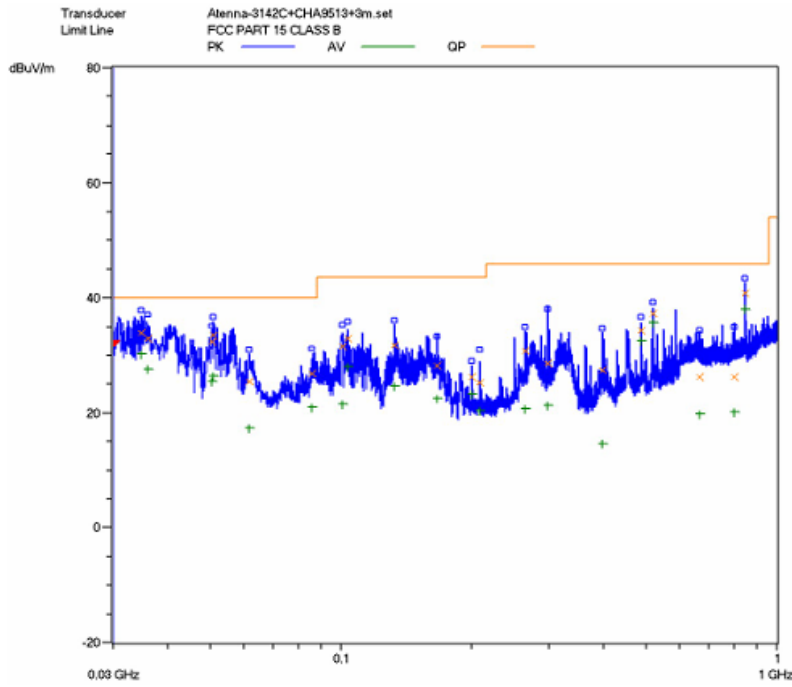

Vertical:Radiated Emission Test Plot(30MHz-1000MHz)

Test Data:

For 9KHz to 30MHz:

Test No.:#	Frequency (MHz)	Cable Loss (dB)	Antenna Factor (dB)	Reading Level QP (dBuV/m)	Emission Level (dBuV/m)	Limit (dBuV/m)	Margin (dB)
1	/	/	/	/	/	/	/
2	/	/	/	/	/	/	/
3	/	/	/	/	/	/	/
4	/	/	/	/	/	/	/
5	/	/	/	/	/	/	/
6	/	/	/	/	/	/	/

Note:

- The field strength is calculated by adding the antenna factor, cable factor. The basic equation with a sample calculation is as follows:

$$\text{Emission Level} = \text{Reading Level} + \text{Antenna Factor} + \text{Cable Loss}.$$
- The limits shown are based on quasi-peak detector except for the frequency bands 9-90 kHz, 110-490 kHz. the bandwidth of Test Receiver was set at 200Hz in frequency range of 9KHz to 150KHz, 9kHz in the frequency range of 150KHz to 30MHz.
- All emission levels in the frequency range of 9KHz to 30MHz are 20dB below the official limits that are not reported.

Test Data:

Adaptor #1(Mass):

IP Call Mode/Below 1GHz:

Frequency (MHz)	Cable Loss (dB)	Antenna Factor (dB)	Preamp Factor (dB)	Reading Level QP (dBuV/m)	Emission Level (dBuV/m)	Limit (dBuV/m)	Margin (dB)
Horizontal							
36.160	0.02	18.4	/	9.48	27.9	40.0	-12.1
200.000	0.10	6.8	/	27.10	34.0	43.5	-9.5
207.360	0.12	7.2	/	26.08	33.4	43.5	-10.1
250.000	0.12	11.8	/	22.18	34.1	46.0	-11.9
450.000	0.20	16.8	/	15.4	32.4	46.0	-13.6
844.560	0.42	22.6	/	12.98	36.0	46.0	-10.0
Vertical							
30.640	0.02	16.7	/	17.58	34.3	40.0	-5.7
39.520	0.02	16.8	/	17.28	34.1	43.5	-9.4
101.920	0.02	7.8	/	23.88	31.7	43.5	-11.8
207.360	0.12	7.2	/	24.48	31.8	46.0	-14.2
454.800	0.20	16.8	/	24.90	41.9	46.0	-4.1
930.640	0.44	23.8	/	14.06	38.3	46.0	-7.7

Note:

- a) All readings are quasi-peak unless stated otherwise, using a QPA bandwidth of 120kHz, with a 60 s sweep time. A video filter was not used.
- b) The field strength is calculated by adding the Antenna Factor, Cable Factor & Preamplifier. The basic equation with a sample calculation is as follows: Emission Level = Reading Level + Antenna Factor + Cable Loss - Preamplifier Factor.
- c) The other emission levels are 20dB below the official limits that are not reported.

IP Call Mode/Above 1GHz:

Frequency (MHz)	Cable Loss (dB)	Antenna Factor (dB)	Preamplifier Factor (dB)	Reading Level (dBuV/m)	Emission Level (dBuV/m)	Limit (dBuV/m)	Margin (dB)	Antenna Polarization (H/V)
Peak Measurement								
1.056	1.40	23.9	-33.6	-0.01	58.89	74	-15.11	H
1.192	1.45	24.5	-33.6	0.4	59.95	74	-14.05	H
1.592	1.76	26.7	-33	-2.65	58.81	74	-15.19	H
1.080	1.42	24.1	-33.6	-2.4	56.72	74	-17.28	V
1.192	1.45	24.5	-33.6	-4.42	55.13	74	-18.87	V
1.592	1.76	26.7	-33	-10.77	50.69	74	-23.31	V
Average Measurement								
1.056	1.40	23.9	-33.6	-13.15	45.75	54	-8.25	H
1.192	1.45	24.5	-33.6	-16.85	42.70	54	-11.3	H
1.592	1.76	26.7	-33	-20.42	41.04	54	-12.96	H
1.080	1.42	24.1	-33.6	-18.41	40.71	54	-13.29	V
1.192	1.45	24.5	-33.6	-15.82	43.73	54	-10.27	V
1.592	1.76	26.7	-33	-15.3	46.16	54	-7.84	V

Note:

- a) The field strength is calculated by adding the Antenna Factor, Cable Factor & Preamplifier. The basic equation with a sample calculation is as follows: Emission Level = Reading Level + Antenna Factor + Cable Loss - Preamplifier Factor.
- b) The limits shown are based on Peak value and Average value detector above 1GHz, the bandwidth of Test Receiver was set at 1MHz above 1GHz.
- c) The other emission levels are 20dB below the official limits that are not reported.

Adaptor #2: (AK)
IP Call Mode/Below 1GHz:

Frequency (MHz)	Cable Loss (dB)	Antenna Factor (dB)	Preamplifier Factor (dB)	Reading Level QP (dBuV/m)	Emission Level (dBuV/m)	Limit (dBuV/m)	Margin (dB)
Horizontal							
35.360	0.02	16.8	/	11.78	28.6	40.0	-11.4
37.280	0.02	18.4	/	8.08	26.5	40.0	-13.5
207.360	0.12	7.2	/	22.18	29.5	43.5	-14.0
250.000	0.12	11.8	/	27.08	39.0	46.0	-7.0
311.040	0.16	13.7	/	22.94	36.8	46.0	-9.2
844.560	0.20	16.8	/	19.90	36.9	46.0	-9.1
Vertical							
35.280	0.02	18.4	/	14.58	33.0	40.0	-7.0
37.760	0.02	18.4	/	15.48	33.9	40.0	-6.1
108.800	0.02	7.4	/	25.48	32.9	43.5	-10.6
454.800	0.20	16.8	/	27.30	44.0	46.0	-2.0
584.720	0.30	18.7	/	21.4	40.4	46.0	-5.6
959.280	0.44	23.9	/	11.46	35.8	46.0	-10.2

Note:

- a) All readings are quasi-peak unless stated otherwise, using a QPA bandwidth of 120kHz, with a 60 s sweep time. A video filter was not used.
- b) The field strength is calculated by adding the Antenna Factor, Cable Factor & Preamplifier. The basic equation with a sample calculation is as follows: Emission Level = Reading Level + Antenna Factor + Cable Loss - Preamplifier Factor.
- c) The other emission levels are 20dB below the official limits that are not reported.

IP Call Mode/Above 1GHz:

Frequency (MHz)	Cable Loss (dB)	Antenna Factor (dB)	Preamplifier Factor (dB)	Reading Level (dBuV/m)	Emission Level (dBuV/m)	Limit (dBuV/m)	Margin (dB)	Antenna Polarization (H/V)
Peak Measurement								
1.056	1.40	23.9	-33.6	0.23	59.13	74	-14.87	H
1.192	1.45	24.5	-33.6	-4.28	55.27	74	-18.73	H
1.592	1.76	26.7	-33	-5.24	56.22	74	-17.78	H
1.080	1.42	24.1	-33.6	-1.86	57.26	74	-16.74	V
1.192	1.45	24.5	-33.6	-6.36	53.19	74	-20.81	V
1.592	1.76	26.7	-33	-10.14	51.32	74	-22.68	V
Average Measurement								
1.056	1.40	23.9	-33.6	-15.61	43.29	54	-10.71	H
1.192	1.45	24.5	-33.6	-14.45	45.10	54	-8.9	H
1.592	1.76	26.7	-33	-19.09	42.37	54	-11.63	H
1.080	1.42	24.1	-33.6	-18.99	40.13	54	-13.87	V
1.192	1.45	24.5	-33.6	-17.39	42.16	54	-11.84	V
1.592	1.76	26.7	-33	-18.19	43.27	54	-10.73	V

Note:

- a) The field strength is calculated by adding the Antenna Factor, Cable Factor & Preamplifier. The basic equation with a sample calculation is as follows: Emission Level = Reading Level + Antenna Factor + Cable Loss - Preamplifier Factor.
- b) The limits shown are based on Peak value and Average value detector above 1GHz, the bandwidth of Test Receiver was set at 1MHz above 1GHz.
- c) The other emission levels are 20dB below the official limits that are not reported.

**Adaptor #3(Swtec):
IP Call Mode/Below 1GHz:**

Frequency (MHz)	Cable Loss (dB)	Antenna Factor (dB)	Preamplifier Factor (dB)	Reading Level QP (dBuV/m)	Emission Level (dBuV/m)	Limit (dBuV/m)	Margin (dB)
Horizontal							
35.760	0.02	18.4	/	8.98	27.4	40.0	-12.6
38.560	0.02	18.4	/	7.38	25.8	40.0	-14.2
132.960	0.02	7.4	/	21.08	28.5	43.5	-15.0
200.000	0.10	6.8	/	23.2	30.1	43.5	-13.4
250.000	0.12	11.8	/	25.88	37.8	46.0	-8.2
584.720	0.30	18.7	/	20.7	39.7	46.0	-6.3
Vertical							
35.360	0.02	18.4	/	15.28	33.7	40.0	-6.3
50.480	0.02	8.2	/	26.98	35.2	40.0	-4.8
106.720	0.02	7.7	/	24.58	32.3	43.5	-11.2
132.880	0.02	7.4	/	24.28	31.7	43.5	-11.8
454.800	0.20	16.8	/	25.40	42.4	46.0	-3.6
584.720	0.30	18.7	/	22.50	41.5	46.0	-4.5

Note:

- a) All readings are quasi-peak unless stated otherwise, using a QPA bandwidth of 120kHz, with a 60 s sweep time. A video filter was not used.
- b) The field strength is calculated by adding the Antenna Factor, Cable Factor & Preamplifier. The basic equation with a sample calculation is as follows: Emission Level = Reading Level + Antenna Factor + Cable Loss - Preamplifier Factor.
- c) The other emission levels are 20dB below the official limits that are not reported.

IP Call Mode/Above 1GHz:

Frequency (MHz)	Cable Loss (dB)	Antenna Factor (dB)	Preamplifier Factor (dB)	Reading Level (dBuV/m)	Emission Level (dBuV/m)	Limit (dBuV/m)	Margin (dB)	Antenna Polarization (H/V)
Peak Measurement								
1.056	1.40	23.9	-33.6	-1.34	57.56	74	-16.44	H
1.192	1.45	24.5	-33.6	-6.34	53.21	74	-20.79	H
1.592	1.76	26.7	-33	-5.45	56.01	74	-17.99	H
1.080	1.42	24.1	-33.6	-0.85	58.27	74	-15.73	V
1.192	1.45	24.5	-33.6	-1.92	57.63	74	-16.37	V
1.592	1.76	26.7	-33	-9.45	52.01	74	-21.99	V
Average Measurement								
1.056	1.40	23.9	-33.6	-16.13	42.77	54	-11.23	H
1.192	1.45	24.5	-33.6	-17.39	42.16	54	-11.84	H
1.592	1.76	26.7	-33	-20.76	40.70	54	-13.3	H
1.080	1.42	24.1	-33.6	-16.11	43.01	54	-10.99	V
1.192	1.45	24.5	-33.6	-16.28	43.27	54	-10.73	V
1.592	1.76	26.7	-33	-19.36	42.10	54	-11.9	V

Note:

- a) The field strength is calculated by adding the Antenna Factor, Cable Factor & Preamplifier. The basic equation with a sample calculation is as follows: Emission Level = Reading Level + Antenna Factor + Cable Loss - Preamplifier Factor.
- b) The limits shown are based on Peak value and Average value detector above 1GHz, the bandwidth of Test Receiver was set at 1MHz above 1GHz.
- c) The other emission levels are 20dB below the official limits that are not reported.

PoE Mode/Below 1GHz:

Frequency (MHz)	Cable Loss (dB)	Antenna Factor (dB)	Preamplifier Factor (dB)	Reading Level QP (dBuV/m)	Emission Level (dBuV/m)	Limit (dBuV/m)	Margin (dB)
Horizontal							
250.000	0.12	11.8	/	23.18	35.1	46.0	-10.9
364.480	0.16	13.5	/	18.24	31.9	46.0	-14.1
450.480	0.2	16.8	/	16.5	33.5	46.0	-12.5
584.720	0.3	18.7	/	16.5	35.5	46.0	-10.5
750.080	0.39	21.1	/	11.81	33.3	46.0	-12.7
844.560	0.42	22.5	/	12.58	35.5	46.0	-10.5
Vertical							
34.720	0.02	18.0	/	15.98	34.0	40.0	-6.0
36.000	0.02	18.4	/	14.58	33.0	40.0	-7.0
50.400	0.02	8.2	/	24.18	32.4	40.0	-7.6
51.040	0.02	7.2	/	26.38	33.6	40.0	-6.4
100.720	0.02	7.8	/	23.78	31.6	43.5	-11.9
844.560	0.42	22.5	/	17.88	40.8	46.0	-5.2

Note:

- a) All readings are quasi-peak unless stated otherwise, using a QPA bandwidth of 120kHz, with a 60 s sweep time. A video filter was not used.
- b) The field strength is calculated by adding the Antenna Factor, Cable Factor & Preamplifier. The basic equation with a sample calculation is as follows: Emission Level = Reading Level + Antenna Factor + Cable Loss - Preamplifier Factor.
- c) The other emission levels are 20dB below the official limits that are not reported.

PoE Mode/Above 1GHz:

Frequency (MHz)	Cable Loss (dB)	Antenna Factor (dB)	Preamplifier Factor (dB)	Reading Level (dBuV/m)	Emission Level (dBuV/m)	Limit (dBuV/m)	Margin (dB)	Antenna Polarization (H/V)
Peak Measurement								
1.056	1.40	23.9	-33.6	-0.03	58.87	74	-15.13	H
1.192	1.45	24.5	-33.6	-3.92	55.63	74	-18.37	H
1.592	1.76	26.7	-33	-1.74	59.72	74	-14.28	H
1.080	1.42	24.1	-33.6	-1.3	57.82	74	-16.18	V
1.192	1.45	24.5	-33.6	-5.76	53.79	74	-20.21	V
1.592	1.76	26.7	-33	-6.46	55.00	74	-19.0	V
Average Measurement								
1.056	1.40	23.9	-33.6	-18.89	40.01	54	-13.99	H
1.192	1.45	24.5	-33.6	-18.32	41.23	54	-12.77	H
1.592	1.76	26.7	-33	-21.45	40.01	54	-13.99	H
1.080	1.42	24.1	-33.6	-13.85	45.27	54	-8.73	V
1.192	1.45	24.5	-33.6	-17.45	42.10	54	-11.9	V
1.592	1.76	26.7	-33	-17.72	43.74	54	-10.26	V

Note:

- a) The field strength is calculated by adding the Antenna Factor, Cable Factor & Preamplifier. The basic equation with a sample calculation is as follows: Emission Level = Reading Level + Antenna Factor + Cable Loss - Preamplifier Factor.
- b) The limits shown are based on Peak value and Average value detector above 1GHz, the bandwidth of Test Receiver was set at 1MHz above 1GHz.
- c) The other emission levels are 20dB below the official limits that are not reported.

Test Equipment List:

<i>Test Equipment</i>	<i>Model No.</i>	<i>Manufacturer</i>	<i>Serial No.</i>	<i>Last Cal.</i>	<i>Cal. Due</i>
<i>Receiver</i>	<i>SMR4503</i>	<i>SCHAFFNER</i>	<i>11725</i>	<i>2011.07.08</i>	<i>2012.07.07</i>
<i>HF Loop Antenna</i>	<i>HLA6120</i>	<i>TESEQ</i>	<i>26348</i>	<i>2011.09.27</i>	<i>2012.09.26</i>
<i>Double-ridged Wave guide horn</i>	<i>3115</i>	<i>ETS</i>	<i>6587</i>	<i>2011.08.02</i>	<i>2012.08.01</i>
<i>Microwave system amplifier</i>	<i>83017A</i>	<i>Agilent</i>	<i>MY39500438</i>	<i>2011.07.11</i>	<i>2012.07.10</i>
<i>Biconilog Antenna</i>	<i>3142C</i>	<i>ETS</i>	<i>00042672</i>	<i>2010.09.28</i>	<i>2011.09.27</i>
<i>Band-pass Filter</i>	<i>BRM50702</i>	<i>Micro-Tronic</i>	<i>S/N-030</i>	<i>2010.11.30</i>	<i>2011.11.29</i>
<i>Spectrum Analyzer</i>	<i>FSP30</i>	<i>R&S</i>	<i>100755</i>	<i>2010.11.30</i>	<i>2011.11.29</i>
<i>Note: All testing were performed using internationally recognized standards. All test instruments were calibrated.</i>					

SIGNED BY:



ENGINEER

REVIEWED BY:



SENIOR ENGINEER

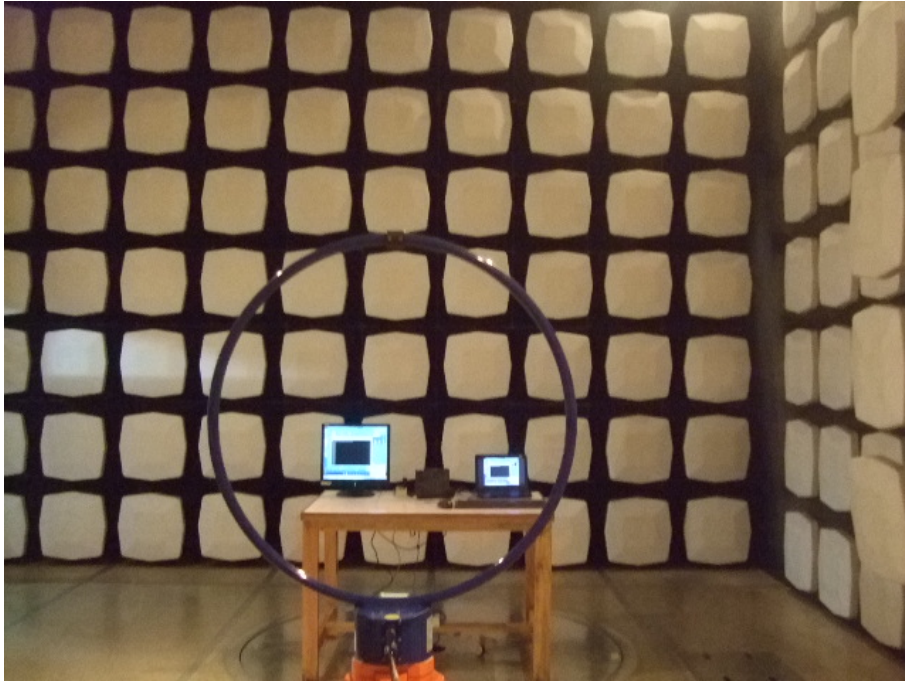

Radiated Emission Test Set-up(9KHz-30MHz)



Radiated Emission Test Set-up(Below 1GHz)



Radiated Emission Test Set-up(Above 1GHz)