

# EMC TEST REPORT

**Report No.:** FCC2012-8032

**Product:** IP Phone

**Model No. :** GXP1160, GXP1165

**Brand Name:** Grandstream

**Applicant:** Grandstream Networks, INC

**FCC ID:** YZZGXP116X

**Issued by:** ShenZhen Electronic Product Quality Testing Center

**Lab Location:** Electronic Testing Building, Shahe Road, Xili, Nanshan District,  
Shenzhen, 518055, P. R. China

**Tel:** 86 755 26627338     **Fax:** 86 755 26627238



This test report consists of **51** pages in total. It may be duplicated completely for legal use with the approval of the applicant. It should not be reproduced except in full, without the written approval of our laboratory. The client should not use it to claim product endorsement by CCIC-SET. The test results in the report only apply to the tested sample. The test report shall be invalid without all the signatures of testing engineers, reviewer and approver. Any objections must be raised to CCIC-SET within 15 days since the date when the report is received. It will not be taken into consideration beyond this limit.

### Test Report

**Product** .....: IP Phone  
**Model No.** .....: GXP1160, GXP1165  
**Applicant** .....: Grandstream Networks, INC  
**Applicant Address** .....: 5F, Bldg #1, No.2 Kefa Rd., Science & Technology Park,  
Shenzhen, China  
**Manufacturer** .....: Grandstream Networks, INC  
**Manufacturer Address** .....: 5F, Bldg #1, No.2 Kefa Rd., Science & Technology Park,  
Shenzhen, China  
**Test Standards** .....: FCC PART 15  
«RADIO FREQUENCY DEVICES»  
**Test Result** .....: PASS  
**Tested by** .....

Zhu Qi      Sept. 24, 2012

Signature, Date

**Reviewed by** .....

Shuangwen Zhang      Sep. 24, 2012

Signature, Date

**Approved by**.....:

Jinwen Li      Sep. 24, 2012

Signature, Date

## Table of Contents

1 General Information.....	4
1.1 Description of EUT .....	4
2 Test Facilities and Configuration.....	5
2.1 Environmental Conditions .....	5
2.2 Measurement Uncertainty .....	5
2.3 Measurement Equipments Used .....	6
3 Summary of Test Results.....	6
4 Emission Test .....	7
4.1 EUT Setup and Operation .....	7
4.2 Conducted Disturbance at Mains Terminals.....	8
<b>4.2.1 Limits</b> .....	8
<b>4.2.2 Test Setup</b> .....	8
<b>4.2.3 Test Result</b> .....	9
4.3 Radiated Disturbance Measurement.....	19
<b>4.3.1 Limits of Radiated Disturbance</b> .....	19
<b>4.3.2 Test Setup</b> .....	19
<b>4.3.3 Test Result</b> .....	21
Appendix I: Photographs of the EUT .....	36
Appendix II: Photographs of EMC Test Configuration.....	50

# 1 General Information

## 1.1 Description of EUT

**Product:** IP Phone

**Model No.:** GXP1160, GXP1165

**Brand Name:** Grandstream

**Serial No.:** 20EYZCPC7040E41B

**Rating:** GXP1165: DC 5V 800mA, DC 48V(POE)  
GXP1160: DC 5V 800mA

**I/O Ports:** PC, LAN(Support POE in model GXP1165)  
Headset, Handset

**Accessories:** Adaptor:

1#

Model:SCF0500080A1BA,SCF0500080E1BA,SCF0500080I1BA

Input: AC 100-240V, 50/60Hz, 0.15A

Output: DC 5.0V 0.8A

2#

Model:UE05L5-050080SPAU, UE05L5-050080SPAV

Input: AC 100-240V, 50/60Hz, 0.2A

Output: DC 5.0V 0.8A

### Note:

1. Model GXP1160, GXP1165 IP Phone are general usage for information technology equipment. The model GXP1165 has POE (Power Over Ethernet) function. The models are identical except for POE function and ethernet transformer.
2. Adaptor 1# has three models, SCF0500080A1BA, SCF0500080E1BA and SCF0500080I1BA. The models are identical except for plug. Unless otherwise specified, all tests are performed on SCF0500080E1BA to represent other models. Adaptor 2# has two models, UE05L5-050080SPAU and UE05L5-050080SPAV. The models are identical except for plug. Unless otherwise specified, all tests are performed on UE05L5-050080SPAV to represent other models.

## **2 Test Facilities and Configuration**

### **2.1 Environmental Conditions**

During the measurement the environmental conditions were within the listed ranges:

- Temperature: 15-35°C
- Humidity: 30-60 %
- Atmospheric pressure: 86-106 kPa

### **2.2 Measurement Uncertainty**

The uncertainty is calculated using the methods suggested in the “Guide to the Expression of Uncertainty in Measurement” (GUM) published by ISO.

- Uncertainty of Conducted Emission,  $U_c = \pm 1.8\text{dB}$
- Uncertainty of Radiated Emission,  $U_c = \pm 5.0\text{dB}$

## 2.3 Measurement Equipments Used

Description	Manufacturer	Model No.	Calibration Date	Serial No.
Test Receiver	ROHDE&SCHWARZ	ESCS30	Jun.10, 2012	A0304260
LISN	ROHDE&SCHWARZ	ESH2-Z5	Jun.10, 2012	A0304221
Shield Room	Nanbo Tech	RF-2 10.5×5×3.2 (m)	Jan 17, 2012	A0301188
Ultra-Broadband Ant.	SCHWARZBECK	VULB 09160	Jun.10, 2012	A0805560
Horn Antenna	ROHDE&SCHWARZ	HF906	Jun.10, 2012	/
Test Receiver	ROHDE&SCHWARZ	ESU8	Jun.10, 2012	A0805559
Semi-Anechoic Chamber	Albatross	SAC-10MAC19. 6*11.8*8.55m	Jun.10, 2012	A0802520

**NOTE:** Equipments above have been calibrated and are in the period of validation.

## 3 Summary of Test Results

The EUT has been tested according to the following specifications:

EMISSION		
Standard	Test Type	Result
FCC PART 15, Class B	Conducted Disturbance at Mains Terminals	PASS
	Radiated disturbance	PASS

## 4 Emission Test

### 4.1 EUT Setup and Operation

No.	Power supply	Test Mode
Mode 1	DC 5V(Adaptor 1#)	IP Call
Mode 2	DC 48V (POE)	IP Call
Mode 3	DC 5V(Adaptor 2#)	IP Call

The EUT of GXP1165 IP Phone was operating at mode 1, mode 2 and mode 3 during all the tests according to the requirement of the standard.

The EUT of GXP1160 IP Phone was operating at mode 1 and mode 3 during all the tests according to the requirement of the standard.

The EUT and cables, and operation modes were configured to produce the maximum level of emissions for each test.

## 4.2 Conducted Disturbance at Mains Terminals

### 4.2.1 Limits

Frequency range (MHz)	Limits (dB $\mu$ V), Class B ITE	
	Quasi-peak	Average
0.15 - 0.50	66~56	56~46
0.50 – 5	56	46
5-30	60	50

#### NOTE:

1. The lower limit shall apply at the transition frequencies.
2. The limit decreases linearly with the logarithm of the frequency in the range 0.15MHz to 0.50MHz.
3. If the quasi-peak value is lower than Average Limits, it is no necessary to conduct the average measurement.

### 4.2.2 Test Setup

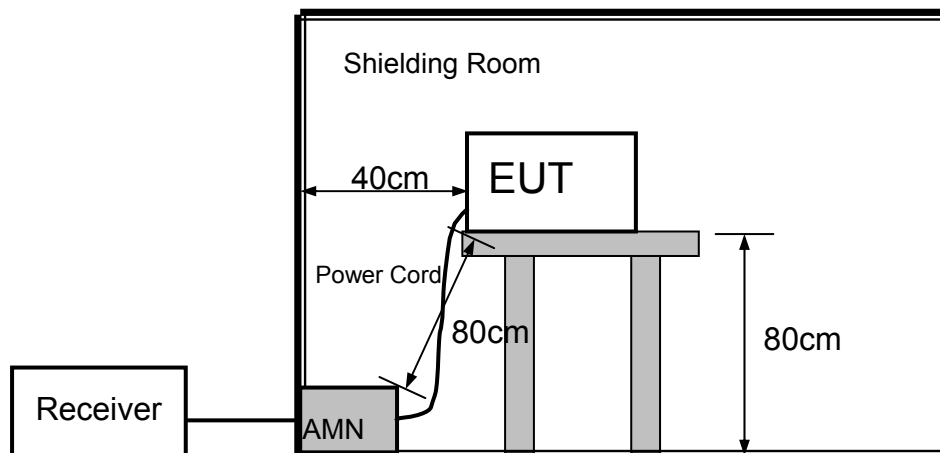



### 4.2.3 Test Result

#### 1, Conducted Disturbance at Mains Terminals

Conducted Disturbance at Mains Terminals							
GXP1165 Mode 1 L Test Data							
QP				AV			
Frequency (MHz)	Limits (dB $\mu$ V)	Measurement Value (dB $\mu$ V)	Margin (dB)	Frequency (MHz)	Limits (dB $\mu$ V)	Measurement Value (dB $\mu$ V)	Margin (dB)
0.5370	56	39.10	16.90	0.5370	46	Note(2)	/
0.5550	56	37.56	18.44	0.5550	46	Note(2)	/
10.7250	60	41.00	19.00	10.7250	50	Note(2)	/
11.3415	60	42.60	17.40	11.3415	50	Note(2)	/
12.6420	60	42.00	18.00	12.6420	50	Note(2)	/
12.9795	60	40.95	19.05	12.9795	50	Note(2)	/

#### L Test Curve

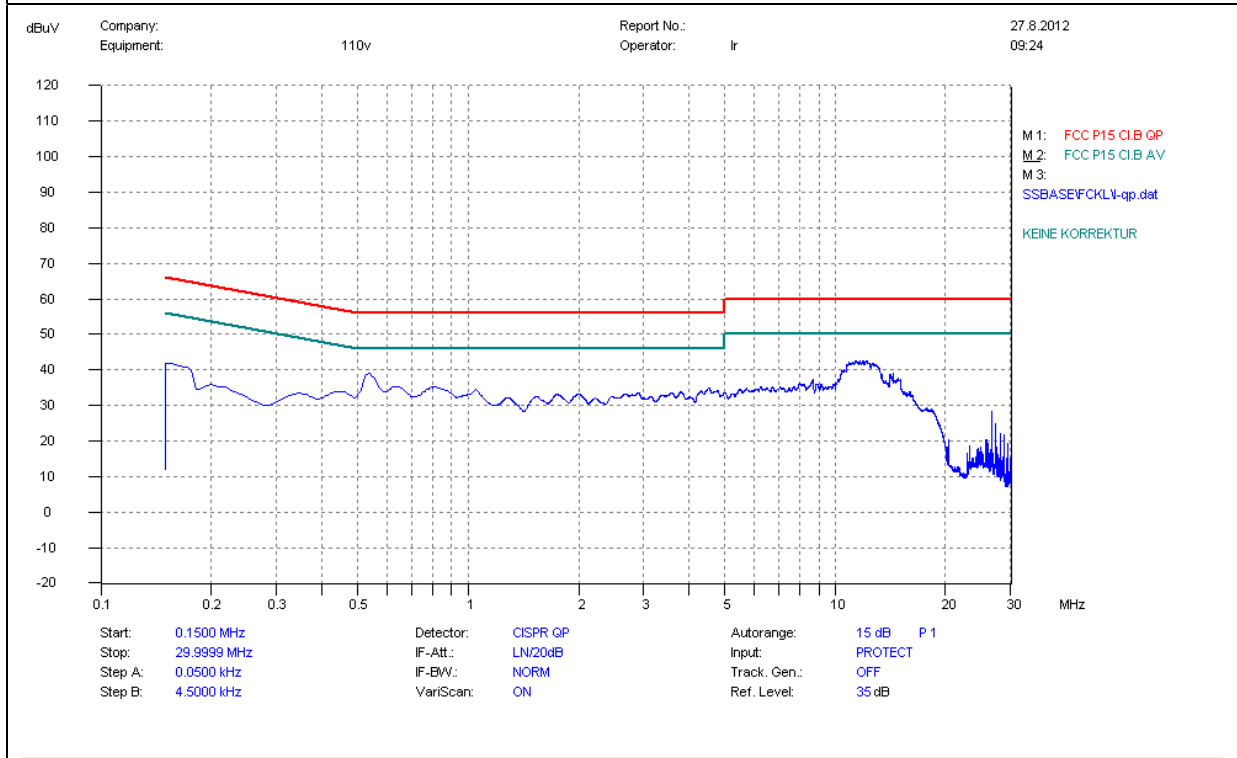

**NOTE:**

1. The lower limit shall apply at the transition frequencies.
2. If the emission levels measured with QP detector are lower than AV limits, there is unnecessary to measure with AV detector.

Conducted Disturbance at Mains Terminals							
GXP1165 Mode 1 N Test Data							
QP				AV			
Frequency (MHz)	Limits (dB $\mu$ V)	Measurement Value (dB $\mu$ V)	Margin (dB)	Frequency (MHz)	Limits (dB $\mu$ V)	Measurement Value (dB $\mu$ V)	Margin (dB)
0.5370	56	45.6	10.4	0.5370	46	Note(2)	/
0.6270	56	41.3	14.7	0.6270	46	Note(2)	/
0.7755	56	40.1	15.9	0.7755	46	Note(2)	/
3.6555	56	40.2	15.8	3.6555	46	Note(2)	/
3.8535	56	40.4	15.6	3.8535	46	Note(2)	/
4.35750	56	40.2	15.8	4.3575	46	Note(2)	/

**N Test Curve**

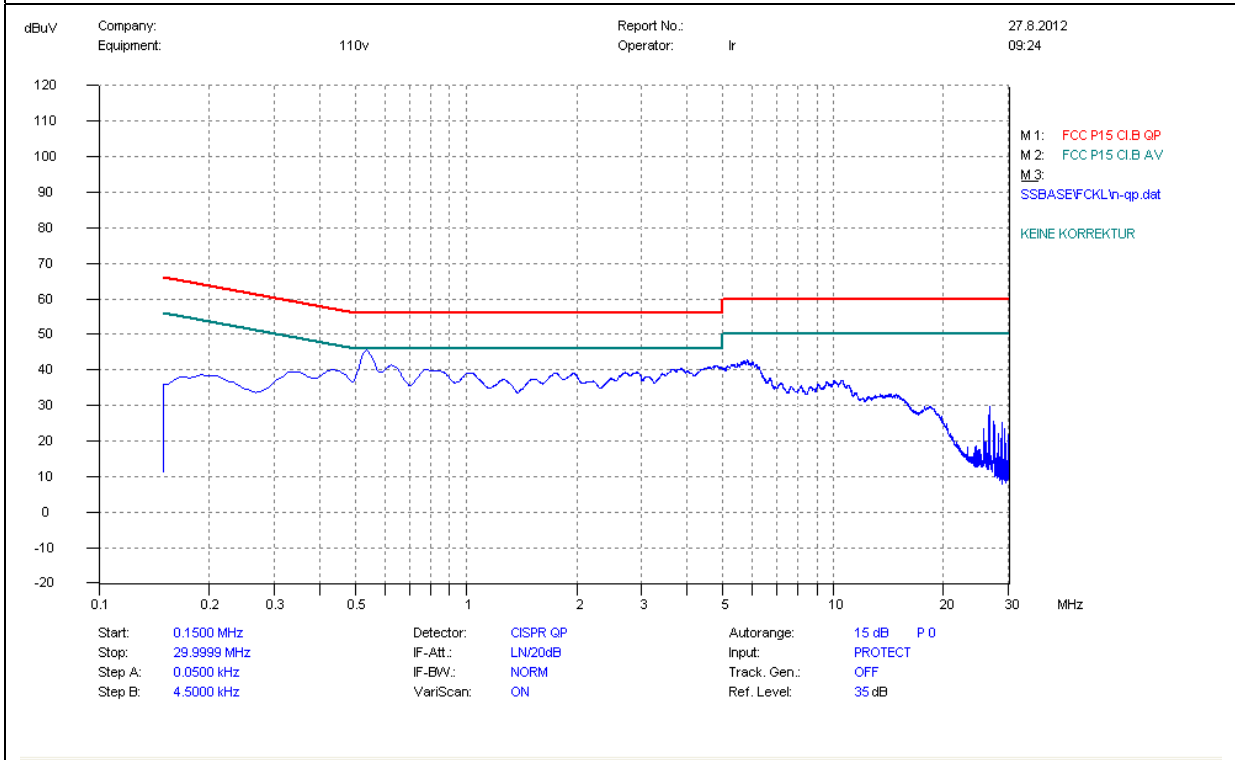

**NOTE:**

1. The lower limit shall apply at the transition frequencies.
2. If the emission levels measured with QP detector are lower than AV limits, there is unnecessary to measure with AV detector.

**Conducted Disturbance at Mains Terminals**

**GXP1165 Mode 2 L Test Data**

QP				AV			
Frequency (MHz)	Limits (dBμV)	Measurement Value (dBμV)	Margin (dB)	Frequency (MHz)	Limits (dBμV)	Measurement Value (dBμV)	Margin (dB)
0.4335	57.2	40.17	17.03	0.4335	47.2	Note(2)	/
0.5010	56	41.00	15.00	0.5010	46	Note(2)	/
0.5100	56	33.48	22.52	0.5100	46	Note(2)	/
0.6810	56	37.48	18.52	0.6810	46	Note(2)	/
0.6855	56	37.78	18.22	0.6855	46	Note(2)	/
0.6900	56	32.77	23.23	0.6900	46	Note(2)	/

**L Test Curve**

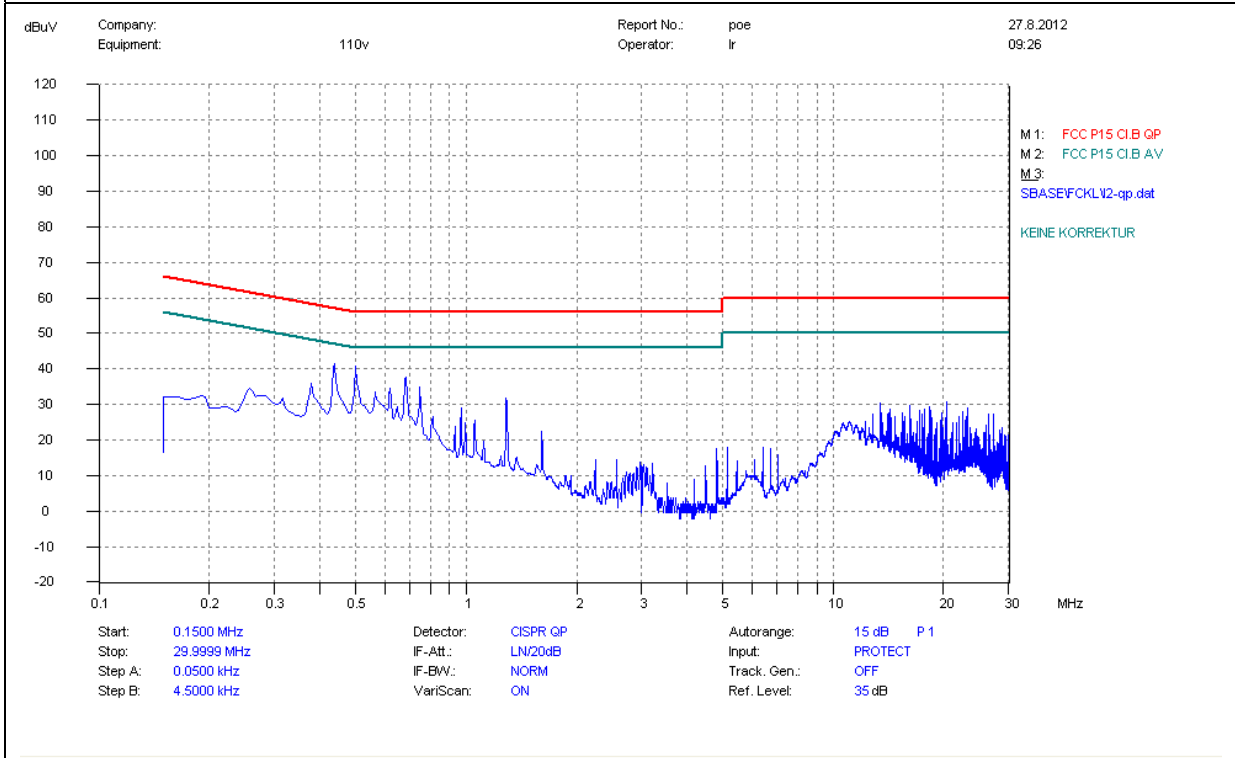

**NOTE:**

- 1 The lower limit shall apply at the transition frequencies.
- 2 If the emission levels measured with QP detector are lower than AV limits, there is unnecessary to measure with AV detector.

Conducted Disturbance at Mains Terminals							
GXP1165 Mode 2 N Test Data							
QP				AV			
Frequency (MHz)	Limits (dB $\mu$ V)	Measurement Value (dB $\mu$ V)	Margin (dB)	Frequency (MHz)	Limits (dB $\mu$ V)	Measurement Value (dB $\mu$ V)	Margin (dB)
0.6450	56	45.70	10.30	0.6450	46	Note(2)	/
0.9645	56	45.90	10.10	0.9645	46	Note(2)	/
0.9950	56	45.59	10.41	0.9950	46	Note(2)	/
1.2840	56	45.69	10.31	1.2840	46	Note(2)	/
1.2885	56	45.80	10.20	1.2885	46	Note(2)	/
4.8606	56	30.00	26.00	4.8606	46	Note(2)	/

**N Test Curve**

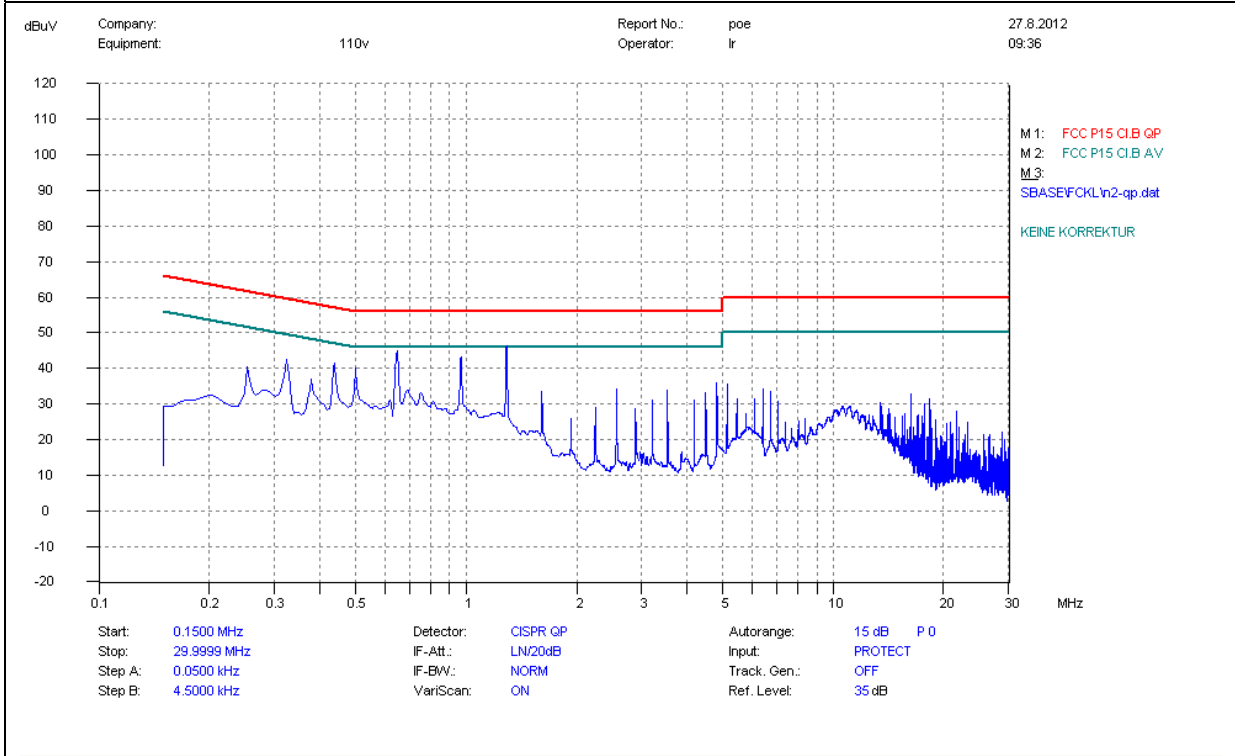

**NOTE:**

- 1 The lower limit shall apply at the transition frequencies.
2. If the emission levels measured with QP detector are lower than AV limits, there is unnecessary to measure with AV detector.

Conducted Disturbance at Mains Terminals							
GXP1165 Mode 3 L Test Data							
QP				AV			
Frequency (MHz)	Limits (dB $\mu$ V)	Measurement Value (dB $\mu$ V)	Margin (dB)	Frequency (MHz)	Limits (dB $\mu$ V)	Measurement Value (dB $\mu$ V)	Margin (dB)
0.3030	60.2	40.70	19.50	0.3030	50.2	37.70	12.50
0.3390	59.2	48.90	10.30	0.3390	49.2	38.90	10.30
0.6765	56	35.40	20.60	0.6765	46	29.50	16.50
1.0346	56	31.26	24.74	1.0346	46	20.56	25.44
1.1568	56	30.46	25.54	1.1568	46	19.86	26.14
2.0460	56	30.56	25.44	2.0460	46	20.42	25.58

**L Test Curve**

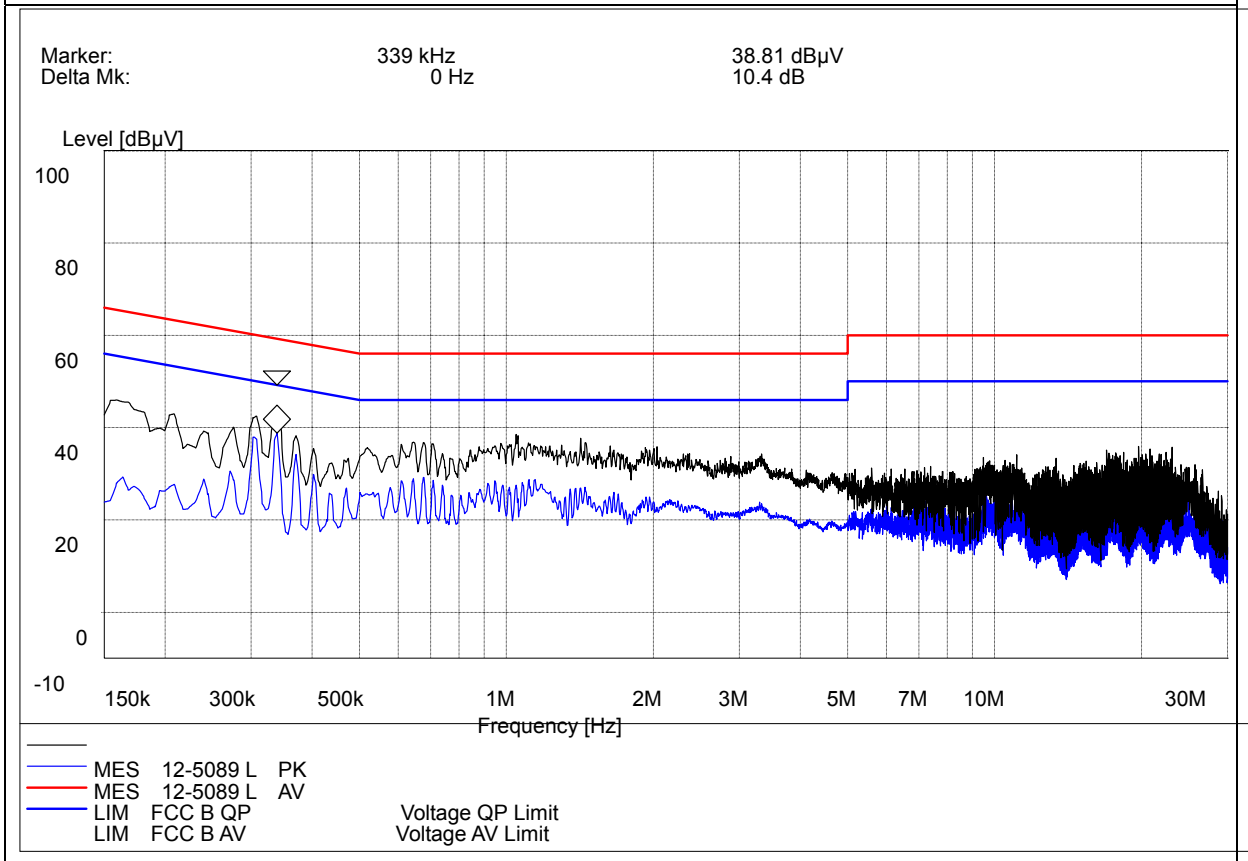

**NOTE:**

- 1 The lower limit shall apply at the transition frequencies.
- 2 If the emission levels measured with QP detector are lower than AV limits, there is unnecessary to measure with AV detector.

Conducted Disturbance at Mains Terminals							
GXP1165 Mode 3 N Test Data							
QP				AV			
Frequency (MHz)	Limits (dB $\mu$ V)	Measurement Value (dB $\mu$ V)	Margin (dB)	Frequency (MHz)	Limits (dB $\mu$ V)	Measurement Value (dB $\mu$ V)	Margin (dB)
0.1680	65.1	41.30	23.80	0.1680	55.1	23.90	31.20
0.3390	60	37.30	22.70	0.3390	50	29.50	20.50
0.8044	56	30.20	25.80	0.8044	46	28.80	17.20
0.9036	56	30.50	25.50	0.9036	46	29.60	26.40
1.0545	56	30.80	25.20	1.0545	46	20.60	25.40
1.0695	56	29.80	26.20	1.0695	46	20.40	25.60

**N Test Curve**

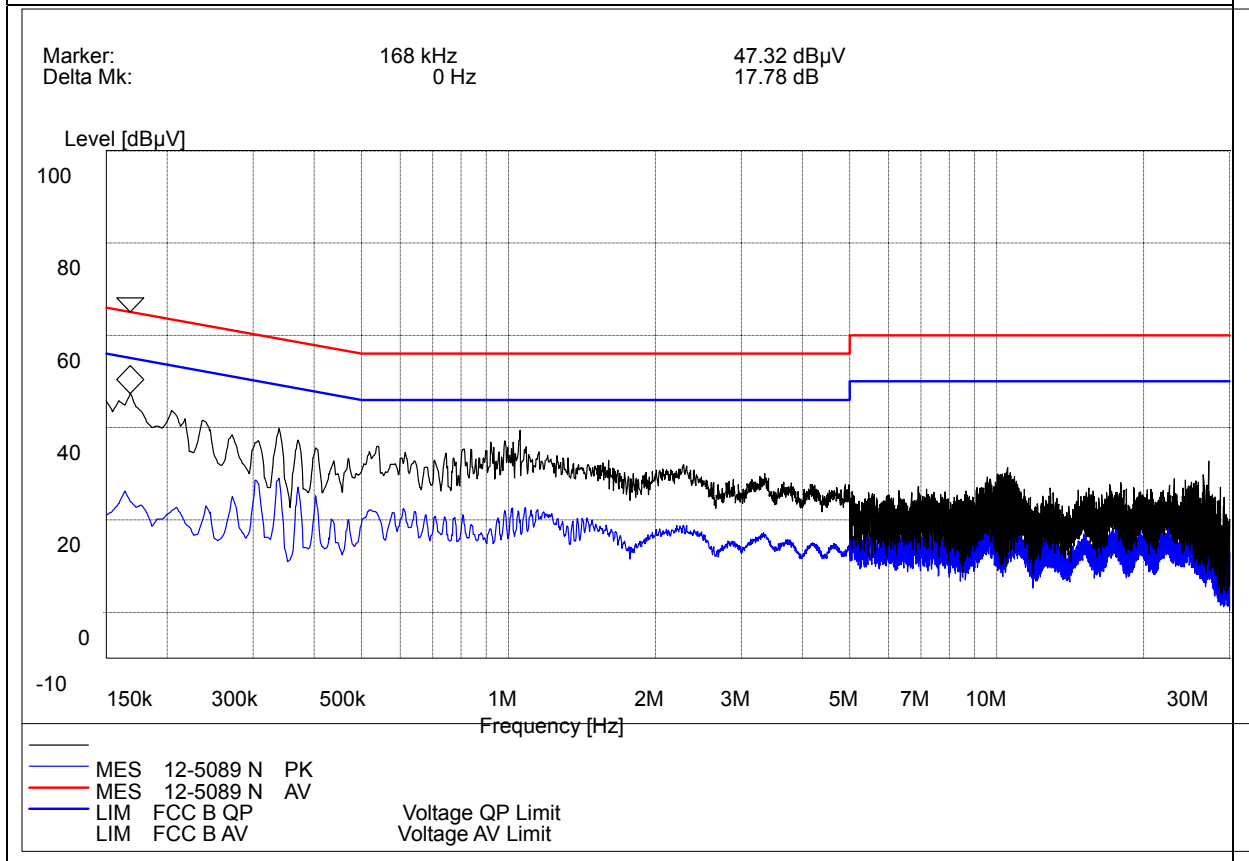

**NOTE:**

- 1 The lower limit shall apply at the transition frequencies.
- 2 If the emission levels measured with QP detector are lower than AV limits, there is unnecessary to measure with AV detector.

Conducted Disturbance at Mains Terminals							
GXP1160 Mode 1 L Test Data							
QP				AV			
Frequency (MHz)	Limits (dB $\mu$ V)	Measurement Value (dB $\mu$ V)	Margin (dB)	Frequency (MHz)	Limits (dB $\mu$ V)	Measurement Value (dB $\mu$ V)	Margin (dB)
0.5100	56	44.60	11.40	0.5100	46	Note(2)	/
0.5190	56	45.33	10.67	0.5190	46	Note(2)	/
0.5550	56	43.37	16.63	0.5550	46	Note(2)	/
5.4970	60	40.20	19.80	5.4970	50	Note(2)	/
5.5880	60	40.10	19.90	5.5880	50	Note(2)	/
5.5990	60	40.00	20.00	5.5990	50	Note(2)	/

**L Test Curve**

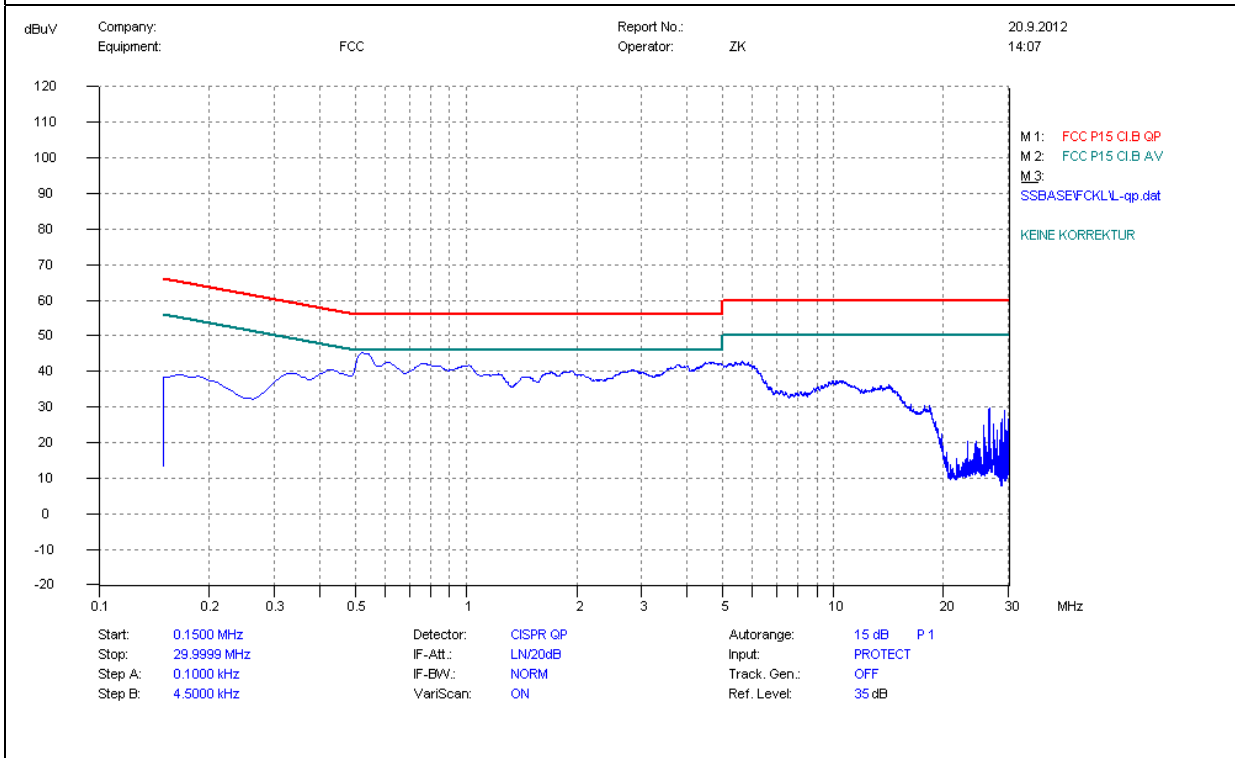

**NOTE:**

- 1 The lower limit shall apply at the transition frequencies.
- 2 If the emission levels measured with QP detector are lower than AV limits, there is unnecessary to measure with AV detector.

Conducted Disturbance at Mains Terminals							
GXP1160 Mode 1 N Test Data							
QP				AV			
Frequency (MHz)	Limits (dB $\mu$ V)	Measurement Value (dB $\mu$ V)	Margin (dB)	Frequency (MHz)	Limits (dB $\mu$ V)	Measurement Value (dB $\mu$ V)	Margin (dB)
0.5190	56	43.46	42.54	0.5190	46	Note(2)	/
0.5325	56	44.75	11.25	0.5325	46	Note(2)	/
0.5505	56	42.17	13.83	0.5505	46	Note(2)	/
5.3970	60	40.30	19.70	5.3970	50	Note(2)	/
5.4870	60	40.00	20.00	5.4870	50	Note(2)	/
5.4960	60	40.00	20.00	5.4960	50	Note(2)	/

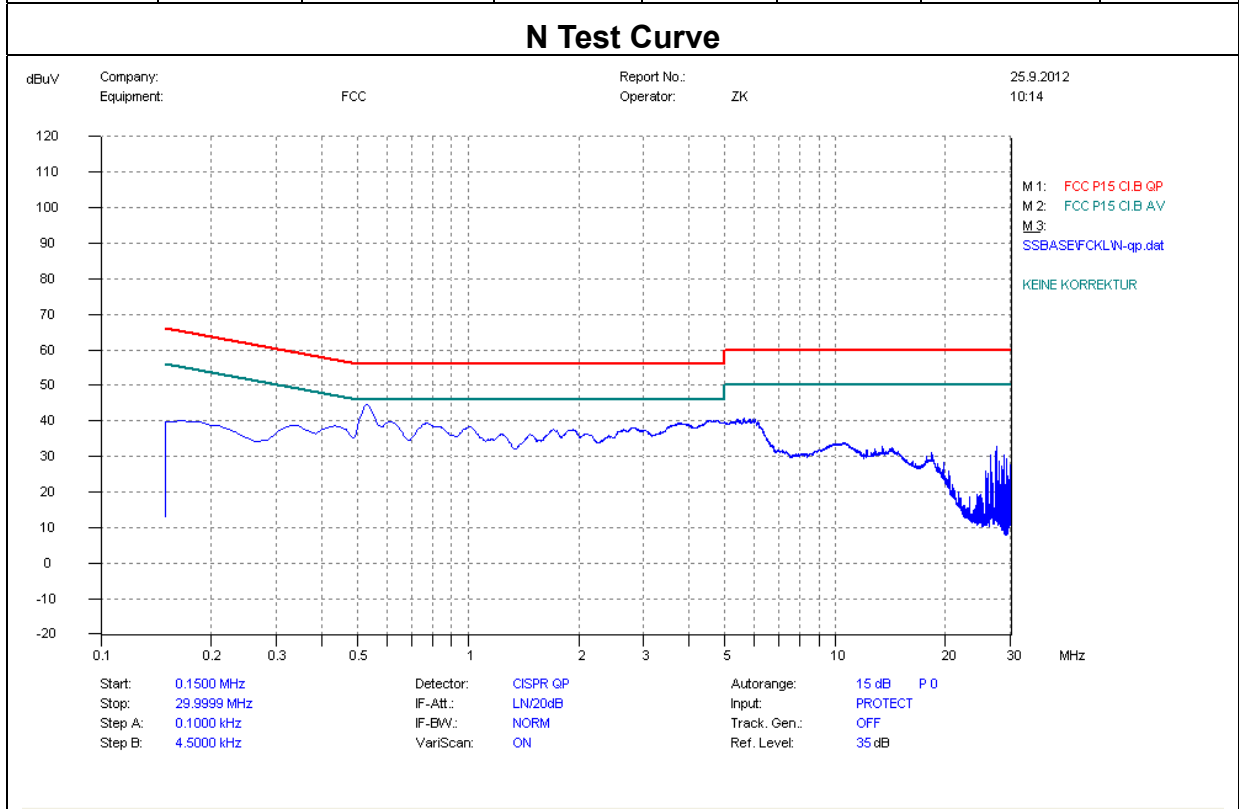

**NOTE:**

- 1 The lower limit shall apply at the transition frequencies.
- 2 If the emission levels measured with QP detector are lower than AV limits, there is unnecessary to measure with AV detector.



Conducted Disturbance at Mains Terminals							
GXP1160 Mode 3 L Test Data							
QP				AV			
Frequency (MHz)	Limits (dBµV)	Measurement Value (dBµV)	Margin (dB)	Frequency (MHz)	Limits (dBµV)	Measurement Value (dBµV)	Margin (dB)
0.7170	56	35.09	10.91	0.7170	46	Note(2)	/
0.7215	56	35.40	10.60	0.7215	46	Note(2)	/
0.7485	56	35.44	10.56	0.7485	46	Note(2)	/
0.9915	56	37.99	18.01	0.9915	46	Note(2)	/
5.7030	60	37.24	22.76	5.7030	50	Note(2)	/
5.7075	60	37.37	22.63	5.7075	50	Note(2)	/

**L Test Curve**

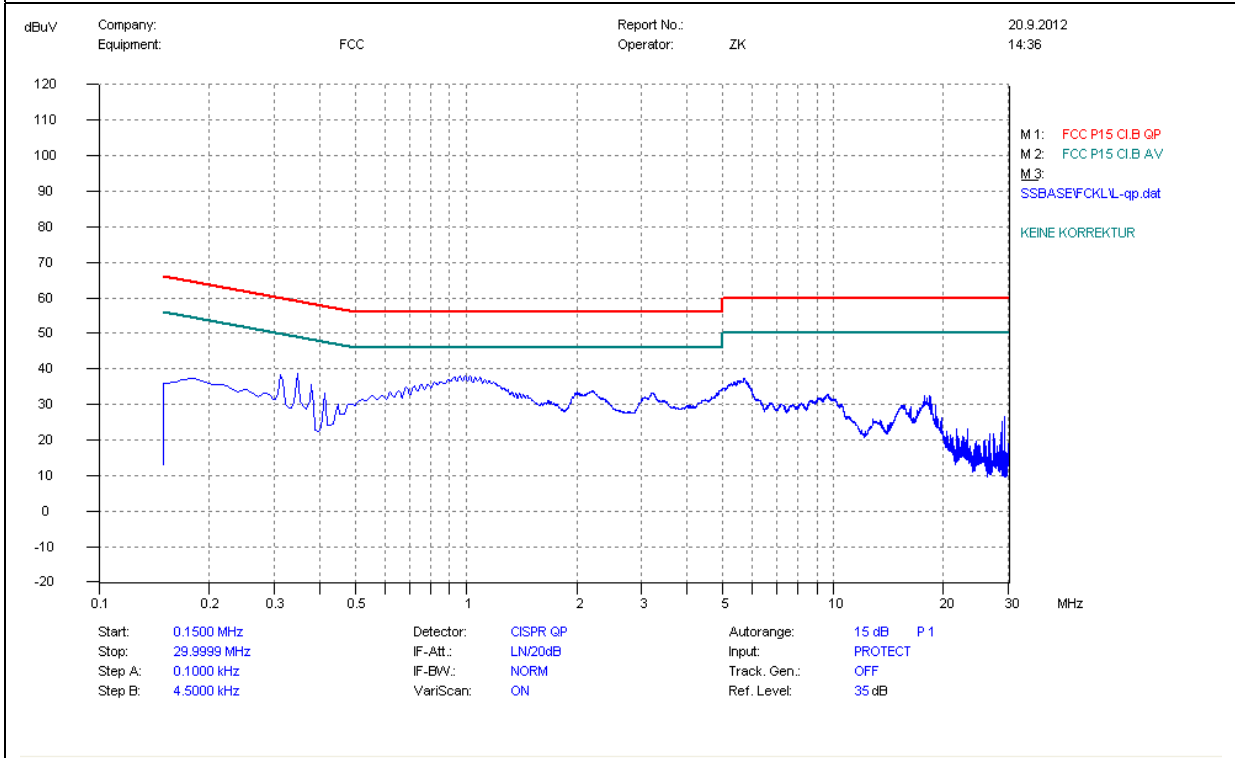

**NOTE:**

- 1 The lower limit shall apply at the transition frequencies.
- 2 If the emission levels measured with QP detector are lower than AV limits, there is unnecessary to measure with AV detector.

Conducted Disturbance at Mains Terminals							
GXP1160 Mode 3 N Test Data							
QP				AV			
Frequency (MHz)	Limits (dBμV)	Measurement Value (dBμV)	Margin (dB)	Frequency (MHz)	Limits (dBμV)	Measurement Value (dBμV)	Margin (dB)
0.3165	59.8	42.50	17.30	0.3165	49.8	Note(2)	/
0.3480	59	44.90	14.10	0.3480	49	Note(2)	/
4.8525	56	36.30	19.70	4.8525	46	Note(2)	/
5.1945	60	37.00	23.00	5.1945	50	Note(2)	/
5.3340	60	38.30	21.70	5.3340	50	Note(2)	/
5.5140	60	37.10	22.90	5.5140	50	Note(2)	/

**N Test Curve**

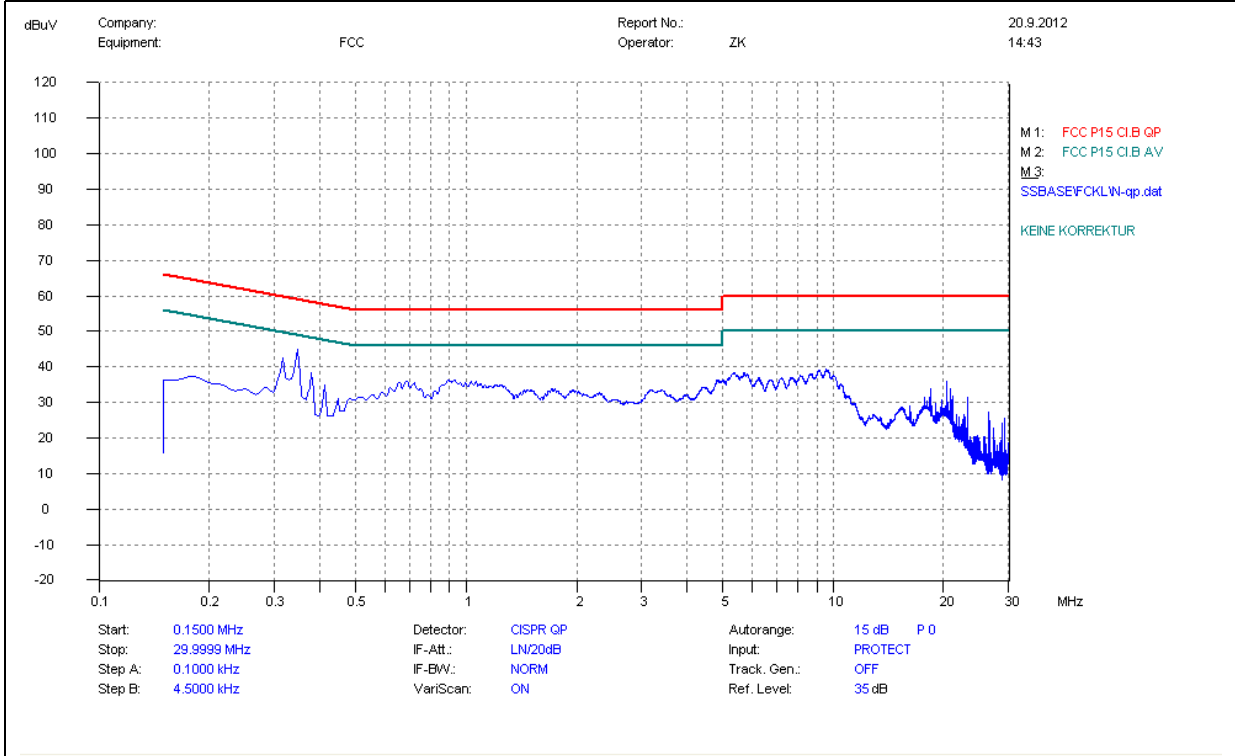

**NOTE:**

- 1 The lower limit shall apply at the transition frequencies.
2. If the emission levels measured with QP detector are lower than AV limits, there is unnecessary to measure with AV detector.

### 4.3 Radiated Disturbance Measurement

#### 4.3.1 Limits of Radiated Disturbance

The field strength of radiated emissions from unintentional radiators at a distance of 3 meters shall not exceed the following values.

Frequency of Emission (MHz)	Field Strength ( $\mu\text{V/m}$ )	Field Strength ( $\text{dB}\mu\text{V/m}$ )
30 - 88	100	40
88 -216	150	43.5
216 - 960	200	46
Above 960	500	54

NOTE:

1. Field Strength ( $\text{dB}\mu\text{V/m}$ )= $20\log$  Field Strength ( $\mu\text{V/m}$ ).
2. In the emission tables above, the tighter limit applies at the band edges.

#### 4.3.2 Test Setup

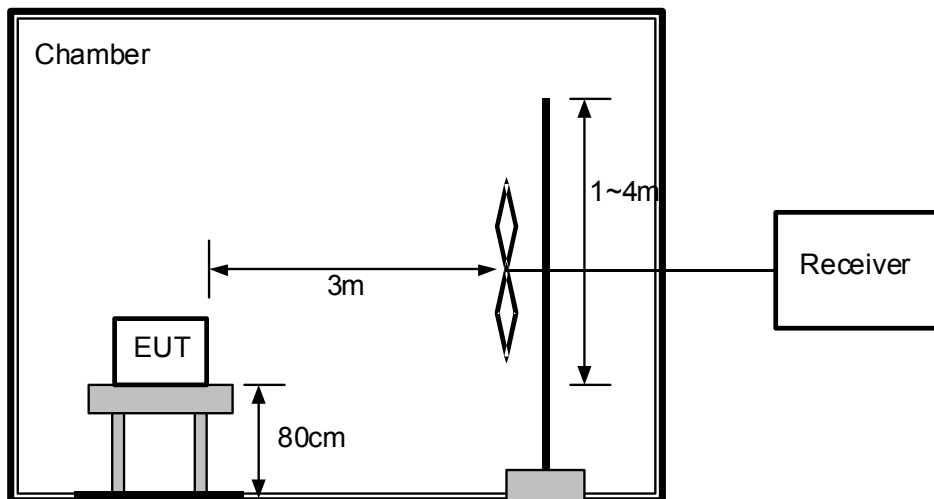

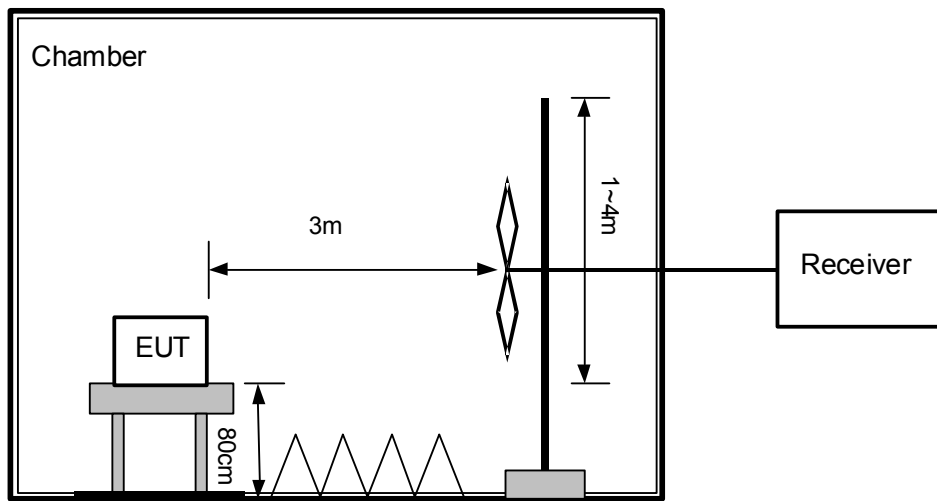

**Over 1GHz**

### 4.3.3 Test Result

#### 1. Radiated Emission Test data

##### GXP1165 Mode 1

No.	Frequency (MHz)	Antenna Polarization	Antenna Height (cm)	Table Angle (Degree)	QP Limits (dB $\mu$ V/m)	Emission Level (dB $\mu$ V/m)
1	250.01	H	150	0	46	43.85
2	414.73	H	150	0	46	43.72
3	725.75	H	150	0	46	42.95
4	47.81	V	100	0	40	36.24
5	98.51	V	100	0	43.5	31.26
6	622.09	V	100	0	46	42.39

No.	Frequency (MHz)	Antenna Polarization	Antenna Height (cm)	Table Angle (Degree)	Limit Value (dB $\mu$ V)		Emission Level (dB $\mu$ V)	
					PK	AV	PK	AV
1	1000-6000	H	100-400	0-360	74	54	<60	<45
2	1000-6000	V	100-400	0-360	74	54	<60	<45

**-Horizontal**

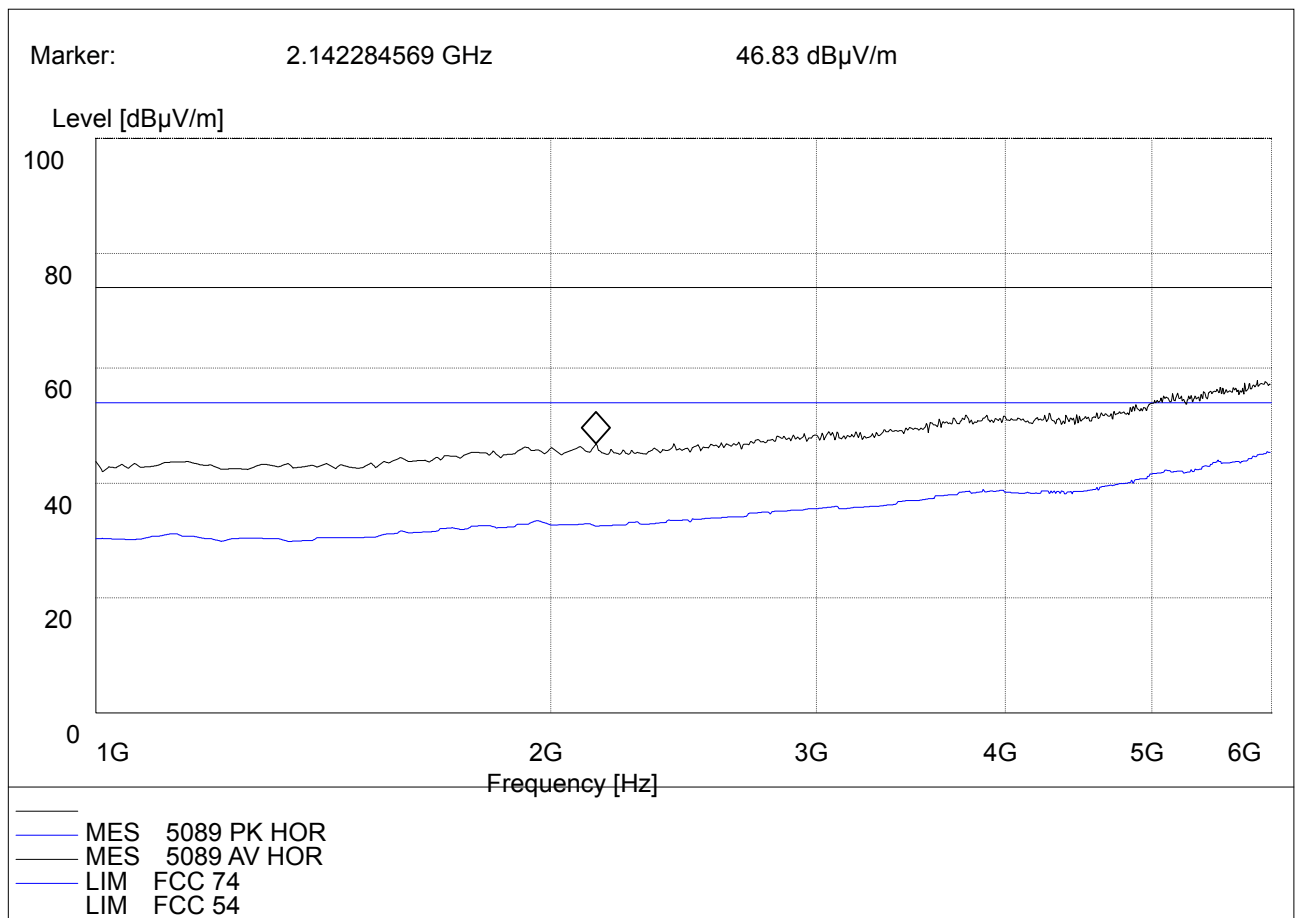
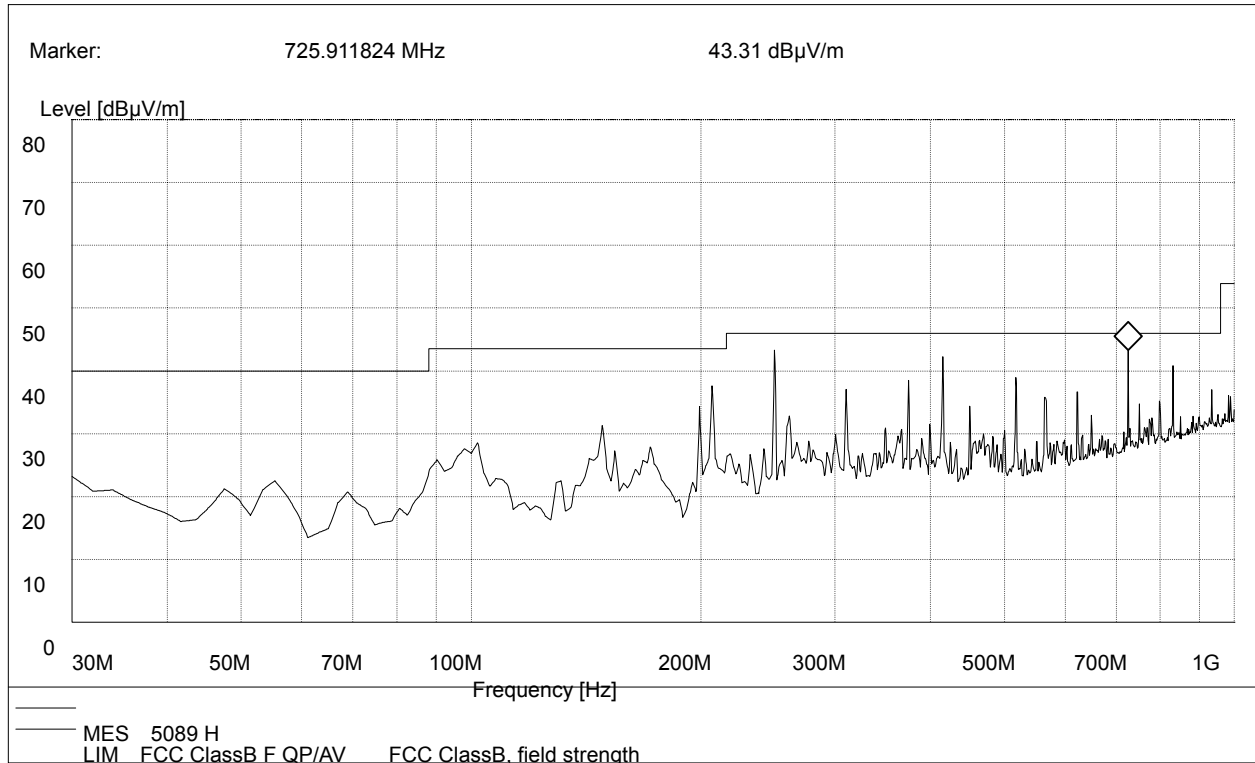

**-Vertical**

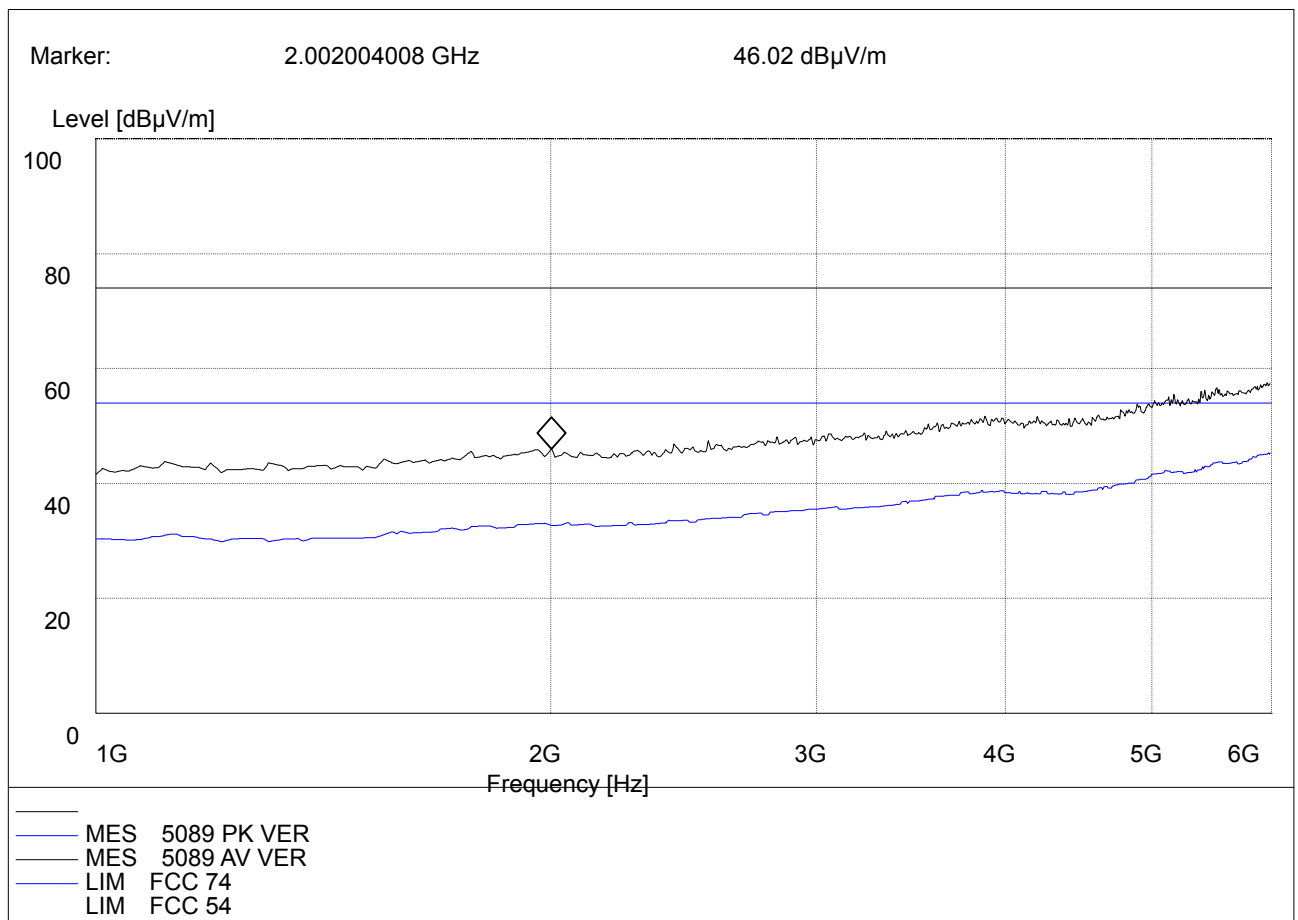
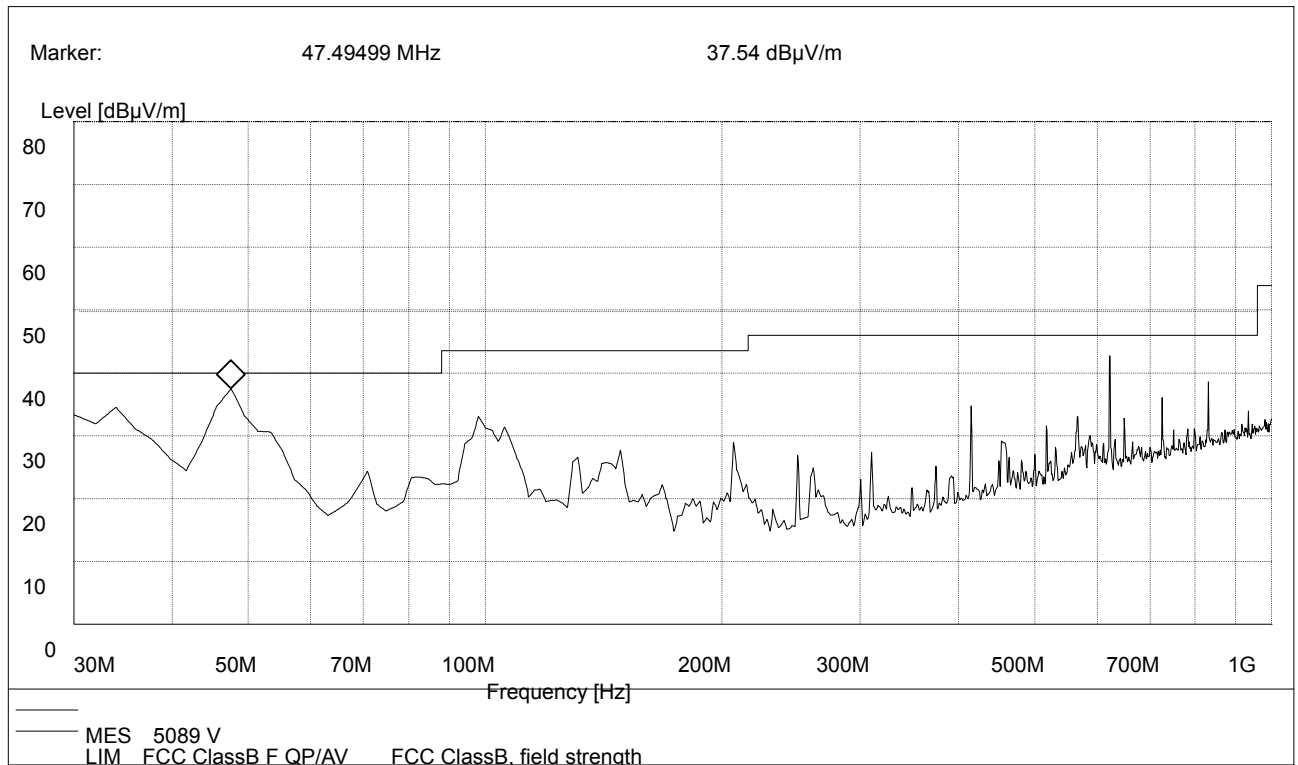

**GXP1165 Mode 2**

No.	Frequency (MHz)	Antenna Polarization	Antenna Height (cm)	Table Angle (Degree)	QP Limits (dB $\mu$ V/m)	Emission Level (dB $\mu$ V/m)
1	247.15	H	150	0	46	38.11
2	412.54	H	150	0	46	39.89
3	904.54	H	150	0	46	38.65
4	33.84	V	100	0	40	33.27
5	47.74	V	100	0	40	34.78
6	166.67	V	100	0	43.5	36.05

No.	Frequency (MHz)	Antenna Polarization	Antenna Height (cm)	Table Angle (Degree)	Limit Value (dB $\mu$ V)		Emission Level (dB $\mu$ V)	
					PK	AV	PK	AV
1	1000-6000	H	100-400	0-360	74	54	<60	<45
2	1000-6000	V	100-400	0-360	74	54	<60	<45



**-Horizontal**

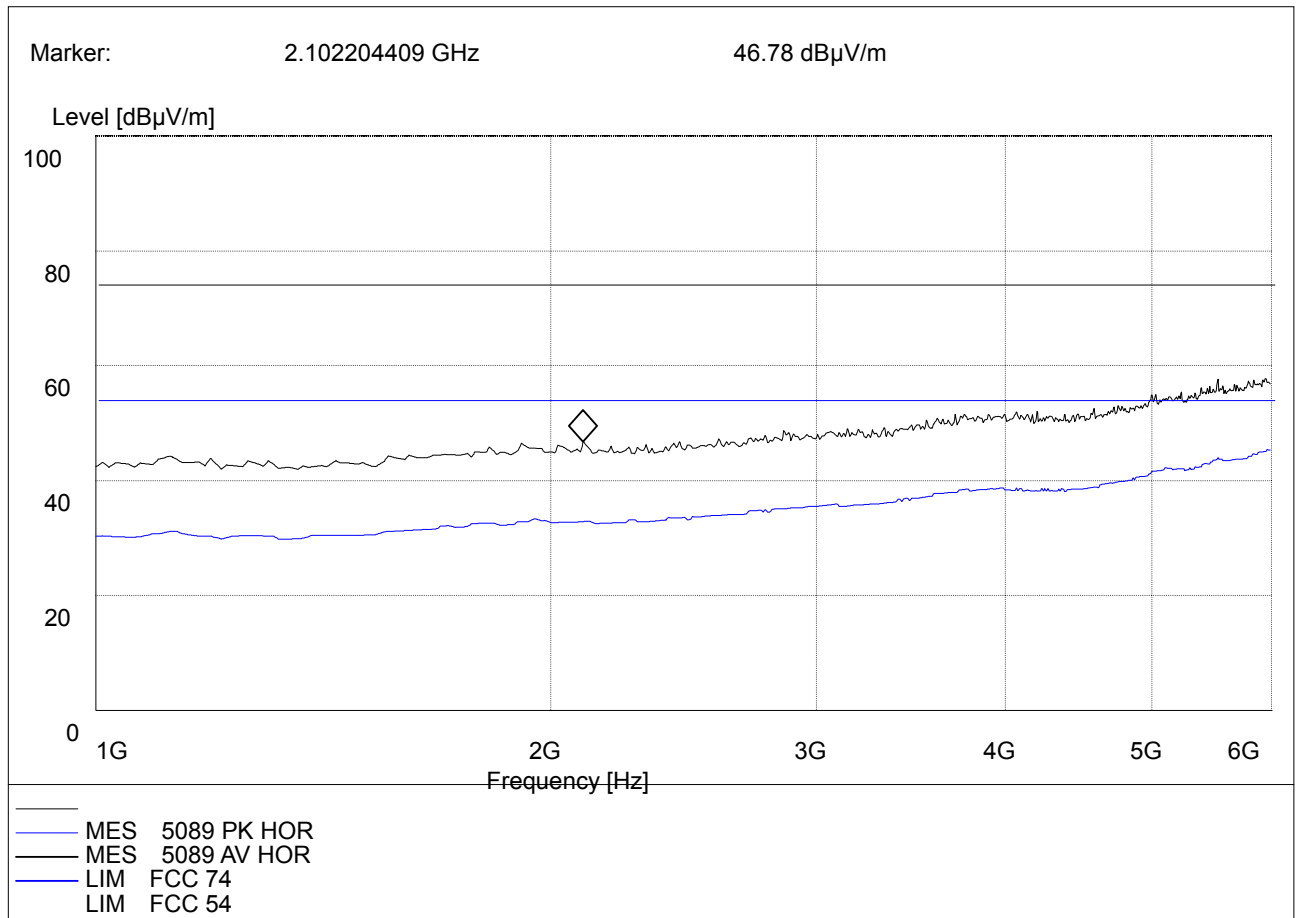
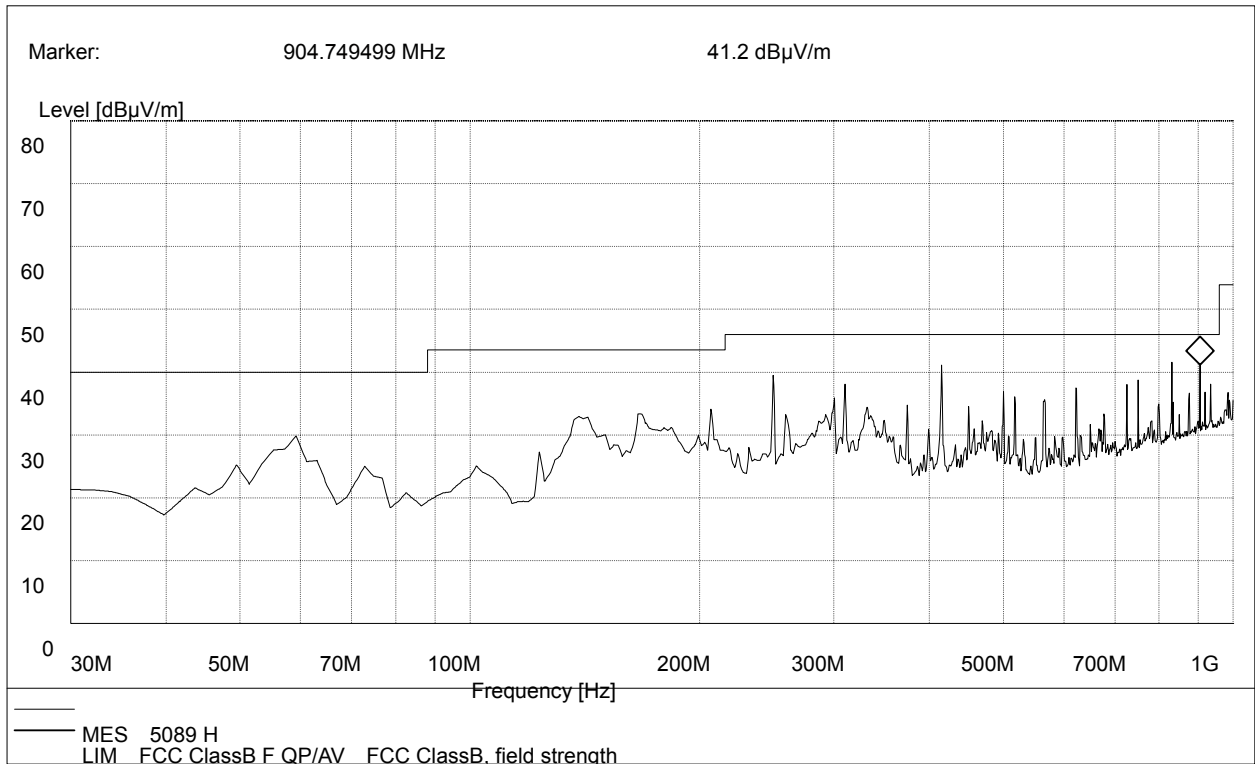

**-Vertical**

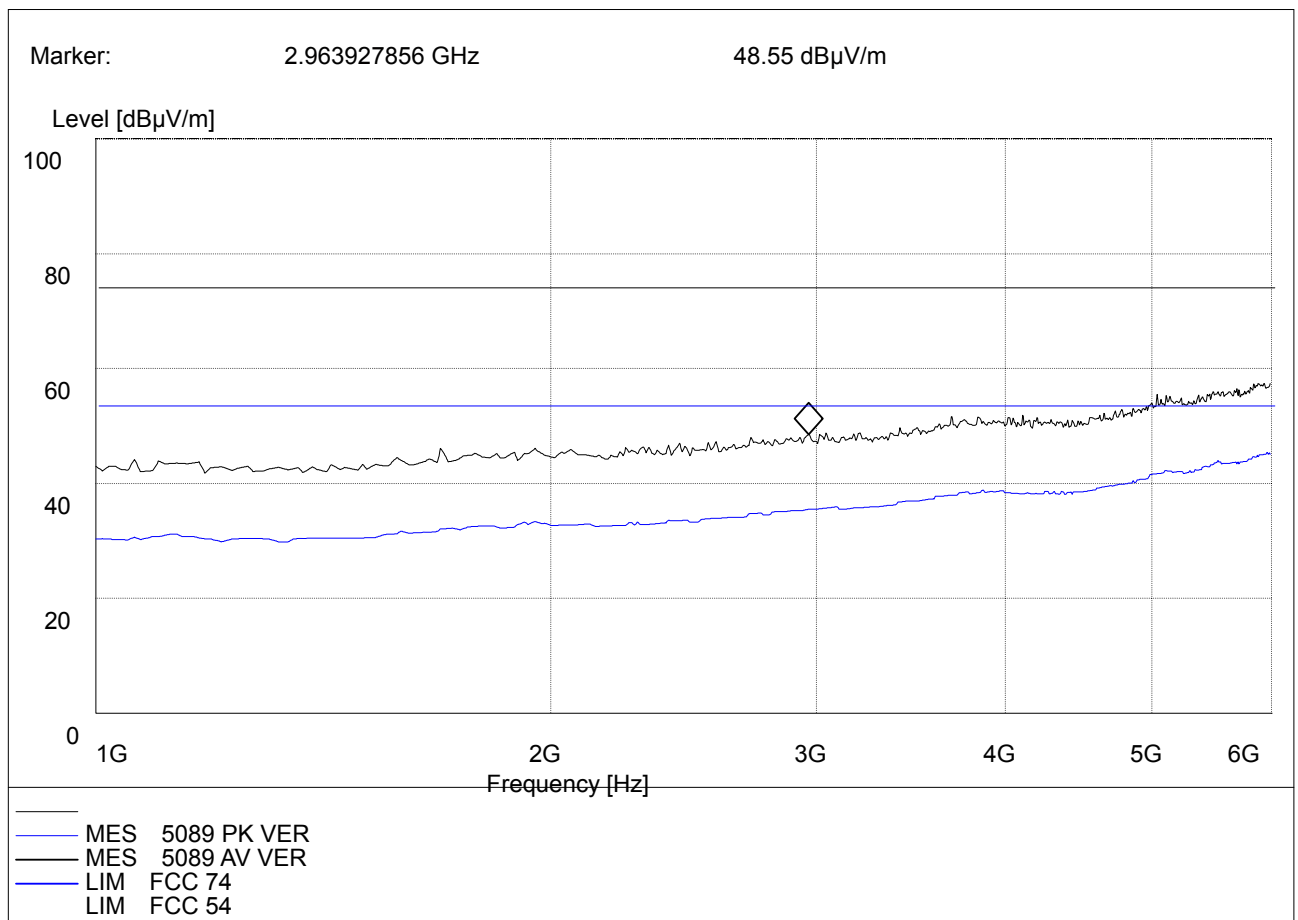
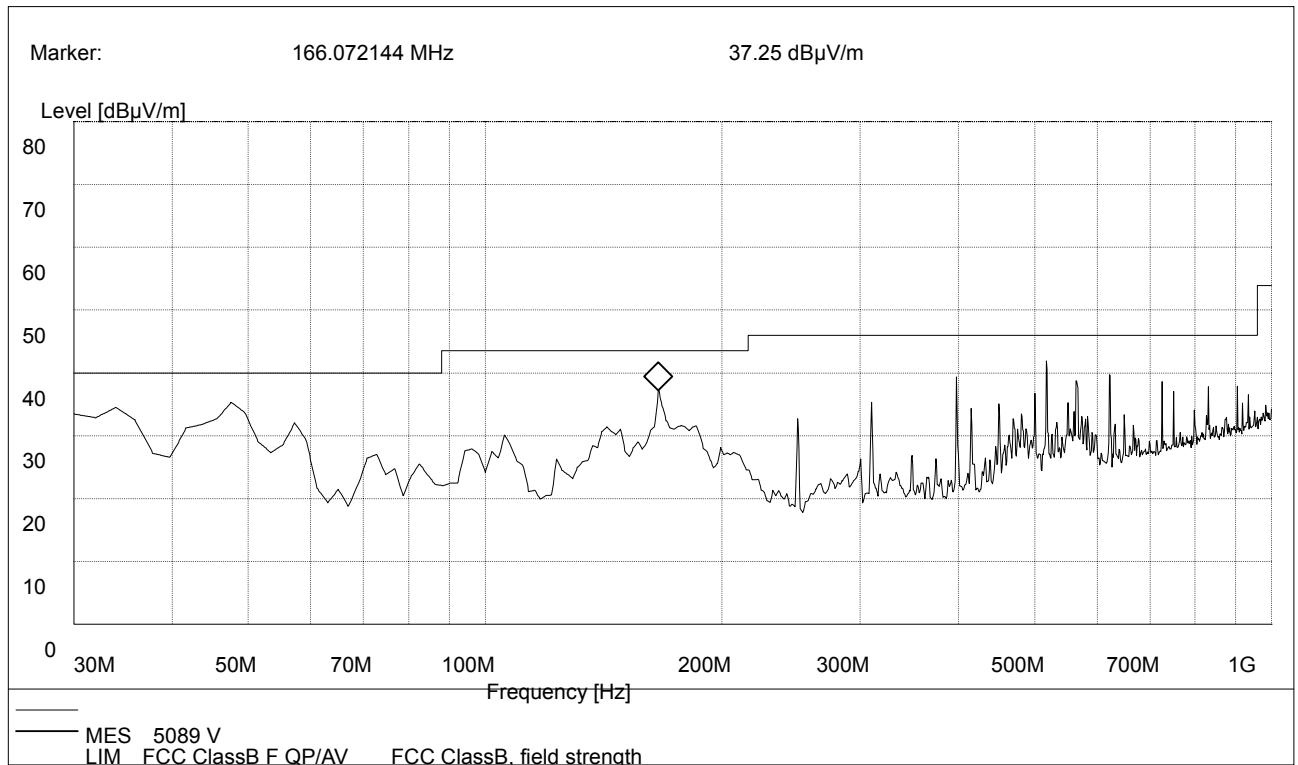

**GXP1165 Mode 3**

No.	Frequency (MHz)	Antenna Polarization	Antenna Height (cm)	Table Angle (Degree)	QP Limits (dB $\mu$ V/m)	Emission Level (dB $\mu$ V/m)
1	249.99	H	150	0	46	39.87
2	407.34	H	150	0	46	41.26
3	900.02	H	150	0	46	43.26
4	34.65	V	100	0	40	36.00
5	51.84	V	100	0	40	36.54
6	119.70	V	100	0	43.5	36.64

No.	Frequency (MHz)	Antenna Polarization	Antenna Height (cm)	Table Angle (Degree)	Limit Value (dB $\mu$ V)		Emission Level (dB $\mu$ V)	
					PK	AV	PK	AV
1	1000-6000	H	100-400	0-360	74	54	<60	<45
2	1000-6000	V	100-400	0-360	74	54	<60	<45

**-Horizontal**

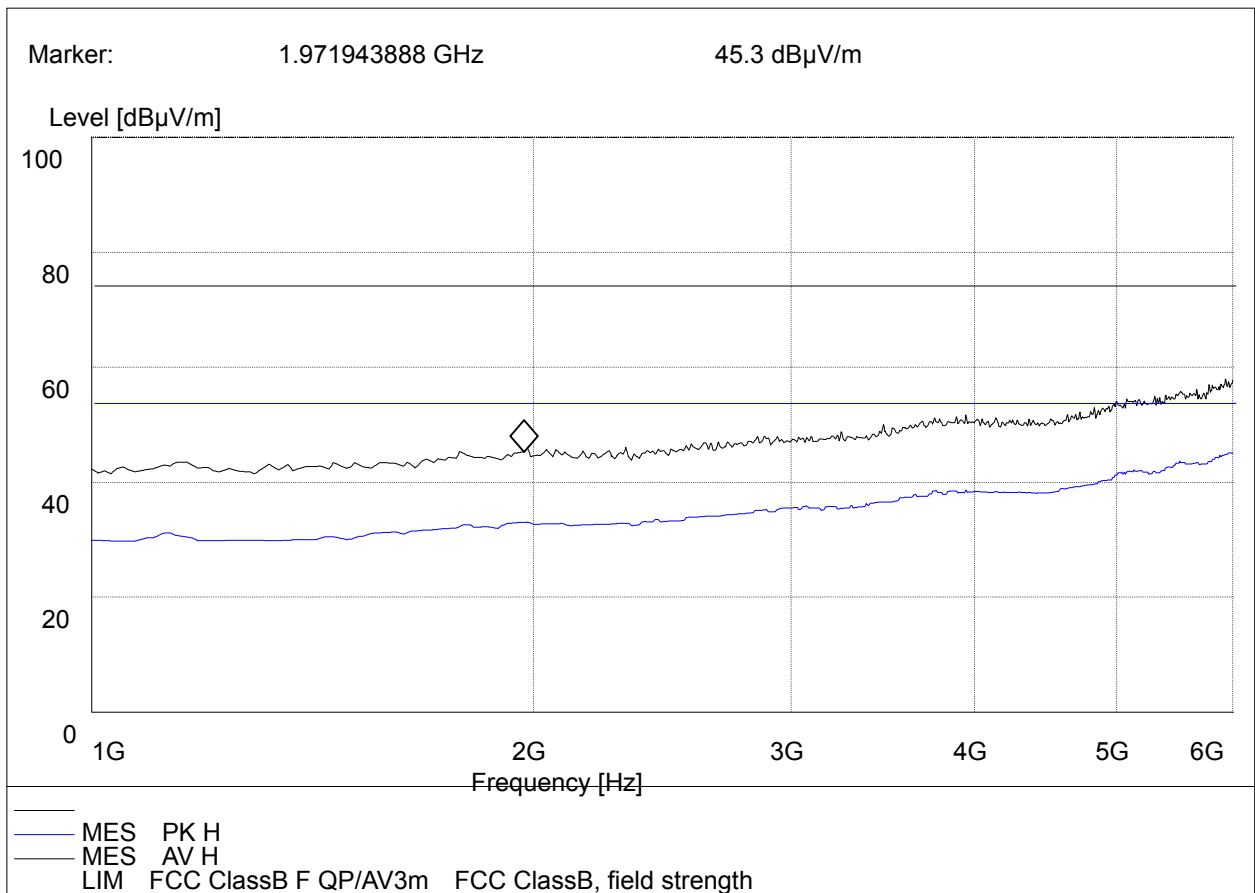
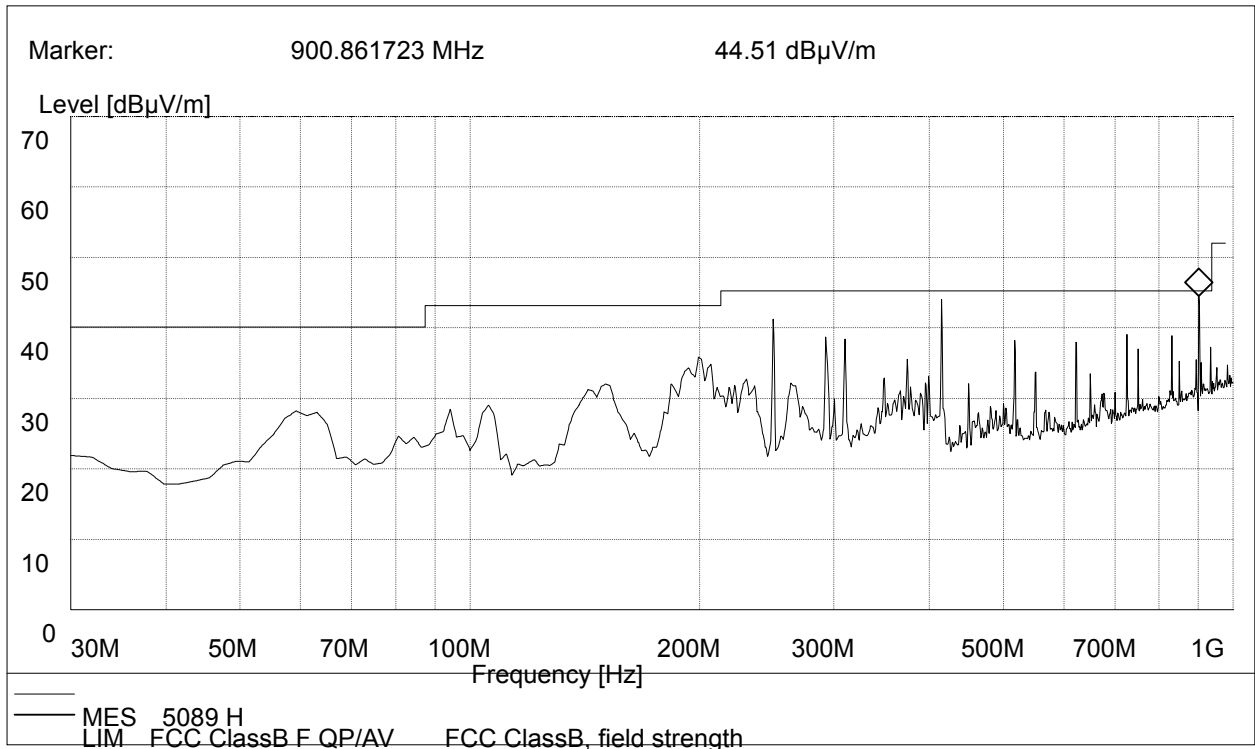

**-Vertical**

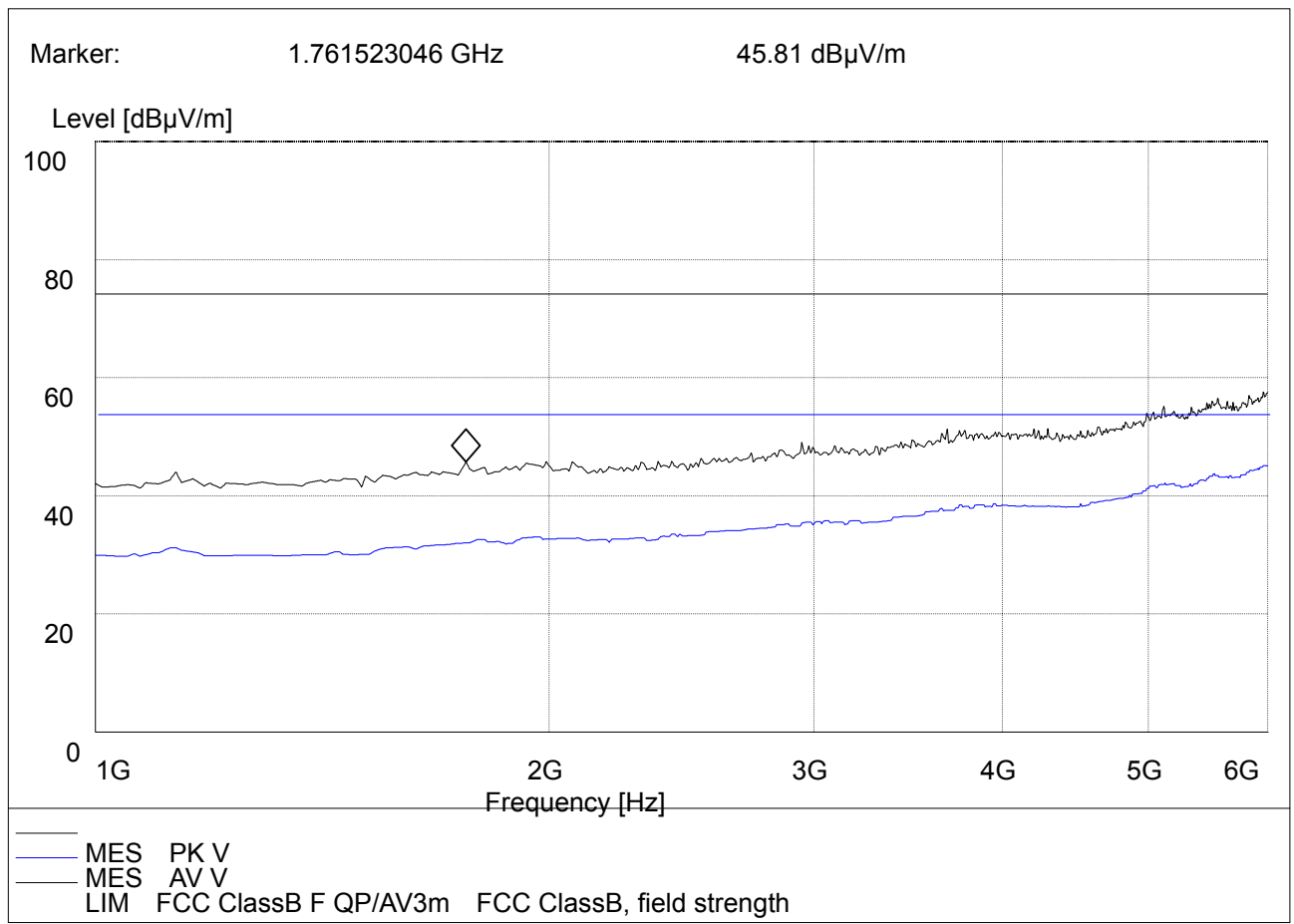
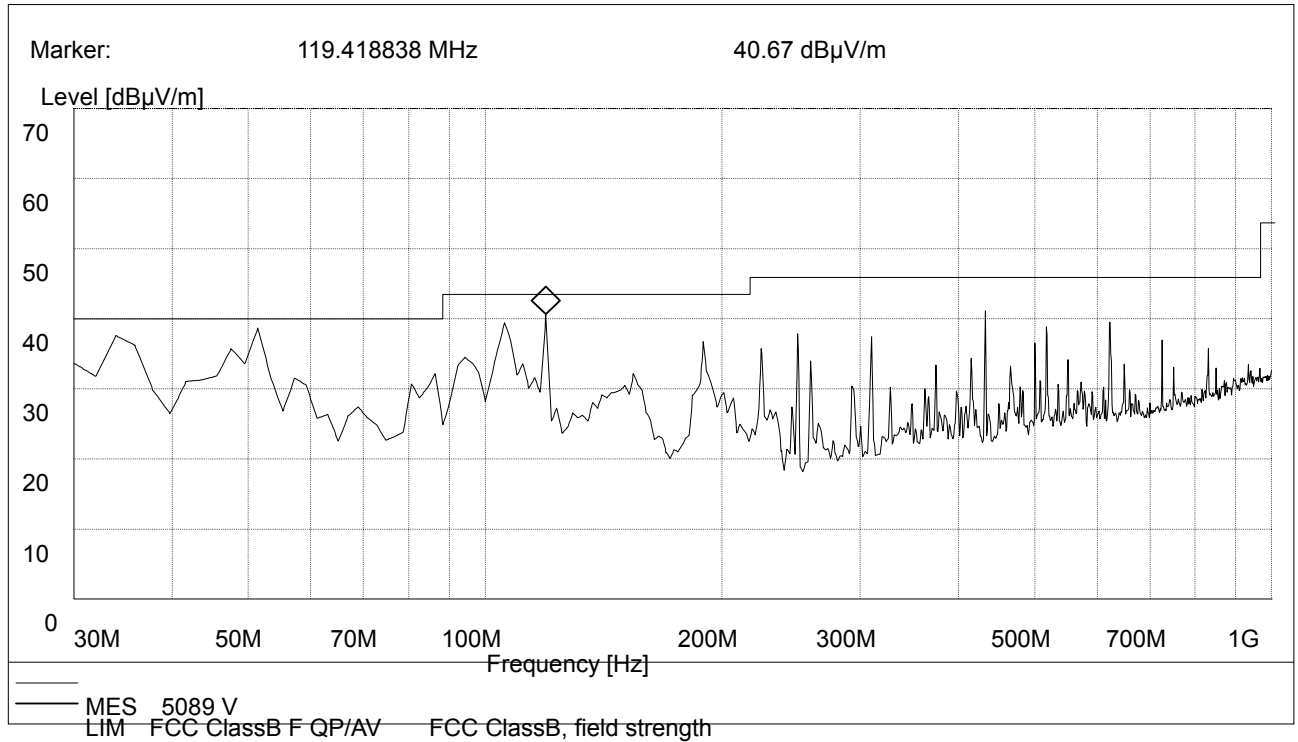

**GXP1160 Mode 1**

No.	Frequency (MHz)	Antenna Polarization	Antenna Height (cm)	Table Angle (Degree)	QP Limits (dB $\mu$ V/m)	Emission Level (dB $\mu$ V/m)
1	306.98	H	150	0	46	39.73
2	414.71	H	150	0	46	43.52
3	725.75	H	150	0	46	42.44
4	36.13	V	100	0	40	37.82
5	47.82	V	100	0	40	36.81
6	155.55	V	100	0	43.5	34.54

No.	Frequency (MHz)	Antenna Polarization	Antenna Height (cm)	Table Angle (Degree)	Limit Value (dB $\mu$ V)		Emission Level (dB $\mu$ V)	
					PK	AV	PK	AV
1	1000-6000	H	100-400	0-360	74	54	<60	<45
2	1000-6000	V	100-400	0-360	74	54	<60	<45

**-Horizontal**

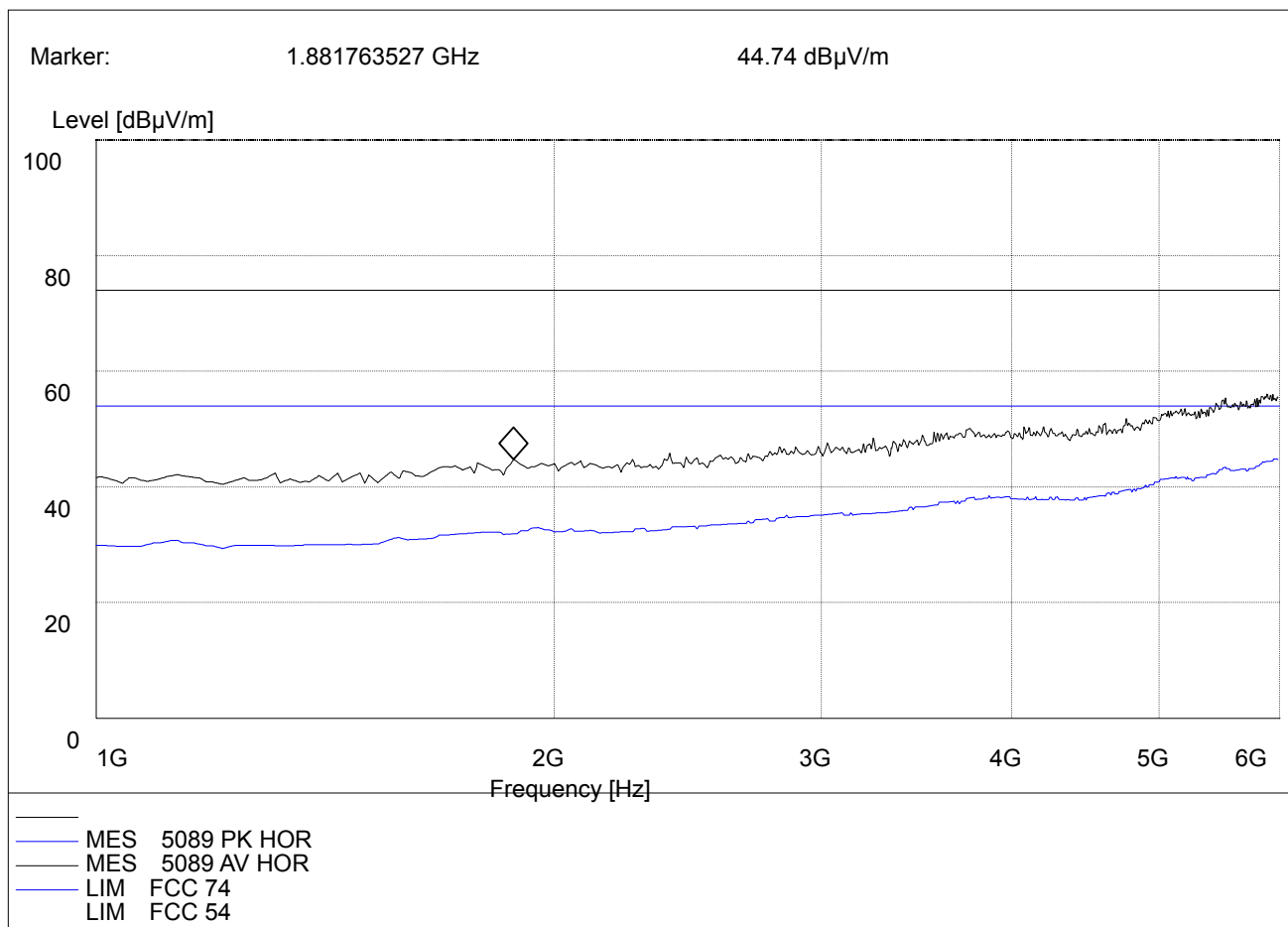
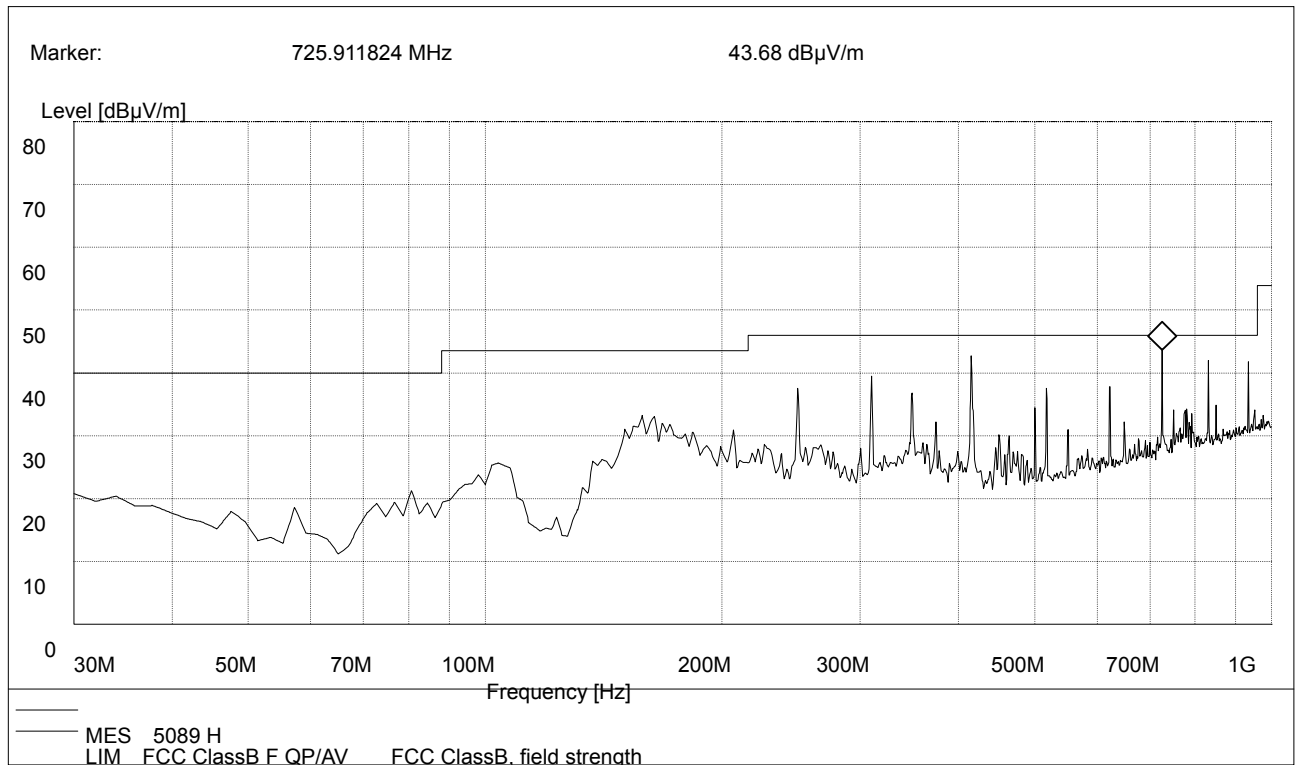

**-Vertical**

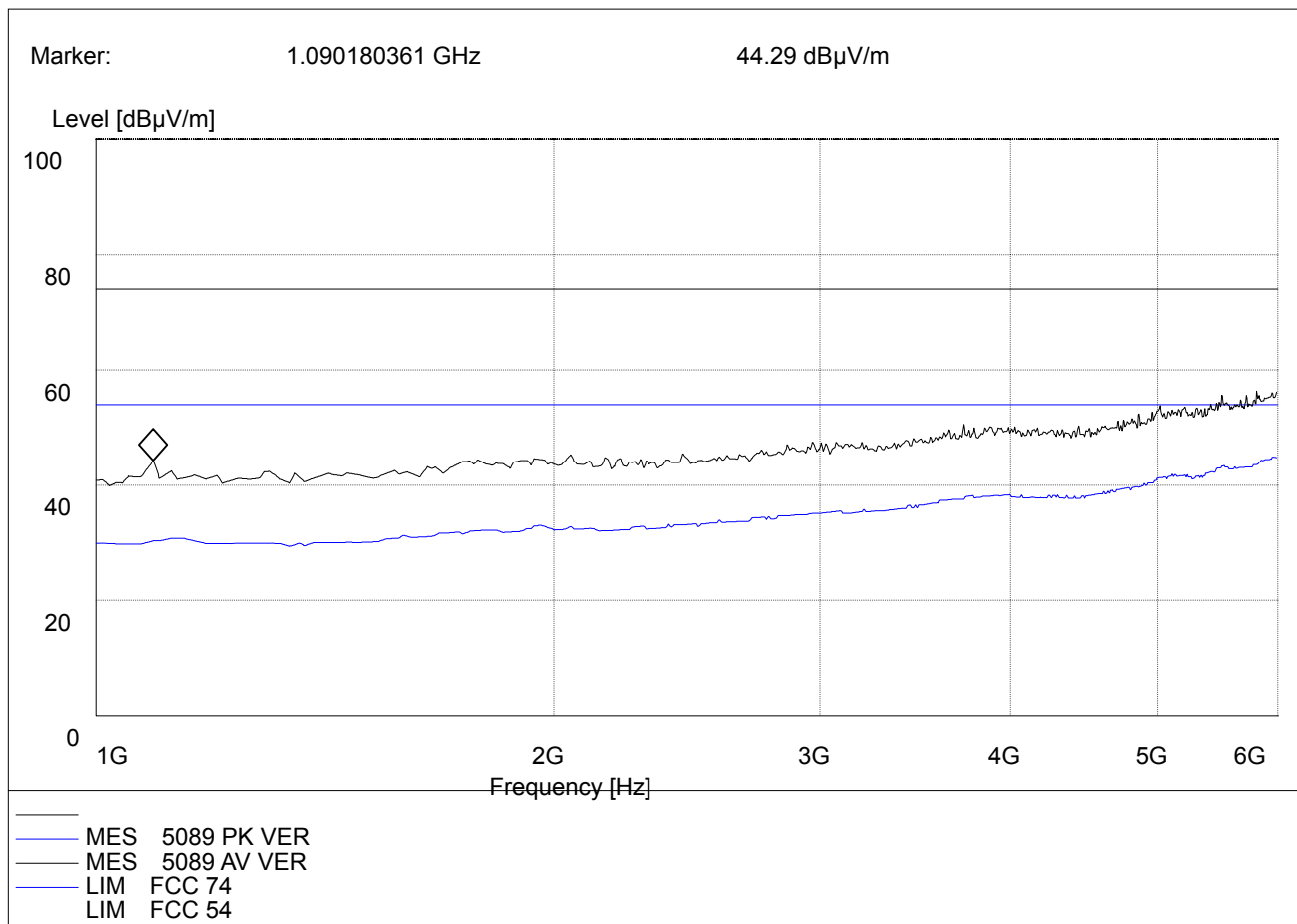
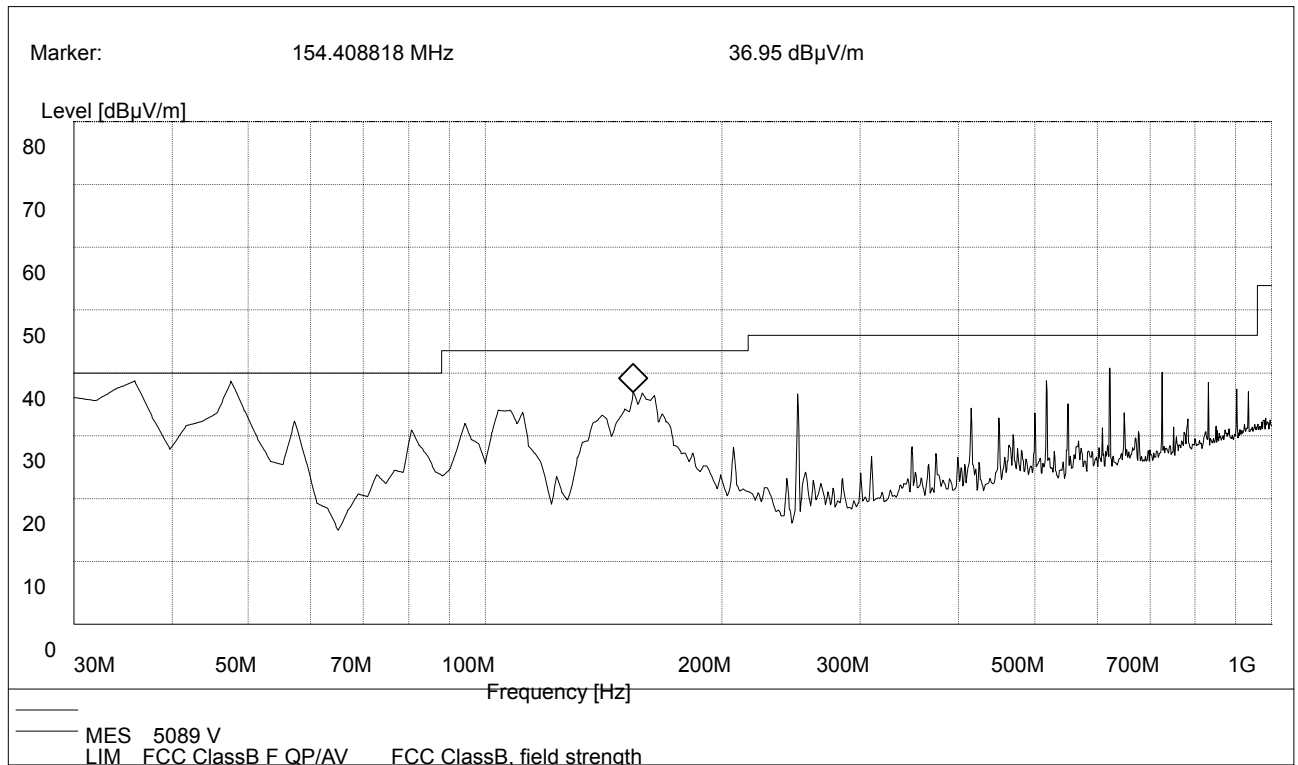



**GXP1160 Mode 3**

No.	Frequency (MHz)	Antenna Polarization	Antenna Height (cm)	Table Angle (Degree)	QP Limits (dB $\mu$ V/m)	Emission Level (dB $\mu$ V/m)
1	34.49	H	150	0	40	30.59
2	249.99	H	150	0	46	42.14
3	414.71	H	150	0	46	39.27
4	34.73	V	100	0	40	38.17
5	47.82	V	100	0	40	38.63
6	518.39	V	100	0	46	44.75

No.	Frequency (MHz)	Antenna Polarization	Antenna Height (cm)	Table Angle (Degree)	Limit Value (dB $\mu$ V)		Emission Level (dB $\mu$ V)	
					PK	AV	PK	AV
1	1000-6000	H	100-400	0-360	74	54	<60	<45
2	1000-6000	H	100-400	0-360	74	54	<60	<45

**-Horizontal**

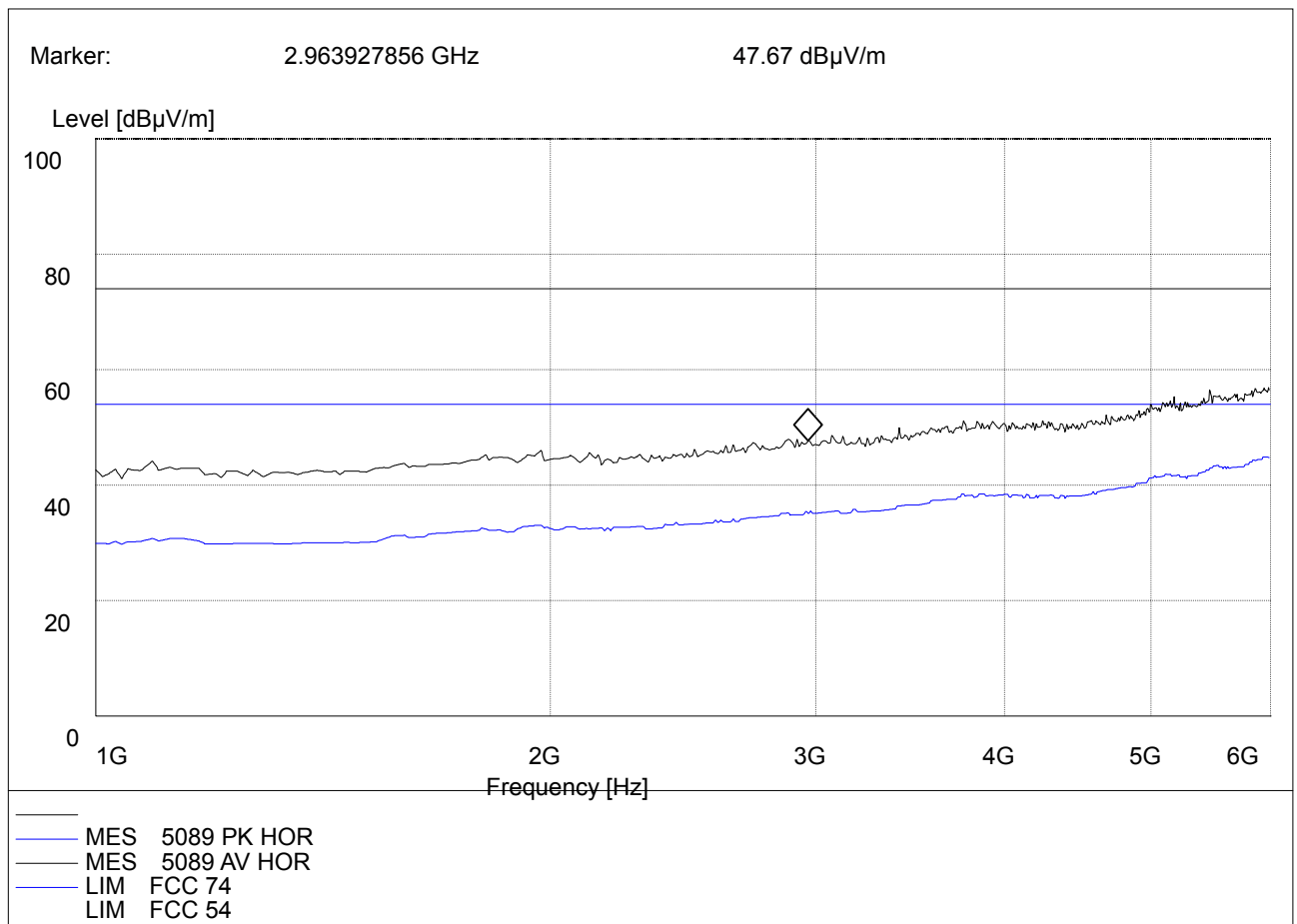
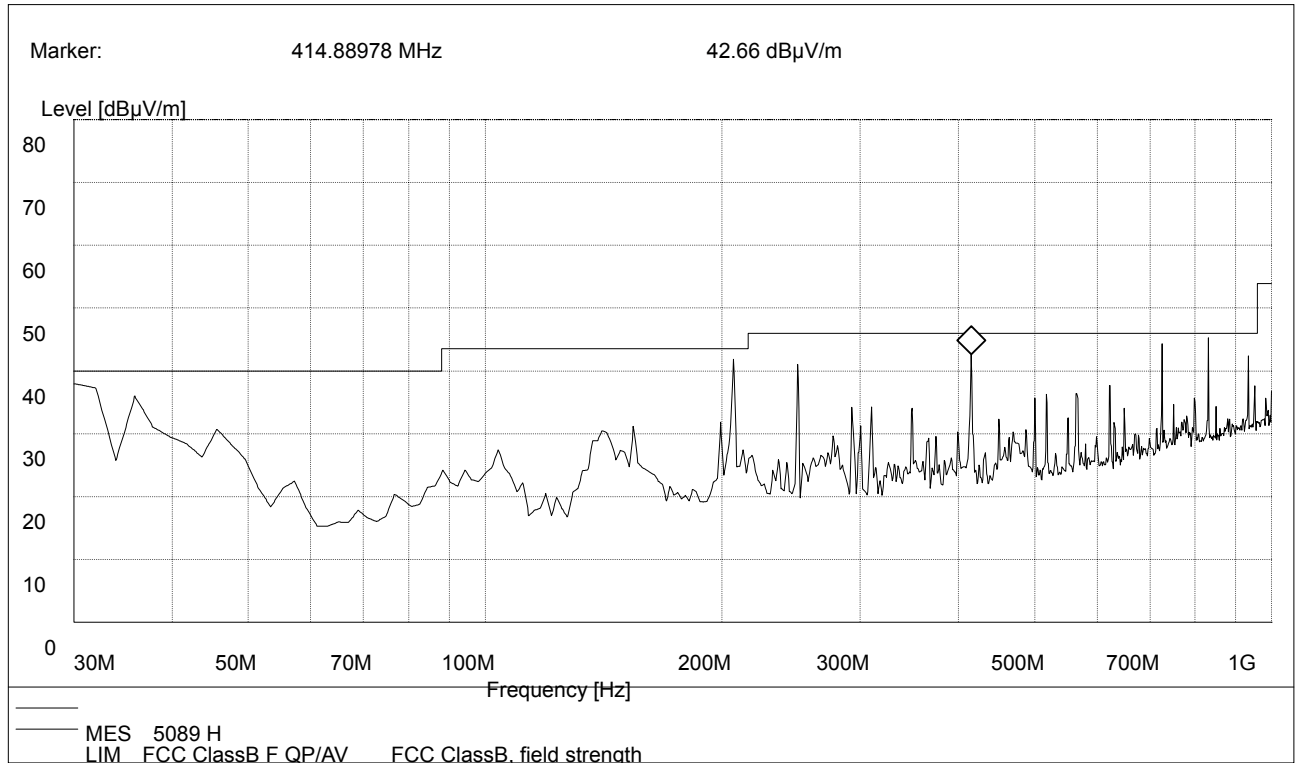

**-Vertical**

