

TEST REPORT

Applicant Name : Grandstream Networks, Inc.
 Address : 126 Brookline Ave., 3rd Floor Boston, MA 02215, USA
 Report Number : RA230620-35395E-EM-00
 FCC ID: YZZGWN7806

Test Standard (s)
 FCC PART 15B, CLASS A

Sample Description

Product Type: Enterprise Layer 2+ Managed Network Switch
 Model No.: GWN7806
 Trade Mark: GRANDSTREAM
 Date Received: 2023-06-20
 Date of Test: 2023-06-27 to 2023-06-29
 Report Date: 2023-07-05

Test Result:	Pass*
--------------	-------

* In the configuration tested, the EUT complied with the standards above.

Prepared and Checked By:

Zeki Ma

Zeki Ma
 EMC Engineer

Approved By:

Candy Li

Candy Li
 EMC Engineer

Note: This report may contain data that are not covered by the A2LA accreditation and are marked with an asterisk "★".
 Shenzhen Accurate Technology Co., Ltd. is not responsible for the authenticity of any test data provided by the applicant. Data included from the applicant that may affect test results are marked with an asterisk "*". Customer model name, addresses, names, trademarks etc. are not considered data.
 This report cannot be reproduced except in full, without prior written approval of the Company. Unless otherwise stated the results shown in this test report refer only to the sample(s) tested. This report is valid only with a valid digital signature. The digital signature may be available only under the Adobe software above version 7.0.

Shenzhen Accurate Technology Co., Ltd.

1/F., Building A, Changyuan New Material Port, Science & Industry Park, Nanshan District, Shenzhen, Guangdong, P.R. China

Tel: +86 755-26503290

Fax: +86 755-26503290

Web: www.atc-lab.com

TABLE OF CONTENTS

1. TEST RESULTS SUMMARY	5
2. GENERAL INFORMATION.....	6
2.1. Description of Device (EUT)	6
2.2. Test mode	6
2.3. General disclaimer.....	6
2.4. Accessory and Auxiliary Equipment and Cables	7
2.5. Description of Test Facility	7
2.6. Measurement Uncertainty	7
3. MEASURING DEVICE AND TEST EQUIPMENT	8
3.1. For Conducted Emission Test	8
3.2. For Radiated Emission Measurement	8
4. CONDUCTED EMISSION MEASUREMENT	9
4.1. Block Diagram of Test Setup	9
4.2. Power Line Conducted Emission Measurement Limits (Class A).....	10
4.3. Test mode description.....	10
4.4. Manufacturer	10
4.5. Operating Condition of EUT	10
4.6. Test Procedure.....	11
4.7. Data Explain	11
4.8. Power Line Conducted Emission Measurement Results	11
5. RADIATED EMISSION MEASUREMENT	18
5.1. Block Diagram of Test Setup	18
5.2. Radiated Emission Limit (Class A).....	19
5.3. Test mode description.....	20
5.4. Manufacturer	20
5.5. Operating Condition of EUT	20
5.6. Test Procedure.....	21
5.7. Data Sample.....	21
5.8. Radiated Emission Measurement Result.....	21

DOCUMENT REVISION HISTORY

Revision Number	Report Number	Description of Revision	Date of Revision
0	RA230620-35395E-EM-00	Original Report	2023-07-05

Test Report Declaration

Applicant : Grandstream Networks, Inc.
Manufacturer : Grandstream Networks, Inc.
Product : Enterprise Layer 2+ Managed Network Switch
Model No. : GWN7806
Trade Mark : GRANDSTREAM

Measurement Procedure Used:

FCC Rules and Regulations Part 15 Subpart B Class A ANSI C63.4-2014

The device described above is tested by Shenzhen Accurate Technology Co., Ltd. to determine the maximum emission levels emanating from the device. The maximum emission levels are compared to the FCC Part 15 Subpart B Class A limits both radiated and conducted emissions. The measurement results are contained in this test report and Shenzhen Accurate Technology Co., Ltd. is assumed full responsibility for the accuracy and completeness of these measurements. Also, this report shows that the Equipment Under Test (EUT) is to be technically compliant with the FCC requirements.

This report applies to above tested sample only. This report shall not be reproduced in part without written approval of Shenzhen Accurate Technology Co., Ltd.

1. TEST RESULTS SUMMARY

Test Items	Test Standard	Test Results
Conducted Emission (150kHz-30MHz)	FCC Part 15 Subpart B, Section 15.107	Pass
Radiated Emission (30-1000MHz)	FCC Part 15 Subpart B, Section 15.109	Pass
Radiated Emission (Above 1GHz)	FCC Part 15 Subpart B, Section 15.109	Pass

2. GENERAL INFORMATION

2.1. Description of Device (EUT)

Product	: Enterprise Layer 2+ Managed Network Switch
Model No.	: GWN7806
Rating	: AC 100-240V, 50-60Hz (Note: The AC line length is 1.1meters.)
Remark(s)	: The EUT highest operating frequency is 1000MHz, the radiated emission measurement shall be made up to 5.0GHz
Applicant	: Grandstream Networks, Inc.
Address	: 126 Brookline Ave., 3rd Floor Boston, MA 02215, USA
Manufacturer	: Grandstream Networks, Inc.
Address	: 126 Brookline Ave., 3rd Floor Boston, MA 02215, USA
Sample Number	: 2749-1
Note	: This product can configure with three different power module, R0070B, ADO-60W1 13 and PA-1061-13H1.

2.2. Test mode

- Test mode 1: System operation with Full load (Power module: R0070B)
- Test mode 2: System operation with Full load (Power module: ADO-60W1 13)
- Test mode 3: System operation with Full load (Power module: PA-1061-13H1)

2.3. General disclaimer

1. Each test item follows test standard and with no deviation.
2. The test results presented in this report relate only to the object tested. The information supplied by the customer can affect the validity of results.

2.4. Accessory and Auxiliary Equipment and Cables

Notebook1	:	Model: Dell 7530 S/N: FKLWV32
Notebook2	:	Model: Lenovo T430 S/N: PBMKKWL
Optical fiber*3	:	Optical fiber length is 110 cm.
Long network cable*2	:	The length is 1.5M.
Short network cable*23	:	Short network cable length is 10cm.

2.5. Description of Test Facility

Name of Firm	:	Shenzhen Accurate Technology Co., Ltd.
Site Location	:	Floor 1, KuMaKe Building, Dongzhou Community, Guangming Street, Guangming District, Shenzhen, Guangdong, China

2.6. Measurement Uncertainty

Conduction Emission Expanded Uncertainty (150kHz-30MHz)	:	$U=2.74dB, k=2$
Radiated emission expanded uncertainty (30MHz-1000MHz)	:	$U=5.08dB, k=2$
Radiated emission expanded uncertainty (1GHz-18GHz)	:	$U=4.96dB, k=2$

3. MEASURING DEVICE AND TEST EQUIPMENT

3.1. For Conducted Emission Test

Item	Equipment	Manufacturer	Model No.	Serial No.	Calibration Date	Calibration Due Date
1.	EMI Test Receiver	Rohde& Schwarz	ESCI	100784	2022/11/25	2023/11/24
2.	L.I.S.N.	Rohde& Schwarz	ENV216	101314	2022/11/25	2023/11/24
3.	50 Coaxial Switch	Anritsu Corp	MP59B	6100237248	2022/12/07	2023/12/06
4.	RF Coaxial Cable	Unknown	No.17	N0350	2022/11/25	2023/11/24
5.	Conducted Emission Test Software: e3 191218 (V9)					

3.2. For Radiated Emission Measurement

Item	Equipment	Manufacturer	Model No.	Serial No.	Calibration Date	Calibration Due Date
1.	Test Receiver	Rohde& Schwarz	ESR	102725	2022/11/25	2023/11/24
2.	Spectrum Analyzer	Rohde&Schwarz	FSV40	101949	2022/11/25	2023/11/24
3.	Amplifier	SONOMA INSTRUMENT	310 N	186131	2022/11/08	2023/11/07
4.	Preamplifier	A.H. Systems, inc.	PAM-0118P	135	2022/11/08	2023/11/07
5.	Bilog Antenna	Schwarzbeck	VULB9163	9163-194	2023/02/14	2026/02/13
6.	Horn Antenna	Schwarzbeck	BBHA9120D	837	2023/02/22	2026/02/21
7.	RF Coaxial Cable	Unknown	No.10	N050	2022/11/25	2023/11/24
8.	RF Coaxial Cable	Unknown	No.11	N1000	2022/11/25	2023/11/24
9.	RF Coaxial Cable	Unknown	No.12	N040	2022/11/25	2023/11/24
10.	RF Coaxial Cable	Unknown	No.13	N300	2022/11/25	2023/11/24
11.	RF Coaxial Cable	Unknown	No.14	N800	2022/11/25	2023/11/24
12.	Radiated Emission Test Software: e3 191218 (V9)					

4. CONDUCTED EMISSION MEASUREMENT

4.1. Block Diagram of Test Setup

4.1.1. Block diagram of connection between the EUT and simulators

Test Mode 1&2&3:

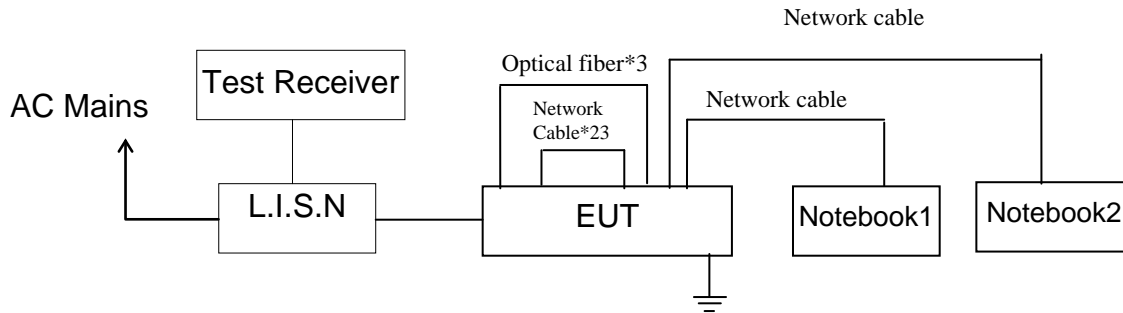

4.1.2. Test System Setup

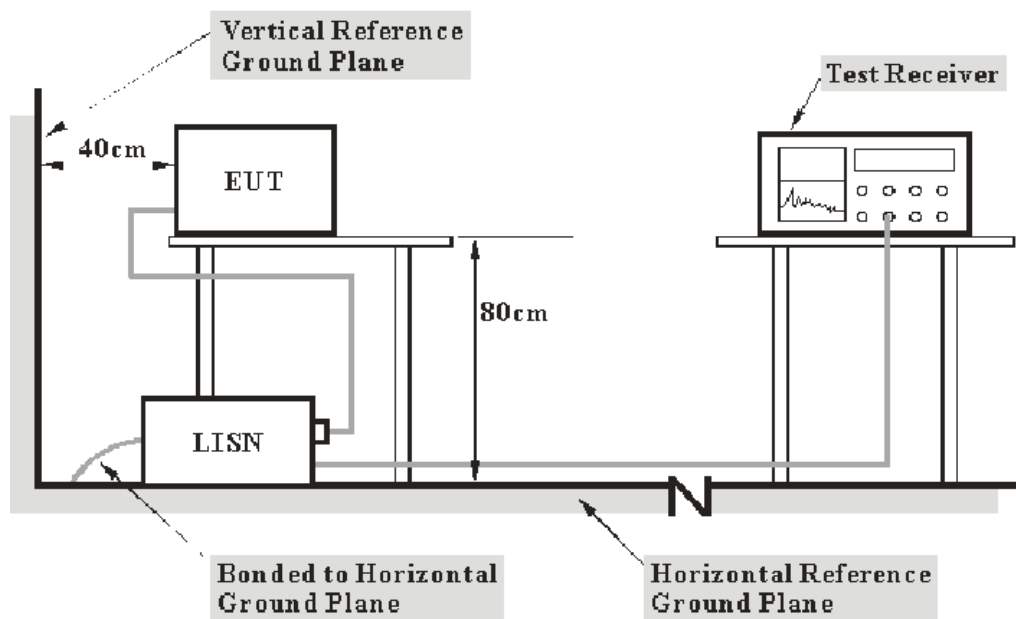

- Note: 1. Support units were connected to second LISN.
 2. Both of LISNs (AMN) 80 cm from EUT and at the least 80 cm from other units and other metal planes support units.

4.2. Power Line Conducted Emission Measurement Limits (Class A)

Frequency (MHz)	Limit dB(μ V)	
	Quasi-peak Level	Average Level
0.15 - 0.50	79.0	66.0
0.50 - 30.00	73.0	60.0

NOTE1: The lower limit shall apply at the transition frequencies.

4.3. Test mode description

Test mode 1: System operation with Full load (Power module: R0070B)

Test mode 2: System operation with Full load (Power module: ADO-60W1 13)

Test mode 3: System operation with Full load (Power module: PA-1061-13H1)

4.3.1. Environmental Conditions

Temperature : 23°C

Relative Humidity : 48%

ATM Pressure : 101kPa

The testing was performed by Jerry Wu on 2023-06-29.

4.4. Manufacturer

The following equipments are installed on Power Line Conducted Emission Measurement to meet the commission requirement and operating regulations in a manner, which tends to maximize its emission characteristics in a normal application.

4.4.1. Enterprise Layer 2+ Managed Network Switch (EUT)

Model Number : GWN7806

Manufacturer : Grandstream Networks, Inc.

4.5. Operating Condition of EUT

4.5.1. Setup the EUT and simulator as shown as Section 4.1.

4.5.2. Turn on the power of all equipments.

4.5.3. Let the EUT work in test mode and measure it.

4.6. Test Procedure

The EUT is put on the plane 0.8m high above the ground by insulating support and is connected to the power mains through a line impedance stabilization network (L.I.S.N.). This provides a 50ohm coupling impedance for the EUT system. Please refer the block diagram of the test setup and photographs. Both sides of AC lines are checked to find out the maximum conducted emission. In order to find the maximum emission levels, the relative positions of equipment and all of the interface cables shall be changed according to ANSI C63.4-2014 on Conducted Emission Measurement.

The bandwidth of test receiver is set at 9kHz.

The frequency range from 150kHz to 30MHz is checked.

4.7. Data Explain

Over limit = Level (dB μ V) - Limit (dB μ V)

4.8. Power Line Conducted Emission Measurement Results

PASS.

The frequency range from 150kHz to 30MHz is checked.

All data was recorded in the Quasi-peak and average detection mode.

The spectral diagrams are attached as below.

Test mode 1:

AC 120V/60Hz, Line:

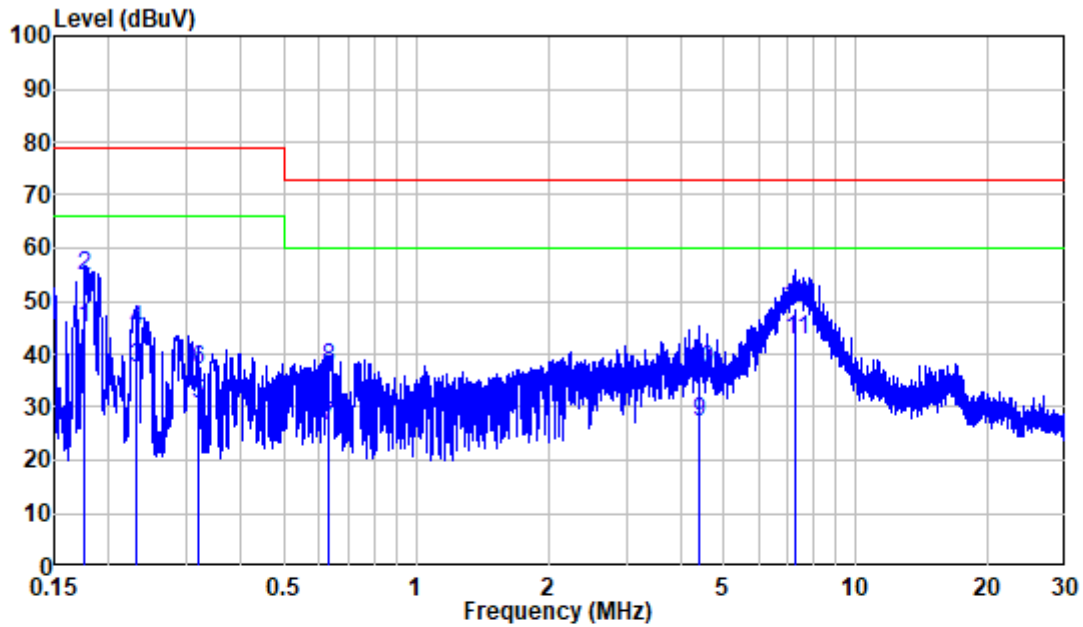

Site : Shielding Room
 Condition: Line
 Job No. : RA230620-35395E-EM
 Mode : System operation with Full load
 Note : R0070B

	Freq	Factor	Read Level	Level	Limit Line	Over Limit	Remark
	MHz	dB	dBuV	dBuV	dBuV	dB	
1	0.176	10.40	34.47	44.87	66.00	-21.13	Average
2	0.176	10.40	44.14	54.54	79.00	-24.46	QP
3	0.230	10.40	27.03	37.43	66.00	-28.57	Average
4	0.230	10.40	34.29	44.69	79.00	-34.31	QP
5	0.319	10.40	20.32	30.72	66.00	-35.28	Average
6	0.319	10.40	26.76	37.16	79.00	-41.84	QP
7	0.634	10.55	15.91	26.46	60.00	-33.54	Average
8	0.634	10.55	26.68	37.23	73.00	-35.77	QP
9	4.390	10.51	16.71	27.22	60.00	-32.78	Average
10	4.390	10.51	26.51	37.02	73.00	-35.98	QP
11	7.300	10.39	32.19	42.58	60.00	-17.42	Average
12	7.300	10.39	38.32	48.71	73.00	-24.29	QP

AC 120V/60Hz, Neutral:

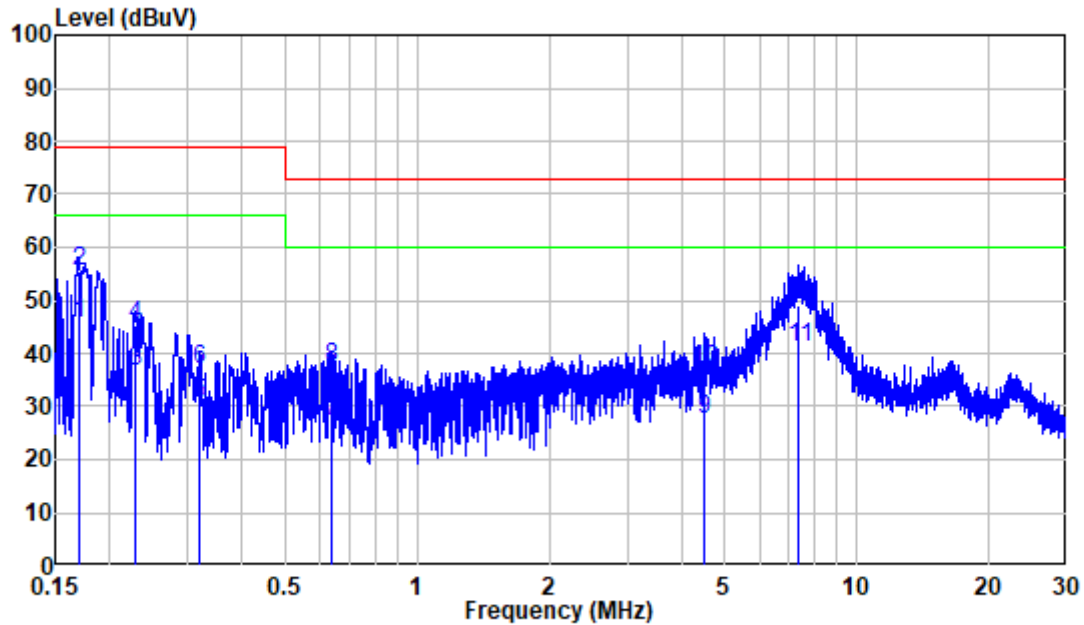

Site : Shielding Room
 Condition: Neutral
 Job No. : RA230620-35395E-EM
 Mode : System operation with Full load
 Note : R0070B

	Freq	Factor	Read Level	Limit Level	Limit Line	Over Limit	Remark
	MHz	dB	dBuV	dBuV	dBuV	dB	
1	0.169	10.44	35.21	45.65	66.00	-20.35	Average
2	0.169	10.44	44.91	55.35	79.00	-23.65	QP
3	0.227	10.49	26.02	36.51	66.00	-29.49	Average
4	0.227	10.49	34.62	45.11	79.00	-33.89	QP
5	0.320	10.45	20.18	30.63	66.00	-35.37	Average
6	0.320	10.45	26.67	37.12	79.00	-41.88	QP
7	0.638	10.48	16.64	27.12	60.00	-32.88	Average
8	0.638	10.48	26.74	37.22	73.00	-35.78	QP
9	4.487	10.44	17.29	27.73	60.00	-32.27	Average
10	4.487	10.44	26.41	36.85	73.00	-36.15	QP
11	7.373	10.48	30.47	40.95	60.00	-19.05	Average
12	7.373	10.48	38.52	49.00	73.00	-24.00	QP

Test mode 2:

AC 120V/60Hz, Line:

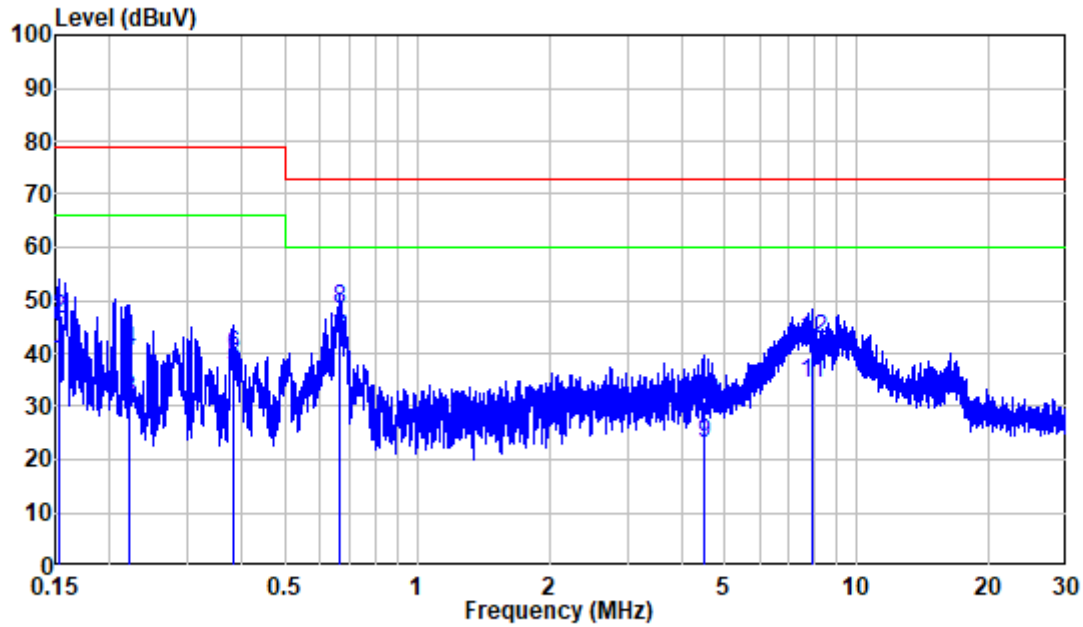

Site : Shielding Room
 Condition: Line
 Job No. : RA230620-35395E-EM
 Mode : System operation with Full load
 Note : ADO-60W1 13

	Freq	Factor	Read Level	Level	Limit Line	Over Limit	Remark
	MHz	dB	dBuV	dBuV	dBuV	dB	
1	0.153	10.40	27.99	38.39	66.00	-27.61	Average
2	0.153	10.40	36.03	46.43	79.00	-32.57	QP
3	0.220	10.40	20.75	31.15	66.00	-34.85	Average
4	0.220	10.40	29.84	40.24	79.00	-38.76	QP
5	0.380	10.40	26.89	37.29	66.00	-28.71	Average
6	0.380	10.40	29.22	39.62	79.00	-39.38	QP
7	0.666	10.58	32.24	42.82	60.00	-17.18	Average
8	0.666	10.58	37.82	48.40	73.00	-24.60	QP
9	4.487	10.50	12.42	22.92	60.00	-37.08	Average
10	4.487	10.50	20.59	31.09	73.00	-41.91	QP
11	7.893	10.45	24.06	34.51	60.00	-25.49	Average
12	7.893	10.45	32.14	42.59	73.00	-30.41	QP

AC 120V/60Hz, Neutral:

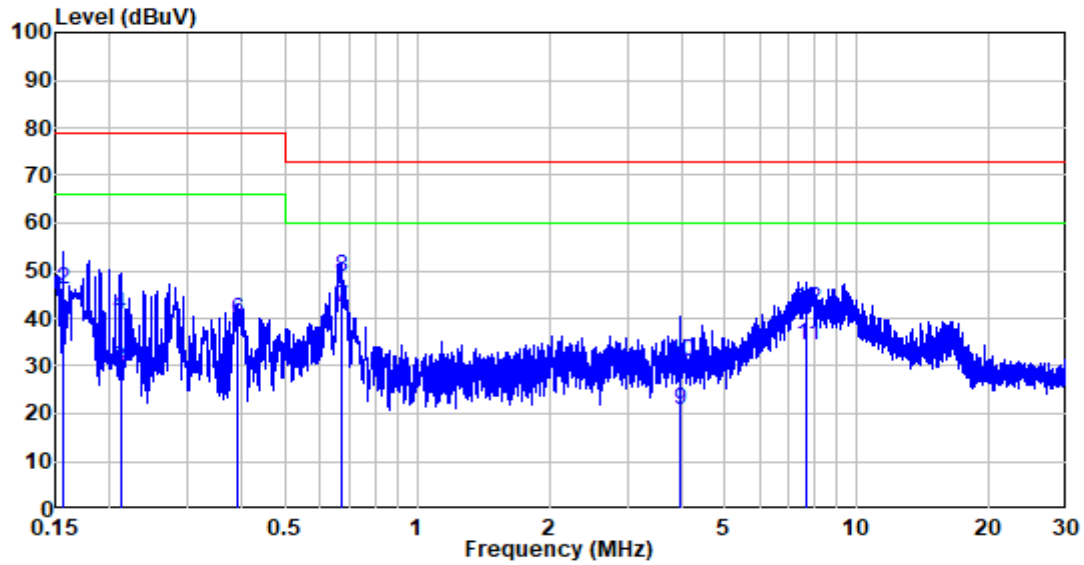

Site : Shielding Room
 Condition: Neutral
 Job No. : RA230620-35395E-EM
 Mode : System operation with Full load
 Note : ADO-60W1 13

	Freq	Factor	Read Level	Level	Limit Line	Over Limit	Remark
	MHz	dB	dBuV	dBuV	dBuV	dB	
1	0.156	10.41	26.78	37.19	66.00	-28.81	Average
2	0.156	10.41	35.57	45.98	79.00	-33.02	QP
3	0.211	10.49	18.82	29.31	66.00	-36.69	Average
4	0.211	10.49	30.35	40.84	79.00	-38.16	QP
5	0.388	10.43	26.45	36.88	66.00	-29.12	Average
6	0.388	10.43	29.30	39.73	79.00	-39.27	QP
7	0.670	10.50	31.85	42.35	60.00	-17.65	Average
8	0.670	10.50	38.02	48.52	73.00	-24.48	QP
9	3.951	10.44	10.43	20.87	60.00	-39.13	Average
10	3.951	10.44	20.62	31.06	73.00	-41.94	QP
11	7.687	10.51	23.76	34.27	60.00	-25.73	Average
12	7.687	10.51	31.41	41.92	73.00	-31.08	QP

Test mode 3:

AC 120V/60Hz, Line:

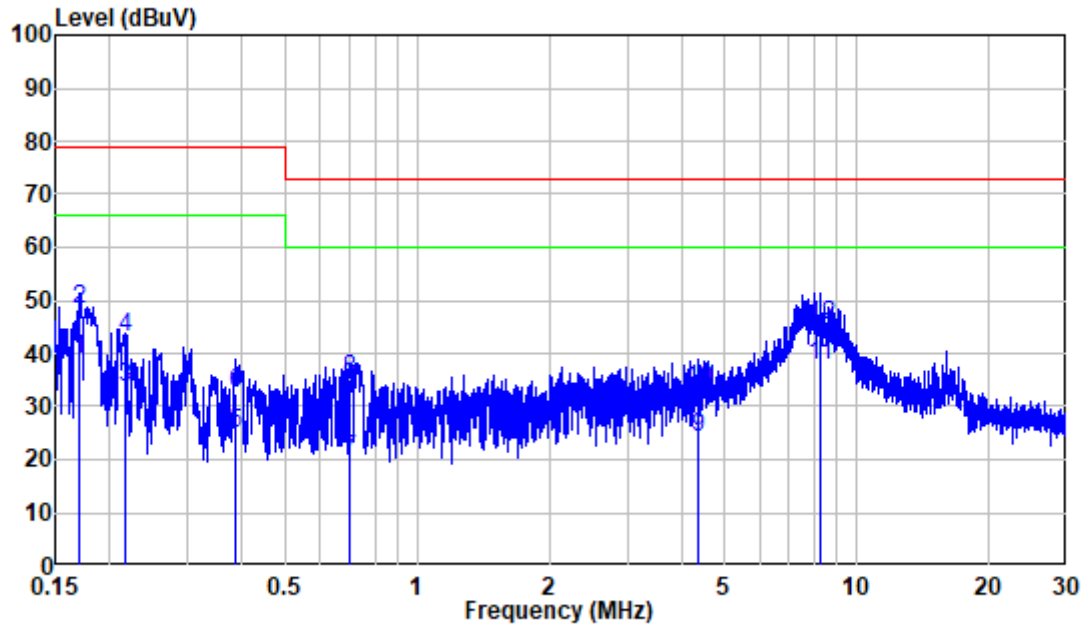

Site : Shielding Room
 Condition: Line
 Job No. : RA230620-35395E-EM
 Mode : System operation with Full load
 Note : PA-1061-13H1

	Freq	Factor	Read Level	Level	Limit Line	Over Limit	Remark
	MHz	dB	dBuV	dBuV	dBuV	dB	
1	0.171	10.40	28.35	38.75	66.00	-27.25	Average
2	0.171	10.40	37.90	48.30	79.00	-30.70	QP
3	0.216	10.40	23.14	33.54	66.00	-32.46	Average
4	0.216	10.40	32.48	42.88	79.00	-36.12	QP
5	0.385	10.40	14.48	24.88	66.00	-41.12	Average
6	0.385	10.40	22.06	32.46	79.00	-46.54	QP
7	0.699	10.61	9.31	19.92	60.00	-40.08	Average
8	0.699	10.61	24.39	35.00	73.00	-38.00	QP
9	4.375	10.51	13.79	24.30	60.00	-35.70	Average
10	4.375	10.51	22.65	33.16	73.00	-39.84	QP
11	8.230	10.47	27.45	37.92	60.00	-22.08	Average
12	8.230	10.47	34.72	45.19	73.00	-27.81	QP

AC 120V/60Hz, Neutral:

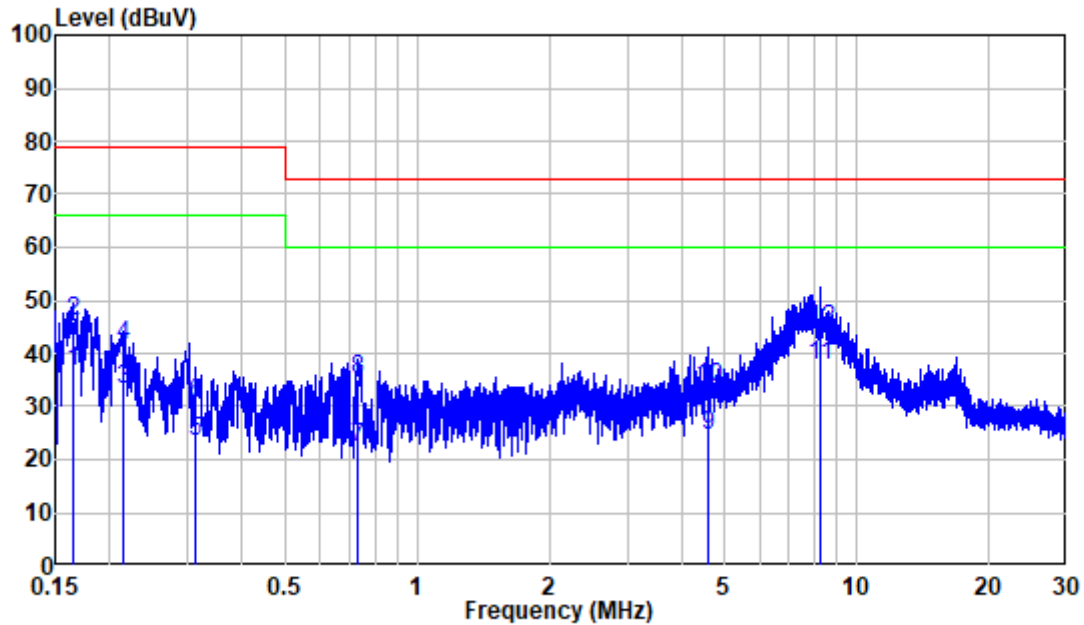

Site : Shielding Room
 Condition: Neutral
 Job No. : RA230620-35395E-EM
 Mode : System operation with Full load
 Note : PA-1061-13H1

	Freq	Factor	Read Level	Limit Level	Limit Line	Over Limit	Remark
	MHz	dB	dBuV	dBuV	dBuV	dB	
1	0.165	10.43	26.13	36.56	66.00	-29.44	Average
2	0.165	10.43	35.63	46.06	79.00	-32.94	QP
3	0.213	10.49	22.71	33.20	66.00	-32.80	Average
4	0.213	10.49	30.90	41.39	79.00	-37.61	QP
5	0.313	10.45	12.76	23.21	66.00	-42.79	Average
6	0.313	10.45	20.23	30.68	79.00	-48.32	QP
7	0.732	10.50	11.84	22.34	60.00	-37.66	Average
8	0.732	10.50	24.50	35.00	73.00	-38.00	QP
9	4.589	10.45	14.25	24.70	60.00	-35.30	Average
10	4.589	10.45	23.02	33.47	73.00	-39.53	QP
11	8.230	10.53	27.39	37.92	60.00	-22.08	Average
12	8.230	10.53	33.95	44.48	73.00	-28.52	QP

5. RADIATED EMISSION MEASUREMENT

5.1. Block Diagram of Test Setup

5.1.1. Block diagram of connection between the EUT and simulators

Test Mode 1&2&3:

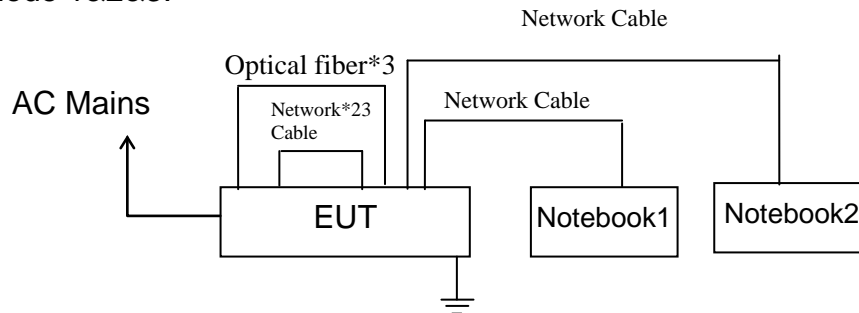

5.1.2. Test System Setup

Below 1GHz:

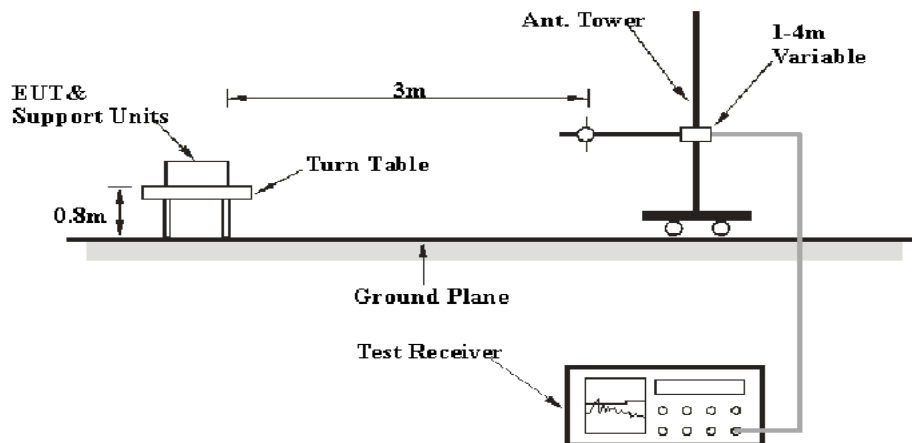

Above 1GHz:

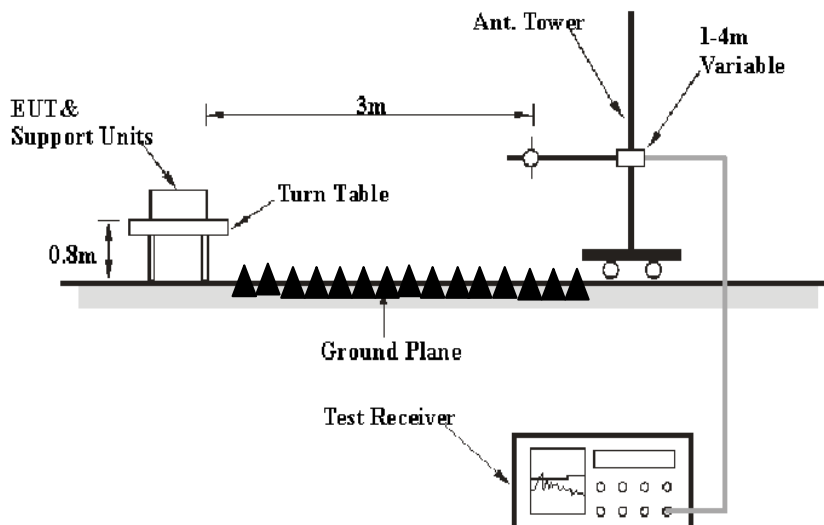

5.2. Radiated Emission Limit (Class A)

All emanations from a class A device or system, including any network of conductors and apparatus connected thereto, shall not exceed the level of field strengths specified below:

Below 1GHz:

Frequency MHz	Distance Meters	Field Strengths Limit
		dB(μ V/m)
30-88	3	49.54
88-216	3	53.98
216-960	3	56.9
960-1000	3	60.0

Remark:

(1) Emission level dB (μ V) = 20 log Emission level μ V/m.

(2) The smaller limit shall apply at the cross point between two frequency bands.

(3) Distance is the distance in meters between the measuring instrument antenna and the closest point of any part of the device or system.

Above 1GHz:

Frequency MHz	Distance Meters	Field Strengths Limit(dB μ V/m)	
		Peak	Average
Above 1000MHz	3	80.0	60.0

5.3. Test mode description

- Test mode 1: System operation with Full load (Power module: R0070B)
- Test mode 2: System operation with Full load (Power module: ADO-60W1 13)
- Test mode 3: System operation with Full load (Power module: PA-1061-13H1)

5.3.1. Environmental Conditions

- Temperature : 22-23°C
- Relative Humidity : 51-56 %
- ATM Pressure : 101kPa

The testing was performed by Jason Liu and Jeef Huang on 2023-06-27.

5.4. Manufacturer

The following equipments are installed on Radiated Emission Measurement to meet the commission requirement and operating regulations in a manner, which tends to maximize its emission characteristics in a normal application.

5.4.1. Enterprise Layer 2+ Managed Network Switch (EUT)

- Model Number : GWN7806
- Manufacturer : Grandstream Networks, Inc.

5.5. Operating Condition of EUT

- 5.5.1. Setup the EUT and simulator as shown as Section 5.1.
- 5.5.2. Turn on the power of all equipments.
- 5.5.3. Let the EUT work in test mode and measure it.

5.6. Test Procedure

The EUT and its simulators are placed on a turntable, which is 0.8 meter high above ground. The turntable can rotate 360 degrees to determine the position of the maximum emission level. EUT is set 3.0 meters away from the receiving antenna, which is mounted on an antenna tower. The antenna can be moved up and down between 1.0 meter and 4 meters to find out the maximum emission level. Broadband antenna (calibrated bilog antenna) is used as receiving antenna. Both horizontal and vertical polarizations of the antenna are set on measurement. In order to find the maximum emission levels, all of the interface cables must be manipulated according to ANSI C63.4-2014 on radiated emission measurement.

The bandwidth of the Receiver is set at 9kHz in 9kHz-30MHz, 120 kHz in 30-1000MHz, and 1MHz for above 1GHz.

The frequency range from 30MHz to 5GHz is investigated.

Highest frequency generated or used in the device or on which the device operates or tunes (MHz)	Upper frequency of measurement range (MHz)
Below 1.705	30.
1.705–108	1000.
108–500	2000.
500–1000	5000.
Above 1000	5th harmonic of the highest frequency or 40 GHz, whichever is lower.

5.7. Data Sample

Over Limit (dB) = Level (dB μ v/m) - Limit (dB μ v/m)

QP = Quasi-peak Reading

The “Over Limit” column of the following data tables indicates the degree of compliance with the applicable limit. For example, an over Limit of -7dB means the emission is 7dB below the limit.

5.8. Radiated Emission Measurement Result

PASS.

The frequency range from 30MHz to 5GHz is investigated.

The spectral diagrams are attached as below.

Below 1GHz

Test mode 1:

Horizontal

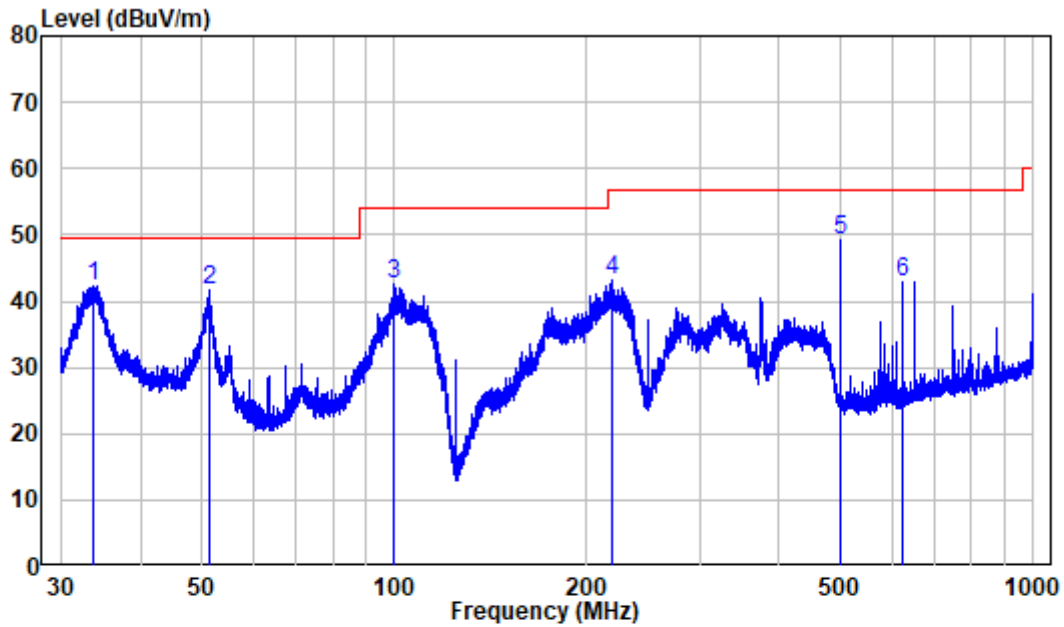

Site : chamber
 Condition: 3m Horizontal
 Job No. : RA230620-35395E-EM
 Test Mode: System operation with Full load
 Note : R0070B

	Freq	Factor	Read Level	Limit Level	Over Limit	Remark
	MHz	dB/m	dBuV	dBuV/m	dBuV/m	dB
1	33.636	-11.90	54.16	42.26	49.54	-7.28 Peak
2	51.211	-9.95	51.68	41.73	49.54	-7.81 Peak
3	99.703	-11.86	54.45	42.59	53.98	-11.39 Peak
4	218.788	-11.48	54.70	43.22	56.90	-13.68 Peak
5	500.082	-4.25	53.54	49.29	56.90	-7.61 Peak
6	625.078	-2.35	45.36	43.01	56.90	-13.89 Peak

Vertical

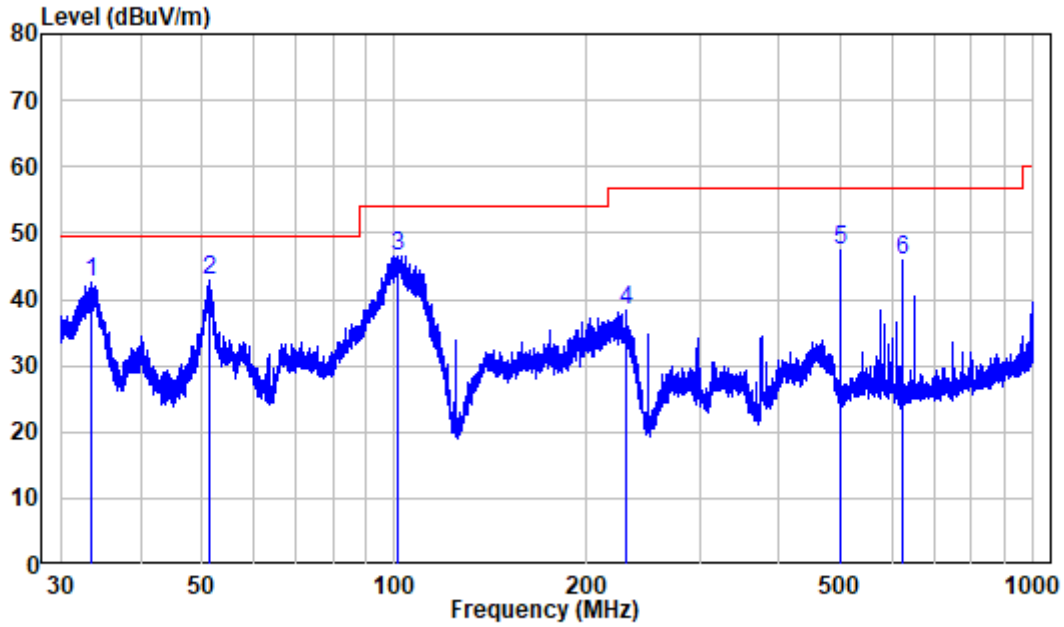

Site : chamber
 Condition: 3m VERTICAL
 Job No. : RA230620-35395E-EM
 Test Mode: System operation with Full load
 Note : R0070B

	Freq	Factor	Read		Limit	Over	Remark
			Level	Level	Line	Limit	
	MHz	dB/m	dBuV	dBuV/m	dBuV/m	dB	
1	33.504	-11.93	54.52	42.59	49.54	-6.95	Peak
2	51.233	-9.95	52.69	42.74	49.54	-6.80	Peak
3	101.111	-11.67	58.23	46.56	53.98	-7.42	Peak
4	229.695	-11.12	49.31	38.19	56.90	-18.71	Peak
5	500.082	-4.25	51.66	47.41	56.90	-9.49	Peak
6	625.078	-2.35	48.15	45.80	56.90	-11.10	Peak

Test mode 2:

Horizontal

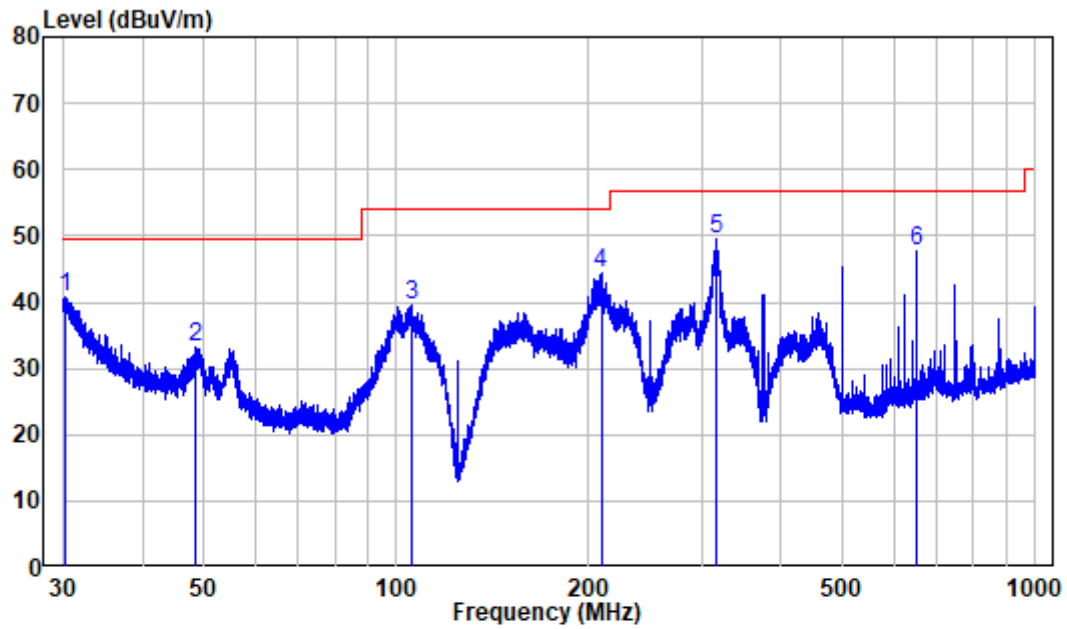

Site : chamber
 Condition: 3m HORIZONTAL
 Job No. : RA230620-35395E-EM
 Test Mode: System operation with Full load
 Note : ADO-60W1 13

	Freq	Factor	Read Level	Level	Limit Line	Over Limit	Remark
	MHz	dB/m	dBuV	dBuV/m	dBuV/m	dB	
1	30.198	-12.38	53.14	40.76	49.54	-8.78	Peak
2	48.565	-9.97	43.29	33.32	49.54	-16.22	Peak
3	105.734	-11.90	51.48	39.58	53.98	-14.40	Peak
4	209.038	-11.85	56.32	44.47	53.98	-9.51	Peak
5	316.728	-8.63	58.12	49.49	56.90	-7.41	Peak
6	650.229	-1.72	49.32	47.60	56.90	-9.30	Peak

Vertical

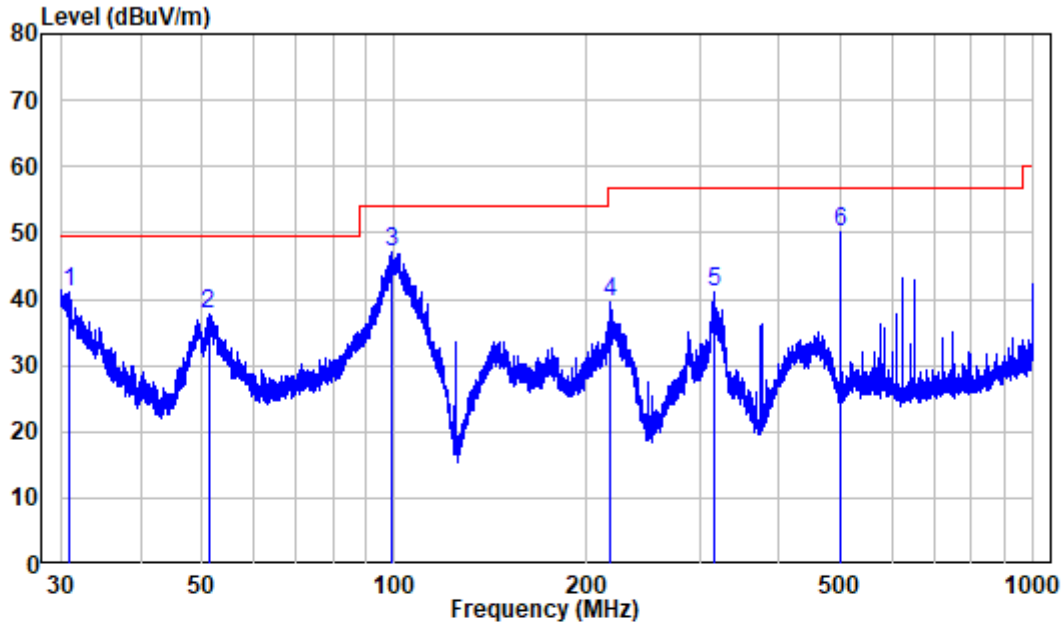

Site : chamber
 Condition: 3m VERTICAL
 Job No. : RA230620-35395E-EM
 Test Mode: System operation with Full load
 Note : ADO-60W1 13

	Freq	Factor	Read Level	Limit Level	Over Limit	Remark
	MHz	dB/m	dBuV	dBuV/m	dBuV/m	dB
1	30.948	-12.30	53.23	40.93	49.54	-8.61 Peak
2	51.121	-9.95	47.61	37.66	49.54	-11.88 Peak
3	99.310	-11.96	59.18	47.22	53.98	-6.76 Peak
4	218.213	-11.51	50.91	39.40	56.90	-17.50 Peak
5	316.312	-8.65	49.60	40.95	56.90	-15.95 Peak
6	500.082	-4.25	54.28	50.03	56.90	-6.87 Peak

Test mode 3:

Horizontal

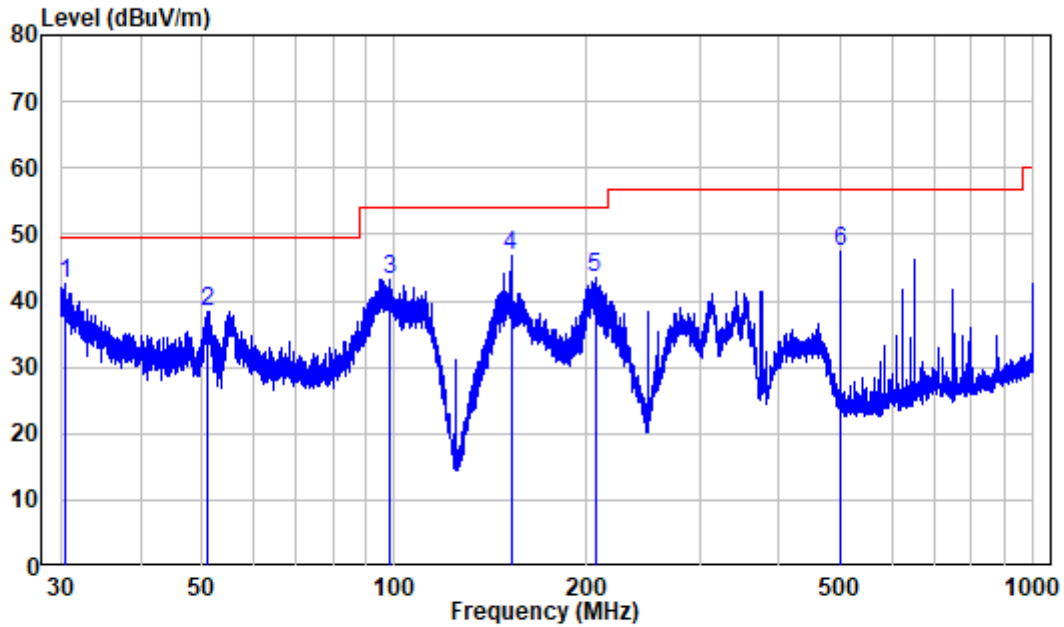

Site : chamber
 Condition: 3m HORIZONTAL
 Job No. : RA230620-35395E-EM
 Test Mode: System operation with Full load
 Note : PA-1061-13H1

	Freq	Factor	Read		Limit	Over	Remark
			Level	Level	Line	Limit	
	MHz	dB/m	dBuV	dBuV/m	dBuV/m	dB	
1	30.424	-12.35	54.87	42.52	49.54	-7.02	Peak
2	50.875	-9.93	48.39	38.46	49.54	-11.08	Peak
3	98.443	-12.15	55.44	43.29	53.98	-10.69	Peak
4	152.130	-15.15	61.84	46.69	53.98	-7.29	Peak
5	206.036	-11.84	55.36	43.52	53.98	-10.46	Peak
6	500.082	-4.25	51.55	47.30	56.90	-9.60	Peak

Vertical

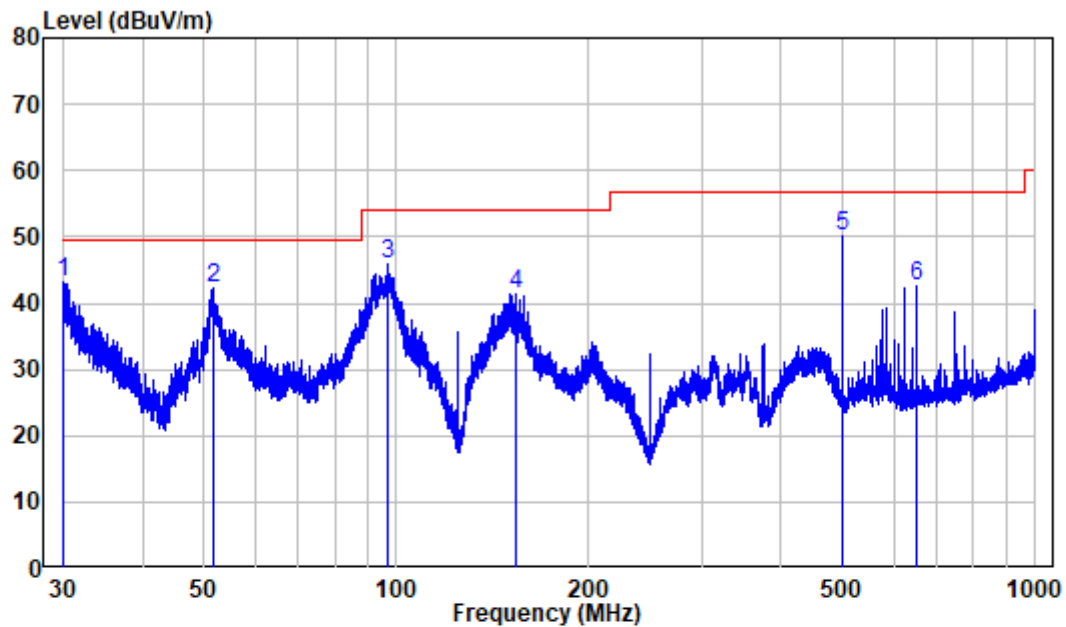

Site : chamber
 Condition: 3m VERTICAL
 Job No. : RA230620-35395E-EM
 Test Mode: System operation with Full load
 Note : PA-1061-13H1

	Freq	Factor	Read Level	Limit Level	Over Line	Over Limit	Remark
	MHz	dB/m	dBuV	dBuV/m	dBuV/m	dB	
1	30.000	-12.40	55.45	43.05	49.54	-6.49	Peak
2	51.639	-9.96	52.18	42.22	49.54	-7.32	Peak
3	96.648	-12.29	58.13	45.84	53.98	-8.14	Peak
4	153.268	-15.08	56.56	41.48	53.98	-12.50	Peak
5	500.082	-4.25	54.37	50.12	56.90	-6.78	Peak
6	650.229	-1.72	44.36	42.64	56.90	-14.26	Peak

Above 1GHz

Test mode 1:

Horizontal

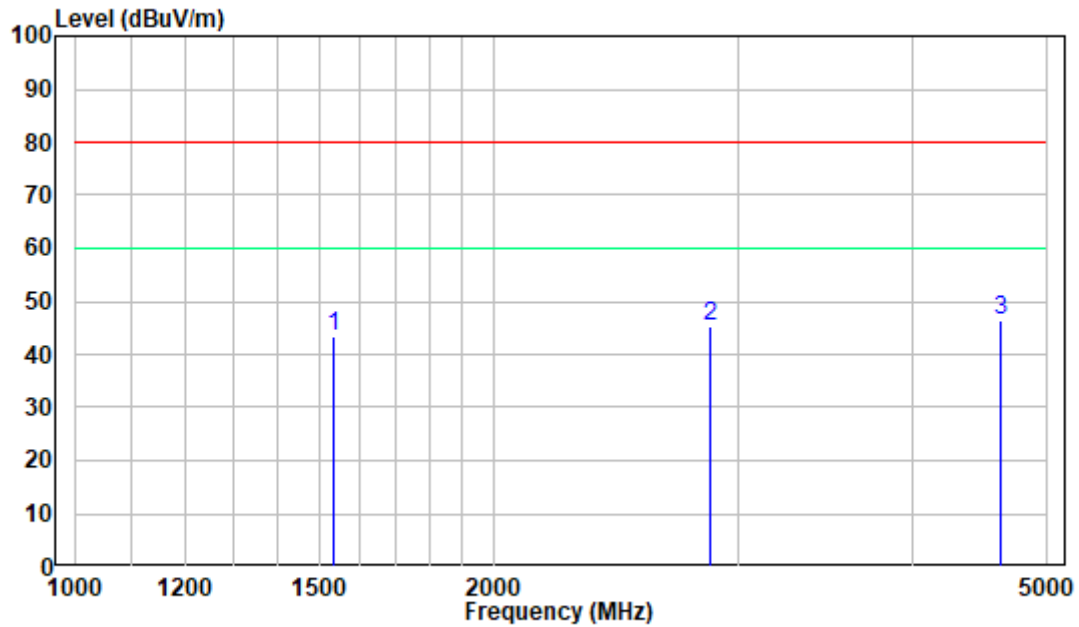

Site : chamber
 Condition: 3m Horizontal
 Job No. : RA230620-35395E-EM
 Test Mode: System operation with Full load
 Note : R0070B

	Freq	Factor	Read Level	Level	Limit Line	Over Limit	Remark
	MHz	dB/m	dBuV	dBuV/m	dBuV/m	dB	
1	1536.000	-13.89	57.14	43.25	80.00	-36.75	Peak
2	2866.000	-10.47	55.65	45.18	80.00	-34.82	Peak
3	4622.000	-6.21	52.66	46.45	80.00	-33.55	Peak

Vertical

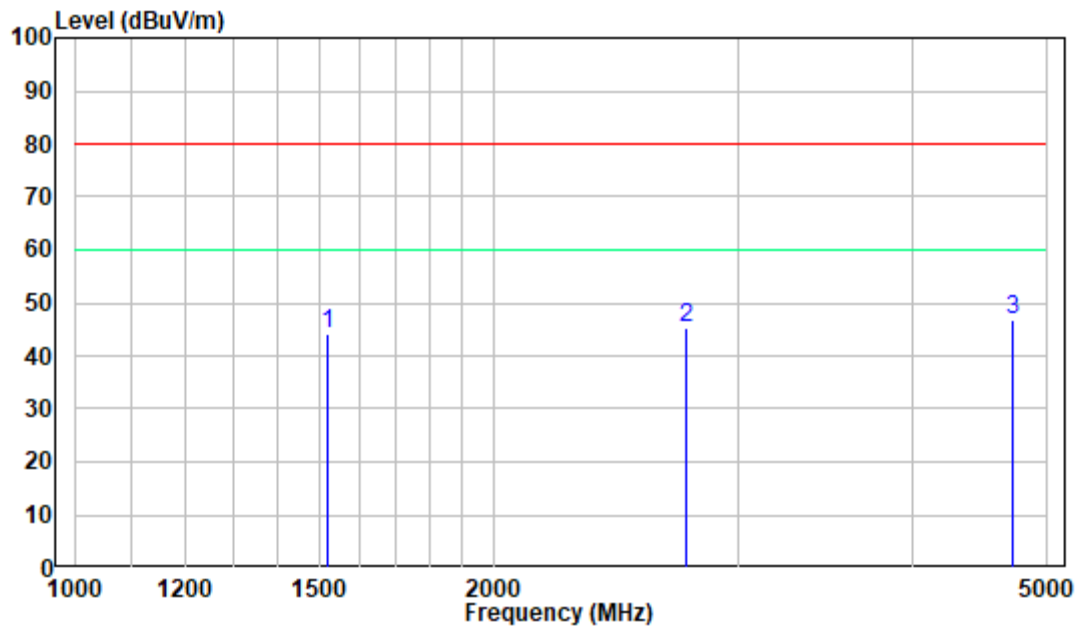

Site : chamber
 Condition: 3m VERTICAL
 Job No. : RA230620-35395E-EM
 Test Mode: System operation with Full load
 Note : R0070B

	Read	Limit	Over			
Freq	Factor	Level	Level	Line	Limit	Remark
MHz	dB/m	dBuV	dBuV/m	dBuV/m	dB	
1	1522.000	-13.90	58.15	44.25	80.00	-35.75 Peak
2	2749.000	-10.21	55.47	45.26	80.00	-34.74 Peak
3	4725.000	-5.47	52.18	46.71	80.00	-33.29 Peak

Test mode 2:

Horizontal

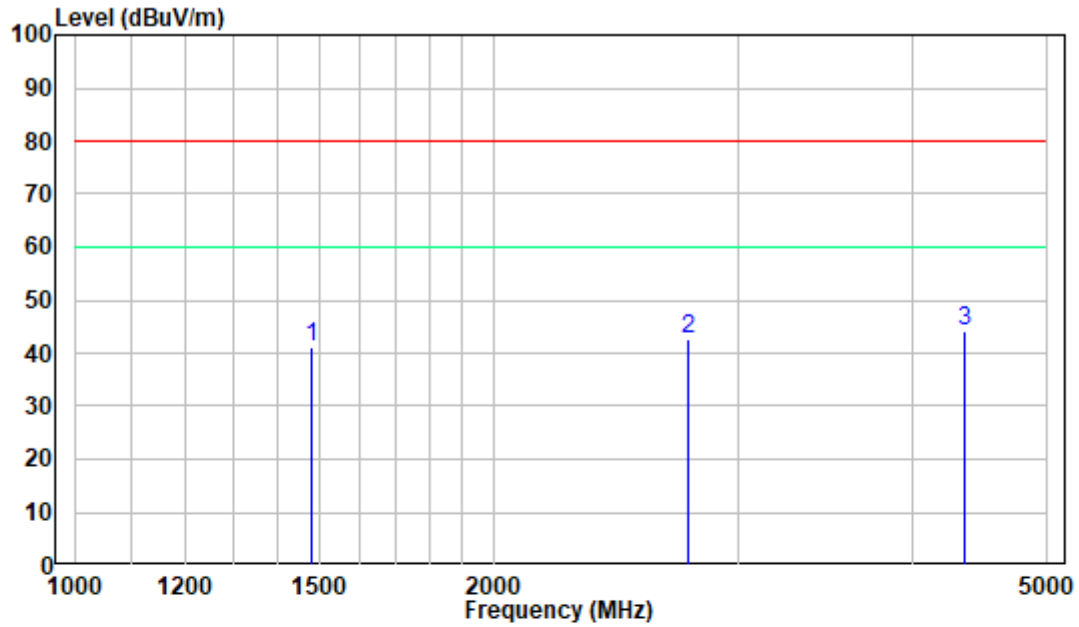

Site : chamber
 Condition: 3m HORIZONTAL
 Job No. : RA230620-35395E-EM
 Test Mode: System operation with Full load
 Note : ADO-60W1 13

	Freq	Factor	Read Level	Level	Limit Line	Over Limit	Remark
	MHz	dB/m	dBuV	dBuV/m	dBuV/m	dB	
1	1482.000	-13.99	55.30	41.31	80.00	-38.69	Peak
2	2761.000	-10.25	52.83	42.58	80.00	-37.42	Peak
3	4355.000	-6.86	50.85	43.99	80.00	-36.01	Peak

Vertical

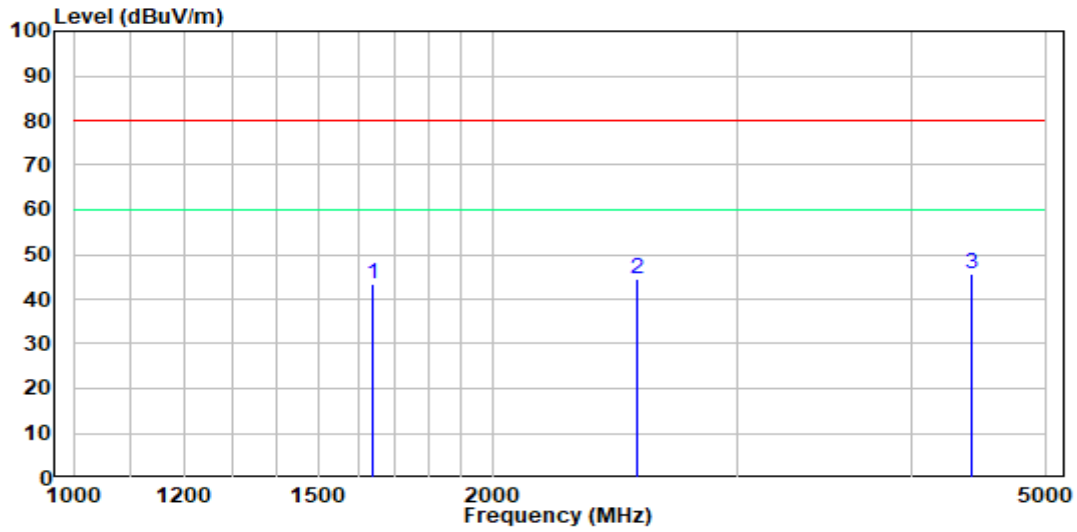

Site : chamber
 Condition: 3m VERTICAL
 Job No. : RA230620-35395E-EM
 Test Mode: System operation with Full load
 Note : ADO-60W1 13

	Freq	Factor	Read Level	Limit Level	Limit Line	Over Limit	Remark
	MHz	dB/m	dBuV	dBuV/m	dBuV/m	dB	
1	1642.000	-13.75	57.00	43.25	80.00	-36.75	Peak
2	2537.000	-10.48	55.09	44.61	80.00	-35.39	Peak
3	4422.000	-6.63	52.14	45.51	80.00	-34.49	Peak

Test mode 3:

Horizontal

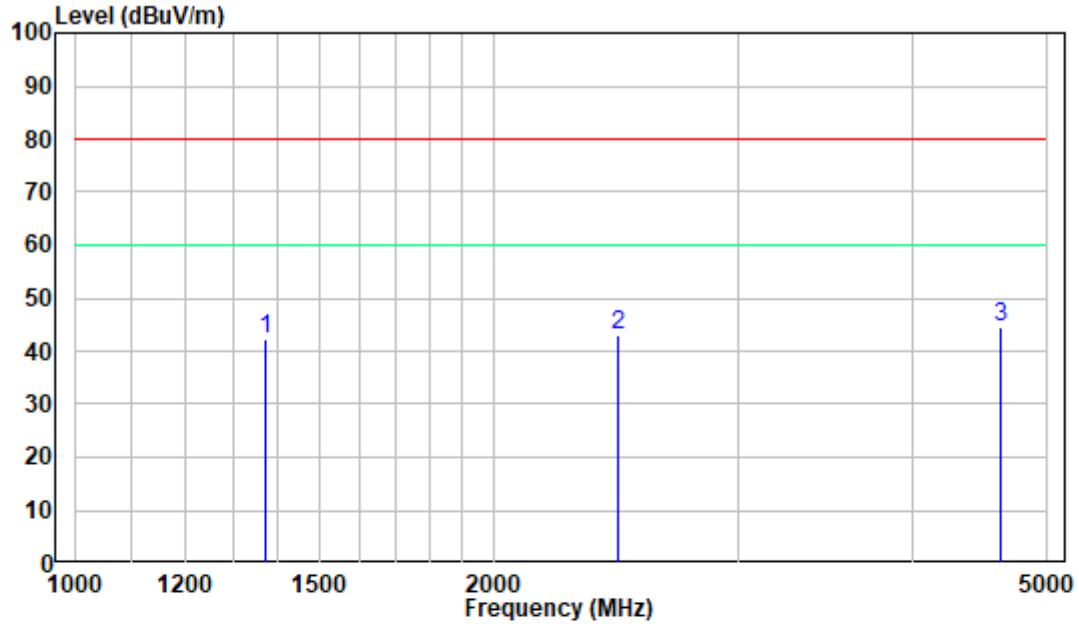

Site : chamber
 Condition: 3m HORIZONTAL
 Job No. : RA230620-35395E-EM
 Test Mode: System operation with Full load
 Note : PA-1061-13H1

	Freq	Factor	Read Level	Level	Limit Line	Over Limit	Remark
	MHz	dB/m	dBuV	dBuV/m	dBuV/m	dB	
1	1372.000	-13.85	56.21	42.36	80.00	-37.64	Peak
2	2455.000	-10.71	53.89	43.18	80.00	-36.82	Peak
3	4628.000	-6.21	50.92	44.71	80.00	-35.29	Peak

Vertical

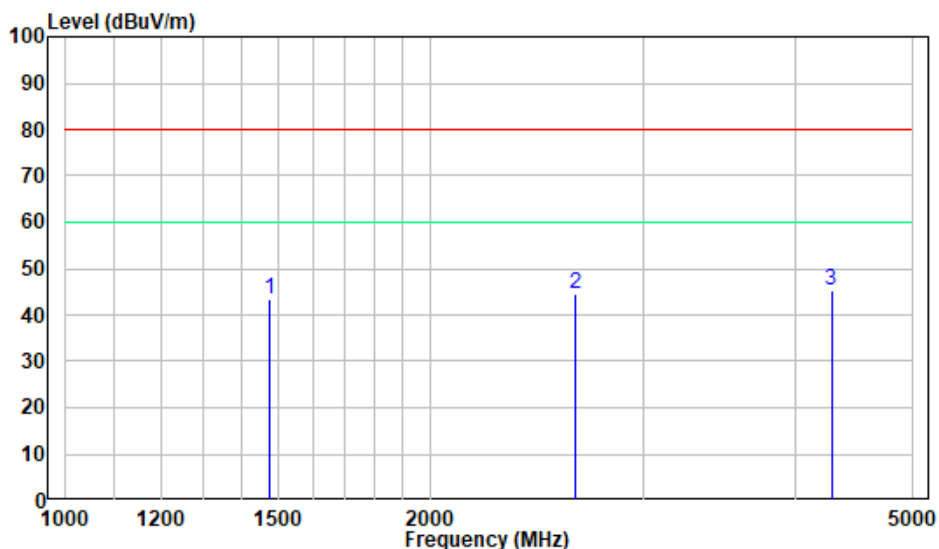

Site : chamber
 Condition: 3m Vertical
 Job No. : RA230620-35395E-EM
 Test Mode: System operation with Full load
 Note : PA-1061-13H1

	Freq	Factor	Read Level	Level	Limit Line	Over Limit	Remark
	MHz	dB/m	dBuV	dBuV/m	dBuV/m	dB	
1	1477.000	-14.01	57.54	43.53	80.00	-36.47	Peak
2	2631.000	-10.68	55.20	44.52	80.00	-35.48	Peak
3	4282.000	-7.13	52.31	45.18	80.00	-34.82	Peak

Note:

- 1) Level= Reading + Factor
- 2) Over Limit = Level-Limit
- 3) For below 1GHz testing, if the maximized peak measured value complies with the limit, then it is unnecessary to perform QP/Average measurement.
- 4) For above 1GHz testing, the test result of peak was 20dB below to the limit of peak, which can be compliant to the average limit, so just peak value was recorded.
- 5) For above 1GHz, other emission which more than 20dB below limit was not recorded.

----- THE END OF TEST REPORT -----