

GWN7661E 2.4G Wi-Fi ANT1 & 5G Wi-Fi ANT0 Antenna Specification

Brand Name: GRANDSTREAM

Manufacture: SHENZHEN CHAOLIU NETWORK TECHNOLOGIES CO., LTD

Manufacturing address: 14th Floor, Building-C, Coolpad Building, Gaoxin North District, Science Park,
Nanshan District, Shenzhen

Product Number (or model Name) : 118-00110-00

设计规格 specifications

频率范围 Frequency (MHz)	2.4G:2400~2500	5G: 5150~5895
电压驻波比 VSWR	$\leq 2.0: 1$	
峰值增益 Peak Gain (dBi)	2.4G: 3.85	5G: 5.85
效率 Efficiency (%)	≥ 60	≥ 70
天线类型 Type	Dipole Antenna	
辐射方向 Radiation Properties	全向 Omni-directional	
最大输入功率 Max Input Power (Watts)	2	
工作温度 Operation Temperature	-40°C to 85°C	
储存温度 Storage Temperature	-40°C to 85°C	
相对湿度 Relative Humidity	40% to 95%	
环保认证 ROHS Compliant	通过 Yes	

辐射方向图 Radiation Pattern

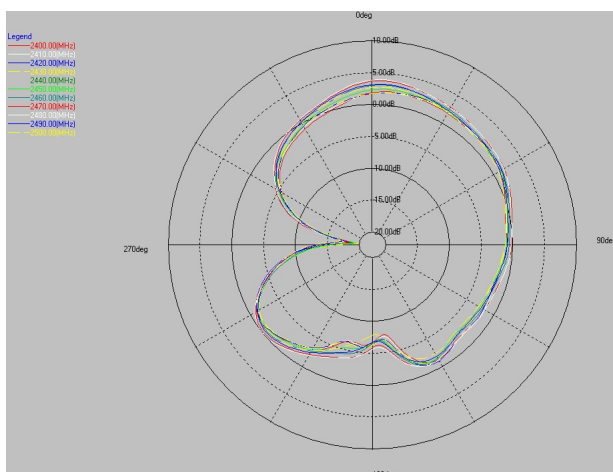

2.4G phi=0deg

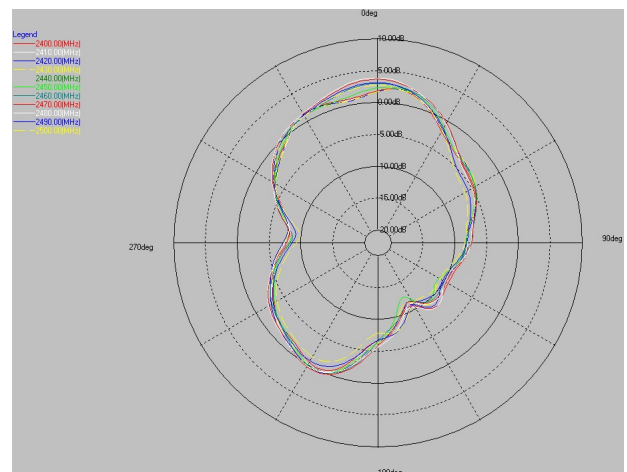

2.4G phi=90deg

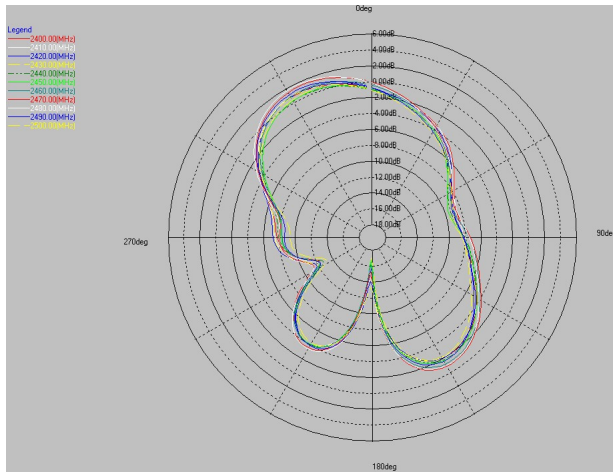

2.4G theta=90deg

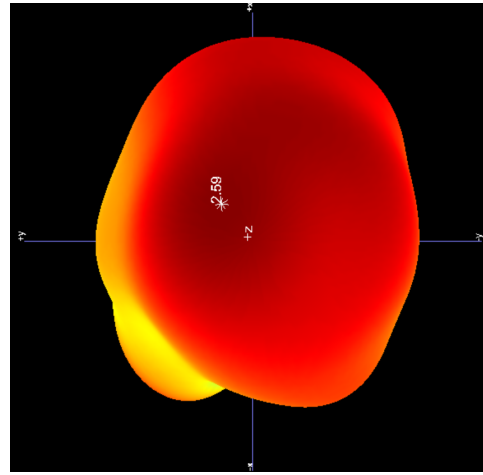

2.4G 3D

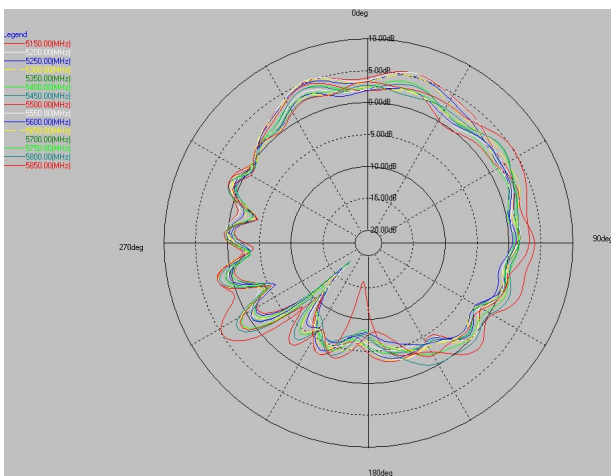

5G phi=0deg

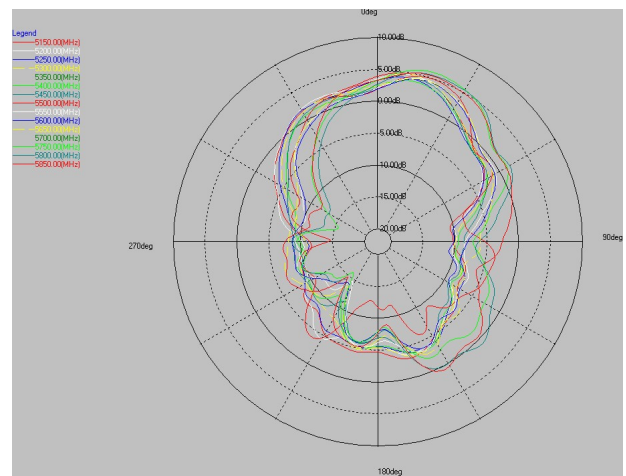

5G phi=90deg

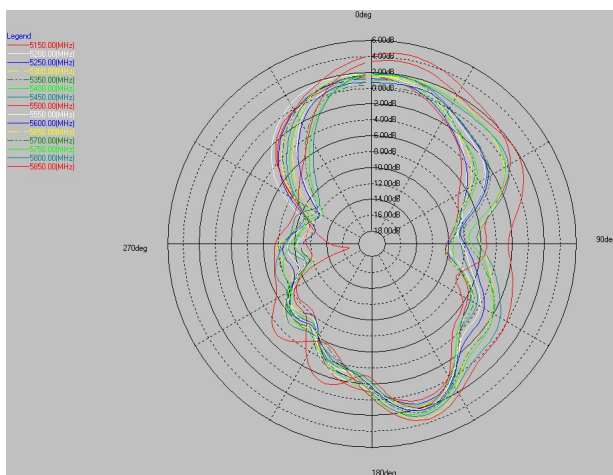

5G theta=90deg

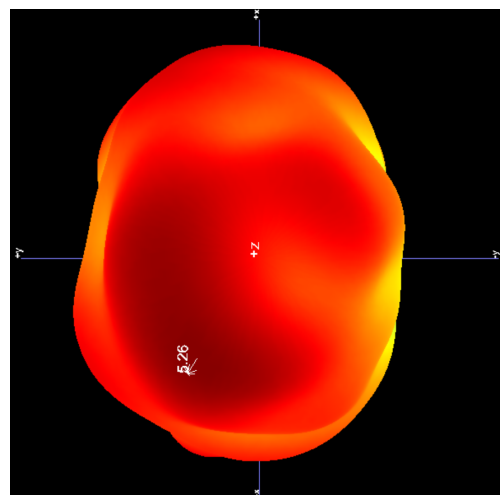

5G 3D

总成图 Mechanical Drawing

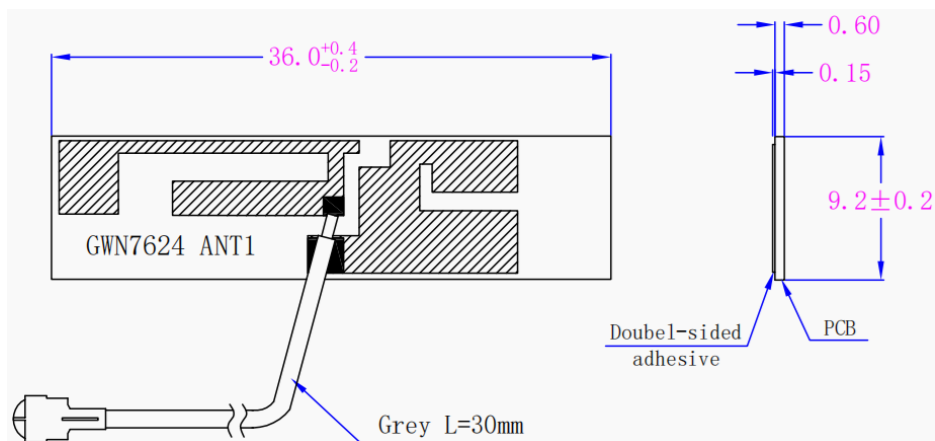

▲规格书到此结束 **END OF THE SPECIFICATION.**