



FCC PART 15.407
RSS-247, ISSUE 2, FEBRUARY 2017
DYNAMIC FREQUENCY SELECTION
TEST REPORT

For

Grandstream Networks, Inc.

126 Brookline Ave., 3rd Floor Boston, MA 02215, USA

FCC ID: YZZGWN7630LR
IC:11964A-GWN7630LR

Report Type: Original Report	Product Type: Outdoor Long-Range High-Performance 802.11ac Wi-Fi Access Point
Report Number:	RSZ191120011-00A1
Report Date:	2020-01-20
Reviewed By:	Jerry Zhang EMC Manager <i>Jerry Zhang</i>
Test Laboratory:	Bay Area Compliance Laboratories Corp. (Dongguan) No.69 Pulongcun, Puxinhu Industry Area, Tangxia, Dongguan, Guangdong, China Tel: +86-769-86858888 Fax: +86-769-86858891 www.baclcorp.com.cn

TABLE OF CONTENTS

GENERAL INFORMATION.....	3
PRODUCT DESCRIPTION FOR EQUIPMENT UNDER TEST (EUT)	3
OBJECTIVE	3
TEST METHODOLOGY	3
TEST FACILITY	3
DECLARATIONS.....	3
SYSTEM TEST CONFIGURATION.....	5
DESCRIPTION OF TEST CONFIGURATION	5
EUT EXERCISE SOFTWARE	5
EQUIPMENT MODIFICATIONS	5
SUPPORT EQUIPMENT LIST AND DETAILS	5
EXTERNAL CABLE.....	5
SUMMARY OF TEST RESULTS	6
APPLICABLE STANDARDS.....	7
DFS REQUIREMENT	7
DFS MEASUREMENT SYSTEM.....	11
SYSTEM BLOCK DIAGRAM.....	11
CONDUCTED METHOD	12
RADIATED METHOD.....	13
TEST PROCEDURE	13
TEST RESULTS.....	14
DESCRIPTION OF EUT	14
TEST EQUIPMENT LIST AND DETAILS.....	14
RADAR WAVEFORM CALIBRATION	15
TEST ENVIRONMENTAL CONDITIONS	15
CHANNEL AVAILABILITY CHECK TIME (CAC)	21
TEST PROCEDURE	21
CHANNEL MOVE TIME AND CHANNEL CLOSING TRANSMISSION TIME	24
TEST PROCEDURE	24
TEST RESULTS	24
NON-OCCUPANCY PERIOD.....	27
TEST PROCEDURE	27
TEST RESULT	27
DETECTION BANDWIDTH.....	28
TEST PROCEDURE	28
TEST RESULT	29
STATISTICAL PERFORMANCE CHECK	33
BRIDGE AND/OR MESH MODE.....	127

GENERAL INFORMATION

Product Description for Equipment under Test (EUT)

The Grandstream Networks, Inc.'s product, model number: GWN7630LR (the "EUT") in this report was a ***Outdoor Long-Range High-Performance 802.11ac Wi-Fi Access Point***, rated input voltage: DC 48V form PoE.

**All measurement and test data in this report was gathered from production sample serial number: RSZ191120011-RF-A1-S1 (Assigned by BACL, Dongguan). The EUT was received on 2019-12-02.*

Objective

This report is prepared on behalf of ***Grandstream Networks, Inc.*** in accordance with Part 2-Subpart J, Part 15-Subparts E of the Federal Communications Commission's rules, and RSS-247, Issue 2, February 2017 of the Innovation, Science and Economic Development Canada.

The objective is to determine compliance with Dynamic Frequency Selection (DFS) of the FCC Part 15, Subpart E, section 15.407 and and RSS-247, Issue 2, February 2017 of the Innovation, Science and Economic Development Canada.

Test Methodology

FCC KDB 905462 D02 UNII DFS Compliance Procedures New Rules v02.

Test Facility

The Test site used by Bay Area Compliance Laboratories Corp. (Dongguan) to collect test data is located on the No.69 Pulongcun, Puxinhu Industry Area, Tangxia, Dongguan, Guangdong, China.

The lab has been recognized as the FCC accredited lab under the KDB 974614 D01 and is listed in the FCC Public Access Link (PAL) database, FCC Registration No. : 897218, the FCC Designation No. : CN1220.

The lab has been recognized by Innovation, Science and Economic Development Canada to test to Canadian radio equipment requirements, the CAB identifier: CN0022.

Declarations

BACL is not responsible for the authenticity of any test data provided by the applicant. Data included from the applicant that may affect test results are marked with a triangle symbol "Δ". Customer model name, addresses, names, trademarks etc. are not considered data.

Unless otherwise stated the results shown in this test report refer only to the sample(s) tested.

Otherwise required by the applicant or Product Regulations, Decision Rule in this report did not consider the uncertainty.

The extended uncertainty given in this report is obtained by combining the standard uncertainty times the coverage factor K with the 95% confidence interval.

This report cannot be reproduced except in full, without prior written approval of the Company.

This report is valid only with a valid digital signature. The digital signature may be available only under the e software above version 7.0.

This report may contain data that are not covered by the accreditation scope and shall be marked with an asterisk “★”.

SYSTEM TEST CONFIGURATION

Description of Test Configuration

The EUT was configured for testing in an engineering mode which was provided by the manufacturer.

EUT Exercise Software

The test was performed under: 'IPOP.exe', which was provided by the manufacturer.

Equipment Modifications

N/A

Support Equipment List and Details

Manufacturer	Description	Model	Serial Number
Dell	Laptop	E6410	00426-OEM-8992662-00497
Dell	Laptop	PP11L	QDS-BRCM133

External Cable

Cable Description	Shielding Type	Ferrite Core	Length (m)	From Port	To
RJ45	NO	NO	10	Laptop	EUT
RJ45	NO	NO	2	Laptop	EUT

SUMMARY OF TEST RESULTS

The following result table represents the list of measurements required under the CFR §47 Part 15.407(h) and RSS-247, Issue 2, February 2017, KDB: 905462 D02 UNII DFS Compliance Procedures New Rules v02

Items	Description of Test	Result
Detection Bandwidth	UNII Detection Bandwidth	Compliance
Performance Requirements Check	Initial Channel Availability Check Time (CAC)	Compliance
	Radar Burst at the Beginning of the CAC	Compliance
	Radar Burst at the End of the CAC	Compliance
In-Service Monitoring	Channel Move Time	Compliance
	Channel Closing Transmission Time	Compliance
	Non-Occupancy Period	Compliance
Radar Detection	Statistical Performance Check	Compliance

APPLICABLE STANDARDS

DFS Requirement

CFR §47 Part 15.407(h)& RSS-247, Issue 2, February 2017

FCC KDB 905462 D02 UNII DFS Compliance Procedures New Rules v02

Table 1: Applicability of DFS Requirements Prior to Use of a Channel

Requirement	Operational Mode		
	Master	Client Without Radar Detection	Client With Radar Detection
<i>Non-Occupancy Period</i>	Yes	Not required	Yes
<i>DFS Detection Threshold</i>	Yes	Not required	Yes
<i>Channel Availability Check Time</i>	Yes	Not required	Not required
<i>U-NII Detection Bandwidth</i>	Yes	Not required	Yes

Table 2: Applicability of DFS requirements during normal operation

Requirement	Operational Mode	
	Master Device or Client with Radar Detection	Client Without Radar Detection
<i>DFS Detection Threshold</i>	Yes	Not required
<i>Channel Closing Transmission Time</i>	Yes	Yes
<i>Channel Move Time</i>	Yes	Yes
<i>U-NII Detection Bandwidth</i>	Yes	Not required

Additional requirements for devices with multiple bandwidth modes	Master Device or Client with Radar Detection	Client Without Radar Detection
<i>U-NII Detection Bandwidth and Statistical Performance Check</i>	All BW modes must be tested	Not required
<i>Channel Move Time and Channel Closing Transmission Time</i>	Test using widest BW mode available	Test using the widest BW mode available for the link
<i>All other tests</i>	Any single BW mode	Not required
Note: Frequencies selected for statistical performance check (Section 7.8.4) should include several frequencies within the radar detection bandwidth and frequencies near the edge of the radar detection bandwidth. For 802.11 devices it is suggested to select frequencies in each of the bonded 20 MHz channels and the channel center frequency.		

Table 3: DFS Detection Thresholds for Master Devices and Client Devices With Radar Detection

Maximum Transmit Power	Value (See Notes 1, 2, and 3)
EIRP \geq 200 milliwatt	-64 dBm
EIRP < 200 milliwatt and power spectral density < 10 dBm/MHz	-62 dBm
EIRP < 200 milliwatt that do not meet the power spectral density requirement	-64 dBm
<p>Note 1: This is the level at the input of the receiver assuming a 0 dBi receive antenna.</p> <p>Note 2: Throughout these test procedures an additional 1 dB has been added to the amplitude of the test transmission waveforms to account for variations in measurement equipment. This will ensure that the test signal is at or above the detection threshold level to trigger a DFS response.</p> <p>Note 3: EIRP is based on the highest antenna gain. For MIMO devices refer to KDB Publication 662911 D01.</p>	

Table 4: DFS Response Requirement Values

Parameter	Value
<i>Non-occupancy period</i>	Minimum 30 minutes
<i>Channel Availability Check Time</i>	60 seconds
<i>Channel Move Time</i>	10 seconds See Note 1.
<i>Channel Closing Transmission Time</i>	200 milliseconds + an aggregate of 60 milliseconds over remaining 10 second period. See Notes 1 and 2.
<i>U-NII Detection Bandwidth</i>	Minimum 100% of the U- NII 99% transmission power bandwidth. See Note 3.
<p>Note 1: <i>Channel Move Time</i> and the <i>Channel Closing Transmission Time</i> should be performed with Radar Type 0. The measurement timing begins at the end of the Radar Type 0 burst.</p> <p>Note 2: The <i>Channel Closing Transmission Time</i> is comprised of 200 milliseconds starting at the beginning of the <i>Channel Move Time</i> plus any additional intermittent control signals required to facilitate a <i>Channel move</i> (an aggregate of 60 milliseconds) during the remainder of the 10 second period. The aggregate duration of control signals will not count quiet periods in between transmissions.</p> <p>Note 3: During the <i>U-NII Detection Bandwidth</i> detection test, radar type 0 should be used. For each frequency step the minimum percentage of detection is 90 percent. Measurements are performed with no data traffic.</p>	

Table 5 – Short Pulse Radar Test Waveforms

Radar Type	Pulse Width (μsec)	PRI (μsec)	Number of Pulses	Minimum Percentage of Successful Detection	Minimum Number of Trials
0	1	1428	18	See Note 1	See Note 1
1	1	Test A: 15 unique PRI values randomly selected from the list of 23 PRI values in Table 5a	Roundup $\left\{ \left(\frac{1}{360} \right) \cdot \left(\frac{19 \cdot 10^6}{\text{PRI}_{\mu\text{sec}}} \right) \right\}$	60%	30
		Test B: 15 unique PRI values randomly selected within the range of 518-3066 μsec, with a minimum increment of 1 μsec, excluding PRI values selected in Test A			
2	1-5	150-230	23-29	60%	30
3	6-10	200-500	16-18	60%	30
4	11-20	200-500	12-16	60%	30
Aggregate (Radar Types 1-4)				80%	120
Note 1: Short Pulse Radar Type 0 should be used for the detection bandwidth test, channel move time, and channel closing time tests.					

A minimum of 30 unique waveforms are required for each of the Short Pulse Radar Types 2 through 4. If more than 30 waveforms are used for Short Pulse Radar Types 2 through 4, then each additional waveform must also be unique and not repeated from the previous waveforms. If more than 30 waveforms are used for Short Pulse Radar Type 1, then each additional waveform is generated with Test B and must also be unique and not repeated from the previous waveforms in Tests A or B.

For example if in Short Pulse Radar Type 1 Test B a PRI of 3066 usec is selected, the number of pulses

would be $\text{Roundup} \left\{ \left(\frac{1}{360} \right) \cdot \left(\frac{19 \cdot 10^6}{3066} \right) \right\} = \text{Roundup} \{17.2\} = 18.$

Table 5a - Pulse Repetition Intervals Values for Test A

Pulse Repetition Frequency Number	Pulse Repetition Frequency (Pulses Per Second)	Pulse Repetition Interval (Microseconds)
1	1930.5	518
2	1858.7	538
3	1792.1	558
4	1730.1	578
5	1672.2	598
6	1618.1	618
7	1567.4	638
8	1519.8	658
9	1474.9	678
10	1432.7	698
11	1392.8	718
12	1355	738
13	1319.3	758
14	1285.3	778
15	1253.1	798
16	1222.5	818
17	1193.3	838
18	1165.6	858
19	1139	878
20	1113.6	898
21	1089.3	918
22	1066.1	938
23	326.2	3066

The aggregate is the average of the percentage of successful detections of Short Pulse Radar Types 1-4. For example, the following table indicates how to compute the aggregate of percentage of successful detections.

Radar Type	Number of Trials	Number of Successful Detections	Minimum Percentage of Successful Detection
1	35	29	82.9%
2	30	18	60%
3	30	27	90%
4	50	44	88%
Aggregate $(82.9\% + 60\% + 90\% + 88\%)/4 = 80.2\%$			

Table 6 – Long Pulse Radar Test Waveform

Radar Type	Pulse Width (μsec)	Chirp Width (MHz)	PRI (μsec)	Number of Pulses per <i>Burst</i>	Number of <i>Bursts</i>	Minimum Percentage of Successful Detection	Minimum Number of Trials
5	50-100	5-20	1000-2000	1-3	8-20	80%	30

Table 7 – Frequency Hopping Radar Test Waveform

Radar Type	Pulse Width (μsec)	PRI (μsec)	Pulses per Hop	Hopping Rate (kHz)	Hopping Sequence Length (msec)	Minimum Percentage of Successful Detection	Minimum Number of Trials
6	1	333	9	0.333	300	70%	30

DFS Measurement System

BACL DFS measurement system consists of two subsystems: (1) The radar signal generating subsystem and (2) the traffic monitoring subsystem.

System Block Diagram

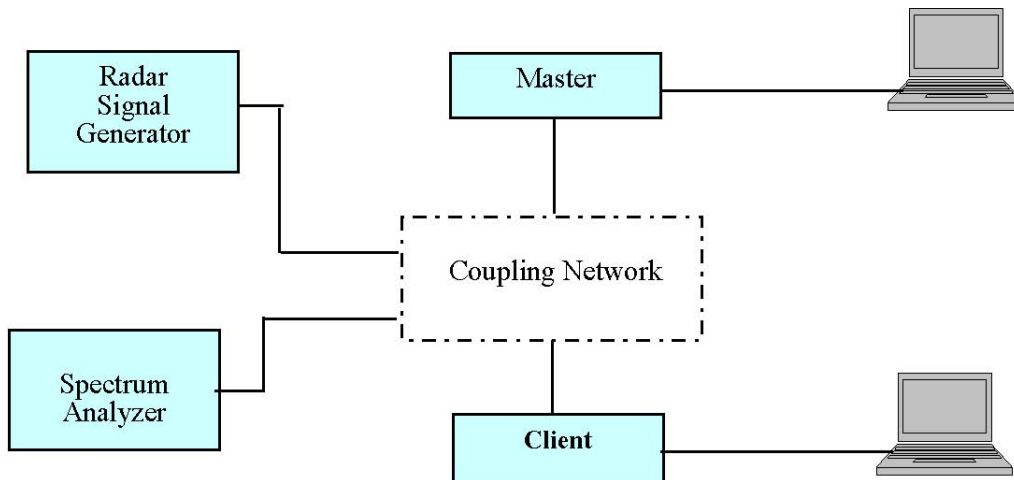

Conducted Method

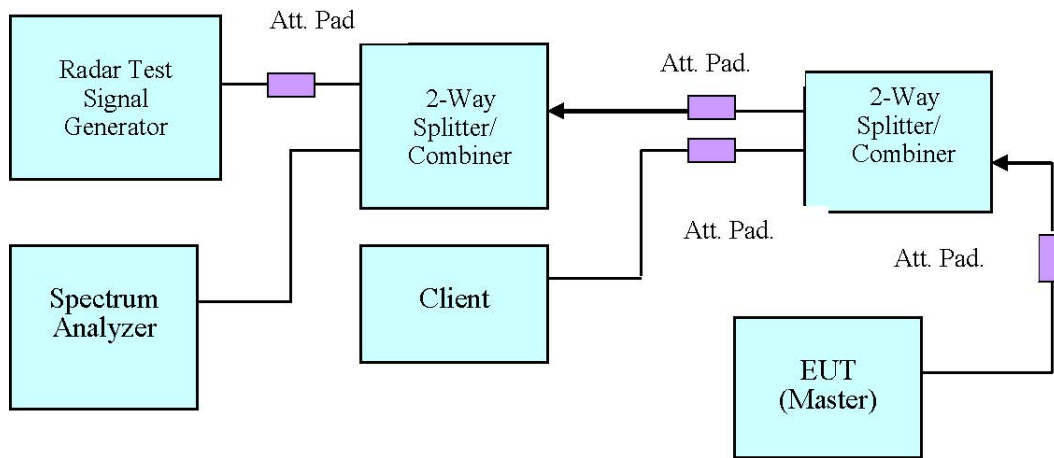

Setup for Master with injection at the Master

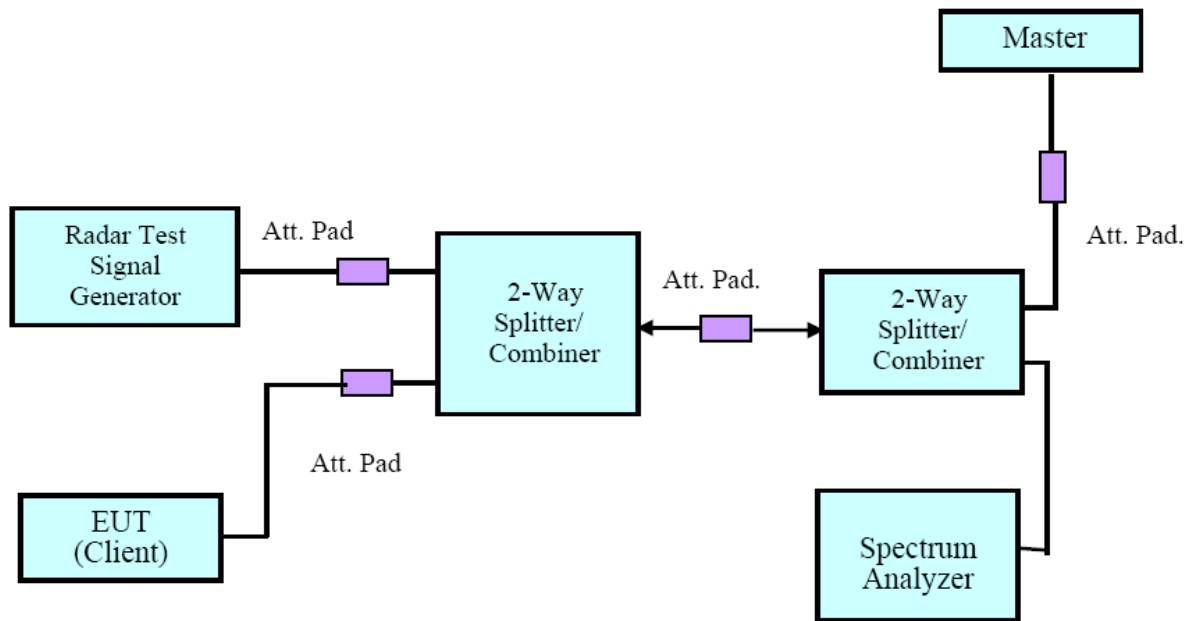

Setup for Client with injection at the Master

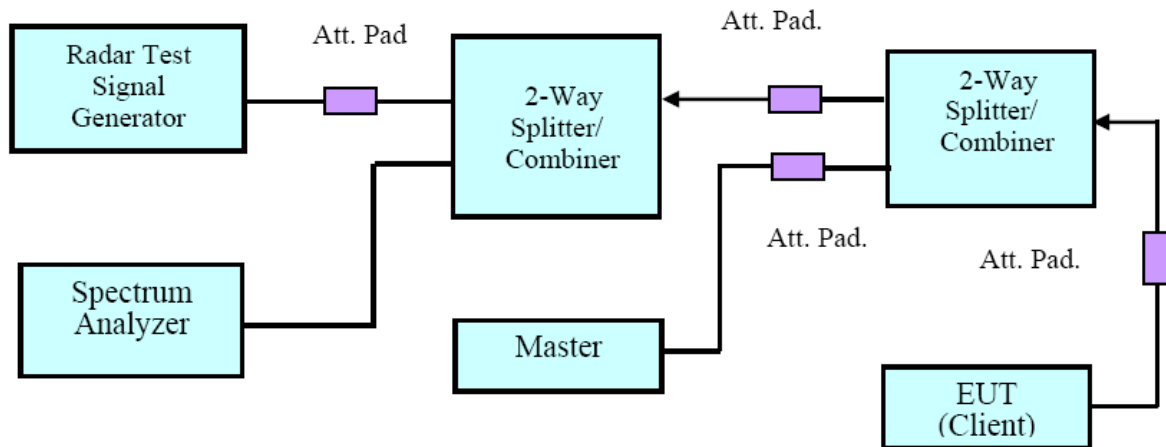

Setup for Client with injection at the Client

Radiated Method

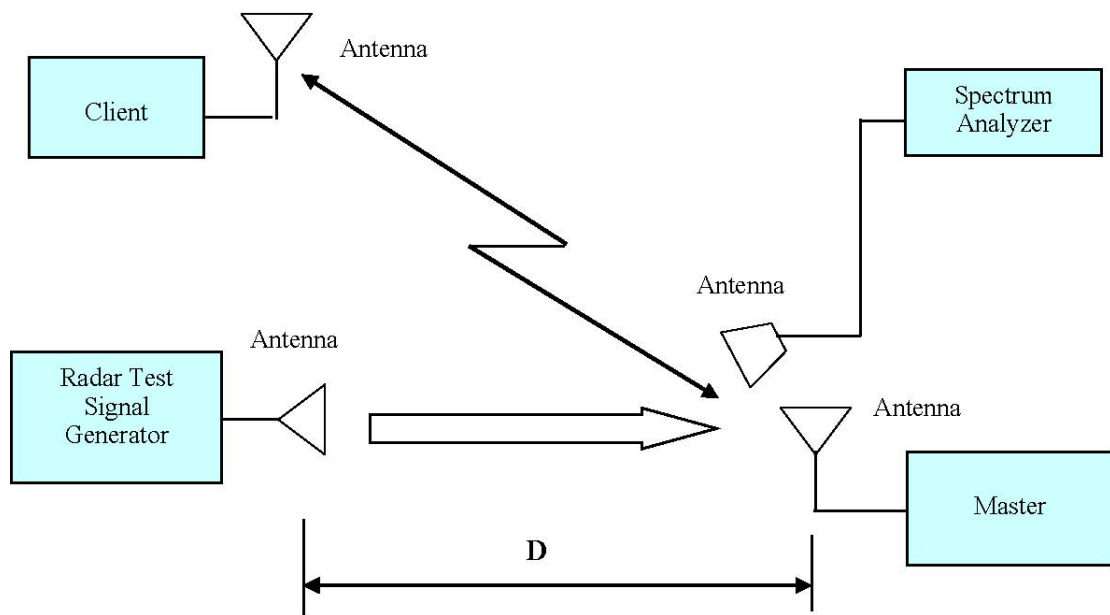

Test Procedure

A spectrum analyzer is used as a monitor verifies that the EUT status including Channel Closing Transmission Time and Channel Move Time, and does not transmit on a Channel during the Non-Occupancy Period after the diction and Channel move. It is also used to monitor EUT transmissions during the Channel Availability Check Time.

TEST RESULTS

Description of EUT

The calibrated radiated DFS detection threshold level is set to -64 dBm is more stringent.

WLAN traffic is generated by streaming the video file TestFile.mpg, this file is used by IP and Frame based systems for loading the test channel during the In-service compliance testing of the U-NII device. The file is streamed from the Access Point to the Client in full motion video mode using the media player with the V2.61 Codec package.

Test Equipment List and Details

Manufacturer	Description	Model	Serial Number	Calibration Date	Calibration Due Date
National Instruments	NI PXI-1042 8-Slot chassis	PXI-1042	VOBX40FBD	N/A	N/A
National Instruments	Arbitrary Waveform Generator	PXI-5421	N/A	N/A	N/A
National Instruments	RF Upconverter	PXI-5610	N/A	N/A	N/A
ASCOR	Upconverter	AS-7202	N/A	N/A	N/A
Agilent	Spectrum Analyzer	E4440A	SG43360054	2019-05-09	2020-05-09
Ditorn	Splitter/Combiner	D3C4080	SN2244	N/A	N/A
TDK RF	Horn Antenna	HRN-0118	130 084	2017-01-05	2020-01-04
ETS LINDGREN	Horn Antenna	3115	000 527 35	2017-01-05	2020-01-04

* **Statement of Traceability:** Bay Area Compliance Laboratories Corp. (Dongguan) attests that all calibrations have been performed, traceable to National Primary Standards and International System of Units (SI).

Radar Waveform Calibration

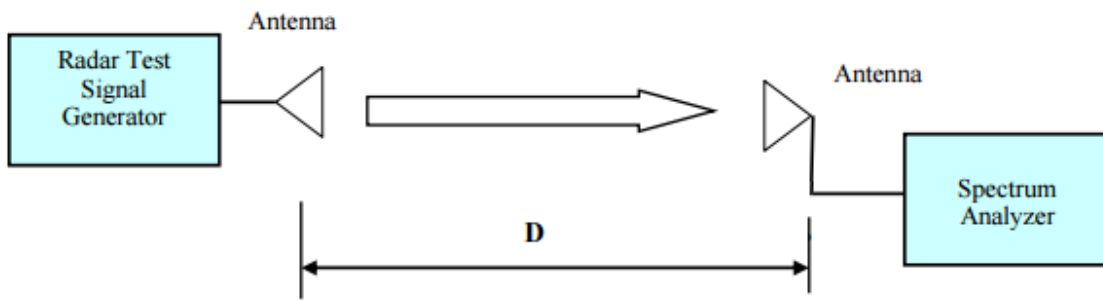

Radiated Calibration Setup Block Diagram

Test Environmental Conditions

Temperature:	22.8~23.4 °C
Relative Humidity:	35~59 %
ATM Pressure:	101.2 kPa
Tester:	Vern Shen
Test Date:	2019-11-28~2019-12-12

Plots of Radar Waveforms

5290 MHz:

Radar Type 0

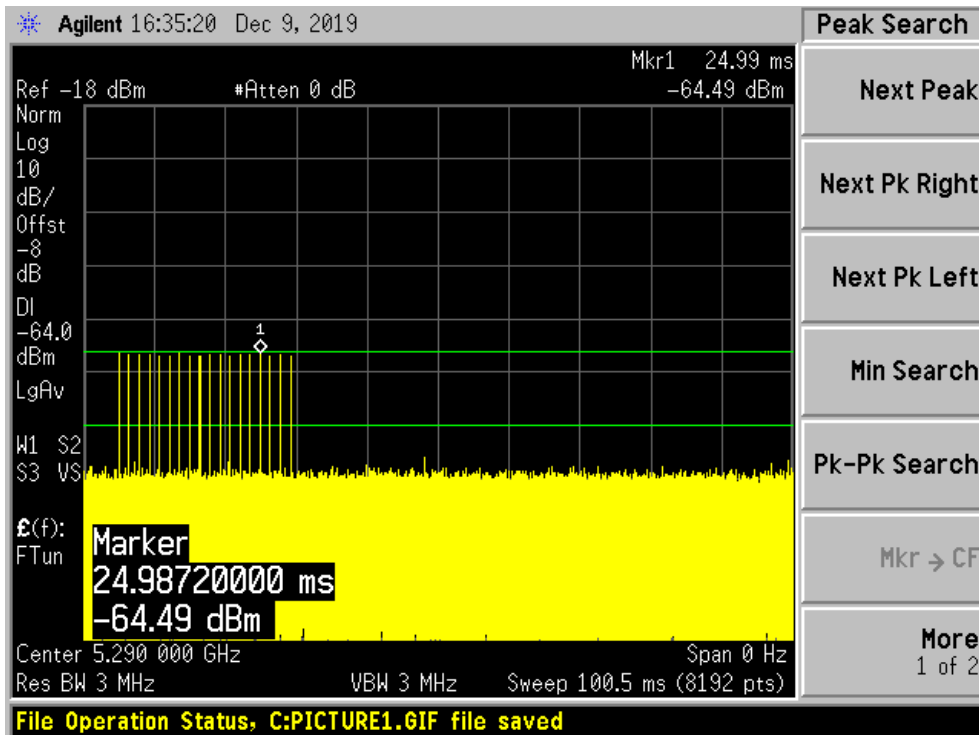

Radar Type 1A

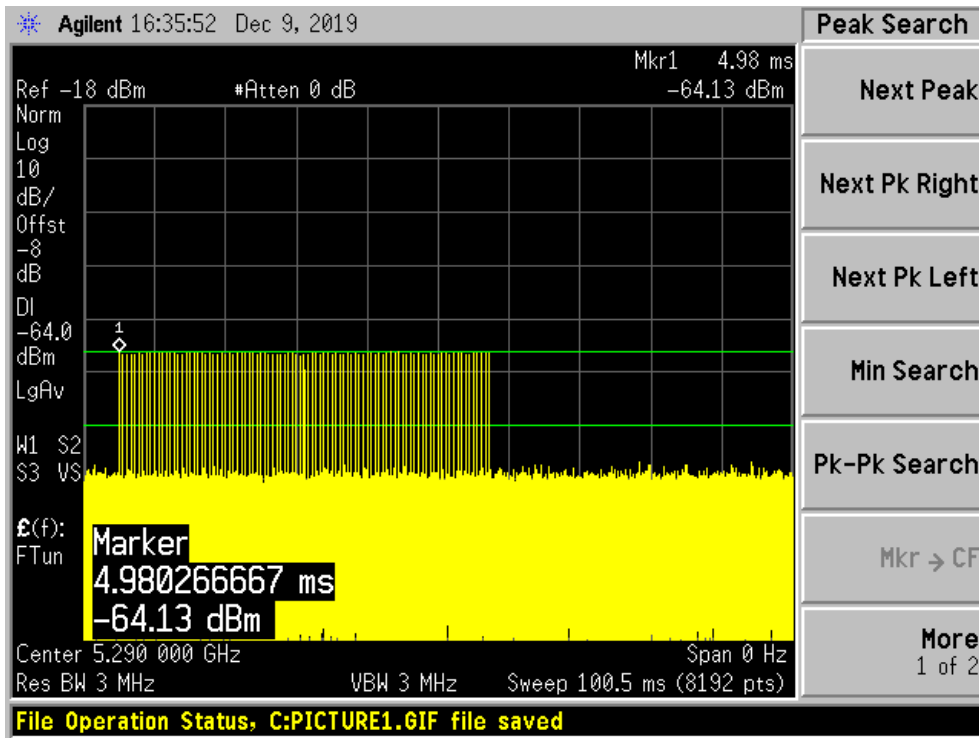

Radar Type 1B

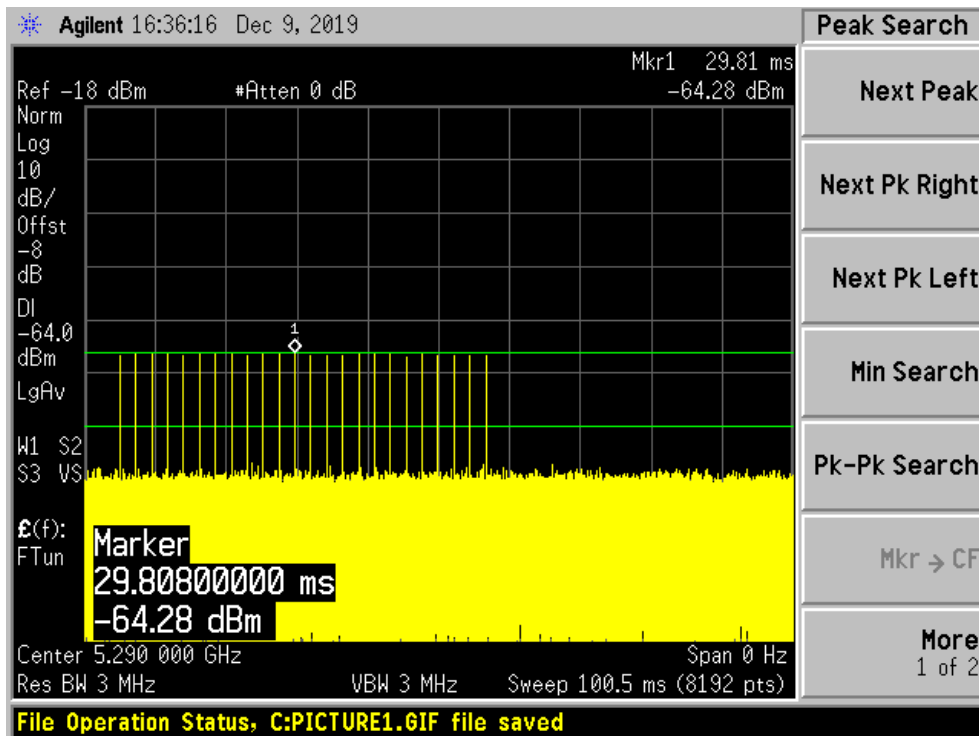

Radar Type 2

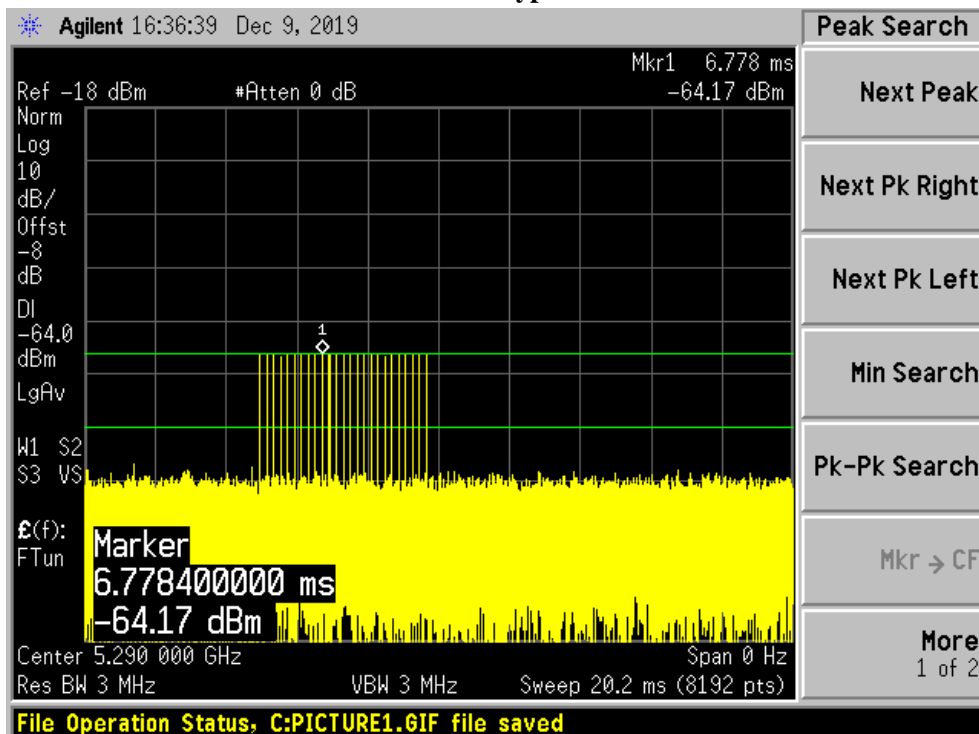

Radar Type 3

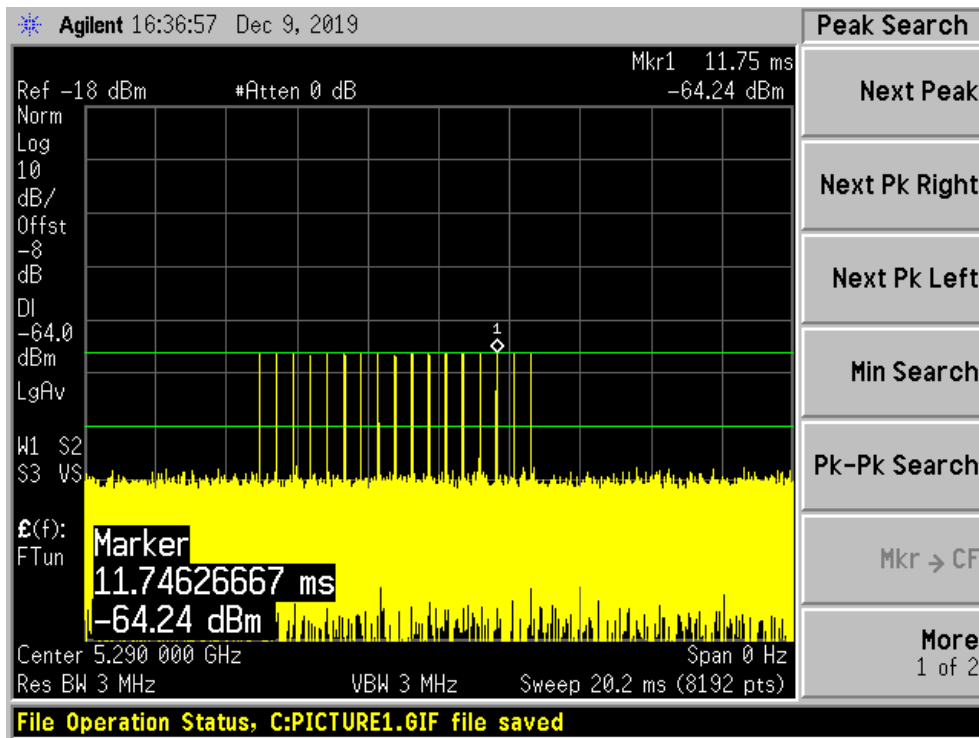

Radar Type 4

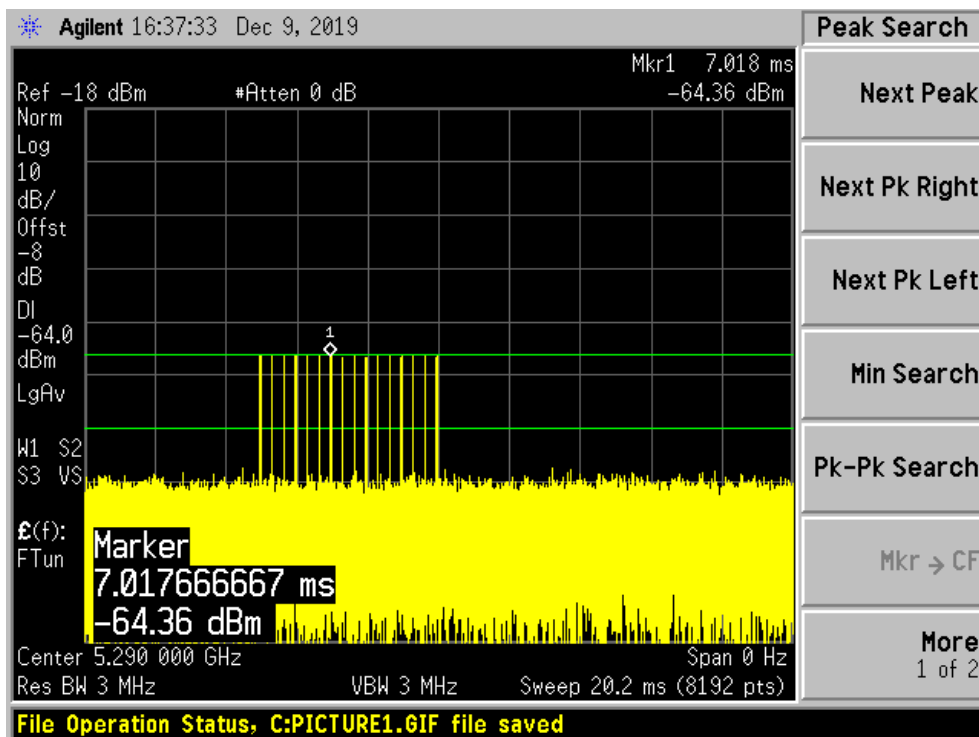

Radar Type 5 Case 1

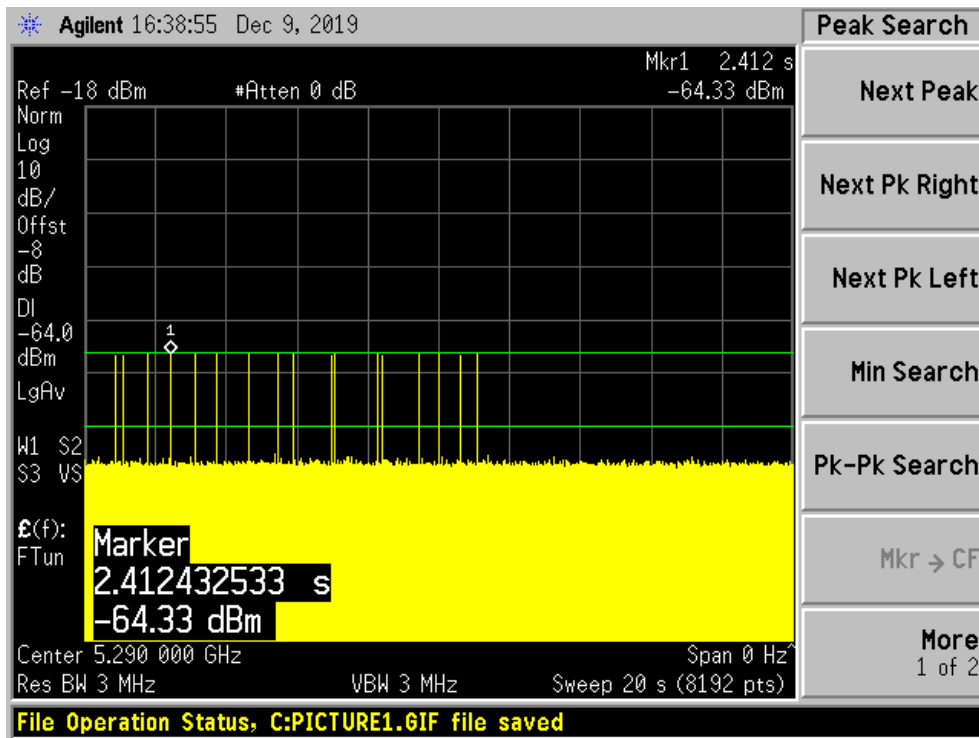

Radar Type 5 Case 2

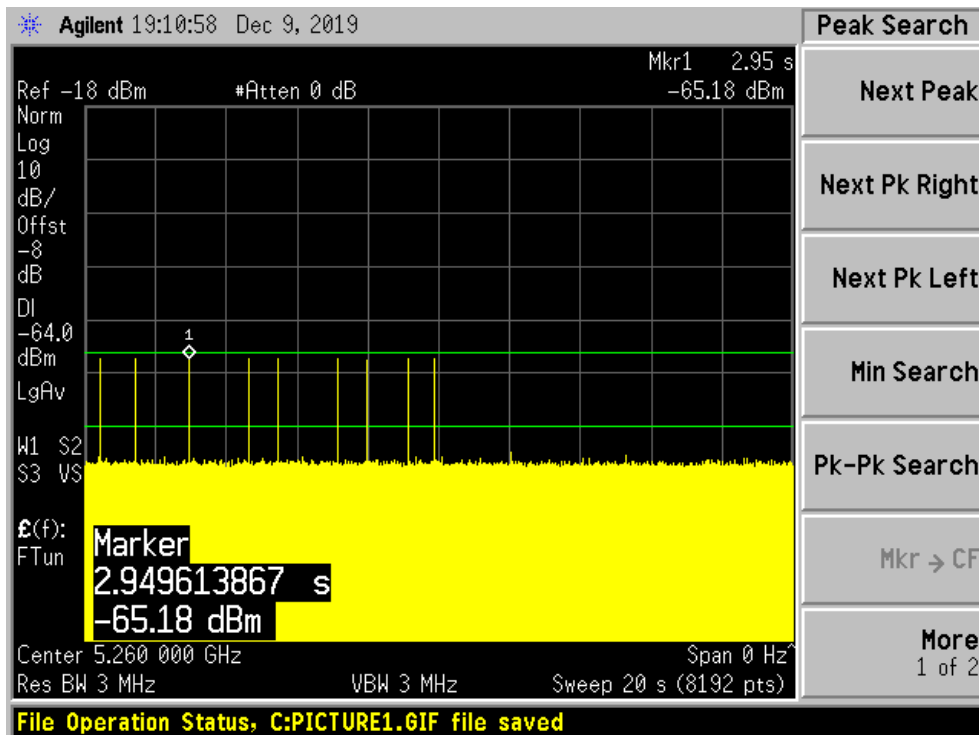

Radar Type 5 Case 3

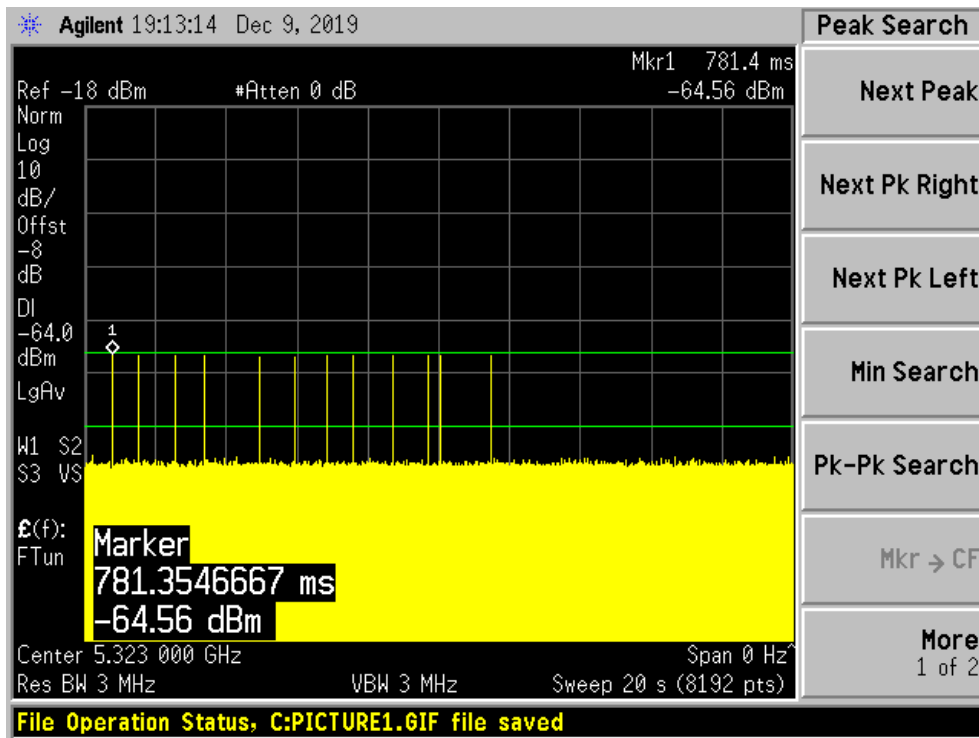

Radar Type 6

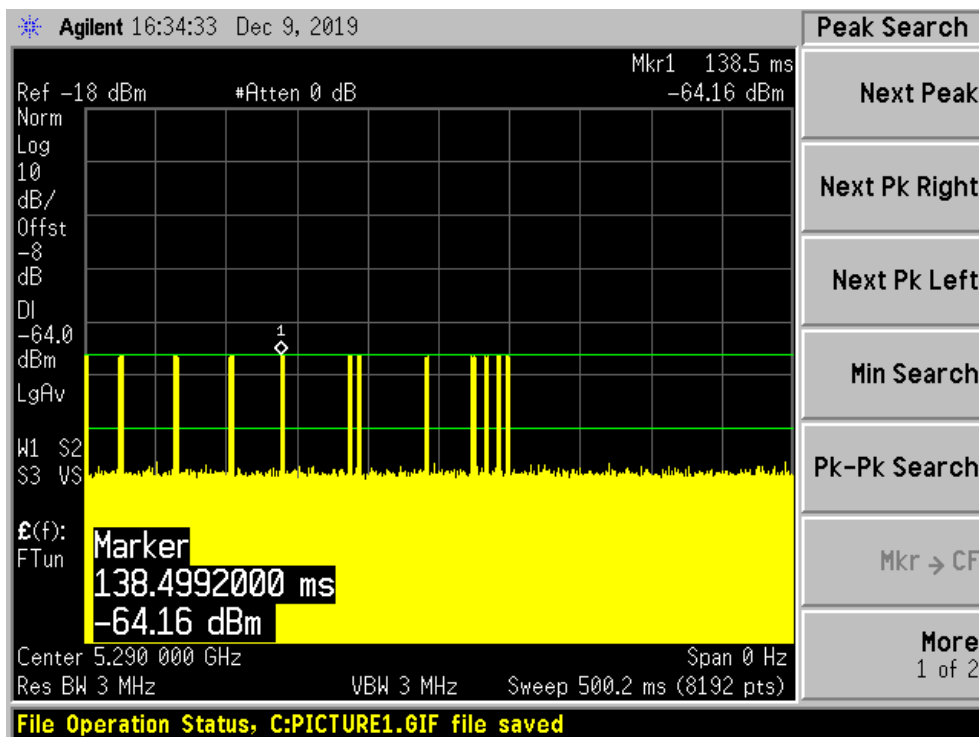

CHANNEL AVAILABILITY CHECK TIME (CAC)

Test Procedure

- 1) Channel Availability Check Time (CAC)
- 2) With link established on channel, apply a radar signal within 0~6 seconds after the initial power-up period; monitor the transmissions on channel from the spectrum analyzer.
- 3) Reboot EUT, with a link established on channel, apply a radar signal within 54~60 seconds after the initial power-up period, and monitor the transmission on channel from the spectrum analyzer.

EUT Initial power-up Cycle Time

Test Frequency (MHz)	EUT initial Power-up cycle (Second)
5260	76.6

Results:

Timing of Radar Burst	Spectrum Analyzer Display
No Radar Triggered	Transmission begin after power-up cycle +60 seconds CAC
Within 6 seconds of the CAC starting	No transmission
Within the last 6 seconds of the CAC	No transmission

Please refer to the following plots.

Radio, 5260 MHz:

Plot of without Radar signal applied

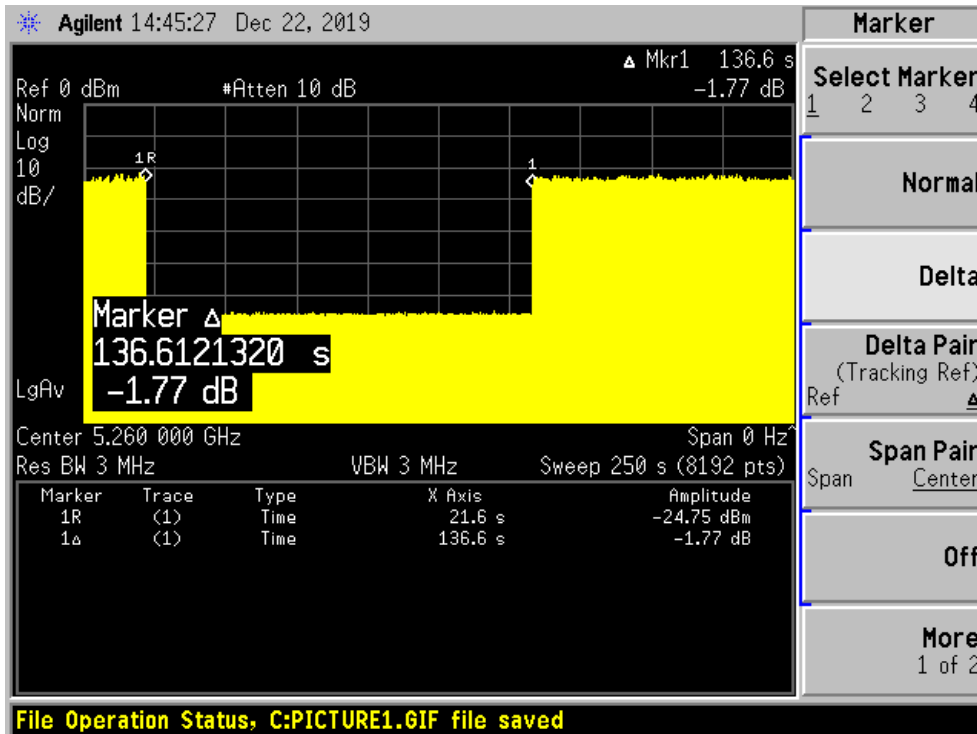

Note: The power-up cycle is 76.6 seconds.

Plot of Radar signal applied within 6 seconds of start of CAC

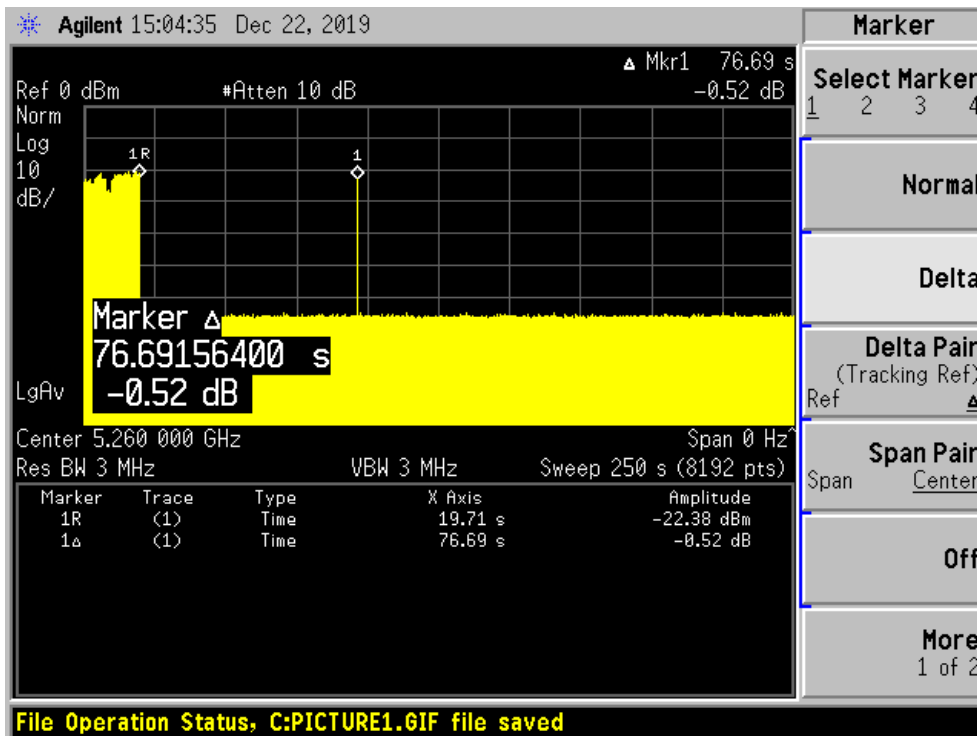

No transmissions found after radar signal applied.

Plot of Radar signal applied at the end of 6 seconds of CAC

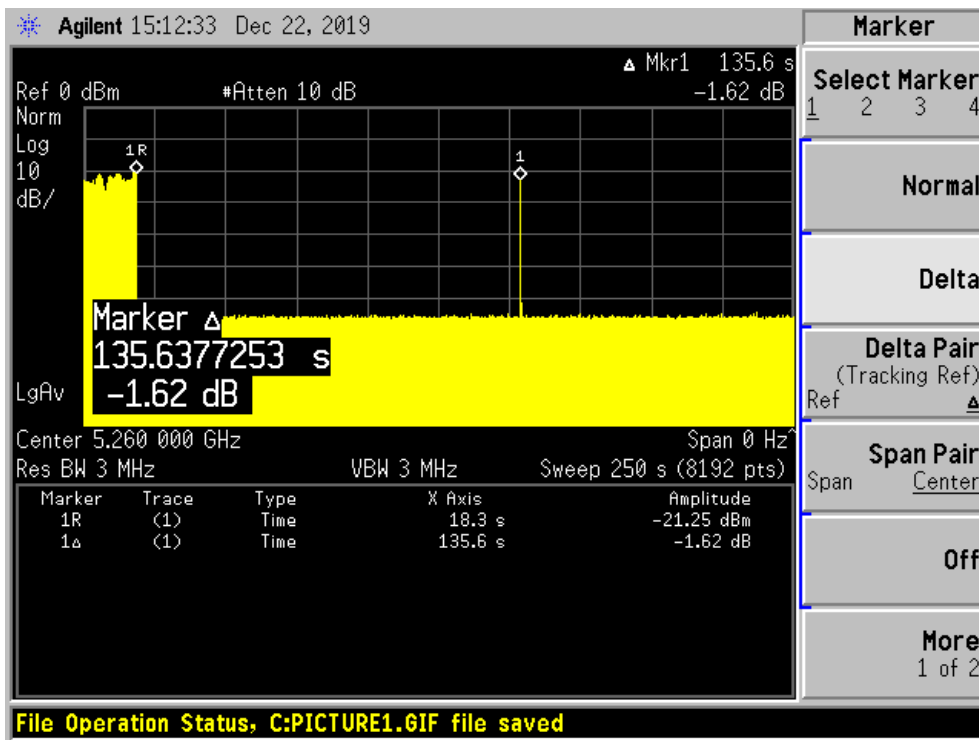

No transmissions found after radar signal applied.

CHANNEL MOVE TIME AND CHANNEL CLOSING TRANSMISSION TIME

Test Procedure

Perform type 0 short pulse radar waveform, repeat using a long pulse radar type5 waveform.
The aggregate channel closing transmission time is calculated as follows:

Aggregate Transmission Time = N*Dwell Time

N is the number of spectrum analyzer bins showing a device transmission Dwell Time is the dwell time per bin (i.e. Dwell Time = S/B, S is the sweep time and B is the number of bin, i.e. 8192)

Test Results

Frequency (MHz)	Bandwidth (MHz)	Radar Type	Results
5290	80	Type 0	Compliant

Please refer to the following tables and plots.

5290 MHz

Type 0 radar channel move time result:

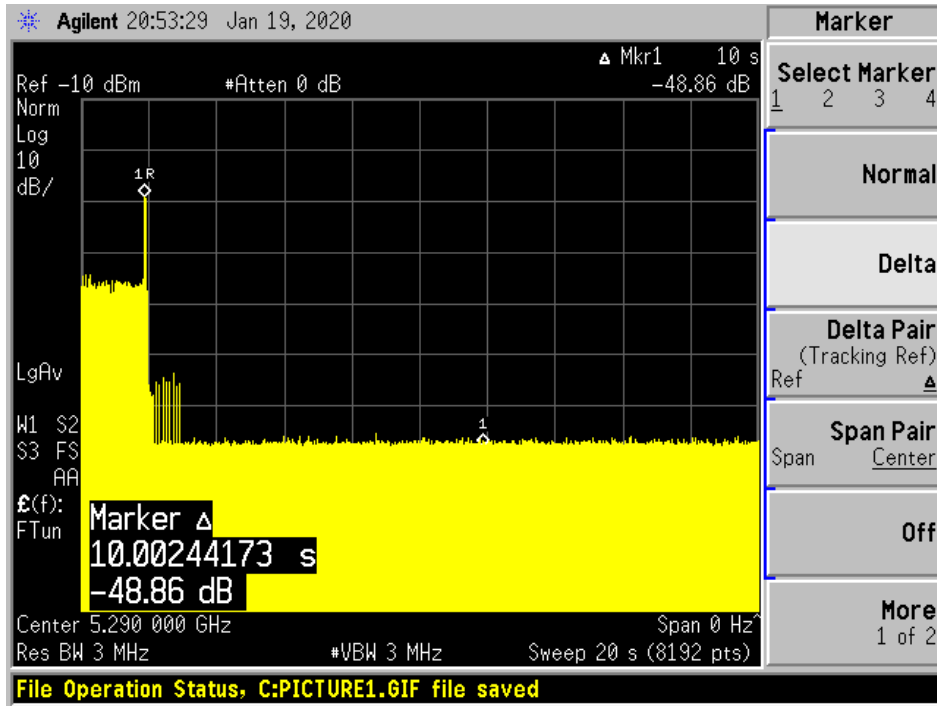

Type0 radar channel closing transmission time result:

Transmission After 200ms	Aggregate Transmission Time After 200ms Delay (ms)	Limit for Aggregate Transmission Time After 200ms Delay (ms)	Result
Yes	21.97	60	Pass

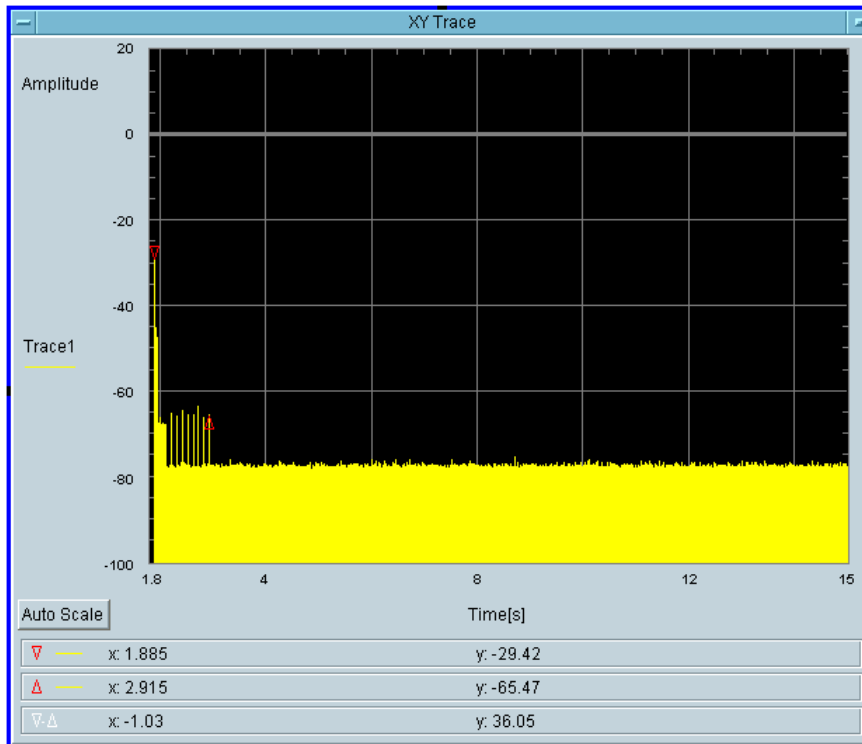

Total On Time [s]
0.1147

Total On Time After Delay [s]
21.97m

NON-OCCUPANCY PERIOD

Test Procedure

Measure the EUT for more than 30 minutes following the channel close/move time to verify that the EUT does not resume any transmissions on this channel. Provide one plot to demonstrate no transmission on the channel for the non-occupancy period (30 minutes observation time)

Test Result

Frequency(MHz)	Bandwidth (MHz)	Spectrum Analyzer Display
5290	80	No transmission within 30 minutes

Please refer to the following plots.

5290 MHz

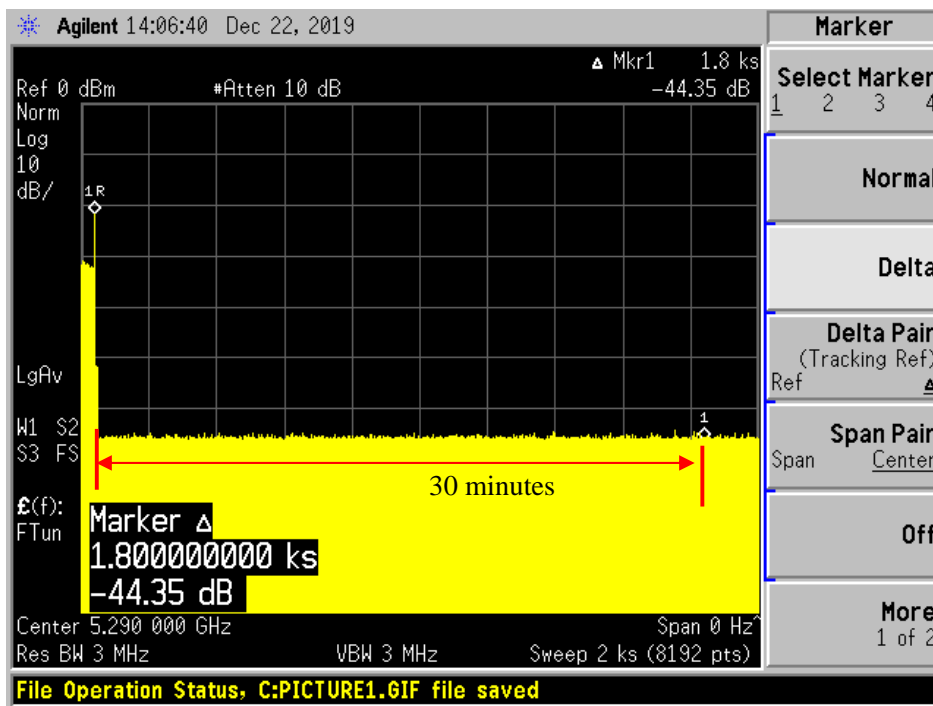

DETECTION BANDWIDTH

Test Procedure

Performed with Type 0 radar waveforms

Starting at the center frequency of the UUT operating *Channel*, increase the radar frequency in 5 MHz steps, repeating the above test sequence, until the detection rate falls below the *U-NII Detection Bandwidth* criterion specified in **Table 4**. Repeat this measurement in 1MHz steps at frequencies 5 MHz below where the detection rate begins to fall. Record the highest frequency (denote as F_H) at which detection is greater than or equal to the *U-NII Detection Bandwidth* criterion. Recording the detection rate at frequencies above F_H is not required to demonstrate compliance.

Starting at the center frequency of the UUT operating *Channel*, decrease the radar frequency in 5 MHz steps, repeating the above test sequence, until the detection rate falls below the *U-NII Detection Bandwidth* criterion specified in **Table 4**. Repeat this measurement in 1MHz steps at frequencies 5 MHz above where the detection rate begins to fall. Record the lowest frequency (denote as F_L) at which detection is greater than or equal to the *U-NII Detection Bandwidth* criterion. Recording the detection rate at frequencies below F_L is not required to demonstrate compliance.

The *U-NII Detection Bandwidth* is calculated as follows:

$$U-NII\ Detection\ Bandwidth = F_H - F_L$$

The *U-NII Detection Bandwidth* must meet the *U-NII Detection Bandwidth* criterion specified in **Table 4**. Otherwise, the UUT does not comply with DFS requirements. This is essential to ensure that the UUT is capable of detecting *Radar Waveforms* across the same frequency spectrum that contains the significant energy from the system. In the case that the *U-NII Detection Bandwidth* is greater than or equal to the 99 percent power bandwidth for the measured F_H and F_L , the test can be truncated and the *U-NII Detection Bandwidth* can be reported as the measured F_H and F_L .

Test Result

Frequency (MHz)	Bandwidth Systems (MHz)	F _L (MHz)	F _H (MHz)	Detection Bandwidth (MHz)	99% Occupied Bandwidth (MHz)	Minimum Limit	Result
5260	20	5250	5270	20	17.756	100%	Compliance
5270	40	5250	5290	40	36.282	100%	Compliance
5290	80	5250	5330	80	75.641	100%	Compliance

Please refer to the following tables and plots.

Results of Detection Bandwidth:

20MHz Bandwidth, EUT Frequency = 5260MHz											
DFS Detection Trials (1 = Detected, 0 = No Detected)											
Radar Frequency (MHz)	1	2	3	4	5	6	7	8	9	10	Detection Rate (%)
5250(F_L)	1	1	1	1	1	1	1	1	1	1	100 %
5251	1	1	1	1	1	1	1	1	1	1	100 %
5252	1	1	1	1	1	1	1	1	1	1	100 %
5253	1	1	1	1	1	1	1	1	1	1	100 %
5254	1	1	1	1	1	1	1	1	1	1	100 %
5255	1	1	1	1	1	1	1	1	1	1	100 %
5260	1	1	1	1	1	1	1	1	1	1	100 %
5265	1	1	1	1	1	1	1	1	1	1	100 %
5266	1	1	1	1	1	1	1	1	1	1	100 %
5267	1	1	1	1	1	1	1	1	1	1	100 %
5268	1	1	1	1	1	1	1	1	1	1	100 %
5269	1	1	1	1	1	1	1	1	1	1	100 %
5270(F_H)	1	1	1	1	1	1	1	1	1	1	100 %
Detection Bandwidth = F _H - F _L = 5270-5250 = 20 MHz											
EUT 99% BW = 17.756 MHz;										Result: Pass	

40MHz Bandwidth, EUT Frequency = 5270 MHz											
DFS Detection Trials (1 = Detected, 0 = No Detected)											
Radar Frequency (MHz)	1	2	3	4	5	6	7	8	9	10	Detection Rate (%)
5250(F_L)	1	1	1	1	1	1	1	1	1	1	100 %
5251	1	1	1	1	1	1	1	1	1	1	100 %
5252	1	1	1	1	1	1	1	1	1	1	100 %
5253	1	1	1	1	1	1	1	1	1	1	100 %
5254	1	1	1	1	1	1	1	1	1	1	100 %
5255	1	1	1	1	1	1	1	1	1	1	100 %
5260	1	1	1	1	1	1	1	1	1	1	100 %
5265	1	1	1	1	1	1	1	1	1	1	100 %
5270	1	1	1	1	1	1	1	1	1	1	100 %
5275	1	1	1	1	1	1	1	1	1	1	100 %
5280	1	1	1	1	1	1	1	1	1	1	100 %
5285	1	1	1	1	1	1	1	1	1	1	100 %
5286	1	1	1	1	1	1	1	1	1	1	100 %
5287	1	1	1	1	1	1	1	1	1	1	100 %
5288	1	1	1	1	1	1	1	1	1	1	100 %
5289	1	1	1	1	1	1	1	1	1	1	100 %
5290(F_H)	1	1	1	1	1	1	1	1	1	1	100 %
Detection Bandwidth = F _H - F _L = 5290-5250 = 40 MHz											
EUT 99% BW = 36.282 MHz;											Result: Pass

80MHz Bandwidth, EUT Frequency = 5290 MHz											
DFS Detection Trials (1 = Detected, 0 = No Detected)											
Radar Frequency (MHz)	1	2	3	4	5	6	7	8	9	10	Detection Rate (%)
5250(F_L)	1	1	1	1	1	1	1	1	1	1	100 %
5251	1	1	1	1	1	1	1	1	1	1	100 %
5252	1	1	1	1	1	1	1	1	1	1	100 %
5253	1	1	1	1	1	1	1	1	1	1	100 %
5254	1	1	1	1	1	1	1	1	1	1	100 %
5255	1	1	1	1	1	1	1	1	1	1	100 %
5260	1	1	1	1	1	1	1	1	1	1	100 %
5265	1	1	1	1	1	1	1	1	1	1	100 %
5270	1	1	1	1	1	1	1	1	1	1	100 %
5275	1	1	1	1	1	1	1	1	1	1	100 %
5280	1	1	1	1	1	1	1	1	1	1	100 %
5285	1	1	1	1	1	1	1	1	1	1	100 %
5290	1	1	1	1	1	1	1	1	1	1	100 %
5295	1	1	1	1	1	1	1	1	1	1	100 %
5300	1	1	1	1	1	1	1	1	1	1	100 %
5305	1	1	1	1	1	1	1	1	1	1	100 %
5310	1	1	1	1	1	1	1	1	1	1	100 %
5315	1	1	1	1	1	1	1	1	1	1	100 %
5320	1	1	1	1	1	1	1	1	1	1	100 %
5325	1	1	1	1	1	1	1	1	1	1	100 %
5326	1	1	1	1	1	1	1	1	1	1	100 %
5327	1	1	1	1	1	1	1	1	1	1	100 %
5328	1	1	1	1	1	1	1	1	1	1	100 %
5329	1	1	1	1	1	1	1	1	1	1	100 %
5330(F_H)	1	1	1	1	1	1	1	1	1	1	100 %
Detection Bandwidth = F _H – F _L = 5330-5250 = 80 MHz											
EUT 99% BW =75.641 MHz;											Result: Pass

STATISTICAL PERFORMANCE CHECK

Procedure:

The steps below define the procedure to determine the minimum percentage of successful detection requirements found in **Tables 5-7** when a radar burst with a level equal to the *DFS Detection Threshold + 1dB* is generated on the *Operating Channel* of the U-NII device (*In-Service Monitoring*).

- a) One frequency will be chosen from the *Operating Channels* of the UUT within the 5250-5350 MHz or 5470-5725 MHz bands.
- b) In case the UUT is a U-NII device operating as a Client Device (with or without Radar Detection), a U-NII device operating as a Master Device will be used to allow the UUT (Client device) to Associate with the Master Device. In case the UUT is a Master Device, a U-NII device operating as a Client Device will be used and it is assumed that the Client will Associate with the UUT (Master). In both cases for conducted tests, the Radar Waveform generator will be connected to the Master Device. For radiated tests, the emissions of the Radar Waveform generator will be directed towards the Master Device. If the Master Device has antenna gain, the main beam of the antenna will be directed toward the radar emitter. Vertical polarization is used for testing.
- c) Stream the channel loading test file from the *Master Device* to the Client Device on the test *Channel* for the entire period of the test.
- d) At time T_0 the *Radar Waveform* generator sends the individual waveform for each of the Radar Types 1- 6 in **Tables 5-7**, at levels defined in **Table 3**, on the *Operating Channel*. An additional 1 dB is added to the radar test signal to ensure it is at or above the *DFS Detection Threshold*, accounting for equipment variations/errors.
- e) Observe the transmissions of the UUT at the end of the Burst on the *Operating Channel* for duration greater than 10 seconds for Radar Type 0 to ensure detection occurs.
- f) Observe the transmissions of the UUT at the end of the Burst on the *Operating Channel* for duration greater than 22 seconds for Long Pulse Radar Type 5 to ensure detection occurs.
- g) In case the UUT is a U-NII device operating as a *Client Device* with *In-Service Monitoring*, perform steps a) to f).

Result:**20MHz**

Radar SignalType	Waveform/Trial Number	Detection (%)	Limit (%)	Pass/Fail
Type 1A	15	100%	60%	pass
Type 1B	15	100%	60%	pass
Type 2	30	83.33 %	60%	Pass
Type 3	30	83.33 %	60%	Pass
Type 4	30	86.67 %	60%	Pass
Aggregate (Type1 to 4)	30	88.33 %	80%	Pass
Type 5	30	100 %	80%	Pass
Type 6	30	100 %	70%	Pass

Please refer to the following statistical tables:

5260MHz**Radar Type 1A Statistical Performance**

Trial #	Fc (MHz)	Pulse/Burst	Pulse Width (μS)	PRI (μs)	Detection (1:yes; 0:no)
1	5260	95	1	558	1
2	5260	89	1	598	1
3	5260	63	1	838	1
4	5260	59	1	898	1
5	5260	92	1	578	1
6	5260	74	1	718	1
7	5260	58	1	918	1
8	5260	67	1	798	1
9	5260	57	1	938	1
10	5260	65	1	818	1
11	5260	81	1	658	1
12	5260	86	1	618	1
13	5260	83	1	638	1
14	5260	68	1	778	1
15	5260	78	1	678	1
Detection Percentage: 100 % (>60%)					

Radar Type 1B Statistical Performance

Trial #	Fc (MHz)	Pulse/Burst	Pulse Width (μS)	PRI (μs)	Detection (1:yes; 0:no)
1	5260	38	1	1408	1
2	5260	18	1	2981	1
3	5260	28	1	1941	1
4	5260	75	1	705	1
5	5260	29	1	1873	1
6	5260	43	1	1250	1
7	5260	21	1	2620	1
8	5260	18	1	2984	1
9	5260	23	1	2322	1
10	5260	51	1	1050	1
11	5260	36	1	1499	1
12	5260	20	1	2762	1
13	5260	24	1	2240	1
14	5260	31	1	1729	1
15	5260	38	1	1392	1
Detection Percentage: 100 % (>60%)					

Radar Type 2 Statistical Performance

Trial #	Fc (MHz)	Pulse/Burst	Pulse Width (μS)	PRI (μs)	Detection (1:yes; 0:no)
1	5260	26	2.4	190	1
2	5260	23	4.5	174	1
3	5260	28	1.1	197	1
4	5260	28	4.3	157	1
5	5260	29	3.8	174	0
6	5260	26	2.8	191	1
7	5260	29	2.8	183	1
8	5260	28	4.2	213	1
9	5260	23	1.1	190	1
10	5260	28	1.4	218	1
11	5260	24	2.7	201	1
12	5260	25	3.3	185	1
13	5260	28	2.4	209	0
14	5260	23	4.2	216	1
15	5260	25	4.4	212	0
16	5260	27	3.8	170	1
17	5260	29	4.7	210	1
18	5260	24	2.5	212	1
19	5260	26	4.7	160	1
20	5260	23	3.1	177	1
21	5260	27	1.8	216	1
22	5260	29	3.6	152	1
23	5260	25	3.1	191	0
24	5260	25	2.5	166	0
25	5260	27	4.5	179	1
26	5260	24	3.7	186	1
27	5260	25	1.9	228	1
28	5260	28	1.7	216	1
29	5260	24	4.8	163	1
30	5260	28	1.8	195	1
Detection Percentage: 83.33 % (>60%)					

Radar Type 3 Statistical Performance

Trial #	Fc (MHz)	Pulse/Burst	Pulse Width (μS)	PRI (μs)	Detection (1:yes; 0:no)
1	5260	16	9.1	313	0
2	5260	18	7.9	224	1
3	5260	17	9.2	225	1
4	5260	18	6.9	366	1
5	5260	17	7.6	415	1
6	5260	16	6.7	456	1
7	5260	18	6.8	493	1
8	5260	16	8.1	319	1
9	5260	17	8	439	1
10	5260	16	9.3	293	1
11	5260	17	9.2	382	1
12	5260	16	8.3	282	1
13	5260	16	9.5	458	1
14	5260	16	7.8	359	1
15	5260	18	7.5	313	1
16	5260	18	8.1	464	1
17	5260	17	7.1	443	0
18	5260	17	6.8	330	1
19	5260	16	7.5	256	1
20	5260	16	7.2	267	1
21	5260	17	7.7	409	1
22	5260	17	8.4	465	1
23	5260	16	8.3	304	1
24	5260	16	6.9	319	0
25	5260	16	7.7	215	0
26	5260	16	8.1	299	0
27	5260	16	9.9	405	1
28	5260	18	7.2	244	1
29	5260	18	7.7	493	1
30	5260	17	8.5	299	1
Detection Percentage: 83.33 % (>60%)					

Radar Type 4 Statistical Performance

Trial #	Fc (MHz)	Pulse/Burst	Pulse Width (μS)	PRI (μs)	Detection (1:yes; 0:no)
1	5260	12	11.5	277	1
2	5260	14	16.8	258	1
3	5260	14	12.7	290	1
4	5260	12	12.2	257	1
5	5260	13	12.2	213	1
6	5260	16	15.4	376	1
7	5260	16	12.2	302	0
8	5260	16	13.6	289	1
9	5260	15	15.4	303	1
10	5260	13	15.4	234	0
11	5260	14	13.6	417	1
12	5260	15	11.7	468	1
13	5260	14	18.1	446	1
14	5260	13	19.6	388	1
15	5260	12	20	470	0
16	5260	14	11.1	308	1
17	5260	12	12.5	262	0
18	5260	12	11.6	290	1
19	5260	13	18.7	465	1
20	5260	15	18.6	436	1
21	5260	13	11	239	1
22	5260	16	19.6	325	1
23	5260	14	17.6	226	1
24	5260	14	13.4	469	1
25	5260	15	14.5	408	1
26	5260	16	19.6	465	1
27	5260	16	12.9	306	1
28	5260	13	11.8	351	1
29	5260	13	19.7	211	1
30	5260	12	11.5	280	1
Detection Percentage: 86.67 % (>60%)					

Radar Type 5 Case 1 Statistical Performance

Statistics 1 (ChirpCenter Frequency: 5260.0MHz)

Trial #	Pulse	Chirp(MHz)	Pulse Width (µS)	Pulse 1-2 spacing(µS)	Pulse 2-3 spacing(µS)	Pulse Start(S)	Detection (1:yes;0:no)
0	1	14	82.5			0.832524	1
1	1	14	80.2			1.270932	
2	2	14	91.5	1308		2.047417	
3	3	14	95.5	1987	1184	2.939009	
4	1	14	50.1			3.883053	
5	3	14	98.5	1152	1938	4.368655	
6	2	14	71.9	1772		5.90725	
7	1	14	93.8			6.338295	
8	2	14	59.2	1653		7.17165	
9	2	14	75.3	1855		7.823199	
10	2	14	86.3	1477		9.13925	
11	2	14	51	1685		9.788363	
12	1	14	57.2			10.53948	
13	3	14	80.7	1324	1748	11.50987	

Statistics 2 (ChirpCenter Frequency: 5260.0 MHz)

Trial #	Pulse	Chirp(MHz)	Pulse Width (µS)	Pulse 1-2 spacing(µS)	Pulse 2-3 spacing(µS)	Pulse Start(S)	Detection (1:yes;0:no)
0	1	10	96.6			0.048982	1
1	2	10	86.7	1970		1.414782	
2	1	10	87.5			2.520097	
3	2	10	80.3	1276		3.602774	
4	2	10	72.3	1425		5.072628	
5	3	10	64.5	1434	1330	6.101459	
6	3	10	76.7	1101	1348	8.205889	
7	3	10	88.3	1997	1854	9.367844	
8	3	10	62.3	1798	1940	10.58726	
9	3	10	65.4	1939	1243	10.82466	

Statistics 3 (ChirpCenter Frequency: 5260.0 MHz)

Trial #	Pulse	Chirp(MHz)	Pulse Width (μS)	Pulse 1-2 spacing(μS)	Pulse 2-3 spacing(μS)	Pulse Start(S)	Detection (1:yes;0:no)
0	3	12	54	1367	1280	0.951751	1
1	1	12	99.8			1.563624	
2	3	12	90.1	1469	1302	2.687546	
3	2	12	79.4	1632		4.104672	
4	2	12	52	1468		4.902166	
5	3	12	55.7	1303	1796	5.664936	
6	2	12	77.4	1069		7.098686	
7	3	12	84.2	1914	1765	8.271846	
8	2	12	77.4	1328		9.801992	
9	2	12	54.1	1345		9.927266	
10	1	12	74.1			11.560834	

Statistics 4 (ChirpCenter Frequency: 5260.0 MHz)

Trial #	Pulse	Chirp(MHz)	Pulse Width (μS)	Pulse 1-2 spacing(μS)	Pulse 2-3 spacing(μS)	Pulse Start(S)	Detection (1:yes;0:no)
0	1	12	52.9			0.25252	1
1	2	12	56.8	1785		0.841163	
2	2	12	79.2	1353		2.049835	
3	1	12	73.7			2.23635	
4	2	12	99	1936		3.219837	
5	1	12	92.4			3.864924	
6	3	12	91.9	1667	1955	4.302619	
7	2	12	94.2	1682		5.414593	
8	2	12	61.1	1151		6.05425	
9	3	12	68.3	1777	1661	6.531854	
10	2	12	77.1	1435		7.466532	
11	2	12	93.9	1374		8.163298	
12	1	12	83.9			8.735428	
13	1	12	52.8			9.852411	
14	2	12	62.8	1230		10.53121	
15	3	12	80.2	1650	1145	11.28426	
16	3	12	70.4	1664	1765	11.34956	

Statistics 5(ChirpCenter Frequency: 5260.0 MHz)

Trial #	Pulse	Chirp(MHz)	Pulse Width (μS)	Pulse 1-2 spacing(μS)	Pulse 2-3 spacing(μS)	Pulse Start(S)	Detection (1:yes;0:no)
0	1	5	76.4			0.948344	1
1	1	5	68.1			1.752313	
2	2	5	75.4	1500		3.476339	
3	2	5	70.7	1250		4.656319	
4	2	5	56.6	1797		5.034434	
5	1	5	76.6			6.040096	
6	1	5	98.7			7.792981	
7	1	5	96.8			9.205321	
8	1	5	86.6			10.70598	
9	2	5	80.3	1316		10.98903	

Statistics 6 (ChirpCenter Frequency: 5260.0 MHz)

Trial #	Pulse	Chirp(MHz)	Pulse Width (μS)	Pulse 1-2 spacing(μS)	Pulse 2-3 spacing(μS)	Pulse Start(S)	Detection (1:yes;0:no)
0	1	15	66			0.689376	1
1	2	15	68.2	1252		1.349655	
2	2	15	72.8	1772		2.140307	
3	2	15	96.5	1800		2.685893	
4	3	15	85.8	1106	1969	3.927	
5	1	15	88			4.501414	
6	2	15	87.3	1484		5.600336	
7	3	15	67.8	1859	1435	6.71606	
8	1	15	91.8			6.912207	
9	2	15	81.8	1323		8.272324	
10	2	15	75.1	1066		8.799073	
11	2	15	92.2	1369		9.679331	
12	3	15	69.3	1523	1572	10.98081	
13	2	15	59.7	1042		11.47443	

Statistics 7(ChirpCenter Frequency: 5260.0 MHz)

Trial #	Pulse	Chirp(MHz)	Pulse Width (μS)	Pulse 1-2 spacing(μS)	Pulse 2-3 spacing(μS)	Pulse Start(S)	Detection (1:yes;0:no)
0	2	12	96.8	1150		0.031454	1
1	1	12	58.9			1.022564	
2	3	12	60.7	1048	1308	1.661239	
3	1	12	68.5			2.622827	
4	3	12	67.7	1139	1792	3.528599	
5	1	12	88.6			4.196966	
6	2	12	95	1141		4.762772	
7	1	12	86.9			5.49433	
8	2	12	99.1	1960		6.661378	
9	3	12	51.4	1781	1553	6.827085	
10	2	12	87.2	1543		7.685278	
11	2	12	88.3	1755		8.526587	
12	3	12	60	1698	1951	9.672852	
13	1	12	52.8			10.15132	
14	3	12	92.2	1496	1632	10.56319	
15	2	12	86.1	1949		11.89202	

Statistics 8 (ChirpCenter Frequency: 5260.0 MHz)

Trial #	Pulse	Chirp(MHz)	Pulse Width (μS)	Pulse 1-2 spacing(μS)	Pulse 2-3 spacing(μS)	Pulse Start(S)	Detection (1:yes;0:no)
0	1	8	78.6			0.026787	1
1	3	8	53.1	1535	1566	1.59584	
2	1	8	98.4			4.223096	
3	3	8	70.1	1860	1219	5.907549	
4	2	8	58.5	1760		7.229727	
5	3	8	52.7	1973	1834	8.451199	
6	2	8	51.8	1803		9.393458	
7	1	8	95.2			10.79237	

Statistics 9 (ChirpCenter Frequency: 5260.0 MHz)

Trial #	Pulse	Chirp(MHz)	Pulse Width (μS)	Pulse 1-2 spacing(μS)	Pulse 2-3 spacing(μS)	Pulse Start(S)	Detection (1:yes;0:no)
0	1	10	92			0.42741	1
1	1	10	78.2			1.027799	
2	2	10	87.9	1098		1.942872	
3	1	10	92.4			2.46366	
4	1	10	61.8			3.131539	
5	3	10	54	1353	1579	3.477346	
6	1	10	90.1			4.193442	
7	3	10	82	1232	1050	5.277948	
8	2	10	59.1	1617		5.56646	
9	3	10	70.4	1290	1319	6.144865	
10	3	10	86.4	1644	1824	6.714002	
11	2	10	62.8	1104		7.664603	
12	2	10	92.4	1941		8.374971	
13	2	10	78.9	1805		9.18779	
14	1	10	81.6			9.74566	
15	3	10	91	1027	1961	10.44839	
16	2	10	51	1152		11.25495	
17	2	10	72.9	1723		11.64313	

Statistics 10 (ChirpCenter Frequency: 5260.0 MHz)

Trial #	Pulse	Chirp(MHz)	Pulse Width (μS)	Pulse 1-2 spacing(μS)	Pulse 2-3 spacing(μS)	Pulse Start(S)	Detection (1:yes;0:no)
0	2	13	53.1	1681		0.770975	1
1	2	13	75.4	1073		1.321732	
2	2	13	55.9	1580		1.856235	
3	2	13	55.1	1974		3.130556	
4	1	13	74.8			3.750143	
5	1	13	86.4			4.84227	
6	3	13	71.7	1216	1410	5.889582	
7	2	13	52.3	1523		6.400795	
8	2	13	85.8	1308		7.28347	
9	2	13	50.8	1388		7.799075	
10	2	13	84	1527		8.811334	
11	2	13	86.9	1596		9.580476	
12	1	13	52.8			10.5236	
13	1	13	71.5			11.19955	

Radar Type 5 Case 2 Statistical Performance

Statistics 1 (ChirpCenter Frequency: 5257.0 MHz)

Trial #	Pulse	Chirp(MHz)	Pulse Width (μS)	Pulse 1-2 spacing(μS)	Pulse 2-3 spacing(μS)	Pulse Start(S)	Detection (1:yes;0:no)
0	2	18	52.9	1135		0.29032	1
1	1	18	88.7			0.942205	
2	3	18	62.6	1288	1989	1.23801	
3	3	18	73.4	1555	1477	1.893442	
4	2	18	76.4	1287		2.529278	
5	2	18	60.1	1126		3.410608	
6	3	18	81.8	1042	1586	3.622879	
7	3	18	53.9	1143	1568	4.325545	
8	2	18	66.9	1255		5.238159	
9	2	18	59.1	1993		5.633709	
10	3	18	61	1381	1684	6.309131	
11	3	18	67.4	1602	1495	6.812107	
12	1	18	64.8			7.289388	
13	3	18	88.9	1819	1228	8.330841	
14	2	18	85.4	1881		8.689103	
15	2	18	98.3	1095		9.275726	
16	3	18	99.7	1985	1995	9.978444	
17	2	18	92	1286		10.36768	
18	2	18	57.5	1757		11.29586	
19	3	18	52	1379	1307	11.89451	

Statistics 2 (ChirpCenter Frequency: 5254.0 MHz)

Trial #	Pulse	Chirp(MHz)	Pulse Width (μS)	Pulse 1-2 spacing(μS)	Pulse 2-3 spacing(μS)	Pulse Start(S)	Detection (1:yes;0:no)
0	1	9	92.4			0.093947	1
1	3	9	51.3	1970	1680	1.645966	
2	3	9	71.2	1525	1408	2.033222	
3	3	9	97.8	1179	1775	3.862927	
4	1	9	69.1			4.091777	
5	1	9	96.2			5.772856	
6	3	9	67.3	1358	1657	6.721996	
7	1	9	60.1			7.24015	
8	2	9	59.3	1969		8.744218	
9	2	9	77.6	1552		9.518881	
10	2	9	86.1	1921		10.70056	
11	3	9	99.1	1671	1561	11.17018	

Statistics 3 (ChirpCenter Frequency: 5254.0 MHz)

Trial #	Pulse	Chirp(MHz)	Pulse Width (µS)	Pulse 1-2 spacing(µS)	Pulse 2-3 spacing(µS)	Pulse Start(S)	Detection (1:yes;0:no)
0	3	9	66.7	1944	1408	0.046703	1
1	2	9	78.5	1002		0.79371	
2	2	9	62.1	1091		1.527018	
3	2	9	95.7	1421		2.539391	
4	2	9	75.6	1884		2.890622	
5	2	9	73.3	1436		3.460532	
6	1	9	70.8			4.329523	
7	2	9	70.7	1675		4.732391	
8	2	9	73.9	1546		5.338887	
9	2	9	98.5	1119		6.250127	
10	1	9	52.8			6.797232	
11	2	9	74.9	1923		7.822291	
12	3	9	52.3	1624	1156	8.177025	
13	1	9	51.3			9.163074	
14	1	9	82.9			9.649787	
15	3	9	59.4	1054	1697	10.08388	
16	2	9	80.5	1883		11.18431	
17	2	9	50.8	1045		11.34963	

Statistics 4 (ChirpCenter Frequency: 5254.0 MHz)

Trial #	Pulse	Chirp(MHz)	Pulse Width (µS)	Pulse 1-2 spacing(µS)	Pulse 2-3 spacing(µS)	Pulse Start(S)	Detection (1:yes;0:no)
0	1	11	88.4			0.380164	1
1	1	11	86.1			1.76301	
2	2	11	50.3	1829		2.537058	
3	1	11	55.6			3.531484	
4	3	11	90.7	1297	1780	4.981323	
5	3	11	63.8	1873	1366	5.896032	
6	2	11	60.1	1623		6.913163	
7	3	11	83.5	1997	1272	7.165425	
8	2	11	66.3	1031		8.714912	
9	3	11	95.4	1798	1775	9.327795	
10	2	11	60.1	1560		10.96056	
11	3	11	97.9	1040	1055	11.60554	

Statistics 5 (ChirpCenter Frequency: 5257.0 MHz)

Trial #	Pulse	Chirp(MHz)	Pulse Width (μS)	Pulse 1-2 spacing(μS)	Pulse 2-3 spacing(μS)	Pulse Start(S)	Detection (1:yes;0:no)
0	2	18	92.4	1601		0.520156	1
1	1	18	79.7			1.171482	
2	2	18	53.7	1726		1.965114	
3	1	18	52.9			2.101995	
4	2	18	59.1	1110		3.173295	
5	3	18	92.3	1765	1852	3.522964	
6	2	18	84.5	1042		4.211161	
7	2	18	71.4	1310		4.971932	
8	2	18	57	1435		5.689914	
9	2	18	75.8	1531		6.525969	
10	2	18	68.4	1837		7.127784	
11	2	18	65.4	1724		7.883414	
12	1	18	51.4			8.485176	
13	1	18	74			9.145988	
14	3	18	55.2	1644	1338	9.780264	
15	1	18	89.8			10.42874	
16	2	18	87.3	1090		11.14774	
17	2	18	65.3	1819		11.50016	

Statistics 6 (ChirpCenter Frequency: 5256.0 MHz)

Trial #	Pulse	Chirp(MHz)	Pulse Width (μS)	Pulse 1-2 spacing(μS)	Pulse 2-3 spacing(μS)	Pulse Start(S)	Detection (1:yes;0:no)
0	2	14	61.9	1410		0.847165	1
1	2	14	86.4	1122		1.574008	
2	1	14	61.3			2.630194	
3	3	14	74.7	1696	1999	3.174896	
4	2	14	51.5	1120		4.815448	
5	1	14	92.4			5.530886	
6	2	14	66.6	1570		6.661701	
7	2	14	68.9	1033		7.281823	
8	3	14	53.8	1567	1335	8.055894	
9	1	14	89.5			9.680807	
10	2	14	85	1230		10.63601	
11	1	14	67			11.73147	

Statistics 7 (ChirpCenter Frequency: 5256.0 MHz)

Trial #	Pulse	Chirp(MHz)	Pulse Width (μS)	Pulse 1-2 spacing(μS)	Pulse 2-3 spacing(μS)	Pulse Start(S)	Detection (1:yes;0:no)
1	3	14	76	1833	1155	0.44075	1
2	2	14	52.5	1293		1.101946	
3	2	14	73.2	1840		1.859994	
4	1	14	76.2			2.199716	
5	2	14	77.4	1650		2.920291	
6	2	14	60.5	1935		3.220744	
7	1	14	87.2			3.892357	
8	1	14	96.3			4.964479	
9	3	14	87.7	1903	1828	5.151377	
10	2	14	65.9	1693		5.966422	
11	1	14	92.8			6.615351	
12	1	14	85.1			7.379526	
13	1	14	55.2			7.599302	
14	2	14	81	1915		8.777246	
15	1	14	72.7			9.043695	
16	1	14	61.5			10.02277	
17	2	14	85.4	1987		10.19498	
18	1	14	92.8			11.07247	

Statistics 8 (ChirpCenter Frequency: 5253.0 MHz)

Trial #	Pulse	Chirp(MHz)	Pulse Width (μS)	Pulse 1-2 spacing(μS)	Pulse 2-3 spacing(μS)	Pulse Start(S)	Detection (1:yes;0:no)
0	2	8	55.7	1314		0.456719	1
1	1	8	99.6			1.843539	
2	1	8	92.2			3.761167	
3	2	8	81.1	1239		5.987294	
4	2	8	60.4	1342		7.022622	
5	1	8	91.4			8.455151	
6	1	8	50.8			10.28006	
7	3	8	87.2	1834	1705	11.92691	

Statistics 9 (ChirpCenter Frequency: 5253.0 MHz)

Trial #	Pulse	Chirp(MHz)	Pulse Width (μS)	Pulse 1-2 spacing(μS)	Pulse 2-3 spacing(μS)	Pulse Start(S)	Detection (1:yes;0:no)
0	3	7	66.4	1396	1606	0.079301	1
1	2	7	67.5	1685		1.604196	
2	3	7	56.3	1477	1885	2.65854	
3	2	7	64.7	1600		3.933786	
4	1	7	61.4			5.384894	
5	3	7	92.5	1491	1329	6.306222	
6	3	7	85.4	1002	1810	7.054518	
7	2	7	92.9	1861		7.995749	
8	2	7	77.7	1965		8.850737	
9	2	7	90.5	1181		10.68934	
10	2	7	53.1	1369		11.81037	

Statistics 10 (ChirpCenter Frequency: 5253.0 MHz)

Trial #	Pulse	Chirp(MHz)	Pulse Width (µS)	Pulse 1-2 spacing(µS)	Pulse 2-3 spacing(µS)	Pulse Start(S)	Detection (1:yes;0:no)
0	2	7	91.6	1166		0.921815	1
1	2	7	54.9	1881		1.143228	
2	1	7	63.8			2.804678	
3	1	7	88.7			3.795693	
4	2	7	57.9	1760		4.300721	
5	2	7	67.9	1397		5.691182	
6	3	7	92.8	1282	1870	6.024624	
7	2	7	64.6	1104		7.183479	
8	3	7	90.8	1425	1906	8.641718	
9	2	7	63.3	1860		9.352713	
10	2	7	59.4	1880		10.23943	
11	3	7	70.2	1084	1229	11.0233	

Radar Type 5 Case 3 Statistical Performance

Statistics 1 (ChirpCenter Frequency: 5264.0 MHz)

Trial #	Pulse	Chirp(MHz)	Pulse Width (µS)	Pulse 1-2 spacing(µS)	Pulse 2-3 spacing(µS)	Pulse Start(S)	Detection (1:yes;0:no)
0	1	14	68.5			0.501094	1
1	1	14	79.5			1.135498	
2	2	14	51.7	1256		2.709546	
3	2	14	58.1	1750		3.348563	
4	3	14	71.3	1341	1966	4.626955	
5	1	14	64.4			6.420954	
6	2	14	92.5	1337		6.589142	
7	3	14	78.8	1660	1446	7.889912	
8	2	14	82.9	1302		9.331527	
9	2	14	84.2	1325		10.04888	
10	3	14	65.5	1600	1748	11.4302	

Statistics 2 (ChirpCenter Frequency: 5265.0 MHz)

Trial #	Pulse	Chirp(MHz)	Pulse Width (μS)	Pulse 1-2 spacing(μS)	Pulse 2-3 spacing(μS)	Pulse Start(S)	Detection (1:yes;0:no)
0	2	12	73	1559		0.074845	1
1	1	12	81			1.383353	
2	2	12	56.3	1576		1.998869	
3	2	12	82.6	1962		3.141508	
4	3	12	89.8	1134	1925	3.26113	
5	2	12	64.2	1932		4.621313	
6	2	12	63.9	1870		4.976206	
7	2	12	88	1502		5.883331	
8	1	12	72			7.001313	
9	3	12	62.1	1750	1848	7.917656	
10	2	12	65.4	1800		8.539285	
11	1	12	97			9.097727	
12	1	12	94.3			10.08381	
13	3	12	63.1	1265	1953	10.48288	
14	1	12	88.1			11.20497	

Statistics 3 (ChirpCenter Frequency: 5264.0 MHz)

Trial #	Pulse	Chirp(MHz)	Pulse Width (μS)	Pulse 1-2 spacing(μS)	Pulse 2-3 spacing(μS)	Pulse Start(S)	Detection (1:yes;0:no)
0	1	16	75.8			0.522113	1
1	2	16	82.1	1245		1.068823	
2	2	16	78.7	1805		2.548003	
3	1	16	56.5			2.923753	
4	1	16	79.7			3.748849	
5	3	16	88.4	1898	1809	5.522645	
6	2	16	95	1595		5.886925	
7	2	16	90.8	1836		6.661987	
8	1	16	91.4			7.971965	
9	1	16	87.5			8.796724	
10	1	16	83.1			9.548759	
11	1	16	71.2			10.39764	
12	2	16	72	1657		11.83781	

Statistics 4 (ChirpCenter Frequency: 5267.0 MHz)

Trial #	Pulse	Chirp(MHz)	Pulse Width (μS)	Pulse 1-2 spacing(μS)	Pulse 2-3 spacing(μS)	Pulse Start(S)	Detection (1:yes;0:no)
0	2	8	99.7	1880		0.113545	1
1	3	8	81.3	1600	1136	0.888635	
2	3	8	61.7	1414	1973	1.544834	
3	1	8	50.5			2.65199	
4	2	8	67.1	1870		3.099594	
5	2	8	80.2	1152		3.653181	
6	2	8	92.3	1020		4.221568	
7	2	8	64	1451		4.993406	
8	1	8	93.1			5.576812	
9	3	8	98.9	1474	1429	6.018725	
10	2	8	56.6	1614		7.303249	
11	2	8	94.4	1324		7.792616	
12	1	8	73.9			8.111281	
13	2	8	63.8	1729		9.024686	
14	1	8	69			9.376995	
15	2	8	97.9	1794		10.0908	
16	3	8	60.2	1466	1431	11.28334	
17	2	8	68.9	1511		11.62256	

Statistics 5 (ChirpCenter Frequency: 5266.0 MHz)

Trial #	Pulse	Chirp(MHz)	Pulse Width (μS)	Pulse 1-2 spacing(μS)	Pulse 2-3 spacing(μS)	Pulse Start(S)	Detection (1:yes;0:no)
0	1	11	67.2			0.453576	1
1	2	11	58.7	1039		1.196336	
2	3	11	91.3	1105	1858	2.064488	
3	3	11	92.6	1445	1354	2.663926	
4	2	11	50.9	1813		3.471054	
5	2	11	57	1088		4.692477	
6	2	11	79.7	1984		5.797332	
7	2	11	62.4	1923		6.19079	
8	2	11	56.8	1917		7.656473	
9	3	11	61.4	1921	1911	8.33236	
10	3	11	83.4	1158	1744	8.78142	
11	1	11	91.6			9.759514	
12	2	11	73.7	1511		10.50199	
13	2	11	60.1	1463		11.60111	

Statistics 6 (ChirpCenter Frequency: 5267.0 MHz)

Trial #	Pulse	Chirp(MHz)	Pulse Width (μS)	Pulse 1-2 spacing(μS)	Pulse 2-3 spacing(μS)	Pulse Start(S)	Detection (1:yes;0:no)
0	2	7	83	1761		0.005169	1
1	1	7	76.9			1.404714	
2	1	7	75.9			1.978933	
3	2	7	62	1942		2.642633	
4	2	7	86.4	1356		3.457818	
5	1	7	55.4			4.639257	
6	2	7	71.7	1892		4.96595	
7	2	7	98.1	1650		5.688215	
8	3	7	76	1012	1021	6.485267	
9	1	7	80.3			7.959511	
10	3	7	88	1139	1703	8.410115	
11	2	7	54.8	1943		9.475286	
12	2	7	99.7	1330		9.947573	
13	3	7	98	1055	1195	10.7935	
14	2	7	81.3	1667		11.23008	

Statistics 7 (ChirpCenter Frequency: 5268.0 MHz)

Trial #	Pulse	Chirp(MHz)	Pulse Width (μS)	Pulse 1-2 spacing(μS)	Pulse 2-3 spacing(μS)	Pulse Start(S)	Detection (1:yes;0:no)
0	3	9	92.8	1628	1854	0.812835	1
1	1	9	78			1.343551	
2	2	9	85.9	1528		2.443973	
3	2	9	61.2	1672		2.691173	
4	2	9	64.3	1915		4.088799	
5	1	9	80			4.84248	
6	1	9	98.3			5.668938	
7	3	9	66.2	1797	1962	6.572841	
8	3	9	87.9	1213	1695	7.196111	
9	2	9	73.6	1808		8.134568	
10	3	9	82.6	1156	1757	9.280825	
11	2	9	99.1	1747		9.925915	

Statistics 8 (ChirpCenter Frequency: 5262.0 MHz)

Trial #	Pulse	Chirp(MHz)	Pulse Width (μS)	Pulse 1-2 spacing(μS)	Pulse 2-3 spacing(μS)	Pulse Start(S)	Detection (1:yes;0:no)
0	3	19	82.1	1473	1731	0.07706	1
1	2	19	85	1053		1.152082	
2	2	19	54.8	1173		2.567175	
3	1	19	94.4			4.3588	
4	2	19	87.2	1101		4.583403	
5	2	19	79	1844		6.277356	
6	2	19	71.9	1712		7.453138	
7	3	19	64.5	1508	1050	8.437768	
8	1	19	51.8			9.262501	
9	3	19	50.4	1060	1706	10.66213	
10	2	19	51.7	1332		11.77972	

Statistics 9 (ChirpCenter Frequency: 5264.0 MHz)

Trial #	Pulse	Chirp(MHz)	Pulse Width (μS)	Pulse 1-2 spacing(μS)	Pulse 2-3 spacing(μS)	Pulse Start(S)	Detection (1:yes;0:no)
0	3	16	58.5	1640	1170	0.531441	1
1	2	16	76.9	1327		1.648882	
2	2	16	83.5	1543		3.110539	
3	2	16	82.4	1910		3.441138	
4	3	16	66.8	1268	1896	4.823707	
5	1	16	92.2			5.569615	
6	3	16	62.3	1283	1904	7.192661	
7	2	16	69.2	1099		8.327705	
8	2	16	69.6	1623		9.213044	
9	2	16	90.1	1435		10.55511	
10	2	16	52.1	1861		11.86275	

Statistics 10 (ChirpCenter Frequency: 5265.0 MHz)

Trial #	Pulse	Chirp(MHz)	Pulse Width (μS)	Pulse 1-2 spacing(μS)	Pulse 2-3 spacing(μS)	Pulse Start(S)	Detection (1:yes;0:no)
0	3	12	92.9	1931	1726	0.815889	1
1	2	12	98.1	1472		1.175058	
2	3	12	84.6	1495	1156	2.738063	
3	1	12	56.4			3.070968	
4	2	12	63.5	1993		4.397997	
5	3	12	89.5	1244	1162	5.039254	
6	2	12	59.3	1408		6.39996	
7	3	12	69	1641	1316	7.263548	
8	2	12	76.2	1426		7.537427	
9	1	12	71			8.551951	
10	2	12	61.4	1052		9.916759	
11	2	12	88	1658		10.36569	
12	2	12	50.9	1792		11.4533	

Radar Type 6 Statistical Performance

Trial #	Fc (MHz)	Pulse /Burst	Pulse Width (µS)	PRI (µs)	Detection (1:yes; 0:no)	Hopping Sequence (MHz)
1	5260	9	1	333	1	5613.0, 5594.0, 5259.0, 5516.0, 5627.0, 5530.0, 5556.0, 5282.0, 5721.0, 5644.0, 5555.0, 5583.0, 5322.0, 5391.0, 5683.0, 5607.0, 5335.0, 5371.0, 5257.0, 5577.0, 5437.0, 5705.0, 5365.0, 5353.0, 5584.0, 5675.0, 5471.0, 5558.0, 5338.0, 5603.0, 5701.0, 5619.0, 5261.0, 5708.0, 5602.0, 5401.0, 5521.0, 5722.0, 5605.0, 5388.0, 5549.0, 5509.0, 5580.0, 5673.0, 5505.0, 5325.0, 5356.0, 5662.0, 5618.0, 5651.0, 5696.0, 5309.0, 5671.0, 5624.0, 5300.0, 5609.0, 5585.0, 5330.0, 5694.0, 5640.0, 5576.0, 5383.0, 5699.0, 5421.0, 5685.0, 5310.0, 5385.0, 5396.0, 5293.0, 5476.0, 5657.0, 5260.0, 5393.0, 5350.0, 5593.0, 5645.0, 5497.0, 5574.0, 5611.0, 5532.0, 5320.0, 5271.0, 5442.0, 5692.0, 5529.0, 5590.0, 5571.0, 5711.0, 5432.0, 5405.0, 5351.0, 5496.0, 5572.0, 5534.0, 5292.0, 5666.0, 5628.0, 5280.0, 5465.0, 5519.0
2	5260	9	1	333	1	5602.0, 5713.0, 5462.0, 5295.0, 5681.0, 5671.0, 5291.0, 5566.0, 5364.0, 5715.0, 5656.0, 5267.0, 5553.0, 5292.0, 5298.0, 5711.0, 5460.0, 5403.0, 5635.0, 5368.0, 5290.0, 5461.0, 5271.0, 5679.0, 5426.0, 5284.0, 5536.0, 5518.0, 5308.0, 5258.0, 5356.0, 5661.0, 5493.0, 5261.0, 5668.0, 5252.0, 5697.0, 5622.0, 5490.0, 5506.0, 5688.0, 5724.0, 5456.0, 5517.0, 5655.0, 5289.0, 5524.0, 5283.0, 5630.0, 5472.0, 5342.0, 5446.0, 5449.0, 5498.0, 5318.0, 5389.0, 5274.0, 5664.0, 5424.0, 5586.0, 5260.0, 5647.0, 5383.0, 5552.0, 5694.0, 5300.0, 5561.0, 5350.0, 5299.0, 5487.0, 5381.0, 5388.0, 5455.0, 5507.0, 5504.0, 5636.0, 5653.0, 5400.0, 5669.0, 5604.0, 5703.0, 5409.0, 5324.0, 5539.0, 5614.0, 5467.0, 5508.0, 5475.0, 5722.0, 5445.0, 5317.0, 5482.0, 5277.0, 5651.0, 5667.0, 5362.0, 5712.0, 5642.0, 5673.0, 5343.0
3	5260	9	1	333	1	5545.0, 5607.0, 5339.0, 5636.0, 5453.0, 5464.0, 5363.0, 5604.0, 5455.0, 5516.0, 5278.0, 5313.0, 5494.0, 5630.0, 5411.0, 5296.0, 5567.0, 5405.0, 5336.0, 5404.0, 5480.0, 5407.0, 5349.0, 5333.0, 5691.0, 5652.0, 5331.0, 5720.0, 5525.0, 5409.0, 5561.0, 5559.0, 5357.0, 5293.0, 5680.0, 5251.0, 5356.0, 5267.0, 5533.0, 5687.0, 5619.0, 5399.0, 5397.0, 5598.0, 5509.0, 5460.0, 5277.0, 5626.0, 5704.0, 5500.0, 5576.0, 5297.0, 5449.0, 5320.0, 5435.0, 5427.0, 5496.0, 5465.0, 5657.0, 5508.0, 5479.0, 5662.0, 5528.0, 5285.0, 5401.0

						5359.0, 5532.0, 5557.0, 5655.0, 5490.0, 5364.0, 5417.0, 5444.0, 5326.0, 5391.0, 5678.0, 5689.0, 5306.0, 5717.0, 5713.0, 5383.0, 5344.0, 5671.0, 5300.0, 5352.0, 5504.0, 5656.0, 5673.0, 5587.0, 5314.0, 5718.0, 5347.0, 5623.0, 5627.0, 5463.0, 5271.0, 5575.0, 5275.0, 5690.0, 5272.0
4	5260	9	1	333	1	5328.0, 5719.0, 5361.0, 5574.0, 5291.0, 5414.0, 5311.0, 5619.0, 5428.0, 5689.0, 5329.0, 5461.0, 5512.0, 5432.0, 5298.0, 5340.0, 5603.0, 5659.0, 5348.0, 5458.0, 5545.0, 5673.0, 5427.0, 5464.0, 5433.0, 5623.0, 5280.0, 5510.0, 5660.0, 5596.0, 5407.0, 5271.0, 5473.0, 5590.0, 5614.0, 5569.0, 5356.0, 5488.0, 5663.0, 5636.0, 5671.0, 5261.0, 5379.0, 5704.0, 5301.0, 5501.0, 5492.0, 5266.0, 5605.0, 5718.0, 5627.0, 5362.0, 5588.0, 5268.0, 5700.0, 5584.0, 5276.0, 5505.0, 5353.0, 5390.0, 5408.0, 5351.0, 5626.0, 5602.0, 5678.0, 5387.0, 5674.0, 5581.0, 5457.0, 5342.0, 5474.0, 5517.0, 5551.0, 5416.0, 5564.0, 5690.0, 5541.0, 5462.0, 5448.0, 5600.0, 5470.0, 5717.0, 5499.0, 5585.0, 5694.0, 5521.0, 5370.0, 5528.0, 5425.0, 5478.0, 5304.0, 5431.0, 5500.0, 5386.0, 5378.0, 5463.0, 5269.0, 5556.0, 5372.0, 5582.0
5	5260	9	1	333	1	5625.0, 5326.0, 5560.0, 5461.0, 5277.0, 5513.0, 5331.0, 5462.0, 5276.0, 5633.0, 5269.0, 5632.0, 5617.0, 5532.0, 5588.0, 5636.0, 5334.0, 5473.0, 5374.0, 5612.0, 5506.0, 5426.0, 5283.0, 5495.0, 5465.0, 5572.0, 5531.0, 5389.0, 5361.0, 5476.0, 5581.0, 5575.0, 5332.0, 5391.0, 5399.0, 5387.0, 5263.0, 5416.0, 5692.0, 5415.0, 5602.0, 5251.0, 5414.0, 5546.0, 5311.0, 5672.0, 5395.0, 5650.0, 5627.0, 5584.0, 5500.0, 5557.0, 5494.0, 5351.0, 5275.0, 5289.0, 5449.0, 5615.0, 5544.0, 5471.0, 5337.0, 5328.0, 5578.0, 5666.0, 5703.0, 5344.0, 5348.0, 5635.0, 5540.0, 5684.0, 5498.0, 5604.0, 5554.0, 5260.0, 5327.0, 5267.0, 5356.0, 5664.0, 5278.0, 5302.0, 5338.0, 5530.0, 5680.0, 5301.0, 5335.0, 5403.0, 5571.0, 5429.0, 5622.0, 5649.0, 5681.0, 5577.0, 5642.0, 5478.0, 5701.0, 5654.0, 5375.0, 5696.0, 5638.0, 5608.0
6	5260	9	1	333	1	5365.0, 5498.0, 5673.0, 5623.0, 5698.0, 5309.0, 5500.0, 5718.0, 5259.0, 5283.0, 5366.0, 5668.0, 5715.0, 5318.0, 5454.0, 5568.0, 5277.0, 5372.0, 5641.0, 5414.0, 5628.0, 5693.0, 5411.0, 5278.0, 5432.0, 5363.0, 5268.0, 5581.0, 5633.0, 5501.0, 5417.0, 5450.0, 5555.0, 5649.0, 5600.0, 5559.0, 5531.0, 5284.0, 5362.0, 5565.0, 5395.0, 5686.0, 5508.0, 5407.0, 5593.0, 5489.0, 5701.0, 5256.0, 5490.0, 5503.0, 5317.0, 5624.0, 5428.0, 5721.0, 5604.0, 5444.0, 5619.0, 5534.0, 5545.0, 5511.0, 5627.0, 5340.0, 5719.0, 5695.0, 5523.0

						5666.0, 5442.0, 5334.0, 5658.0, 5272.0, 5300.0, 5532.0, 5483.0, 5252.0, 5494.0, 5491.0, 5678.0, 5717.0, 5561.0, 5657.0, 5632.0, 5286.0, 5554.0, 5404.0, 5594.0, 5352.0, 5356.0, 5271.0, 5616.0, 5562.0, 5346.0, 5526.0, 5585.0, 5576.0, 5697.0, 5382.0, 5488.0, 5339.0, 5313.0, 5710.0
7	5260	9	1	333	1	5316.0, 5503.0, 5587.0, 5441.0, 5599.0, 5342.0, 5502.0, 5519.0, 5652.0, 5281.0, 5526.0, 5634.0, 5650.0, 5407.0, 5536.0, 5442.0, 5621.0, 5609.0, 5594.0, 5588.0, 5713.0, 5711.0, 5431.0, 5462.0, 5562.0, 5690.0, 5479.0, 5697.0, 5531.0, 5507.0, 5578.0, 5573.0, 5505.0, 5651.0, 5537.0, 5466.0, 5354.0, 5693.0, 5270.0, 5655.0, 5660.0, 5477.0, 5584.0, 5542.0, 5277.0, 5382.0, 5698.0, 5357.0, 5302.0, 5574.0, 5611.0, 5294.0, 5391.0, 5423.0, 5600.0, 5314.0, 5586.0, 5304.0, 5434.0, 5709.0, 5540.0, 5388.0, 5551.0, 5659.0, 5291.0, 5495.0, 5446.0, 5290.0, 5397.0, 5684.0, 5571.0, 5510.0, 5468.0, 5628.0, 5341.0, 5252.0, 5355.0, 5642.0, 5501.0, 5443.0, 5561.0, 5699.0, 5473.0, 5706.0, 5333.0, 5371.0, 5400.0, 5496.0, 5487.0, 5559.0, 5549.0, 5334.0, 5683.0, 5325.0, 5317.0, 5265.0, 5482.0, 5332.0, 5453.0, 5602.0
8	5260	9	1	333	1	5349.0, 5611.0, 5432.0, 5578.0, 5541.0, 5464.0, 5300.0, 5715.0, 5599.0, 5391.0, 5336.0, 5378.0, 5608.0, 5615.0, 5626.0, 5649.0, 5556.0, 5447.0, 5267.0, 5553.0, 5259.0, 5435.0, 5392.0, 5450.0, 5387.0, 5472.0, 5555.0, 5571.0, 5708.0, 5706.0, 5576.0, 5659.0, 5646.0, 5684.0, 5301.0, 5396.0, 5565.0, 5704.0, 5477.0, 5572.0, 5610.0, 5397.0, 5617.0, 5595.0, 5505.0, 5648.0, 5292.0, 5702.0, 5326.0, 5566.0, 5513.0, 5588.0, 5709.0, 5269.0, 5419.0, 5525.0, 5671.0, 5335.0, 5289.0, 5530.0, 5516.0, 5507.0, 5411.0, 5579.0, 5664.0, 5375.0, 5612.0, 5310.0, 5564.0, 5261.0, 5282.0, 5604.0, 5266.0, 5690.0, 5466.0, 5631.0, 5337.0, 5448.0, 5703.0, 5536.0, 5592.0, 5635.0, 5305.0, 5506.0, 5306.0, 5716.0, 5630.0, 5331.0, 5403.0, 5492.0, 5453.0, 5667.0, 5696.0, 5414.0, 5364.0, 5694.0, 5714.0, 5348.0, 5594.0, 5395.0
9	5260	9	1	333	1	5698.0, 5346.0, 5584.0, 5473.0, 5609.0, 5268.0, 5305.0, 5632.0, 5321.0, 5378.0, 5435.0, 5501.0, 5444.0, 5572.0, 5312.0, 5423.0, 5582.0, 5554.0, 5364.0, 5558.0, 5616.0, 5467.0, 5384.0, 5715.0, 5630.0, 5379.0, 5424.0, 5611.0, 5394.0, 5573.0, 5520.0, 5350.0, 5304.0, 5408.0, 5303.0, 5404.0, 5319.0, 5279.0, 5496.0, 5700.0, 5521.0, 5474.0, 5299.0, 5595.0, 5643.0, 5266.0, 5713.0, 5475.0, 5538.0, 5702.0, 5514.0, 5631.0, 5571.0, 5513.0, 5693.0, 5259.0, 5488.0, 5417.0, 5718.0, 5553.0, 5396.0, 5413.0, 5466.0, 5341.0, 5500.0

						5498.0, 5397.0, 5262.0, 5386.0, 5659.0, 5637.0, 5363.0, 5291.0, 5441.0, 5696.0, 5260.0, 5683.0, 5546.0, 5586.0, 5599.0, 5680.0, 5255.0, 5669.0, 5638.0, 5634.0, 5419.0, 5624.0, 5645.0, 5385.0, 5664.0, 5705.0, 5576.0, 5335.0, 5560.0, 5610.0, 5258.0, 5685.0, 5563.0, 5414.0, 5578.0
10	5260	9	1	333	1	5391.0, 5281.0, 5364.0, 5679.0, 5591.0, 5354.0, 5520.0, 5622.0, 5325.0, 5602.0, 5590.0, 5428.0, 5440.0, 5358.0, 5295.0, 5505.0, 5554.0, 5262.0, 5535.0, 5356.0, 5538.0, 5280.0, 5452.0, 5526.0, 5611.0, 5618.0, 5345.0, 5457.0, 5681.0, 5381.0, 5388.0, 5663.0, 5485.0, 5702.0, 5695.0, 5565.0, 5719.0, 5542.0, 5689.0, 5394.0, 5260.0, 5581.0, 5333.0, 5351.0, 5660.0, 5615.0, 5418.0, 5509.0, 5720.0, 5419.0, 5282.0, 5403.0, 5641.0, 5530.0, 5537.0, 5307.0, 5508.0, 5597.0, 5636.0, 5371.0, 5533.0, 5408.0, 5268.0, 5541.0, 5558.0, 5483.0, 5436.0, 5439.0, 5291.0, 5290.0, 5461.0, 5629.0, 5723.0, 5311.0, 5465.0, 5255.0, 5467.0, 5341.0, 5635.0, 5480.0, 5297.0, 5259.0, 5432.0, 5555.0, 5551.0, 5539.0, 5668.0, 5409.0, 5561.0, 5451.0, 5426.0, 5546.0, 5499.0, 5277.0, 5573.0, 5350.0, 5490.0, 5661.0, 5606.0, 5366.0
11	5260	9	1	333	1	5377.0, 5426.0, 5620.0, 5566.0, 5403.0, 5393.0, 5591.0, 5396.0, 5698.0, 5570.0, 5627.0, 5334.0, 5604.0, 5433.0, 5669.0, 5365.0, 5489.0, 5711.0, 5589.0, 5443.0, 5539.0, 5323.0, 5673.0, 5448.0, 5477.0, 5677.0, 5637.0, 5526.0, 5405.0, 5558.0, 5607.0, 5320.0, 5724.0, 5682.0, 5485.0, 5469.0, 5504.0, 5263.0, 5690.0, 5317.0, 5681.0, 5402.0, 5583.0, 5588.0, 5680.0, 5384.0, 5362.0, 5251.0, 5297.0, 5694.0, 5631.0, 5428.0, 5274.0, 5537.0, 5717.0, 5528.0, 5520.0, 5290.0, 5576.0, 5458.0, 5463.0, 5407.0, 5253.0, 5332.0, 5524.0, 5645.0, 5707.0, 5325.0, 5639.0, 5444.0, 5465.0, 5313.0, 5322.0, 5640.0, 5372.0, 5678.0, 5392.0, 5459.0, 5706.0, 5420.0, 5349.0, 5650.0, 5540.0, 5644.0, 5335.0, 5344.0, 5411.0, 5721.0, 5658.0, 5517.0, 5294.0, 5676.0, 5695.0, 5568.0, 5672.0, 5713.0, 5352.0, 5582.0, 5497.0, 5599.0
12	5260	9	1	333	1	5706.0, 5583.0, 5473.0, 5384.0, 5642.0, 5664.0, 5465.0, 5555.0, 5659.0, 5323.0, 5478.0, 5278.0, 5378.0, 5714.0, 5415.0, 5295.0, 5586.0, 5418.0, 5386.0, 5681.0, 5589.0, 5533.0, 5666.0, 5567.0, 5649.0, 5502.0, 5485.0, 5576.0, 5511.0, 5717.0, 5675.0, 5722.0, 5506.0, 5491.0, 5438.0, 5441.0, 5702.0, 5414.0, 5694.0, 5428.0, 5691.0, 5466.0, 5629.0, 5561.0, 5579.0, 5369.0, 5508.0, 5299.0, 5671.0, 5300.0, 5509.0, 5531.0, 5640.0, 5291.0, 5322.0, 5366.0, 5493.0, 5431.0, 5683.0, 5668.0, 5413.0, 5550.0, 5621.0, 5562.0, 5499.0,

						5283.0, 5312.0, 5460.0, 5693.0, 5346.0, 5648.0, 5661.0, 5412.0, 5437.0, 5553.0, 5315.0, 5377.0, 5345.0, 5305.0, 5269.0, 5521.0, 5515.0, 5467.0, 5364.0, 5449.0, 5617.0, 5476.0, 5622.0, 5716.0, 5656.0, 5641.0, 5628.0, 5350.0, 5601.0, 5400.0, 5523.0, 5435.0, 5566.0, 5635.0, 5307.0
13	5260	9	1	333	1	5606.0, 5380.0, 5423.0, 5428.0, 5348.0, 5531.0, 5610.0, 5292.0, 5381.0, 5440.0, 5365.0, 5317.0, 5421.0, 5575.0, 5305.0, 5353.0, 5414.0, 5285.0, 5389.0, 5565.0, 5400.0, 5484.0, 5377.0, 5671.0, 5661.0, 5450.0, 5532.0, 5701.0, 5539.0, 5253.0, 5461.0, 5665.0, 5479.0, 5336.0, 5614.0, 5433.0, 5265.0, 5404.0, 5654.0, 5448.0, 5541.0, 5399.0, 5550.0, 5718.0, 5678.0, 5545.0, 5650.0, 5514.0, 5693.0, 5406.0, 5504.0, 5566.0, 5538.0, 5699.0, 5385.0, 5715.0, 5560.0, 5508.0, 5513.0, 5629.0, 5500.0, 5589.0, 5431.0, 5689.0, 5344.0, 5710.0, 5473.0, 5296.0, 5471.0, 5583.0, 5582.0, 5342.0, 5311.0, 5646.0, 5652.0, 5314.0, 5366.0, 5388.0, 5596.0, 5561.0, 5313.0, 5466.0, 5267.0, 5515.0, 5672.0, 5683.0, 5723.0, 5472.0, 5464.0, 5379.0, 5262.0, 5368.0, 5603.0, 5690.0, 5345.0, 5343.0, 5529.0, 5570.0, 5611.0, 5384.0
14	5260	9	1	333	1	5609.0, 5671.0, 5527.0, 5473.0, 5332.0, 5387.0, 5301.0, 5305.0, 5489.0, 5690.0, 5324.0, 5341.0, 5632.0, 5611.0, 5459.0, 5346.0, 5260.0, 5716.0, 5394.0, 5715.0, 5279.0, 5479.0, 5347.0, 5540.0, 5390.0, 5418.0, 5663.0, 5537.0, 5597.0, 5720.0, 5445.0, 5283.0, 5257.0, 5604.0, 5651.0, 5707.0, 5370.0, 5286.0, 5292.0, 5409.0, 5287.0, 5552.0, 5560.0, 5326.0, 5601.0, 5688.0, 5660.0, 5493.0, 5309.0, 5339.0, 5351.0, 5497.0, 5253.0, 5317.0, 5458.0, 5373.0, 5431.0, 5360.0, 5624.0, 5681.0, 5638.0, 5667.0, 5443.0, 5662.0, 5423.0, 5579.0, 5275.0, 5269.0, 5296.0, 5649.0, 5603.0, 5634.0, 5555.0, 5724.0, 5444.0, 5325.0, 5406.0, 5381.0, 5558.0, 5644.0, 5343.0, 5264.0, 5521.0, 5642.0, 5583.0, 5338.0, 5265.0, 5572.0, 5399.0, 5285.0, 5606.0, 5261.0, 5629.0, 5678.0, 5616.0, 5398.0, 5708.0, 5595.0, 5259.0, 5421.0
15	5260	9	1	333	1	5319.0, 5476.0, 5379.0, 5337.0, 5436.0, 5305.0, 5621.0, 5266.0, 5309.0, 5278.0, 5421.0, 5516.0, 5645.0, 5699.0, 5389.0, 5406.0, 5435.0, 5702.0, 5686.0, 5376.0, 5296.0, 5281.0, 5362.0, 5600.0, 5336.0, 5617.0, 5558.0, 5328.0, 5602.0, 5410.0, 5448.0, 5684.0, 5484.0, 5588.0, 5382.0, 5675.0, 5635.0, 5695.0, 5322.0, 5289.0, 5612.0, 5605.0, 5397.0, 5493.0, 5311.0, 5467.0, 5608.0, 5456.0, 5259.0, 5522.0, 5475.0, 5422.0, 5251.0, 5361.0, 5711.0, 5634.0, 5577.0, 5388.0, 5565.0, 5428.0, 5676.0, 5370.0, 5299.0, 5499.0, 5491.0

						5318.0, 5286.0, 5669.0, 5351.0, 5442.0, 5288.0, 5648.0, 5685.0, 5414.0, 5510.0, 5375.0, 5500.0, 5300.0, 5329.0, 5273.0, 5655.0, 5320.0, 5285.0, 5326.0, 5261.0, 5626.0, 5615.0, 5501.0, 5658.0, 5330.0, 5538.0, 5327.0, 5606.0, 5554.0, 5561.0, 5459.0, 5586.0, 5536.0, 5347.0, 5595.0
16	5260	9	1	333	1	5489.0, 5330.0, 5430.0, 5695.0, 5578.0, 5272.0, 5521.0, 5386.0, 5568.0, 5581.0, 5642.0, 5384.0, 5564.0, 5490.0, 5414.0, 5481.0, 5681.0, 5560.0, 5606.0, 5346.0, 5710.0, 5285.0, 5419.0, 5567.0, 5584.0, 5310.0, 5416.0, 5665.0, 5271.0, 5286.0, 5654.0, 5494.0, 5707.0, 5709.0, 5281.0, 5653.0, 5476.0, 5648.0, 5697.0, 5342.0, 5486.0, 5548.0, 5408.0, 5297.0, 5364.0, 5340.0, 5680.0, 5622.0, 5600.0, 5621.0, 5591.0, 5538.0, 5616.0, 5573.0, 5655.0, 5305.0, 5634.0, 5515.0, 5459.0, 5670.0, 5531.0, 5512.0, 5474.0, 5295.0, 5423.0, 5428.0, 5643.0, 5442.0, 5411.0, 5429.0, 5360.0, 5596.0, 5421.0, 5499.0, 5426.0, 5553.0, 5356.0, 5677.0, 5519.0, 5617.0, 5580.0, 5536.0, 5488.0, 5604.0, 5562.0, 5465.0, 5254.0, 5471.0, 5395.0, 5607.0, 5638.0, 5472.0, 5312.0, 5586.0, 5712.0, 5690.0, 5565.0, 5514.0, 5441.0, 5597.0
17	5260	9	1	333	1	5568.0, 5716.0, 5678.0, 5719.0, 5665.0, 5339.0, 5283.0, 5706.0, 5510.0, 5545.0, 5521.0, 5603.0, 5569.0, 5407.0, 5487.0, 5298.0, 5627.0, 5509.0, 5494.0, 5464.0, 5370.0, 5604.0, 5306.0, 5373.0, 5390.0, 5364.0, 5548.0, 5356.0, 5500.0, 5479.0, 5592.0, 5564.0, 5344.0, 5560.0, 5513.0, 5478.0, 5291.0, 5323.0, 5458.0, 5256.0, 5301.0, 5641.0, 5457.0, 5330.0, 5286.0, 5375.0, 5632.0, 5421.0, 5542.0, 5550.0, 5579.0, 5324.0, 5512.0, 5337.0, 5578.0, 5652.0, 5677.0, 5721.0, 5295.0, 5547.0, 5584.0, 5684.0, 5355.0, 5317.0, 5468.0, 5278.0, 5280.0, 5656.0, 5443.0, 5403.0, 5422.0, 5524.0, 5709.0, 5312.0, 5290.0, 5358.0, 5252.0, 5526.0, 5587.0, 5307.0, 5639.0, 5508.0, 5598.0, 5680.0, 5488.0, 5293.0, 5543.0, 5663.0, 5483.0, 5668.0, 5722.0, 5424.0, 5620.0, 5593.0, 5688.0, 5591.0, 5274.0, 5491.0, 5703.0, 5412.0
18	5260	9	1	333	1	5363.0, 5667.0, 5280.0, 5706.0, 5302.0, 5609.0, 5660.0, 5688.0, 5383.0, 5429.0, 5477.0, 5634.0, 5327.0, 5273.0, 5301.0, 5695.0, 5649.0, 5452.0, 5537.0, 5476.0, 5643.0, 5610.0, 5568.0, 5282.0, 5446.0, 5335.0, 5505.0, 5340.0, 5678.0, 5314.0, 5441.0, 5591.0, 5657.0, 5368.0, 5413.0, 5442.0, 5412.0, 5311.0, 5670.0, 5597.0, 5466.0, 5328.0, 5601.0, 5425.0, 5534.0, 5639.0, 5611.0, 5549.0, 5596.0, 5710.0, 5319.0, 5680.0, 5584.0, 5267.0, 5274.0, 5588.0, 5448.0, 5351.0, 5313.0, 5603.0, 5461.0, 5384.0, 5420.0, 5488.0, 5641.0,

						5300.0, 5499.0, 5410.0, 5458.0, 5682.0, 5276.0, 5585.0, 5581.0, 5475.0, 5367.0, 5703.0, 5428.0, 5512.0, 5307.0, 5570.0, 5411.0, 5621.0, 5538.0, 5326.0, 5348.0, 5444.0, 5523.0, 5436.0, 5715.0, 5513.0, 5478.0, 5697.0, 5702.0, 5498.0, 5398.0, 5567.0, 5389.0, 5264.0, 5268.0, 5285.0
19	5260	9	1	333	1	5426.0, 5594.0, 5366.0, 5600.0, 5557.0, 5385.0, 5315.0, 5454.0, 5311.0, 5284.0, 5533.0, 5394.0, 5474.0, 5478.0, 5289.0, 5350.0, 5487.0, 5512.0, 5529.0, 5551.0, 5613.0, 5383.0, 5667.0, 5502.0, 5428.0, 5580.0, 5362.0, 5683.0, 5586.0, 5258.0, 5654.0, 5709.0, 5360.0, 5256.0, 5266.0, 5518.0, 5381.0, 5267.0, 5480.0, 5672.0, 5460.0, 5539.0, 5276.0, 5430.0, 5442.0, 5377.0, 5299.0, 5371.0, 5710.0, 5597.0, 5591.0, 5633.0, 5439.0, 5552.0, 5724.0, 5250.0, 5716.0, 5453.0, 5490.0, 5441.0, 5443.0, 5465.0, 5300.0, 5625.0, 5393.0, 5674.0, 5380.0, 5713.0, 5488.0, 5562.0, 5303.0, 5576.0, 5655.0, 5312.0, 5319.0, 5519.0, 5496.0, 5470.0, 5345.0, 5309.0, 5543.0, 5589.0, 5369.0, 5386.0, 5588.0, 5257.0, 5328.0, 5563.0, 5435.0, 5507.0, 5657.0, 5616.0, 5599.0, 5395.0, 5342.0, 5357.0, 5384.0, 5295.0, 5479.0, 5402.0
20	5260	9	1	333	1	5626.0, 5578.0, 5271.0, 5546.0, 5628.0, 5506.0, 5606.0, 5276.0, 5293.0, 5639.0, 5410.0, 5412.0, 5273.0, 5415.0, 5554.0, 5690.0, 5489.0, 5495.0, 5303.0, 5663.0, 5706.0, 5569.0, 5507.0, 5355.0, 5371.0, 5343.0, 5695.0, 5635.0, 5301.0, 5674.0, 5426.0, 5254.0, 5420.0, 5461.0, 5517.0, 5685.0, 5344.0, 5302.0, 5672.0, 5662.0, 5509.0, 5535.0, 5459.0, 5638.0, 5667.0, 5413.0, 5561.0, 5311.0, 5263.0, 5572.0, 5523.0, 5532.0, 5258.0, 5262.0, 5713.0, 5340.0, 5541.0, 5565.0, 5290.0, 5556.0, 5601.0, 5564.0, 5585.0, 5567.0, 5313.0, 5296.0, 5579.0, 5275.0, 5487.0, 5691.0, 5265.0, 5536.0, 5522.0, 5334.0, 5307.0, 5462.0, 5389.0, 5544.0, 5686.0, 5698.0, 5610.0, 5531.0, 5669.0, 5425.0, 5382.0, 5434.0, 5298.0, 5325.0, 5649.0, 5496.0, 5710.0, 5324.0, 5387.0, 5608.0, 5680.0, 5627.0, 5528.0, 5393.0, 5654.0, 5490.0
21	5260	9	1	333	1	5585.0, 5439.0, 5650.0, 5700.0, 5332.0, 5562.0, 5563.0, 5489.0, 5511.0, 5518.0, 5424.0, 5542.0, 5641.0, 5688.0, 5334.0, 5308.0, 5472.0, 5488.0, 5654.0, 5600.0, 5345.0, 5644.0, 5347.0, 5603.0, 5416.0, 5565.0, 5602.0, 5421.0, 5705.0, 5724.0, 5295.0, 5503.0, 5586.0, 5589.0, 5560.0, 5669.0, 5287.0, 5576.0, 5413.0, 5579.0, 5435.0, 5543.0, 5615.0, 5628.0, 5666.0, 5663.0, 5507.0, 5561.0, 5426.0, 5716.0, 5387.0, 5423.0, 5468.0, 5575.0, 5702.0, 5454.0, 5715.0, 5558.0, 5459.0, 5315.0, 5377.0, 5277.0, 5516.0, 5521.0, 5682.0

						5636.0, 5583.0, 5438.0, 5272.0, 5327.0, 5276.0, 5311.0, 5428.0, 5672.0, 5627.0, 5309.0, 5452.0, 5395.0, 5717.0, 5533.0, 5651.0, 5418.0, 5300.0, 5642.0, 5263.0, 5584.0, 5465.0, 5357.0, 5621.0, 5581.0, 5548.0, 5446.0, 5460.0, 5363.0, 5325.0, 5605.0, 5721.0, 5506.0, 5587.0, 5547.0
22	5260	9	1	333	1	5718.0, 5674.0, 5709.0, 5273.0, 5411.0, 5297.0, 5620.0, 5435.0, 5340.0, 5704.0, 5501.0, 5712.0, 5650.0, 5476.0, 5511.0, 5336.0, 5255.0, 5454.0, 5264.0, 5444.0, 5378.0, 5631.0, 5669.0, 5489.0, 5344.0, 5626.0, 5252.0, 5558.0, 5471.0, 5628.0, 5701.0, 5523.0, 5365.0, 5368.0, 5642.0, 5482.0, 5561.0, 5288.0, 5341.0, 5385.0, 5514.0, 5443.0, 5366.0, 5395.0, 5588.0, 5502.0, 5720.0, 5417.0, 5647.0, 5301.0, 5711.0, 5632.0, 5636.0, 5686.0, 5381.0, 5706.0, 5658.0, 5283.0, 5351.0, 5625.0, 5560.0, 5703.0, 5250.0, 5328.0, 5614.0, 5327.0, 5339.0, 5538.0, 5663.0, 5401.0, 5425.0, 5542.0, 5335.0, 5641.0, 5612.0, 5692.0, 5458.0, 5579.0, 5695.0, 5583.0, 5286.0, 5708.0, 5321.0, 5541.0, 5557.0, 5529.0, 5300.0, 5551.0, 5261.0, 5548.0, 5705.0, 5688.0, 5256.0, 5465.0, 5660.0, 5433.0, 5691.0, 5452.0, 5637.0, 5323.0
23	5260	9	1	333	1	5440.0, 5664.0, 5516.0, 5676.0, 5422.0, 5638.0, 5649.0, 5252.0, 5397.0, 5633.0, 5687.0, 5323.0, 5554.0, 5324.0, 5296.0, 5663.0, 5535.0, 5550.0, 5490.0, 5279.0, 5445.0, 5428.0, 5701.0, 5506.0, 5624.0, 5479.0, 5546.0, 5416.0, 5341.0, 5335.0, 5688.0, 5401.0, 5619.0, 5433.0, 5378.0, 5705.0, 5281.0, 5406.0, 5407.0, 5573.0, 5595.0, 5276.0, 5719.0, 5263.0, 5679.0, 5486.0, 5670.0, 5536.0, 5582.0, 5456.0, 5329.0, 5614.0, 5389.0, 5390.0, 5634.0, 5350.0, 5578.0, 5393.0, 5419.0, 5722.0, 5712.0, 5560.0, 5365.0, 5355.0, 5618.0, 5453.0, 5475.0, 5680.0, 5699.0, 5558.0, 5258.0, 5285.0, 5286.0, 5402.0, 5360.0, 5667.0, 5655.0, 5459.0, 5561.0, 5723.0, 5477.0, 5483.0, 5313.0, 5591.0, 5415.0, 5605.0, 5556.0, 5310.0, 5606.0, 5488.0, 5544.0, 5446.0, 5338.0, 5639.0, 5579.0, 5448.0, 5654.0, 5317.0, 5630.0, 5531.0
24	5260	9	1	333	1	5645.0, 5335.0, 5342.0, 5367.0, 5697.0, 5330.0, 5711.0, 5628.0, 5277.0, 5280.0, 5533.0, 5520.0, 5372.0, 5413.0, 5459.0, 5676.0, 5687.0, 5350.0, 5285.0, 5622.0, 5615.0, 5253.0, 5318.0, 5423.0, 5660.0, 5260.0, 5319.0, 5255.0, 5301.0, 5491.0, 5256.0, 5665.0, 5651.0, 5539.0, 5699.0, 5607.0, 5418.0, 5698.0, 5620.0, 5331.0, 5653.0, 5671.0, 5311.0, 5573.0, 5254.0, 5558.0, 5548.0, 5426.0, 5535.0, 5461.0, 5594.0, 5557.0, 5618.0, 5258.0, 5674.0, 5386.0, 5701.0, 5570.0, 5341.0, 5488.0, 5715.0, 5333.0, 5718.0, 5287.0, 5403.0

						5658.0, 5600.0, 5394.0, 5497.0, 5526.0, 5334.0, 5458.0, 5392.0, 5381.0, 5357.0, 5373.0, 5585.0, 5404.0, 5262.0, 5252.0, 5545.0, 5444.0, 5546.0, 5509.0, 5489.0, 5700.0, 5321.0, 5661.0, 5427.0, 5528.0, 5352.0, 5595.0, 5527.0, 5502.0, 5460.0, 5685.0, 5642.0, 5672.0, 5693.0, 5537.0
25	5260	9	1	333	1	5714.0, 5559.0, 5287.0, 5603.0, 5697.0, 5331.0, 5378.0, 5407.0, 5508.0, 5512.0, 5347.0, 5545.0, 5672.0, 5465.0, 5685.0, 5362.0, 5720.0, 5411.0, 5494.0, 5383.0, 5284.0, 5534.0, 5425.0, 5471.0, 5398.0, 5723.0, 5412.0, 5300.0, 5656.0, 5397.0, 5631.0, 5570.0, 5406.0, 5456.0, 5417.0, 5293.0, 5441.0, 5687.0, 5517.0, 5483.0, 5520.0, 5390.0, 5543.0, 5661.0, 5264.0, 5606.0, 5315.0, 5696.0, 5705.0, 5388.0, 5396.0, 5670.0, 5592.0, 5546.0, 5527.0, 5460.0, 5540.0, 5333.0, 5325.0, 5536.0, 5608.0, 5311.0, 5644.0, 5594.0, 5382.0, 5636.0, 5268.0, 5335.0, 5261.0, 5706.0, 5386.0, 5510.0, 5489.0, 5681.0, 5712.0, 5699.0, 5587.0, 5695.0, 5305.0, 5721.0, 5690.0, 5574.0, 5416.0, 5558.0, 5660.0, 5591.0, 5552.0, 5260.0, 5633.0, 5358.0, 5462.0, 5275.0, 5621.0, 5675.0, 5426.0, 5650.0, 5267.0, 5452.0, 5671.0, 5669.0
26	5260	9	1	333	1	5719.0, 5513.0, 5457.0, 5490.0, 5511.0, 5632.0, 5346.0, 5411.0, 5455.0, 5310.0, 5329.0, 5501.0, 5499.0, 5462.0, 5311.0, 5618.0, 5594.0, 5453.0, 5711.0, 5689.0, 5581.0, 5582.0, 5361.0, 5514.0, 5585.0, 5480.0, 5596.0, 5409.0, 5444.0, 5679.0, 5404.0, 5252.0, 5271.0, 5686.0, 5267.0, 5482.0, 5545.0, 5586.0, 5380.0, 5583.0, 5279.0, 5390.0, 5413.0, 5614.0, 5481.0, 5344.0, 5423.0, 5557.0, 5571.0, 5559.0, 5616.0, 5384.0, 5722.0, 5607.0, 5573.0, 5517.0, 5542.0, 5316.0, 5276.0, 5375.0, 5537.0, 5572.0, 5656.0, 5574.0, 5484.0, 5405.0, 5498.0, 5636.0, 5621.0, 5325.0, 5684.0, 5628.0, 5507.0, 5400.0, 5273.0, 5458.0, 5579.0, 5600.0, 5646.0, 5448.0, 5538.0, 5487.0, 5612.0, 5615.0, 5641.0, 5678.0, 5349.0, 5396.0, 5622.0, 5372.0, 5536.0, 5568.0, 5561.0, 5674.0, 5328.0, 5288.0, 5544.0, 5300.0, 5562.0, 5682.0
27	5260	9	1	333	1	5502.0, 5575.0, 5696.0, 5457.0, 5656.0, 5506.0, 5300.0, 5680.0, 5619.0, 5624.0, 5358.0, 5549.0, 5250.0, 5285.0, 5535.0, 5581.0, 5711.0, 5449.0, 5509.0, 5716.0, 5491.0, 5364.0, 5578.0, 5379.0, 5417.0, 5720.0, 5340.0, 5328.0, 5542.0, 5611.0, 5350.0, 5572.0, 5541.0, 5437.0, 5665.0, 5307.0, 5453.0, 5698.0, 5648.0, 5553.0, 5668.0, 5671.0, 5291.0, 5645.0, 5321.0, 5325.0, 5448.0, 5704.0, 5400.0, 5341.0, 5391.0, 5296.0, 5643.0, 5610.0, 5539.0, 5434.0, 5344.0, 5547.0, 5347.0, 5305.0, 5455.0, 5311.0, 5490.0, 5280.0, 5625.0

						5435.0, 5602.0, 5313.0, 5630.0, 5462.0, 5377.0, 5309.0, 5528.0, 5670.0, 5497.0, 5583.0, 5495.0, 5567.0, 5306.0, 5635.0, 5603.0, 5538.0, 5302.0, 5343.0, 5415.0, 5499.0, 5537.0, 5718.0, 5609.0, 5406.0, 5523.0, 5627.0, 5685.0, 5429.0, 5679.0, 5338.0, 5531.0, 5256.0, 5695.0, 5402.0
28	5260	9	1	333	1	5654.0, 5337.0, 5457.0, 5539.0, 5673.0, 5386.0, 5527.0, 5632.0, 5250.0, 5267.0, 5533.0, 5466.0, 5397.0, 5326.0, 5495.0, 5415.0, 5714.0, 5569.0, 5420.0, 5366.0, 5721.0, 5307.0, 5720.0, 5647.0, 5596.0, 5264.0, 5641.0, 5388.0, 5266.0, 5482.0, 5434.0, 5567.0, 5601.0, 5318.0, 5723.0, 5277.0, 5418.0, 5622.0, 5409.0, 5297.0, 5484.0, 5259.0, 5365.0, 5428.0, 5261.0, 5512.0, 5303.0, 5381.0, 5262.0, 5683.0, 5573.0, 5639.0, 5526.0, 5631.0, 5521.0, 5396.0, 5312.0, 5648.0, 5314.0, 5490.0, 5697.0, 5414.0, 5352.0, 5579.0, 5286.0, 5547.0, 5669.0, 5542.0, 5561.0, 5349.0, 5488.0, 5562.0, 5603.0, 5308.0, 5665.0, 5432.0, 5375.0, 5322.0, 5600.0, 5666.0, 5520.0, 5429.0, 5672.0, 5462.0, 5258.0, 5447.0, 5493.0, 5651.0, 5536.0, 5469.0, 5301.0, 5363.0, 5350.0, 5559.0, 5637.0, 5681.0, 5541.0, 5685.0, 5343.0, 5374.0
29	5260	9	1	333	1	5675.0, 5440.0, 5597.0, 5621.0, 5449.0, 5676.0, 5632.0, 5517.0, 5670.0, 5481.0, 5383.0, 5320.0, 5708.0, 5331.0, 5665.0, 5464.0, 5555.0, 5538.0, 5643.0, 5435.0, 5653.0, 5671.0, 5631.0, 5562.0, 5701.0, 5370.0, 5443.0, 5682.0, 5377.0, 5398.0, 5476.0, 5584.0, 5404.0, 5515.0, 5495.0, 5646.0, 5461.0, 5395.0, 5423.0, 5433.0, 5666.0, 5527.0, 5455.0, 5312.0, 5286.0, 5287.0, 5393.0, 5687.0, 5705.0, 5341.0, 5622.0, 5578.0, 5594.0, 5710.0, 5293.0, 5384.0, 5557.0, 5432.0, 5662.0, 5359.0, 5658.0, 5722.0, 5397.0, 5363.0, 5608.0, 5425.0, 5618.0, 5342.0, 5306.0, 5386.0, 5280.0, 5485.0, 5291.0, 5463.0, 5349.0, 5467.0, 5553.0, 5717.0, 5614.0, 5523.0, 5612.0, 5282.0, 5656.0, 5700.0, 5336.0, 5285.0, 5475.0, 5652.0, 5502.0, 5356.0, 5252.0, 5698.0, 5471.0, 5689.0, 5628.0, 5718.0, 5428.0, 5326.0, 5418.0, 5295.0
30	5260	9	1	333	1	5525.0, 5535.0, 5659.0, 5627.0, 5363.0, 5640.0, 5521.0, 5468.0, 5422.0, 5527.0, 5708.0, 5324.0, 5483.0, 5432.0, 5696.0, 5720.0, 5291.0, 5456.0, 5540.0, 5707.0, 5577.0, 5345.0, 5499.0, 5564.0, 5354.0, 5383.0, 5300.0, 5679.0, 5268.0, 5538.0, 5543.0, 5252.0, 5542.0, 5272.0, 5593.0, 5358.0, 5680.0, 5373.0, 5491.0, 5600.0, 5301.0, 5688.0, 5579.0, 5666.0, 5412.0, 5395.0, 5408.0, 5393.0, 5665.0, 5348.0, 5379.0, 5695.0, 5309.0, 5614.0, 5339.0, 5683.0, 5596.0, 5316.0, 5469.0, 5594.0, 5457.0, 5476.0, 5490.0, 5702.0, 5446.0

						5554.0, 5281.0, 5711.0, 5633.0, 5515.0, 5628.0, 5264.0, 5637.0, 5385.0, 5655.0, 5437.0, 5399.0, 5353.0, 5303.0, 5599.0, 5424.0, 5340.0, 5325.0, 5612.0, 5649.0, 5433.0, 5336.0, 5265.0, 5449.0, 5357.0, 5356.0, 5623.0, 5536.0, 5360.0, 5384.0, 5256.0, 5648.0, 5415.0, 5425.0, 5578.0
--	--	--	--	--	--	--

40MHz

Radar SignalType	Waveform/Trial Number	Detection (%)	Limit (%)	Pass/Fail
Type 1A	15	100%	60%	pass
Type 1B	15	100%	60%	pass
Type 2	30	100 %	60%	Pass
Type 3	30	90 %	60%	Pass
Type 4	30	93.33 %	60%	Pass
Aggregate(Type1 to 4)	120	95.83%	80%	Pass
Type 5	30	100 %	80%	Pass
Type 6	30	100 %	70%	Pass

Please refer to the following statistical tables:

5270MHz**Radar Type 1A Statistical Performance**

Trial #	Fc (MHz)	Pulse/Burst	Pulse Width (μS)	PRI (μs)	Detection (1:yes; 0:no)
1	5270	102	1	518	1
2	5270	63	1	838	1
3	5270	65	1	818	1
4	5270	70	1	758	1
5	5270	67	1	798	1
6	5270	76	1	698	1
7	5270	58	1	918	1
8	5270	83	1	638	1
9	5270	72	1	738	1
10	5270	59	1	898	1
11	5270	57	1	938	1
12	5270	95	1	558	1
13	5270	92	1	578	1
14	5270	68	1	778	1
15	5270	61	1	878	1
Detection Percentage: 100 % (>60%)					

Radar Type 1B Statistical Performance

Trial #	Fc (MHz)	Pulse/Burst	Pulse Width (μS)	PRI (μs)	Detection (1:yes; 0:no)
1	5270	19	1	2829	1
2	5270	52	1	1015	1
3	5270	18	1	2937	1
4	5270	19	1	2824	1
5	5270	24	1	2267	1
6	5270	32	1	1658	1
7	5270	35	1	1509	1
8	5270	55	1	975	1
9	5270	71	1	752	1
10	5270	18	1	3005	1
11	5270	30	1	1768	1
12	5270	31	1	1758	1
13	5270	66	1	811	1
14	5270	24	1	2260	1
15	5270	33	1	1636	1
Detection Percentage: 100 % (>60%)					

Radar Type 2 Statistical Performance

Trial #	Fc (MHz)	Pulse/Burst	Pulse Width (μS)	PRI (μs)	Detection (1:yes; 0:no)
1	5270	26	1.4	187	1
2	5270	24	2.1	217	1
3	5270	26	3.7	225	1
4	5270	25	4.5	211	1
5	5270	28	3	210	1
6	5270	23	1.5	172	1
7	5270	27	3.7	222	1
8	5270	23	3.4	181	1
9	5270	25	1.4	167	1
10	5270	28	4.8	217	1
11	5270	23	2.1	227	1
12	5270	29	3.1	209	1
13	5270	27	4.9	188	1
14	5270	28	2.4	177	1
15	5270	27	1.4	173	1
16	5270	29	4.3	198	1
17	5270	28	1.4	205	1
18	5270	23	2.9	164	1
19	5270	23	2.7	187	1
20	5270	28	2.8	192	1
21	5270	29	2.5	166	1
22	5270	24	4.2	155	1
23	5270	25	3.2	195	1
24	5270	24	2.2	159	1
25	5270	25	2	187	1
26	5270	25	4.1	220	1
27	5270	25	4.5	190	1
28	5270	25	2.7	220	1
29	5270	26	3.5	220	1
30	5270	23	3.1	226	1
Detection Percentage: 100 % (>60%)					

Radar Type 3 Statistical Performance

Trial #	Fc (MHz)	Pulse/Burst	Pulse Width (μS)	PRI (μs)	Detection (1:yes; 0:no)
1	5270	17	10	426	1
2	5270	16	10	240	1
3	5270	18	6.9	319	1
4	5270	16	7.2	338	1
5	5270	17	8.3	350	1
6	5270	17	6.8	475	1
7	5270	17	9.5	305	1
8	5270	17	7.4	423	0
9	5270	17	8.4	267	1
10	5270	18	6.5	237	0
11	5270	16	7.6	341	1
12	5270	18	6.6	497	1
13	5270	18	9.9	355	1
14	5270	16	6.8	383	1
15	5270	17	7	404	1
16	5270	16	6.2	491	0
17	5270	17	6.9	267	1
18	5270	16	8.8	498	1
19	5270	18	9.4	466	1
20	5270	16	9.6	412	1
21	5270	16	6	233	1
22	5270	16	6.7	303	1
23	5270	16	6.8	249	1
24	5270	18	8.6	232	1
25	5270	16	9.8	487	1
26	5270	16	8.5	350	1
27	5270	17	10	216	1
28	5270	18	6.2	476	1
29	5270	18	9.5	219	1
30	5270	17	6.4	270	1
Detection Percentage: 90 % (>60%)					

Radar Type 4 Statistical Performance

Trial #	Fc (MHz)	Pulse/Burst	Pulse Width (μS)	PRI (μs)	Detection (1:yes; 0:no)
1	5270	15	19.8	379	1
2	5270	12	11.8	261	1
3	5270	16	16.5	360	1
4	5270	13	16.7	345	1
5	5270	14	14.1	267	1
6	5270	13	18.4	377	1
7	5270	16	19.9	223	1
8	5270	12	16.3	380	0
9	5270	14	11.2	257	1
10	5270	14	15	435	1
11	5270	15	11.6	400	0
12	5270	12	11.3	248	1
13	5270	12	13.1	392	1
14	5270	15	18.2	423	1
15	5270	14	11.4	448	1
16	5270	14	13.8	313	1
17	5270	13	15.4	431	1
18	5270	15	18	215	1
19	5270	13	18.8	285	1
20	5270	15	17.4	329	1
21	5270	14	13.4	382	1
22	5270	14	12.4	489	1
23	5270	16	13.6	389	1
24	5270	16	14.2	473	1
25	5270	12	12.9	494	1
26	5270	12	17.8	333	1
27	5270	14	16.7	301	1
28	5270	13	12.5	207	1
29	5270	13	11.9	441	1
30	5270	16	16.8	263	1
Detection Percentage: 93.33 % (>60%)					

Radar Type 5 Case 1 Statistical Performance

Statistics 1 (ChirpCenter Frequency: 5270.0MHz)

Trial #	Pulse	Chirp(MHz)	Pulse Width (µS)	Pulse 1-2 spacing(µS)	Pulse 2-3 spacing(µS)	Pulse Start(S)	Detection (1:yes;0:no)
0	2	13	73.3	1184		0.152041	1
1	2	13	55.2	1329		1.287776	
2	2	13	52.2	1843		1.893283	
3	2	13	55.7	1806		3.167557	
4	1	13	61.5			3.79156	
5	2	13	79.9	1545		4.900694	
6	1	13	59.9			5.980896	
7	3	13	69.4	1608	1835	6.34169	
8	2	13	79	1356		6.949024	
9	3	13	82.4	1795	1297	8.340032	
10	2	13	62	1757		9.356766	
11	2	13	98.3	1671		9.956569	
12	1	13	66.3			10.72735	
13	2	13	96.1	1777		11.35562	

Statistics 2 (ChirpCenter Frequency: 5270.0 MHz)

Trial #	Pulse	Chirp(MHz)	Pulse Width (µS)	Pulse 1-2 spacing(µS)	Pulse 2-3 spacing(µS)	Pulse Start(S)	Detection (1:yes;0:no)
0	1	5	50.1			0.673213	1
1	3	5	59.4	1688	1953	1.266538	
2	2	5	51.3	1628		1.729018	
3	2	5	93.6	1766		2.166647	
4	1	5	57.8			2.899137	
5	2	5	80.7	1186		3.732658	
6	2	5	86.3	1907		4.900034	
7	2	5	70.8	1498		5.484735	
8	1	5	54.2			6.131927	
9	2	5	57.9	1785		7.010205	
10	3	5	90.4	1029	1767	7.348108	
11	2	5	81.8	1227		8.248496	
12	1	5	98.5			8.526627	
13	3	5	50.8	1215	1956	9.682375	
14	1	5	67.9			10.23575	
15	3	5	55.2	1010	1629	10.77686	

Statistics 3 (ChirpCenter Frequency: 5270.0 MHz)

Trial #	Pulse	Chirp(MHz)	Pulse Width (μS)	Pulse 1-2 spacing(μS)	Pulse 2-3 spacing(μS)	Pulse Start(S)	Detection (1:yes;0:no)
0	1	5	50.1			0.673213	1
1	3	5	59.4	1688	1953	1.266538	
2	2	5	51.3	1628		1.729018	
3	2	5	93.6	1766		2.166647	
4	1	5	57.8			2.899137	
5	2	5	80.7	1186		3.732658	
6	2	5	86.3	1907		4.900034	
7	2	5	70.8	1498		5.484735	
8	1	5	54.2			6.131927	
9	2	5	57.9	1785		7.010205	
10	3	5	90.4	1029	1767	7.348108	
11	2	5	81.8	1227		8.248496	
12	1	5	98.5			8.526627	
13	3	5	50.8	1215	1956	9.682375	
14	1	5	67.9			10.23575	
15	3	5	55.2	1010	1629	10.77686	
16	2	5	92.4	1708		11.31506	

Statistics 4 (ChirpCenter Frequency: 5270.0 MHz)

Trial #	Pulse	Chirp(MHz)	Pulse Width (μS)	Pulse 1-2 spacing(μS)	Pulse 2-3 spacing(μS)	Pulse Start(S)	Detection (1:yes;0:no)
0	2	13	65.9	1126		0.342892	1
1	1	13	93.5			2.938362	
2	2	13	61.1	1702		4.098542	
3	1	13	76.2			5.067452	
4	1	13	98.4			6.107511	
5	1	13	98			7.682626	
6	2	13	69.5	1516		10.17758	
7	2	13	56.4	1738		10.56607	

Statistics 5(ChirpCenter Frequency: 5270.0 MHz)

Trial #	Pulse	Chirp(MHz)	Pulse Width (μS)	Pulse 1-2 spacing(μS)	Pulse 2-3 spacing(μS)	Pulse Start(S)	Detection (1:yes;0:no)
0	2	11	97.3	1529		0.861499	1
1	1	11	70.1			1.835162	
2	1	11	99.3			2.725055	
3	2	11	94.1	1842		3.06245	
4	1	11	91.2			4.008156	
5	3	11	52.9	1202	1468	4.650405	
6	1	11	89			6.038086	
7	3	11	79.3	1347	1128	6.712278	
8	2	11	64.1	1083		7.795328	
9	1	11	79.8			8.916016	
10	1	11	58.1			9.996216	
11	3	11	98.7	1597	1688	10.29146	
12	2	11	68.2	1768		11.39109	

Statistics 6 (ChirpCenter Frequency: 5270.0 MHz)

Trial #	Pulse	Chirp(MHz)	Pulse Width (μ S)	Pulse 1-2 spacing(μ S)	Pulse 2-3 spacing(μ S)	Pulse Start(S)	Detection (1:yes;0:no)
0	2	5	95	1571		0.741961	1
1	3	5	78.9	1618	1607	2.360799	
2	2	5	51.6	1584		2.942995	
3	2	5	59	1180		3.735192	
4	1	5	64.4			5.762331	
5	2	5	55	1359		6.40494	
6	3	5	69.3	1164	1396	7.623129	
7	3	5	52.1	1568	1210	9.277139	
8	1	5	80.6			9.908556	
9	1	5	70.7			11.64254	

Statistics 7(ChirpCenter Frequency: 5270.0 MHz)

Trial #	Pulse	Chirp(MHz)	Pulse Width (μ S)	Pulse 1-2 spacing(μ S)	Pulse 2-3 spacing(μ S)	Pulse Start(S)	Detection (1:yes;0:no)
0	3	6	75.3	1420	1486	0.832626	1
1	2	6	71.8	1008		1.183793	
2	3	6	51.1	1887	1758	2.485061	
3	2	6	52.2	1316		3.140527	
4	1	6	95.9			4.978019	
5	2	6	59.2	1434		5.265803	
6	1	6	56.7			6.465487	
7	1	6	98.3			7.077666	
8	3	6	97.3	1135	1577	8.137581	
9	3	6	55.5	1137	1959	9.872309	
10	2	6	81.1	1224		10.6674	
11	1	6	76.4			11.55569	

Statistics 8 (ChirpCenter Frequency: 5270.0 MHz)

Trial #	Pulse	Chirp(MHz)	Pulse Width (μS)	Pulse 1-2 spacing(μS)	Pulse 2-3 spacing(μS)	Pulse Start(S)	Detection (1:yes;0:no)
0	2	7	66.1	1378		0.67636	1
1	1	7	62.9			1.672084	
2	2	7	85.9	1625		2.201102	
3	3	7	81.1	1162	1463	2.940613	
4	2	7	74.5	1094		3.846482	
5	2	7	59.4	1807		4.441114	
6	1	7	85.9			5.248336	
7	2	7	56.2	1767		6.192439	
8	2	7	73.7	1696		7.212624	
9	2	7	95.1	1029		8.553065	
10	3	7	83.7	1325	1155	8.648687	
11	2	7	88.8	1799		9.566288	
12	3	7	56.4	1260	1865	10.87755	
13	2	7	92.2	1553		11.20056	

Statistics 9 (ChirpCenter Frequency: 5270.0 MHz)

Trial #	Pulse	Chirp(MHz)	Pulse Width (μS)	Pulse 1-2 spacing(μS)	Pulse 2-3 spacing(μS)	Pulse Start(S)	Detection (1:yes;0:no)
0	3	14	84.6	1164	1781	1.192844	1
1	2	14	67.8	1507		1.819259	
2	2	14	51.1	1367		3.755463	
3	2	14	68.8	1422		4.265808	
4	3	14	66.3	1348	1764	6.528504	
5	3	14	80.1	1910	1379	7.288205	
6	2	14	80.6	1306		8.569083	
7	1	14	86.1			9.907825	
8	3	14	78.4	1612	1675	11.16892	

Statistics 10 (ChirpCenter Frequency: 5270.0 MHz)

Trial #	Pulse	Chirp(MHz)	Pulse Width (μS)	Pulse 1-2 spacing(μS)	Pulse 2-3 spacing(μS)	Pulse Start(S)	Detection (1:yes;0:no)
0	1	6	52.3			0.136669	1
1	3	6	99.9	1746	1079	1.324675	
2	2	6	64.5	1817		2.645308	
3	2	6	55.1	1290		3.423529	
4	3	6	78.6	1911	1295	4.063908	
5	3	6	54.6	1569	1300	5.492281	
6	2	6	82.5	1269		6.071219	
7	1	6	50			6.524652	
8	2	6	96.5	1004		7.941458	
9	2	6	94.2	1207		8.816052	
10	1	6	82.1			9.317171	
11	2	6	93.1	1509		10.69524	
12	2	6	68.1	1860		11.18556	

Radar Type 5 Case 2 Statistical Performance

Statistics 1 (ChirpCenter Frequency: 5254.0 MHz)

Trial #	Pulse	Chirp(MHz)	Pulse Width (µS)	Pulse 1-2 spacing(µS)	Pulse 2-3 spacing(µS)	Pulse Start(S)	Detection (1:yes;0:no)
0	1	9	53			0.333898	1
1	2	9	70.9	1710		1.264567	
2	3	9	73.7	1591	1741	2.14286	
3	2	9	76.1	1444		3.280873	
4	2	9	90.8	1933		3.927528	
5	1	9	90.1			5.476685	
6	2	9	78.4	1174		6.25946	
7	3	9	52.7	1448	1886	7.248326	
8	1	9	52.9			7.763306	
9	3	9	59.2	1972	1681	8.633992	
10	1	9	64.6			10.12503	
11	2	9	70.8	1795		11.02356	
12	2	9	79.6	1402		11.40583	

Statistics 2 (ChirpCenter Frequency: 5257.0 MHz)

Trial #	Pulse	Chirp(MHz)	Pulse Width (µS)	Pulse 1-2 spacing(µS)	Pulse 2-3 spacing(µS)	Pulse Start(S)	Detection (1:yes;0:no)
0	2	18	87	1091		0.366795	1
1	2	18	63.7	1110		1.490273	
2	2	18	85.2	1614		2.329307	
3	2	18	93.4	1293		3.118338	
4	2	18	63.7	1599		4.260084	
5	2	18	87	1738		4.319998	
6	3	18	99.1	1967	1260	5.9708	
7	2	18	69	1282		6.181931	
8	2	18	93	1296		7.472962	
9	2	18	99.8	1926		8.539973	
10	2	18	67.4	1810		8.89248	
11	2	18	66.8	1968		9.576586	
12	1	18	51.6			11.09866	
13	2	18	71.6	1831		11.96537	

Statistics 3 (ChirpCenter Frequency: 5257.0 MHz)

Trial #	Pulse	Chirp(MHz)	Pulse Width (μS)	Pulse 1-2 spacing(μS)	Pulse 2-3 spacing(μS)	Pulse Start(S)	Detection (1:yes;0:no)
0	3	17	80.2	1186	1042	0.022204	1
1	3	17	52.6	1989	1756	0.963505	
2	3	17	80.7	1114	1791	2.049831	
3	2	17	54.3	1874		2.721845	
4	3	17	66.7	1577	1787	3.969535	
5	2	17	63.3	1705		4.484422	
6	3	17	73.6	1352	1558	5.487761	
7	1	17	89.6			5.894029	
8	2	17	71.4	1266		6.542621	
9	2	17	83.8	1866		7.895186	
10	1	17	92.3			8.30184	
11	3	17	74.2	1075	1287	9.421185	
12	3	17	87.1	1050	1101	9.974593	
13	2	17	77	1275		10.67524	
14	2	17	78.9	1100		11.30152	

Statistics 4 (ChirpCenter Frequency: 5253.0 MHz)

Trial #	Pulse	Chirp(MHz)	Pulse Width (μS)	Pulse 1-2 spacing(μS)	Pulse 2-3 spacing(μS)	Pulse Start(S)	Detection (1:yes;0:no)
0	3	7	62.3	1545	1157	0.276222	1
1	2	7	58.3	1625		1.210686	
2	2	7	66.3	1389		1.606016	
3	2	7	69.1	1919		2.497017	
4	2	7	51.7	1576		3.18522	
5	3	7	64	1721	1068	3.945089	
6	2	7	77.5	1586		4.802026	
7	2	7	73.4	1688		5.670184	
8	3	7	78.2	1698	1553	6.226822	
9	3	7	59.7	1680	1321	6.940841	
10	1	7	51.5			7.731737	
11	2	7	53.4	1037		8.612732	
12	2	7	96.1	1725		9.679648	
13	1	7	73.2			9.781335	
14	3	7	64.9	1040	1778	10.98383	
15	3	7	54.8	1934	1822	11.85596	

Statistics 5 (ChirpCenter Frequency: 5256.0 MHz)

Trial #	Pulse	Chirp(MHz)	Pulse Width (μ S)	Pulse 1-2 spacing(μ S)	Pulse 2-3 spacing(μ S)	Pulse Start(S)	Detection (1:yes;0:no)
0	3	15	83.6	1973	1507	0.442249	1
1	1	15	99.9			1.357636	
2	2	15	88.4	1746		1.599332	
3	2	15	78.1	1742		2.874354	
4	1	15	86.3			3.731745	
5	3	15	88.8	1992	1387	3.907066	
6	3	15	60.1	1196	1280	4.784329	
7	3	15	80.7	1305	1582	5.43727	
8	3	15	85.8	1897	1208	6.278072	
9	1	15	88.1			7.354002	
10	2	15	62	1877		7.577103	
11	3	15	84	1659	1247	8.741966	
12	3	15	76.7	1508	1871	9.101096	
13	2	15	57	1430		10.33576	
14	1	15	74.4			10.76967	
15	3	15	98.9	1977	1582	11.79009	

Statistics 6 (ChirpCenter Frequency: 5252.0 MHz)

Trial #	Pulse	Chirp(MHz)	Pulse Width (μS)	Pulse 1-2 spacing(μS)	Pulse 2-3 spacing(μS)	Pulse Start(S)	Detection (1:yes;0:no)
0	2	6	89.1	1948		0.169707	1
1	2	6	81.6	1785		1.172178	
2	1	6	96.2			2.88498	
3	2	6	91.9	1234		3.315047	
4	1	6	52.1			4.486364	
5	2	6	83.1	1711		5.292262	
6	2	6	52.4	1971		6.286602	
7	3	6	99	1112	1940	7.463751	
8	2	6	92.1	1003		8.942302	
9	2	6	92.8	1451		9.750785	
10	3	6	70.8	1629	1685	10.9455	
11	1	6	90.2			11.63463	

Statistics 7 (ChirpCenter Frequency: 5255.0 MHz)

Trial #	Pulse	Chirp(MHz)	Pulse Width (μS)	Pulse 1-2 spacing(uS)	Pulse 2-3 spacing(uS)	Pulse Start(S)	Detection (1:yes;0:no)
0	3	13	78.8	1390	1613	0.230777	1
1	2	13	89.6	1815		1.221033	
2	3	13	72.3	1479	1625	1.842749	
3	3	13	78.2	1453	1569	3.039425	
4	1	13	82.2			3.314316	
5	1	13	84.5			4.499149	
6	3	13	59.9	1948	1030	4.848	
7	2	13	62.8	1260		5.955926	
8	2	13	89	1121		7.125519	
9	2	13	92.9	1702		7.566825	
10	1	13	52.3			8.346004	
11	3	13	71.4	1009	1582	9.194001	
12	1	13	74.4			9.982629	
13	2	13	64.8	1105		10.88381	
14	2	13	77.6	1018		11.48546	

Statistics 8 (ChirpCenter Frequency: 5254.0 MHz)

Trial #	Pulse	Chirp(MHz)	Pulse Width (μS)	Pulse 1-2 spacing(μS)	Pulse 2-3 spacing(μS)	Pulse Start(S)	Detection (1:yes;0:no)
0	2	9	68.6	1608		0.245811	1
1	2	9	77.9	1605		1.054873	
2	3	9	74.3	1060	1452	1.759107	
3	2	9	97.7	1845		2.503137	
4	2	9	94.1	1366		3.313459	
5	2	9	79.4	1311		3.704361	
6	2	9	91.5	1902		4.851873	
7	1	9	79.2			5.637997	
8	2	9	85.2	1316		5.861048	
9	2	9	65	1513		6.356284	
10	1	9	69.2			7.415904	
11	3	9	64.6	1865	1573	8.445198	
12	2	9	82.8	1825		8.514148	
13	3	9	68.5	1720	1870	9.475593	
14	1	9	65.3			10.2526	
15	2	9	87.5	1426		11.19899	
16	2	9	50.8	1196		11.74842	

Statistics 9 (ChirpCenter Frequency: 5258.0 MHz)

Trial #	Pulse	Chirp(MHz)	Pulse Width (μS)	Pulse 1-2 spacing(μS)	Pulse 2-3 spacing(μS)	Pulse Start(S)	Detection (1:yes;0:no)
0	1	19	68.7			1.031541	1
1	2	19	56.2	1372		1.599612	
2	3	19	86.8	1929	1993	3.240555	
3	2	19	77	1723		3.950142	
4	2	19	91.8	1055		4.940142	
5	2	19	72.1	1630		5.890918	
6	3	19	73.2	1708	1013	6.875992	
7	1	19	70.9			8.454508	
8	1	19	96			9.579859	
9	1	19	71.6			10.57241	
10	2	19	81.3	1935		11.78784	

Statistics 10 (ChirpCenter Frequency: 5252.0 MHz)

Trial #	Pulse	Chirp(MHz)	Pulse Width (μS)	Pulse 1-2 spacing(μS)	Pulse 2-3 spacing(μS)	Pulse Start(S)	Detection (1:yes;0:no)
0	2	10	79	1634		0.112007	1
1	2	10	69.3	1296		0.885955	
2	2	10	59.5	1059		1.641339	
3	1	10	66.8			2.075667	
4	1	10	91.9			2.992002	
5	3	10	86.7	1300	1378	3.984561	
6	3	10	65.9	1436	1106	4.013332	
7	2	10	58.7	1547		4.691034	
8	2	10	54.3	1905		5.467208	
9	2	10	89.3	1408		6.23207	
10	3	10	69.6	1127	1360	6.782726	
11	2	10	60.5	1906		7.551793	
12	2	10	96.3	1499		8.194055	
13	2	10	87.7	1864		9.319057	
14	2	10	89.7	1969		9.597716	
15	2	10	75.1	1658		10.25915	
16	2	10	67	1666		11.1388	
17	1	10	51.6			11.59146	

Radar Type 5 Case 3 Statistical Performance

Statistics 1 (ChirpCenter Frequency: 5282.0 MHz)

Trial #	Pulse	Chirp(MHz)	Pulse Width (µS)	Pulse 1-2 spacing(µS)	Pulse 2-3 spacing(µS)	Pulse Start(S)	Detection (1:yes;0:no)
0	2	19	69	1151		0.097666	1
1	1	19	65.7			1.470169	
2	1	19	96.8			2.140993	
3	3	19	57.8	1662	1526	2.741023	
4	3	19	57.2	1911	1183	3.739995	
5	1	19	79			4.429961	
6	1	19	97.9			5.1697	
7	2	19	64.4	1092		6.214477	
8	3	19	86	1999	1657	7.016281	
9	3	19	57.6	1643	1052	7.340412	
10	1	19	76.9			8.506003	
11	1	19	81.7			8.823349	
12	2	19	65.3	1840		10.06286	
13	3	19	53.4	1638	1179	10.97139	
14	3	19	99.6	1113	1182	11.88703	

Statistics 2 (ChirpCenter Frequency: 5288.0 MHz)

Trial #	Pulse	Chirp(MHz)	Pulse Width (µS)	Pulse 1-2 spacing(µS)	Pulse 2-3 spacing(µS)	Pulse Start(S)	Detection (1:yes;0:no)
0	3	6	64.8	1085	1275	0.779922	1
1	1	6	78.1			2.379436	
2	2	6	96.4	1188		3.477072	
3	1	6	83.7			4.00363	
4	1	6	61.1			5.992578	
5	2	6	77.8	1159		7.008786	
6	2	6	69.5	1582		7.36971	
7	2	6	69.6	1036		8.448759	
8	3	6	67.2	1482	1740	10.76895	
9	2	6	92	1717		11.12407	

Statistics 3 (ChirpCenter Frequency: 5286.0 MHz)

Trial #	Pulse	Chirp(MHz)	Pulse Width (µS)	Pulse 1-2 spacing(µS)	Pulse 2-3 spacing(µS)	Pulse Start(S)	Detection (1:yes;0:no)
0	2	11	94.1	1397		0.737915	1
1	2	11	81.8	1411		1.720399	
2	2	11	99.8	1791		2.670407	
3	2	11	73.2	1887		3.892577	
4	1	11	65.5			4.679385	
5	2	11	97.6	1734		5.762127	
6	2	11	76.2	1278		7.096171	
7	2	11	62.9	1135		8.563116	
8	1	11	73.3			9.015157	
9	2	11	68.7	1817		9.934388	
10	3	11	68.8	1038	1752	11.91514	

Statistics 4 (ChirpCenter Frequency: 5283.0 MHz)

Trial #	Pulse	Chirp(MHz)	Pulse Width (µS)	Pulse 1-2 spacing(µS)	Pulse 2-3 spacing(µS)	Pulse Start(S)	Detection (1:yes;0:no)
0	3	17	96.5	1075	1638	0.469907	1
1	2	17	63.8	1811		1.064689	
2	2	17	92.3	1674		2.209992	
3	3	17	70.7	1774	1481	3.334798	
4	3	17	70.5	1137	1517	4.305072	
5	2	17	71.4	1203		4.867228	
6	2	17	67.3	1660		5.98421	
7	2	17	77	1938		7.147643	
8	1	17	59.1			8.098494	
9	2	17	63.5	1387		8.692901	
10	2	17	77.2	1124		10.05241	
11	3	17	88.5	1967	1950	11.03745	
12	2	17	77.8	1831		11.72201	

Statistics 5 (ChirpCenter Frequency: 5284.0 MHz)

Trial #	Pulse	Chirp(MHz)	Pulse Width (µS)	Pulse 1-2 spacing(µS)	Pulse 2-3 spacing(µS)	Pulse Start(S)	Detection (1:yes;0:no)
0	3	15	52.3	1110	1966	0.414218	1
1	3	15	59.2	1547	1483	0.96154	
2	3	15	82.8	1665	1976	2.030258	
3	3	15	89.9	1504	1348	2.429598	
4	3	15	89.9	1696	1273	3.455139	
5	3	15	59	1528	1620	4.239887	
6	3	15	72.9	1503	1647	4.945988	
7	3	15	94.4	1711	1690	5.755974	
8	1	15	69.8			6.02314	
9	2	15	98.7	1969		7.340852	
10	3	15	54	1369	1102	8.093637	
11	2	15	93.1	1936		8.798171	
12	2	15	79.4	1807		9.442512	
13	2	15	76.2	1137		10.366	
14	3	15	77.6	1324	1628	10.75955	
15	2	15	65.9	1984		11.58145	

Statistics 6 (ChirpCenter Frequency: 5286.0 MHz)

Trial #	Pulse	Chirp(MHz)	Pulse Width (μS)	Pulse 1-2 spacing(μS)	Pulse 2-3 spacing(μS)	Pulse Start(S)	Detection (1:yes;0:no)
0	1	10	89.3			0.507432	1
1	3	10	69.2	1108	1206	1.004316	
2	3	10	71.6	1486	1490	1.639858	
3	3	10	90.8	1924	1222	2.400452	
4	1	10	84.9			2.703742	
5	1	10	81.7			3.657487	
6	3	10	67.1	1451	1170	4.068658	
7	2	10	71.4	1548		5.075034	
8	1	10	82.1			5.738791	
9	3	10	87.2	1860	1733	6.243778	
10	2	10	69.7	1744		7.326648	
11	2	10	60.9	1950		7.417085	
12	1	10	92.5			8.017831	
13	2	10	80.9	1787		9.026225	
14	3	10	74.4	1575	1798	9.375688	
15	2	10	63.5	1300		10.1205	
16	3	10	72.6	1830	1035	10.70897	
17	2	10	72.3	1845		11.42121	

Statistics 7 (ChirpCenter Frequency: 5283.0 MHz)

Trial #	Pulse	Chirp(MHz)	Pulse Width (μS)	Pulse 1-2 spacing(μS)	Pulse 2-3 spacing(μS)	Pulse Start(S)	Detection (1:yes;0:no)
0	1	18	89			0.11178	1
1	3	18	92.1	1952	1413	1.691868	
2	1	18	68.6			2.348415	
3	3	18	57.4	1747	1174	3.799681	
4	3	18	79.8	1591	1194	4.632383	
5	2	18	95.4	1241		5.208583	
6	3	18	92.1	1853	1109	6.729473	
7	2	18	81.2	1272		7.554683	
8	3	18	66.7	1397	1467	8.767468	
9	3	18	59.1	1656	1957	9.270662	
10	1	18	81.3			10.55434	
11	2	18	98.2	1204		11.47376	

Statistics 8 (ChirpCenter Frequency: 5287.0 MHz)

Trial #	Pulse	Chirp(MHz)	Pulse Width (μS)	Pulse 1-2 spacing(μS)	Pulse 2-3 spacing(μS)	Pulse Start(S)	Detection (1:yes;0:no)
0	3	7	63.2	1957	1598	1.269265	1
1	1	7	75.7			2.049496	
2	3	7	78.8	1591	1854	3.857436	
3	3	7	53.6	1977	1740	4.990045	
4	2	7	72.2	1758		5.494227	
5	2	7	68.8	1352		7.792267	
6	2	7	52.9	1068		8.31347	
7	2	7	74.9	1141		9.56715	
8	1	7	86.8			10.79249	

Statistics 9 (ChirpCenter Frequency: 5284.0 MHz)

Trial #	Pulse	Chirp(MHz)	Pulse Width (μS)	Pulse 1-2 spacing(μS)	Pulse 2-3 spacing(μS)	Pulse Start(S)	Detection (1:yes;0:no)
0	2	14	74.2	1460		0.496114	1
1	2	14	91.9	1439		0.93674	
2	1	14	93.8			2.073146	
3	2	14	91.8	1918		2.308299	
4	1	14	81.5			3.324589	
5	1	14	78.8			4.015461	
6	2	14	95.8	1058		4.329651	
7	3	14	53.5	1437	1198	5.243734	
8	2	14	65.6	1213		6.080059	
9	2	14	61.7	1484		6.415648	
10	3	14	67.9	1314	1966	7.544771	
11	2	14	57.7	1766		8.144375	
12	3	14	81.5	1729	1233	8.990169	
13	2	14	51.5	1461		9.691682	
14	3	14	66.7	1297	1473	10.20205	
15	2	14	80.2	1501		10.67496	
16	1	14	75.1			11.70291	

Statistics 10 (ChirpCenter Frequency: 5284.0 MHz)

Trial #	Pulse	Chirp(MHz)	Pulse Width (μS)	Pulse 1-2 spacing(μS)	Pulse 2-3 spacing(μS)	Pulse Start(S)	Detection (1:yes;0:no)
0	3	15	87	1607	1482	0.130226	1
1	3	15	97.5	1262	1189	1.063838	
2	3	15	86.6	1123	1120	1.998706	
3	1	15	74.5			2.602699	
4	3	15	89.2	1724	1576	3.946335	
5	3	15	75	1209	1422	4.578797	
6	1	15	53.8			5.265608	
7	2	15	57	1092		5.611562	
8	1	15	87.9			7.124597	
9	2	15	62.8	1182		7.270805	
10	1	15	83			8.691989	
11	1	15	88.4			9.497636	
12	2	15	61.3	1952		9.903582	
13	2	15	99.8	1095		10.86115	
14	1	15	50.5			11.45198	

Radar Type 6 Statistical Performance

Trial #	Fc (MHz)	Pulse /Burst	Pulse Width (µS)	PRI (µs)	Detection (1:yes; 0:no)	Hopping Sequence (MHz)
1	5270	9	1	333	1	5369.0, 5669.0, 5530.0, 5590.0, 5525.0, 5256.0, 5250.0, 5285.0, 5559.0, 5677.0, 5289.0, 5423.0, 5451.0, 5290.0, 5580.0, 5708.0, 5458.0, 5621.0, 5512.0, 5593.0, 5430.0, 5562.0, 5642.0, 5476.0, 5287.0, 5284.0, 5449.0, 5724.0, 5379.0, 5663.0, 5504.0, 5500.0, 5340.0, 5547.0, 5719.0, 5283.0, 5480.0, 5617.0, 5604.0, 5686.0, 5339.0, 5392.0, 5675.0, 5660.0, 5314.0, 5470.0, 5362.0, 5503.0, 5546.0, 5682.0, 5411.0, 5397.0, 5331.0, 5416.0, 5268.0, 5502.0, 5306.0, 5665.0, 5575.0, 5564.0, 5291.0, 5492.0, 5633.0, 5471.0, 5335.0, 5262.0, 5532.0, 5586.0, 5443.0, 5436.0, 5650.0, 5317.0, 5581.0, 5616.0, 5406.0, 5493.0, 5591.0, 5327.0, 5310.0, 5563.0, 5395.0, 5600.0, 5464.0, 5582.0, 5292.0, 5424.0, 5610.0, 5578.0, 5495.0, 5260.0, 5401.0, 5639.0, 5671.0, 5384.0, 5475.0, 5276.0, 5667.0, 5467.0, 5418.0, 5664.0
2	5270	9	1	333	1	5423.0, 5670.0, 5697.0, 5486.0, 5492.0, 5581.0, 5530.0, 5597.0, 5465.0, 5411.0, 5481.0, 5259.0, 5408.0, 5720.0, 5570.0, 5475.0, 5338.0, 5252.0, 5352.0, 5622.0, 5267.0, 5704.0, 5621.0, 5523.0, 5539.0, 5544.0, 5533.0, 5351.0, 5652.0, 5337.0, 5263.0, 5260.0, 5336.0, 5613.0, 5370.0, 5307.0, 5635.0, 5568.0, 5575.0, 5565.0, 5639.0, 5630.0, 5612.0, 5625.0, 5363.0, 5449.0, 5558.0, 5305.0, 5623.0, 5489.0, 5478.0, 5596.0, 5403.0, 5566.0, 5304.0, 5398.0, 5264.0, 5654.0, 5261.0, 5528.0, 5419.0, 5645.0, 5396.0, 5384.0, 5578.0, 5357.0, 5508.0, 5536.0, 5522.0, 5722.0, 5675.0, 5647.0, 5633.0, 5292.0, 5393.0, 5277.0, 5696.0, 5485.0, 5648.0, 5588.0, 5514.0, 5718.0, 5614.0, 5642.0, 5662.0, 5552.0, 5582.0, 5641.0, 5605.0, 5399.0, 5615.0, 5467.0, 5364.0, 5532.0, 5638.0, 5476.0, 5441.0, 5368.0, 5501.0, 5477.0
3	5270	9	1	333	1	5321.0, 5511.0, 5690.0, 5417.0, 5385.0, 5592.0, 5722.0, 5315.0, 5352.0, 5668.0, 5292.0, 5671.0, 5314.0, 5282.0, 5360.0, 5471.0, 5397.0, 5461.0, 5579.0, 5677.0, 5251.0, 5702.0, 5608.0, 5307.0, 5474.0, 5299.0, 5481.0, 5711.0, 5281.0, 5627.0, 5546.0, 5652.0, 5439.0, 5497.0, 5577.0, 5350.0, 5673.0, 5636.0, 5616.0, 5655.0, 5599.0, 5498.0, 5272.0, 5261.0, 5476.0, 5298.0, 5363.0, 5515.0, 5650.0, 5503.0, 5438.0, 5311.0, 5426.0, 5418.0, 5333.0, 5522.0, 5548.0, 5347.0, 5257.0, 5670.0, 5434.0, 5694.0, 5556.0, 5410.0, 5356.0

						5294.0, 5510.0, 5550.0, 5265.0, 5524.0, 5316.0, 5264.0, 5326.0, 5357.0, 5540.0, 5553.0, 5530.0, 5632.0, 5612.0, 5338.0, 5408.0, 5499.0, 5618.0, 5706.0, 5566.0, 5416.0, 5660.0, 5589.0, 5647.0, 5669.0, 5400.0, 5332.0, 5328.0, 5341.0, 5482.0, 5373.0, 5465.0, 5335.0, 5435.0, 5383.0
4	5270	9	1	333	1	5370.0, 5664.0, 5422.0, 5342.0, 5531.0, 5361.0, 5699.0, 5686.0, 5431.0, 5718.0, 5317.0, 5527.0, 5714.0, 5349.0, 5336.0, 5514.0, 5631.0, 5670.0, 5277.0, 5471.0, 5695.0, 5432.0, 5307.0, 5434.0, 5281.0, 5329.0, 5407.0, 5328.0, 5266.0, 5280.0, 5339.0, 5601.0, 5640.0, 5496.0, 5512.0, 5499.0, 5703.0, 5667.0, 5466.0, 5481.0, 5479.0, 5430.0, 5386.0, 5295.0, 5500.0, 5292.0, 5356.0, 5392.0, 5552.0, 5545.0, 5639.0, 5628.0, 5495.0, 5286.0, 5366.0, 5575.0, 5456.0, 5395.0, 5413.0, 5429.0, 5519.0, 5348.0, 5369.0, 5702.0, 5478.0, 5544.0, 5663.0, 5296.0, 5723.0, 5410.0, 5343.0, 5373.0, 5536.0, 5297.0, 5383.0, 5653.0, 5638.0, 5401.0, 5621.0, 5583.0, 5398.0, 5671.0, 5539.0, 5411.0, 5573.0, 5447.0, 5595.0, 5294.0, 5315.0, 5599.0, 5475.0, 5404.0, 5412.0, 5530.0, 5492.0, 5651.0, 5624.0, 5388.0, 5510.0, 5563.0
5	5270	9	1	333	1	5681.0, 5578.0, 5380.0, 5594.0, 5347.0, 5425.0, 5695.0, 5324.0, 5419.0, 5311.0, 5297.0, 5702.0, 5490.0, 5265.0, 5614.0, 5430.0, 5678.0, 5391.0, 5444.0, 5431.0, 5293.0, 5714.0, 5346.0, 5710.0, 5615.0, 5310.0, 5720.0, 5603.0, 5257.0, 5339.0, 5361.0, 5384.0, 5670.0, 5470.0, 5650.0, 5487.0, 5492.0, 5559.0, 5326.0, 5480.0, 5424.0, 5267.0, 5523.0, 5358.0, 5250.0, 5429.0, 5648.0, 5435.0, 5643.0, 5389.0, 5694.0, 5386.0, 5506.0, 5318.0, 5343.0, 5292.0, 5350.0, 5616.0, 5624.0, 5288.0, 5546.0, 5508.0, 5321.0, 5533.0, 5515.0, 5699.0, 5482.0, 5456.0, 5323.0, 5272.0, 5542.0, 5416.0, 5295.0, 5418.0, 5555.0, 5261.0, 5574.0, 5656.0, 5512.0, 5488.0, 5708.0, 5557.0, 5530.0, 5664.0, 5598.0, 5541.0, 5300.0, 5302.0, 5256.0, 5417.0, 5496.0, 5505.0, 5588.0, 5645.0, 5316.0, 5440.0, 5640.0, 5701.0, 5544.0, 5255.0
6	5270	9	1	333	1	5281.0, 5538.0, 5405.0, 5540.0, 5410.0, 5345.0, 5634.0, 5704.0, 5401.0, 5336.0, 5589.0, 5621.0, 5542.0, 5592.0, 5438.0, 5295.0, 5633.0, 5340.0, 5554.0, 5499.0, 5297.0, 5280.0, 5722.0, 5286.0, 5721.0, 5564.0, 5397.0, 5477.0, 5679.0, 5495.0, 5684.0, 5501.0, 5603.0, 5359.0, 5267.0, 5437.0, 5368.0, 5418.0, 5369.0, 5507.0, 5460.0, 5393.0, 5467.0, 5714.0, 5637.0, 5676.0, 5646.0, 5440.0, 5593.0, 5305.0, 5271.0, 5523.0, 5491.0, 5313.0, 5466.0, 5566.0, 5374.0, 5430.0, 5465.0, 5615.0, 5453.0, 5426.0, 5347.0, 5520.0, 5617.0,

						5362.0, 5456.0, 5434.0, 5375.0, 5638.0, 5476.0, 5449.0, 5284.0, 5534.0, 5486.0, 5503.0, 5723.0, 5513.0, 5483.0, 5611.0, 5364.0, 5528.0, 5613.0, 5715.0, 5653.0, 5392.0, 5461.0, 5327.0, 5674.0, 5527.0, 5712.0, 5316.0, 5510.0, 5391.0, 5287.0, 5643.0, 5612.0, 5601.0, 5517.0, 5565.0
7	5270	9	1	333	1	5628.0, 5368.0, 5252.0, 5507.0, 5437.0, 5488.0, 5618.0, 5479.0, 5290.0, 5520.0, 5466.0, 5718.0, 5281.0, 5420.0, 5535.0, 5642.0, 5387.0, 5469.0, 5708.0, 5276.0, 5271.0, 5441.0, 5665.0, 5661.0, 5275.0, 5294.0, 5348.0, 5716.0, 5624.0, 5461.0, 5501.0, 5689.0, 5601.0, 5411.0, 5655.0, 5548.0, 5473.0, 5678.0, 5312.0, 5344.0, 5372.0, 5370.0, 5685.0, 5409.0, 5298.0, 5413.0, 5365.0, 5554.0, 5324.0, 5400.0, 5293.0, 5385.0, 5388.0, 5546.0, 5415.0, 5322.0, 5440.0, 5277.0, 5515.0, 5603.0, 5573.0, 5361.0, 5723.0, 5417.0, 5703.0, 5696.0, 5621.0, 5286.0, 5579.0, 5622.0, 5251.0, 5360.0, 5509.0, 5652.0, 5674.0, 5633.0, 5584.0, 5700.0, 5503.0, 5506.0, 5261.0, 5310.0, 5698.0, 5305.0, 5631.0, 5701.0, 5396.0, 5272.0, 5590.0, 5447.0, 5485.0, 5559.0, 5283.0, 5627.0, 5389.0, 5486.0, 5403.0, 5356.0, 5676.0, 5687.0
8	5270	9	1	333	1	5500.0, 5475.0, 5637.0, 5716.0, 5634.0, 5441.0, 5321.0, 5376.0, 5476.0, 5418.0, 5346.0, 5520.0, 5437.0, 5636.0, 5374.0, 5464.0, 5466.0, 5576.0, 5287.0, 5525.0, 5323.0, 5355.0, 5574.0, 5536.0, 5675.0, 5454.0, 5542.0, 5357.0, 5616.0, 5643.0, 5424.0, 5386.0, 5324.0, 5512.0, 5260.0, 5295.0, 5552.0, 5285.0, 5435.0, 5718.0, 5522.0, 5518.0, 5509.0, 5667.0, 5656.0, 5506.0, 5299.0, 5263.0, 5582.0, 5494.0, 5519.0, 5250.0, 5507.0, 5308.0, 5289.0, 5453.0, 5682.0, 5695.0, 5254.0, 5384.0, 5670.0, 5516.0, 5531.0, 5479.0, 5581.0, 5523.0, 5646.0, 5555.0, 5619.0, 5589.0, 5361.0, 5438.0, 5530.0, 5280.0, 5341.0, 5607.0, 5638.0, 5276.0, 5711.0, 5373.0, 5645.0, 5537.0, 5314.0, 5395.0, 5405.0, 5434.0, 5310.0, 5311.0, 5625.0, 5622.0, 5658.0, 5459.0, 5303.0, 5481.0, 5641.0, 5360.0, 5501.0, 5294.0, 5504.0, 5527.0
9	5270	9	1	333	1	5333.0, 5553.0, 5626.0, 5635.0, 5435.0, 5537.0, 5583.0, 5451.0, 5259.0, 5533.0, 5670.0, 5420.0, 5572.0, 5392.0, 5437.0, 5339.0, 5666.0, 5269.0, 5475.0, 5371.0, 5506.0, 5716.0, 5688.0, 5675.0, 5345.0, 5321.0, 5353.0, 5366.0, 5369.0, 5513.0, 5293.0, 5416.0, 5536.0, 5559.0, 5336.0, 5516.0, 5359.0, 5284.0, 5283.0, 5606.0, 5458.0, 5446.0, 5497.0, 5443.0, 5492.0, 5596.0, 5295.0, 5620.0, 5519.0, 5350.0, 5434.0, 5444.0, 5450.0, 5320.0, 5278.0, 5478.0, 5317.0, 5386.0, 5503.0, 5310.0, 5438.0, 5272.0, 5576.0, 5343.0, 5327.0,

						5311.0, 5591.0, 5349.0, 5563.0, 5646.0, 5433.0, 5432.0, 5488.0, 5291.0, 5557.0, 5312.0, 5658.0, 5352.0, 5683.0, 5708.0, 5611.0, 5521.0, 5706.0, 5605.0, 5574.0, 5577.0, 5382.0, 5313.0, 5682.0, 5538.0, 5422.0, 5699.0, 5415.0, 5613.0, 5530.0, 5300.0, 5616.0, 5687.0, 5556.0, 5677.0
10	5270	9	1	333	1	5268.0, 5564.0, 5383.0, 5267.0, 5334.0, 5270.0, 5637.0, 5357.0, 5411.0, 5344.0, 5635.0, 5332.0, 5374.0, 5361.0, 5287.0, 5619.0, 5305.0, 5294.0, 5485.0, 5266.0, 5587.0, 5272.0, 5643.0, 5613.0, 5664.0, 5717.0, 5673.0, 5436.0, 5604.0, 5269.0, 5481.0, 5428.0, 5527.0, 5386.0, 5424.0, 5538.0, 5281.0, 5315.0, 5706.0, 5319.0, 5510.0, 5260.0, 5461.0, 5625.0, 5657.0, 5257.0, 5371.0, 5464.0, 5381.0, 5303.0, 5659.0, 5419.0, 5649.0, 5528.0, 5279.0, 5534.0, 5300.0, 5469.0, 5322.0, 5521.0, 5712.0, 5359.0, 5352.0, 5699.0, 5503.0, 5704.0, 5693.0, 5550.0, 5572.0, 5651.0, 5402.0, 5274.0, 5655.0, 5606.0, 5345.0, 5286.0, 5466.0, 5342.0, 5674.0, 5265.0, 5543.0, 5377.0, 5599.0, 5449.0, 5335.0, 5393.0, 5397.0, 5290.0, 5256.0, 5451.0, 5658.0, 5605.0, 5555.0, 5647.0, 5654.0, 5333.0, 5472.0, 5541.0, 5413.0, 5326.0
11	5270	9	1	333	1	5262.0, 5313.0, 5494.0, 5527.0, 5426.0, 5495.0, 5363.0, 5374.0, 5513.0, 5417.0, 5580.0, 5576.0, 5465.0, 5502.0, 5456.0, 5714.0, 5324.0, 5586.0, 5656.0, 5563.0, 5644.0, 5572.0, 5398.0, 5695.0, 5430.0, 5442.0, 5686.0, 5460.0, 5592.0, 5593.0, 5352.0, 5275.0, 5469.0, 5265.0, 5310.0, 5425.0, 5510.0, 5433.0, 5497.0, 5684.0, 5301.0, 5448.0, 5612.0, 5416.0, 5561.0, 5564.0, 5571.0, 5583.0, 5498.0, 5272.0, 5423.0, 5346.0, 5664.0, 5486.0, 5597.0, 5297.0, 5424.0, 5327.0, 5554.0, 5604.0, 5393.0, 5503.0, 5362.0, 5257.0, 5567.0, 5525.0, 5706.0, 5587.0, 5658.0, 5315.0, 5412.0, 5482.0, 5693.0, 5546.0, 5274.0, 5625.0, 5622.0, 5372.0, 5518.0, 5680.0, 5666.0, 5406.0, 5410.0, 5282.0, 5302.0, 5568.0, 5445.0, 5399.0, 5347.0, 5565.0, 5484.0, 5471.0, 5336.0, 5562.0, 5685.0, 5500.0, 5322.0, 5557.0, 5603.0, 5670.0
12	5270	9	1	333	1	5304.0, 5679.0, 5252.0, 5481.0, 5628.0, 5712.0, 5255.0, 5585.0, 5555.0, 5510.0, 5444.0, 5378.0, 5273.0, 5386.0, 5368.0, 5548.0, 5309.0, 5445.0, 5596.0, 5668.0, 5703.0, 5316.0, 5381.0, 5646.0, 5262.0, 5567.0, 5674.0, 5447.0, 5590.0, 5650.0, 5462.0, 5582.0, 5389.0, 5570.0, 5512.0, 5580.0, 5330.0, 5339.0, 5375.0, 5641.0, 5469.0, 5404.0, 5259.0, 5358.0, 5473.0, 5513.0, 5536.0, 5684.0, 5526.0, 5587.0, 5496.0, 5523.0, 5334.0, 5468.0, 5601.0, 5327.0, 5433.0, 5633.0, 5711.0, 5676.0, 5337.0, 5362.0, 5296.0, 5388.0, 5714.0,

						5412.0, 5552.0, 5405.0, 5546.0, 5382.0, 5648.0, 5543.0, 5459.0, 5256.0, 5638.0, 5480.0, 5306.0, 5338.0, 5522.0, 5303.0, 5716.0, 5487.0, 5715.0, 5557.0, 5636.0, 5415.0, 5722.0, 5446.0, 5599.0, 5697.0, 5268.0, 5491.0, 5508.0, 5530.0, 5418.0, 5344.0, 5534.0, 5432.0, 5442.0, 5349.0
13	5270	9	1	333	1	5424.0, 5574.0, 5498.0, 5401.0, 5654.0, 5535.0, 5693.0, 5258.0, 5364.0, 5338.0, 5621.0, 5271.0, 5312.0, 5560.0, 5684.0, 5643.0, 5368.0, 5307.0, 5467.0, 5675.0, 5284.0, 5696.0, 5381.0, 5483.0, 5473.0, 5373.0, 5525.0, 5394.0, 5493.0, 5613.0, 5653.0, 5358.0, 5691.0, 5566.0, 5639.0, 5420.0, 5687.0, 5325.0, 5374.0, 5689.0, 5516.0, 5697.0, 5469.0, 5400.0, 5417.0, 5565.0, 5707.0, 5273.0, 5310.0, 5477.0, 5327.0, 5722.0, 5699.0, 5713.0, 5363.0, 5663.0, 5379.0, 5331.0, 5484.0, 5436.0, 5524.0, 5336.0, 5564.0, 5505.0, 5510.0, 5528.0, 5547.0, 5542.0, 5421.0, 5398.0, 5683.0, 5344.0, 5595.0, 5337.0, 5651.0, 5466.0, 5599.0, 5320.0, 5488.0, 5470.0, 5672.0, 5455.0, 5430.0, 5352.0, 5304.0, 5537.0, 5534.0, 5451.0, 5678.0, 5399.0, 5589.0, 5495.0, 5412.0, 5627.0, 5577.0, 5387.0, 5449.0, 5267.0, 5291.0, 5626.0
14	5270	9	1	333	1	5707.0, 5284.0, 5312.0, 5695.0, 5495.0, 5588.0, 5440.0, 5461.0, 5620.0, 5484.0, 5696.0, 5697.0, 5500.0, 5676.0, 5452.0, 5563.0, 5450.0, 5504.0, 5496.0, 5432.0, 5559.0, 5644.0, 5353.0, 5724.0, 5331.0, 5652.0, 5338.0, 5259.0, 5301.0, 5518.0, 5622.0, 5292.0, 5650.0, 5547.0, 5506.0, 5441.0, 5556.0, 5334.0, 5653.0, 5375.0, 5256.0, 5326.0, 5418.0, 5702.0, 5633.0, 5715.0, 5420.0, 5543.0, 5487.0, 5651.0, 5423.0, 5569.0, 5590.0, 5268.0, 5436.0, 5388.0, 5527.0, 5539.0, 5411.0, 5714.0, 5576.0, 5647.0, 5523.0, 5704.0, 5429.0, 5722.0, 5324.0, 5413.0, 5567.0, 5712.0, 5296.0, 5280.0, 5376.0, 5478.0, 5366.0, 5473.0, 5467.0, 5442.0, 5444.0, 5290.0, 5538.0, 5382.0, 5400.0, 5347.0, 5479.0, 5332.0, 5281.0, 5670.0, 5379.0, 5370.0, 5485.0, 5632.0, 5410.0, 5483.0, 5528.0, 5557.0, 5637.0, 5395.0, 5308.0, 5424.0
15	5270	9	1	333	1	5441.0, 5568.0, 5312.0, 5649.0, 5501.0, 5703.0, 5575.0, 5467.0, 5336.0, 5391.0, 5371.0, 5670.0, 5535.0, 5678.0, 5534.0, 5642.0, 5623.0, 5514.0, 5605.0, 5705.0, 5270.0, 5331.0, 5252.0, 5366.0, 5616.0, 5578.0, 5619.0, 5263.0, 5697.0, 5254.0, 5630.0, 5611.0, 5403.0, 5471.0, 5606.0, 5435.0, 5268.0, 5452.0, 5621.0, 5376.0, 5429.0, 5522.0, 5546.0, 5330.0, 5717.0, 5476.0, 5604.0, 5666.0, 5423.0, 5409.0, 5552.0, 5721.0, 5383.0, 5688.0, 5675.0, 5346.0, 5442.0, 5337.0, 5294.0, 5637.0, 5370.0, 5577.0, 5276.0, 5440.0, 5562.0,

						5591.0, 5281.0, 5488.0, 5300.0, 5285.0, 5492.0, 5307.0, 5509.0, 5572.0, 5262.0, 5272.0, 5444.0, 5553.0, 5390.0, 5520.0, 5723.0, 5557.0, 5532.0, 5673.0, 5620.0, 5283.0, 5421.0, 5580.0, 5433.0, 5490.0, 5498.0, 5689.0, 5299.0, 5516.0, 5273.0, 5350.0, 5614.0, 5632.0, 5297.0, 5425.0
16	5270	9	1	333	1	5263.0, 5633.0, 5460.0, 5340.0, 5260.0, 5451.0, 5637.0, 5301.0, 5504.0, 5569.0, 5281.0, 5342.0, 5421.0, 5317.0, 5373.0, 5690.0, 5444.0, 5291.0, 5639.0, 5307.0, 5349.0, 5474.0, 5611.0, 5309.0, 5450.0, 5447.0, 5372.0, 5594.0, 5619.0, 5580.0, 5336.0, 5262.0, 5680.0, 5395.0, 5437.0, 5279.0, 5299.0, 5361.0, 5265.0, 5626.0, 5251.0, 5582.0, 5353.0, 5622.0, 5343.0, 5254.0, 5657.0, 5678.0, 5654.0, 5682.0, 5600.0, 5490.0, 5406.0, 5591.0, 5256.0, 5497.0, 5259.0, 5471.0, 5598.0, 5588.0, 5672.0, 5277.0, 5720.0, 5538.0, 5382.0, 5710.0, 5322.0, 5668.0, 5401.0, 5503.0, 5712.0, 5412.0, 5655.0, 5562.0, 5599.0, 5488.0, 5692.0, 5333.0, 5346.0, 5506.0, 5609.0, 5525.0, 5475.0, 5511.0, 5508.0, 5331.0, 5700.0, 5278.0, 5312.0, 5290.0, 5446.0, 5329.0, 5516.0, 5560.0, 5271.0, 5298.0, 5517.0, 5328.0, 5368.0, 5717.0
17	5270	9	1	333	1	5635.0, 5471.0, 5379.0, 5404.0, 5628.0, 5369.0, 5436.0, 5439.0, 5356.0, 5262.0, 5557.0, 5310.0, 5402.0, 5632.0, 5536.0, 5371.0, 5264.0, 5476.0, 5454.0, 5270.0, 5500.0, 5383.0, 5428.0, 5526.0, 5595.0, 5441.0, 5596.0, 5453.0, 5445.0, 5267.0, 5698.0, 5372.0, 5435.0, 5266.0, 5358.0, 5421.0, 5571.0, 5523.0, 5389.0, 5260.0, 5615.0, 5434.0, 5268.0, 5497.0, 5271.0, 5656.0, 5317.0, 5391.0, 5299.0, 5346.0, 5367.0, 5480.0, 5612.0, 5550.0, 5277.0, 5652.0, 5357.0, 5472.0, 5598.0, 5488.0, 5546.0, 5451.0, 5703.0, 5285.0, 5610.0, 5587.0, 5601.0, 5711.0, 5677.0, 5483.0, 5527.0, 5443.0, 5534.0, 5616.0, 5333.0, 5464.0, 5254.0, 5440.0, 5707.0, 5353.0, 5567.0, 5406.0, 5572.0, 5418.0, 5586.0, 5722.0, 5545.0, 5530.0, 5581.0, 5477.0, 5544.0, 5461.0, 5637.0, 5460.0, 5272.0, 5675.0, 5666.0, 5280.0, 5444.0, 5382.0
18	5270	9	1	333	1	5588.0, 5587.0, 5294.0, 5473.0, 5438.0, 5568.0, 5280.0, 5607.0, 5273.0, 5361.0, 5631.0, 5446.0, 5530.0, 5582.0, 5288.0, 5314.0, 5363.0, 5343.0, 5355.0, 5472.0, 5461.0, 5281.0, 5503.0, 5259.0, 5513.0, 5674.0, 5531.0, 5380.0, 5415.0, 5546.0, 5369.0, 5591.0, 5497.0, 5715.0, 5636.0, 5700.0, 5714.0, 5629.0, 5515.0, 5634.0, 5310.0, 5423.0, 5476.0, 5716.0, 5610.0, 5431.0, 5451.0, 5525.0, 5262.0, 5558.0, 5326.0, 5724.0, 5643.0, 5586.0, 5317.0, 5311.0, 5711.0, 5358.0, 5661.0, 5702.0, 5251.0, 5574.0, 5599.0, 5299.0, 5644.0

						5386.0, 5322.0, 5561.0, 5484.0, 5387.0, 5692.0, 5347.0, 5520.0, 5623.0, 5554.0, 5483.0, 5290.0, 5698.0, 5559.0, 5685.0, 5602.0, 5381.0, 5474.0, 5351.0, 5534.0, 5638.0, 5469.0, 5283.0, 5518.0, 5396.0, 5324.0, 5426.0, 5615.0, 5354.0, 5445.0, 5668.0, 5335.0, 5624.0, 5287.0, 5400.0
19	5270	9	1	333	1	5457.0, 5419.0, 5455.0, 5626.0, 5667.0, 5474.0, 5282.0, 5490.0, 5365.0, 5463.0, 5323.0, 5278.0, 5395.0, 5267.0, 5312.0, 5541.0, 5330.0, 5466.0, 5252.0, 5362.0, 5442.0, 5604.0, 5633.0, 5505.0, 5435.0, 5685.0, 5397.0, 5326.0, 5523.0, 5432.0, 5405.0, 5580.0, 5529.0, 5647.0, 5314.0, 5451.0, 5424.0, 5319.0, 5350.0, 5550.0, 5683.0, 5388.0, 5265.0, 5253.0, 5291.0, 5534.0, 5293.0, 5334.0, 5402.0, 5269.0, 5661.0, 5476.0, 5663.0, 5396.0, 5452.0, 5608.0, 5428.0, 5676.0, 5570.0, 5441.0, 5545.0, 5681.0, 5518.0, 5542.0, 5665.0, 5525.0, 5511.0, 5721.0, 5416.0, 5430.0, 5366.0, 5491.0, 5251.0, 5345.0, 5324.0, 5382.0, 5349.0, 5552.0, 5565.0, 5581.0, 5674.0, 5610.0, 5689.0, 5268.0, 5281.0, 5480.0, 5346.0, 5311.0, 5637.0, 5517.0, 5266.0, 5394.0, 5557.0, 5384.0, 5629.0, 5456.0, 5423.0, 5333.0, 5531.0, 5607.0
20	5270	9	1	333	1	5517.0, 5668.0, 5588.0, 5463.0, 5591.0, 5385.0, 5456.0, 5418.0, 5363.0, 5495.0, 5291.0, 5315.0, 5700.0, 5492.0, 5639.0, 5449.0, 5412.0, 5442.0, 5275.0, 5282.0, 5598.0, 5521.0, 5443.0, 5654.0, 5461.0, 5714.0, 5367.0, 5481.0, 5351.0, 5670.0, 5660.0, 5695.0, 5701.0, 5301.0, 5323.0, 5459.0, 5278.0, 5313.0, 5379.0, 5440.0, 5407.0, 5603.0, 5359.0, 5644.0, 5568.0, 5408.0, 5694.0, 5494.0, 5596.0, 5676.0, 5305.0, 5255.0, 5296.0, 5340.0, 5650.0, 5613.0, 5523.0, 5292.0, 5559.0, 5499.0, 5609.0, 5373.0, 5430.0, 5562.0, 5478.0, 5368.0, 5322.0, 5446.0, 5436.0, 5361.0, 5502.0, 5529.0, 5280.0, 5345.0, 5434.0, 5684.0, 5555.0, 5646.0, 5347.0, 5636.0, 5534.0, 5454.0, 5530.0, 5665.0, 5424.0, 5584.0, 5441.0, 5445.0, 5532.0, 5656.0, 5702.0, 5629.0, 5582.0, 5482.0, 5355.0, 5606.0, 5337.0, 5417.0, 5682.0, 5333.0
21	5270	9	1	333	1	5587.0, 5459.0, 5693.0, 5565.0, 5335.0, 5380.0, 5685.0, 5397.0, 5376.0, 5406.0, 5484.0, 5352.0, 5470.0, 5438.0, 5265.0, 5292.0, 5539.0, 5602.0, 5302.0, 5627.0, 5347.0, 5676.0, 5316.0, 5441.0, 5704.0, 5446.0, 5711.0, 5580.0, 5461.0, 5286.0, 5364.0, 5360.0, 5422.0, 5508.0, 5548.0, 5385.0, 5304.0, 5350.0, 5293.0, 5390.0, 5256.0, 5375.0, 5285.0, 5277.0, 5661.0, 5408.0, 5496.0, 5540.0, 5672.0, 5555.0, 5445.0, 5606.0, 5677.0, 5322.0, 5346.0, 5653.0, 5471.0, 5344.0, 5447.0, 5506.0, 5396.0, 5467.0, 5323.0, 5597.0, 5550.0

						5601.0, 5719.0, 5681.0, 5332.0, 5695.0, 5387.0, 5495.0, 5485.0, 5369.0, 5275.0, 5257.0, 5469.0, 5573.0, 5314.0, 5554.0, 5682.0, 5642.0, 5412.0, 5465.0, 5327.0, 5488.0, 5393.0, 5705.0, 5497.0, 5562.0, 5483.0, 5460.0, 5398.0, 5288.0, 5290.0, 5609.0, 5581.0, 5635.0, 5584.0, 5556.0
22	5270	9	1	333	1	5671.0, 5374.0, 5312.0, 5700.0, 5321.0, 5653.0, 5512.0, 5365.0, 5292.0, 5371.0, 5252.0, 5545.0, 5615.0, 5548.0, 5441.0, 5510.0, 5517.0, 5628.0, 5335.0, 5657.0, 5395.0, 5675.0, 5536.0, 5415.0, 5351.0, 5327.0, 5251.0, 5469.0, 5450.0, 5638.0, 5696.0, 5636.0, 5543.0, 5262.0, 5297.0, 5324.0, 5449.0, 5359.0, 5648.0, 5337.0, 5370.0, 5707.0, 5666.0, 5672.0, 5654.0, 5537.0, 5344.0, 5411.0, 5463.0, 5476.0, 5673.0, 5477.0, 5452.0, 5578.0, 5534.0, 5281.0, 5581.0, 5267.0, 5661.0, 5263.0, 5275.0, 5277.0, 5546.0, 5644.0, 5334.0, 5294.0, 5524.0, 5684.0, 5380.0, 5398.0, 5454.0, 5318.0, 5280.0, 5366.0, 5625.0, 5692.0, 5630.0, 5511.0, 5688.0, 5577.0, 5256.0, 5261.0, 5488.0, 5472.0, 5360.0, 5338.0, 5314.0, 5652.0, 5361.0, 5559.0, 5579.0, 5508.0, 5397.0, 5289.0, 5407.0, 5720.0, 5307.0, 5655.0, 5564.0, 5647.0
23	5270	9	1	333	1	5475.0, 5400.0, 5444.0, 5537.0, 5399.0, 5577.0, 5576.0, 5478.0, 5314.0, 5362.0, 5406.0, 5607.0, 5693.0, 5471.0, 5555.0, 5374.0, 5525.0, 5441.0, 5702.0, 5332.0, 5641.0, 5368.0, 5271.0, 5371.0, 5514.0, 5566.0, 5279.0, 5431.0, 5432.0, 5388.0, 5396.0, 5398.0, 5483.0, 5666.0, 5353.0, 5487.0, 5551.0, 5661.0, 5276.0, 5701.0, 5652.0, 5618.0, 5358.0, 5364.0, 5708.0, 5395.0, 5626.0, 5589.0, 5281.0, 5472.0, 5606.0, 5697.0, 5687.0, 5631.0, 5696.0, 5256.0, 5629.0, 5477.0, 5656.0, 5336.0, 5635.0, 5623.0, 5408.0, 5676.0, 5615.0, 5612.0, 5559.0, 5401.0, 5451.0, 5491.0, 5721.0, 5308.0, 5407.0, 5572.0, 5673.0, 5705.0, 5453.0, 5667.0, 5363.0, 5290.0, 5677.0, 5404.0, 5341.0, 5624.0, 5703.0, 5316.0, 5668.0, 5301.0, 5442.0, 5352.0, 5355.0, 5637.0, 5342.0, 5380.0, 5598.0, 5574.0, 5385.0, 5689.0, 5608.0, 5503.0
24	5270	9	1	333	1	5354.0, 5334.0, 5608.0, 5698.0, 5567.0, 5398.0, 5508.0, 5587.0, 5670.0, 5253.0, 5448.0, 5585.0, 5533.0, 5643.0, 5432.0, 5501.0, 5524.0, 5483.0, 5465.0, 5675.0, 5687.0, 5446.0, 5480.0, 5317.0, 5427.0, 5498.0, 5265.0, 5487.0, 5538.0, 5537.0, 5503.0, 5263.0, 5705.0, 5457.0, 5535.0, 5421.0, 5714.0, 5418.0, 5633.0, 5568.0, 5664.0, 5517.0, 5673.0, 5679.0, 5486.0, 5684.0, 5496.0, 5375.0, 5339.0, 5430.0, 5560.0, 5541.0, 5297.0, 5455.0, 5626.0, 5637.0, 5531.0, 5460.0, 5500.0, 5439.0, 5257.0, 5286.0, 5678.0, 5393.0, 5345.0

						5622.0, 5658.0, 5702.0, 5623.0, 5435.0, 5332.0, 5321.0, 5649.0, 5437.0, 5701.0, 5555.0, 5539.0, 5420.0, 5329.0, 5355.0, 5544.0, 5358.0, 5276.0, 5271.0, 5611.0, 5660.0, 5344.0, 5653.0, 5516.0, 5680.0, 5505.0, 5341.0, 5417.0, 5302.0, 5570.0, 5433.0, 5592.0, 5312.0, 5590.0, 5415.0
25	5270	9	1	333	1	5422.0, 5456.0, 5428.0, 5394.0, 5582.0, 5681.0, 5519.0, 5701.0, 5608.0, 5291.0, 5659.0, 5634.0, 5336.0, 5600.0, 5374.0, 5302.0, 5411.0, 5670.0, 5603.0, 5672.0, 5293.0, 5387.0, 5500.0, 5269.0, 5664.0, 5661.0, 5675.0, 5461.0, 5350.0, 5250.0, 5449.0, 5331.0, 5395.0, 5427.0, 5549.0, 5564.0, 5557.0, 5647.0, 5559.0, 5265.0, 5660.0, 5320.0, 5479.0, 5298.0, 5377.0, 5475.0, 5441.0, 5375.0, 5364.0, 5454.0, 5567.0, 5261.0, 5260.0, 5392.0, 5721.0, 5366.0, 5686.0, 5408.0, 5618.0, 5637.0, 5521.0, 5398.0, 5707.0, 5340.0, 5369.0, 5715.0, 5476.0, 5378.0, 5421.0, 5444.0, 5696.0, 5325.0, 5472.0, 5610.0, 5641.0, 5624.0, 5537.0, 5585.0, 5418.0, 5642.0, 5297.0, 5687.0, 5673.0, 5619.0, 5678.0, 5429.0, 5720.0, 5653.0, 5443.0, 5578.0, 5657.0, 5658.0, 5282.0, 5345.0, 5370.0, 5372.0, 5305.0, 5435.0, 5341.0, 5334.0
26	5270	9	1	333	1	5356.0, 5267.0, 5594.0, 5627.0, 5452.0, 5644.0, 5572.0, 5639.0, 5398.0, 5389.0, 5342.0, 5401.0, 5520.0, 5477.0, 5541.0, 5335.0, 5533.0, 5428.0, 5295.0, 5609.0, 5419.0, 5589.0, 5292.0, 5310.0, 5330.0, 5481.0, 5525.0, 5615.0, 5722.0, 5279.0, 5333.0, 5515.0, 5269.0, 5415.0, 5403.0, 5253.0, 5414.0, 5577.0, 5492.0, 5348.0, 5698.0, 5614.0, 5554.0, 5418.0, 5592.0, 5635.0, 5350.0, 5689.0, 5448.0, 5692.0, 5380.0, 5530.0, 5578.0, 5318.0, 5469.0, 5488.0, 5293.0, 5565.0, 5296.0, 5619.0, 5442.0, 5404.0, 5508.0, 5397.0, 5340.0, 5504.0, 5413.0, 5262.0, 5374.0, 5375.0, 5439.0, 5328.0, 5534.0, 5327.0, 5688.0, 5437.0, 5575.0, 5460.0, 5363.0, 5480.0, 5456.0, 5690.0, 5551.0, 5699.0, 5673.0, 5663.0, 5424.0, 5681.0, 5255.0, 5429.0, 5392.0, 5395.0, 5678.0, 5648.0, 5358.0, 5423.0, 5553.0, 5260.0, 5532.0, 5369.0
27	5270	9	1	333	1	5671.0, 5611.0, 5403.0, 5386.0, 5631.0, 5326.0, 5314.0, 5656.0, 5512.0, 5626.0, 5483.0, 5311.0, 5256.0, 5265.0, 5257.0, 5454.0, 5406.0, 5418.0, 5552.0, 5383.0, 5618.0, 5493.0, 5365.0, 5456.0, 5496.0, 5591.0, 5592.0, 5325.0, 5323.0, 5443.0, 5500.0, 5628.0, 5295.0, 5340.0, 5526.0, 5638.0, 5604.0, 5342.0, 5550.0, 5710.0, 5335.0, 5658.0, 5401.0, 5621.0, 5612.0, 5461.0, 5708.0, 5391.0, 5409.0, 5501.0, 5373.0, 5390.0, 5289.0, 5412.0, 5684.0, 5551.0, 5370.0, 5319.0, 5670.0, 5510.0, 5668.0, 5288.0, 5642.0, 5494.0, 5566.0

						5313.0, 5716.0, 5545.0, 5449.0, 5637.0, 5345.0, 5274.0, 5458.0, 5359.0, 5473.0, 5544.0, 5511.0, 5439.0, 5269.0, 5565.0, 5677.0, 5529.0, 5524.0, 5603.0, 5413.0, 5469.0, 5712.0, 5569.0, 5387.0, 5267.0, 5488.0, 5534.0, 5367.0, 5481.0, 5320.0, 5547.0, 5459.0, 5602.0, 5680.0, 5339.0
28	5270	9	1	333	1	5355.0, 5330.0, 5388.0, 5395.0, 5351.0, 5673.0, 5549.0, 5689.0, 5577.0, 5700.0, 5622.0, 5479.0, 5356.0, 5433.0, 5368.0, 5327.0, 5521.0, 5257.0, 5500.0, 5396.0, 5703.0, 5439.0, 5718.0, 5478.0, 5264.0, 5496.0, 5624.0, 5352.0, 5646.0, 5579.0, 5314.0, 5717.0, 5365.0, 5430.0, 5495.0, 5324.0, 5698.0, 5410.0, 5546.0, 5589.0, 5621.0, 5426.0, 5537.0, 5716.0, 5530.0, 5453.0, 5505.0, 5675.0, 5269.0, 5471.0, 5713.0, 5664.0, 5391.0, 5623.0, 5404.0, 5652.0, 5493.0, 5429.0, 5613.0, 5348.0, 5647.0, 5332.0, 5617.0, 5278.0, 5334.0, 5556.0, 5524.0, 5457.0, 5252.0, 5668.0, 5451.0, 5346.0, 5688.0, 5694.0, 5434.0, 5458.0, 5593.0, 5491.0, 5684.0, 5416.0, 5514.0, 5632.0, 5412.0, 5497.0, 5382.0, 5569.0, 5385.0, 5708.0, 5265.0, 5415.0, 5251.0, 5536.0, 5588.0, 5467.0, 5656.0, 5359.0, 5690.0, 5584.0, 5720.0, 5362.0
29	5270	9	1	333	1	5576.0, 5662.0, 5644.0, 5439.0, 5416.0, 5336.0, 5543.0, 5409.0, 5658.0, 5276.0, 5463.0, 5707.0, 5677.0, 5274.0, 5591.0, 5256.0, 5525.0, 5657.0, 5601.0, 5511.0, 5497.0, 5340.0, 5586.0, 5480.0, 5441.0, 5636.0, 5686.0, 5266.0, 5714.0, 5282.0, 5660.0, 5615.0, 5546.0, 5499.0, 5572.0, 5702.0, 5634.0, 5721.0, 5582.0, 5337.0, 5592.0, 5279.0, 5560.0, 5555.0, 5628.0, 5469.0, 5718.0, 5501.0, 5362.0, 5376.0, 5452.0, 5562.0, 5354.0, 5440.0, 5664.0, 5267.0, 5494.0, 5503.0, 5268.0, 5532.0, 5255.0, 5623.0, 5704.0, 5257.0, 5510.0, 5545.0, 5505.0, 5604.0, 5663.0, 5327.0, 5485.0, 5332.0, 5475.0, 5599.0, 5508.0, 5611.0, 5265.0, 5278.0, 5349.0, 5456.0, 5682.0, 5451.0, 5360.0, 5581.0, 5614.0, 5692.0, 5387.0, 5454.0, 5413.0, 5561.0, 5607.0, 5656.0, 5313.0, 5428.0, 5344.0, 5398.0, 5415.0, 5695.0, 5694.0, 5462.0
30	5510	9	1	333	1	5520.0, 5478.0, 5351.0, 5262.0, 5531.0, 5453.0, 5251.0, 5652.0, 5298.0, 5568.0, 5288.0, 5682.0, 5261.0, 5506.0, 5447.0, 5605.0, 5624.0, 5657.0, 5285.0, 5557.0, 5468.0, 5650.0, 5302.0, 5641.0, 5580.0, 5545.0, 5581.0, 5523.0, 5501.0, 5457.0, 5477.0, 5703.0, 5720.0, 5394.0, 5505.0, 5369.0, 5693.0, 5430.0, 5441.0, 5429.0, 5502.0, 5625.0, 5376.0, 5338.0, 5305.0, 5266.0, 5655.0, 5255.0, 5319.0, 5698.0, 5281.0, 5613.0, 5609.0, 5503.0, 5673.0, 5714.0, 5543.0, 5274.0, 5678.0, 5317.0, 5705.0, 5324.0, 5589.0, 5493.0, 5314.0

						5318.0, 5431.0, 5696.0, 5354.0, 5469.0, 5470.0, 5511.0, 5272.0, 5550.0, 5476.0, 5567.0, 5651.0, 5564.0, 5480.0, 5347.0, 5515.0, 5260.0, 5361.0, 5604.0, 5304.0, 5332.0, 5487.0, 5676.0, 5411.0, 5488.0, 5390.0, 5616.0, 5529.0, 5549.0, 5438.0, 5704.0, 5336.0, 5386.0, 5582.0, 5326.0
--	--	--	--	--	--	--

80MHz

Radar SignalType	Waveform/Trial Number	Detection (%)	Limit (%)	Pass/Fail
Type 1A	15	100%	60%	pass
Type 1B	15	100%	60%	pass
Type 2	30	100 %	60%	Pass
Type 3	30	100 %	60%	Pass
Type 4	30	100 %	60%	Pass
Aggregate(Type1 to 4)	120	100 %	80%	Pass
Type 5	30	100 %	80%	Pass
Type 6	30	100 %	70%	Pass

Please refer to the following statistical tables:

5290MHz**Radar Type 1A Statistical Performance**

Trial #	Fc (MHz)	Pulse/Burst	Pulse Width (μS)	PRI (μs)	Detection (1:yes; 0:no)
1	5290	18	1	3066	1
2	5290	72	1	738	1
3	5290	59	1	898	1
4	5290	95	1	558	1
5	5290	65	1	818	1
6	5290	61	1	878	1
7	5290	99	1	538	1
8	5290	83	1	638	1
9	5290	63	1	838	1
10	5290	58	1	918	1
11	5290	102	1	518	1
12	5290	89	1	598	1
13	5290	86	1	618	1
14	5290	74	1	718	1
15	5290	68	1	778	1
Detection Percentage: 100 % (>60%)					

Radar Type 1B Statistical Performance

Trial #	Fc (MHz)	Pulse/Burst	Pulse Width (μS)	PRI (μs)	Detection (1:yes; 0:no)
1	5290	35	1	1540	1
2	5290	21	1	2606	1
3	5290	65	1	813	1
4	5290	19	1	2822	1
5	5290	32	1	1671	1
6	5290	33	1	1647	1
7	5290	19	1	2782	1
8	5290	34	1	1560	1
9	5290	42	1	1284	1
10	5290	24	1	2247	1
11	5290	59	1	896	1
12	5290	38	1	1390	1
13	5290	38	1	1398	1
14	5290	64	1	827	1
15	5290	30	1	1764	1
Detection Percentage: 100 % (>60%)					

Radar Type 2 Statistical Performance

Trial #	Fc (MHz)	Pulse/Burst	Pulse Width (μS)	PRI (μs)	Detection (1:yes; 0:no)
1	5290	25	2.7	166	1
2	5290	28	4.2	169	1
3	5290	27	2.1	193	1
4	5290	29	3	196	1
5	5290	24	2.9	190	1
6	5290	26	4.3	219	1
7	5290	29	4.8	171	1
8	5290	28	1.2	175	1
9	5290	26	4.4	183	1
10	5290	28	1.9	164	1
11	5290	27	1.4	185	1
12	5290	29	4.5	154	1
13	5290	28	5	158	1
14	5290	27	3.5	215	1
15	5290	26	3.6	204	1
16	5290	28	1.2	177	1
17	5290	27	2.4	175	1
18	5290	29	4.1	203	1
19	5290	25	4.1	204	1
20	5290	23	3.6	174	1
21	5290	24	4.6	164	1
22	5290	24	1.9	203	1
23	5290	26	2.1	200	1
24	5290	25	3.9	193	1
25	5290	26	4.4	205	1
26	5290	29	3.8	186	1
27	5290	28	2.4	171	1
28	5290	28	1.4	204	1
29	5290	29	4.7	227	1
30	5290	23	3.8	183	1
Detection Percentage: 100 % (>60%)					

Radar Type 3 Statistical Performance

Trial #	Fc (MHz)	Pulse/Burst	Pulse Width (μS)	PRI (μs)	Detection (1:yes; 0:no)
1	5290	18	9.9	428	1
2	5290	16	8.4	292	1
3	5290	16	6.4	443	1
4	5290	16	8.6	486	1
5	5290	16	6.6	444	1
6	5290	16	6.8	466	1
7	5290	17	9.1	214	1
8	5290	17	6.1	294	1
9	5290	18	8.6	464	1
10	5290	16	6.1	350	1
11	5290	17	7.9	344	1
12	5290	17	9.5	499	1
13	5290	17	9.7	271	1
14	5290	18	7.4	444	1
15	5290	17	7.1	271	1
16	5290	16	6.5	409	1
17	5290	16	8.1	437	1
18	5290	18	6.1	357	1
19	5290	18	7.7	489	1
20	5290	16	7.4	478	1
21	5290	16	9.7	488	1
22	5290	16	8.7	220	1
23	5290	18	9.2	307	1
24	5290	16	9.8	408	1
25	5290	18	9.6	202	1
26	5290	17	9.2	364	1
27	5290	18	9.1	426	1
28	5290	16	9.6	455	1
29	5290	16	9.5	287	1
30	5290	16	10	314	1
Detection Percentage: 100 % (>60%)					

Radar Type 4 Statistical Performance

Trial #	Fc (MHz)	Pulse/Burst	Pulse Width (μS)	PRI (μs)	Detection (1:yes; 0:no)
1	5290	13	14.9	202	1
2	5290	13	16.3	315	1
3	5290	13	17.7	225	1
4	5290	13	19.3	264	1
5	5290	15	17.3	445	1
6	5290	13	11.1	274	1
7	5290	14	12.8	428	1
8	5290	13	13.7	289	1
9	5290	15	12.5	387	1
10	5290	12	11	428	1
11	5290	16	14.5	350	1
12	5290	12	19.3	287	1
13	5290	13	17.9	255	1
14	5290	15	13.9	355	1
15	5290	12	12.9	418	1
16	5290	14	15.7	487	1
17	5290	15	19.6	410	1
18	5290	12	15.3	329	1
19	5290	14	18.6	230	1
20	5290	14	12.1	476	1
21	5290	14	14.9	262	1
22	5290	12	11.7	436	1
23	5290	15	16	382	1
24	5290	12	16.7	216	1
25	5290	13	16	240	1
26	5290	12	13.7	452	1
27	5290	16	19.5	445	1
28	5290	12	17.7	331	1
29	5290	13	19.9	492	1
30	5290	14	19.4	217	1
Detection Percentage: 100 % (>60%)					

Radar Type 5 Case 1 Statistical Performance

Statistics 1 (ChirpCenter Frequency: 5290.0MHz)

Trial #	Pulse	Chirp(MHz)	Pulse Width (µS)	Pulse 1-2 spacing(µS)	Pulse 2-3 spacing(µS)	Pulse Start(S)	Detection (1:yes;0:no)
0	1	6	52.6			0.982827	1
1	2	6	50.4	1676		1.737596	
2	2	6	75.1	1709		2.975505	
3	2	6	98.1	1578		3.089489	
4	1	6	52.6			4.177118	
5	1	6	75.8			5.542659	
6	2	6	87.5	1399		6.84257	
7	3	6	93.7	1716	1792	7.674794	
8	1	6	89.5			8.522158	
9	3	6	60	1714	1216	9.160051	
10	3	6	66.3	1303	1098	10.22321	
11	3	6	59.8	1383	1948	11.58196	

Statistics 2 (ChirpCenter Frequency: 5290.0 MHz)

Trial #	Pulse	Chirp(MHz)	Pulse Width (µS)	Pulse 1-2 spacing(µS)	Pulse 2-3 spacing(µS)	Pulse Start(S)	Detection (1:yes;0:no)
0	3	13	62	1184	1250	0.689718	1
1	3	13	66.3	1427	1685	1.639969	
2	2	13	75	1057		2.593214	
3	2	13	57.6	1918		3.457015	
4	2	13	99.8	1783		4.511062	
5	2	13	61.7	1365		5.418686	
6	2	13	54.6	1282		5.666215	
7	2	13	85.8	1697		6.837044	
8	1	13	82.1			7.830999	
9	1	13	87.7			8.623193	
10	2	13	66.6	1089		10.0713	
11	1	13	58.5			10.20938	
12	3	13	55.8	1297	1189	11.49178	

Statistics 3 (ChirpCenter Frequency: 5290.0 MHz)

Trial #	Pulse	Chirp(MHz)	Pulse Width (μS)	Pulse 1-2 spacing(μS)	Pulse 2-3 spacing(μS)	Pulse Start(S)	Detection (1:yes;0:no)
0	2	9	50.4	1858		0.146018	1
1	3	9	83.5	1454	1930	0.780122	
2	2	9	59.5	1285		1.617123	
3	1	9	61.9			2.591737	
4	2	9	68.9	1623		2.96862	
5	2	9	52.3	1033		3.378496	
6	1	9	99.9			4.285487	
7	1	9	85.5			4.84463	
8	2	9	67.8	1970		5.95499	
9	2	9	55.9	1643		6.633238	
10	3	9	91.7	1968	1456	7.087676	
11	3	9	92.6	1326	1048	7.346057	
12	2	9	83.9	1116		8.005896	
13	3	9	84.2	1328	1980	8.930182	
14	3	9	58.3	1894	1432	9.82575	
15	3	9	84.3	1745	1278	10.59908	
16	1	9	70.9			10.95838	
17	2	9	61.3	1866		11.77218	

Statistics 4 (ChirpCenter Frequency: 5290.0 MHz)

Trial #	Pulse	Chirp(MHz)	Pulse Width (μS)	Pulse 1-2 spacing(μS)	Pulse 2-3 spacing(μS)	Pulse Start(S)	Detection (1:yes;0:no)
0	1	16	70.5			0.084923	1
1	1	16	87			0.717629	
2	2	16	82.2	1680		1.57247	
3	2	16	59.9	1229		2.393716	
4	2	16	83.8	1665		2.969616	
5	2	16	93.4	1330		3.364958	
6	2	16	53.3	1111		4.08072	
7	3	16	64.5	1754	1705	5.223458	
8	3	16	63.5	1365	1050	5.351359	
9	3	16	76.3	1742	1629	6.041536	
10	2	16	57.8	1482		7.185037	
11	3	16	92.1	1581	1790	7.40268	
12	1	16	63.6			8.109804	
13	3	16	54.5	1763	1578	8.906009	
14	2	16	81.1	1380		9.723547	
15	1	16	65.1			10.00634	
16	2	16	92.4	1802		10.83525	
17	3	16	71.3	1472	1135	11.70485	

Statistics 5(ChirpCenter Frequency: 5290.0 MHz)

Trial #	Pulse	Chirp(MHz)	Pulse Width (μS)	Pulse 1-2 spacing(μS)	Pulse 2-3 spacing(μS)	Pulse Start(S)	Detection (1:yes;0:no)
0	2	9	85.1	1511		0.635447	1
1	3	9	54.5	1296	1034	1.815078	
2	2	9	73.6	1967		2.754174	
3	2	9	60.5	1391		3.985582	
4	3	9	72.5	1531	1456	4.329248	
5	2	9	60.1	1985		5.353452	
6	2	9	85.4	1091		6.634032	
7	2	9	75	1129		7.986652	
8	3	9	97.2	1277	1162	8.465116	
9	1	9	87			9.636917	
10	3	9	65.1	1117	1899	10.18607	
11	1	9	71.4			11.15883	

Statistics 6 (ChirpCenter Frequency: 5290.0 MHz)

Trial #	Pulse	Chirp(MHz)	Pulse Width (μS)	Pulse 1-2 spacing(μS)	Pulse 2-3 spacing(μS)	Pulse Start(S)	Detection (1:yes;0:no)
0	2	13	97.6	1336		0.508539	1
1	3	13	77	1048	1502	0.955945	
2	3	13	94.7	1280	1119	1.837187	
3	2	13	67.8	1511		2.711167	
4	2	13	63.2	1736		3.193798	
5	2	13	52.8	1291		4.105233	
6	2	13	85.4	1750		4.423792	
7	3	13	94.3	1453	1699	5.043212	
8	2	13	58.9	1146		6.160071	
9	2	13	58.4	1909		6.396602	
10	2	13	92.3	1431		7.288401	
11	2	13	77.9	1301		8.366216	
12	1	13	92.9			8.645349	
13	2	13	76.2	1153		9.558389	
14	2	13	78.9	1666		10.20691	
15	1	13	70.2			11.1142	
16	2	13	59.9	1390		11.98006	

Statistics 7(ChirpCenter Frequency: 5290.0 MHz)

Trial #	Pulse	Chirp(MHz)	Pulse Width (μS)	Pulse 1-2 spacing(μS)	Pulse 2-3 spacing(μS)	Pulse Start(S)	Detection (1:yes;0:no)
0	2	14	89.7	1357		0.146003	1
1	1	14	79.9			1.32872	
2	1	14	69.1			1.959164	
3	2	14	84.6	1882		2.439215	
4	2	14	57.2	1885		3.134497	
5	1	14	90.8			3.95914	
6	2	14	74.8	1508		4.448208	
7	2	14	99.8	1408		5.622221	
8	2	14	59.9	1423		5.967266	
9	2	14	62.1	1619		7.049865	
10	2	14	78.9	1852		7.154027	
11	3	14	76.3	1897	1787	8.45095	
12	3	14	78.8	1780	1736	9.115197	
13	2	14	64.3	1092		9.421488	
14	3	14	89.4	1597	1457	10.25219	
15	1	14	88.8			10.69995	
16	1	14	81.4			11.52004	

Statistics 8 (ChirpCenter Frequency: 5290.0 MHz)

Trial #	Pulse	Chirp(MHz)	Pulse Width (μS)	Pulse 1-2 spacing(μS)	Pulse 2-3 spacing(μS)	Pulse Start(S)	Detection (1:yes;0:no)
0	2	15	52.1	1251		0.189227	1
1	3	15	72.9	1033	1490	1.176423	
2	3	15	65.2	1260	1411	1.79001	
3	3	15	61.4	1026	1335	2.737385	
4	3	15	90.5	1612	1617	3.928663	
5	2	15	73.8	1037		4.710073	
6	2	15	64.3	1886		4.810466	
7	3	15	53.5	1556	1593	6.024594	
8	2	15	94.1	1281		6.790194	
9	1	15	96.1			7.827552	
10	2	15	73	1366		8.538212	
11	3	15	85	1415	1329	8.844562	
12	1	15	93.3			10.36033	
13	2	15	94.6	1952		10.62241	
14	1	15	72.8			11.43843	

Statistics 9 (ChirpCenter Frequency: 5290.0 MHz)

Trial #	Pulse	Chirp(MHz)	Pulse Width (μS)	Pulse 1-2 spacing(μS)	Pulse 2-3 spacing(μS)	Pulse Start(S)	Detection (1:yes;0:no)
0	1	5	65.9			0.104479	1
1	1	5	86.2			1.518941	
2	1	5	50.5			2.017628	
3	2	5	93.3	1378		2.531187	
4	2	5	64.5	1643		3.30611	
5	3	5	100	1822	1838	4.428218	
6	1	5	89.3			5.587643	
7	2	5	86.1	1990		6.370542	
8	1	5	87.1			7.101432	
9	2	5	83	1440		7.439503	
10	1	5	54.3			8.514301	
11	2	5	77.4	1720		9.049331	
12	3	5	92.4	1910	1377	9.771992	
13	3	5	75.3	1726	1971	10.83096	
14	1	5	82.8			11.73623	

Statistics 10 (ChirpCenter Frequency: 5290.0 MHz)

Trial #	Pulse	Chirp(MHz)	Pulse Width (μS)	Pulse 1-2 spacing(μS)	Pulse 2-3 spacing(μS)	Pulse Start(S)	Detection (1:yes;0:no)
0	2	14	81.3	1403		0.482914	1
1	2	14	53.9	1062		0.681361	
2	1	14	93.7			1.639835	
3	1	14	68			2.186299	
4	3	14	68.6	1494	1023	2.926008	
5	2	14	86	1605		3.249588	
6	1	14	73.8			4.238524	
7	3	14	84.3	1754	1465	4.597393	
8	1	14	59.1			5.076968	
9	3	14	79.4	1289	1118	5.802148	
10	2	14	94.7	1946		6.489175	
11	2	14	60.4	1653		7.552829	
12	2	14	90.9	1904		7.903591	
13	3	14	98.2	1394	1565	8.534557	
14	2	14	73.9	1851		8.902781	
15	3	14	62.2	1478	1349	9.722108	
16	2	14	97.4	1146		10.25043	
17	2	14	53.6	1004		10.87996	
18	2	14	76.1	1854		11.61685	

Radar Type 5 Case 2 Statistical Performance

Statistics 1 (ChirpCenter Frequency: 5254.0MHz)

Trial #	Pulse	Chirp(MHz)	Pulse Width (µS)	Pulse 1-2 spacing(µS)	Pulse 2-3 spacing(µS)	Pulse Start(S)	Detection (1:yes;0:no)
0	1	11	90.9			0.233653	1
1	2	11	79.6	1769		0.966909	
2	1	11	55.6			2.146983	
3	1	11	93.8			2.987186	
4	2	11	59.8	1995		3.427898	
5	2	11	78.5	1163		3.865925	
6	3	11	50.9	1262	1081	4.531208	
7	1	11	73.2			5.941084	
8	1	11	74.8			6.701759	
9	1	11	90.3			7.240969	
10	3	11	59.7	1780	1496	7.856494	
11	2	11	54	1847		8.494046	
12	3	11	64	1815	1415	9.582666	
13	2	11	88.4	1373		10.18251	
14	3	11	54.5	1786	1093	11.13632	
15	3	11	70.4	1188	1652	11.4651	

Statistics 2 (ChirpCenter Frequency: 5254.0 MHz)

Trial #	Pulse	Chirp(MHz)	Pulse Width (µS)	Pulse 1-2 spacing(µS)	Pulse 2-3 spacing(µS)	Pulse Start(S)	Detection (1:yes;0:no)
0	3	10	74.3	1972	1945	0.224473	1
1	2	10	84.6	1798		1.447254	
2	3	10	55.4	1673	1516	2.476804	
3	2	10	98.5	1771		3.039363	
4	3	10	58.6	1087	1789	3.543452	
5	2	10	96.7	1059		4.64511	
6	2	10	91.3	1747		5.734446	
7	2	10	56.9	1814		6.740748	
8	2	10	54.7	1405		7.148495	
9	2	10	95.8	1766		8.222809	
10	1	10	63.6			8.883024	
11	3	10	99.1	1986	1919	10.06788	
12	2	10	84.5	1797		10.49896	
13	3	10	54.7	1468	1957	11.84036	

Statistics 3 (ChirpCenter Frequency: 5254.0 MHz)

Trial #	Pulse	Chirp(MHz)	Pulse Width (μS)	Pulse 1-2 spacing(μS)	Pulse 2-3 spacing(μS)	Pulse Start(S)	Detection (1:yes;0:no)
0	1	9	57.1			0.454685	1
1	1	9	54			1.079615	
2	2	9	80.8	1778		2.051018	
3	2	9	79.6	1771		2.308653	
4	2	9	67.6	1165		3.256639	
5	2	9	82.2	1524		4.116303	
6	2	9	78.5	1162		4.412684	
7	1	9	86			5.329098	
8	1	9	99.4			6.133419	
9	1	9	98.5			6.927372	
10	2	9	85.5	1828		7.230967	
11	2	9	90.7	1308		8.350661	
12	1	9	92.8			8.503089	
13	2	9	54.3	1824		9.464552	
14	2	9	52.3	1489		10.5572	
15	2	9	51.4	1926		11.27705	
16	1	9	62.3			11.56336	

Statistics 4 (ChirpCenter Frequency: 5258.0 MHz)

Trial #	Pulse	Chirp(MHz)	Pulse Width (μS)	Pulse 1-2 spacing(μS)	Pulse 2-3 spacing(μS)	Pulse Start(S)	Detection (1:yes;0:no)
0	2	19	56.3	1818		0.450094	1
1	1	19	51.9			1.072819	
2	2	19	65.8	1215		1.507664	
3	3	19	85.2	1630	1136	2.138334	
4	2	19	77.5	1695		3.116641	
5	1	19	88.7			3.51864	
6	2	19	85.7	1051		4.102914	
7	3	19	65.7	1798	1830	4.803766	
8	2	19	68.4	1127		5.730206	
9	2	19	93.9	1811		6.046604	
10	1	19	52.2			6.757646	
11	2	19	79.5	1276		7.900596	
12	2	19	51	1035		8.348359	
13	2	19	86.8	1370		8.753133	
14	1	19	71.9			9.335901	
15	1	19	62.9			10.32075	
16	3	19	72.6	1265	1867	10.96793	
17	2	19	80.4	1480		11.38772	

Statistics 5(ChirpCenter Frequency: 5256.0 MHz)

Trial #	Pulse	Chirp(MHz)	Pulse Width (μS)	Pulse 1-2 spacing(μS)	Pulse 2-3 spacing(μS)	Pulse Start(S)	Detection (1:yes;0:no)
0	1	14	65.9			0.250612	1
1	1	14	99.5			1.329014	
2	2	14	79.9	1222		2.534677	
3	1	14	92.3			2.887053	
4	2	14	71.9	1807		3.78683	
5	2	14	58.8	1713		5.323018	
6	1	14	93.9			5.752094	
7	1	14	78			6.712274	
8	1	14	53			7.690256	
9	2	14	65.8	1805		9.191881	
10	2	14	72.2	1690		9.889086	
11	3	14	96.1	1226	1675	10.83875	
12	3	14	91.4	1909	1728	11.94779	

Statistics 6 (ChirpCenter Frequency: 5256.0 MHz)

Trial #	Pulse	Chirp(MHz)	Pulse Width (μS)	Pulse 1-2 spacing(μS)	Pulse 2-3 spacing(μS)	Pulse Start(S)	Detection (1:yes;0:no)
0	3	15	91.3	1134	1957	0.034425	1
1	3	15	72.5	1994	1784	0.868455	
2	2	15	89.1	1484		1.914687	
3	3	15	54.2	1658	1034	2.055223	
4	3	15	96.6	1472	1078	3.134362	
5	1	15	89.5			3.425114	
6	3	15	54.6	1769	1995	4.159183	
7	2	15	75.7	1503		4.854059	
8	2	15	75.6	1670		5.772787	
9	1	15	96.6			6.455143	
10	2	15	68.2	1412		7.199765	
11	2	15	97.4	1377		7.576709	
12	2	15	74.4	1155		8.066437	
13	3	15	55.3	1047	1264	9.205934	
14	2	15	62.9	1909		9.892588	
15	2	15	56	1024		10.05763	
16	2	15	69.2	1962		11.14397	
17	2	15	90.2	1333		11.72585	

Statistics 7(ChirpCenter Frequency: 5256.0 MHz)

Trial #	Pulse	Chirp(MHz)	Pulse Width (μS)	Pulse 1-2 spacing(μS)	Pulse 2-3 spacing(μS)	Pulse Start(S)	Detection (1:yes;0:no)
0	1	16	67			0.221269	1
1	2	16	83.5	1543		1.379882	
2	2	16	62.4	1213		3.093894	
3	2	16	87.9	1597		4.566415	
4	1	16	64			4.86694	
5	2	16	69	1538		6.944273	
6	2	16	60.3	1967		7.913499	
7	3	16	59.1	1590	1274	8.665369	
8	2	16	94.7	1758		10.5327	
9	3	16	84.7	1596	1203	11.49885	

Statistics 8 (ChirpCenter Frequency: 5257.0 MHz)

Trial #	Pulse	Chirp(MHz)	Pulse Width (μS)	Pulse 1-2 spacing(μS)	Pulse 2-3 spacing(μS)	Pulse Start(S)	Detection (1:yes;0:no)
0	2	17	95.4	1409		0.399692	1
1	3	17	88.5	1180	1659	0.997041	
2	3	17	65.5	1046	1678	1.839723	
3	3	17	83.5	1279	1470	2.425084	
4	2	17	82.1	1604		3.022746	
5	1	17	56			3.2833	
6	1	17	60.6			4.167376	
7	2	17	82.6	1493		4.93811	
8	2	17	59	1503		5.291959	
9	3	17	53.3	1031	1430	5.720974	
10	3	17	97.5	1524	1574	6.60661	
11	2	17	56.1	1962		7.258965	
12	2	17	54.2	1586		8.100697	
13	1	17	60.8			8.492324	
14	2	17	90.5	1990		9.150432	
15	2	17	55.6	1610		9.967898	
16	1	17	67.7			10.17716	
17	3	17	53.1	1152	1727	10.77799	
18	1	17	80.5			11.80711	

Statistics 9 (ChirpCenter Frequency: 5254.0 MHz)

Trial #	Pulse	Chirp(MHz)	Pulse Width (μS)	Pulse 1-2 spacing(μS)	Pulse 2-3 spacing(μS)	Pulse Start(S)	Detection (1:yes;0:no)
0	1	9	83			0.18855	1
1	3	9	74.8	1331	1894	1.178102	
2	3	9	80.6	1556	1992	2.037131	
3	1	9	68.4			2.143412	
4	1	9	71.6			3.400442	
5	1	9	50.6			3.79573	
6	2	9	59.7	1328		4.81914	
7	1	9	70.1			5.037932	
8	1	9	65.2			5.918646	
9	1	9	85.4			6.67015	
10	2	9	73.1	1874		7.462397	
11	2	9	75.4	1659		8.165447	
12	2	9	82	1406		8.855135	
13	2	9	99	1312		9.588357	
14	1	9	59.6			10.23904	
15	2	9	94.7	1387		11.18787	
16	1	9	64.2			11.36211	

Statistics 10 (ChirpCenter Frequency: 5254.0 MHz)

Trial #	Pulse	Chirp(MHz)	Pulse Width (μS)	Pulse 1-2 spacing(μS)	Pulse 2-3 spacing(μS)	Pulse Start(S)	Detection (1:yes;0:no)
0	3	11	62.7	1850	1562	1.463186	1
1	2	11	84.1	1801		2.181844	
2	2	11	94	1335		3.392549	
3	1	11	91.9			5.143977	
4	1	11	72.5			6.59773	
5	1	11	59.5			8.447294	
6	3	11	77.1	1769	1287	9.423225	
7	3	11	52.8	1241	1957	11.5061	

Radar Type 5 Case 3 Statistical Performance

Statistics 1 (ChirpCenter Frequency: 5323.0MHz)

Trial #	Pulse	Chirp(MHz)	Pulse Width (μS)	Pulse 1-2 spacing(μS)	Pulse 2-3 spacing(μS)	Pulse Start(S)	Detection (1:yes;0:no)
0	2	18	97.9	1851		0.166125	1
1	2	18	89.7	1158		0.60154	
2	1	18	73			1.679113	
3	1	18	94.5			2.017123	
4	2	18	82.8	1697		2.536272	
5	2	18	57.9	1459		3.17139	
6	3	18	91.2	1415	1552	3.849521	
7	2	18	90.8	1253		4.253554	
8	1	18	81.9			4.825044	
9	2	18	76.9	1013		5.858902	
10	1	18	79			6.159715	
11	3	18	78.2	1005	1124	6.741158	
12	3	18	78.3	1825	1742	7.579708	
13	3	18	82.7	1282	1745	7.822198	
14	1	18	86.1			8.728129	
15	2	18	81.8	1673		9.13712	
16	2	18	50.2	1576		10.14576	
17	1	18	62.1			10.32897	
18	1	18	60.2			10.87486	
19	3	18	74.8	1309	1865	11.5288	

Statistics 2 (ChirpCenter Frequency: 5322.0 MHz)

Trial #	Pulse	Chirp(MHz)	Pulse Width (μS)	Pulse 1-2 spacing(μS)	Pulse 2-3 spacing(μS)	Pulse Start(S)	Detection (1:yes;0:no)
0	3	19	58.6	1547	1648	0.461422	1
1	2	19	53.6	1502		1.144101	
2	2	19	97.5	1171		1.7147	
3	2	19	64.9	1551		2.703886	
4	3	19	88.6	1097	1432	3.072102	
5	2	19	63.8	1153		4.28811	
6	1	19	89.5			5.134128	
7	2	19	84.6	1069		5.924314	
8	2	19	55.5	1473		6.013739	
9	3	19	56.4	1710	1387	6.860005	
10	3	19	99.4	1360	1391	7.898018	
11	2	19	79.9	1149		8.636359	
12	1	19	66.2			9.599328	
13	2	19	80.2	1158		9.932314	
14	3	19	87.1	1357	1456	10.97279	
15	2	19	68	1780		11.44252	

Statistics 3 (ChirpCenter Frequency: 5326.0 MHz)

Trial #	Pulse	Chirp(MHz)	Pulse Width (µS)	Pulse 1-2 spacing(µS)	Pulse 2-3 spacing(µS)	Pulse Start(S)	Detection (1:yes;0:no)
0	2	11	98.5	1148		0.535023	1
1	2	11	82.1	1046		1.225127	
2	2	11	93.6	1233		1.840947	
3	2	11	93.6	1796		2.067836	
4	2	11	83.3	1848		3.072351	
5	2	11	54.1	1460		3.541688	
6	3	11	80.2	1514	1134	4.574721	
7	1	11	98.4			4.851147	
8	3	11	82.1	1841	1095	5.583593	
9	1	11	55			6.604707	
10	1	11	62.2			7.054785	
11	3	11	98.3	1597	1143	7.739454	
12	2	11	74	1978		8.625641	
13	3	11	61.4	1520	1802	9.034497	
14	2	11	59.3	1536		9.886204	
15	1	11	84.4			10.53136	
16	2	11	71.4	1875		10.96039	
17	2	11	55.7	1894		11.98297	

Statistics 4 (ChirpCenter Frequency: 5323.0 MHz)

Trial #	Pulse	Chirp(MHz)	Pulse Width (µS)	Pulse 1-2 spacing(µS)	Pulse 2-3 spacing(µS)	Pulse Start(S)	Detection (1:yes;0:no)
0	3	17	77	1713	1878	0.626899	1
1	3	17	74.8	1576	1249	1.492051	
2	1	17	86.6			2.603711	
3	2	17	55.9	1292		3.626807	
4	2	17	67	1501		5.85173	
5	1	17	85.7			6.660129	
6	1	17	60.1			7.447492	
7	2	17	84.5	1399		8.475335	
8	2	17	56.2	1203		10.67093	
9	1	17	79.6			10.90709	

Statistics 5(ChirpCenter Frequency: 5322.0 MHz)

Trial #	Pulse	Chirp(MHz)	Pulse Width (μS)	Pulse 1-2 spacing(μS)	Pulse 2-3 spacing(μS)	Pulse Start(S)	Detection (1:yes;0:no)
0	3	19	80.9	1314	1477	0.83634	1
1	3	19	75.6	1305	1357	1.630373	
2	2	19	69	1763		2.123424	
3	3	19	81.5	1363	1063	3.802744	
4	3	19	84.2	1891	1202	4.640417	
5	2	19	83.9	1464		5.542159	
6	3	19	79.8	1906	1095	6.595023	
7	2	19	96.9	1740		7.591747	
8	2	19	53.9	1711		8.625042	
9	2	19	63.2	1738		9.569408	
10	2	19	71.5	1760		10.32584	
11	2	19	51.3	1409		11.39235	

Statistics 6 (ChirpCenter Frequency: 5322.0 MHz)

Trial #	Pulse	Chirp(MHz)	Pulse Width (μS)	Pulse 1-2 spacing(μS)	Pulse 2-3 spacing(μS)	Pulse Start(S)	Detection (1:yes;0:no)
0	2	19	91.9	1637		0.287457	1
1	3	19	86.6	1545	1452	1.642529	
2	1	19	95.5			2.610079	
3	2	19	91	1277		3.269288	
4	2	19	74.6	1477		4.544357	
5	2	19	74.3	1327		5.547351	
6	3	19	69.7	1481	1752	6.159212	
7	1	19	61.9			7.07583	
8	2	19	83.7	1814		8.118425	
9	2	19	71.6	1605		9.320634	
10	3	19	74.3	1510	1057	10.80361	
11	2	19	68.2	1344		11.39446	

Statistics 7(ChirpCenter Frequency: 5328.0 MHz)

Trial #	Pulse	Chirp(MHz)	Pulse Width (μS)	Pulse 1-2 spacing(μS)	Pulse 2-3 spacing(μS)	Pulse Start(S)	Detection (1:yes;0:no)
0	3	6	81.9	1644	1490	0.076966	1
1	2	6	97.5	1702		0.653316	
2	3	6	83.2	1229	1460	1.501923	
3	1	6	85.1			2.246668	
4	2	6	58.2	1459		2.598788	
5	3	6	50.1	1226	1454	3.298249	
6	1	6	75.7			3.968739	
7	3	6	56	1386	1634	4.758706	
8	2	6	80.8	1590		5.366774	
9	2	6	92.5	1504		5.932794	
10	1	6	88.1			6.451642	
11	3	6	96.2	1797	1438	7.420726	
12	1	6	72.6			7.733745	
13	2	6	80.2	1405		8.239227	
14	2	6	86	1523		9.083533	
15	2	6	58.5	1360		9.851692	
16	3	6	71.1	1549	1506	10.10846	
17	3	6	58.5	1823	1146	10.9379	
18	2	6	91.9	1639		11.67595	

Statistics 8 (ChirpCenter Frequency: 5325.0 MHz)

Trial #	Pulse	Chirp(MHz)	Pulse Width (μS)	Pulse 1-2 spacing(μS)	Pulse 2-3 spacing(μS)	Pulse Start(S)	Detection (1:yes;0:no)
0	3	13	72.3	1810	1746	0.5471	1
1	2	13	87.9	1147		0.996804	
2	1	13	76.9			1.293064	
3	2	13	89.8	1402		2.31845	
4	2	13	99.2	1732		3.025058	
5	2	13	79.8	1804		3.334084	
6	2	13	50.6	1230		3.841477	
7	3	13	80.9	1779	1973	4.618778	
8	3	13	98	1344	1727	5.421566	
9	2	13	62.3	1980		6.308067	
10	2	13	96.7	1510		6.425232	
11	3	13	58.5	1747	1020	7.034956	
12	2	13	55.8	1337		7.881653	
13	2	13	56.4	1659		8.593946	
14	2	13	93.9	1385		9.078872	
15	1	13	82.6			9.791109	
16	3	13	82.2	1066	1149	10.63369	
17	3	13	69.9	1315	1558	10.85175	
18	1	13	76.1			11.61833	

Statistics 9 (ChirpCenter Frequency: 5324.0 MHz)

Trial #	Pulse	Chirp(MHz)	Pulse Width (µS)	Pulse 1-2 spacing(µS)	Pulse 2-3 spacing(µS)	Pulse Start(S)	Detection (1:yes;0:no)
0	1	16	66.2			0.540867	1
1	1	16	70.3			0.689661	
2	2	16	89.4	1300		1.648787	
3	2	16	57	1651		2.089301	
4	2	16	63.6	1086		2.67241	
5	2	16	65.1	1157		3.509903	
6	2	16	51.4	1251		4.660423	
7	2	16	59.7	1707		4.971914	
8	2	16	90.3	1851		5.588112	
9	3	16	73.9	1927	1120	6.323275	
10	1	16	71.7			6.769117	
11	2	16	59.1	1941		7.818579	
12	2	16	79.1	1076		8.630446	
13	2	16	88.1	1849		9.007401	
14	1	16	79.3			9.474075	
15	3	16	60.8	1951	1161	10.17556	
16	3	16	95.1	1404	1535	11.27849	
17	2	16	95.3	1667		11.57095	

Statistics 10 (ChirpCenter Frequency: 5326.0 MHz)

Trial #	Pulse	Chirp(MHz)	Pulse Width (µS)	Pulse 1-2 spacing(µS)	Pulse 2-3 spacing(µS)	Pulse Start(S)	Detection (1:yes;0:no)
0	1	16	66.2			0.540867	1
1	1	16	70.3			0.689661	
2	2	16	89.4	1300		1.648787	
3	2	16	57	1651		2.089301	
4	2	16	63.6	1086		2.67241	
5	2	16	65.1	1157		3.509903	
6	2	16	51.4	1251		4.660423	
7	2	16	59.7	1707		4.971914	
8	2	16	90.3	1851		5.588112	
9	3	16	73.9	1927	1120	6.323275	
10	1	16	71.7			6.769117	
11	2	16	59.1	1941		7.818579	
12	2	16	79.1	1076		8.630446	
13	2	16	88.1	1849		9.007401	
14	1	16	79.3			9.474075	
15	3	16	60.8	1951	1161	10.17556	
16	3	16	95.1	1404	1535	11.27849	
17	2	16	95.3	1667		11.57095	

Radar Type 6 Statistical Performance

Trial #	Fc (MHz)	Pulse /Burst	Pulse Width (µS)	PRI (µs)	Detection (1:yes; 0:no)	Hopping Sequence (MHz)
1	5290	9	1	333	1	5511.0, 5562.0, 5378.0, 5503.0, 5720.0, 5713.0, 5693.0, 5718.0, 5265.0, 5564.0, 5534.0, 5264.0, 5421.0, 5501.0, 5592.0, 5618.0, 5268.0, 5682.0, 5701.0, 5261.0, 5354.0, 5428.0, 5255.0, 5629.0, 5282.0, 5526.0, 5559.0, 5677.0, 5536.0, 5318.0, 5669.0, 5460.0, 5276.0, 5397.0, 5420.0, 5288.0, 5301.0, 5482.0, 5552.0, 5254.0, 5609.0, 5723.0, 5283.0, 5516.0, 5312.0, 5612.0, 5625.0, 5260.0, 5587.0, 5662.0, 5498.0, 5631.0, 5319.0, 5548.0, 5413.0, 5327.0, 5293.0, 5398.0, 5340.0, 5350.0, 5602.0, 5358.0, 5393.0, 5621.0, 5561.0, 5395.0, 5518.0, 5636.0, 5375.0, 5513.0, 5299.0, 5348.0, 5504.0, 5458.0, 5519.0, 5576.0, 5465.0, 5583.0, 5637.0, 5597.0, 5308.0, 5298.0, 5642.0, 5538.0, 5665.0, 5715.0, 5330.0, 5430.0, 5615.0, 5653.0, 5529.0, 5582.0, 5632.0, 5399.0, 5599.0, 5652.0, 5321.0, 5598.0, 5456.0, 5401.0
2	5290	9	1	333	1	5278.0, 5459.0, 5634.0, 5360.0, 5657.0, 5632.0, 5621.0, 5649.0, 5513.0, 5364.0, 5430.0, 5384.0, 5257.0, 5646.0, 5538.0, 5599.0, 5307.0, 5388.0, 5259.0, 5566.0, 5611.0, 5408.0, 5366.0, 5363.0, 5717.0, 5319.0, 5417.0, 5415.0, 5651.0, 5515.0, 5587.0, 5722.0, 5413.0, 5542.0, 5540.0, 5382.0, 5309.0, 5286.0, 5288.0, 5289.0, 5474.0, 5677.0, 5487.0, 5362.0, 5563.0, 5643.0, 5521.0, 5680.0, 5269.0, 5636.0, 5482.0, 5302.0, 5457.0, 5530.0, 5324.0, 5654.0, 5365.0, 5379.0, 5443.0, 5491.0, 5435.0, 5318.0, 5353.0, 5281.0, 5270.0, 5499.0, 5355.0, 5500.0, 5271.0, 5292.0, 5254.0, 5349.0, 5381.0, 5641.0, 5628.0, 5432.0, 5711.0, 5323.0, 5603.0, 5401.0, 5706.0, 5343.0, 5357.0, 5531.0, 5336.0, 5370.0, 5350.0, 5287.0, 5396.0, 5545.0, 5347.0, 5493.0, 5683.0, 5444.0, 5267.0, 5525.0, 5665.0, 5456.0, 5276.0, 5460.0
3	5290	9	1	333	1	5338.0, 5253.0, 5629.0, 5413.0, 5432.0, 5460.0, 5457.0, 5443.0, 5572.0, 5383.0, 5547.0, 5665.0, 5721.0, 5272.0, 5553.0, 5653.0, 5565.0, 5285.0, 5473.0, 5622.0, 5482.0, 5361.0, 5544.0, 5613.0, 5633.0, 5658.0, 5656.0, 5635.0, 5574.0, 5411.0, 5651.0, 5314.0, 5648.0, 5607.0, 5277.0, 5417.0, 5661.0, 5296.0, 5450.0, 5287.0, 5506.0, 5387.0, 5474.0, 5535.0, 5675.0, 5561.0, 5393.0, 5649.0, 5293.0, 5495.0, 5545.0, 5564.0, 5659.0, 5515.0, 5643.0, 5502.0, 5345.0, 5712.0, 5251.0, 5571.0, 5425.0, 5577.0, 5676.0, 5447.0, 5710.0

						5439.0, 5586.0, 5702.0, 5539.0, 5462.0, 5517.0, 5278.0, 5470.0, 5612.0, 5698.0, 5379.0, 5618.0, 5567.0, 5354.0, 5390.0, 5267.0, 5681.0, 5685.0, 5587.0, 5294.0, 5414.0, 5310.0, 5391.0, 5563.0, 5542.0, 5589.0, 5403.0, 5644.0, 5341.0, 5406.0, 5501.0, 5357.0, 5717.0, 5503.0, 5657.0
4	5290	9	1	333	1	5511.0, 5414.0, 5717.0, 5388.0, 5647.0, 5448.0, 5262.0, 5411.0, 5633.0, 5687.0, 5286.0, 5599.0, 5601.0, 5540.0, 5467.0, 5554.0, 5642.0, 5412.0, 5595.0, 5597.0, 5501.0, 5587.0, 5664.0, 5508.0, 5332.0, 5721.0, 5317.0, 5504.0, 5437.0, 5636.0, 5358.0, 5473.0, 5256.0, 5367.0, 5305.0, 5629.0, 5314.0, 5257.0, 5592.0, 5635.0, 5604.0, 5313.0, 5593.0, 5518.0, 5457.0, 5335.0, 5722.0, 5288.0, 5458.0, 5537.0, 5364.0, 5590.0, 5380.0, 5273.0, 5346.0, 5252.0, 5366.0, 5413.0, 5406.0, 5702.0, 5291.0, 5720.0, 5462.0, 5393.0, 5258.0, 5495.0, 5491.0, 5605.0, 5456.0, 5480.0, 5450.0, 5486.0, 5466.0, 5567.0, 5638.0, 5293.0, 5555.0, 5559.0, 5483.0, 5321.0, 5704.0, 5493.0, 5594.0, 5684.0, 5492.0, 5452.0, 5690.0, 5668.0, 5711.0, 5351.0, 5383.0, 5675.0, 5694.0, 5381.0, 5579.0, 5613.0, 5560.0, 5654.0, 5671.0, 5712.0
5	5290	9	1	333	1	5387.0, 5293.0, 5337.0, 5384.0, 5407.0, 5278.0, 5622.0, 5262.0, 5713.0, 5549.0, 5435.0, 5395.0, 5381.0, 5655.0, 5451.0, 5446.0, 5668.0, 5326.0, 5559.0, 5722.0, 5434.0, 5689.0, 5678.0, 5665.0, 5644.0, 5377.0, 5554.0, 5706.0, 5621.0, 5443.0, 5331.0, 5553.0, 5425.0, 5371.0, 5612.0, 5658.0, 5518.0, 5301.0, 5701.0, 5579.0, 5636.0, 5597.0, 5346.0, 5257.0, 5268.0, 5397.0, 5602.0, 5645.0, 5375.0, 5266.0, 5638.0, 5335.0, 5333.0, 5666.0, 5324.0, 5598.0, 5570.0, 5273.0, 5297.0, 5651.0, 5307.0, 5420.0, 5591.0, 5259.0, 5320.0, 5274.0, 5433.0, 5691.0, 5390.0, 5504.0, 5385.0, 5474.0, 5502.0, 5296.0, 5530.0, 5394.0, 5657.0, 5368.0, 5491.0, 5325.0, 5479.0, 5515.0, 5383.0, 5641.0, 5694.0, 5342.0, 5284.0, 5558.0, 5656.0, 5432.0, 5628.0, 5282.0, 5672.0, 5674.0, 5663.0, 5392.0, 5338.0, 5702.0, 5581.0, 5430.0
6	5290	9	1	333	1	5407.0, 5573.0, 5700.0, 5349.0, 5524.0, 5260.0, 5373.0, 5644.0, 5355.0, 5400.0, 5446.0, 5336.0, 5559.0, 5341.0, 5443.0, 5683.0, 5389.0, 5551.0, 5509.0, 5436.0, 5664.0, 5423.0, 5334.0, 5322.0, 5686.0, 5363.0, 5411.0, 5504.0, 5532.0, 5713.0, 5300.0, 5567.0, 5312.0, 5562.0, 5396.0, 5557.0, 5328.0, 5358.0, 5418.0, 5518.0, 5492.0, 5489.0, 5556.0, 5285.0, 5284.0, 5453.0, 5464.0, 5516.0, 5690.0, 5619.0, 5558.0, 5647.0, 5533.0, 5460.0, 5374.0, 5682.0, 5430.0, 5582.0, 5383.0, 5620.0, 5332.0, 5457.0, 5547.0, 5696.0, 5491.0,

						5578.0, 5356.0, 5613.0, 5611.0, 5298.0, 5536.0, 5416.0, 5519.0, 5281.0, 5315.0, 5308.0, 5621.0, 5499.0, 5435.0, 5450.0, 5340.0, 5709.0, 5608.0, 5420.0, 5473.0, 5310.0, 5574.0, 5583.0, 5717.0, 5296.0, 5662.0, 5317.0, 5722.0, 5274.0, 5635.0, 5637.0, 5697.0, 5712.0, 5623.0, 5706.0
7	5290	9	1	333	1	5255.0, 5258.0, 5310.0, 5515.0, 5472.0, 5708.0, 5375.0, 5350.0, 5667.0, 5499.0, 5531.0, 5657.0, 5620.0, 5334.0, 5562.0, 5624.0, 5501.0, 5596.0, 5330.0, 5544.0, 5397.0, 5582.0, 5539.0, 5309.0, 5568.0, 5656.0, 5555.0, 5468.0, 5417.0, 5632.0, 5701.0, 5271.0, 5293.0, 5694.0, 5466.0, 5651.0, 5648.0, 5300.0, 5324.0, 5619.0, 5444.0, 5495.0, 5279.0, 5622.0, 5605.0, 5695.0, 5260.0, 5388.0, 5497.0, 5419.0, 5311.0, 5707.0, 5268.0, 5446.0, 5439.0, 5427.0, 5259.0, 5371.0, 5522.0, 5572.0, 5524.0, 5338.0, 5253.0, 5700.0, 5421.0, 5618.0, 5589.0, 5546.0, 5569.0, 5643.0, 5418.0, 5442.0, 5329.0, 5357.0, 5581.0, 5351.0, 5295.0, 5538.0, 5426.0, 5487.0, 5507.0, 5385.0, 5712.0, 5644.0, 5668.0, 5440.0, 5603.0, 5587.0, 5348.0, 5652.0, 5525.0, 5316.0, 5304.0, 5717.0, 5318.0, 5486.0, 5285.0, 5520.0, 5579.0, 5718.0
8	5290	9	1	333	1	5695.0, 5483.0, 5259.0, 5552.0, 5579.0, 5382.0, 5405.0, 5516.0, 5673.0, 5625.0, 5296.0, 5262.0, 5651.0, 5337.0, 5336.0, 5315.0, 5510.0, 5511.0, 5609.0, 5279.0, 5555.0, 5339.0, 5630.0, 5433.0, 5603.0, 5342.0, 5602.0, 5690.0, 5258.0, 5494.0, 5587.0, 5379.0, 5392.0, 5281.0, 5654.0, 5676.0, 5466.0, 5282.0, 5439.0, 5598.0, 5254.0, 5499.0, 5638.0, 5456.0, 5452.0, 5365.0, 5606.0, 5417.0, 5675.0, 5639.0, 5401.0, 5424.0, 5251.0, 5530.0, 5380.0, 5520.0, 5595.0, 5576.0, 5680.0, 5299.0, 5559.0, 5370.0, 5627.0, 5591.0, 5396.0, 5264.0, 5527.0, 5362.0, 5716.0, 5256.0, 5376.0, 5464.0, 5667.0, 5422.0, 5277.0, 5514.0, 5549.0, 5662.0, 5522.0, 5521.0, 5470.0, 5551.0, 5385.0, 5700.0, 5633.0, 5272.0, 5629.0, 5462.0, 5454.0, 5529.0, 5524.0, 5674.0, 5506.0, 5647.0, 5537.0, 5689.0, 5531.0, 5664.0, 5554.0, 5650.0
9	5290	9	1	333	1	5568.0, 5649.0, 5513.0, 5547.0, 5389.0, 5281.0, 5382.0, 5570.0, 5283.0, 5522.0, 5444.0, 5446.0, 5530.0, 5375.0, 5622.0, 5558.0, 5369.0, 5341.0, 5288.0, 5633.0, 5306.0, 5318.0, 5307.0, 5689.0, 5331.0, 5262.0, 5636.0, 5562.0, 5516.0, 5695.0, 5436.0, 5386.0, 5682.0, 5644.0, 5611.0, 5412.0, 5640.0, 5402.0, 5608.0, 5334.0, 5659.0, 5362.0, 5560.0, 5654.0, 5368.0, 5455.0, 5470.0, 5438.0, 5416.0, 5557.0, 5292.0, 5447.0, 5332.0, 5350.0, 5519.0, 5626.0, 5664.0, 5573.0, 5616.0, 5709.0, 5592.0, 5479.0, 5471.0, 5299.0, 5488.0

						5317.0, 5697.0, 5593.0, 5303.0, 5722.0, 5366.0, 5676.0, 5509.0, 5254.0, 5275.0, 5566.0, 5552.0, 5567.0, 5460.0, 5370.0, 5322.0, 5404.0, 5704.0, 5310.0, 5629.0, 5521.0, 5572.0, 5304.0, 5291.0, 5321.0, 5691.0, 5571.0, 5456.0, 5624.0, 5485.0, 5590.0, 5591.0, 5473.0, 5443.0, 5632.00
10	5290	9	1	333	1	5665.0, 5441.0, 5330.0, 5421.0, 5276.0, 5346.0, 5694.0, 5632.0, 5687.0, 5394.0, 5614.0, 5721.0, 5496.0, 5709.0, 5298.0, 5445.0, 5500.0, 5569.0, 5577.0, 5641.0, 5323.0, 5255.0, 5671.0, 5506.0, 5683.0, 5252.0, 5716.0, 5277.0, 5414.0, 5548.0, 5722.0, 5595.0, 5266.0, 5617.0, 5332.0, 5684.0, 5444.0, 5693.0, 5413.0, 5553.0, 5653.0, 5392.0, 5391.0, 5715.0, 5281.0, 5648.0, 5359.0, 5317.0, 5555.0, 5686.0, 5512.0, 5339.0, 5723.0, 5473.0, 5396.0, 5534.0, 5624.0, 5364.0, 5596.0, 5700.0, 5300.0, 5649.0, 5714.0, 5401.0, 5402.0, 5487.0, 5250.0, 5633.0, 5679.0, 5549.0, 5309.0, 5622.0, 5404.0, 5650.0, 5597.0, 5670.0, 5278.0, 5570.0, 5368.0, 5261.0, 5470.0, 5498.0, 5451.0, 5656.0, 5642.0, 5357.0, 5664.0, 5260.0, 5375.0, 5550.0, 5613.0, 5274.0, 5547.0, 5601.0, 5383.0, 5525.0, 5483.0, 5480.0, 5710.0, 5395.0
11	5290	9	1	333	1	5717.0, 5685.0, 5656.0, 5423.0, 5384.0, 5491.0, 5285.0, 5546.0, 5315.0, 5279.0, 5627.0, 5424.0, 5708.0, 5585.0, 5539.0, 5560.0, 5336.0, 5256.0, 5602.0, 5324.0, 5482.0, 5287.0, 5432.0, 5255.0, 5513.0, 5446.0, 5390.0, 5554.0, 5520.0, 5702.0, 5363.0, 5400.0, 5701.0, 5349.0, 5603.0, 5419.0, 5258.0, 5290.0, 5665.0, 5410.0, 5579.0, 5620.0, 5467.0, 5515.0, 5297.0, 5633.0, 5362.0, 5710.0, 5606.0, 5478.0, 5638.0, 5366.0, 5403.0, 5402.0, 5273.0, 5415.0, 5405.0, 5590.0, 5635.0, 5523.0, 5479.0, 5346.0, 5618.0, 5298.0, 5251.0, 5342.0, 5509.0, 5663.0, 5559.0, 5455.0, 5615.0, 5683.0, 5306.0, 5267.0, 5722.0, 5319.0, 5367.0, 5694.0, 5397.0, 5544.0, 5442.0, 5496.0, 5517.0, 5464.0, 5431.0, 5288.0, 5355.0, 5382.0, 5377.0, 5364.0, 5631.0, 5309.0, 5715.0, 5505.0, 5411.0, 5333.0, 5317.0, 5408.0, 5389.0, 5644.0
12	5290	9	1	333	1	5672.0, 5667.0, 5654.0, 5290.0, 5272.0, 5335.0, 5632.0, 5350.0, 5407.0, 5548.0, 5643.0, 5576.0, 5468.0, 5720.0, 5557.0, 5311.0, 5328.0, 5591.0, 5511.0, 5276.0, 5345.0, 5459.0, 5343.0, 5330.0, 5479.0, 5419.0, 5451.0, 5357.0, 5377.0, 5579.0, 5710.0, 5393.0, 5274.0, 5427.0, 5696.0, 5587.0, 5681.0, 5369.0, 5310.0, 5719.0, 5464.0, 5582.0, 5584.0, 5580.0, 5416.0, 5449.0, 5570.0, 5562.0, 5336.0, 5520.0, 5718.0, 5524.0, 5674.0, 5391.0, 5495.0, 5514.0, 5440.0, 5595.0, 5384.0, 5608.0, 5636.0, 5375.0, 5693.0, 5304.0, 5662.0,

						5653.0, 5652.0, 5412.0, 5446.0, 5430.0, 5332.0, 5628.0, 5499.0, 5263.0, 5317.0, 5385.0, 5583.0, 5713.0, 5491.0, 5711.0, 5418.0, 5722.0, 5622.0, 5287.0, 5707.0, 5270.0, 5551.0, 5443.0, 5624.0, 5600.0, 5477.0, 5261.0, 5453.0, 5383.0, 5470.0, 5683.0, 5286.0, 5697.0, 5684.0, 5314.0
13	5290	9	1	333	1	5377.0, 5256.0, 5536.0, 5713.0, 5652.0, 5444.0, 5592.0, 5318.0, 5361.0, 5711.0, 5483.0, 5260.0, 5588.0, 5348.0, 5382.0, 5528.0, 5360.0, 5434.0, 5671.0, 5270.0, 5712.0, 5538.0, 5466.0, 5595.0, 5411.0, 5461.0, 5415.0, 5579.0, 5590.0, 5343.0, 5255.0, 5306.0, 5505.0, 5605.0, 5724.0, 5405.0, 5309.0, 5587.0, 5480.0, 5503.0, 5438.0, 5423.0, 5284.0, 5337.0, 5665.0, 5577.0, 5585.0, 5486.0, 5606.0, 5344.0, 5539.0, 5358.0, 5391.0, 5617.0, 5263.0, 5369.0, 5524.0, 5522.0, 5656.0, 5271.0, 5611.0, 5641.0, 5550.0, 5630.0, 5282.0, 5456.0, 5549.0, 5349.0, 5388.0, 5532.0, 5706.0, 5317.0, 5412.0, 5425.0, 5443.0, 5455.0, 5351.0, 5390.0, 5453.0, 5710.0, 5457.0, 5283.0, 5597.0, 5409.0, 5432.0, 5471.0, 5410.0, 5515.0, 5470.0, 5556.0, 5315.0, 5653.0, 5366.0, 5346.0, 5357.0, 5428.0, 5661.0, 5670.0, 5651.0, 5683.0
14	5290	9	1	333	1	5638.0, 5551.0, 5313.0, 5659.0, 5281.0, 5644.0, 5433.0, 5407.0, 5717.0, 5581.0, 5505.0, 5383.0, 5633.0, 5343.0, 5687.0, 5428.0, 5610.0, 5517.0, 5705.0, 5623.0, 5422.0, 5477.0, 5488.0, 5532.0, 5589.0, 5487.0, 5408.0, 5476.0, 5661.0, 5679.0, 5365.0, 5701.0, 5609.0, 5319.0, 5693.0, 5622.0, 5675.0, 5308.0, 5540.0, 5569.0, 5524.0, 5498.0, 5314.0, 5449.0, 5599.0, 5256.0, 5264.0, 5618.0, 5707.0, 5267.0, 5607.0, 5301.0, 5385.0, 5375.0, 5467.0, 5702.0, 5501.0, 5364.0, 5342.0, 5681.0, 5507.0, 5344.0, 5703.0, 5447.0, 5296.0, 5716.0, 5436.0, 5550.0, 5297.0, 5519.0, 5669.0, 5691.0, 5641.0, 5440.0, 5696.0, 5680.0, 5340.0, 5427.0, 5425.0, 5437.0, 5455.0, 5668.0, 5469.0, 5573.0, 5423.0, 5473.0, 5557.0, 5309.0, 5671.0, 5439.0, 5709.0, 5536.0, 5273.0, 5499.0, 5592.0, 5371.0, 5483.0, 5324.0, 5457.0, 5334.0
15	5290	9	1	333	1	5432.0, 5588.0, 5426.0, 5713.0, 5626.0, 5412.0, 5535.0, 5425.0, 5686.0, 5337.0, 5397.0, 5350.0, 5481.0, 5365.0, 5531.0, 5392.0, 5343.0, 5285.0, 5439.0, 5663.0, 5409.0, 5280.0, 5651.0, 5715.0, 5676.0, 5328.0, 5322.0, 5288.0, 5252.0, 5396.0, 5434.0, 5259.0, 5255.0, 5475.0, 5581.0, 5385.0, 5609.0, 5498.0, 5482.0, 5542.0, 5553.0, 5598.0, 5301.0, 5272.0, 5577.0, 5606.0, 5405.0, 5640.0, 5318.0, 5604.0, 5452.0, 5719.0, 5433.0, 5712.0, 5316.0, 5656.0, 5250.0, 5473.0, 5530.0, 5270.0, 5406.0, 5718.0, 5391.0, 5378.0, 5526.0

						5361.0, 5377.0, 5654.0, 5627.0, 5453.0, 5407.0, 5424.0, 5567.0, 5722.0, 5597.0, 5678.0, 5657.0, 5478.0, 5390.0, 5354.0, 5404.0, 5283.0, 5630.0, 5344.0, 5287.0, 5680.0, 5696.0, 5619.0, 5311.0, 5565.0, 5298.0, 5593.0, 5589.0, 5561.0, 5313.0, 5611.0, 5618.0, 5258.0, 5314.0, 5349.0
16	5290	9	1	333	1	5259.0, 5318.0, 5487.0, 5567.0, 5652.0, 5536.0, 5586.0, 5472.0, 5565.0, 5370.0, 5680.0, 5339.0, 5347.0, 5420.0, 5515.0, 5720.0, 5437.0, 5426.0, 5414.0, 5366.0, 5697.0, 5269.0, 5256.0, 5280.0, 5502.0, 5704.0, 5393.0, 5504.0, 5252.0, 5647.0, 5335.0, 5359.0, 5662.0, 5523.0, 5645.0, 5470.0, 5555.0, 5709.0, 5309.0, 5661.0, 5418.0, 5413.0, 5624.0, 5663.0, 5355.0, 5575.0, 5651.0, 5407.0, 5554.0, 5473.0, 5447.0, 5552.0, 5625.0, 5711.0, 5445.0, 5296.0, 5299.0, 5580.0, 5588.0, 5440.0, 5396.0, 5583.0, 5320.0, 5547.0, 5542.0, 5528.0, 5411.0, 5333.0, 5518.0, 5297.0, 5329.0, 5692.0, 5495.0, 5301.0, 5334.0, 5525.0, 5683.0, 5388.0, 5268.0, 5549.0, 5510.0, 5486.0, 5422.0, 5607.0, 5293.0, 5284.0, 5479.0, 5304.0, 5545.0, 5307.0, 5310.0, 5385.0, 5700.0, 5373.0, 5490.0, 5609.0, 5522.0, 5433.0, 5615.0, 5611.0
17	5290	9	1	333	1	5404.0, 5591.0, 5526.0, 5551.0, 5496.0, 5349.0, 5718.0, 5720.0, 5403.0, 5269.0, 5576.0, 5296.0, 5446.0, 5438.0, 5383.0, 5531.0, 5540.0, 5593.0, 5343.0, 5436.0, 5697.0, 5620.0, 5418.0, 5358.0, 5527.0, 5567.0, 5571.0, 5533.0, 5635.0, 5626.0, 5413.0, 5509.0, 5575.0, 5607.0, 5447.0, 5331.0, 5538.0, 5564.0, 5702.0, 5517.0, 5289.0, 5521.0, 5362.0, 5556.0, 5677.0, 5685.0, 5507.0, 5341.0, 5435.0, 5282.0, 5616.0, 5676.0, 5397.0, 5445.0, 5258.0, 5604.0, 5646.0, 5307.0, 5400.0, 5353.0, 5650.0, 5329.0, 5552.0, 5253.0, 5408.0, 5402.0, 5708.0, 5340.0, 5578.0, 5589.0, 5321.0, 5367.0, 5712.0, 5634.0, 5483.0, 5392.0, 5290.0, 5423.0, 5539.0, 5264.0, 5523.0, 5512.0, 5426.0, 5500.0, 5498.0, 5449.0, 5303.0, 5334.0, 5488.0, 5419.0, 5314.0, 5270.0, 5469.0, 5454.0, 5255.0, 5558.0, 5668.0, 5421.0, 5263.0, 5328.0
18	5290	9	1	333	1	5616.0, 5265.0, 5269.0, 5359.0, 5316.0, 5678.0, 5366.0, 5598.0, 5715.0, 5711.0, 5445.0, 5392.0, 5318.0, 5347.0, 5433.0, 5659.0, 5561.0, 5548.0, 5466.0, 5523.0, 5262.0, 5566.0, 5447.0, 5451.0, 5350.0, 5388.0, 5310.0, 5419.0, 5291.0, 5434.0, 5687.0, 5422.0, 5332.0, 5406.0, 5418.0, 5512.0, 5492.0, 5718.0, 5290.0, 5585.0, 5371.0, 5452.0, 5631.0, 5346.0, 5374.0, 5504.0, 5705.0, 5623.0, 5669.0, 5272.0, 5592.0, 5256.0, 5607.0, 5483.0, 5481.0, 5343.0, 5336.0, 5543.0, 5429.0, 5362.0, 5581.0, 5604.0, 5503.0, 5557.0, 5268.0

						5427.0, 5608.0, 5537.0, 5677.0, 5573.0, 5574.0, 5495.0, 5381.0, 5330.0, 5327.0, 5502.0, 5530.0, 5617.0, 5629.0, 5373.0, 5370.0, 5627.0, 5699.0, 5257.0, 5389.0, 5712.0, 5703.0, 5563.0, 5372.0, 5520.0, 5411.0, 5568.0, 5465.0, 5475.0, 5456.0, 5414.0, 5339.0, 5266.0, 5720.0, 5668.0
19	5290	9	1	333	1	5347.0, 5384.0, 5441.0, 5263.0, 5440.0, 5598.0, 5403.0, 5567.0, 5629.0, 5595.0, 5273.0, 5717.0, 5552.0, 5385.0, 5635.0, 5683.0, 5707.0, 5676.0, 5633.0, 5514.0, 5520.0, 5690.0, 5634.0, 5261.0, 5342.0, 5305.0, 5378.0, 5304.0, 5489.0, 5438.0, 5420.0, 5418.0, 5257.0, 5316.0, 5393.0, 5388.0, 5394.0, 5262.0, 5669.0, 5708.0, 5570.0, 5423.0, 5691.0, 5443.0, 5513.0, 5620.0, 5457.0, 5464.0, 5311.0, 5627.0, 5666.0, 5519.0, 5580.0, 5451.0, 5588.0, 5280.0, 5372.0, 5411.0, 5484.0, 5398.0, 5652.0, 5272.0, 5485.0, 5252.0, 5400.0, 5465.0, 5541.0, 5370.0, 5626.0, 5630.0, 5616.0, 5647.0, 5653.0, 5415.0, 5709.0, 5651.0, 5255.0, 5599.0, 5559.0, 5335.0, 5503.0, 5346.0, 5613.0, 5496.0, 5637.0, 5544.0, 5303.0, 5268.0, 5654.0, 5581.0, 5326.0, 5623.0, 5659.0, 5275.0, 5495.0, 5330.0, 5432.0, 5688.0, 5498.0, 5294.0
20	5290	9	1	333	1	5458.0, 5291.0, 5386.0, 5445.0, 5616.0, 5253.0, 5427.0, 5682.0, 5555.0, 5594.0, 5526.0, 5619.0, 5652.0, 5634.0, 5516.0, 5572.0, 5511.0, 5295.0, 5676.0, 5453.0, 5471.0, 5326.0, 5666.0, 5324.0, 5541.0, 5529.0, 5294.0, 5628.0, 5259.0, 5300.0, 5345.0, 5476.0, 5524.0, 5284.0, 5544.0, 5659.0, 5491.0, 5342.0, 5444.0, 5456.0, 5638.0, 5473.0, 5649.0, 5624.0, 5457.0, 5270.0, 5685.0, 5252.0, 5522.0, 5559.0, 5643.0, 5598.0, 5707.0, 5443.0, 5323.0, 5451.0, 5404.0, 5460.0, 5673.0, 5383.0, 5612.0, 5521.0, 5395.0, 5568.0, 5553.0, 5617.0, 5278.0, 5507.0, 5501.0, 5528.0, 5564.0, 5658.0, 5483.0, 5450.0, 5543.0, 5433.0, 5282.0, 5264.0, 5414.0, 5550.0, 5603.0, 5692.0, 5289.0, 5479.0, 5613.0, 5700.0, 5695.0, 5393.0, 5378.0, 5449.0, 5251.0, 5262.0, 5681.0, 5304.0, 5637.0, 5370.0, 5365.0, 5260.0, 5421.0, 5429.0
21	5290	9	1	333	1	5609.0, 5274.0, 5611.0, 5430.0, 5305.0, 5267.0, 5443.0, 5531.0, 5339.0, 5491.0, 5486.0, 5503.0, 5315.0, 5410.0, 5685.0, 5721.0, 5532.0, 5389.0, 5573.0, 5705.0, 5276.0, 5666.0, 5577.0, 5627.0, 5541.0, 5509.0, 5370.0, 5574.0, 5617.0, 5542.0, 5570.0, 5335.0, 5291.0, 5437.0, 5418.0, 5306.0, 5252.0, 5505.0, 5625.0, 5279.0, 5545.0, 5669.0, 5561.0, 5678.0, 5314.0, 5458.0, 5444.0, 5349.0, 5308.0, 5582.0, 5386.0, 5588.0, 5724.0, 5567.0, 5436.0, 5286.0, 5427.0, 5639.0, 5258.0, 5454.0, 5464.0, 5353.0, 5302.0, 5476.0, 5462.0

						5316.0, 5283.0, 5535.0, 5360.0, 5463.0, 5432.0, 5713.0, 5576.0, 5382.0, 5447.0, 5621.0, 5711.0, 5494.0, 5622.0, 5321.0, 5477.0, 5363.0, 5599.0, 5526.0, 5357.0, 5457.0, 5390.0, 5523.0, 5311.0, 5352.0, 5717.0, 5466.0, 5359.0, 5287.0, 5272.0, 5579.0, 5499.0, 5558.0, 5688.0, 5431.0
22	5290	9	1	333	1	5369.0, 5503.0, 5492.0, 5604.0, 5521.0, 5664.0, 5287.0, 5402.0, 5674.0, 5646.0, 5505.0, 5300.0, 5592.0, 5628.0, 5481.0, 5404.0, 5626.0, 5378.0, 5260.0, 5444.0, 5299.0, 5668.0, 5390.0, 5252.0, 5680.0, 5619.0, 5399.0, 5612.0, 5564.0, 5341.0, 5510.0, 5648.0, 5493.0, 5600.0, 5274.0, 5515.0, 5673.0, 5441.0, 5599.0, 5530.0, 5622.0, 5636.0, 5367.0, 5364.0, 5278.0, 5488.0, 5438.0, 5507.0, 5462.0, 5457.0, 5485.0, 5272.0, 5720.0, 5432.0, 5565.0, 5256.0, 5435.0, 5413.0, 5379.0, 5360.0, 5340.0, 5382.0, 5591.0, 5280.0, 5269.0, 5414.0, 5448.0, 5634.0, 5320.0, 5322.0, 5713.0, 5297.0, 5597.0, 5384.0, 5336.0, 5257.0, 5512.0, 5393.0, 5352.0, 5344.0, 5705.0, 5596.0, 5323.0, 5691.0, 5583.0, 5443.0, 5516.0, 5265.0, 5608.0, 5500.0, 5387.0, 5415.0, 5284.0, 5490.0, 5522.0, 5391.0, 5611.0, 5311.0, 5467.0, 5639.0
23	5290	9	1	333	1	5377.0, 5277.0, 5714.0, 5290.0, 5465.0, 5546.0, 5487.0, 5591.0, 5475.0, 5400.0, 5555.0, 5693.0, 5521.0, 5420.0, 5485.0, 5648.0, 5668.0, 5545.0, 5301.0, 5585.0, 5425.0, 5598.0, 5333.0, 5542.0, 5337.0, 5503.0, 5517.0, 5621.0, 5467.0, 5299.0, 5580.0, 5691.0, 5385.0, 5589.0, 5357.0, 5432.0, 5593.0, 5322.0, 5414.0, 5373.0, 5365.0, 5291.0, 5344.0, 5460.0, 5637.0, 5582.0, 5430.0, 5579.0, 5712.0, 5446.0, 5443.0, 5478.0, 5463.0, 5402.0, 5284.0, 5558.0, 5263.0, 5703.0, 5688.0, 5674.0, 5323.0, 5573.0, 5700.0, 5410.0, 5505.0, 5252.0, 5451.0, 5520.0, 5489.0, 5702.0, 5327.0, 5687.0, 5493.0, 5274.0, 5439.0, 5567.0, 5528.0, 5678.0, 5578.0, 5356.0, 5506.0, 5705.0, 5384.0, 5615.0, 5603.0, 5459.0, 5431.0, 5710.0, 5500.0, 5372.0, 5339.0, 5408.0, 5497.0, 5367.0, 5588.0, 5635.0, 5596.0, 5690.0, 5343.0, 5490.0
24	5290	9	1	333	1	5656.0, 5594.0, 5262.0, 5412.0, 5599.0, 5536.0, 5505.0, 5321.0, 5707.0, 5372.0, 5454.0, 5485.0, 5544.0, 5421.0, 5682.0, 5511.0, 5352.0, 5360.0, 5336.0, 5558.0, 5664.0, 5414.0, 5274.0, 5577.0, 5523.0, 5491.0, 5277.0, 5382.0, 5386.0, 5553.0, 5416.0, 5304.0, 5313.0, 5270.0, 5559.0, 5534.0, 5663.0, 5373.0, 5340.0, 5718.0, 5349.0, 5615.0, 5466.0, 5587.0, 5569.0, 5531.0, 5341.0, 5408.0, 5476.0, 5533.0, 5717.0, 5719.0, 5334.0, 5358.0, 5564.0, 5366.0, 5517.0, 5515.0, 5335.0, 5289.0, 5384.0, 5528.0, 5520.0, 5636.0, 5706.0

						5652.0, 5285.0, 5359.0, 5684.0, 5317.0, 5621.0, 5392.0, 5644.0, 5371.0, 5275.0, 5425.0, 5396.0, 5429.0, 5500.0, 5369.0, 5253.0, 5521.0, 5590.0, 5329.0, 5519.0, 5263.0, 5400.0, 5422.0, 5642.0, 5638.0, 5712.0, 5518.0, 5281.0, 5447.0, 5689.0, 5578.0, 5508.0, 5342.0, 5310.0, 5504.0
25	5290	9	1	333	1	5292.0, 5263.0, 5698.0, 5641.0, 5713.0, 5624.0, 5413.0, 5705.0, 5254.0, 5269.0, 5598.0, 5303.0, 5694.0, 5586.0, 5286.0, 5469.0, 5533.0, 5329.0, 5394.0, 5504.0, 5609.0, 5559.0, 5482.0, 5667.0, 5353.0, 5415.0, 5470.0, 5446.0, 5572.0, 5453.0, 5339.0, 5639.0, 5603.0, 5666.0, 5655.0, 5594.0, 5680.0, 5406.0, 5299.0, 5612.0, 5634.0, 5411.0, 5291.0, 5287.0, 5527.0, 5656.0, 5599.0, 5393.0, 5614.0, 5532.0, 5685.0, 5258.0, 5388.0, 5268.0, 5366.0, 5468.0, 5566.0, 5401.0, 5375.0, 5440.0, 5400.0, 5588.0, 5640.0, 5538.0, 5335.0, 5585.0, 5692.0, 5348.0, 5283.0, 5326.0, 5261.0, 5561.0, 5438.0, 5322.0, 5338.0, 5275.0, 5442.0, 5552.0, 5706.0, 5386.0, 5717.0, 5372.0, 5310.0, 5265.0, 5266.0, 5455.0, 5510.0, 5475.0, 5336.0, 5323.0, 5557.0, 5488.0, 5420.0, 5564.0, 5542.0, 5537.0, 5315.0, 5278.0, 5589.0, 5298.0
26	5290	9	1	333	1	5710.0, 5645.0, 5516.0, 5442.0, 5575.0, 5333.0, 5630.0, 5662.0, 5353.0, 5421.0, 5709.0, 5464.0, 5545.0, 5490.0, 5609.0, 5420.0, 5708.0, 5535.0, 5694.0, 5503.0, 5527.0, 5636.0, 5647.0, 5586.0, 5498.0, 5322.0, 5310.0, 5439.0, 5615.0, 5550.0, 5511.0, 5452.0, 5515.0, 5274.0, 5261.0, 5499.0, 5448.0, 5566.0, 5531.0, 5549.0, 5717.0, 5419.0, 5395.0, 5507.0, 5456.0, 5318.0, 5542.0, 5593.0, 5465.0, 5336.0, 5533.0, 5557.0, 5277.0, 5356.0, 5686.0, 5616.0, 5433.0, 5518.0, 5466.0, 5548.0, 5513.0, 5517.0, 5628.0, 5477.0, 5591.0, 5551.0, 5623.0, 5300.0, 5446.0, 5637.0, 5425.0, 5284.0, 5385.0, 5345.0, 5389.0, 5293.0, 5613.0, 5366.0, 5585.0, 5512.0, 5438.0, 5287.0, 5660.0, 5610.0, 5334.0, 5657.0, 5388.0, 5720.0, 5572.0, 5670.0, 5568.0, 5625.0, 5688.0, 5712.0, 5341.0, 5618.0, 5655.0, 5703.0, 5602.0, 5290.0
27	5290	9	1	333	1	5502.0, 5263.0, 5659.0, 5514.0, 5673.0, 5353.0, 5623.0, 5382.0, 5303.0, 5605.0, 5381.0, 5557.0, 5472.0, 5461.0, 5714.0, 5512.0, 5444.0, 5480.0, 5268.0, 5654.0, 5508.0, 5572.0, 5666.0, 5501.0, 5669.0, 5441.0, 5560.0, 5343.0, 5639.0, 5403.0, 5629.0, 5252.0, 5637.0, 5638.0, 5253.0, 5320.0, 5351.0, 5526.0, 5312.0, 5261.0, 5305.0, 5474.0, 5622.0, 5282.0, 5577.0, 5709.0, 5686.0, 5446.0, 5705.0, 5491.0, 5530.0, 5411.0, 5682.0, 5426.0, 5496.0, 5286.0, 5408.0, 5360.0, 5603.0, 5592.0, 5688.0, 5509.0, 5573.0, 5293.0, 5288.0

						5696.0, 5367.0, 5542.0, 5412.0, 5341.0, 5702.0, 5593.0, 5401.0, 5409.0, 5648.0, 5566.0, 5317.0, 5462.0, 5389.0, 5347.0, 5609.0, 5359.0, 5499.0, 5471.0, 5290.0, 5416.0, 5668.0, 5582.0, 5350.0, 5568.0, 5571.0, 5467.0, 5269.0, 5454.0, 5306.0, 5708.0, 5354.0, 5468.0, 5584.0, 5370.0
28	5290	9	1	333	1	5555.0, 5657.0, 5645.0, 5502.0, 5483.0, 5370.0, 5279.0, 5641.0, 5703.0, 5360.0, 5488.0, 5261.0, 5305.0, 5630.0, 5558.0, 5443.0, 5570.0, 5548.0, 5509.0, 5547.0, 5527.0, 5501.0, 5386.0, 5530.0, 5676.0, 5353.0, 5378.0, 5475.0, 5646.0, 5610.0, 5273.0, 5659.0, 5341.0, 5690.0, 5691.0, 5421.0, 5658.0, 5390.0, 5309.0, 5306.0, 5675.0, 5687.0, 5644.0, 5427.0, 5518.0, 5315.0, 5669.0, 5697.0, 5609.0, 5350.0, 5358.0, 5567.0, 5573.0, 5441.0, 5440.0, 5624.0, 5389.0, 5329.0, 5365.0, 5591.0, 5413.0, 5551.0, 5512.0, 5376.0, 5380.0, 5524.0, 5444.0, 5620.0, 5571.0, 5504.0, 5552.0, 5423.0, 5575.0, 5459.0, 5493.0, 5578.0, 5637.0, 5685.0, 5281.0, 5672.0, 5699.0, 5323.0, 5600.0, 5589.0, 5497.0, 5638.0, 5503.0, 5605.0, 5398.0, 5426.0, 5271.0, 5713.0, 5354.0, 5698.0, 5399.0, 5411.0, 5340.0, 5319.0, 5285.0, 5722.0
29	5290	9	1	333	1	5433.0, 5279.0, 5421.0, 5296.0, 5254.0, 5645.0, 5557.0, 5681.0, 5381.0, 5333.0, 5617.0, 5457.0, 5413.0, 5300.0, 5494.0, 5475.0, 5710.0, 5438.0, 5721.0, 5388.0, 5616.0, 5317.0, 5686.0, 5398.0, 5488.0, 5697.0, 5393.0, 5561.0, 5574.0, 5318.0, 5588.0, 5346.0, 5632.0, 5353.0, 5577.0, 5365.0, 5312.0, 5652.0, 5276.0, 5692.0, 5650.0, 5572.0, 5489.0, 5723.0, 5690.0, 5391.0, 5667.0, 5502.0, 5628.0, 5643.0, 5624.0, 5702.0, 5545.0, 5448.0, 5688.0, 5625.0, 5461.0, 5596.0, 5708.0, 5287.0, 5510.0, 5576.0, 5582.0, 5498.0, 5463.0, 5642.0, 5326.0, 5294.0, 5452.0, 5430.0, 5336.0, 5278.0, 5313.0, 5526.0, 5651.0, 5607.0, 5646.0, 5376.0, 5693.0, 5566.0, 5377.0, 5583.0, 5474.0, 5331.0, 5385.0, 5324.0, 5674.0, 5627.0, 5338.0, 5518.0, 5552.0, 5682.0, 5492.0, 5612.0, 5264.0, 5325.0, 5653.0, 5705.0, 5470.0, 5408.0
30	5290	9	1	333	1	5265.0, 5718.0, 5708.0, 5681.0, 5401.0, 5381.0, 5319.0, 5281.0, 5560.0, 5309.0, 5329.0, 5504.0, 5439.0, 5304.0, 5417.0, 5524.0, 5414.0, 5663.0, 5634.0, 5713.0, 5339.0, 5529.0, 5646.0, 5633.0, 5423.0, 5514.0, 5303.0, 5570.0, 5505.0, 5347.0, 5585.0, 5561.0, 5515.0, 5259.0, 5645.0, 5452.0, 5579.0, 5669.0, 5595.0, 5453.0, 5343.0, 5465.0, 5274.0, 5382.0, 5269.0, 5364.0, 5714.0, 5449.0, 5463.0, 5459.0, 5597.0, 5375.0, 5629.0, 5685.0, 5665.0, 5407.0, 5386.0, 5380.0, 5581.0, 5641.0, 5548.0, 5428.0, 5690.0, 5719.0, 5482.0

						5278.0, 5531.0, 5664.0, 5393.0, 5620.0, 5300.0, 5477.0, 5723.0, 5543.0, 5508.0, 5628.0, 5539.0, 5391.0, 5342.0, 5593.0, 5438.0, 5294.0, 5566.0, 5494.0, 5395.0, 5353.0, 5333.0, 5324.0, 5705.0, 5412.0, 5672.0, 5498.0, 5662.0, 5542.0, 5469.0, 5509.0, 5643.0, 5466.0, 5298.0, 5619.0
--	--	--	--	--	--	--

BRIDGE AND/OR MESH MODE

Test Standard:

Networks Access Points with Bridge and/or MESH modes of operation are permitted to operate in the DFS bands but must employ a DFS function. The functionality of the Bridge mode as specified in §15.403(a) must be validated in the DFS test report. Devices operating as relays where they act as master and client must also employ DFS function for the master. The method used to validate the functionality must be documented and validation data must be documented. Bridge mode can be validated by performing a test statistical performance check (Section 7.8.4) on any one of the radar types. This is an abbreviated test to verify DFS functionality. MESH mode operational methodology must be submitted in the application for certification for evaluation by the FCC.

Test Result:

Compliance, please refer the the below data.

5290MHz**Radar Type 2 Statistical Performance**

Trial #	Fc (MHz)	Pulse/Burst	Pulse Width (μS)	PRI (μs)	Detection (1:yes; 0:no)
1	5290	28	2.8	222	1
2	5290	28	1.7	170	1
3	5290	24	1.3	151	1
4	5290	25	1	163	1
5	5290	24	2.7	218	1
6	5290	26	3.7	223	1
7	5290	26	2.9	222	1
8	5290	25	2.7	178	1
9	5290	23	3.4	203	1
10	5290	23	2.5	213	1
11	5290	24	4.1	172	1
12	5290	23	1.4	196	1
13	5290	25	3.6	206	1
14	5290	27	1.4	227	1
15	5290	25	1.2	189	1
16	5290	26	1.7	196	1
17	5290	29	2.4	160	1
18	5290	29	2	173	1
19	5290	26	4.6	199	1
20	5290	27	2.5	181	1
21	5290	27	4.2	186	1
22	5290	29	1.8	198	1
23	5290	26	3.6	182	1
24	5290	24	4.1	219	1
25	5290	27	4.1	174	1
26	5290	24	1.7	169	1
27	5290	24	1.6	195	1
28	5290	28	1.8	182	1
29	5290	26	3.1	191	1
30	5290	27	1.4	172	1
Detection Percentage: 100 % (>60%)					

Directions

1. The information marked # is provided by the applicant, the laboratory is not responsible for its authenticity and this information can affect the validity of the result in the test report.
2. Unless otherwise stated the results shown in this test report refer only to the sample(s) tested.
3. Otherwise required by the applicant or Product Regulations, Decision Rule in this report did not consider the uncertainty.
4. The extended uncertainty given in this report is obtained by combining the standard uncertainty times the coverage factor K with the 95% confidence interval.
5. This report cannot be reproduced except in full, without prior written approval of the Company.
6. This report is valid only with a valid digital signature. The digital signature may be available only under the Adobe software above version 7.0.
7. This report may contain data that are not covered by the accreditation scope and shall be marked with an asterisk “★” .
8. This report must not be used by the customer to claim product certification, approval, or endorsement by A2LA, or any agency of the U.S. Government.

******* END OF REPORT *******