



FCC PART 15.407
RSS-247, ISSUE 2, FEBRUARY 2017
DYNAMIC FREQUENCY SELECTION
TEST REPORT

For

Grandstream Networks, Inc.

126 Brookline Ave., 3rd Floor Boston, MA 02215, USA

FCC ID: YZZGWN7630
IC:11964A-GWN7630

Report Type: Original Report	Product Type: Enterprise 802.11ac Wave-2 4x4 : 4 Wi-Fi Access Point
Report Number:	RSZ190626007-00
Report Date:	2019-10-14
Reviewed By:	Jerry Zhang EMC Manager <i>Jerry Zhang</i>
Test Laboratory:	Bay Area Compliance Laboratories Corp. (Dongguan) No.69 Pulongcun, Puxinhu Industry Area, Tangxia, Dongguan, Guangdong, China Tel: +86-769-86858888 Fax: +86-769-86858891 www.baclcorp.com.cn

TABLE OF CONTENTS

GENERAL INFORMATION.....	3
PRODUCT DESCRIPTION FOR EQUIPMENT UNDER TEST (EUT)	3
OBJECTIVE	3
TEST METHODOLOGY	3
TEST FACILITY	3
SYSTEM TEST CONFIGURATION.....	4
DESCRIPTION OF TEST CONFIGURATION	4
EUT EXERCISE SOFTWARE	4
EQUIPMENT MODIFICATIONS	4
SUPPORT EQUIPMENT LIST AND DETAILS	4
EXTERNAL CABLE.....	4
SUMMARY OF TEST RESULTS	5
APPLICABLE STANDARDS.....	6
DFS REQUIREMENT	6
DFS MEASUREMENT SYSTEM	10
SYSTEM BLOCK DIAGRAM	10
CONDUCTED METHOD	11
RADIATED METHOD.....	12
TEST PROCEDURE	12
TEST RESULTS.....	13
DESCRIPTION OF EUT	13
TEST EQUIPMENT LIST AND DETAILS.....	13
RADAR WAVEFORM CALIBRATION	14
TEST ENVIRONMENTAL CONDITIONS	14
CHANNEL AVAILABILITY CHECK TIME (CAC)	20
TEST PROCEDURE	20
CHANNEL MOVE TIME AND CHANNEL CLOSING TRANSMISSION TIME	23
TEST PROCEDURE	23
TEST RESULTS	23
NON-OCCUPANCY PERIOD	26
TEST PROCEDURE	26
TEST RESULT	26
DETECTION BANDWIDTH.....	27
TEST PROCEDURE	27
TEST RESULT	28
STATISTICAL PERFORMANCE CHECK	32
BRIDGE AND/OR MESH MODE.....	124

GENERAL INFORMATION

Product Description for Equipment under Test (EUT)

The Grandstream Networks, Inc.'s product, model number: GWN7630 (the "EUT") in this report was a *Enterprise 802.11ac Wave-2 4x4 : 4 Wi-Fi Access Point*, rated input voltage: DC 48V form PoE.

**All measurement and test data in this report was gathered from production sample serial number: 190626007 (Assigned by BACL, Dongguan). The EUT was received on 2019-06-07.*

Objective

This report is prepared on behalf of *Grandstream Networks, Inc.* in accordance with Part 2-Subpart J, Part 15-Subparts E of the Federal Communications Commission's rules, and RSS-247, Issue 2, February 2017 of the Innovation, Science and Economic Development Canada.

The objective is to determine compliance with Dynamic Frequency Selection (DFS) of the FCC Part 15, Subpart E, section 15.407 and and RSS-247, Issue 2, February 2017 of the Innovation, Science and Economic Development Canada.

Test Methodology

FCC KDB 905462 D02 UNII DFS Compliance Procedures New Rules v02.

Test Facility

The Test site used by Bay Area Compliance Laboratories Corp. (Dongguan) to collect test data is located on the No.69 Pulongcun, Puxinhu Industry Area, Tangxia, Dongguan, Guangdong, China.

The lab has been recognized as the FCC accredited lab under the KDB 974614 D01 and is listed in the FCC Public Access Link (PAL) database, FCC Registration No. : 897218, the FCC Designation No. : CN1220.

The lab has been recognized by Innovation, Science and Economic Development Canada to test to Canadian radio equipment requirements, the CAB identifier: CN0022.

SYSTEM TEST CONFIGURATION

Description of Test Configuration

The EUT was configured for testing in an engineering mode which was provided by the manufacturer.

EUT Exercise Software

The test was performed under: 'IPOP.exe', which was provided by the manufacturer.

Equipment Modifications

N/A

Support Equipment List and Details

Manufacturer	Description	Model	Serial Number
Dell	Laptop	E6410	00426-OEM-8992662-00497
Dell	Laptop	PP11L	QDS-BRCM133

External Cable

Cable Description	Shielding Type	Ferrite Core	Length (m)	From Port	To
RJ45	NO	NO	10	Laptop	EUT
RJ45	NO	NO	2	Laptop	EUT

SUMMARY OF TEST RESULTS

The following result table represents the list of measurements required under the CFR §47 Part 15.407(h) and RSS-247, Issue 2, February 2017, KDB: 905462 D02 UNII DFS Compliance Procedures New Rules v02

Items	Description of Test	Result
Detection Bandwidth	UNII Detection Bandwidth	Compliance
Performance Requirements Check	Initial Channel Availability Check Time (CAC)	Compliance
	Radar Burst at the Beginning of the CAC	Compliance
	Radar Burst at the End of the CAC	Compliance
In-Service Monitoring	Channel Move Time	Compliance
	Channel Closing Transmission Time	Compliance
	Non-Occupancy Period	Compliance
Radar Detection	Statistical Performance Check	Compliance

APPLICABLE STANDARDS

DFS Requirement

CFR §47 Part 15.407(h)& RSS-247, Issue 2, February 2017

FCC KDB 905462 D02 UNII DFS Compliance Procedures New Rules v02

Table 1: Applicability of DFS Requirements Prior to Use of a Channel

Requirement	Operational Mode		
	Master	Client Without Radar Detection	Client With Radar Detection
<i>Non-Occupancy Period</i>	Yes	Not required	Yes
<i>DFS Detection Threshold</i>	Yes	Not required	Yes
<i>Channel Availability Check Time</i>	Yes	Not required	Not required
<i>U-NII Detection Bandwidth</i>	Yes	Not required	Yes

Table 2: Applicability of DFS requirements during normal operation

Requirement	Operational Mode	
	Master Device or Client with Radar Detection	Client Without Radar Detection
<i>DFS Detection Threshold</i>	Yes	Not required
<i>Channel Closing Transmission Time</i>	Yes	Yes
<i>Channel Move Time</i>	Yes	Yes
<i>U-NII Detection Bandwidth</i>	Yes	Not required

Additional requirements for devices with multiple bandwidth modes	Master Device or Client with Radar Detection	Client Without Radar Detection
<i>U-NII Detection Bandwidth and Statistical Performance Check</i>	All BW modes must be tested	Not required
<i>Channel Move Time and Channel Closing Transmission Time</i>	Test using widest BW mode available	Test using the widest BW mode available for the link
<i>All other tests</i>	Any single BW mode	Not required
Note: Frequencies selected for statistical performance check (Section 7.8.4) should include several frequencies within the radar detection bandwidth and frequencies near the edge of the radar detection bandwidth. For 802.11 devices it is suggested to select frequencies in each of the bonded 20 MHz channels and the channel center frequency.		

Table 3: DFS Detection Thresholds for Master Devices and Client Devices With Radar Detection

Maximum Transmit Power	Value (See Notes 1, 2, and 3)
EIRP \geq 200 milliwatt	-64 dBm
EIRP < 200 milliwatt and power spectral density < 10 dBm/MHz	-62 dBm
EIRP < 200 milliwatt that do not meet the power spectral density requirement	-64 dBm
<p>Note 1: This is the level at the input of the receiver assuming a 0 dBi receive antenna.</p> <p>Note 2: Throughout these test procedures an additional 1 dB has been added to the amplitude of the test transmission waveforms to account for variations in measurement equipment. This will ensure that the test signal is at or above the detection threshold level to trigger a DFS response.</p> <p>Note 3: EIRP is based on the highest antenna gain. For MIMO devices refer to KDB Publication 662911 D01.</p>	

Table 4: DFS Response Requirement Values

Parameter	Value
<i>Non-occupancy period</i>	Minimum 30 minutes
<i>Channel Availability Check Time</i>	60 seconds
<i>Channel Move Time</i>	10 seconds See Note 1.
<i>Channel Closing Transmission Time</i>	200 milliseconds + an aggregate of 60 milliseconds over remaining 10 second period. See Notes 1 and 2.
<i>U-NII Detection Bandwidth</i>	Minimum 100% of the U- NII 99% transmission power bandwidth. See Note 3.
<p>Note 1: <i>Channel Move Time</i> and the <i>Channel Closing Transmission Time</i> should be performed with Radar Type 0. The measurement timing begins at the end of the Radar Type 0 burst.</p> <p>Note 2: The <i>Channel Closing Transmission Time</i> is comprised of 200 milliseconds starting at the beginning of the <i>Channel Move Time</i> plus any additional intermittent control signals required to facilitate a <i>Channel move</i> (an aggregate of 60 milliseconds) during the remainder of the 10 second period. The aggregate duration of control signals will not count quiet periods in between transmissions.</p> <p>Note 3: During the <i>U-NII Detection Bandwidth</i> detection test, radar type 0 should be used. For each frequency step the minimum percentage of detection is 90 percent. Measurements are performed with no data traffic.</p>	

Table 5 – Short Pulse Radar Test Waveforms

Radar Type	Pulse Width (μsec)	PRI (μsec)	Number of Pulses	Minimum Percentage of Successful Detection	Minimum Number of Trials
0	1	1428	18	See Note 1	See Note 1
1	1	Test A: 15 unique PRI values randomly selected from the list of 23 PRI values in Table 5a	Roundup $\left\{ \left(\frac{1}{360} \right) \cdot \left(\frac{19 \cdot 10^6}{PRI_{\mu sec}} \right) \right\}$	60%	30
		Test B: 15 unique PRI values randomly selected within the range of 518-3066 μsec, with a minimum increment of 1 μsec, excluding PRI values selected in Test A			
2	1-5	150-230	23-29	60%	30
3	6-10	200-500	16-18	60%	30
4	11-20	200-500	12-16	60%	30
Aggregate (Radar Types 1-4)				80%	120
Note 1: Short Pulse Radar Type 0 should be used for the detection bandwidth test, channel move time, and channel closing time tests.					

A minimum of 30 unique waveforms are required for each of the Short Pulse Radar Types 2 through 4. If more than 30 waveforms are used for Short Pulse Radar Types 2 through 4, then each additional waveform must also be unique and not repeated from the previous waveforms. If more than 30 waveforms are used for Short Pulse Radar Type 1, then each additional waveform is generated with Test B and must also be unique and not repeated from the previous waveforms in Tests A or B.

For example if in Short Pulse Radar Type 1 Test B a PRI of 3066 usec is selected, the number of pulses

would be $\text{Roundup} \left\{ \left(\frac{1}{360} \right) \cdot \left(\frac{19 \cdot 10^6}{3066} \right) \right\} = \text{Roundup} \{17.2\} = 18.$

Table 5a - Pulse Repetition Intervals Values for Test A

Pulse Repetition Frequency Number	Pulse Repetition Frequency (Pulses Per Second)	Pulse Repetition Interval (Microseconds)
1	1930.5	518
2	1858.7	538
3	1792.1	558
4	1730.1	578
5	1672.2	598
6	1618.1	618
7	1567.4	638
8	1519.8	658
9	1474.9	678
10	1432.7	698
11	1392.8	718
12	1355	738
13	1319.3	758
14	1285.3	778
15	1253.1	798
16	1222.5	818
17	1193.3	838
18	1165.6	858
19	1139	878
20	1113.6	898
21	1089.3	918
22	1066.1	938
23	326.2	3066

The aggregate is the average of the percentage of successful detections of Short Pulse Radar Types 1-4. For example, the following table indicates how to compute the aggregate of percentage of successful detections.

Radar Type	Number of Trials	Number of Successful Detections	Minimum Percentage of Successful Detection
1	35	29	82.9%
2	30	18	60%
3	30	27	90%
4	50	44	88%
Aggregate $(82.9\% + 60\% + 90\% + 88\%)/4 = 80.2\%$			

Table 6 – Long Pulse Radar Test Waveform

Radar Type	Pulse Width (μsec)	Chirp Width (MHz)	PRI (μsec)	Number of Pulses per <i>Burst</i>	Number of <i>Bursts</i>	Minimum Percentage of Successful Detection	Minimum Number of Trials
5	50-100	5-20	1000-2000	1-3	8-20	80%	30

Table 7 – Frequency Hopping Radar Test Waveform

Radar Type	Pulse Width (μsec)	PRI (μsec)	Pulses per Hop	Hopping Rate (kHz)	Hopping Sequence Length (msec)	Minimum Percentage of Successful Detection	Minimum Number of Trials
6	1	333	9	0.333	300	70%	30

DFS Measurement System

BACL DFS measurement system consists of two subsystems: (1) The radar signal generating subsystem and (2) the traffic monitoring subsystem.

System Block Diagram

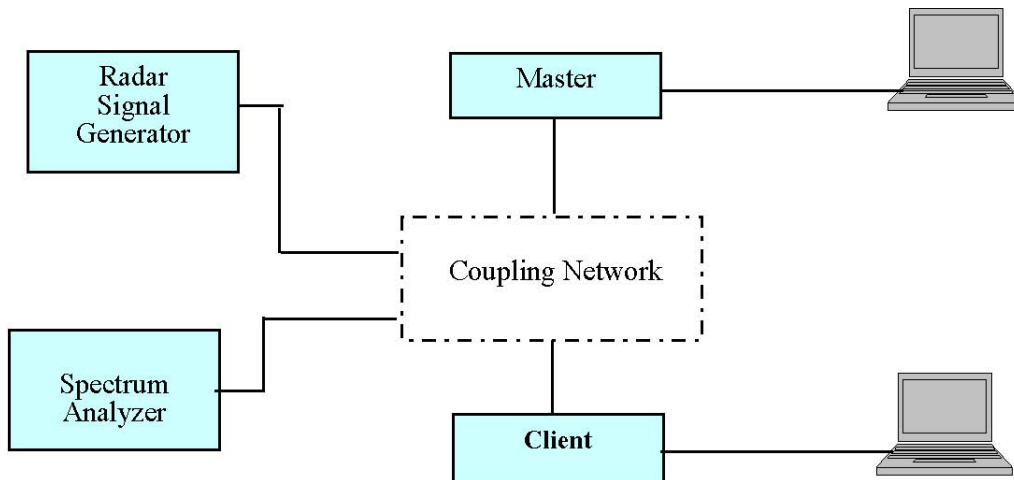

Conducted Method

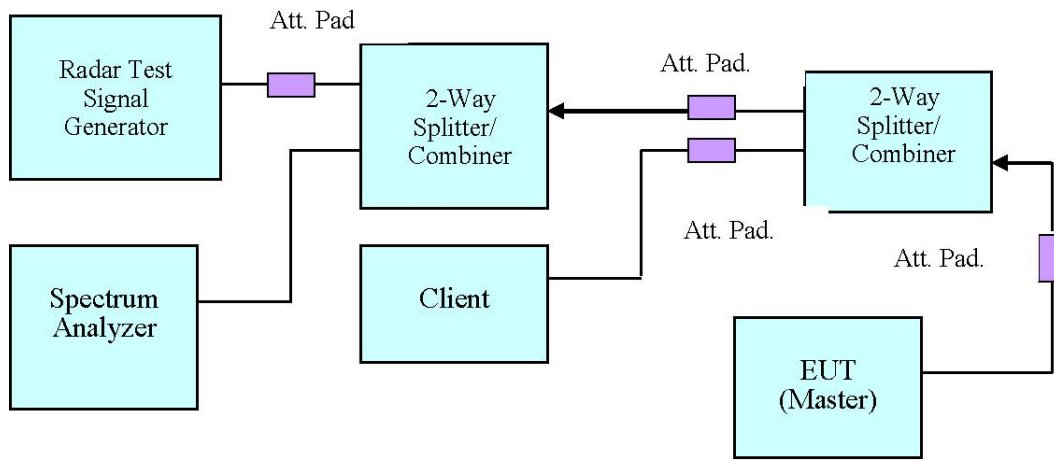

Setup for Master with injection at the Master

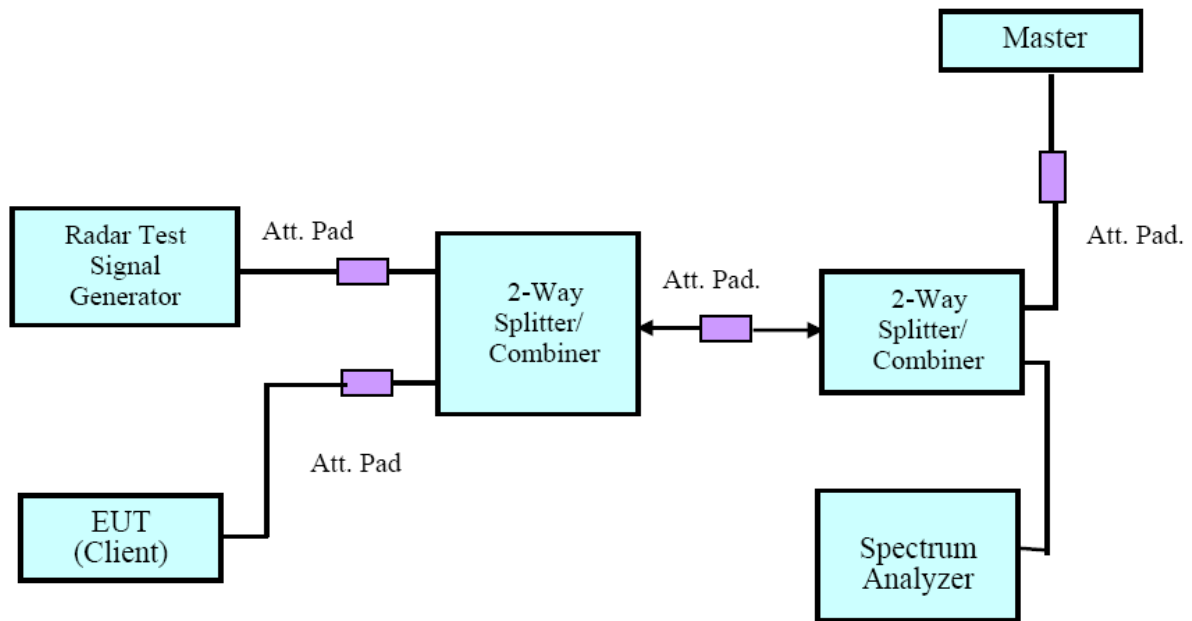

Setup for Client with injection at the Master

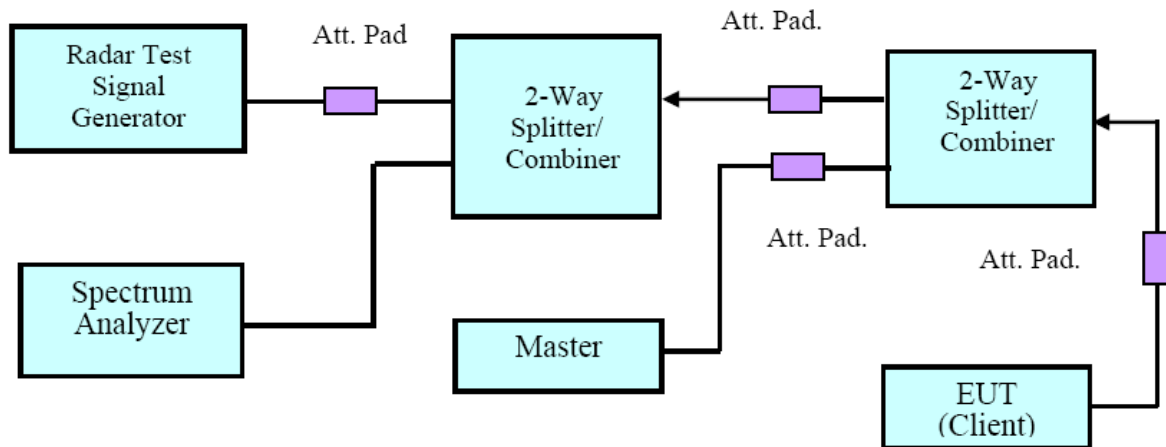

Setup for Client with injection at the Client

Radiated Method

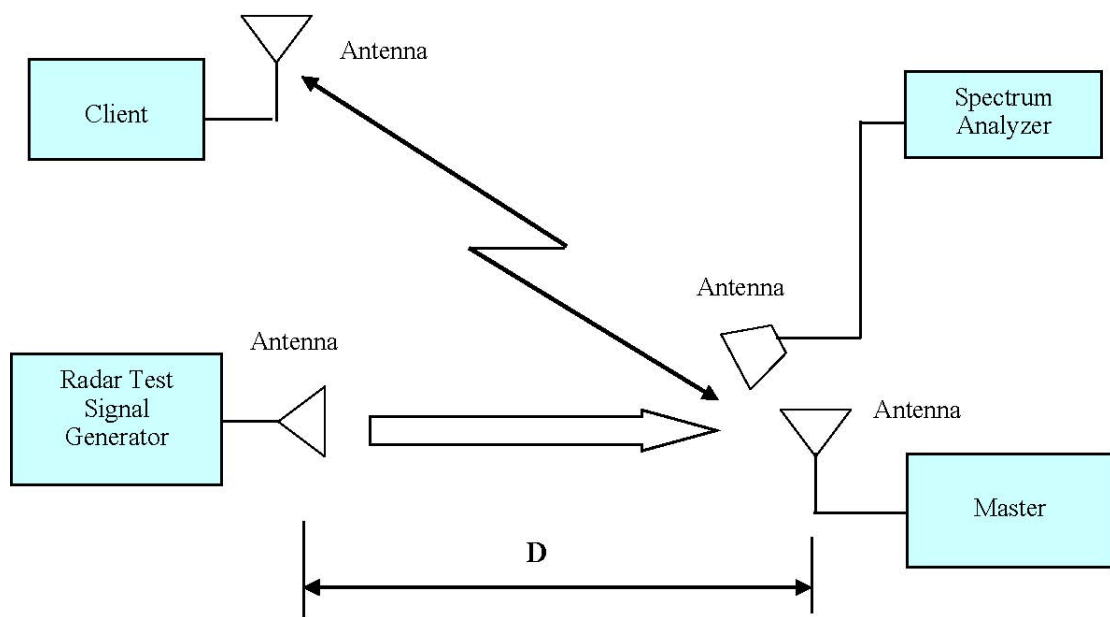

Test Procedure

A spectrum analyzer is used as a monitor verifies that the EUT status including Channel Closing Transmission Time and Channel Move Time, and does not transmit on a Channel during the Non-Occupancy Period after the diction and Channel move. It is also used to monitor EUT transmissions during the Channel Availability Check Time.

TEST RESULTS

Description of EUT

The calibrated radiated DFS detection threshold level is set to -64 dBm is more stringent.

WLAN traffic is generated by streaming the video file TestFile.mpg, this file is used by IP and Frame based systems for loading the test channel during the In-service compliance testing of the U-NII device. The file is streamed from the Access Point to the Client in full motion video mode using the media player with the V2.61 Codec package.

Test Equipment List and Details

Manufacturer	Description	Model	Serial Number	Calibration Date	Calibration Due Date
National Instruments	NI PXI-1042 8-Slot chassis	PXI-1042	VOBX40FBD	N/A	N/A
National Instruments	Arbitrary Waveform Generator	PXI-5421	N/A	N/A	N/A
National Instruments	RF Upconverter	PXI-5610	N/A	N/A	N/A
ASCOR	Upconverter	AS-7202	N/A	N/A	N/A
Agilent	Spectrum Analyzer	E4440A	SG43360054	2018-12-08	2019-12-08
Agilent	Spectrum Analyzer	E4440A	SG43360054	2018-12-08	2019-12-08
Ditorn	Splitter/Combiner	D3C4080	SN2244	N/A	N/A
TDK RF	Horn Antenna	HRN-0118	130 084	2017-01-05	2020-01-04
ETS LINDGREN	Horn Antenna	3115	000 527 35	2017-01-05	2020-01-04

* **Statement of Traceability:** Bay Area Compliance Laboratories Corp. (Dongguan) attests that all calibrations have been performed, traceable to National Primary Standards and International System of Units (SI).

Radar Waveform Calibration

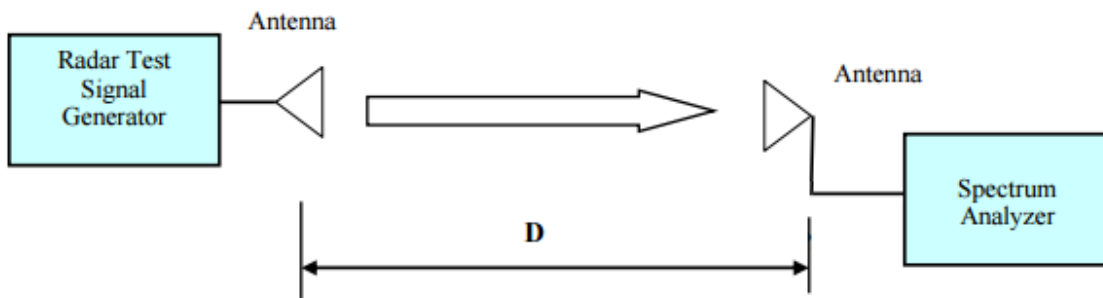

Radiated Calibration Setup Block Diagram

Test Environmental Conditions

Temperature:	27.8~28.4 °C
Relative Humidity:	35~59 %
ATM Pressure:	101.2 kPa
Tester:	Lucy Lu
Test Date:	2019-06-28~2019-10-12

Plots of Radar Waveforms

5530 MHz:

Radar Type 0

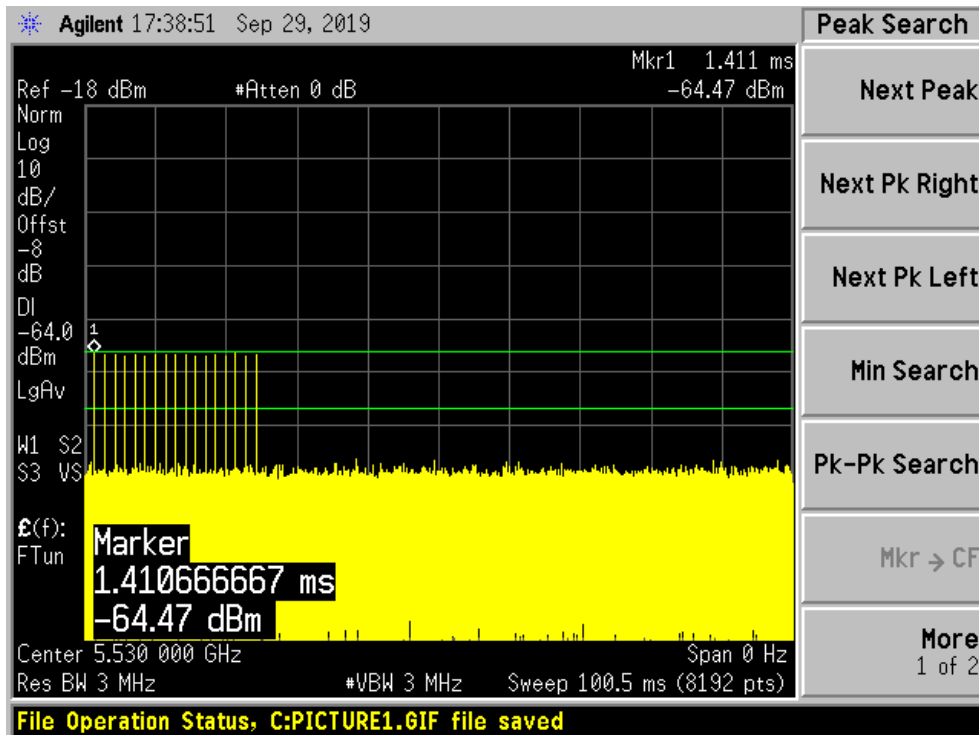

Radar Type 1A

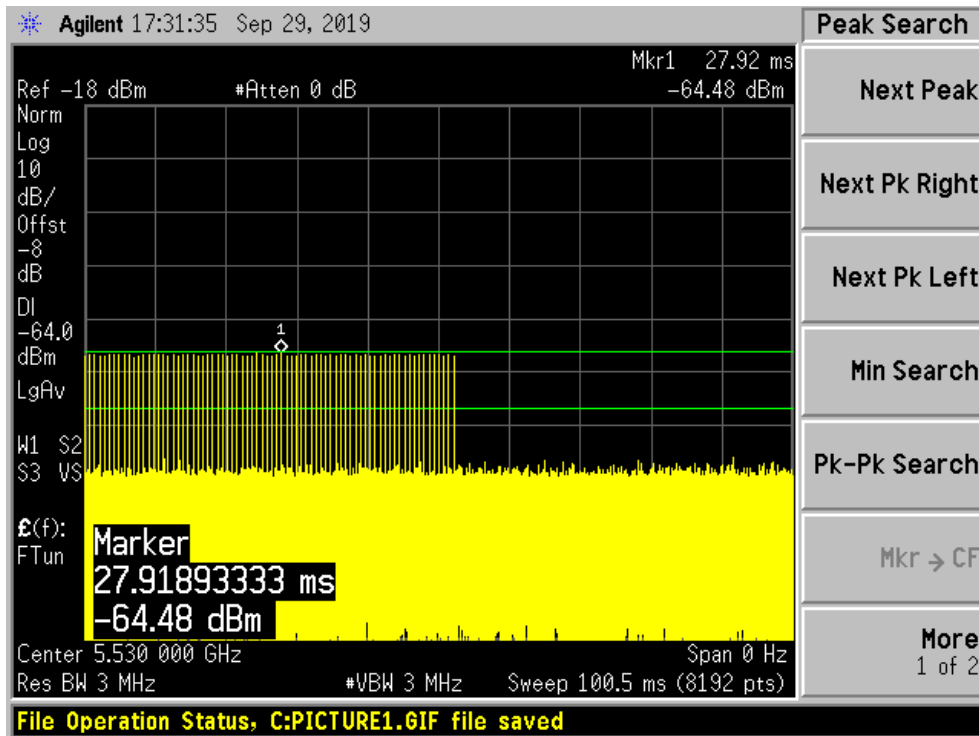

Radar Type 1B

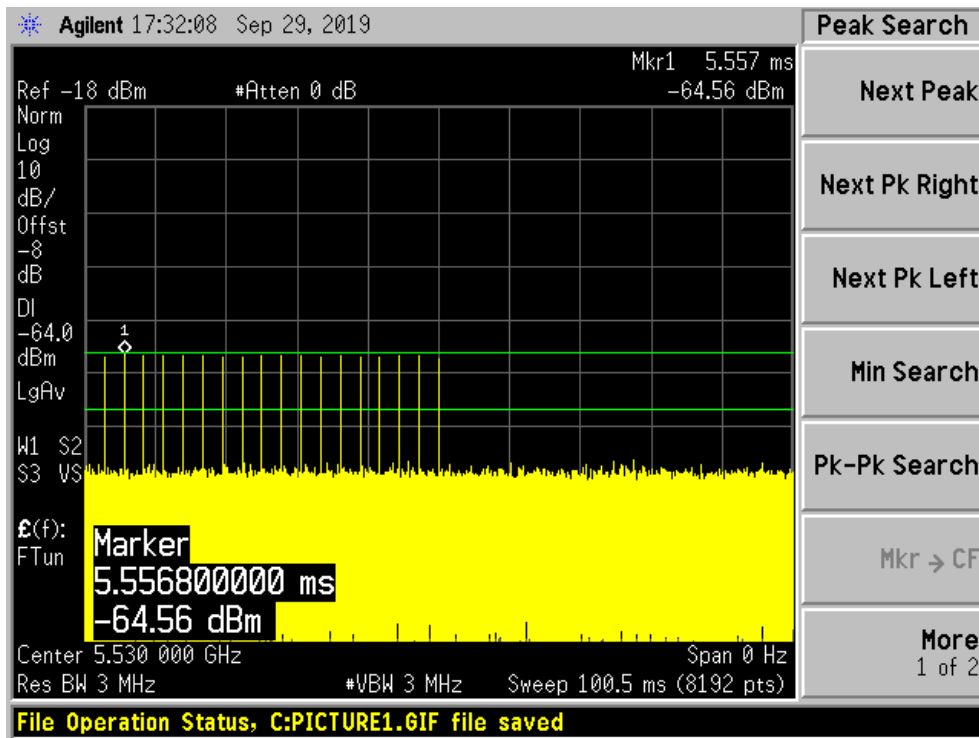

Radar Type 2

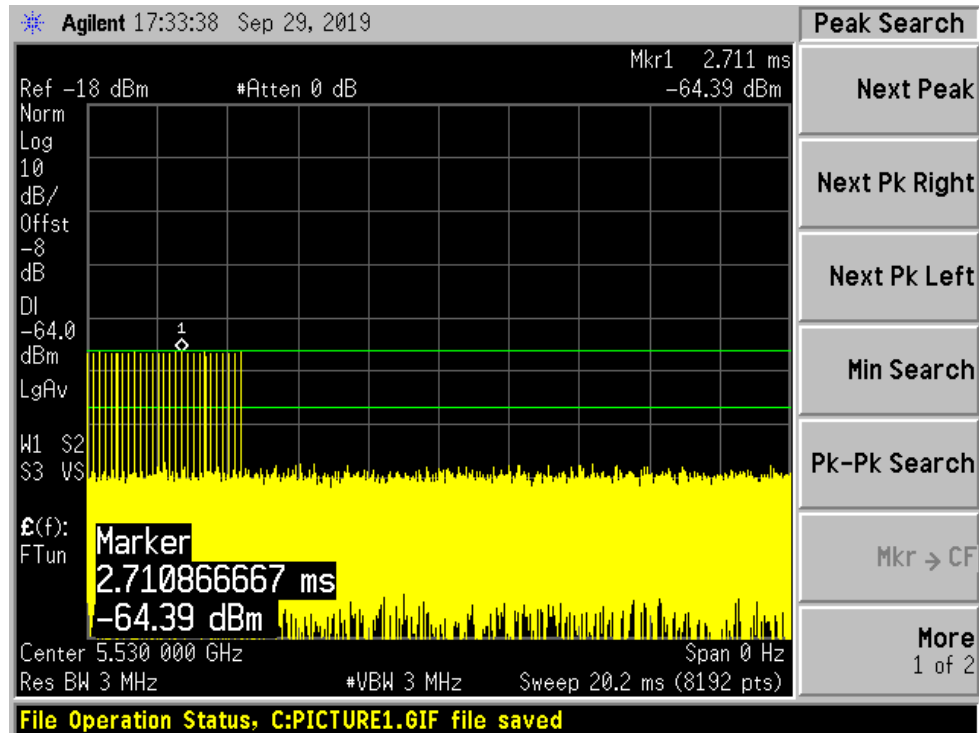

Radar Type 3

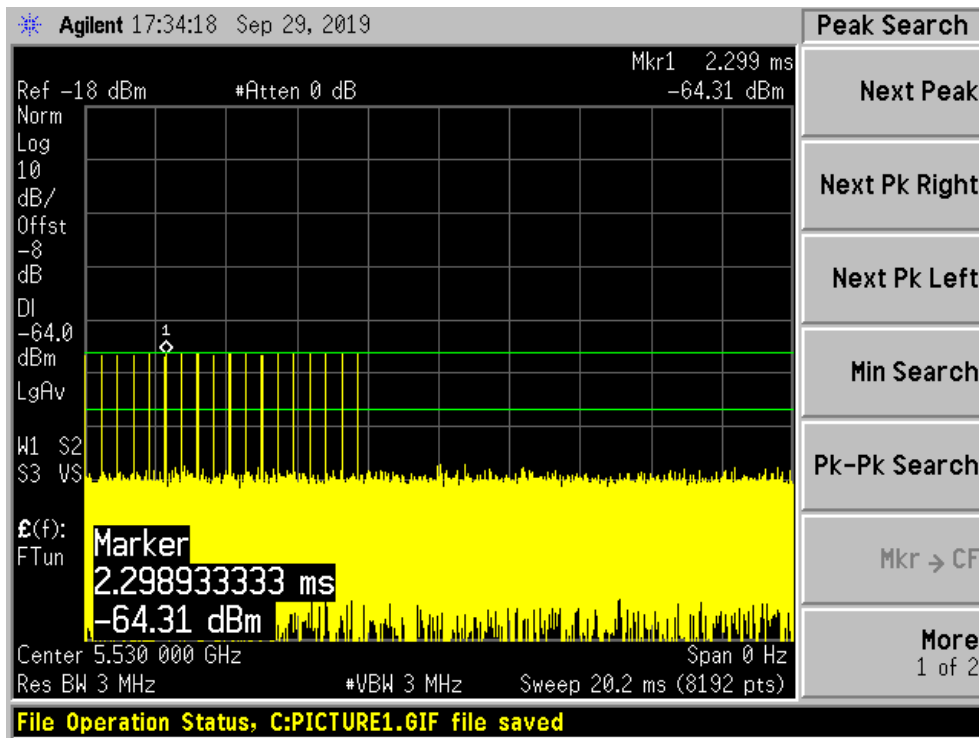

Radar Type 4

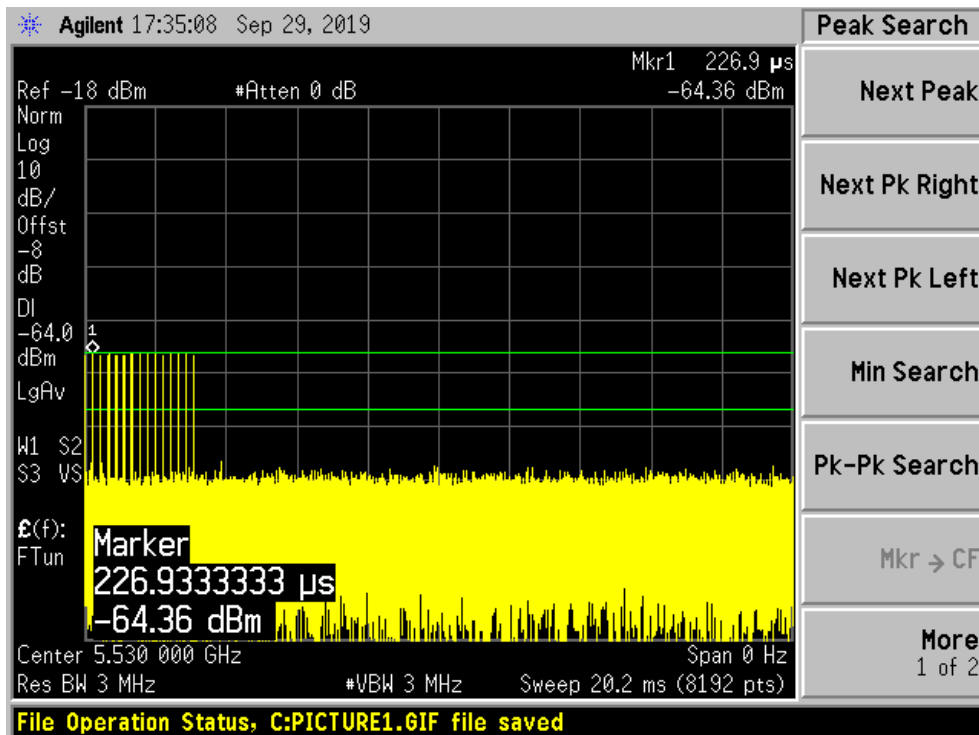

Radar Type 5 Case 1

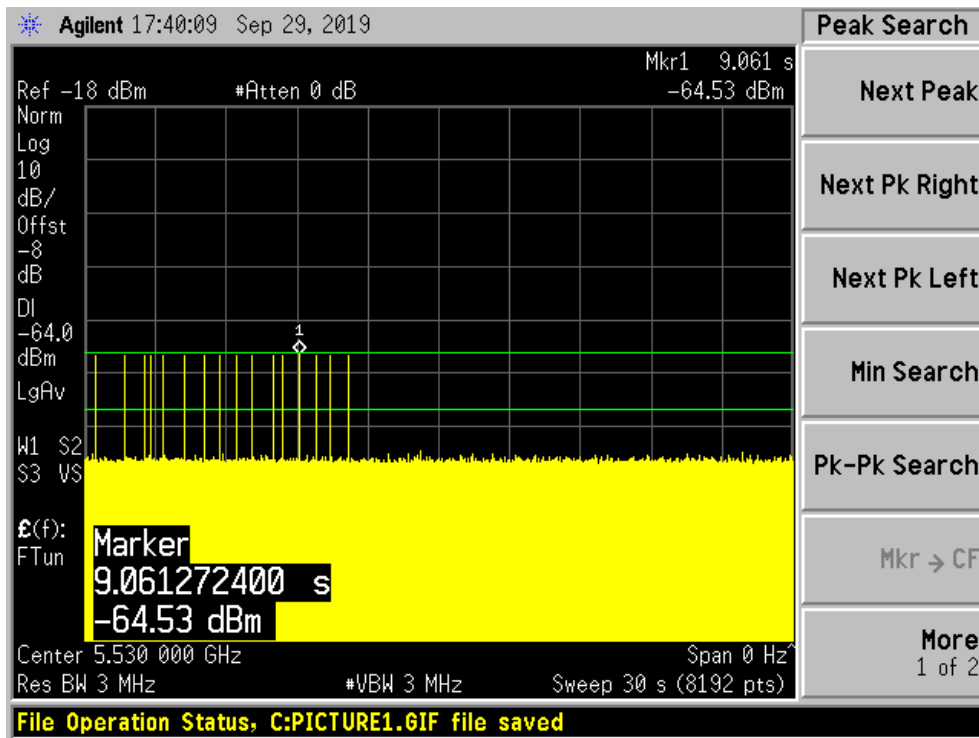

Radar Type 5 Case 2

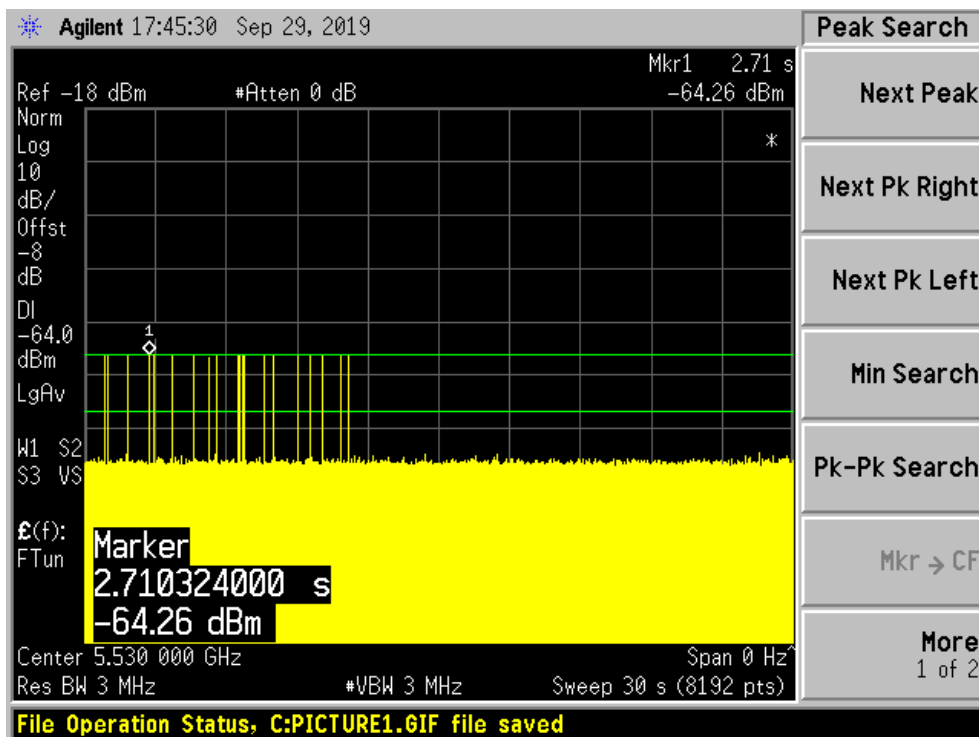

Radar Type 5 Case 3

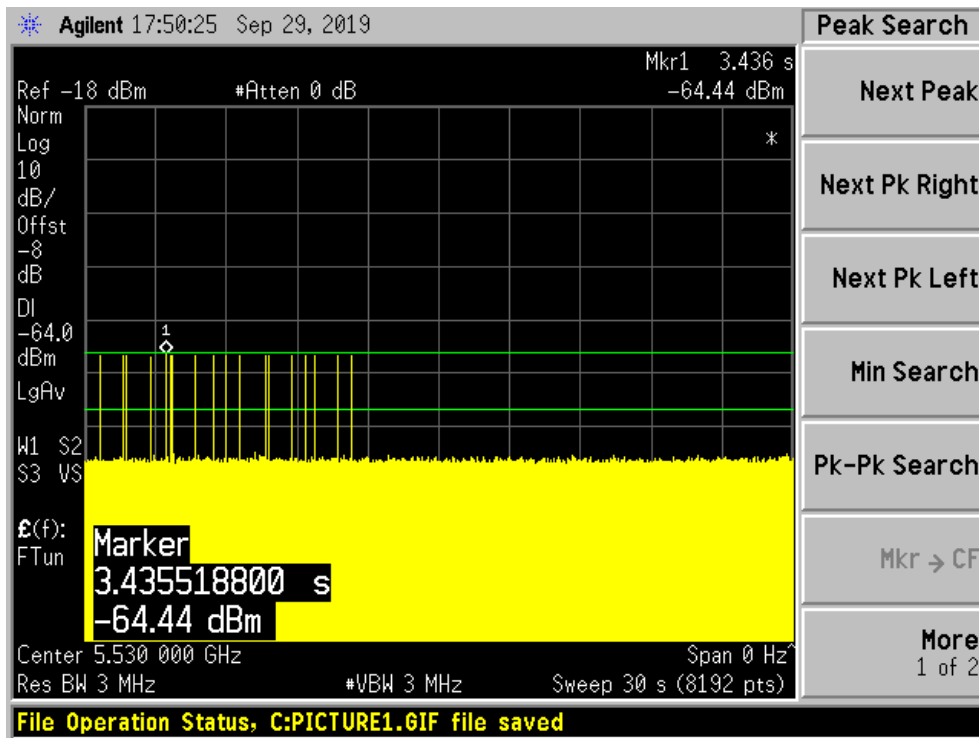

Radar Type 6

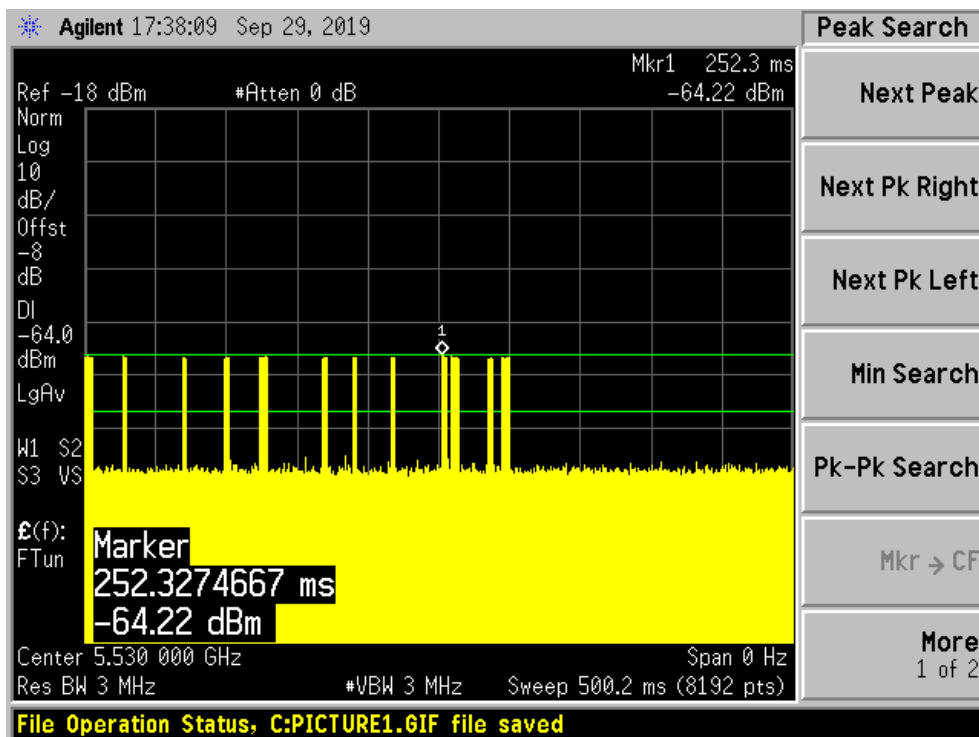

CHANNEL AVAILABILITY CHECK TIME (CAC)

Test Procedure

- 1) Channel Availability Check Time (CAC)
- 2) With link established on channel, apply a radar signal within 0~6 seconds after the initial power-up period; monitor the transmissions on channel from the spectrum analyzer.
- 3) Reboot EUT, with a link established on channel, apply a radar signal within 54~60 seconds after the initial power-up period, and monitor the transmission on channel from the spectrum analyzer.

EUT Initial power-up Cycle Time

Test Frequency (MHz)	EUT initial Power-up cycle (Second)
5500	89.2

Results:

Timing of Radar Burst	Spectrum Analyzer Display
No Radar Triggered	Transmission begin after power-up cycle +60 seconds CAC
Within 6 seconds of the CAC starting	No transmission
Within the last 6 seconds of the CAC	No transmission

Please refer to the following plots.

Radio,5500 MHz:

Plot of without Radar signal applied

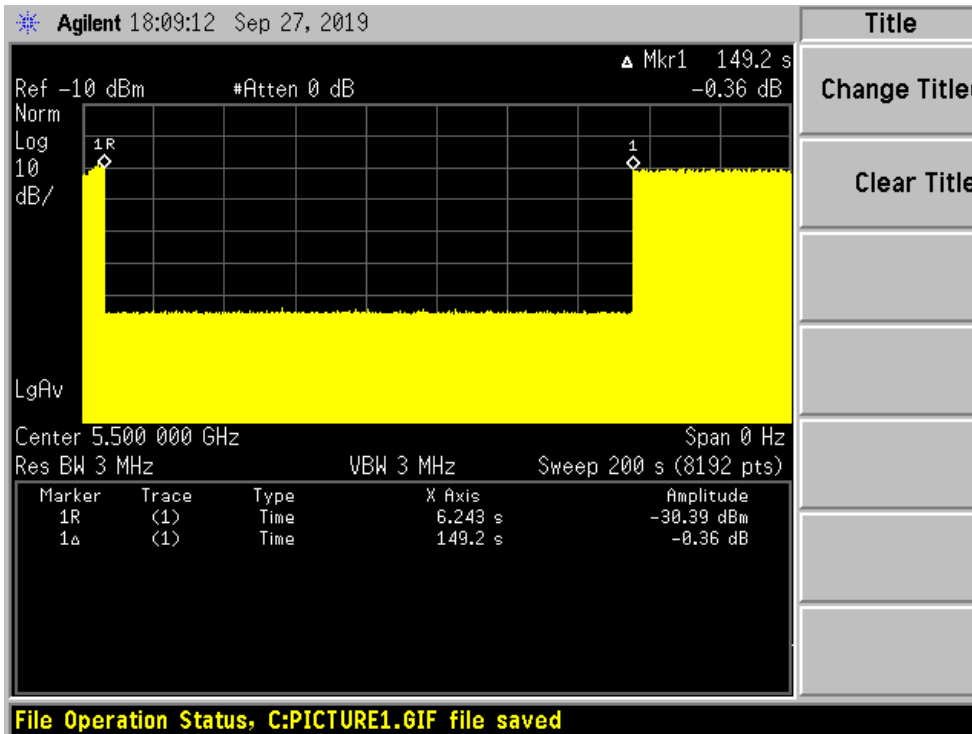

Note: The power-up cycle is 89.2 seconds.

Plot of Radar signal applied within 6 seconds of start of CAC

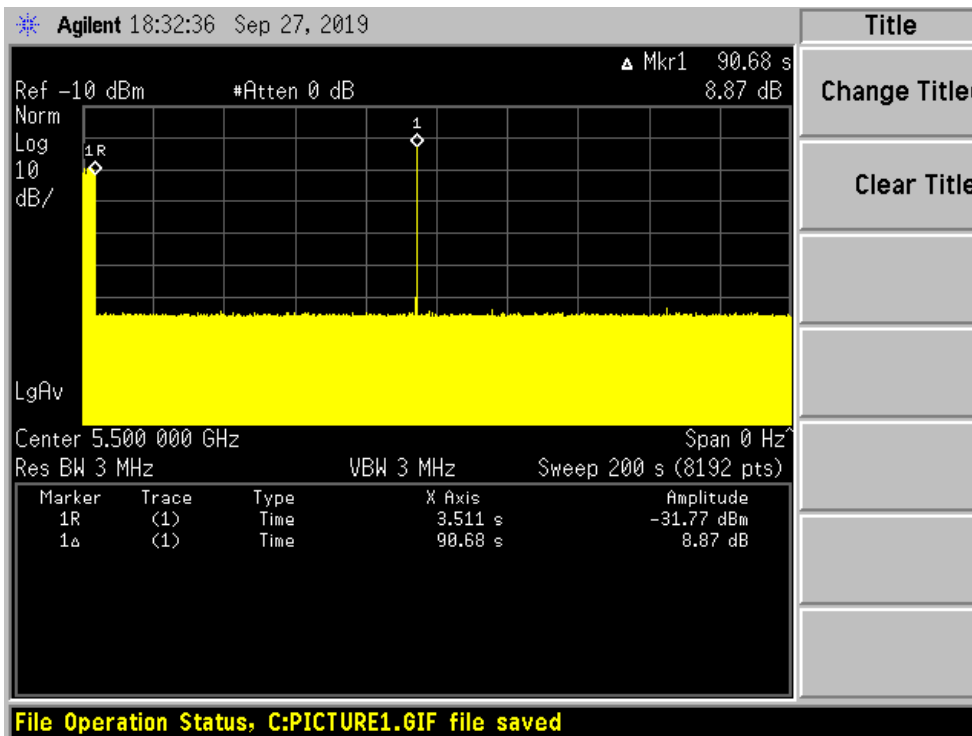

No transmissions found after radar signal applied.

Plot of Radar signal applied at the end of 6 seconds of CAC

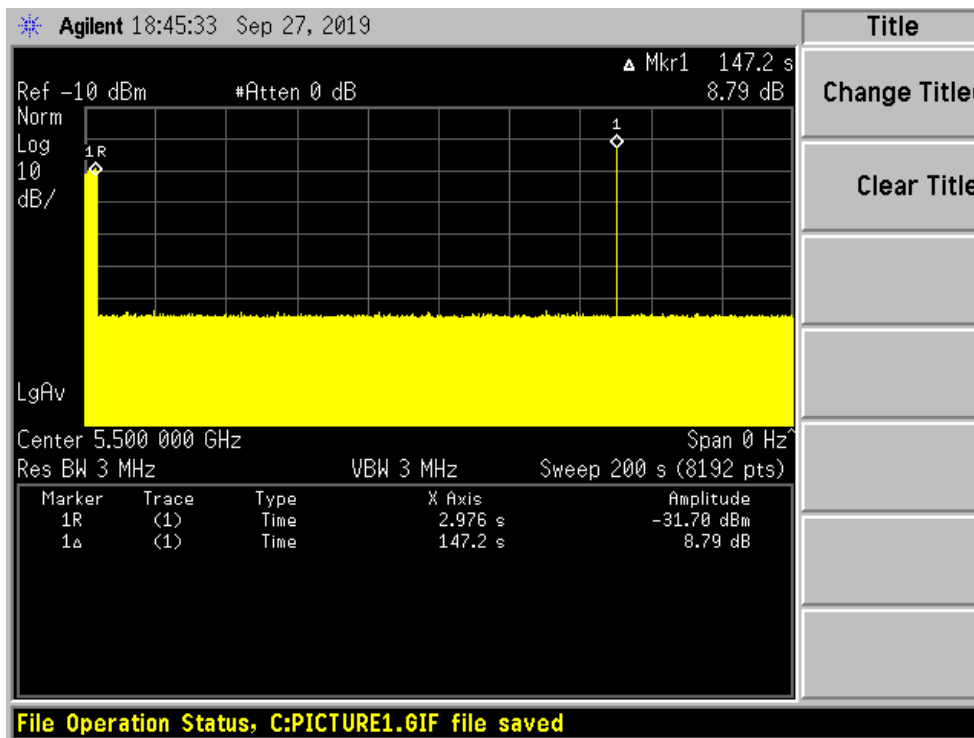

No transmissions found after radar signal applied.

CHANNEL MOVE TIME AND CHANNEL CLOSING TRANSMISSION TIME

Test Procedure

Perform type 0 short pulse radar waveform, repeat using a long pulse radar type5 waveform.
The aggregate channel closing transmission time is calculated as follows:

Aggregate Transmission Time = N*Dwell Time

N is the number of spectrum analyzer bins showing a device transmission Dwell Time is the dwell time per bin (i.e. Dwell Time = S/B, S is the sweep time and B is the number of bin, i.e. 8192)

Test Results

Frequency (MHz)	Bandwidth (MHz)	Radar Type	Results
5530	80	Type 0	Compliant

Please refer to the following tables and plots.

5530 MHz

Type 0 radar channel move time result:

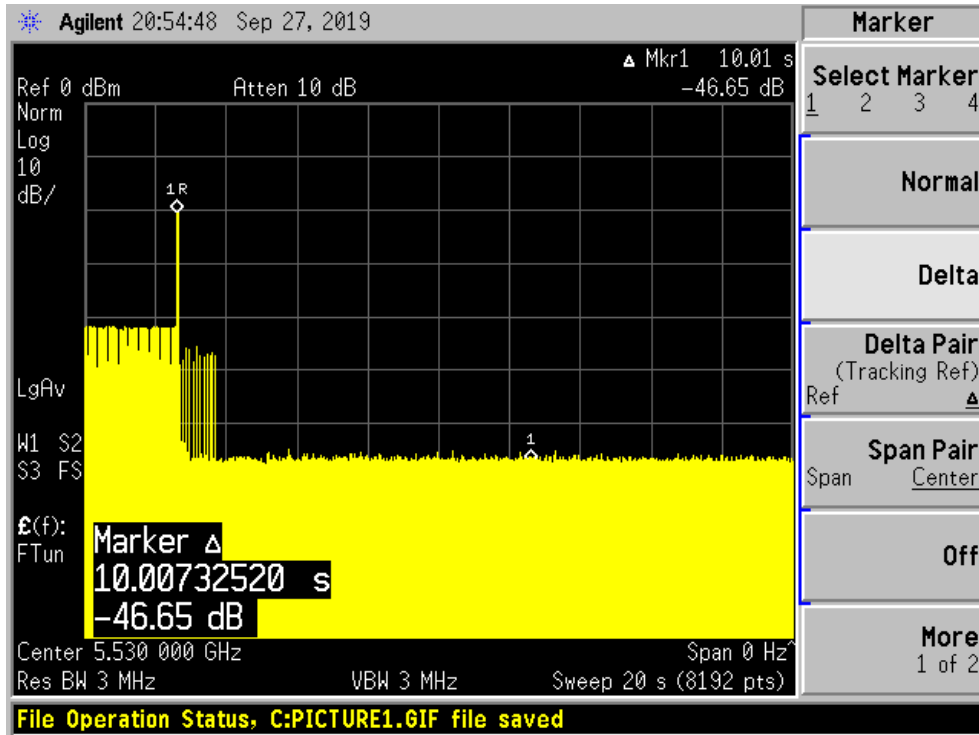

Type0 radar channel closing transmission time result:

Transmission After 200ms	Aggregate Transmission Time After 200ms Delay (ms)	Limit for Aggregate Transmission Time After 200ms Delay (ms)	Result
Yes	43.95	60	Pass

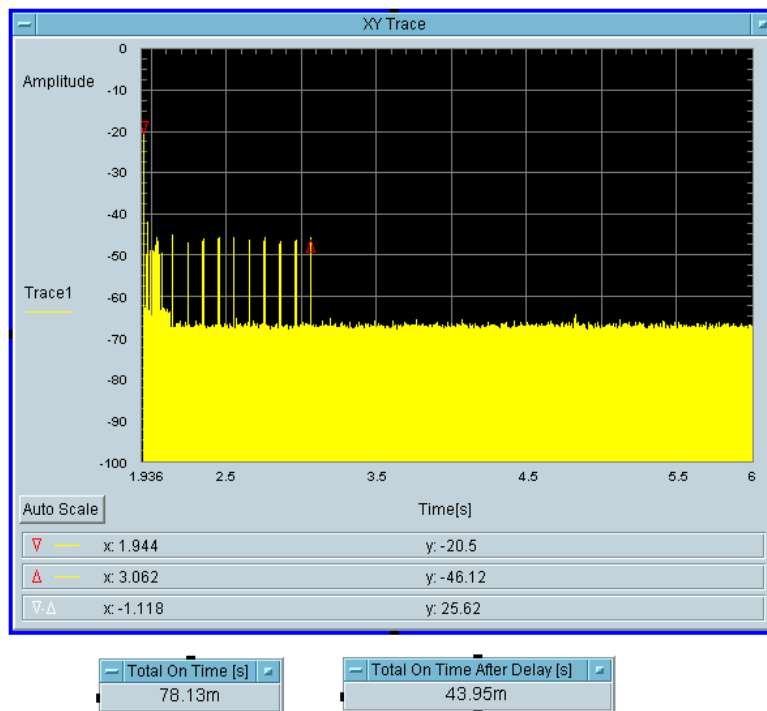

NON-OCCUPANCY PERIOD

Test Procedure

Measure the EUT for more than 30 minutes following the channel close/move time to verify that the EUT does not resume any transmissions on this channel. Provide one plot to demonstrate no transmission on the channel for the non-occupancy period (30 minutes observation time)

Test Result

Frequency(MHz)	Bandwidth (MHz)	Spectrum Analyzer Display
5530	80	No transmission within 30 minutes

Please refer to the following plots.

5530 MHz

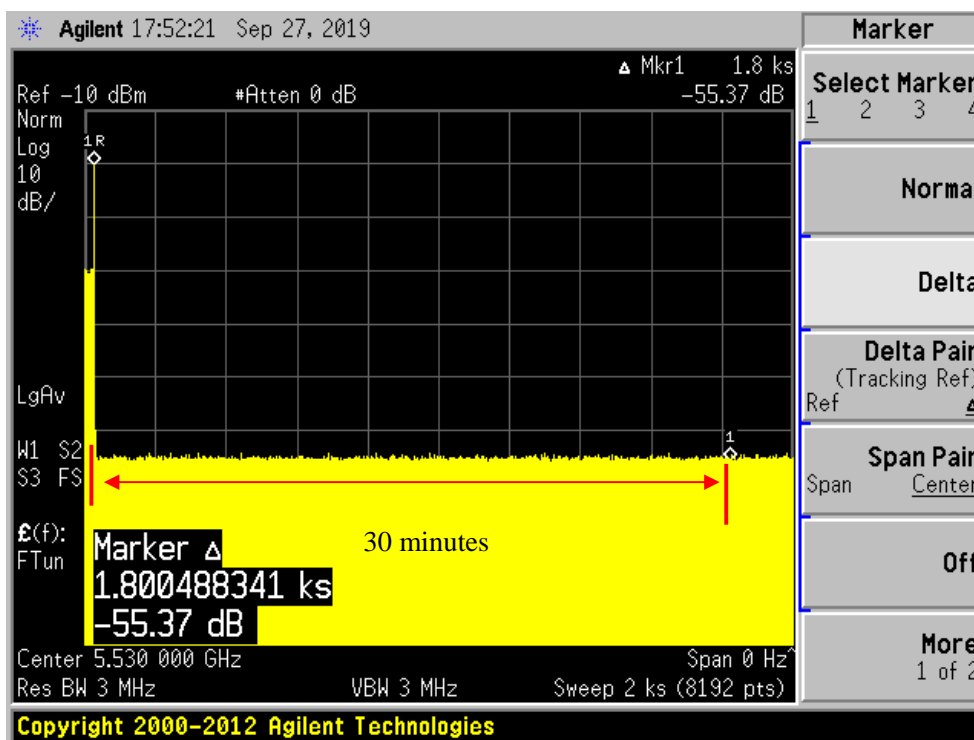

DETECTION BANDWIDTH

Test Procedure

Performed with Type 0 radar waveforms

Starting at the center frequency of the UUT operating *Channel*, increase the radar frequency in 5 MHz steps, repeating the above test sequence, until the detection rate falls below the *U-NII Detection Bandwidth* criterion specified in **Table 4**. Repeat this measurement in 1MHz steps at frequencies 5 MHz below where the detection rate begins to fall. Record the highest frequency (denote as F_H) at which detection is greater than or equal to the *U-NII Detection Bandwidth* criterion. Recording the detection rate at frequencies above F_H is not required to demonstrate compliance.

Starting at the center frequency of the UUT operating *Channel*, decrease the radar frequency in 5 MHz steps, repeating the above test sequence, until the detection rate falls below the *U-NII Detection Bandwidth* criterion specified in **Table 4**. Repeat this measurement in 1MHz steps at frequencies 5 MHz above where the detection rate begins to fall. Record the lowest frequency (denote as F_L) at which detection is greater than or equal to the *U-NII Detection Bandwidth* criterion. Recording the detection rate at frequencies below F_L is not required to demonstrate compliance.

The *U-NII Detection Bandwidth* is calculated as follows:

$$U-NII\ Detection\ Bandwidth = F_H - F_L$$

The *U-NII Detection Bandwidth* must meet the *U-NII Detection Bandwidth* criterion specified in **Table 4**. Otherwise, the UUT does not comply with DFS requirements. This is essential to ensure that the UUT is capable of detecting *Radar Waveforms* across the same frequency spectrum that contains the significant energy from the system. In the case that the *U-NII Detection Bandwidth* is greater than or equal to the 99 percent power bandwidth for the measured F_H and F_L , the test can be truncated and the *U-NII Detection Bandwidth* can be reported as the measured F_H and F_L .

Test Result

Frequency (MHz)	Bandwidth Systems (MHz)	F _L (MHz)	F _H (MHz)	Detection Bandwidth (MHz)	99% Occupied Bandwidth (MHz)	Minimum Limit	Result
5500	20	5490	5510	20	17.63	100%	Compliance
5510	40	5490	5530	40	36.28	100%	Compliance
5530	80	5490	5570	80	75.39	100%	Compliance

Please refer to the following tables and plots.

Results of Detection Bandwidth:

20MHz Bandwidth, EUT Frequency = 5500MHz											
DFS Detection Trials (1 = Detected, 0 = No Detected)											
Radar Frequency (MHz)	1	2	3	4	5	6	7	8	9	10	Detection Rate (%)
5490(F_L)	1	1	1	1	1	1	1	1	1	1	100 %
5491	1	1	1	1	1	1	1	1	1	1	100 %
5492	1	1	1	1	1	1	1	1	1	1	100 %
5493	1	1	1	1	1	1	1	1	1	1	100 %
5494	1	1	1	1	1	1	1	1	1	1	100 %
5495	1	1	1	1	1	1	1	1	1	1	100 %
5500	1	1	1	1	1	1	1	1	1	1	100 %
5505	1	1	1	1	1	1	1	1	1	1	100 %
5506	1	1	1	1	1	1	1	1	1	1	100 %
5507	1	1	1	1	1	1	1	1	1	1	100 %
5508	1	1	1	1	1	1	1	1	1	1	100 %
5509	1	1	1	1	1	1	1	1	1	1	100 %
5510(F_H)	1	1	1	1	1	1	1	1	1	1	100 %
Detection Bandwidth = F _H - F _L = 5510-5490 = 20 MHz											
EUT 99% BW = 17.63 MHz;											Result: Pass

40MHz Bandwidth, EUT Frequency = 5510 MHz											
DFS Detection Trials (1 = Detected, 0 = No Detected)											
Radar Frequency (MHz)	1	2	3	4	5	6	7	8	9	10	Detection Rate (%)
5490(F_L)	1	1	1	1	1	1	1	1	1	1	100 %
5491	1	1	1	1	1	1	1	1	1	1	100 %
5492	1	1	1	1	1	1	1	1	1	1	100 %
5493	1	1	1	1	1	1	1	1	1	1	100 %
5494	1	1	1	1	1	1	1	1	1	1	100 %
5495	1	1	1	1	1	1	1	1	1	1	100 %
5500	1	1	1	1	1	1	1	1	1	1	100 %
5505	1	1	1	1	1	1	1	1	1	1	100 %
5510	1	1	1	1	1	1	1	1	1	1	100 %
5515	1	1	1	1	1	1	1	1	1	1	100 %
5520	1	1	1	1	1	1	1	1	1	1	100 %
5525	1	1	1	1	1	1	1	1	1	1	100 %
5526	1	1	1	1	1	1	1	1	1	1	100 %
5527	1	1	1	1	1	1	1	1	1	1	100 %
5528	1	1	1	1	1	1	1	1	1	1	100 %
5529	1	1	1	1	1	1	1	1	1	1	100 %
5530(F_H)	1	1	1	1	1	1	1	1	1	1	100 %
Detection Bandwidth = F _H – F _L = 5530-5490 = 40 MHz											
EUT 99% BW = 36.28 MHz;										Result: Pass	

80MHz Bandwidth, EUT Frequency = 5530 MHz											
DFS Detection Trials (1 = Detected, 0 = No Detected)											
Radar Frequency (MHz)	1	2	3	4	5	6	7	8	9	10	Detection Rate (%)
5490(F_L)	1	1	1	1	1	1	1	1	1	1	100 %
5491	1	1	1	1	1	1	1	1	1	1	100 %
5492	1	1	1	1	1	1	1	1	1	1	100 %
5493	1	1	1	1	1	1	1	1	1	1	100 %
5494	1	1	1	1	1	1	1	1	1	1	100 %
5495	1	1	1	1	1	1	1	1	1	1	100 %
5500	1	1	1	1	1	1	1	1	1	1	100 %
5505	1	1	1	1	1	1	1	1	1	1	100 %
5510	1	1	1	1	1	1	1	1	1	1	100 %
5515	1	1	1	1	1	1	1	1	1	1	100 %
5520	1	1	1	1	1	1	1	1	1	1	100 %
5525	1	1	1	1	1	1	1	1	1	1	100 %
5530	1	1	1	1	1	1	1	1	1	1	100 %
5535	1	1	1	1	1	1	1	1	1	1	100 %
5540	1	1	1	1	1	1	1	1	1	1	100 %
5545	1	1	1	1	1	1	1	1	1	1	100 %
5550	1	1	1	1	1	1	1	1	1	1	100 %
5555	1	1	1	1	1	1	1	1	1	1	100 %
5560	1	1	1	1	1	1	1	1	1	1	100 %
5565	1	1	1	1	1	1	1	1	1	1	100 %
5566	1	1	1	1	1	1	1	1	1	1	100 %
5567	1	1	1	1	1	1	1	1	1	1	100 %
5568	1	1	1	1	1	1	1	1	1	1	100 %
5569	1	1	1	1	1	1	1	1	1	1	100 %
5570(F_H)	1	1	1	1	1	1	1	1	1	1	100 %
Detection Bandwidth = F_H – F_L = 5570-5490 = 80 MHz											
EUT 99% BW =75.39 MHz;										Result: Pass	

STATISTICAL PERFORMANCE CHECK

Procedure:

The steps below define the procedure to determine the minimum percentage of successful detection requirements found in **Tables 5-7** when a radar burst with a level equal to the *DFS Detection Threshold + 1dB* is generated on the *Operating Channel* of the U-NII device (*In-Service Monitoring*).

- a) One frequency will be chosen from the *Operating Channels* of the UUT within the 5250-5350 MHz or 5470-5725 MHz bands.
- b) In case the UUT is a U-NII device operating as a Client Device (with or without Radar Detection), a U-NII device operating as a Master Device will be used to allow the UUT (Client device) to Associate with the Master Device. In case the UUT is a Master Device, a U-NII device operating as a Client Device will be used and it is assumed that the Client will Associate with the UUT (Master). In both cases for conducted tests, the Radar Waveform generator will be connected to the Master Device. For radiated tests, the emissions of the Radar Waveform generator will be directed towards the Master Device. If the Master Device has antenna gain, the main beam of the antenna will be directed toward the radar emitter. Vertical polarization is used for testing.
- c) Stream the channel loading test file from the *Master Device* to the Client Device on the test *Channel* for the entire period of the test.
- d) At time T_0 the *Radar Waveform* generator sends the individual waveform for each of the Radar Types 1- 6 in **Tables 5-7**, at levels defined in **Table 3**, on the *Operating Channel*. An additional 1 dB is added to the radar test signal to ensure it is at or above the *DFS Detection Threshold*, accounting for equipment variations/errors.
- e) Observe the transmissions of the UUT at the end of the Burst on the *Operating Channel* for duration greater than 10 seconds for Radar Type 0 to ensure detection occurs.
- f) Observe the transmissions of the UUT at the end of the Burst on the *Operating Channel* for duration greater than 22 seconds for Long Pulse Radar Type 5 to ensure detection occurs.
- g) In case the UUT is a U-NII device operating as a *Client Device* with *In-Service Monitoring*, perform steps a) to f).

Result:**20MHz**

Radar SignalType	Waveform/Trial Number	Detection (%)	Limit (%)	Pass/Fail
Type 1A	15	100%	60%	pass
Type 1B	15	100%	60%	pass
Type 2	30	100 %	60%	Pass
Type 3	30	100 %	60%	Pass
Type 4	30	100 %	60%	Pass
Aggregate (Type1 to 4)	120	100 %	80%	Pass
Type 5	30	100 %	80%	Pass
Type 6	30	100 %	70%	Pass

Please refer to the following statistical tables:

5500MHz**Radar Type 1A Statistical Performance**

Trial #	Fc (MHz)	Pulse/Burst	Pulse Width (μS)	PRI (μs)	Detection (1:yes; 0:no)
1	5500	89	1	598	1
2	5500	92	1	578	1
3	5500	78	1	678	1
4	5500	58	1	918	1
5	5500	76	1	698	1
6	5500	65	1	818	1
7	5500	67	1	798	1
8	5500	74	1	718	1
9	5500	68	1	778	1
10	5500	63	1	838	1
11	5500	70	1	758	1
12	5500	61	1	878	1
13	5500	81	1	658	1
14	5500	95	1	558	1
15	5500	18	1	3066	1
Detection Percentage: 100 % (>60%)					

Radar Type 1B Statistical Performance

Trial #	Fc (MHz)	Pulse/Burst	Pulse Width (μS)	PRI (μs)	Detection (1:yes; 0:no)
1	5500	44	1	1208	1
2	5500	24	1	2223	1
3	5500	26	1	2071	1
4	5500	24	1	2241	1
5	5500	49	1	1096	1
6	5500	40	1	1351	1
7	5500	21	1	2616	1
8	5500	29	1	1837	1
9	5500	39	1	1365	1
10	5500	32	1	1667	1
11	5500	64	1	834	1
12	5500	42	1	1283	1
13	5500	23	1	2326	1
14	5500	77	1	686	1
15	5500	18	1	3034	1
Detection Percentage: 100 % (>60%)					

Radar Type 2 Statistical Performance

Trial #	Fc (MHz)	Pulse/Burst	Pulse Width (μS)	PRI (μs)	Detection (1:yes; 0:no)
1	5500	25	2.4	150	1
2	5500	24	4	197	1
3	5500	24	3	215	1
4	5500	25	2.3	217	1
5	5500	24	2.2	160	1
6	5500	29	3.1	192	1
7	5500	28	1.7	180	1
8	5500	26	4.2	228	1
9	5500	28	3.3	171	1
10	5500	28	4.8	183	1
11	5500	29	4.1	193	1
12	5500	24	1.9	177	1
13	5500	25	2.7	166	1
14	5500	25	1	209	1
15	5500	26	3.9	226	1
16	5500	28	1.6	191	1
17	5500	26	1.7	155	1
18	5500	25	4.6	190	1
19	5500	27	2.3	182	1
20	5500	25	2.5	200	1
21	5500	26	3.2	197	1
22	5500	23	1.7	199	1
23	5500	26	2.4	175	1
24	5500	24	4.5	226	1
25	5500	23	4.4	156	1
26	5500	24	2.9	208	1
27	5500	28	4.8	200	1
28	5500	23	4.1	220	1
29	5500	27	3.6	177	1
30	5500	23	3.2	181	1
Detection Percentage: 100 % (>60%)					

Radar Type 3 Statistical Performance

Trial #	Fc (MHz)	Pulse/Burst	Pulse Width (μS)	PRI (μs)	Detection (1:yes; 0:no)
1	5500	18	6.5	449	1
2	5500	17	6.4	355	1
3	5500	18	7.6	203	1
4	5500	16	7.4	236	1
5	5500	17	8.5	276	1
6	5500	16	9.2	387	1
7	5500	18	7.4	454	1
8	5500	16	8.4	377	1
9	5500	18	8.9	336	1
10	5500	18	7.4	411	1
11	5500	17	6.8	211	1
12	5500	16	7.6	209	1
13	5500	18	9.5	436	1
14	5500	18	8.9	278	1
15	5500	17	8.5	447	1
16	5500	16	9.2	496	1
17	5500	17	9.5	484	1
18	5500	16	7.3	323	1
19	5500	18	6.8	478	1
20	5500	17	10	223	1
21	5500	16	7.8	454	1
22	5500	18	6.1	308	1
23	5500	16	9.5	372	1
24	5500	16	10	244	1
25	5500	18	7.7	430	1
26	5500	18	6.9	246	1
27	5500	18	8.4	455	1
28	5500	17	9.8	497	1
29	5500	18	9.4	353	1
30	5500	18	8.3	310	1
Detection Percentage: 100 % (>60%)					

Radar Type 4 Statistical Performance

Trial #	Fc (MHz)	Pulse/Burst	Pulse Width (μS)	PRI (μs)	Detection (1:yes; 0:no)
1	5500	15	17.4	437	1
2	5500	14	11.3	350	1
3	5500	15	14.8	411	1
4	5500	13	13.9	290	1
5	5500	16	13.5	383	1
6	5500	15	17.2	473	1
7	5500	15	14.8	494	1
8	5500	12	18.9	247	1
9	5500	12	13.9	259	1
10	5500	15	20	303	1
11	5500	16	18.4	224	1
12	5500	12	13.3	488	1
13	5500	13	14	296	1
14	5500	15	13.6	391	1
15	5500	12	16.8	474	1
16	5500	12	12.2	227	1
17	5500	14	13.1	386	1
18	5500	15	13.9	338	1
19	5500	16	16.4	497	1
20	5500	12	16.9	395	1
21	5500	12	13.8	340	1
22	5500	15	19.8	266	1
23	5500	13	15.7	245	1
24	5500	14	19.2	371	1
25	5500	13	12.5	487	1
26	5500	16	14.4	387	1
27	5500	15	11	349	1
28	5500	13	16.5	413	1
29	5500	16	18.8	387	1
30	5500	15	12.5	426	1
Detection Percentage: 100 % (>60%)					

Radar Type 5 Case 1 Statistical Performance

Statistics 1 (ChirpCenter Frequency: 5500.0MHz)

Trial #	Pulse	Chirp(MHz)	Pulse Width (µS)	Pulse 1-2 spacing(µS)	Pulse 2-3 spacing(µS)	Pulse Start(S)	Detection (1:yes;0:no)
0	3	10	74.8	1772	1130	1.241851	1
1	3	10	82.8	1622	1662	2.03177	
2	2	10	57.6	1165		3.683923	
3	2	10	80.4	1150		4.072654	
4	3	10	74.7	1019	1173	6.386826	
5	1	10	67			7.512901	
6	2	10	50.8	1326		8.396371	
7	2	10	65.2	1331		10.04771	
8	3	10	78.3	1440	1955	11.63818	

Statistics 2 (ChirpCenter Frequency: 5500.0 MHz)

Trial #	Pulse	Chirp(MHz)	Pulse Width (µS)	Pulse 1-2 spacing(µS)	Pulse 2-3 spacing(µS)	Pulse Start(S)	Detection (1:yes;0:no)
0	2	16	86.9	1084		0.382876	1
1	2	16	51.1	1288		0.903512	
2	3	16	71.8	1395	1363	2.074639	
3	2	16	72.5	1237		2.513638	
4	1	16	53.5			3.315691	
5	3	16	84.4	1574	1712	3.78502	
6	1	16	73.1			4.823484	
7	3	16	59.8	1071	1448	5.206963	
8	3	16	58.8	1131	1086	5.941869	
9	3	16	92.4	1451	1731	6.617772	
10	2	16	79.2	1038		7.216248	
11	2	16	85.6	1284		7.937901	
12	1	16	71			9.013537	
13	2	16	79.5	1056		9.527114	
14	2	16	94.3	1846		10.2514	
15	1	16	76.3			10.62422	
16	2	16	93.6	1009		11.77259	

Statistics 3 (ChirpCenter Frequency: 5500.0 MHz)

Trial #	Pulse	Chirp(MHz)	Pulse Width (μS)	Pulse 1-2 spacing(μS)	Pulse 2-3 spacing(μS)	Pulse Start(S)	Detection (1:yes;0:no)
0	2	11	71.4	1572		0.02843	1
1	1	11	86.7			0.84689	
2	2	11	90	1343		1.836314	
3	2	11	97.2	1864		2.478048	
4	1	11	67.7			2.986572	
5	1	11	83.1			3.758389	
6	3	11	63.1	1524	1919	4.40631	
7	2	11	73.1	1699		4.54567	
8	2	11	52.4	1583		5.136947	
9	1	11	71.5			5.894098	
10	3	11	71.2	1341	1918	6.332551	
11	3	11	57.5	1602	1892	7.46316	
12	1	11	96.1			8.160968	
13	2	11	53	1679		8.32902	
14	3	11	62.3	1106	1812	9.344625	
15	3	11	59.6	1316	1805	9.88581	
16	1	11	58.3			10.56249	
17	2	11	81.1	1065		11.2606	
18	2	11	72.1	1870		11.96599	

Statistics 4 (ChirpCenter Frequency: 5500.0 MHz)

Trial #	Pulse	Chirp(MHz)	Pulse Width (μS)	Pulse 1-2 spacing(μS)	Pulse 2-3 spacing(μS)	Pulse Start(S)	Detection (1:yes;0:no)
0	1	16	77.6			0.190632	1
1	1	16	58.9			1.168421	
2	2	16	61.8	1339		1.866372	
3	1	16	82.4			2.133964	
4	2	16	54.8	1752		3.257869	
5	2	16	56.7	1111		3.843401	
6	1	16	65.1			4.112404	
7	2	16	57.1	1118		4.861496	
8	2	16	81.5	1763		5.98683	
9	2	16	92.3	1290		6.179679	
10	2	16	94	1446		7.062993	
11	2	16	99.8	1370		7.8641	
12	3	16	82	1742	1424	8.543926	
13	3	16	55.9	1367	1090	8.944342	
14	2	16	63.1	1950		9.438191	
15	1	16	83.2			10.00271	
16	2	16	79.1	1500		11.02594	
17	1	16	95.3			11.60443	

Statistics 5(ChirpCenter Frequency: 5500.0 MHz)

Trial #	Pulse	Chirp(MHz)	Pulse Width (μS)	Pulse 1-2 spacing(μS)	Pulse 2-3 spacing(μS)	Pulse Start(S)	Detection (1:yes;0:no)
0	3	13	87.9	1731	1972	0.129236	1
1	3	13	90.9	1326	1314	2.193497	
2	2	13	67	1723		3.030147	
3	3	13	94.3	1165	1010	4.663607	
4	3	13	79.2	1154	1196	6.333507	
5	1	13	79.3			7.160207	
6	2	13	53.5	1268		9.220855	
7	2	13	78.2	1554		9.343154	
8	2	13	66.7	1747		11.53108	

Statistics 6 (ChirpCenter Frequency: 5500.0 MHz)

Trial #	Pulse	Chirp(MHz)	Pulse Width (μS)	Pulse 1-2 spacing(μS)	Pulse 2-3 spacing(μS)	Pulse Start(S)	Detection (1:yes;0:no)
0	1	12	97.8			0.771159	1
1	3	12	60.5	1992	1633	1.88675	
2	2	12	74.8	1119		2.832222	
3	2	12	85.9	1797		3.557866	
4	1	12	82.5			4.666436	
5	1	12	98.7			5.606752	
6	3	12	77.2	1476	1891	6.361038	
7	2	12	61.9	1203		7.158363	
8	1	12	64.3			8.443085	
9	2	12	99.9	1266		9.987426	
10	1	12	95.2			10.43712	
11	2	12	51.8	1157		11.14077	

Statistics 7(ChirpCenter Frequency: 5500.0 MHz)

Trial #	Pulse	Chirp(MHz)	Pulse Width (μS)	Pulse 1-2 spacing(μS)	Pulse 2-3 spacing(μS)	Pulse Start(S)	Detection (1:yes;0:no)
0	2	15	98.1	1986		0.091354	1
1	3	15	94.7	1124	1168	1.756561	
2	2	15	79.3	1324		2.081454	
3	1	15	76.1			2.780011	
4	1	15	82			4.367076	
5	2	15	93.9	1783		4.738472	
6	1	15	92.4			6.385563	
7	1	15	75.1			6.93005	
8	2	15	60.4	1061		7.737481	
9	2	15	64.5	1363		8.649155	
10	2	15	85.1	1498		10.0779	
11	2	15	54.1	1208		10.21804	
12	1	15	90.6			11.85805	

Statistics 8 (ChirpCenter Frequency: 5500.0 MHz)

Trial #	Pulse	Chirp(MHz)	Pulse Width (μS)	Pulse 1-2 spacing(μS)	Pulse 2-3 spacing(μS)	Pulse Start(S)	Detection (1:yes;0:no)
0	2	8	94.2	1688		0.466255	1
1	1	8	61.8			1.240444	
2	3	8	92.1	1569	1129	2.266458	
3	2	8	54.5	1416		3.146596	
4	2	8	52.6	1704		3.552382	
5	2	8	81.6	1038		4.791311	
6	2	8	53	1746		5.458612	
7	3	8	57.1	1991	1199	5.822571	
8	2	8	98.8	1132		6.604381	
9	2	8	69.3	1373		7.503467	
10	2	8	61.5	1008		8.043803	
11	2	8	60.2	1007		9.162399	
12	3	8	64.9	1453	1893	10.37358	
13	3	8	79.1	1312	1378	11.01088	
14	3	8	75.2	1944	1712	11.52999	

Statistics 9 (ChirpCenter Frequency: 5500.0 MHz)

Trial #	Pulse	Chirp(MHz)	Pulse Width (μS)	Pulse 1-2 spacing(μS)	Pulse 2-3 spacing(μS)	Pulse Start(S)	Detection (1:yes;0:no)
0	2	10	82.4	1211		0.178065	1
1	2	10	53	1533		1.105442	
2	3	10	100	1723	1353	1.46542	
3	1	10	93.2			2.214806	
4	1	10	66.9			2.560016	
5	2	10	60.2	1747		3.75248	
6	1	10	62.8			4.006852	
7	3	10	75.1	1157	1126	4.978085	
8	1	10	95.4			5.377783	
9	3	10	95.6	1012	1879	6.205843	
10	2	10	90	1724		6.396742	
11	3	10	56.2	1618	1616	7.087898	
12	3	10	68.2	1728	1257	7.745987	
13	3	10	88.6	1237	1160	8.331206	
14	1	10	80.2			9.184886	
15	3	10	77.6	1916	1096	10.04889	
16	1	10	68.1			10.66036	
17	3	10	78.9	1422	1056	10.88538	
18	3	10	82.6	1481	1884	11.53126	

Statistics 10 (ChirpCenter Frequency: 5500.0 MHz)

Trial #	Pulse	Chirp(MHz)	Pulse Width (µS)	Pulse 1-2 spacing(µS)	Pulse 2-3 spacing(µS)	Pulse Start(S)	Detection (1:yes;0:no)
0	2	6	57.9	1824		0.749386	1
1	3	6	67.4	1108	1574	1.587043	
2	2	6	77.2	1709		2.202856	
3	1	6	68.6			3.97067	
4	3	6	53.9	1927	1396	4.571042	
5	2	6	50.6	1379		5.155174	
6	3	6	67.5	1416	1691	6.039277	
7	3	6	69.2	1830	1755	7.76283	
8	2	6	92.1	1073		8.839717	
9	2	6	82.6	1465		9.879825	
10	2	6	66	1750		10.61262	
11	1	6	59.6			11.2773	

Radar Type 5 Case 2 Statistical Performance

Statistics 1 (ChirpCenter Frequency: 5492.0 MHz)

Trial #	Pulse	Chirp(MHz)	Pulse Width (µS)	Pulse 1-2 spacing(µS)	Pulse 2-3 spacing(µS)	Pulse Start(S)	Detection (1:yes;0:no)
0	3	5	50.5	1270	1048	0.16614	1
1	1	5	89.5			1.445513	
2	1	5	93.9			3.159858	
3	3	5	78	1780	1500	3.662747	
4	2	5	59.6	1682		4.846517	
5	2	5	59.1	1072		6.103297	
6	2	5	72.2	1047		7.380748	
7	2	5	92.9	1135		8.550738	
8	2	5	91.7	1427		9.366419	
9	2	5	84.3	1820		10.68066	
10	3	5	80.8	1102	1241	11.36227	

Statistics 2 (ChirpCenter Frequency: 5494.0 MHz)

Trial #	Pulse	Chirp(MHz)	Pulse Width (μ S)	Pulse 1-2 spacing(μ S)	Pulse 2-3 spacing(μ S)	Pulse Start(S)	Detection (1:yes;0:no)
0	3	11	77.3	1012	1323	0.540582	1
1	2	11	68.9	1253		0.757601	
2	2	11	86.1	1429		1.647103	
3	3	11	93.7	1805	1427	2.315548	
4	1	11	64.5			2.780186	
5	3	11	70.1	1370	1040	3.371023	
6	1	11	91.7			4.334265	
7	3	11	64	1042	1468	4.465419	
8	1	11	90.5			5.161079	
9	2	11	64	1795		6.253587	
10	1	11	64.7			6.415283	
11	2	11	82.3	1188		7.182515	
12	2	11	56	1158		7.797895	
13	2	11	94.7	1669		8.528106	
14	2	11	74.2	1317		8.917777	
15	2	11	74.4	1906		9.797528	
16	1	11	66.5			10.206	
17	2	11	66.4	1138		10.99522	
18	1	11	71.3			11.42142	

Statistics 3 (ChirpCenter Frequency: 5494.0 MHz)

Trial #	Pulse	Chirp(MHz)	Pulse Width (μ S)	Pulse 1-2 spacing(μ S)	Pulse 2-3 spacing(μ S)	Pulse Start(S)	Detection (1:yes;0:no)
0	1	9	69.1			0.519864	1
1	2	9	66.7	1846		1.327873	
2	1	9	81.6			2.812588	
3	2	9	67.6	1683		4.263017	
4	3	9	69.8	1977	1381	4.756577	
5	2	9	57.9	1361		6.385658	
6	1	9	73.5			7.304028	
7	2	9	98.8	1636		7.672592	
8	2	9	95.6	1330		9.789582	
9	1	9	58.6			10.74355	
10	1	9	57.1			11.11907	

Statistics 4 (ChirpCenter Frequency: 5492.0 MHz)

Trial #	Pulse	Chirp(MHz)	Pulse Width (μS)	Pulse 1-2 spacing(μS)	Pulse 2-3 spacing(μS)	Pulse Start(S)	Detection (1:yes;0:no)
0	2	5	62.2	1914		0.501716	1
1	2	5	54.1	1174		0.779935	
2	2	5	79.4	1420		1.731317	
3	2	5	65.6	1389		2.132135	
4	2	5	72.1	1926		2.861866	
5	2	5	61.6	1775		3.390887	
6	1	5	95.9			3.845323	
7	2	5	66.2	1810		4.583895	
8	2	5	74	1163		4.86781	
9	2	5	99.9	1608		5.512628	
10	2	5	53.4	1052		6.004834	
11	3	5	92	1408	1264	6.924887	
12	2	5	99.3	1863		7.445211	
13	2	5	78.8	1732		8.041501	
14	2	5	80	1947		8.845349	
15	1	5	85.3			9.421669	
16	3	5	96.6	1572	1982	9.911237	
17	2	5	83.7	1764		10.48886	
18	1	5	75.2			10.8896	
19	1	5	89.7			11.49229	

Statistics 5 (ChirpCenter Frequency: 5494.0 MHz)

Trial #	Pulse	Chirp(MHz)	Pulse Width (μS)	Pulse 1-2 spacing(μS)	Pulse 2-3 spacing(μS)	Pulse Start(S)	Detection (1:yes;0:no)
0	1	10	94.2			0.279504	1
1	2	10	73.3	1117		1.378127	
2	1	10	70.3			1.953498	
3	2	10	87.9	1102		2.855757	
4	3	10	96.3	1093	1052	3.737106	
5	2	10	50	1637		4.087682	
6	3	10	87.7	1833	1497	5.227476	
7	2	10	79.4	1794		5.553114	
8	2	10	73.7	1156		6.489814	
9	1	10	94			7.484541	
10	3	10	56.1	1656	1426	7.591098	
11	3	10	97.9	1052	1929	8.58182	
12	2	10	68.4	1110		9.042305	
13	2	10	61.2	1478		10.08725	
14	3	10	68	1833	1294	10.8128	
15	2	10	85.1	1218		11.98348	

Statistics 6 (ChirpCenter Frequency: 5496.0 MHz)

Trial #	Pulse	Chirp(MHz)	Pulse Width (μS)	Pulse 1-2 spacing(μS)	Pulse 2-3 spacing(μS)	Pulse Start(S)	Detection (1:yes;0:no)
0	3	16	62.5	1354	1824	0.702876	1
1	2	16	80	1102		1.340559	
2	2	16	91.7	1034		1.920674	
3	3	16	77	1266	1650	2.843577	
4	2	16	50.4	1267		4.498239	
5	1	16	69.6			5.364369	
6	2	16	88.2	1653		5.956591	
7	2	16	87.1	1182		7.228927	
8	2	16	85.7	1743		7.966282	
9	2	16	98.5	1729		8.617669	
10	2	16	72.3	1987		10.10337	
11	2	16	93.4	1954		10.51215	
12	1	16	74.9			11.89082	

Statistics 7 (ChirpCenter Frequency: 5495.0 MHz)

Trial #	Pulse	Chirp(MHz)	Pulse Width (μS)	Pulse 1-2 spacing(uS)	Pulse 2-3 spacing(uS)	Pulse Start(S)	Detection (1:yes;0:no)
1	2	12	72.4	1583		1.593748	1
2	3	12	50.9	1331	1327	2.314048	
3	2	12	60.2	1440		3.754379	
4	3	12	63.7	1270	1936	5.268651	
5	2	12	57.4	1341		5.589034	
6	3	12	93.7	1369	1430	7.304718	
7	1	12	82.4			7.663764	
8	1	12	62.2			9.648972	
9	2	12	74.8	1909		10.76679	
10	2	12	59.2	1572		10.96038	
1	2	12	72.4	1583		1.593748	

Statistics 8 (ChirpCenter Frequency: 5496.0 MHz)

Trial #	Pulse	Chirp(MHz)	Pulse Width (μS)	Pulse 1-2 spacing(μS)	Pulse 2-3 spacing(μS)	Pulse Start(S)	Detection (1:yes;0:no)
0	3	14	53.2	1070	1989	0.605635	1
1	3	14	86.8	1366	1905	0.959885	
2	2	14	67.8	1712		1.349653	
3	3	14	79.4	1910	1005	2.261574	
4	2	14	59	1545		3.135976	
5	3	14	94.9	1223	1704	3.309346	
6	1	14	51.9			3.825753	
7	3	14	96.9	1518	1312	4.907067	
8	2	14	84.3	1046		5.319051	
9	2	14	71	1677		5.902485	
10	1	14	54.8			6.392367	
11	2	14	65.6	1308		7.03652	
12	2	14	68.1	1080		7.679817	
13	1	14	83.7			8.368386	
14	3	14	82	1369	1335	9.014141	
15	1	14	67.5			9.905819	
16	3	14	99.8	1139	1376	10.12226	
17	2	14	79.9	1532		11.09221	
18	1	14	70.9			11.87408	

Statistics 9 (ChirpCenter Frequency: 5496.0 MHz)

Trial #	Pulse	Chirp(MHz)	Pulse Width (μS)	Pulse 1-2 spacing(μS)	Pulse 2-3 spacing(μS)	Pulse Start(S)	Detection (1:yes;0:no)
0	2	15	98.4	1188		0.317555	1
1	2	15	64.5	1854		1.16908	
2	3	15	72.9	1570	1078	1.544989	
3	2	15	80.8	1821		2.230647	
4	2	15	78.6	1523		2.768211	
5	3	15	56.6	1840	1161	3.485748	
6	3	15	85.5	1741	1879	4.04202	
7	3	15	99.7	1240	1706	4.560412	
8	2	15	76.6	1500		5.309438	
9	2	15	80	1804		5.604307	
10	2	15	66.9	1479		6.525761	
11	1	15	79.1			6.895699	
12	2	15	78.6	1272		7.694045	
13	2	15	87.7	1957		8.070756	
14	2	15	91.9	1606		8.519624	
15	2	15	57.9	1785		9.558981	
16	1	15	86.6			9.951112	
17	3	15	82.6	1148	1810	10.65071	
18	1	15	84.2			11.10072	
19	3	15	91.5	1293	1714	11.88018	

Statistics 10 (ChirpCenter Frequency: 5492.0 MHz)

Trial #	Pulse	Chirp(MHz)	Pulse Width (µS)	Pulse 1-2 spacing(µS)	Pulse 2-3 spacing(µS)	Pulse Start(S)	Detection (1:yes;0:no)
0	2	5	69	1325		0.107546	1
1	2	5	70.4	1228		1.246289	
2	2	5	64.2	1368		1.966632	
3	3	5	57	1771	1298	2.944808	
4	2	5	70.8	1648		3.38494	
5	2	5	91.1	1167		4.115004	
6	2	5	75	1423		5.418643	
7	3	5	61.5	1054	1735	5.743843	
8	3	5	72.2	1586	1112	6.822158	
9	2	5	98.3	1570		7.377567	
10	2	5	60.9	1039		8.690238	
11	2	5	84.4	1155		8.934328	
12	3	5	89	1909	1092	9.919602	
13	2	5	54.9	1634		10.42431	
14	3	5	50.3	1791	1026	11.29905	

Radar Type 5 Case 3 Statistical Performance

Statistics 1 (ChirpCenter Frequency: 5503.0 MHz)

Trial #	Pulse	Chirp(MHz)	Pulse Width (µS)	Pulse 1-2 spacing(µS)	Pulse 2-3 spacing(µS)	Pulse Start(S)	Detection (1:yes;0:no)
0	3	18	95.8	1004	1139	0.134432	1
1	1	18	89			1.357814	
2	2	18	92.2	1156		2.190408	
3	1	18	74.2			2.719219	
4	2	18	91.7	1794		3.756805	
5	2	18	70.7	1434		4.74502	
6	2	18	69.6	1284		5.456644	
7	2	18	97.2	1672		5.9768	
8	2	18	73.8	1293		6.887771	
9	3	18	60.5	1267	1256	7.339248	
10	2	18	81.2	1262		8.285363	
11	3	18	79.2	1757	1084	8.951299	
12	1	18	74.2			10.35965	
13	1	18	60.9			10.59641	
14	2	18	97.6	1556		11.51391	

Statistics 2 (ChirpCenter Frequency: 5508.0 MHz)

Trial #	Pulse	Chirp(MHz)	Pulse Width (µS)	Pulse 1-2 spacing(µS)	Pulse 2-3 spacing(µS)	Pulse Start(S)	Detection (1:yes;0:no)
0	3	16	62.8	1999	1629	1.277062	1
1	1	16	81.4			2.031206	
2	3	16	97.8	1968	1594	2.853924	
3	1	16	58.1			4.498777	
4	3	16	93.7	1967	1119	5.909153	
5	2	16	53.8	1298		7.803787	
6	2	16	93.2	1389		8.417006	
7	3	16	70.2	1065	1094	10.19633	
8	1	16	57.3			11.68777	

Statistics 3 (ChirpCenter Frequency: 5506.0 MHz)

Trial #	Pulse	Chirp(MHz)	Pulse Width (µS)	Pulse 1-2 spacing(µS)	Pulse 2-3 spacing(µS)	Pulse Start(S)	Detection (1:yes;0:no)
0	2	9	63.5	1233		0.669665	1
1	3	9	94	1516	1186	1.091466	
2	3	9	76.1	1971	1504	1.709525	
3	2	9	91.6	1063		2.591223	
4	3	9	63.2	1387	1748	3.650987	
5	2	9	79.9	1815		4.666101	
6	1	9	64.4			5.134364	
7	3	9	74.7	1057	1782	6.16921	
8	2	9	97.4	1483		7.105554	
9	3	9	61.7	1367	1599	7.428595	
10	3	9	98.7	1263	1860	8.224131	
11	2	9	59	1120		9.10095	
12	2	9	83.8	1514		9.844478	
13	3	9	76.3	1637	1869	10.54646	
14	2	9	69.1	1062		11.20894	

Statistics 4 (ChirpCenter Frequency: 5508.0 MHz)

Trial #	Pulse	Chirp(MHz)	Pulse Width (µS)	Pulse 1-2 spacing(µS)	Pulse 2-3 spacing(µS)	Pulse Start(S)	Detection (1:yes;0:no)
0	3	5	59.9	1851	1525	0.074914	1
1	3	5	67	1139	1245	1.455782	
2	2	5	56.7	1855		2.119812	
3	1	5	52.4			2.451315	
4	3	5	70.3	1903	1572	3.720561	
5	1	5	68.3			4.20773	
6	3	5	77.5	1890	1614	5.264046	
7	1	5	60.8			5.839944	
8	2	5	63.7	1959		6.587835	
9	1	5	94.2			7.772455	
10	3	5	89.1	1651	1599	8.1075	
11	2	5	74.8	1054		8.81071	
12	1	5	71.4			10.38713	
13	2	5	66.1	1653		10.91655	
14	3	5	63.9	1924	1068	11.60801	

Statistics 5 (ChirpCenter Frequency: 5505.0 MHz)

Trial #	Pulse	Chirp(MHz)	Pulse Width (µS)	Pulse 1-2 spacing(µS)	Pulse 2-3 spacing(µS)	Pulse Start(S)	Detection (1:yes;0:no)
0	1	13	68.9			1.018147	1
1	2	13	55.4	1976		2.260118	
2	2	13	76.8	1875		2.695248	
3	1	13	80.2			4.099394	
4	1	13	63.7			5.911463	
5	3	13	75.6	1651	1087	7.515407	
6	3	13	77.9	1737	1684	8.369285	
7	2	13	58.4	1097		10.06229	
8	2	13	91.4	1979		10.95365	

Statistics 6 (ChirpCenter Frequency: 5505.0 MHz)

Trial #	Pulse	Chirp(MHz)	Pulse Width (µS)	Pulse 1-2 spacing(µS)	Pulse 2-3 spacing(µS)	Pulse Start(S)	Detection (1:yes;0:no)
0	2	13	55.3	1779		0.369196	
1	3	13	86.9	1494	1827	1.363172	
2	2	13	80.8	1029		3.822558	
3	3	13	83	1475	1170	4.280414	
4	1	13	68.9			5.997534	
5	1	13	98.8			7.618084	
6	2	13	95.4	1251		8.75153	
7	2	13	87.8	1660		10.52762	
8	2	13	79.5	1123		11.66852	

Statistics 7 (ChirpCenter Frequency: 5506.0 MHz)

Trial #	Pulse	Chirp(MHz)	Pulse Width (μS)	Pulse 1-2 spacing(μS)	Pulse 2-3 spacing(μS)	Pulse Start(S)	Detection (1:yes;0:no)
0	3	9	92.8	1628	1854	0.812835	1
1	1	9	78			1.343551	
2	2	9	85.9	1528		2.443973	
3	2	9	61.2	1672		2.691173	
4	2	9	64.3	1915		4.088799	
5	1	9	80			4.84248	
6	1	9	98.3			5.668938	
7	3	9	66.2	1797	1962	6.572841	
8	3	9	87.9	1213	1695	7.196111	
9	2	9	73.6	1808		8.134568	
10	3	9	82.6	1156	1757	9.280825	
11	2	9	99.1	1747		9.925915	
12	2	9	97.8	1359		10.59621	
13	3	9	58.5	1661	1462	11.31668	

Statistics 8 (ChirpCenter Frequency: 5503.0 MHz)

Trial #	Pulse	Chirp(MHz)	Pulse Width (μS)	Pulse 1-2 spacing(μS)	Pulse 2-3 spacing(μS)	Pulse Start(S)	Detection (1:yes;0:no)
0	2	18	93.4	1233		0.763548	1
1	2	18	93	1275		1.40659	
2	3	18	74.5	1085	1180	2.412481	
3	2	18	77.7	1122		4.110106	
4	3	18	61.7	1368	1613	5.941532	
5	3	18	59.5	1556	1926	6.115738	
6	2	18	88.2	1909		8.340715	
7	2	18	92.8	1268		9.511116	
8	2	18	95.6	1919		9.670088	
9	1	18	77.9			11.79756	

Statistics 9 (ChirpCenter Frequency: 5508.0 MHz)

Trial #	Pulse	Chirp(MHz)	Pulse Width (μS)	Pulse 1-2 spacing(μS)	Pulse 2-3 spacing(μS)	Pulse Start(S)	Detection (1:yes;0:no)
0	2	6	65.9	1578		0.004378	1
1	1	6	89.8			1.092791	
2	2	6	65.5	1026		2.099908	
3	2	6	86	1408		3.430733	
4	3	6	51.5	1503	1253	3.737122	
5	2	6	79.2	1831		5.017803	
6	1	6	65.6			5.563279	
7	1	6	74.5			7.32946	
8	2	6	75.4	1850		7.619813	
9	2	6	55.6	1601		9.160294	
10	2	6	64.4	1035		9.715449	
11	2	6	76.6	1160		10.90738	
12	2	6	81.6	1325		11.89248	

Statistics 10 (ChirpCenter Frequency: 5503.0 MHz)

Trial #	Pulse	Chirp(MHz)	Pulse Width (μS)	Pulse 1-2 spacing(μS)	Pulse 2-3 spacing(μS)	Pulse Start(S)	Detection (1:yes;0:no)
0	3	17	76.3	1696	1823	0.312203	1
1	3	17	90.7	1442	1994	0.968695	
2	3	17	67	1488	1091	1.530958	
3	3	17	90.7	1973	1662	2.160902	
4	2	17	66.6	1992		2.654361	
5	2	17	80.5	1898		3.381656	
6	2	17	76.5	1660		4.231195	
7	2	17	87.3	1101		4.601464	
8	2	17	93.4	1692		5.43067	
9	1	17	78.1			6.137118	
10	1	17	84.7			6.687559	
11	1	17	61.4			7.082026	
12	1	17	72.2			7.890351	
13	3	17	85.2	1814	1796	8.534436	
14	1	17	61.5			8.867246	
15	2	17	93	1419		9.657006	
16	2	17	86.5	1499		10.11912	
17	2	17	75	1947		11.06544	
18	2	17	91.8	1475		11.60612	

Radar Type 6 Statistical Performance

Trial #	Fc (MHz)	Pulse /Burst	Pulse Width (µS)	PRI (µs)	Detection (1:yes; 0:no)	Hopping Sequence (MHz)
1	5500	9	1	333	1	5493.0, 5447.0, 5545.0, 5505.0, 5256.0, 5569.0, 5568.0, 5459.0, 5575.0, 5511.0, 5436.0, 5609.0, 5423.0, 5480.0, 5679.0, 5411.0, 5479.0, 5620.0, 5529.0, 5666.0, 5377.0, 5693.0, 5483.0, 5532.0, 5656.0, 5689.0, 5253.0, 5721.0, 5531.0, 5452.0, 5709.0, 5356.0, 5639.0, 5290.0, 5259.0, 5456.0, 5276.0, 5703.0, 5576.0, 5626.0, 5599.0, 5677.0, 5269.0, 5257.0, 5396.0, 5412.0, 5263.0, 5303.0, 5470.0, 5674.0, 5379.0, 5606.0, 5485.0, 5404.0, 5644.0, 5367.0, 5528.0, 5715.0, 5712.0, 5460.0, 5601.0, 5462.0, 5607.0, 5335.0, 5683.0, 5484.0, 5694.0, 5473.0, 5602.0, 5476.0, 5534.0, 5500.0, 5546.0, 5704.0, 5562.0, 5332.0, 5663.0, 5334.0, 5622.0, 5349.0, 5556.0, 5304.0, 5719.0, 5383.0, 5357.0, 5496.0, 5311.0, 5328.0, 5655.0, 5572.0, 5266.0, 5330.0, 5424.0, 5467.0, 5361.0, 5580.0, 5298.0, 5398.0, 5472.0, 5579.0
2	5500	9	1	333	1	5410.0, 5472.0, 5271.0, 5376.0, 5624.0, 5367.0, 5452.0, 5401.0, 5546.0, 5501.0, 5521.0, 5302.0, 5599.0, 5583.0, 5324.0, 5646.0, 5653.0, 5438.0, 5314.0, 5508.0, 5493.0, 5391.0, 5603.0, 5290.0, 5467.0, 5619.0, 5422.0, 5285.0, 5557.0, 5701.0, 5266.0, 5620.0, 5405.0, 5415.0, 5446.0, 5291.0, 5486.0, 5541.0, 5265.0, 5414.0, 5366.0, 5270.0, 5408.0, 5413.0, 5655.0, 5672.0, 5512.0, 5685.0, 5638.0, 5567.0, 5507.0, 5594.0, 5563.0, 5601.0, 5490.0, 5637.0, 5616.0, 5625.0, 5525.0, 5349.0, 5660.0, 5635.0, 5719.0, 5636.0, 5258.0, 5333.0, 5390.0, 5418.0, 5669.0, 5313.0, 5336.0, 5642.0, 5331.0, 5588.0, 5274.0, 5353.0, 5492.0, 5647.0, 5330.0, 5702.0, 5556.0, 5667.0, 5529.0, 5264.0, 5267.0, 5632.0, 5428.0, 5688.0, 5464.0, 5365.0, 5495.0, 5578.0, 5691.0, 5584.0, 5378.0, 5436.0, 5538.0, 5607.0, 5534.0, 5473.0
3	5500	9	1	333	1	5464.0, 5606.0, 5281.0, 5634.0, 5466.0, 5310.0, 5638.0, 5434.0, 5534.0, 5575.0, 5661.0, 5474.0, 5608.0, 5648.0, 5465.0, 5330.0, 5503.0, 5452.0, 5424.0, 5655.0, 5505.0, 5418.0, 5259.0, 5429.0, 5643.0, 5289.0, 5507.0, 5715.0, 5711.0, 5565.0, 5650.0, 5672.0, 5640.0, 5321.0, 5551.0, 5297.0, 5560.0, 5306.0, 5441.0, 5261.0, 5283.0, 5352.0, 5463.0, 5403.0, 5515.0, 5368.0, 5470.0, 5722.0, 5635.0, 5458.0, 5314.0, 5571.0, 5363.0, 5589.0, 5600.0, 5591.0, 5578.0, 5552.0, 5561.0, 5667.0, 5436.0, 5450.0, 5646.0, 5295.0, 5423.0,

						5446.0, 5697.0, 5287.0, 5263.0, 5478.0, 5617.0, 5594.0, 5476.0, 5512.0, 5499.0, 5290.0, 5378.0, 5473.0, 5350.0, 5581.0, 5444.0, 5676.0, 5457.0, 5278.0, 5469.0, 5563.0, 5349.0, 5477.0, 5688.0, 5271.0, 5686.0, 5541.0, 5485.0, 5649.0, 5483.0, 5443.0, 5342.0, 5356.0, 5405.0, 5566.0
4	5500	9	1	333	1	5309.0, 5514.0, 5606.0, 5391.0, 5544.0, 5292.0, 5688.0, 5638.0, 5394.0, 5401.0, 5651.0, 5483.0, 5362.0, 5376.0, 5648.0, 5535.0, 5429.0, 5506.0, 5366.0, 5388.0, 5304.0, 5641.0, 5555.0, 5616.0, 5283.0, 5537.0, 5715.0, 5627.0, 5435.0, 5251.0, 5600.0, 5331.0, 5497.0, 5433.0, 5622.0, 5599.0, 5501.0, 5710.0, 5589.0, 5488.0, 5312.0, 5531.0, 5307.0, 5618.0, 5250.0, 5524.0, 5364.0, 5542.0, 5334.0, 5460.0, 5720.0, 5586.0, 5690.0, 5553.0, 5268.0, 5422.0, 5427.0, 5456.0, 5665.0, 5428.0, 5473.0, 5692.0, 5649.0, 5356.0, 5662.0, 5540.0, 5525.0, 5317.0, 5282.0, 5455.0, 5257.0, 5548.0, 5299.0, 5620.0, 5416.0, 5461.0, 5325.0, 5667.0, 5281.0, 5263.0, 5352.0, 5363.0, 5340.0, 5701.0, 5628.0, 5718.0, 5570.0, 5551.0, 5347.0, 5511.0, 5418.0, 5384.0, 5675.0, 5300.0, 5449.0, 5306.0, 5387.0, 5423.0, 5326.0, 5494.0
5	5500	9	1	333	1	5352.0, 5513.0, 5266.0, 5614.0, 5707.0, 5476.0, 5257.0, 5531.0, 5293.0, 5490.0, 5584.0, 5568.0, 5662.0, 5654.0, 5436.0, 5334.0, 5323.0, 5515.0, 5369.0, 5658.0, 5611.0, 5440.0, 5255.0, 5361.0, 5679.0, 5607.0, 5315.0, 5539.0, 5579.0, 5332.0, 5487.0, 5469.0, 5594.0, 5276.0, 5711.0, 5360.0, 5713.0, 5720.0, 5533.0, 5342.0, 5297.0, 5432.0, 5428.0, 5273.0, 5450.0, 5528.0, 5269.0, 5514.0, 5670.0, 5681.0, 5689.0, 5617.0, 5478.0, 5591.0, 5503.0, 5589.0, 5268.0, 5516.0, 5696.0, 5577.0, 5354.0, 5484.0, 5424.0, 5718.0, 5562.0, 5300.0, 5486.0, 5517.0, 5448.0, 5638.0, 5618.0, 5570.0, 5609.0, 5344.0, 5580.0, 5401.0, 5543.0, 5694.0, 5535.0, 5329.0, 5557.0, 5722.0, 5265.0, 5598.0, 5397.0, 5319.0, 5489.0, 5318.0, 5447.0, 5655.0, 5359.0, 5616.0, 5542.0, 5688.0, 5576.0, 5691.0, 5398.0, 5326.0, 5310.0, 5320.0
6	5500	9	1	333	1	5662.0, 5386.0, 5586.0, 5661.0, 5483.0, 5411.0, 5551.0, 5372.0, 5326.0, 5279.0, 5330.0, 5259.0, 5552.0, 5640.0, 5454.0, 5351.0, 5388.0, 5515.0, 5696.0, 5298.0, 5270.0, 5639.0, 5645.0, 5533.0, 5684.0, 5663.0, 5685.0, 5572.0, 5651.0, 5550.0, 5559.0, 5570.0, 5491.0, 5406.0, 5461.0, 5707.0, 5553.0, 5568.0, 5424.0, 5453.0, 5519.0, 5489.0, 5361.0, 5439.0, 5370.0, 5301.0, 5430.0, 5498.0, 5631.0, 5724.0, 5356.0, 5344.0, 5441.0, 5649.0, 5633.0, 5557.0, 5593.0, 5535.0, 5554.0, 5389.0, 5496.0, 5362.0, 5617.0, 5354.0, 5397.0,

						5261.0, 5516.0, 5719.0, 5583.0, 5407.0, 5495.0, 5253.0, 5283.0, 5277.0, 5333.0, 5311.0, 5709.0, 5665.0, 5711.0, 5715.0, 5580.0, 5438.0, 5641.0, 5493.0, 5458.0, 5532.0, 5384.0, 5434.0, 5412.0, 5286.0, 5630.0, 5660.0, 5615.0, 5343.0, 5469.0, 5563.0, 5543.0, 5381.0, 5423.0, 5456.0
7	5500	9	1	333	1	5526.0, 5323.0, 5255.0, 5424.0, 5536.0, 5610.0, 5360.0, 5687.0, 5641.0, 5555.0, 5608.0, 5644.0, 5685.0, 5440.0, 5541.0, 5332.0, 5277.0, 5416.0, 5478.0, 5675.0, 5638.0, 5450.0, 5722.0, 5686.0, 5397.0, 5652.0, 5364.0, 5656.0, 5594.0, 5714.0, 5268.0, 5320.0, 5292.0, 5373.0, 5378.0, 5265.0, 5612.0, 5309.0, 5361.0, 5666.0, 5430.0, 5674.0, 5506.0, 5548.0, 5571.0, 5274.0, 5475.0, 5486.0, 5326.0, 5366.0, 5559.0, 5492.0, 5414.0, 5421.0, 5403.0, 5431.0, 5363.0, 5433.0, 5681.0, 5463.0, 5480.0, 5375.0, 5551.0, 5269.0, 5330.0, 5474.0, 5705.0, 5512.0, 5348.0, 5351.0, 5310.0, 5701.0, 5461.0, 5384.0, 5388.0, 5580.0, 5501.0, 5581.0, 5256.0, 5422.0, 5279.0, 5546.0, 5451.0, 5407.0, 5338.0, 5305.0, 5628.0, 5554.0, 5259.0, 5658.0, 5355.0, 5402.0, 5556.0, 5690.0, 5308.0, 5615.0, 5383.0, 5657.0, 5620.0, 5423.0
8	5500	9	1	333	1	5646.0, 5688.0, 5359.0, 5672.0, 5375.0, 5593.0, 5668.0, 5635.0, 5523.0, 5576.0, 5285.0, 5319.0, 5595.0, 5678.0, 5396.0, 5673.0, 5460.0, 5680.0, 5398.0, 5323.0, 5406.0, 5376.0, 5540.0, 5556.0, 5417.0, 5516.0, 5335.0, 5470.0, 5525.0, 5504.0, 5464.0, 5305.0, 5329.0, 5443.0, 5286.0, 5316.0, 5257.0, 5472.0, 5385.0, 5453.0, 5290.0, 5259.0, 5681.0, 5372.0, 5403.0, 5355.0, 5486.0, 5451.0, 5671.0, 5368.0, 5532.0, 5415.0, 5543.0, 5500.0, 5718.0, 5662.0, 5307.0, 5705.0, 5495.0, 5465.0, 5274.0, 5649.0, 5440.0, 5318.0, 5333.0, 5342.0, 5707.0, 5283.0, 5590.0, 5273.0, 5446.0, 5433.0, 5387.0, 5722.0, 5459.0, 5338.0, 5572.0, 5449.0, 5597.0, 5515.0, 5455.0, 5626.0, 5539.0, 5601.0, 5389.0, 5267.0, 5679.0, 5684.0, 5509.0, 5702.0, 5567.0, 5330.0, 5361.0, 5629.0, 5490.0, 5676.0, 5604.0, 5438.0, 5549.0, 5288.0
9	5500	9	1	333	1	5620.0, 5531.0, 5259.0, 5656.0, 5435.0, 5691.0, 5629.0, 5624.0, 5636.0, 5298.0, 5397.0, 5536.0, 5485.0, 5617.0, 5426.0, 5509.0, 5481.0, 5510.0, 5714.0, 5322.0, 5432.0, 5692.0, 5493.0, 5429.0, 5297.0, 5306.0, 5619.0, 5434.0, 5527.0, 5660.0, 5484.0, 5403.0, 5262.0, 5585.0, 5420.0, 5664.0, 5330.0, 5631.0, 5711.0, 5384.0, 5253.0, 5555.0, 5641.0, 5367.0, 5301.0, 5258.0, 5613.0, 5459.0, 5618.0, 5421.0, 5700.0, 5654.0, 5680.0, 5348.0, 5364.0, 5413.0, 5574.0, 5311.0, 5482.0, 5372.0, 5564.0, 5282.0, 5688.0, 5333.0, 5637.0,

						5338.0, 5463.0, 5489.0, 5662.0, 5385.0, 5705.0, 5296.0, 5558.0, 5670.0, 5365.0, 5684.0, 5562.0, 5473.0, 5634.0, 5390.0, 5549.0, 5579.0, 5477.0, 5650.0, 5340.0, 5468.0, 5266.0, 5720.0, 5607.0, 5632.0, 5276.0, 5568.0, 5319.0, 5513.0, 5697.0, 5462.0, 5251.0, 5299.0, 5303.0, 5627.0
10	5500	9	1	333	1	5264.0, 5259.0, 5353.0, 5688.0, 5668.0, 5560.0, 5537.0, 5284.0, 5415.0, 5475.0, 5411.0, 5593.0, 5480.0, 5294.0, 5459.0, 5300.0, 5312.0, 5511.0, 5700.0, 5278.0, 5423.0, 5709.0, 5670.0, 5297.0, 5590.0, 5313.0, 5290.0, 5705.0, 5366.0, 5436.0, 5275.0, 5325.0, 5375.0, 5696.0, 5632.0, 5306.0, 5676.0, 5358.0, 5263.0, 5520.0, 5569.0, 5269.0, 5271.0, 5417.0, 5650.0, 5570.0, 5412.0, 5265.0, 5723.0, 5330.0, 5319.0, 5720.0, 5513.0, 5565.0, 5524.0, 5722.0, 5685.0, 5270.0, 5453.0, 5663.0, 5472.0, 5533.0, 5308.0, 5466.0, 5561.0, 5350.0, 5388.0, 5310.0, 5283.0, 5262.0, 5392.0, 5362.0, 5331.0, 5539.0, 5474.0, 5322.0, 5340.0, 5386.0, 5382.0, 5588.0, 5282.0, 5432.0, 5563.0, 5253.0, 5582.0, 5669.0, 5321.0, 5711.0, 5347.0, 5712.0, 5333.0, 5335.0, 5680.0, 5404.0, 5621.0, 5421.0, 5460.0, 5544.0, 5431.0, 5509.0
11	5500	9	1	333	1	5375.0, 5406.0, 5592.0, 5709.0, 5666.0, 5399.0, 5484.0, 5429.0, 5287.0, 5539.0, 5305.0, 5377.0, 5502.0, 5597.0, 5371.0, 5321.0, 5283.0, 5362.0, 5454.0, 5280.0, 5500.0, 5285.0, 5722.0, 5481.0, 5425.0, 5585.0, 5412.0, 5682.0, 5443.0, 5509.0, 5420.0, 5360.0, 5343.0, 5383.0, 5253.0, 5345.0, 5441.0, 5319.0, 5552.0, 5510.0, 5635.0, 5376.0, 5639.0, 5289.0, 5275.0, 5286.0, 5571.0, 5341.0, 5309.0, 5333.0, 5514.0, 5531.0, 5434.0, 5693.0, 5432.0, 5614.0, 5282.0, 5442.0, 5688.0, 5498.0, 5702.0, 5448.0, 5339.0, 5656.0, 5386.0, 5540.0, 5520.0, 5633.0, 5697.0, 5710.0, 5257.0, 5634.0, 5506.0, 5651.0, 5472.0, 5636.0, 5483.0, 5270.0, 5378.0, 5315.0, 5586.0, 5384.0, 5607.0, 5687.0, 5659.0, 5562.0, 5459.0, 5324.0, 5686.0, 5274.0, 5507.0, 5617.0, 5612.0, 5400.0, 5665.0, 5372.0, 5288.0, 5381.0, 5422.0, 5301.0
12	5500	9	1	333	1	5325.0, 5649.0, 5407.0, 5560.0, 5361.0, 5411.0, 5651.0, 5340.0, 5473.0, 5496.0, 5479.0, 5278.0, 5292.0, 5494.0, 5366.0, 5549.0, 5293.0, 5665.0, 5586.0, 5386.0, 5370.0, 5301.0, 5499.0, 5504.0, 5319.0, 5594.0, 5405.0, 5380.0, 5689.0, 5600.0, 5250.0, 5540.0, 5554.0, 5604.0, 5396.0, 5673.0, 5558.0, 5281.0, 5392.0, 5403.0, 5342.0, 5259.0, 5359.0, 5354.0, 5484.0, 5552.0, 5334.0, 5262.0, 5391.0, 5489.0, 5510.0, 5308.0, 5423.0, 5620.0, 5296.0, 5264.0, 5511.0, 5306.0, 5573.0, 5256.0, 5559.0, 5353.0, 5654.0, 5527.0, 5697.0,

						5378.0, 5547.0, 5328.0, 5358.0, 5488.0, 5481.0, 5629.0, 5326.0, 5333.0, 5442.0, 5616.0, 5542.0, 5317.0, 5672.0, 5376.0, 5701.0, 5607.0, 5283.0, 5274.0, 5677.0, 5388.0, 5287.0, 5533.0, 5397.0, 5270.0, 5372.0, 5404.0, 5464.0, 5656.0, 5587.0, 5468.0, 5466.0, 5619.0, 5718.0, 5412.0
13	5500	9	1	333	1	5569.0, 5547.0, 5538.0, 5313.0, 5565.0, 5468.0, 5421.0, 5414.0, 5405.0, 5277.0, 5557.0, 5365.0, 5346.0, 5646.0, 5284.0, 5652.0, 5686.0, 5499.0, 5373.0, 5650.0, 5707.0, 5340.0, 5716.0, 5702.0, 5595.0, 5554.0, 5661.0, 5432.0, 5665.0, 5689.0, 5297.0, 5594.0, 5666.0, 5437.0, 5385.0, 5326.0, 5585.0, 5404.0, 5559.0, 5540.0, 5457.0, 5306.0, 5357.0, 5655.0, 5434.0, 5402.0, 5319.0, 5415.0, 5601.0, 5388.0, 5680.0, 5401.0, 5264.0, 5400.0, 5416.0, 5712.0, 5290.0, 5330.0, 5627.0, 5604.0, 5451.0, 5709.0, 5620.0, 5710.0, 5324.0, 5255.0, 5721.0, 5354.0, 5282.0, 5463.0, 5489.0, 5580.0, 5337.0, 5348.0, 5691.0, 5508.0, 5696.0, 5715.0, 5492.0, 5535.0, 5436.0, 5628.0, 5682.0, 5446.0, 5417.0, 5558.0, 5574.0, 5625.0, 5360.0, 5285.0, 5445.0, 5616.0, 5293.0, 5630.0, 5490.0, 5317.0, 5386.0, 5613.0, 5292.0, 5629.0
14	5500	9	1	333	1	5252.0, 5661.0, 5711.0, 5689.0, 5541.0, 5591.0, 5295.0, 5355.0, 5575.0, 5379.0, 5581.0, 5289.0, 5481.0, 5286.0, 5441.0, 5305.0, 5717.0, 5614.0, 5332.0, 5501.0, 5511.0, 5545.0, 5414.0, 5327.0, 5348.0, 5428.0, 5354.0, 5709.0, 5362.0, 5690.0, 5550.0, 5539.0, 5666.0, 5671.0, 5336.0, 5611.0, 5526.0, 5723.0, 5446.0, 5389.0, 5266.0, 5557.0, 5296.0, 5598.0, 5520.0, 5506.0, 5504.0, 5499.0, 5374.0, 5584.0, 5329.0, 5331.0, 5255.0, 5641.0, 5326.0, 5579.0, 5606.0, 5719.0, 5308.0, 5583.0, 5478.0, 5432.0, 5440.0, 5694.0, 5261.0, 5569.0, 5533.0, 5437.0, 5417.0, 5459.0, 5337.0, 5663.0, 5463.0, 5325.0, 5589.0, 5623.0, 5631.0, 5479.0, 5489.0, 5530.0, 5467.0, 5675.0, 5613.0, 5699.0, 5474.0, 5503.0, 5290.0, 5350.0, 5487.0, 5632.0, 5385.0, 5523.0, 5708.0, 5363.0, 5677.0, 5345.0, 5555.0, 5597.0, 5315.0, 5610.0
15	5500	9	1	333	1	5285.0, 5603.0, 5303.0, 5251.0, 5298.0, 5406.0, 5395.0, 5569.0, 5533.0, 5380.0, 5564.0, 5696.0, 5543.0, 5450.0, 5646.0, 5692.0, 5268.0, 5258.0, 5471.0, 5435.0, 5347.0, 5405.0, 5378.0, 5554.0, 5269.0, 5339.0, 5491.0, 5688.0, 5716.0, 5516.0, 5428.0, 5458.0, 5631.0, 5373.0, 5309.0, 5492.0, 5322.0, 5260.0, 5348.0, 5280.0, 5327.0, 5512.0, 5672.0, 5371.0, 5527.0, 5486.0, 5396.0, 5472.0, 5641.0, 5434.0, 5261.0, 5355.0, 5626.0, 5419.0, 5403.0, 5571.0, 5366.0, 5644.0, 5277.0, 5497.0, 5305.0, 5667.0, 5257.0, 5561.0, 5550.0

						5368.0, 5519.0, 5711.0, 5392.0, 5588.0, 5697.0, 5409.0, 5473.0, 5404.0, 5585.0, 5640.0, 5494.0, 5385.0, 5664.0, 5507.0, 5341.0, 5545.0, 5266.0, 5576.0, 5709.0, 5364.0, 5604.0, 5410.0, 5281.0, 5400.0, 5645.0, 5326.0, 5399.0, 5628.0, 5678.0, 5704.0, 5265.0, 5451.0, 5633.0, 5509.0
16	5500	9	1	333	1	5713.0, 5469.0, 5645.0, 5342.0, 5297.0, 5612.0, 5541.0, 5354.0, 5254.0, 5591.0, 5322.0, 5604.0, 5344.0, 5264.0, 5548.0, 5436.0, 5494.0, 5523.0, 5450.0, 5468.0, 5252.0, 5698.0, 5360.0, 5441.0, 5364.0, 5586.0, 5309.0, 5594.0, 5634.0, 5255.0, 5657.0, 5520.0, 5397.0, 5347.0, 5485.0, 5289.0, 5550.0, 5467.0, 5306.0, 5394.0, 5542.0, 5492.0, 5675.0, 5718.0, 5387.0, 5317.0, 5583.0, 5275.0, 5311.0, 5522.0, 5528.0, 5325.0, 5406.0, 5491.0, 5393.0, 5478.0, 5363.0, 5302.0, 5456.0, 5377.0, 5501.0, 5670.0, 5298.0, 5518.0, 5632.0, 5701.0, 5582.0, 5346.0, 5476.0, 5664.0, 5404.0, 5585.0, 5666.0, 5652.0, 5668.0, 5599.0, 5299.0, 5399.0, 5606.0, 5314.0, 5536.0, 5395.0, 5296.0, 5561.0, 5642.0, 5373.0, 5305.0, 5707.0, 5680.0, 5544.0, 5678.0, 5392.0, 5251.0, 5508.0, 5329.0, 5669.0, 5262.0, 5452.0, 5627.0, 5382.0
17	5500	9	1	333	1	5343.0, 5335.0, 5408.0, 5276.0, 5543.0, 5354.0, 5723.0, 5630.0, 5432.0, 5357.0, 5476.0, 5628.0, 5260.0, 5332.0, 5546.0, 5455.0, 5703.0, 5545.0, 5548.0, 5352.0, 5394.0, 5708.0, 5588.0, 5553.0, 5573.0, 5290.0, 5721.0, 5486.0, 5480.0, 5280.0, 5468.0, 5608.0, 5435.0, 5597.0, 5416.0, 5521.0, 5426.0, 5705.0, 5623.0, 5472.0, 5611.0, 5421.0, 5419.0, 5482.0, 5298.0, 5516.0, 5287.0, 5355.0, 5722.0, 5697.0, 5422.0, 5356.0, 5283.0, 5606.0, 5665.0, 5288.0, 5478.0, 5537.0, 5612.0, 5701.0, 5505.0, 5702.0, 5492.0, 5650.0, 5679.0, 5473.0, 5436.0, 5520.0, 5640.0, 5304.0, 5636.0, 5624.0, 5491.0, 5594.0, 5600.0, 5423.0, 5360.0, 5593.0, 5273.0, 5414.0, 5255.0, 5502.0, 5483.0, 5320.0, 5667.0, 5494.0, 5493.0, 5531.0, 5411.0, 5652.0, 5396.0, 5586.0, 5289.0, 5632.0, 5615.0, 5397.0, 5444.0, 5263.0, 5566.0, 5661.0
18	5500	9	1	333	1	5351.0, 5632.0, 5627.0, 5571.0, 5307.0, 5502.0, 5295.0, 5721.0, 5277.0, 5583.0, 5706.0, 5310.0, 5361.0, 5347.0, 5576.0, 5423.0, 5511.0, 5648.0, 5539.0, 5476.0, 5449.0, 5343.0, 5251.0, 5616.0, 5411.0, 5507.0, 5510.0, 5287.0, 5540.0, 5617.0, 5561.0, 5474.0, 5276.0, 5261.0, 5558.0, 5442.0, 5342.0, 5665.0, 5601.0, 5304.0, 5693.0, 5281.0, 5471.0, 5620.0, 5317.0, 5708.0, 5623.0, 5654.0, 5349.0, 5440.0, 5658.0, 5618.0, 5533.0, 5367.0, 5534.0, 5529.0, 5681.0, 5579.0, 5383.0, 5353.0, 5704.0, 5312.0, 5472.0, 5301.0, 5555.0

						5685.0, 5582.0, 5392.0, 5581.0, 5516.0, 5573.0, 5530.0, 5594.0, 5553.0, 5629.0, 5407.0, 5269.0, 5557.0, 5253.0, 5268.0, 5309.0, 5252.0, 5513.0, 5586.0, 5504.0, 5417.0, 5700.0, 5500.0, 5547.0, 5283.0, 5447.0, 5550.0, 5403.0, 5300.0, 5415.0, 5467.0, 5536.0, 5356.0, 5328.0, 5437.0
19	5500	9	1	333	1	5717.0, 5408.0, 5449.0, 5569.0, 5708.0, 5542.0, 5576.0, 5342.0, 5379.0, 5458.0, 5402.0, 5263.0, 5254.0, 5273.0, 5626.0, 5646.0, 5530.0, 5651.0, 5343.0, 5658.0, 5527.0, 5553.0, 5655.0, 5477.0, 5292.0, 5675.0, 5721.0, 5431.0, 5362.0, 5583.0, 5324.0, 5492.0, 5659.0, 5387.0, 5670.0, 5415.0, 5291.0, 5388.0, 5411.0, 5601.0, 5478.0, 5279.0, 5538.0, 5448.0, 5582.0, 5357.0, 5680.0, 5356.0, 5529.0, 5724.0, 5401.0, 5500.0, 5696.0, 5474.0, 5456.0, 5466.0, 5299.0, 5282.0, 5619.0, 5697.0, 5548.0, 5597.0, 5261.0, 5610.0, 5550.0, 5301.0, 5649.0, 5693.0, 5678.0, 5574.0, 5704.0, 5443.0, 5407.0, 5470.0, 5397.0, 5627.0, 5314.0, 5506.0, 5480.0, 5380.0, 5290.0, 5545.0, 5322.0, 5358.0, 5294.0, 5417.0, 5598.0, 5536.0, 5396.0, 5484.0, 5473.0, 5395.0, 5307.0, 5262.0, 5665.0, 5461.0, 5268.0, 5375.0, 5652.0, 5502.0
20	5500	9	1	333	1	5274.0, 5290.0, 5450.0, 5633.0, 5648.0, 5499.0, 5439.0, 5601.0, 5521.0, 5328.0, 5342.0, 5267.0, 5703.0, 5606.0, 5273.0, 5372.0, 5542.0, 5484.0, 5620.0, 5472.0, 5494.0, 5500.0, 5597.0, 5594.0, 5332.0, 5587.0, 5277.0, 5360.0, 5436.0, 5511.0, 5296.0, 5304.0, 5428.0, 5464.0, 5609.0, 5723.0, 5592.0, 5254.0, 5431.0, 5519.0, 5611.0, 5573.0, 5435.0, 5710.0, 5522.0, 5584.0, 5549.0, 5640.0, 5351.0, 5517.0, 5626.0, 5409.0, 5621.0, 5546.0, 5379.0, 5283.0, 5695.0, 5329.0, 5307.0, 5538.0, 5454.0, 5474.0, 5349.0, 5433.0, 5391.0, 5595.0, 5438.0, 5314.0, 5468.0, 5446.0, 5618.0, 5491.0, 5325.0, 5327.0, 5361.0, 5541.0, 5627.0, 5485.0, 5381.0, 5417.0, 5607.0, 5312.0, 5505.0, 5258.0, 5720.0, 5664.0, 5301.0, 5276.0, 5554.0, 5677.0, 5624.0, 5380.0, 5430.0, 5389.0, 5568.0, 5302.0, 5305.0, 5358.0, 5563.0, 5507.0
21	5500	9	1	333	1	5606.0, 5486.0, 5325.0, 5399.0, 5691.0, 5672.0, 5563.0, 5327.0, 5617.0, 5542.0, 5712.0, 5534.0, 5395.0, 5284.0, 5553.0, 5713.0, 5324.0, 5358.0, 5609.0, 5472.0, 5352.0, 5355.0, 5387.0, 5283.0, 5711.0, 5488.0, 5397.0, 5698.0, 5366.0, 5437.0, 5361.0, 5585.0, 5650.0, 5267.0, 5531.0, 5333.0, 5410.0, 5518.0, 5394.0, 5404.0, 5595.0, 5271.0, 5596.0, 5644.0, 5446.0, 5685.0, 5310.0, 5639.0, 5383.0, 5615.0, 5469.0, 5298.0, 5374.0, 5533.0, 5364.0, 5309.0, 5348.0, 5652.0, 5570.0, 5532.0, 5492.0, 5462.0, 5382.0, 5354.0, 5431.0,

						5403.0, 5536.0, 5535.0, 5694.0, 5613.0, 5591.0, 5654.0, 5568.0, 5559.0, 5334.0, 5676.0, 5705.0, 5343.0, 5500.0, 5538.0, 5665.0, 5487.0, 5576.0, 5416.0, 5677.0, 5292.0, 5466.0, 5649.0, 5337.0, 5529.0, 5368.0, 5346.0, 5605.0, 5398.0, 5695.0, 5580.0, 5428.0, 5689.0, 5640.0, 5558.0
22	5500	9	1	333	1	5612.0, 5489.0, 5313.0, 5693.0, 5511.0, 5407.0, 5492.0, 5488.0, 5480.0, 5576.0, 5254.0, 5286.0, 5571.0, 5626.0, 5397.0, 5287.0, 5615.0, 5308.0, 5637.0, 5641.0, 5625.0, 5543.0, 5655.0, 5634.0, 5598.0, 5302.0, 5590.0, 5477.0, 5525.0, 5320.0, 5589.0, 5533.0, 5273.0, 5704.0, 5416.0, 5506.0, 5277.0, 5686.0, 5469.0, 5291.0, 5441.0, 5379.0, 5646.0, 5372.0, 5387.0, 5334.0, 5708.0, 5400.0, 5673.0, 5322.0, 5380.0, 5619.0, 5276.0, 5549.0, 5408.0, 5523.0, 5700.0, 5679.0, 5385.0, 5544.0, 5315.0, 5449.0, 5442.0, 5499.0, 5596.0, 5450.0, 5258.0, 5575.0, 5519.0, 5481.0, 5620.0, 5541.0, 5329.0, 5656.0, 5368.0, 5444.0, 5362.0, 5451.0, 5703.0, 5715.0, 5600.0, 5346.0, 5551.0, 5476.0, 5434.0, 5711.0, 5585.0, 5433.0, 5617.0, 5580.0, 5338.0, 5651.0, 5627.0, 5421.0, 5542.0, 5717.0, 5446.0, 5521.0, 5340.0, 5335.0
23	5500	9	1	333	1	5294.0, 5301.0, 5612.0, 5494.0, 5543.0, 5430.0, 5629.0, 5292.0, 5495.0, 5568.0, 5609.0, 5678.0, 5472.0, 5546.0, 5263.0, 5578.0, 5320.0, 5530.0, 5601.0, 5368.0, 5510.0, 5672.0, 5711.0, 5554.0, 5421.0, 5654.0, 5531.0, 5341.0, 5325.0, 5310.0, 5291.0, 5634.0, 5635.0, 5354.0, 5392.0, 5442.0, 5356.0, 5398.0, 5508.0, 5718.0, 5285.0, 5346.0, 5507.0, 5321.0, 5394.0, 5511.0, 5373.0, 5406.0, 5423.0, 5335.0, 5721.0, 5570.0, 5340.0, 5262.0, 5574.0, 5514.0, 5382.0, 5515.0, 5651.0, 5440.0, 5503.0, 5548.0, 5540.0, 5703.0, 5362.0, 5639.0, 5684.0, 5332.0, 5710.0, 5317.0, 5479.0, 5610.0, 5415.0, 5416.0, 5555.0, 5478.0, 5665.0, 5486.0, 5407.0, 5501.0, 5528.0, 5460.0, 5329.0, 5343.0, 5470.0, 5454.0, 5633.0, 5586.0, 5283.0, 5258.0, 5419.0, 5685.0, 5599.0, 5485.0, 5655.0, 5465.0, 5464.0, 5328.0, 5447.0, 5573.0
24	5500	9	1	333	1	5503.0, 5399.0, 5695.0, 5298.0, 5688.0, 5567.0, 5370.0, 5325.0, 5617.0, 5408.0, 5578.0, 5693.0, 5634.0, 5350.0, 5288.0, 5611.0, 5448.0, 5662.0, 5510.0, 5547.0, 5308.0, 5632.0, 5686.0, 5513.0, 5312.0, 5485.0, 5591.0, 5323.0, 5677.0, 5586.0, 5292.0, 5716.0, 5293.0, 5397.0, 5377.0, 5538.0, 5398.0, 5609.0, 5337.0, 5710.0, 5478.0, 5501.0, 5457.0, 5486.0, 5462.0, 5585.0, 5722.0, 5277.0, 5433.0, 5544.0, 5476.0, 5443.0, 5258.0, 5692.0, 5254.0, 5283.0, 5576.0, 5608.0, 5401.0, 5574.0, 5690.0, 5415.0, 5311.0, 5679.0, 5708.0

						5451.0, 5431.0, 5344.0, 5592.0, 5721.0, 5554.0, 5534.0, 5276.0, 5720.0, 5360.0, 5358.0, 5579.0, 5666.0, 5655.0, 5383.0, 5663.0, 5426.0, 5372.0, 5456.0, 5380.0, 5346.0, 5577.0, 5467.0, 5375.0, 5509.0, 5440.0, 5275.0, 5712.0, 5525.0, 5384.0, 5421.0, 5395.0, 5320.0, 5425.0, 5418.0
25	5500	9	1	333	1	5364.0, 5516.0, 5647.0, 5355.0, 5304.0, 5266.0, 5534.0, 5707.0, 5592.0, 5519.0, 5661.0, 5537.0, 5584.0, 5635.0, 5666.0, 5330.0, 5375.0, 5610.0, 5510.0, 5511.0, 5507.0, 5293.0, 5483.0, 5522.0, 5502.0, 5625.0, 5427.0, 5545.0, 5515.0, 5652.0, 5476.0, 5366.0, 5562.0, 5492.0, 5305.0, 5603.0, 5434.0, 5456.0, 5717.0, 5329.0, 5359.0, 5322.0, 5613.0, 5508.0, 5722.0, 5566.0, 5458.0, 5337.0, 5579.0, 5341.0, 5693.0, 5680.0, 5518.0, 5646.0, 5326.0, 5306.0, 5619.0, 5710.0, 5682.0, 5571.0, 5544.0, 5662.0, 5448.0, 5500.0, 5643.0, 5440.0, 5347.0, 5352.0, 5663.0, 5701.0, 5313.0, 5564.0, 5533.0, 5267.0, 5447.0, 5425.0, 5383.0, 5438.0, 5679.0, 5686.0, 5275.0, 5284.0, 5623.0, 5406.0, 5672.0, 5296.0, 5574.0, 5595.0, 5292.0, 5285.0, 5398.0, 5594.0, 5542.0, 5658.0, 5314.0, 5540.0, 5413.0, 5639.0, 5428.0, 5446.0
26	5500	9	1	333	1	5672.0, 5640.0, 5567.0, 5400.0, 5536.0, 5403.0, 5542.0, 5588.0, 5382.0, 5709.0, 5476.0, 5525.0, 5508.0, 5633.0, 5424.0, 5645.0, 5642.0, 5620.0, 5563.0, 5278.0, 5346.0, 5473.0, 5367.0, 5319.0, 5553.0, 5650.0, 5516.0, 5629.0, 5307.0, 5371.0, 5328.0, 5300.0, 5590.0, 5594.0, 5661.0, 5347.0, 5357.0, 5276.0, 5657.0, 5627.0, 5693.0, 5678.0, 5412.0, 5513.0, 5312.0, 5569.0, 5713.0, 5426.0, 5420.0, 5712.0, 5396.0, 5496.0, 5623.0, 5448.0, 5294.0, 5698.0, 5597.0, 5606.0, 5625.0, 5609.0, 5283.0, 5408.0, 5600.0, 5286.0, 5397.0, 5526.0, 5684.0, 5628.0, 5384.0, 5425.0, 5259.0, 5273.0, 5718.0, 5267.0, 5358.0, 5648.0, 5266.0, 5682.0, 5388.0, 5341.0, 5302.0, 5453.0, 5472.0, 5324.0, 5310.0, 5510.0, 5655.0, 5519.0, 5440.0, 5551.0, 5537.0, 5254.0, 5458.0, 5506.0, 5410.0, 5463.0, 5521.0, 5299.0, 5449.0, 5613.0
27	5500	9	1	333	1	5371.0, 5318.0, 5608.0, 5319.0, 5576.0, 5658.0, 5483.0, 5440.0, 5624.0, 5377.0, 5656.0, 5476.0, 5539.0, 5651.0, 5453.0, 5680.0, 5332.0, 5678.0, 5469.0, 5357.0, 5412.0, 5696.0, 5616.0, 5492.0, 5692.0, 5344.0, 5720.0, 5390.0, 5621.0, 5578.0, 5718.0, 5617.0, 5353.0, 5360.0, 5662.0, 5309.0, 5511.0, 5446.0, 5577.0, 5661.0, 5288.0, 5465.0, 5363.0, 5342.0, 5422.0, 5670.0, 5339.0, 5454.0, 5403.0, 5397.0, 5354.0, 5506.0, 5366.0, 5253.0, 5516.0, 5488.0, 5605.0, 5277.0, 5438.0, 5347.0, 5691.0, 5419.0, 5387.0, 5471.0, 5329.0

						5265.0, 5501.0, 5275.0, 5694.0, 5480.0, 5585.0, 5645.0, 5709.0, 5523.0, 5514.0, 5256.0, 5625.0, 5443.0, 5251.0, 5261.0, 5457.0, 5558.0, 5532.0, 5315.0, 5250.0, 5640.0, 5487.0, 5287.0, 5270.0, 5364.0, 5566.0, 5490.0, 5365.0, 5306.0, 5455.0, 5565.0, 5638.0, 5534.0, 5430.0, 5580.0
28	5500	9	1	333	1	5429.0, 5620.0, 5678.0, 5662.0, 5261.0, 5364.0, 5607.0, 5308.0, 5453.0, 5382.0, 5667.0, 5363.0, 5512.0, 5621.0, 5636.0, 5267.0, 5432.0, 5692.0, 5677.0, 5474.0, 5370.0, 5516.0, 5648.0, 5688.0, 5312.0, 5473.0, 5330.0, 5257.0, 5426.0, 5671.0, 5654.0, 5540.0, 5458.0, 5491.0, 5619.0, 5347.0, 5384.0, 5543.0, 5368.0, 5638.0, 5712.0, 5537.0, 5264.0, 5416.0, 5687.0, 5443.0, 5304.0, 5698.0, 5495.0, 5663.0, 5329.0, 5413.0, 5579.0, 5391.0, 5309.0, 5679.0, 5572.0, 5720.0, 5525.0, 5593.0, 5718.0, 5291.0, 5469.0, 5288.0, 5338.0, 5567.0, 5467.0, 5436.0, 5613.0, 5534.0, 5642.0, 5544.0, 5483.0, 5298.0, 5419.0, 5587.0, 5696.0, 5477.0, 5265.0, 5475.0, 5456.0, 5545.0, 5653.0, 5410.0, 5439.0, 5601.0, 5631.0, 5645.0, 5418.0, 5275.0, 5563.0, 5422.0, 5279.0, 5535.0, 5348.0, 5266.0, 5276.0, 5568.0, 5719.0, 5672.0
29	5500	9	1	333	1	5593.0, 5283.0, 5414.0, 5370.0, 5588.0, 5625.0, 5468.0, 5448.0, 5610.0, 5661.0, 5323.0, 5513.0, 5497.0, 5439.0, 5459.0, 5269.0, 5493.0, 5501.0, 5490.0, 5626.0, 5541.0, 5551.0, 5265.0, 5255.0, 5538.0, 5502.0, 5615.0, 5399.0, 5586.0, 5403.0, 5268.0, 5318.0, 5288.0, 5690.0, 5454.0, 5499.0, 5577.0, 5503.0, 5258.0, 5624.0, 5337.0, 5714.0, 5262.0, 5522.0, 5498.0, 5303.0, 5374.0, 5483.0, 5580.0, 5281.0, 5433.0, 5470.0, 5563.0, 5644.0, 5476.0, 5365.0, 5371.0, 5631.0, 5534.0, 5632.0, 5515.0, 5351.0, 5525.0, 5376.0, 5455.0, 5272.0, 5670.0, 5257.0, 5474.0, 5526.0, 5346.0, 5411.0, 5666.0, 5353.0, 5647.0, 5290.0, 5336.0, 5438.0, 5550.0, 5388.0, 5444.0, 5485.0, 5600.0, 5274.0, 5430.0, 5561.0, 5319.0, 5378.0, 5291.0, 5576.0, 5708.0, 5423.0, 5402.0, 5571.0, 5464.0, 5358.0, 5375.0, 5284.0, 5638.0, 5287.0
30	5500	9	1	333	1	5440.0, 5402.0, 5272.0, 5486.0, 5548.0, 5608.0, 5347.0, 5378.0, 5582.0, 5517.0, 5301.0, 5427.0, 5292.0, 5397.0, 5314.0, 5684.0, 5712.0, 5255.0, 5436.0, 5606.0, 5513.0, 5359.0, 5588.0, 5529.0, 5452.0, 5556.0, 5572.0, 5469.0, 5560.0, 5677.0, 5715.0, 5538.0, 5645.0, 5353.0, 5447.0, 5536.0, 5269.0, 5392.0, 5414.0, 5579.0, 5583.0, 5711.0, 5719.0, 5441.0, 5281.0, 5704.0, 5509.0, 5433.0, 5311.0, 5555.0, 5559.0, 5421.0, 5435.0, 5368.0, 5634.0, 5544.0, 5323.0, 5629.0, 5585.0, 5365.0, 5470.0, 5404.0, 5330.0, 5661.0, 5660.0

						5505.0, 5566.0, 5596.0, 5687.0, 5609.0, 5550.0, 5520.0, 5666.0, 5450.0, 5363.0, 5508.0, 5278.0, 5289.0, 5475.0, 5276.0, 5251.0, 5432.0, 5604.0, 5620.0, 5342.0, 5356.0, 5277.0, 5724.0, 5637.0, 5670.0, 5341.0, 5259.0, 5495.0, 5631.0, 5718.0, 5446.0, 5357.0, 5524.0, 5279.0, 5326.0
--	--	--	--	--	--	--

40MHz

Radar SignalType	Waveform/Trial Number	Detection (%)	Limit (%)	Pass/Fail
Type 1A	15	100%	60%	pass
Type 1B	15	100%	60%	pass
Type 2	30	100 %	60%	Pass
Type 3	30	100 %	60%	Pass
Type 4	30	96.7 %	60%	Pass
Aggregate(Type1 to 4)	120	99%	80%	Pass
Type 5	30	100 %	80%	Pass
Type 6	30	100 %	70%	Pass

Please refer to the following statistical tables:

5510MHz**Radar Type 1A Statistical Performance**

Trial #	Fc (MHz)	Pulse/Burst	Pulse Width (μS)	PRI (μs)	Detection (1:yes; 0:no)
1	5510	83	1	638	1
2	5510	99	1	538	1
3	5510	59	1	898	1
4	5510	95	1	558	1
5	5510	72	1	738	1
6	5510	63	1	838	1
7	5510	102	1	518	1
8	5510	62	1	858	1
9	5510	70	1	758	1
10	5510	58	1	918	1
11	5510	81	1	658	1
12	5510	67	1	798	1
13	5510	68	1	778	1
14	5510	76	1	698	1
15	5510	89	1	598	1
Detection Percentage: 100 % (>60%)					

Radar Type 1B Statistical Performance

Trial #	Fc (MHz)	Pulse/Burst	Pulse Width (μS)	PRI (μs)	Detection (1:yes; 0:no)
1	5510	24	1	2263	1
2	5510	31	1	1738	1
3	5510	24	1	2221	1
4	5510	57	1	942	1
5	5510	21	1	2617	1
6	5510	18	1	2955	1
7	5510	40	1	1350	1
8	5510	37	1	1432	1
9	5510	27	1	1997	1
10	5510	29	1	1826	1
11	5510	37	1	1436	1
12	5510	40	1	1335	1
13	5510	24	1	2204	1
14	5510	81	1	659	1
15	5510	97	1	548	1
Detection Percentage: 100 % (>60%)					

Radar Type 2 Statistical Performance

Trial #	Fc (MHz)	Pulse/Burst	Pulse Width (μS)	PRI (μs)	Detection (1:yes; 0:no)
1	5510	27	4.5	217	1
2	5510	27	4	157	1
3	5510	25	2.9	195	1
4	5510	29	3	163	1
5	5510	25	4.9	196	1
6	5510	26	3.3	163	1
7	5510	23	2.4	151	1
8	5510	26	3.3	200	1
9	5510	26	4.9	227	1
10	5510	29	1.6	167	1
11	5510	29	4.8	196	1
12	5510	23	5	206	1
13	5510	23	2.6	199	1
14	5510	28	4	197	1
15	5510	23	1.1	164	1
16	5510	24	3.4	228	1
17	5510	23	2	159	1
18	5510	24	1.2	165	1
19	5510	25	4.4	214	1
20	5510	23	4.1	152	1
21	5510	25	3.8	189	1
22	5510	26	3.5	178	1
23	5510	29	2.3	189	1
24	5510	24	4.7	159	1
25	5510	27	3.5	166	1
26	5510	27	2.4	153	1
27	5510	23	1.6	208	1
28	5510	24	4.6	216	1
29	5510	23	3.5	212	1
30	5510	23	3.5	166	1
31	5510	23	3	184	1
Detection Percentage: 100 % (>60%)					

Radar Type 3 Statistical Performance

Trial #	Fc (MHz)	Pulse/Burst	Pulse Width (μS)	PRI (μs)	Detection (1:yes; 0:no)
1	5510	16	6.5	260	1
2	5510	16	9.9	363	1
3	5510	16	8	364	1
4	5510	17	6.8	296	1
5	5510	17	8.2	440	1
6	5510	17	7.7	214	1
7	5510	16	7.3	238	1
8	5510	16	9.1	310	1
9	5510	18	7.9	257	1
10	5510	18	8	420	1
11	5510	16	8.2	286	1
12	5510	17	9.4	405	1
13	5510	18	6.8	443	1
14	5510	16	6.9	200	1
15	5510	17	6.9	220	1
16	5510	16	9.1	479	1
17	5510	16	8.5	404	1
18	5510	17	8.2	325	1
19	5510	16	8.6	462	1
20	5510	16	9.3	276	1
21	5510	16	9.3	242	1
22	5510	16	9.9	246	1
23	5510	17	8.6	430	1
24	5510	16	7.3	208	1
25	5510	16	6.4	417	1
26	5510	16	8	420	1
27	5510	17	10	468	1
28	5510	18	7.5	332	1
29	5510	17	6.3	220	1
30	5510	18	7.4	268	1
Detection Percentage: 100 % (>60%)					

Radar Type 4 Statistical Performance

Trial #	Fc (MHz)	Pulse/Burst	Pulse Width (μS)	PRI (μs)	Detection (1:yes; 0:no)
1	5510	15	16.7	310	1
2	5510	12	17	283	1
3	5510	13	13.6	325	1
4	5510	16	18.6	316	1
5	5510	15	18.4	472	1
6	5510	14	16.7	451	1
7	5510	14	18.9	436	1
8	5510	12	17.1	264	1
9	5510	13	14	230	1
10	5510	14	12.2	201	1
11	5510	14	18.6	349	1
12	5510	14	15.1	414	1
13	5510	16	11.5	339	1
14	5510	16	13.4	317	1
15	5510	13	16.1	339	1
16	5510	16	11.7	223	1
17	5510	15	19.1	228	1
18	5510	14	13.2	228	1
19	5510	13	13.7	450	0
20	5510	12	14.5	208	1
21	5510	12	11.3	460	1
22	5510	14	15.1	459	1
23	5510	16	11.9	443	1
24	5510	14	16.8	210	1
25	5510	15	11.5	400	1
26	5510	12	19.9	269	1
27	5510	15	11.3	466	1
28	5510	14	17.7	379	1
29	5510	16	15.3	469	1
30	5510	12	14.6	218	1
Detection Percentage: 96.7 % (>60%)					

Radar Type 5 Case 1 Statistical Performance

Statistics 1 (ChirpCenter Frequency: 5510.0MHz)

Trial #	Pulse	Chirp(MHz)	Pulse Width (µS)	Pulse 1-2 spacing(µS)	Pulse 2-3 spacing(µS)	Pulse Start(S)	Detection (1:yes;0:no)
0	1	14	95.4			0.173152	1
1	2	14	72.5	1491		1.022667	
2	1	14	63.4			1.396165	
3	1	14	57.6			2.300257	
4	3	14	93.1	1383	1493	2.602863	
5	3	14	88.3	1290	1409	3.016037	
6	2	14	76.4	1866		3.94267	
7	2	14	79.7	1047		4.24388	
8	2	14	54.4	1275		5.349747	
9	1	14	97.1			5.685467	
10	2	14	66.1	1871		6.352505	
11	3	14	79.4	1928	1875	6.614376	
12	1	14	89.3			7.371587	
13	3	14	86	1157	1811	7.933237	
14	3	14	53.3	1422	1982	8.991991	
15	3	14	58.6	1520	1636	9.506874	
16	2	14	86.6	1907		9.822298	
17	2	14	85.2	1075		10.48712	
18	2	14	83.8	1016		10.8754	
19	2	14	67.1	1196		11.77852	

Statistics 2 (ChirpCenter Frequency: 5510.0 MHz)

Trial #	Pulse	Chirp(MHz)	Pulse Width (µS)	Pulse 1-2 spacing(µS)	Pulse 2-3 spacing(µS)	Pulse Start(S)	Detection (1:yes;0:no)
0	2	13	58.6	1228		0.223454	1
1	2	13	53.9	1394		0.986913	
2	3	13	80.9	1724	1922	1.616238	
3	3	13	59.6	1873	1531	2.77603	
4	2	13	88	1854		3.757118	
5	2	13	98.2	1786		4.744683	
6	2	13	74.1	1542		4.942867	
7	1	13	85.9			6.014678	
8	1	13	57.8			6.43062	
9	2	13	77.8	1342		7.819734	
10	2	13	78.3	1671		8.225843	
11	2	13	68.3	1801		9.474421	
12	3	13	98.9	1036	1600	9.779097	
13	2	13	57.5	1313		10.70222	
14	3	13	50.5	1430	1994	11.77323	

Statistics 3 (ChirpCenter Frequency: 5510.0 MHz)

Trial #	Pulse	Chirp(MHz)	Pulse Width (μS)	Pulse 1-2 spacing(μS)	Pulse 2-3 spacing(μS)	Pulse Start(S)	Detection (1:yes;0:no)
0	2	16	96	1823		0.422686	1
1	1	16	61.1			1.125424	
2	3	16	55.9	1185	1305	2.848185	
3	3	16	86.8	1017	1815	3.420548	
4	3	16	62.9	1869	1950	5.081175	
5	3	16	84	1965	1522	5.86403	
6	2	16	64.5	1165		7.13248	
7	3	16	61	1984	1266	8.204225	
8	2	16	69.8	1405		8.741993	
9	2	16	88.8	1830		10.3722	
10	2	16	98.3	1661		11.59719	

Statistics 4 (ChirpCenter Frequency: 5510.0 MHz)

Trial #	Pulse	Chirp(MHz)	Pulse Width (μS)	Pulse 1-2 spacing(μS)	Pulse 2-3 spacing(μS)	Pulse Start(S)	Detection (1:yes;0:no)
0	2	12	84.8	1817		0.706664	1
1	2	12	91.5	1842		1.062762	
2	2	12	57.9	1237		2.748504	
3	2	12	85.5	1772		3.095061	
4	2	12	91.3	1530		4.421171	
5	2	12	97.4	1964		4.979899	
6	2	12	82.7	1727		5.673759	
7	2	12	99.2	1806		7.209514	
8	3	12	99.6	1732	1574	8.198253	
9	3	12	85.9	1106	1254	9.129588	
10	3	12	84.3	1131	1674	9.639739	
11	3	12	98.4	1602	1795	10.19649	
12	1	12	64.9			11.68874	

Statistics 5(ChirpCenter Frequency: 5510.0 MHz)

Trial #	Pulse	Chirp(MHz)	Pulse Width (μS)	Pulse 1-2 spacing(μS)	Pulse 2-3 spacing(μS)	Pulse Start(S)	Detection (1:yes;0:no)
0	3	13	92.5	1567	1437	0.233937	1
1	2	13	61.3	1121		1.598245	
2	2	13	81.6	1657		2.527582	
3	2	13	67.5	1440		3.391503	
4	3	13	92.7	1336	1193	3.929754	
5	2	13	52.9	1756		5.223333	
6	3	13	93.4	1675	1346	6.174211	
7	2	13	77.7	1711		7.131352	
8	2	13	67.3	1804		8.258207	
9	1	13	59.5			9.062051	
10	3	13	86.5	1442	1668	9.76706	
11	3	13	72.7	1594	1556	10.59165	
12	2	13	54.2	1039		11.68625	

Statistics 6 (ChirpCenter Frequency: 5510.0 MHz)

Trial #	Pulse	Chirp(MHz)	Pulse Width (μS)	Pulse 1-2 spacing(μS)	Pulse 2-3 spacing(μS)	Pulse Start(S)	Detection (1:yes;0:no)
0	2	12	74	1795		1.065684	1
1	2	12	65	1659		1.715656	
2	2	12	53.5	1479		2.563665	
3	1	12	66.8			3.784378	
4	2	12	74.8	1503		5.375901	
5	3	12	81.2	1115	1406	6.362695	
6	2	12	84.4	1115		6.653073	
7	3	12	80.3	1176	1444	8.459094	
8	1	12	92			9.590524	
9	1	12	93.2			10.08203	
10	2	12	68.2	1186		11.46773	

Statistics 7(ChirpCenter Frequency: 5510.0 MHz)

Trial #	Pulse	Chirp(MHz)	Pulse Width (μS)	Pulse 1-2 spacing(μS)	Pulse 2-3 spacing(μS)	Pulse Start(S)	Detection (1:yes;0:no)
0	3	15	94.9	1509	1332	0.496776	1
1	2	15	98.9	1340		0.738153	
2	2	15	99.6	1249		1.693698	
3	1	15	53.1			2.321088	
4	1	15	61.3			2.730727	
5	3	15	61.7	1754	1620	3.186962	
6	1	15	87.2			3.837206	
7	1	15	56.3			4.47632	
8	1	15	73.4			5.083165	
9	2	15	84.9	1341		5.97941	
10	2	15	77.9	1029		6.63429	
11	2	15	59.1	1170		7.154779	
12	2	15	85.6	1291		7.934818	
13	1	15	92.4			8.243851	
14	2	15	63.9	1236		9.109943	
15	2	15	92.3	1430		9.717049	
16	2	15	91.9	1538		10.50191	
17	1	15	97.6			10.94968	
18	3	15	95.7	1531	1955	11.58544	

Statistics 8 (ChirpCenter Frequency: 5510.0 MHz)

Trial #	Pulse	Chirp(MHz)	Pulse Width (μS)	Pulse 1-2 spacing(μS)	Pulse 2-3 spacing(μS)	Pulse Start(S)	Detection (1:yes;0:no)
0	1	16	50.1			0.209588	1
1	3	16	89.6	1540	1932	1.616576	
2	2	16	81.8	1961		3.582035	
3	2	16	97.3	1842		4.109759	
4	1	16	82.4			5.060558	
5	3	16	63.3	1012	1275	6.511268	
6	3	16	78.1	1456	1500	7.570979	
7	1	16	79.8			8.619637	
8	2	16	85.9	1722		10.59906	
9	2	16	55.3	1185		11.80082	

Statistics 9 (ChirpCenter Frequency: 5510.0 MHz)

Trial #	Pulse	Chirp(MHz)	Pulse Width (μS)	Pulse 1-2 spacing(μS)	Pulse 2-3 spacing(μS)	Pulse Start(S)	Detection (1:yes;0:no)
0	2	9	83.1	1224		0.228633	1
1	3	9	67.5	1506	1634	0.95461	
2	2	9	77.4	1353		1.850179	
3	3	9	80.8	1632	1154	1.940066	
4	2	9	74.1	1856		3.066437	
5	1	9	83.3			3.207182	
6	2	9	63.7	1743		4.308536	
7	1	9	51.9			4.699493	
8	2	9	53.8	1794		5.467144	
9	2	9	89.9	1264		6.078712	
10	1	9	54.3			6.431081	
11	2	9	63	1982		7.214222	
12	1	9	75.1			8.177643	
13	2	9	77.8	1666		8.484047	
14	1	9	93.6			9.072546	
15	2	9	53.5	1014		9.554896	
16	3	9	55.4	1333	1029	10.62505	
17	3	9	84.7	1929	1960	11.19284	
18	3	9	56.9	1868	1064	11.50304	

Statistics 10 (ChirpCenter Frequency: 5510.0 MHz)

Trial #	Pulse	Chirp(MHz)	Pulse Width (μS)	Pulse 1-2 spacing(μS)	Pulse 2-3 spacing(μS)	Pulse Start(S)	Detection (1:yes;0:no)
0	2	14	53.5	1714		1.085798	1
1	2	14	74.7	1638		1.536553	
2	1	14	81.3			3.802815	
3	3	14	71.3	1485	1653	5.436103	
4	3	14	89.8	1324	1004	6.964741	
5	2	14	57.8	1714		8.302782	
6	2	14	73.9	1926		9.255269	
7	2	14	50.2	1871		11.40707	

Radar Type 5 Case 2 Statistical Performance

Statistics 1 (ChirpCenter Frequency: 5496.0 MHz)

Trial #	Pulse	Chirp(MHz)	Pulse Width (μS)	Pulse 1-2 spacing(μS)	Pulse 2-3 spacing(μS)	Pulse Start(S)	Detection (1:yes;0:no)
0	1	16	61.3			0.613273	1
1	1	16	64.2			1.117766	
2	2	16	95.8	1920		2.457819	
3	3	16	71.3	1484	1494	3.10583	
4	1	16	90.7			4.021992	
5	2	16	70.3	1285		5.044718	
6	1	16	72.5			6.987128	
7	1	16	59.2			7.883557	
8	2	16	88.1	1938		8.060022	
9	2	16	56.1	1632		9.165365	
10	1	16	90.9			10.01269	
11	3	16	93.7	1555	1908	11.92796	

Statistics 2 (ChirpCenter Frequency: 5494.0 MHz)

Trial #	Pulse	Chirp(MHz)	Pulse Width (μS)	Pulse 1-2 spacing(μS)	Pulse 2-3 spacing(μS)	Pulse Start(S)	Detection (1:yes;0:no)
0	3	10	74	1364	1668	0.70744	1
1	2	10	72.3	1823		1.060446	
2	1	10	78.7			1.54011	
3	2	10	58.6	1074		2.609571	
4	2	10	73	1407		3.396211	
5	1	10	83.1			4.359888	
6	3	10	53.4	1740	1576	5.042479	
7	2	10	57.6	1424		5.978305	
8	1	10	98.9			6.712167	
9	3	10	62	1955	1414	7.143039	
10	3	10	83.2	1970	1613	7.961463	
11	2	10	61.4	1763		8.525376	
12	3	10	90.4	1027	1280	9.705061	
13	1	10	75.7			10.41107	
14	1	10	98.3			10.94797	
15	2	10	64.4	1126		11.47675	

Statistics 3 (ChirpCenter Frequency: 5494.0 MHz)

Trial #	Pulse	Chirp(MHz)	Pulse Width (μS)	Pulse 1-2 spacing(μS)	Pulse 2-3 spacing(μS)	Pulse Start(S)	Detection (1:yes;0:no)
0	1	11	53.7			0.824768	1
1	1	11	83.1			2.053985	
2	3	11	73.9	1287	1226	2.702861	
3	2	11	72.5	1350		4.130902	
4	2	11	73.2	1198		5.109704	
5	2	11	68.3	1111		6.256003	
6	1	11	67			7.5032	
7	1	11	80.8			8.003327	
8	2	11	98.7	1008		9.611551	
9	1	11	80			9.988807	
10	2	11	87.3	1339		11.3601	

Statistics 4 (ChirpCenter Frequency: 5494.0 MHz)

Trial #	Pulse	Chirp(MHz)	Pulse Width (μS)	Pulse 1-2 spacing(μS)	Pulse 2-3 spacing(μS)	Pulse Start(S)	Detection (1:yes;0:no)
0	3	10	81.8	1605	1846	0.32354	1
1	1	10	78.9			1.355421	
2	3	10	92.6	1814	1546	1.896782	
3	2	10	57.5	1048		3.346272	
4	2	10	52.9	1052		4.075788	
5	3	10	61.1	1700	1109	4.597862	
6	2	10	78.4	1925		5.210371	
7	2	10	95.8	1502		6.0302	
8	1	10	97.2			7.639944	
9	2	10	71.4	1486		8.557938	
10	1	10	76			8.910954	
11	2	10	83.2	1929		10.16331	
12	1	10	90.9			10.53641	
13	2	10	59.4	1813		11.97127	

Statistics 5 (ChirpCenter Frequency: 5494.0 MHz)

Trial #	Pulse	Chirp(MHz)	Pulse Width (μS)	Pulse 1-2 spacing(μS)	Pulse 2-3 spacing(μS)	Pulse Start(S)	Detection (1:yes;0:no)
0	1	11	72.6			0.831471	1
1	2	11	69.1	1260		2.16179	
2	3	11	75.5	1076	1315	3.939295	
3	2	11	52.2	1290		5.064736	
4	2	11	90.5	1062		6.547494	
5	2	11	71.3	1499		7.428817	
6	1	11	59.3			8.708623	
7	2	11	77.2	1129		9.861092	
8	2	11	70.4	1744		11.5727	

Statistics 6 (ChirpCenter Frequency: 5494.0 MHz)

Trial #	Pulse	Chirp(MHz)	Pulse Width (μS)	Pulse 1-2 spacing(μS)	Pulse 2-3 spacing(μS)	Pulse Start(S)	Detection (1:yes;0:no)
0	1	9	94.5			0.294378	1
1	2	9	65.7	1497		0.9147	
2	3	9	79.8	1267	1122	1.875947	
3	2	9	78.7	1227		2.738169	
4	2	9	88.9	1506		3.743318	
5	2	9	73.3	1231		3.750948	
6	2	9	95.8	1746		4.705002	
7	2	9	87	1442		5.478303	
8	3	9	70.4	1347	1332	6.292953	
9	3	9	60.8	1844	1712	6.996969	
10	2	9	99.5	1246		8.05353	
11	2	9	73.8	1785		8.930441	
12	1	9	51.4			9.095725	
13	2	9	76	1090		10.34009	
14	2	9	91.9	1217		10.68769	
15	3	9	76.5	1183	1572	11.41536	

Statistics 7 (ChirpCenter Frequency: 5496.0 MHz)

Trial #	Pulse	Chirp(MHz)	Pulse Width (μS)	Pulse 1-2 spacing(uS)	Pulse 2-3 spacing(uS)	Pulse Start(S)	Detection (1:yes;0:no)
0	1	15	79.1			0.842334	1
1	2	15	79.5	1892		1.916831	
2	1	15	99.7			2.753731	
3	3	15	62.2	1097	1768	3.062638	
4	2	15	55.1	1015		4.418105	
5	2	15	92.3	1703		5.828665	
6	1	15	83.2			6.041173	
7	1	15	63.2			7.874116	
8	2	15	77.1	1986		8.865826	
9	2	15	65.2	1064		9.078944	
10	3	15	68.1	1022	1740	10.25111	
11	3	15	72.1	1886	1851	11.04032	

Statistics 8 (ChirpCenter Frequency: 5494.0 MHz)

Trial #	Pulse	Chirp(MHz)	Pulse Width (μS)	Pulse 1-2 spacing(μS)	Pulse 2-3 spacing(μS)	Pulse Start(S)	Detection (1:yes;0:no)
0	1	11	74.5			0.884585	1
1	1	11	75.1			1.558125	
2	2	11	73.7	1490		1.961208	
3	1	11	58.2			3.677433	
4	2	11	88.6	1590		3.743821	
5	2	11	86.5	1289		5.231996	
6	2	11	95.6	1829		5.797754	
7	2	11	90.7	1592		7.173922	
8	2	11	99.8	1521		7.929521	
9	1	11	95.6			9.050783	
10	3	11	72	1099	1292	9.325131	
11	2	11	67.7	1511		10.73302	
12	1	11	58.7			11.94551	

Statistics 9 (ChirpCenter Frequency: 5492.0 MHz)

Trial #	Pulse	Chirp(MHz)	Pulse Width (μS)	Pulse 1-2 spacing(μS)	Pulse 2-3 spacing(μS)	Pulse Start(S)	Detection (1:yes;0:no)
0	1	5	67.5			0.096748	1
1	3	5	53	1168	1149	0.963405	
2	3	5	64.6	2000	1731	2.017108	
3	2	5	82	1101		2.948652	
4	3	5	60.8	1221	1381	4.458692	
5	2	5	70.2	1246		4.782234	
6	2	5	60	1421		6.216401	
7	2	5	74.7	1736		7.246379	
8	2	5	98.7	1894		8.09005	
9	2	5	82.1	1935		8.435157	
10	2	5	82.2	1765		9.483215	
11	1	5	62			10.381	
12	2	5	90.7	1644		11.70145	

Statistics 10 (ChirpCenter Frequency: 5493.0 MHz)

Trial #	Pulse	Chirp(MHz)	Pulse Width (μS)	Pulse 1-2 spacing(μS)	Pulse 2-3 spacing(μS)	Pulse Start(S)	Detection (1:yes;0:no)
0	1	7	63.7			1.000944	1
1	2	7	96.4	1925		1.928962	
2	2	7	76.3	1183		2.665083	
3	2	7	83.3	1803		3.971692	
4	2	7	63.3	1700		5.369988	
5	1	7	88.4			5.950101	
6	1	7	66			6.618262	
7	2	7	76.6	1076		8.148379	
8	2	7	83.3	1024		9.247936	
9	2	7	78.1	1848		10.12309	
10	1	7	61.4			11.03624	

Radar Type 5 Case 3 Statistical Performance

Statistics 1 (ChirpCenter Frequency: 5227.0 MHz)

Trial #	Pulse	Chirp(MHz)	Pulse Width (μS)	Pulse 1-2 spacing(μS)	Pulse 2-3 spacing(μS)	Pulse Start(S)	Detection (1:yes;0:no)
0	3	8	54.1	1877	1687	0.847555	1
1	2	8	81.2	1162		1.381913	
2	2	8	70.1	1835		2.957016	
3	3	8	89.2	1796	1864	3.205956	
4	2	8	88.7	1206		4.332967	
5	3	8	92	1443	1074	5.987024	
6	2	8	92.2	1139		6.477862	
7	3	8	73.8	1463	1954	7.282612	
8	1	8	61			8.791479	
9	1	8	78.3			9.716191	
10	2	8	62.3	1753		10.23253	
11	2	8	54.2	1250		11.38216	

Statistics 2 (ChirpCenter Frequency: 5526.0 MHz)

Trial #	Pulse	Chirp(MHz)	Pulse Width (μS)	Pulse 1-2 spacing(μS)	Pulse 2-3 spacing(μS)	Pulse Start(S)	Detection (1:yes;0:no)
0	1	10	53.3			0.792059	1
1	3	10	63.8	1758	1266	1.094849	
2	2	10	68.3	1346		1.860516	
3	3	10	79.8	1754	1835	3.515279	
4	3	10	81.5	1075	1250	3.804646	
5	2	10	86	1331		5.233583	
6	3	10	57.3	1563	1856	5.953974	
7	2	10	98.4	1967		6.481842	
8	2	10	59.9	1586		7.556332	
9	3	10	99.3	1605	1167	8.866128	
10	2	10	96.6	1843		10.04604	
11	1	10	95.1			10.48625	
12	2	10	83.8	1996		11.11527	

Statistics 3 (ChirpCenter Frequency: 5525.0 MHz)

Trial #	Pulse	Chirp(MHz)	Pulse Width (μS)	Pulse 1-2 spacing(μS)	Pulse 2-3 spacing(μS)	Pulse Start(S)	Detection (1:yes;0:no)
0	3	13	70.5	1833	1829	0.447634	1
1	2	13	92	1819		1.350634	
2	3	13	65.3	1979	1729	3.132907	
3	2	13	58.1	1747		3.280281	
4	2	13	95.8	1514		5.030736	
5	2	13	86.1	1879		6.066175	
6	3	13	79.1	1171	1624	7.567982	
7	3	13	52.2	1011	1120	8.580546	
8	3	13	67.9	1158	1592	8.988635	
9	2	13	84.4	1669		10.07076	
10	3	13	71.9	1264	1158	11.78944	

Statistics 4 (ChirpCenter Frequency: 5522.0 MHz)

Trial #	Pulse	Chirp(MHz)	Pulse Width (µS)	Pulse 1-2 spacing(µS)	Pulse 2-3 spacing(µS)	Pulse Start(S)	Detection (1:yes;0:no)
0	3	19	75.8	1482	1869	0.744087	1
1	2	19	90.9	1832		1.201775	
2	3	19	81.2	1319	1770	2.469815	
3	3	19	90.3	1975	1099	3.918631	
4	2	19	87	1248		4.991708	
5	2	19	99	1429		5.173208	
6	2	19	88.3	1128		6.41756	
7	2	19	77.6	1668		7.250558	
8	1	19	60.4			8.963202	
9	2	19	58.4	1314		9.71534	
10	1	19	87.7			10.81859	
11	3	19	94	1366	1754	11.75101	

Statistics 5 (ChirpCenter Frequency: 5524.0 MHz)

Trial #	Pulse	Chirp(MHz)	Pulse Width (µS)	Pulse 1-2 spacing(µS)	Pulse 2-3 spacing(µS)	Pulse Start(S)	Detection (1:yes;0:no)
0	1	15	81.1			0.660781	1
1	1	15	54.6			0.993007	
2	1	15	64.9			1.552727	
3	2	15	61.7	1833		2.649998	
4	2	15	63.5	1285		3.373477	
5	1	15	67.2			4.13653	
6	3	15	85.1	1607	1482	4.981569	
7	2	15	81	1799		5.293223	
8	1	15	63.8			6.567046	
9	3	15	78.4	1163	1953	7.325761	
10	1	15	60.3			7.753522	
11	2	15	94	1393		8.752393	
12	2	15	58.2	1782		9.58439	
13	1	15	70.1			10.4359	
14	2	15	76.2	1901		11.00452	
15	3	15	62.5	1564	1214	11.51779	

Statistics 6 (ChirpCenter Frequency: 5525.0 MHz)

Trial #	Pulse	Chirp(MHz)	Pulse Width (μS)	Pulse 1-2 spacing(μS)	Pulse 2-3 spacing(μS)	Pulse Start(S)	Detection (1:yes;0:no)
0	1	12	74.3			0.664939	1
1	1	12	96.6			0.928596	
2	2	12	81.7	1032		1.629216	
3	3	12	51	1104	1524	2.676427	
4	3	12	67.2	1692	1434	2.948733	
5	2	12	77.9	1455		4.160899	
6	3	12	70.7	1301	1794	4.432959	
7	3	12	65.4	1232	1111	5.47244	
8	3	12	56.9	1305	1396	6.269483	
9	3	12	62	1337	1420	6.753787	
10	2	12	78.4	1020		7.724388	
11	2	12	96.5	1362		8.453183	
12	1	12	61.3			8.496484	
13	3	12	68.6	1728	1291	9.524914	
14	3	12	61.8	1377	1288	10.22576	
15	2	12	56.5	1697		11.08774	
16	1	12	94.8			11.66707	

Statistics 7 (ChirpCenter Frequency: 5525.0 MHz)

Trial #	Pulse	Chirp(MHz)	Pulse Width (μS)	Pulse 1-2 spacing(μS)	Pulse 2-3 spacing(μS)	Pulse Start(S)	Detection (1:yes;0:no)
0	2	12	53	1403		0.562303	1
1	1	12	91			1.452909	
2	2	12	70.4	1225		2.171286	
3	2	12	56.1	1245		2.993435	
4	3	12	93	1962	1533	3.174703	
5	2	12	81	1346		4.123819	
6	3	12	95.5	1346	1518	4.758991	
7	2	12	50.8	1921		5.658443	
8	1	12	90.5			6.118796	
9	2	12	86	1703		7.163243	
10	2	12	55.2	1768		8.020844	
11	2	12	55.3	1660		8.623412	
12	2	12	50.4	1874		9.167254	
13	3	12	88.6	1631	1137	10.26654	
14	2	12	86.5	1930		10.68222	
15	2	12	78.1	1602		11.31117	

Statistics 8 (ChirpCenter Frequency: 5526.0 MHz)

Trial #	Pulse	Chirp(MHz)	Pulse Width (μS)	Pulse 1-2 spacing(μS)	Pulse 2-3 spacing(μS)	Pulse Start(S)	Detection (1:yes;0:no)
0	2	9	75.1	1940		1.163748	1
1	1	9	53.3			1.410038	
2	2	9	99	1037		2.972612	
3	1	9	74.7			3.882591	
4	1	9	85.1			5.671178	
5	2	9	76.7	1671		6.85406	
6	2	9	65.3	1439		7.309446	
7	1	9	84.6			8.953597	
8	2	9	60.8	1366		10.77814	
9	3	9	96.3	1963	1591	11.45664	

Statistics 9 (ChirpCenter Frequency: 5524.0 MHz)

Trial #	Pulse	Chirp(MHz)	Pulse Width (μS)	Pulse 1-2 spacing(μS)	Pulse 2-3 spacing(μS)	Pulse Start(S)	Detection (1:yes;0:no)
0	1	14	91.6			0.079309	1
1	3	14	57	1230	1616	1.046257	
2	2	14	98.5	1262		1.942786	
3	1	14	55.3			2.464625	
4	2	14	65.8	1314		2.96395	
5	2	14	68	1205		3.870823	
6	2	14	81.5	1821		4.800565	
7	1	14	67.8			5.539712	
8	3	14	99.1	1092	1931	5.884864	
9	2	14	71.5	1970		6.887018	
10	3	14	59.9	1659	1194	7.219781	
11	2	14	73.9	1932		8.436672	
12	1	14	91.2			8.524306	
13	2	14	63.2	1513		9.315386	
14	2	14	61.2	1873		10.40908	
15	3	14	64.9	1515	1431	11.13516	
16	1	14	54.8			11.53086	

Statistics 10 (ChirpCenter Frequency: 5525.0 MHz)

Trial #	Pulse	Chirp(MHz)	Pulse Width (μS)	Pulse 1-2 spacing(μS)	Pulse 2-3 spacing(μS)	Pulse Start(S)	Detection (1:yes;0:no)
0	2	12	95.3	1419		0.525008	1
1	2	12	84.3	1259		1.095373	
2	1	12	63.3			1.465905	
3	1	12	90.6			2.246837	
4	2	12	71.6	1278		3.008962	
5	2	12	90.9	1652		3.431377	
6	1	12	89.3			4.233856	
7	2	12	67.2	1153		4.984886	
8	2	12	65.5	1458		5.896074	
9	2	12	88.5	1917		6.337174	
10	1	12	74.9			7.005349	
11	2	12	54	1114		7.421253	
12	3	12	96.1	1288	1681	8.185749	
13	2	12	80.1	1219		8.833817	
14	2	12	79	1017		9.570341	
15	2	12	98.1	1356		10.65442	
16	2	12	85.2	1950		10.8969	
17	1	12	81.2			11.82866	

Radar Type 6 Statistical Performance

Trial #	Fc (MHz)	Pulse /Burst	Pulse Width (µS)	PRI (µs)	Detection (1:yes; 0:no)	Hopping Sequence (MHz)
1	5510	9	1	333	1	5483.0, 5637.0, 5263.0, 5542.0, 5649.0, 5634.0, 5603.0, 5324.0, 5276.0, 5716.0, 5706.0, 5573.0, 5632.0, 5554.0, 5372.0, 5341.0, 5315.0, 5620.0, 5302.0, 5497.0, 5463.0, 5662.0, 5445.0, 5684.0, 5535.0, 5722.0, 5571.0, 5507.0, 5491.0, 5396.0, 5339.0, 5292.0, 5415.0, 5482.0, 5577.0, 5462.0, 5428.0, 5676.0, 5465.0, 5584.0, 5473.0, 5464.0, 5384.0, 5297.0, 5354.0, 5474.0, 5611.0, 5321.0, 5653.0, 5517.0, 5336.0, 5262.0, 5672.0, 5678.0, 5566.0, 5692.0, 5687.0, 5558.0, 5707.0, 5599.0, 5296.0, 5358.0, 5294.0, 5531.0, 5605.0, 5366.0, 5451.0, 5377.0, 5265.0, 5374.0, 5499.0, 5279.0, 5623.0, 5625.0, 5543.0, 5288.0, 5485.0, 5280.0, 5522.0, 5293.0, 5323.0, 5506.0, 5431.0, 5534.0, 5650.0, 5564.0, 5587.0, 5648.0, 5523.0, 5720.0, 5647.0, 5576.0, 5548.0, 5444.0, 5382.0, 5513.0, 5359.0, 5273.0, 5370.0, 5703.0
2	5510	9	1	333	1	5496.0, 5717.0, 5472.0, 5459.0, 5660.0, 5297.0, 5623.0, 5291.0, 5366.0, 5388.0, 5364.0, 5268.0, 5314.0, 5719.0, 5518.0, 5650.0, 5619.0, 5308.0, 5301.0, 5687.0, 5315.0, 5489.0, 5425.0, 5491.0, 5654.0, 5338.0, 5605.0, 5644.0, 5466.0, 5590.0, 5549.0, 5564.0, 5507.0, 5686.0, 5445.0, 5424.0, 5696.0, 5627.0, 5585.0, 5356.0, 5657.0, 5678.0, 5672.0, 5283.0, 5448.0, 5438.0, 5451.0, 5607.0, 5509.0, 5348.0, 5551.0, 5320.0, 5691.0, 5488.0, 5579.0, 5583.0, 5682.0, 5344.0, 5430.0, 5379.0, 5374.0, 5369.0, 5578.0, 5587.0, 5709.0, 5666.0, 5333.0, 5471.0, 5693.0, 5441.0, 5473.0, 5454.0, 5548.0, 5408.0, 5263.0, 5304.0, 5255.0, 5417.0, 5692.0, 5269.0, 5615.0, 5495.0, 5350.0, 5520.0, 5288.0, 5290.0, 5534.0, 5525.0, 5516.0, 5511.0, 5700.0, 5343.0, 5570.0, 5597.0, 5277.0, 5562.0, 5604.0, 5426.0, 5721.0, 5393.0
3	5510	9	1	333	1	5640.0, 5501.0, 5455.0, 5652.0, 5308.0, 5396.0, 5479.0, 5302.0, 5346.0, 5314.0, 5721.0, 5526.0, 5278.0, 5304.0, 5445.0, 5605.0, 5259.0, 5363.0, 5530.0, 5272.0, 5556.0, 5436.0, 5527.0, 5680.0, 5657.0, 5686.0, 5298.0, 5310.0, 5258.0, 5598.0, 5473.0, 5411.0, 5422.0, 5362.0, 5410.0, 5325.0, 5722.0, 5561.0, 5291.0, 5724.0, 5447.0, 5572.0, 5688.0, 5646.0, 5597.0, 5656.0, 5720.0, 5334.0, 5370.0, 5690.0, 5612.0, 5674.0, 5502.0, 5536.0, 5431.0, 5407.0, 5591.0, 5306.0, 5563.0, 5495.0, 5498.0, 5509.0, 5443.0, 5582.0, 5456.0

						5528.0, 5671.0, 5499.0, 5365.0, 5256.0, 5480.0, 5471.0, 5624.0, 5541.0, 5293.0, 5383.0, 5711.0, 5623.0, 5269.0, 5534.0, 5514.0, 5477.0, 5515.0, 5484.0, 5260.0, 5423.0, 5552.0, 5336.0, 5560.0, 5311.0, 5400.0, 5430.0, 5360.0, 5687.0, 5299.0, 5328.0, 5617.0, 5516.0, 5497.0, 5588.0
4	5510	9	1	333	1	5299.0, 5550.0, 5389.0, 5344.0, 5410.0, 5266.0, 5452.0, 5693.0, 5692.0, 5518.0, 5716.0, 5618.0, 5289.0, 5570.0, 5562.0, 5503.0, 5699.0, 5491.0, 5347.0, 5679.0, 5336.0, 5355.0, 5368.0, 5631.0, 5321.0, 5646.0, 5349.0, 5589.0, 5353.0, 5342.0, 5522.0, 5302.0, 5583.0, 5388.0, 5351.0, 5668.0, 5493.0, 5306.0, 5537.0, 5277.0, 5305.0, 5639.0, 5506.0, 5255.0, 5554.0, 5338.0, 5572.0, 5530.0, 5441.0, 5428.0, 5479.0, 5438.0, 5397.0, 5471.0, 5517.0, 5317.0, 5333.0, 5468.0, 5350.0, 5630.0, 5627.0, 5469.0, 5654.0, 5685.0, 5609.0, 5557.0, 5536.0, 5467.0, 5647.0, 5560.0, 5439.0, 5608.0, 5310.0, 5294.0, 5312.0, 5635.0, 5659.0, 5603.0, 5271.0, 5370.0, 5680.0, 5427.0, 5648.0, 5257.0, 5602.0, 5346.0, 5701.0, 5694.0, 5377.0, 5538.0, 5369.0, 5254.0, 5290.0, 5437.0, 5311.0, 5487.0, 5356.0, 5313.0, 5547.0, 5300.0
5	5510	9	1	333	1	5420.0, 5609.0, 5685.0, 5717.0, 5656.0, 5718.0, 5317.0, 5543.0, 5467.0, 5558.0, 5452.0, 5405.0, 5301.0, 5336.0, 5589.0, 5428.0, 5289.0, 5497.0, 5288.0, 5455.0, 5386.0, 5356.0, 5511.0, 5612.0, 5595.0, 5660.0, 5410.0, 5607.0, 5701.0, 5359.0, 5575.0, 5608.0, 5501.0, 5462.0, 5369.0, 5438.0, 5628.0, 5520.0, 5553.0, 5308.0, 5503.0, 5256.0, 5576.0, 5476.0, 5281.0, 5388.0, 5316.0, 5670.0, 5477.0, 5465.0, 5524.0, 5445.0, 5450.0, 5266.0, 5304.0, 5500.0, 5305.0, 5705.0, 5444.0, 5545.0, 5382.0, 5604.0, 5627.0, 5443.0, 5364.0, 5639.0, 5539.0, 5594.0, 5342.0, 5385.0, 5383.0, 5449.0, 5306.0, 5354.0, 5668.0, 5678.0, 5340.0, 5280.0, 5587.0, 5490.0, 5366.0, 5374.0, 5416.0, 5447.0, 5706.0, 5371.0, 5697.0, 5267.0, 5654.0, 5439.0, 5312.0, 5561.0, 5384.0, 5634.0, 5394.0, 5529.0, 5522.0, 5722.0, 5526.0, 5454.0
6	5510	9	1	333	1	5533.0, 5555.0, 5661.0, 5714.0, 5339.0, 5581.0, 5397.0, 5675.0, 5433.0, 5589.0, 5337.0, 5516.0, 5512.0, 5435.0, 5309.0, 5594.0, 5506.0, 5328.0, 5646.0, 5430.0, 5279.0, 5442.0, 5550.0, 5566.0, 5520.0, 5525.0, 5267.0, 5595.0, 5483.0, 5502.0, 5292.0, 5511.0, 5425.0, 5340.0, 5324.0, 5466.0, 5457.0, 5338.0, 5553.0, 5633.0, 5643.0, 5311.0, 5658.0, 5395.0, 5336.0, 5357.0, 5599.0, 5580.0, 5706.0, 5584.0, 5358.0, 5614.0, 5475.0, 5455.0, 5427.0, 5479.0, 5608.0, 5382.0, 5327.0, 5493.0, 5702.0, 5343.0, 5724.0, 5567.0, 5412.0

						5389.0, 5615.0, 5405.0, 5460.0, 5294.0, 5256.0, 5720.0, 5695.0, 5355.0, 5694.0, 5545.0, 5255.0, 5408.0, 5538.0, 5668.0, 5481.0, 5606.0, 5501.0, 5577.0, 5375.0, 5524.0, 5404.0, 5462.0, 5620.0, 5454.0, 5323.0, 5419.0, 5596.0, 5297.0, 5320.0, 5519.0, 5432.0, 5645.0, 5495.0, 5468.0
7	5510	9	1	333	1	5563.0, 5328.0, 5368.0, 5448.0, 5561.0, 5471.0, 5543.0, 5508.0, 5444.0, 5619.0, 5457.0, 5585.0, 5403.0, 5557.0, 5426.0, 5482.0, 5566.0, 5492.0, 5628.0, 5439.0, 5453.0, 5662.0, 5663.0, 5408.0, 5435.0, 5376.0, 5358.0, 5608.0, 5657.0, 5282.0, 5587.0, 5405.0, 5505.0, 5295.0, 5470.0, 5393.0, 5519.0, 5343.0, 5546.0, 5280.0, 5643.0, 5512.0, 5263.0, 5337.0, 5281.0, 5417.0, 5639.0, 5522.0, 5336.0, 5489.0, 5449.0, 5720.0, 5483.0, 5711.0, 5377.0, 5668.0, 5338.0, 5653.0, 5437.0, 5252.0, 5618.0, 5423.0, 5601.0, 5321.0, 5694.0, 5675.0, 5251.0, 5425.0, 5607.0, 5436.0, 5428.0, 5602.0, 5632.0, 5401.0, 5642.0, 5575.0, 5331.0, 5498.0, 5300.0, 5348.0, 5455.0, 5375.0, 5346.0, 5496.0, 5626.0, 5349.0, 5433.0, 5354.0, 5556.0, 5524.0, 5461.0, 5387.0, 5379.0, 5309.0, 5578.0, 5509.0, 5658.0, 5286.0, 5292.0, 5296.0
8	5510	9	1	333	1	5614.0, 5372.0, 5429.0, 5433.0, 5259.0, 5691.0, 5419.0, 5675.0, 5643.0, 5414.0, 5256.0, 5298.0, 5620.0, 5714.0, 5723.0, 5667.0, 5361.0, 5474.0, 5375.0, 5385.0, 5531.0, 5296.0, 5665.0, 5265.0, 5689.0, 5263.0, 5542.0, 5613.0, 5395.0, 5504.0, 5357.0, 5479.0, 5697.0, 5294.0, 5312.0, 5471.0, 5535.0, 5601.0, 5544.0, 5467.0, 5283.0, 5530.0, 5351.0, 5284.0, 5428.0, 5269.0, 5657.0, 5690.0, 5551.0, 5321.0, 5301.0, 5326.0, 5381.0, 5517.0, 5358.0, 5327.0, 5724.0, 5532.0, 5295.0, 5702.0, 5364.0, 5449.0, 5270.0, 5310.0, 5333.0, 5300.0, 5426.0, 5350.0, 5507.0, 5662.0, 5423.0, 5524.0, 5559.0, 5329.0, 5401.0, 5415.0, 5574.0, 5687.0, 5580.0, 5360.0, 5493.0, 5412.0, 5251.0, 5599.0, 5584.0, 5418.0, 5342.0, 5538.0, 5503.0, 5281.0, 5434.0, 5582.0, 5484.0, 5600.0, 5336.0, 5285.0, 5647.0, 5427.0, 5603.0, 5378.0
9	5510	9	1	333	1	5500.0, 5378.0, 5434.0, 5429.0, 5423.0, 5481.0, 5382.0, 5646.0, 5722.0, 5545.0, 5315.0, 5422.0, 5342.0, 5262.0, 5299.0, 5668.0, 5522.0, 5698.0, 5712.0, 5635.0, 5546.0, 5673.0, 5555.0, 5693.0, 5381.0, 5650.0, 5442.0, 5326.0, 5711.0, 5627.0, 5367.0, 5384.0, 5553.0, 5482.0, 5321.0, 5415.0, 5282.0, 5573.0, 5268.0, 5508.0, 5271.0, 5480.0, 5601.0, 5701.0, 5293.0, 5674.0, 5300.0, 5264.0, 5495.0, 5356.0, 5520.0, 5301.0, 5454.0, 5526.0, 5513.0, 5525.0, 5492.0, 5506.0, 5261.0, 5288.0, 5352.0, 5493.0, 5614.0, 5463.0, 5568.0

						5599.0, 5697.0, 5445.0, 5624.0, 5255.0, 5649.0, 5456.0, 5685.0, 5444.0, 5277.0, 5432.0, 5270.0, 5297.0, 5291.0, 5328.0, 5598.0, 5485.0, 5290.0, 5501.0, 5324.0, 5377.0, 5272.0, 5663.0, 5590.0, 5428.0, 5661.0, 5594.0, 5368.0, 5332.0, 5483.0, 5440.0, 5405.0, 5671.0, 5581.0, 5538.0
10	5510	9	1	333	1	5317.0, 5485.0, 5557.0, 5448.0, 5596.0, 5544.0, 5552.0, 5709.0, 5682.0, 5601.0, 5500.0, 5669.0, 5371.0, 5620.0, 5528.0, 5444.0, 5408.0, 5549.0, 5414.0, 5251.0, 5413.0, 5721.0, 5279.0, 5487.0, 5597.0, 5291.0, 5593.0, 5320.0, 5474.0, 5712.0, 5641.0, 5356.0, 5515.0, 5275.0, 5450.0, 5611.0, 5579.0, 5333.0, 5578.0, 5636.0, 5433.0, 5361.0, 5607.0, 5405.0, 5305.0, 5470.0, 5539.0, 5304.0, 5655.0, 5455.0, 5274.0, 5439.0, 5447.0, 5482.0, 5339.0, 5498.0, 5667.0, 5393.0, 5561.0, 5677.0, 5314.0, 5370.0, 5648.0, 5346.0, 5446.0, 5538.0, 5348.0, 5664.0, 5586.0, 5272.0, 5496.0, 5493.0, 5362.0, 5307.0, 5497.0, 5565.0, 5683.0, 5398.0, 5394.0, 5666.0, 5430.0, 5262.0, 5521.0, 5427.0, 5558.0, 5665.0, 5336.0, 5492.0, 5260.0, 5570.0, 5547.0, 5587.0, 5598.0, 5490.0, 5454.0, 5491.0, 5603.0, 5604.0, 5337.0, 5297.0
11	5510	9	1	333	1	5509.0, 5427.0, 5301.0, 5464.0, 5383.0, 5419.0, 5460.0, 5703.0, 5261.0, 5308.0, 5695.0, 5298.0, 5293.0, 5416.0, 5540.0, 5705.0, 5318.0, 5538.0, 5662.0, 5640.0, 5357.0, 5653.0, 5360.0, 5304.0, 5670.0, 5253.0, 5432.0, 5361.0, 5331.0, 5307.0, 5370.0, 5539.0, 5610.0, 5691.0, 5283.0, 5580.0, 5372.0, 5650.0, 5369.0, 5335.0, 5313.0, 5502.0, 5722.0, 5490.0, 5405.0, 5265.0, 5276.0, 5494.0, 5625.0, 5503.0, 5681.0, 5547.0, 5267.0, 5666.0, 5622.0, 5354.0, 5326.0, 5712.0, 5551.0, 5302.0, 5568.0, 5270.0, 5449.0, 5386.0, 5345.0, 5297.0, 5382.0, 5312.0, 5467.0, 5472.0, 5466.0, 5506.0, 5384.0, 5718.0, 5724.0, 5658.0, 5462.0, 5266.0, 5632.0, 5600.0, 5410.0, 5258.0, 5543.0, 5364.0, 5713.0, 5619.0, 5368.0, 5633.0, 5440.0, 5273.0, 5672.0, 5294.0, 5430.0, 5358.0, 5709.0, 5649.0, 5561.0, 5630.0, 5567.0, 5498.0
12	5510	9	1	333	1	5356.0, 5365.0, 5553.0, 5500.0, 5707.0, 5525.0, 5691.0, 5672.0, 5717.0, 5343.0, 5512.0, 5474.0, 5327.0, 5653.0, 5412.0, 5481.0, 5498.0, 5681.0, 5414.0, 5516.0, 5705.0, 5703.0, 5586.0, 5402.0, 5483.0, 5273.0, 5562.0, 5566.0, 5709.0, 5624.0, 5684.0, 5309.0, 5690.0, 5461.0, 5537.0, 5392.0, 5559.0, 5389.0, 5678.0, 5518.0, 5636.0, 5683.0, 5523.0, 5361.0, 5278.0, 5321.0, 5675.0, 5270.0, 5721.0, 5388.0, 5552.0, 5347.0, 5374.0, 5716.0, 5689.0, 5355.0, 5505.0, 5398.0, 5377.0, 5274.0, 5334.0, 5718.0, 5520.0, 5420.0, 5415.0

						5308.0, 5251.0, 5643.0, 5623.0, 5319.0, 5304.0, 5618.0, 5580.0, 5447.0, 5289.0, 5554.0, 5477.0, 5469.0, 5670.0, 5524.0, 5326.0, 5550.0, 5437.0, 5376.0, 5631.0, 5549.0, 5335.0, 5307.0, 5373.0, 5313.0, 5685.0, 5479.0, 5371.0, 5295.0, 5426.0, 5410.0, 5324.0, 5382.0, 5422.0, 5429.0
13	5510	9	1	333	1	5325.0, 5352.0, 5698.0, 5305.0, 5304.0, 5467.0, 5302.0, 5650.0, 5630.0, 5480.0, 5303.0, 5682.0, 5415.0, 5453.0, 5526.0, 5649.0, 5708.0, 5542.0, 5438.0, 5555.0, 5654.0, 5545.0, 5301.0, 5387.0, 5294.0, 5510.0, 5706.0, 5591.0, 5267.0, 5397.0, 5595.0, 5448.0, 5580.0, 5396.0, 5452.0, 5670.0, 5489.0, 5360.0, 5527.0, 5717.0, 5276.0, 5319.0, 5597.0, 5451.0, 5508.0, 5295.0, 5521.0, 5392.0, 5583.0, 5474.0, 5611.0, 5454.0, 5355.0, 5643.0, 5609.0, 5299.0, 5463.0, 5274.0, 5471.0, 5612.0, 5291.0, 5271.0, 5538.0, 5517.0, 5674.0, 5395.0, 5310.0, 5296.0, 5378.0, 5504.0, 5462.0, 5347.0, 5432.0, 5258.0, 5582.0, 5690.0, 5450.0, 5353.0, 5399.0, 5403.0, 5363.0, 5402.0, 5560.0, 5607.0, 5537.0, 5349.0, 5444.0, 5507.0, 5466.0, 5659.0, 5632.0, 5468.0, 5285.0, 5722.0, 5374.0, 5709.0, 5645.0, 5318.0, 5705.0, 5525.0
14	5510	9	1	333	1	5350.0, 5285.0, 5510.0, 5652.0, 5292.0, 5273.0, 5597.0, 5440.0, 5618.0, 5299.0, 5697.0, 5701.0, 5422.0, 5306.0, 5301.0, 5623.0, 5641.0, 5347.0, 5439.0, 5559.0, 5518.0, 5357.0, 5400.0, 5426.0, 5380.0, 5662.0, 5390.0, 5587.0, 5450.0, 5596.0, 5707.0, 5265.0, 5573.0, 5644.0, 5378.0, 5508.0, 5344.0, 5296.0, 5276.0, 5418.0, 5687.0, 5620.0, 5477.0, 5365.0, 5674.0, 5716.0, 5449.0, 5545.0, 5712.0, 5520.0, 5542.0, 5487.0, 5427.0, 5661.0, 5681.0, 5425.0, 5680.0, 5636.0, 5360.0, 5539.0, 5309.0, 5485.0, 5646.0, 5293.0, 5666.0, 5489.0, 5266.0, 5351.0, 5370.0, 5376.0, 5353.0, 5655.0, 5468.0, 5505.0, 5632.0, 5386.0, 5371.0, 5295.0, 5507.0, 5441.0, 5622.0, 5457.0, 5714.0, 5660.0, 5327.0, 5612.0, 5509.0, 5670.0, 5261.0, 5719.0, 5454.0, 5534.0, 5710.0, 5574.0, 5464.0, 5436.0, 5416.0, 5493.0, 5443.0, 5316.0
15	5510	9	1	333	1	5451.0, 5711.0, 5489.0, 5352.0, 5699.0, 5606.0, 5659.0, 5695.0, 5591.0, 5383.0, 5483.0, 5427.0, 5365.0, 5302.0, 5696.0, 5569.0, 5552.0, 5604.0, 5341.0, 5578.0, 5595.0, 5455.0, 5724.0, 5371.0, 5650.0, 5336.0, 5682.0, 5469.0, 5468.0, 5691.0, 5285.0, 5416.0, 5262.0, 5594.0, 5294.0, 5429.0, 5445.0, 5517.0, 5419.0, 5473.0, 5698.0, 5496.0, 5369.0, 5634.0, 5322.0, 5568.0, 5704.0, 5324.0, 5409.0, 5680.0, 5390.0, 5588.0, 5453.0, 5300.0, 5342.0, 5527.0, 5544.0, 5600.0, 5329.0, 5276.0, 5502.0, 5362.0, 5290.0, 5274.0, 5385.0

						5612.0, 5388.0, 5488.0, 5631.0, 5360.0, 5358.0, 5399.0, 5509.0, 5465.0, 5361.0, 5651.0, 5535.0, 5331.0, 5255.0, 5601.0, 5617.0, 5284.0, 5293.0, 5493.0, 5683.0, 5485.0, 5422.0, 5306.0, 5252.0, 5633.0, 5558.0, 5351.0, 5565.0, 5406.0, 5618.0, 5554.0, 5635.0, 5602.0, 5589.0, 5657.0
16	5510	9	1	333	1	5352.0, 5610.0, 5483.0, 5599.0, 5343.0, 5525.0, 5264.0, 5695.0, 5643.0, 5630.0, 5518.0, 5684.0, 5403.0, 5678.0, 5595.0, 5473.0, 5666.0, 5557.0, 5581.0, 5358.0, 5290.0, 5486.0, 5510.0, 5436.0, 5533.0, 5263.0, 5308.0, 5258.0, 5669.0, 5637.0, 5487.0, 5711.0, 5445.0, 5257.0, 5596.0, 5425.0, 5310.0, 5319.0, 5699.0, 5345.0, 5565.0, 5338.0, 5677.0, 5612.0, 5265.0, 5442.0, 5547.0, 5587.0, 5344.0, 5686.0, 5306.0, 5389.0, 5698.0, 5461.0, 5451.0, 5396.0, 5272.0, 5655.0, 5603.0, 5382.0, 5508.0, 5646.0, 5391.0, 5286.0, 5330.0, 5337.0, 5277.0, 5325.0, 5524.0, 5559.0, 5315.0, 5409.0, 5495.0, 5412.0, 5523.0, 5453.0, 5394.0, 5490.0, 5593.0, 5334.0, 5393.0, 5535.0, 5647.0, 5538.0, 5460.0, 5715.0, 5357.0, 5491.0, 5457.0, 5477.0, 5279.0, 5340.0, 5297.0, 5604.0, 5404.0, 5671.0, 5463.0, 5464.0, 5521.0, 5351.0
17	5510	9	1	333	1	5636.0, 5351.0, 5285.0, 5467.0, 5302.0, 5349.0, 5657.0, 5487.0, 5332.0, 5420.0, 5390.0, 5463.0, 5479.0, 5494.0, 5270.0, 5265.0, 5530.0, 5645.0, 5397.0, 5595.0, 5609.0, 5507.0, 5379.0, 5613.0, 5568.0, 5640.0, 5596.0, 5317.0, 5361.0, 5346.0, 5399.0, 5350.0, 5451.0, 5519.0, 5540.0, 5323.0, 5552.0, 5309.0, 5429.0, 5501.0, 5536.0, 5669.0, 5435.0, 5679.0, 5334.0, 5559.0, 5660.0, 5631.0, 5341.0, 5622.0, 5371.0, 5407.0, 5266.0, 5466.0, 5456.0, 5354.0, 5363.0, 5403.0, 5567.0, 5372.0, 5574.0, 5664.0, 5556.0, 5313.0, 5310.0, 5705.0, 5311.0, 5428.0, 5316.0, 5413.0, 5558.0, 5722.0, 5662.0, 5544.0, 5453.0, 5703.0, 5348.0, 5712.0, 5689.0, 5526.0, 5539.0, 5480.0, 5717.0, 5575.0, 5642.0, 5626.0, 5562.0, 5378.0, 5476.0, 5584.0, 5471.0, 5549.0, 5408.0, 5550.0, 5279.0, 5303.0, 5459.0, 5377.0, 5707.0, 5564.0
18	5510	9	1	333	1	5484.0, 5253.0, 5517.0, 5559.0, 5451.0, 5652.0, 5526.0, 5713.0, 5352.0, 5330.0, 5464.0, 5665.0, 5567.0, 5350.0, 5513.0, 5363.0, 5705.0, 5389.0, 5591.0, 5286.0, 5610.0, 5582.0, 5343.0, 5394.0, 5678.0, 5667.0, 5264.0, 5355.0, 5686.0, 5592.0, 5423.0, 5466.0, 5558.0, 5362.0, 5401.0, 5483.0, 5572.0, 5628.0, 5408.0, 5493.0, 5434.0, 5542.0, 5521.0, 5660.0, 5465.0, 5534.0, 5631.0, 5695.0, 5703.0, 5438.0, 5566.0, 5663.0, 5281.0, 5601.0, 5365.0, 5685.0, 5337.0, 5544.0, 5376.0, 5424.0, 5504.0, 5435.0, 5492.0, 5259.0, 5299.0,

						5323.0, 5662.0, 5307.0, 5666.0, 5721.0, 5333.0, 5347.0, 5345.0, 5396.0, 5602.0, 5317.0, 5611.0, 5273.0, 5622.0, 5649.0, 5311.0, 5411.0, 5613.0, 5641.0, 5605.0, 5332.0, 5477.0, 5351.0, 5470.0, 5316.0, 5691.0, 5549.0, 5714.0, 5612.0, 5552.0, 5270.0, 5478.0, 5702.0, 5472.0, 5637.0
19	5510	9	1	333	1	5299.0, 5279.0, 5589.0, 5603.0, 5605.0, 5599.0, 5677.0, 5424.0, 5663.0, 5587.0, 5572.0, 5418.0, 5687.0, 5654.0, 5261.0, 5430.0, 5625.0, 5387.0, 5382.0, 5367.0, 5359.0, 5678.0, 5268.0, 5272.0, 5291.0, 5621.0, 5641.0, 5422.0, 5542.0, 5400.0, 5571.0, 5635.0, 5682.0, 5412.0, 5358.0, 5328.0, 5656.0, 5699.0, 5612.0, 5278.0, 5398.0, 5417.0, 5297.0, 5460.0, 5371.0, 5662.0, 5404.0, 5436.0, 5680.0, 5444.0, 5453.0, 5622.0, 5624.0, 5704.0, 5253.0, 5718.0, 5576.0, 5629.0, 5318.0, 5454.0, 5626.0, 5583.0, 5413.0, 5366.0, 5274.0, 5689.0, 5580.0, 5391.0, 5500.0, 5528.0, 5652.0, 5507.0, 5421.0, 5492.0, 5529.0, 5646.0, 5694.0, 5495.0, 5293.0, 5270.0, 5311.0, 5609.0, 5343.0, 5482.0, 5684.0, 5380.0, 5288.0, 5342.0, 5465.0, 5516.0, 5323.0, 5700.0, 5702.0, 5303.0, 5538.0, 5640.0, 5434.0, 5648.0, 5485.0, 5598.0
20	5510	9	1	333	1	5363.0, 5343.0, 5641.0, 5596.0, 5318.0, 5709.0, 5529.0, 5293.0, 5393.0, 5260.0, 5708.0, 5375.0, 5419.0, 5264.0, 5712.0, 5266.0, 5586.0, 5670.0, 5686.0, 5583.0, 5543.0, 5715.0, 5533.0, 5551.0, 5473.0, 5476.0, 5357.0, 5550.0, 5489.0, 5677.0, 5319.0, 5627.0, 5272.0, 5604.0, 5600.0, 5259.0, 5699.0, 5648.0, 5678.0, 5628.0, 5387.0, 5534.0, 5591.0, 5287.0, 5689.0, 5624.0, 5330.0, 5282.0, 5718.0, 5257.0, 5451.0, 5601.0, 5301.0, 5295.0, 5636.0, 5291.0, 5542.0, 5386.0, 5305.0, 5329.0, 5506.0, 5497.0, 5606.0, 5526.0, 5265.0, 5594.0, 5607.0, 5585.0, 5576.0, 5478.0, 5554.0, 5397.0, 5502.0, 5511.0, 5593.0, 5320.0, 5569.0, 5333.0, 5342.0, 5460.0, 5617.0, 5621.0, 5612.0, 5687.0, 5705.0, 5373.0, 5559.0, 5644.0, 5288.0, 5254.0, 5681.0, 5432.0, 5396.0, 5253.0, 5649.0, 5425.0, 5250.0, 5410.0, 5294.0, 5662.0
21	5510	9	1	333	1	5252.0, 5508.0, 5538.0, 5332.0, 5327.0, 5385.0, 5672.0, 5302.0, 5659.0, 5305.0, 5353.0, 5277.0, 5258.0, 5474.0, 5411.0, 5356.0, 5601.0, 5676.0, 5274.0, 5638.0, 5297.0, 5313.0, 5540.0, 5469.0, 5395.0, 5409.0, 5644.0, 5619.0, 5368.0, 5336.0, 5330.0, 5410.0, 5500.0, 5374.0, 5282.0, 5650.0, 5339.0, 5692.0, 5666.0, 5343.0, 5449.0, 5304.0, 5321.0, 5493.0, 5463.0, 5570.0, 5477.0, 5519.0, 5542.0, 5473.0, 5499.0, 5491.0, 5548.0, 5421.0, 5649.0, 5568.0, 5415.0, 5549.0, 5712.0, 5309.0, 5436.0, 5616.0, 5396.0, 5430.0, 5673.0

						5269.0, 5451.0, 5272.0, 5358.0, 5523.0, 5524.0, 5633.0, 5316.0, 5687.0, 5534.0, 5387.0, 5403.0, 5610.0, 5265.0, 5514.0, 5580.0, 5279.0, 5615.0, 5413.0, 5462.0, 5364.0, 5360.0, 5701.0, 5250.0, 5691.0, 5354.0, 5578.0, 5656.0, 5280.0, 5298.0, 5342.0, 5386.0, 5686.0, 5562.0, 5662.0
22	5510	9	1	333	1	5542.0, 5367.0, 5267.0, 5703.0, 5699.0, 5615.0, 5572.0, 5421.0, 5492.0, 5564.0, 5581.0, 5660.0, 5347.0, 5424.0, 5509.0, 5285.0, 5619.0, 5464.0, 5675.0, 5407.0, 5292.0, 5579.0, 5252.0, 5288.0, 5278.0, 5605.0, 5325.0, 5401.0, 5359.0, 5664.0, 5446.0, 5501.0, 5487.0, 5653.0, 5505.0, 5636.0, 5381.0, 5341.0, 5680.0, 5456.0, 5354.0, 5633.0, 5382.0, 5574.0, 5716.0, 5517.0, 5657.0, 5300.0, 5337.0, 5626.0, 5319.0, 5264.0, 5251.0, 5533.0, 5655.0, 5486.0, 5276.0, 5603.0, 5413.0, 5417.0, 5351.0, 5345.0, 5313.0, 5268.0, 5584.0, 5623.0, 5491.0, 5506.0, 5638.0, 5706.0, 5499.0, 5609.0, 5436.0, 5712.0, 5387.0, 5534.0, 5361.0, 5384.0, 5353.0, 5641.0, 5553.0, 5328.0, 5694.0, 5634.0, 5287.0, 5330.0, 5474.0, 5281.0, 5415.0, 5321.0, 5332.0, 5385.0, 5283.0, 5693.0, 5709.0, 5272.0, 5544.0, 5551.0, 5616.0, 5538.0
23	5510	9	1	333	1	5258.0, 5392.0, 5330.0, 5405.0, 5466.0, 5518.0, 5506.0, 5475.0, 5542.0, 5507.0, 5486.0, 5531.0, 5586.0, 5568.0, 5406.0, 5434.0, 5684.0, 5650.0, 5251.0, 5474.0, 5593.0, 5415.0, 5337.0, 5271.0, 5350.0, 5654.0, 5308.0, 5537.0, 5503.0, 5658.0, 5702.0, 5621.0, 5304.0, 5376.0, 5487.0, 5324.0, 5400.0, 5371.0, 5601.0, 5307.0, 5516.0, 5343.0, 5374.0, 5410.0, 5653.0, 5688.0, 5484.0, 5327.0, 5634.0, 5626.0, 5595.0, 5368.0, 5644.0, 5625.0, 5716.0, 5322.0, 5310.0, 5689.0, 5377.0, 5652.0, 5357.0, 5695.0, 5485.0, 5278.0, 5393.0, 5648.0, 5522.0, 5504.0, 5541.0, 5450.0, 5398.0, 5454.0, 5630.0, 5378.0, 5712.0, 5296.0, 5510.0, 5457.0, 5323.0, 5382.0, 5395.0, 5257.0, 5552.0, 5590.0, 5605.0, 5566.0, 5608.0, 5525.0, 5267.0, 5517.0, 5362.0, 5473.0, 5319.0, 5627.0, 5559.0, 5615.0, 5569.0, 5301.0, 5635.0, 5580.0
24	5510	9	1	333	1	5378.0, 5263.0, 5460.0, 5429.0, 5661.0, 5345.0, 5425.0, 5568.0, 5333.0, 5491.0, 5614.0, 5392.0, 5348.0, 5456.0, 5366.0, 5380.0, 5597.0, 5432.0, 5364.0, 5648.0, 5372.0, 5450.0, 5712.0, 5482.0, 5645.0, 5342.0, 5571.0, 5529.0, 5512.0, 5519.0, 5663.0, 5486.0, 5495.0, 5481.0, 5579.0, 5408.0, 5546.0, 5639.0, 5617.0, 5409.0, 5318.0, 5283.0, 5694.0, 5452.0, 5252.0, 5446.0, 5306.0, 5397.0, 5305.0, 5686.0, 5291.0, 5399.0, 5338.0, 5625.0, 5473.0, 5721.0, 5695.0, 5576.0, 5387.0, 5649.0, 5294.0, 5503.0, 5534.0, 5581.0, 5275.0

						5256.0, 5402.0, 5532.0, 5624.0, 5530.0, 5293.0, 5463.0, 5710.0, 5640.0, 5358.0, 5673.0, 5296.0, 5675.0, 5440.0, 5462.0, 5254.0, 5430.0, 5465.0, 5266.0, 5303.0, 5273.0, 5400.0, 5517.0, 5435.0, 5680.0, 5590.0, 5376.0, 5539.0, 5557.0, 5346.0, 5559.0, 5295.0, 5493.0, 5302.0, 5690.0
25	5510	9	1	333	1	5633.0, 5392.0, 5398.0, 5354.0, 5719.0, 5294.0, 5684.0, 5366.0, 5702.0, 5634.0, 5576.0, 5685.0, 5680.0, 5310.0, 5665.0, 5256.0, 5547.0, 5382.0, 5466.0, 5646.0, 5299.0, 5418.0, 5449.0, 5486.0, 5465.0, 5309.0, 5408.0, 5577.0, 5595.0, 5279.0, 5563.0, 5378.0, 5312.0, 5662.0, 5290.0, 5571.0, 5395.0, 5342.0, 5523.0, 5325.0, 5420.0, 5386.0, 5269.0, 5696.0, 5405.0, 5718.0, 5640.0, 5651.0, 5264.0, 5708.0, 5337.0, 5629.0, 5361.0, 5259.0, 5587.0, 5690.0, 5283.0, 5258.0, 5404.0, 5542.0, 5555.0, 5319.0, 5331.0, 5400.0, 5658.0, 5456.0, 5397.0, 5653.0, 5688.0, 5311.0, 5320.0, 5707.0, 5317.0, 5569.0, 5621.0, 5276.0, 5601.0, 5367.0, 5351.0, 5419.0, 5699.0, 5716.0, 5533.0, 5561.0, 5292.0, 5485.0, 5543.0, 5584.0, 5614.0, 5695.0, 5430.0, 5562.0, 5693.0, 5521.0, 5524.0, 5423.0, 5654.0, 5440.0, 5335.0, 5286.0
26	5510	9	1	333	1	5484.0, 5621.0, 5722.0, 5414.0, 5498.0, 5571.0, 5434.0, 5515.0, 5483.0, 5313.0, 5312.0, 5461.0, 5565.0, 5518.0, 5394.0, 5305.0, 5628.0, 5307.0, 5482.0, 5348.0, 5278.0, 5489.0, 5256.0, 5604.0, 5569.0, 5699.0, 5579.0, 5533.0, 5665.0, 5349.0, 5495.0, 5707.0, 5325.0, 5659.0, 5613.0, 5371.0, 5672.0, 5329.0, 5316.0, 5678.0, 5361.0, 5606.0, 5516.0, 5446.0, 5303.0, 5608.0, 5680.0, 5353.0, 5702.0, 5675.0, 5591.0, 5631.0, 5443.0, 5716.0, 5637.0, 5334.0, 5690.0, 5359.0, 5654.0, 5682.0, 5471.0, 5562.0, 5373.0, 5397.0, 5594.0, 5575.0, 5344.0, 5492.0, 5259.0, 5412.0, 5534.0, 5445.0, 5693.0, 5656.0, 5524.0, 5318.0, 5283.0, 5531.0, 5711.0, 5367.0, 5363.0, 5272.0, 5396.0, 5319.0, 5302.0, 5622.0, 5460.0, 5677.0, 5472.0, 5476.0, 5390.0, 5710.0, 5715.0, 5347.0, 5566.0, 5627.0, 5311.0, 5387.0, 5538.0, 5294.0
27	5510	9	1	333	1	5650.0, 5593.0, 5367.0, 5466.0, 5276.0, 5426.0, 5252.0, 5610.0, 5395.0, 5616.0, 5483.0, 5286.0, 5267.0, 5660.0, 5698.0, 5461.0, 5572.0, 5670.0, 5717.0, 5515.0, 5638.0, 5635.0, 5693.0, 5336.0, 5266.0, 5275.0, 5328.0, 5520.0, 5330.0, 5353.0, 5449.0, 5452.0, 5320.0, 5591.0, 5283.0, 5666.0, 5359.0, 5719.0, 5445.0, 5556.0, 5420.0, 5696.0, 5645.0, 5388.0, 5551.0, 5569.0, 5598.0, 5521.0, 5309.0, 5495.0, 5575.0, 5482.0, 5620.0, 5659.0, 5549.0, 5439.0, 5606.0, 5586.0, 5311.0, 5322.0, 5363.0, 5614.0, 5305.0, 5689.0, 5339.0,

						5261.0, 5419.0, 5582.0, 5282.0, 5517.0, 5577.0, 5341.0, 5559.0, 5387.0, 5580.0, 5327.0, 5672.0, 5637.0, 5372.0, 5543.0, 5396.0, 5524.0, 5629.0, 5601.0, 5557.0, 5615.0, 5300.0, 5263.0, 5444.0, 5349.0, 5258.0, 5545.0, 5355.0, 5514.0, 5649.0, 5678.0, 5683.0, 5365.0, 5523.0, 5273.0
28	5510	9	1	333	1	5397.0, 5528.0, 5299.0, 5574.0, 5535.0, 5300.0, 5625.0, 5714.0, 5577.0, 5553.0, 5673.0, 5586.0, 5555.0, 5712.0, 5487.0, 5532.0, 5561.0, 5630.0, 5330.0, 5718.0, 5474.0, 5437.0, 5425.0, 5548.0, 5332.0, 5507.0, 5590.0, 5258.0, 5495.0, 5283.0, 5250.0, 5723.0, 5564.0, 5369.0, 5480.0, 5269.0, 5522.0, 5575.0, 5323.0, 5441.0, 5277.0, 5613.0, 5672.0, 5703.0, 5601.0, 5695.0, 5291.0, 5538.0, 5358.0, 5293.0, 5721.0, 5381.0, 5638.0, 5260.0, 5419.0, 5286.0, 5431.0, 5502.0, 5514.0, 5498.0, 5257.0, 5551.0, 5517.0, 5511.0, 5580.0, 5266.0, 5635.0, 5570.0, 5346.0, 5392.0, 5311.0, 5350.0, 5313.0, 5338.0, 5540.0, 5597.0, 5521.0, 5631.0, 5649.0, 5417.0, 5276.0, 5510.0, 5408.0, 5469.0, 5666.0, 5636.0, 5716.0, 5426.0, 5681.0, 5515.0, 5537.0, 5453.0, 5341.0, 5654.0, 5622.0, 5409.0, 5303.0, 5318.0, 5547.0, 5416.0
29	5510	9	1	333	1	5450.0, 5719.0, 5558.0, 5689.0, 5691.0, 5515.0, 5326.0, 5567.0, 5270.0, 5362.0, 5604.0, 5292.0, 5506.0, 5640.0, 5627.0, 5509.0, 5481.0, 5442.0, 5278.0, 5677.0, 5524.0, 5652.0, 5256.0, 5461.0, 5483.0, 5497.0, 5664.0, 5521.0, 5615.0, 5681.0, 5666.0, 5317.0, 5683.0, 5385.0, 5293.0, 5631.0, 5714.0, 5710.0, 5498.0, 5548.0, 5356.0, 5314.0, 5670.0, 5554.0, 5717.0, 5358.0, 5355.0, 5617.0, 5723.0, 5393.0, 5487.0, 5274.0, 5433.0, 5507.0, 5412.0, 5499.0, 5475.0, 5398.0, 5577.0, 5476.0, 5585.0, 5513.0, 5707.0, 5472.0, 5367.0, 5312.0, 5428.0, 5402.0, 5489.0, 5656.0, 5410.0, 5589.0, 5308.0, 5378.0, 5562.0, 5377.0, 5403.0, 5311.0, 5510.0, 5340.0, 5619.0, 5657.0, 5422.0, 5336.0, 5316.0, 5288.0, 5426.0, 5544.0, 5275.0, 5470.0, 5335.0, 5343.0, 5380.0, 5690.0, 5543.0, 5341.0, 5609.0, 5359.0, 5542.0, 5284.0
30	5510	9	1	333	1	5426.0, 5637.0, 5392.0, 5296.0, 5517.0, 5531.0, 5530.0, 5641.0, 5602.0, 5362.0, 5487.0, 5629.0, 5303.0, 5642.0, 5590.0, 5667.0, 5615.0, 5294.0, 5295.0, 5527.0, 5652.0, 5578.0, 5647.0, 5298.0, 5704.0, 5541.0, 5338.0, 5284.0, 5657.0, 5552.0, 5507.0, 5458.0, 5692.0, 5538.0, 5463.0, 5374.0, 5257.0, 5577.0, 5567.0, 5251.0, 5324.0, 5623.0, 5512.0, 5650.0, 5719.0, 5514.0, 5366.0, 5610.0, 5712.0, 5344.0, 5679.0, 5502.0, 5535.0, 5451.0, 5503.0, 5619.0, 5424.0, 5329.0, 5686.0, 5408.0, 5291.0, 5304.0, 5433.0, 5542.0, 5266.0

						5599.0, 5283.0, 5529.0, 5386.0, 5420.0, 5700.0, 5315.0, 5603.0, 5444.0, 5494.0, 5490.0, 5616.0, 5385.0, 5349.0, 5684.0, 5528.0, 5644.0, 5300.0, 5406.0, 5706.0, 5399.0, 5434.0, 5586.0, 5543.0, 5476.0, 5532.0, 5484.0, 5272.0, 5662.0, 5442.0, 5721.0, 5438.0, 5479.0, 5683.0, 5380.0
--	--	--	--	--	--	--

80MHz

Radar SignalType	Waveform/Trial Number	Detection (%)	Limit (%)	Pass/Fail
Type 1A	15	100%	60%	pass
Type 1B	15	100%	60%	pass
Type 2	30	100 %	60%	Pass
Type 3	30	96.7 %	60%	Pass
Type 4	30	96.7 %	60%	Pass
Aggregate(Type1 to 4)	120	98.3%	80%	Pass
Type 5	30	93.3 %	80%	Pass
Type 6	30	100 %	70%	Pass

Please refer to the following statistical tables:

5530MHz**Radar Type 1A Statistical Performance**

Trial #	Fc (MHz)	Pulse/Burst	Pulse Width (μS)	PRI (μs)	Detection (1:yes; 0:no)
1	5530	99	1	538	1
2	5530	72	1	738	1
3	5530	63	1	838	1
4	5530	81	1	658	1
5	5530	59	1	898	1
6	5530	95	1	558	1
7	5530	61	1	878	1
8	5530	92	1	578	1
9	5530	65	1	818	1
10	5530	76	1	698	1
11	5530	68	1	778	1
12	5530	89	1	598	1
13	5530	70	1	758	1
14	5530	62	1	858	1
15	5530	78	1	678	1
Detection Percentage: 100 % (>60%)					

Radar Type 1B Statistical Performance

Trial #	Fc (MHz)	Pulse/Burst	Pulse Width (μS)	PRI (μs)	Detection (1:yes; 0:no)
1	5530	69	1	770	1
2	5530	68	1	780	1
3	5530	20	1	2644	1
4	5530	30	1	1776	1
5	5530	23	1	2333	1
6	5530	21	1	2530	1
7	5530	73	1	725	1
8	5530	24	1	2218	1
9	5530	22	1	2417	1
10	5530	35	1	1526	1
11	5530	26	1	2056	1
12	5530	25	1	2149	1
13	5530	29	1	1857	1
14	5530	23	1	2318	1
15	5530	30	1	1816	1
Detection Percentage: 100 % (>60%)					

Radar Type 2 Statistical Performance

Trial #	Fc (MHz)	Pulse/Burst	Pulse Width (μS)	PRI (μs)	Detection (1:yes; 0:no)
1	5530	28	3.9	183	1
2	5530	24	4.4	198	1
3	5530	23	2	168	1
4	5530	28	1.4	193	1
5	5530	28	1.7	216	1
6	5530	26	1.6	218	1
7	5530	26	2.4	175	1
8	5530	28	4.8	154	1
9	5530	23	1.6	178	1
10	5530	24	2.3	193	1
11	5530	28	3.8	186	1
12	5530	24	2.7	221	1
13	5530	29	4.1	209	1
14	5530	28	4.1	199	1
15	5530	26	1.1	166	1
16	5530	25	4.8	180	1
17	5530	26	4.7	154	1
18	5530	27	1.5	214	1
19	5530	24	2.8	184	1
20	5530	27	4.4	230	1
21	5530	27	2.7	162	1
22	5530	26	2.9	211	1
23	5530	28	4.4	166	1
24	5530	24	4.4	166	1
25	5530	28	4.3	216	1
26	5530	29	1.6	205	1
27	5530	28	1.5	172	1
28	5530	24	4.3	162	1
29	5530	23	3.5	181	1
30	5530	24	1.1	209	1
Detection Percentage: 100 % (>60%)					

Radar Type 3 Statistical Performance

Trial #	Fc (MHz)	Pulse/Burst	Pulse Width (μS)	PRI (μs)	Detection (1:yes; 0:no)
1	5530	18	6.4	430	1
2	5530	18	8.3	393	1
3	5530	17	8.5	387	1
4	5530	18	6.7	243	1
5	5530	16	9.7	393	1
6	5530	17	9.9	446	1
7	5530	17	8.8	273	1
8	5530	17	7	463	1
9	5530	18	8.4	328	1
10	5530	18	9.4	210	1
11	5530	18	9.6	324	1
12	5530	16	10	438	1
13	5530	17	8.9	334	1
14	5530	17	8	485	1
15	5530	16	9.8	337	1
16	5530	17	9.4	493	1
17	5530	16	8.2	414	1
18	5530	18	8.3	462	1
19	5530	18	6.7	311	1
20	5530	18	6.4	395	1
21	5530	18	7.7	210	0
22	5530	18	6.2	456	1
23	5530	17	10	446	1
24	5530	17	6.4	404	1
25	5530	17	8.6	408	1
26	5530	17	9.4	389	1
27	5530	16	7	383	1
28	5530	16	6.5	210	1
29	5530	18	9.5	215	1
30	5530	18	6.3	400	1
Detection Percentage: 96.7 % (>60%)					

Radar Type 4 Statistical Performance

Trial #	Fc (MHz)	Pulse/Burst	Pulse Width (μS)	PRI (μs)	Detection (1:yes; 0:no)
1	5530	12	14.9	414	1
2	5530	16	13.8	273	1
3	5530	13	14.2	379	1
4	5530	16	14.5	330	1
5	5530	13	11.9	409	1
6	5530	15	19.6	292	1
7	5530	15	15.5	459	1
8	5530	12	16.1	316	1
9	5530	16	17.4	266	1
10	5530	15	14	308	1
11	5530	14	18.5	378	1
12	5530	12	15.1	419	1
13	5530	16	14.8	308	1
14	5530	16	18.2	266	1
15	5530	12	15.8	449	1
16	5530	15	11.3	369	1
17	5530	13	20	455	1
18	5530	15	16.2	205	1
19	5530	16	19.8	295	1
20	5530	14	11.5	285	1
21	5530	12	16.7	485	1
22	5530	12	15	457	1
23	5530	15	17.1	277	1
24	5530	14	13.7	267	1
25	5530	12	12.8	359	0
26	5530	13	12	480	1
27	5530	14	11.5	224	1
28	5530	15	19	485	1
29	5530	14	18.8	276	1
30	5530	14	18.7	272	1
Detection Percentage: 96.7 % (>60%)					

Radar Type 5 Case 1 Statistical Performance

Statistics 1 (ChirpCenter Frequency: 5530.0MHz)

Trial #	Pulse	Chirp(MHz)	Pulse Width (µS)	Pulse 1-2 spacing(µS)	Pulse 2-3 spacing(µS)	Pulse Start(S)	Detection (1:yes;0:no)
0	3	13	89.4	1293	1877	0.424322	1
1	1	13	95.2			0.945878	
2	3	13	65.7	1012	1248	1.828932	
3	3	13	96.1	1615	1025	2.13204	
4	1	13	92.6			3.271818	
5	2	13	55.1	1663		3.727001	
6	3	13	69.2	1089	1381	4.616707	
7	1	13	59.2			4.797544	
8	2	13	62.2	1845		5.851237	
9	1	13	66.3			6.629509	
10	3	13	88	1890	1211	7.001304	
11	3	13	82	1616	1001	7.918735	
12	2	13	88.9	1413		8.196355	
13	3	13	67.5	1370	1464	9.178235	
14	1	13	74.1			9.757445	
15	2	13	67.1	1290		10.18191	
16	3	13	53.6	1818	1217	10.72146	
17	3	13	96.5	1880	1283	11.71074	

Statistics 2 (ChirpCenter Frequency: 5530.0 MHz)

Trial #	Pulse	Chirp(MHz)	Pulse Width (µS)	Pulse 1-2 spacing(µS)	Pulse 2-3 spacing(µS)	Pulse Start(S)	Detection (1:yes;0:no)
0	2	15	83.2	1955		0.392473	1
1	1	15	91.4			1.036352	
2	1	15	90.4			1.382267	
3	3	15	63	1798	1786	2.51403	
4	2	15	50.2	1039		2.933555	
5	1	15	64.3			3.67029	
6	3	15	58.2	1753	1412	3.833819	
7	1	15	67.9			4.738728	
8	2	15	62.5	1220		5.624378	
9	3	15	92.3	1205	1901	5.696179	
10	2	15	88.5	1733		6.377409	
11	2	15	50.9	1078		6.999691	
12	2	15	55.1	1187		7.730119	
13	3	15	57.4	1407	1368	8.628919	
14	3	15	89.7	1195	1290	9.235388	
15	2	15	66.9	1793		9.676004	
16	2	15	89.9	1811		10.4229	
17	2	15	76.8	1050		10.81463	
18	3	15	54.1	1580	1216	11.56264	

Statistics 3 (ChirpCenter Frequency: 5530.0 MHz)

Trial #	Pulse	Chirp(MHz)	Pulse Width (μS)	Pulse 1-2 spacing(μS)	Pulse 2-3 spacing(μS)	Pulse Start(S)	Detection (1:yes;0:no)
0	1	6	78.4			0.111614	1
1	2	6	62.5	1829		1.799719	
2	1	6	99.3			2.096689	
3	3	6	94.9	1833	1124	2.833875	
4	1	6	88.8			4.085236	
5	2	6	50.5	1741		5.183335	
6	3	6	78	1552	1057	6.233509	
7	3	6	84.8	1998	1370	6.931548	
8	2	6	82.5	1795		7.479134	
9	2	6	89.7	1326		9.179021	
10	1	6	55.7			9.916155	
11	1	6	68.6			11.03178	
12	2	6	58.1	1903		11.09518	

Statistics 4 (ChirpCenter Frequency: 5530.0 MHz)

Trial #	Pulse	Chirp(MHz)	Pulse Width (μS)	Pulse 1-2 spacing(μS)	Pulse 2-3 spacing(μS)	Pulse Start(S)	Detection (1:yes;0:no)
0	1	6	93.8			0.48196	1
1	3	6	82.9	1930	1933	1.702591	
2	3	6	51.6	1008	1171	2.316803	
3	2	6	73.1	1112		3.164558	
4	1	6	94.7			3.629966	
5	1	6	94.8			4.706783	
6	2	6	66	1411		5.534755	
7	2	6	78.9	1908		6.124489	
8	2	6	51.2	1767		7.308916	
9	1	6	77.4			8.353788	
10	2	6	69.1	1591		8.825984	
11	2	6	70.4	1694		9.71735	
12	2	6	69.4	1224		10.95313	
13	1	6	89.8			11.32053	

Statistics 5(ChirpCenter Frequency: 5530.0 MHz)

Trial #	Pulse	Chirp(MHz)	Pulse Width (μS)	Pulse 1-2 spacing(μS)	Pulse 2-3 spacing(μS)	Pulse Start(S)	Detection (1:yes;0:no)
0	2	8	94.7	1324		0.685491	1
1	2	8	86.3	1575		1.35139	
2	2	8	75.1	1659		2.832289	
3	3	8	78.3	1156	1731	3.835121	
4	2	8	96.3	1645		4.023613	
5	1	8	69.9			5.016215	
6	2	8	80.7	1194		6.489713	
7	3	8	54	1499	1784	7.311667	
8	1	8	60.7			8.832922	
9	2	8	96.7	1548		9.886724	
10	2	8	69.6	1059		10.59109	
11	1	8	73.4			11.41212	

Statistics 6 (ChirpCenter Frequency: 5500.0 MHz)

Trial #	Pulse	Chirp(MHz)	Pulse Width (μS)	Pulse 1-2 spacing(μS)	Pulse 2-3 spacing(μS)	Pulse Start(S)	Detection (1:yes;0:no)
0	2	14	63.2	1219		0.616653	1
1	2	14	70.6	1527		1.146365	
2	2	14	58.4	1563		2.060045	
3	1	14	69			3.122173	
4	1	14	55.6			3.618457	
5	2	14	66.5	1265		4.423601	
6	3	14	92.1	1094	1367	5.404092	
7	2	14	56.1	1258		6.312747	
8	1	14	59.6			7.115076	
9	2	14	88.2	1538		8.218028	
10	3	14	67.5	1963	1682	9.185494	
11	3	14	52	1253	1519	9.431491	
12	1	14	91.2			10.67482	
13	3	14	76.6	1222	1667	11.87716	

Statistics 7(ChirpCenter Frequency: 5530.0 MHz)

Trial #	Pulse	Chirp(MHz)	Pulse Width (μS)	Pulse 1-2 spacing(μS)	Pulse 2-3 spacing(μS)	Pulse Start(S)	Detection (1:yes;0:no)
0	3	10	52	1384	1861	0.740573	1
1	2	10	67.6	1078		1.099695	
2	3	10	97.1	1057	1277	2.538591	
3	2	10	50.6	1297		3.675137	
4	2	10	94.3	1388		4.071587	
5	2	10	58.1	1516		5.894071	
6	2	10	51.2	1476		6.590089	
7	2	10	81.7	1168		7.73192	
8	2	10	78	1572		8.686925	
9	2	10	56.5	1010		9.169522	
10	2	10	74	1102		10.73948	
11	2	10	55	1502		11.47063	

Statistics 8 (ChirpCenter Frequency: 5530.0 MHz)

Trial #	Pulse	Chirp(MHz)	Pulse Width (μS)	Pulse 1-2 spacing(μS)	Pulse 2-3 spacing(μS)	Pulse Start(S)	Detection (1:yes;0:no)
0	1	14	99.6			0.285432	1
1	3	14	63.8	1991	1442	0.680753	
2	1	14	66.4			1.708281	
3	3	14	82.2	1580	1363	2.313838	
4	2	14	86.6	1104		2.734047	
5	2	14	66.7	1155		3.639016	
6	2	14	54.7	1796		3.839589	
7	2	14	87.1	1085		4.951806	
8	3	14	51.5	1356	1771	5.216009	
9	2	14	86.9	1773		6.010453	
10	2	14	59.8	1127		6.392811	
11	1	14	77.7			7.459272	
12	1	14	60.9			7.600463	
13	3	14	89.5	1786	1281	8.558913	
14	2	14	55.1	1630		9.442031	
15	1	14	62.9			9.645149	
16	2	14	92.4	1803		10.54226	
17	2	14	76.3	1073		10.77727	
18	2	14	91.7	1839		11.84562	

Statistics 9 (ChirpCenter Frequency: 5530.0 MHz)

Trial #	Pulse	Chirp(MHz)	Pulse Width (μS)	Pulse 1-2 spacing(μS)	Pulse 2-3 spacing(μS)	Pulse Start(S)	Detection (1:yes;0:no)
0	1	9	58.2			0.162229	1
1	1	9	75.3			1.037124	
2	1	9	58.8			2.176161	
3	2	9	67.7	1765		2.444697	
4	2	9	79	1194		3.899161	
5	2	9	82.9	1884		4.535573	
6	2	9	88.6	1599		5.329957	
7	1	9	56.3			5.724812	
8	1	9	67.4			6.865192	
9	2	9	99	1937		7.706642	
10	1	9	88.7			8.59459	
11	3	9	97.9	1540	1472	9.309968	
12	2	9	71.8	1206		10.32241	
13	3	9	53.3	1570	1963	10.77269	
14	3	9	58.5	1527	1669	11.83346	

Statistics 10 (ChirpCenter Frequency: 5530.0 MHz)

Trial #	Pulse	Chirp(MHz)	Pulse Width (μS)	Pulse 1-2 spacing(μS)	Pulse 2-3 spacing(μS)	Pulse Start(S)	Detection (1:yes;0:no)
0	2	12	68.4	1763		0.421917	1
1	2	12	70.3	1867		0.894953	
2	1	12	83.3			1.269812	
3	3	12	68.6	1171	1019	2.27961	
4	3	12	97.8	1204	1560	3.111524	
5	3	12	95.4	1977	1572	3.741298	
6	2	12	76.1	1301		4.073803	
7	1	12	50.1			5.014295	
8	3	12	97.1	1662	1774	5.320537	
9	2	12	95.3	1404		6.163543	
10	3	12	76	1765	1255	6.842907	
11	2	12	72.9	1518		7.234826	
12	2	12	78	1915		7.964352	
13	3	12	84.2	1251	1259	8.466862	
14	3	12	82.6	1161	1966	9.216666	
15	2	12	55	1935		9.575864	
16	2	12	94.1	1802		10.53196	
17	2	12	83.4	1220		11.17479	
18	2	12	89.7	1901		11.42744	

Radar Type 5 Case 2 Statistical Performance

Statistics 1 (ChirpCenter Frequency: 5495.0MHz)

Trial #	Pulse	Chirp(MHz)	Pulse Width (μS)	Pulse 1-2 spacing(μS)	Pulse 2-3 spacing(μS)	Pulse Start(S)	Detection (1:yes;0:no)
0	3	11	83.8	1144	1878	0.966504	1
1	2	11	79.2	1330		1.633932	
2	3	11	68.8	1171	1039	2.004423	
3	3	11	86.1	1236	1406	3.212879	
4	1	11	72.7			4.625298	
5	2	11	76.6	1350		5.983492	
6	2	11	70.1	1930		6.402528	
7	2	11	63.2	1926		7.769342	
8	3	11	61.4	1782	1860	8.12069	
9	1	11	91.5			9.463872	
10	1	11	67.7			10.57759	
11	1	11	74.9			11.31538	

Statistics 2 (ChirpCenter Frequency: 5495.0 MHz)

Trial #	Pulse	Chirp(MHz)	Pulse Width (μS)	Pulse 1-2 spacing(μS)	Pulse 2-3 spacing(μS)	Pulse Start(S)	Detection (1:yes;0:no)
0	1	10	92.8			0.235951	1
1	3	10	53.3	1940	1427	1.202326	
2	2	10	88.9	1744		1.624732	
3	2	10	62.1	1528		2.641587	
4	3	10	63.7	1809	1260	3.503093	
5	3	10	88.7	1270	1546	3.842327	
6	2	10	70.4	1245		4.979611	
7	2	10	69.7	1001		5.934858	
8	3	10	78.6	1554	1382	6.55596	
9	2	10	89.5	1490		6.761146	
10	3	10	67.6	1009	1526	8.067569	
11	3	10	57.8	1457	1246	8.334263	
12	1	10	59.4			9.176339	
13	3	10	79.5	1357	1267	10.29241	
14	2	10	77	1929		10.59787	
15	2	10	75.6	1392		11.4053	

Statistics 3 (ChirpCenter Frequency: 5494.0 MHz)

Trial #	Pulse	Chirp(MHz)	Pulse Width (µS)	Pulse 1-2 spacing(µS)	Pulse 2-3 spacing(µS)	Pulse Start(S)	Detection (1:yes;0:no)
0	3	9	66.3	1573	1542	0.043197	1
1	3	9	50.6	1597	1181	1.249107	
2	2	9	58.2	1666		1.72446	
3	3	9	65.1	1555	1058	1.918807	
4	1	9	92			2.586726	
5	1	9	79.9			3.324929	
6	1	9	91.5			3.96531	
7	3	9	86.1	1988	1034	4.577282	
8	2	9	53.5	1986		5.67708	
9	3	9	86.4	1957	1526	5.996583	
10	2	9	66	1309		6.564562	
11	2	9	73.7	1222		7.224224	
12	2	9	68	1525		7.682775	
13	2	9	77.6	1977		8.745268	
14	2	9	82	1850		9.408066	
15	3	9	58.2	1904	1840	9.901629	
16	2	9	98.5	1864		10.19931	
17	2	9	92.7	1956		11.26343	
18	2	9	98.2	1550		11.62184	

Statistics 4 (ChirpCenter Frequency: 5493.0 MHz)

Trial #	Pulse	Chirp(MHz)	Pulse Width (µS)	Pulse 1-2 spacing(µS)	Pulse 2-3 spacing(µS)	Pulse Start(S)	Detection (1:yes;0:no)
0	2	12	65.7	1846		0.360535	1
1	3	12	89.1	1981	1482	1.770015	
2	2	12	54.9	1402		2.651713	
3	2	12	78.4	1286		4.179618	
4	1	12	50.7			4.82754	
5	2	12	59.9	1311		6.503814	
6	3	12	76.4	1065	1917	7.347891	
7	2	12	82.8	1829		7.681642	
8	1	12	78.9			9.629869	
9	2	12	56.2	1732		9.935703	
10	1	12	95			11.18831	

Statistics 5(ChirpCenter Frequency: 5493.0 MHz)

Trial #	Pulse	Chirp(MHz)	Pulse Width (μS)	Pulse 1-2 spacing(μS)	Pulse 2-3 spacing(μS)	Pulse Start(S)	Detection (1:yes;0:no)
0	2	6	76.8	1649		0.243256	0
1	2	6	71.7	1029		1.081471	
2	2	6	77	1513		2.216073	
3	2	6	53.8	1062		3.060319	
4	1	6	53.7			4.256321	
5	2	6	58.5	1443		5.592	
6	2	6	76.3	1287		6.195256	
7	2	6	77.4	1718		7.820439	
8	1	6	88.1			8.65505	
9	3	6	83.7	1133	1058	9.790626	
10	1	6	98.5			10.45011	
11	2	6	56.5	1961		11.14886	

Statistics 6 (ChirpCenter Frequency: 5497.0 MHz)

Trial #	Pulse	Chirp(MHz)	Pulse Width (μS)	Pulse 1-2 spacing(μS)	Pulse 2-3 spacing(μS)	Pulse Start(S)	Detection (1:yes;0:no)
0	2	16	87.9	1566		0.656447	0
1	2	16	50.3	1093		1.057519	
2	2	16	55	1918		2.086269	
3	3	16	55.4	1411	1561	2.308032	
4	1	16	63.8			3.051016	
5	3	16	61.3	1204	1233	4.222881	
6	2	16	63.4	1135		4.488009	
7	2	16	97.3	1909		5.63516	
8	2	16	86.4	1973		5.942315	
9	2	16	79.4	1246		6.526359	
10	2	16	55.2	1225		7.651136	
11	2	16	67.9	1609		7.84105	
12	3	16	65.1	1999	1919	8.933557	
13	1	16	90.2			9.462193	
14	1	16	58			10.29728	
15	2	16	87.9	1032		11.21336	
16	1	16	62.9			11.83583	

Statistics 7(ChirpCenter Frequency: 5494.0 MHz)

Trial #	Pulse	Chirp(MHz)	Pulse Width (μS)	Pulse 1-2 spacing(μS)	Pulse 2-3 spacing(μS)	Pulse Start(S)	Detection (1:yes;0:no)
0	3	20	96.4	1493	1325	0.942443	1
1	3	20	77.4	1523	1994	1.500473	
2	3	20	84.6	1458	1646	3.285136	
3	2	20	73.6	1725		5.071029	
4	2	20	52.1	1010		5.5935	
5	1	20	71.3			6.759665	
6	3	20	71.6	1107	1386	8.41552	
7	2	20	90.7	1378		10.37748	
8	3	20	53.7	1898	1062	11.34048	

Statistics 8 (ChirpCenter Frequency: 5494.0 MHz)

Trial #	Pulse	Chirp(MHz)	Pulse Width (μS)	Pulse 1-2 spacing(μS)	Pulse 2-3 spacing(μS)	Pulse Start(S)	Detection (1:yes;0:no)
0	2	14	59	1164		0.292813	1
1	3	14	54.7	1706	1018	1.830282	
2	2	14	79.9	1008		2.297932	
3	2	14	53.6	1025		3.498794	
4	3	14	63.4	1742	1491	4.78265	
5	1	14	90.4			5.523204	
6	3	14	73.1	1029	1226	6.926952	
7	1	14	99.9			7.630008	
8	2	14	52.8	1471		8.938039	
9	2	14	93.6	1539		9.817249	
10	1	14	73.5			10.42918	
11	2	14	83.1	1941		11.20772	

Statistics 9 (ChirpCenter Frequency: 5497.0 MHz)

Trial #	Pulse	Chirp(MHz)	Pulse Width (μS)	Pulse 1-2 spacing(μS)	Pulse 2-3 spacing(μS)	Pulse Start(S)	Detection (1:yes;0:no)
0	2	5	87.5	1539		0.926143	1
1	3	5	87.1	1187	1881	2.074956	
2	3	5	84.7	1189	1027	2.63106	
3	2	5	87	1252		3.394605	
4	2	5	99.1	1454		5.268229	
5	2	5	69	1370		5.821287	
6	2	5	78.4	1126		7.320171	
7	2	5	81.4	1382		8.573897	
8	2	5	74.4	1837		9.475325	
9	2	5	50.2	1131		10.21513	
10	1	5	51			11.62186	

Statistics 10 (ChirpCenter Frequency: 5496.0 MHz)

Trial #	Pulse	Chirp(MHz)	Pulse Width (μS)	Pulse 1-2 spacing(μS)	Pulse 2-3 spacing(μS)	Pulse Start(S)	Detection (1:yes;0:no)
0	1	15	58.5			0.057208	1
1	1	15	61.6			1.746669	
2	2	15	73.4	1229		2.716265	
3	2	15	71.2	1327		4.11546	
4	3	15	77.3	1802	1343	5.962406	
5	1	15	71.1			7.65338	
6	3	15	60.4	1501	1480	8.850219	
7	1	15	73.3			9.936985	
8	2	15	56.3	1845		11.60925	

Radar Type 5 Case 3 Statistical Performance

Statistics 1 (ChirpCenter Frequency: 5562.0MHz)

Trial #	Pulse	Chirp(MHz)	Pulse Width (μS)	Pulse 1-2 spacing(μS)	Pulse 2-3 spacing(μS)	Pulse Start(S)	Detection (1:yes;0:no)
0	2	7	84.2	1354		0.91807	1
1	2	7	50.8	1092		1.69682	
2	2	7	62.9	1025		3.450492	
3	2	7	80	1916		4.458818	
4	2	7	95.9	1658		6.320234	
5	3	7	74	1773	1250	7.666918	
6	3	7	56.6	1028	1810	9.159174	
7	3	7	54.7	1243	1360	9.558506	
8	1	7	95.9			11.2981	

Statistics 2 (ChirpCenter Frequency: 5565.0 MHz)

Trial #	Pulse	Chirp(MHz)	Pulse Width (μS)	Pulse 1-2 spacing(μS)	Pulse 2-3 spacing(μS)	Pulse Start(S)	Detection (1:yes;0:no)
0	3	6	66	1190	1436	1.269379	1
1	2	6	58.1	1909		2.93818	
2	2	6	70.6	1568		3.077113	
3	3	6	67.5	1467	1021	5.096919	
4	2	6	93	1913		6.901589	
5	2	6	63.5	1261		7.530483	
6	2	6	67.1	1564		10.33011	
7	2	6	67.5	1233		10.50782	

Statistics 3 (ChirpCenter Frequency: 5567.0 MHz)

Trial #	Pulse	Chirp(MHz)	Pulse Width (μS)	Pulse 1-2 spacing(μS)	Pulse 2-3 spacing(μS)	Pulse Start(S)	Detection (1:yes;0:no)
0	3	13	76.5	1119	1932	0.284244	1
1	1	13	54.1			1.38081	
2	1	13	59.3			1.717698	
3	3	13	90.7	1153	1993	2.465805	
4	1	13	67.9			3.50752	
5	1	13	81.6			3.632471	
6	2	13	51	1821		4.741534	
7	2	13	80.2	1912		5.417644	
8	1	13	55.1			5.807811	
9	3	13	69.2	1634	1512	6.952929	
10	1	13	56.3			7.708441	
11	1	13	59.7			8.45598	
12	1	13	84.6			8.855183	
13	3	13	56.4	1889	1812	9.639394	
14	1	13	73.7			10.51411	
15	2	13	90.9	1934		11.10625	
16	2	13	60.5	1628		11.99087	

Statistics 4 (ChirpCenter Frequency: 5566.0 MHz)

Trial #	Pulse	Chirp(MHz)	Pulse Width (μS)	Pulse 1-2 spacing(μS)	Pulse 2-3 spacing(μS)	Pulse Start(S)	Detection (1:yes;0:no)
0	2	16	72.7	1741		0.878115	1
1	2	16	89.3	1706		1.809924	
2	3	16	74.3	1878	1282	2.100309	
3	1	16	98			3.00479	
4	2	16	51.8	1870		3.848266	
5	3	16	52	1266	1701	5.287512	
6	1	16	60.6			5.588054	
7	2	16	67.8	1599		6.495676	
8	2	16	56.6	1442		8.231916	
9	2	16	53.1	1287		8.769979	
10	3	16	76.8	1455	1255	9.47316	
11	2	16	95.9	1042		10.79925	
12	3	16	84.7	1838	1163	11.17975	

Statistics 5(ChirpCenter Frequency: 5564.0 MHz)

Trial #	Pulse	Chirp(MHz)	Pulse Width (μS)	Pulse 1-2 spacing(μS)	Pulse 2-3 spacing(μS)	Pulse Start(S)	Detection (1:yes;0:no)
0	2	9	73.9	1385		0.406299	1
1	2	9	55.2	1390		1.588003	
2	2	9	81.6	1290		2.084248	
3	3	9	55.4	1513	1028	3.532353	
4	1	9	59.6			4.266695	
5	2	9	62.8	1571		5.322055	
6	2	9	54.3	1572		5.627669	
7	2	9	67.4	1281		7.064416	
8	2	9	75.6	1966		7.922333	
9	2	9	84.7	1628		9.078144	
10	2	9	81.7	1428		9.846941	
11	2	9	50.3	1859		10.73048	
12	2	9	80.1	1477		11.91052	

Statistics 6 (ChirpCenter Frequency: 5563.0 MHz)

Trial #	Pulse	Chirp(MHz)	Pulse Width (μS)	Pulse 1-2 spacing(μS)	Pulse 2-3 spacing(μS)	Pulse Start(S)	Detection (1:yes;0:no)
0	2	13	50.7	1768		0.189895	1
1	1	13	77.2			1.108124	
2	2	13	91.4	1269		1.56211	
3	2	13	97.1	1029		2.329027	
4	3	13	90.5	1268	1867	3.714858	
5	2	13	86.7	1495		3.852549	
6	1	13	81.1			5.231893	
7	2	13	71.5	1612		5.869653	
8	3	13	52.9	1180	1110	6.395794	
9	2	13	96.5	1310		7.084669	
10	3	13	53.5	1645	1951	8.174462	
11	1	13	70.7			8.625396	
12	2	13	58.1	1614		9.052985	
13	2	13	88.4	1079		10.47802	
14	2	13	97.5	1313		10.65181	
15	2	13	61.7	1967		11.62729	

Statistics 7(ChirpCenter Frequency: 5567.0 MHz)

Trial #	Pulse	Chirp(MHz)	Pulse Width (μS)	Pulse 1-2 spacing(μS)	Pulse 2-3 spacing(μS)	Pulse Start(S)	Detection (1:yes;0:no)
0	3	7	58.9	1506	1925	0.424078	1
1	3	7	98.7	1621	1020	1.175932	
2	2	7	76.2	1575		3.003283	
3	2	7	73.9	1263		4.300169	
4	2	7	60.1	1140		4.963585	
5	3	7	67.7	1413	1748	5.602798	
6	3	7	90.3	1437	1112	6.612536	
7	1	7	96.3			8.044335	
8	2	7	79	1463		8.806726	
9	1	7	52.3			9.8201	
10	1	7	85.5			10.95989	

Statistics 8 (ChirpCenter Frequency: 5565.0 MHz)

Trial #	Pulse	Chirp(MHz)	Pulse Width (μS)	Pulse 1-2 spacing(μS)	Pulse 2-3 spacing(μS)	Pulse Start(S)	Detection (1:yes;0:no)
0	2	6	93	1987		0.585777	1
1	2	6	95.7	1683		1.866078	
2	2	6	56	1739		2.523559	
3	2	6	97.3	1919		3.883087	
4	3	6	62.9	1233	1713	5.187512	
5	2	6	97.9	1858		6.38146	
6	2	6	55	1774		7.270476	
7	3	6	50.9	1852	1815	8.07993	
8	2	6	81.5	1356		9.387409	
9	3	6	62.8	1183	1060	10.30196	
10	2	6	74.3	1705		11.5418	

Statistics 9 (ChirpCenter Frequency: 5567.0 MHz)

Trial #	Pulse	Chirp(MHz)	Pulse Width (μ S)	Pulse 1-2 spacing(μ S)	Pulse 2-3 spacing(μ S)	Pulse Start(S)	Detection (1:yes;0:no)
0	3	9	82	1301	1722	0.590957	1
1	3	9	67.3	1254	1952	1.565601	
2	2	9	66.8	1305		1.753492	
3	2	9	70.2	1328		2.834977	
4	2	9	79.8	1060		3.482414	
5	2	9	54.2	1030		4.666147	
6	3	9	53.2	1252	1221	5.526698	
7	2	9	79.9	1314		6.255244	
8	1	9	78			6.57261	
9	3	9	75.7	1212	1765	7.857784	
10	2	9	55	1875		8.393607	
11	2	9	60.6	1530		9.050665	
12	1	9	95			9.688569	
13	3	9	93.3	1148	1323	11.06377	
14	2	9	89.8	1579		11.6802	

Statistics 10 (ChirpCenter Frequency: 5564.0 MHz)

Trial #	Pulse	Chirp(MHz)	Pulse Width (μ S)	Pulse 1-2 spacing(μ S)	Pulse 2-3 spacing(μ S)	Pulse Start(S)	Detection (1:yes;0:no)
0	2	16	79.3	1792		0.105258	1
1	2	16	99.9	1987		0.761787	
2	1	16	84.5			2.111848	
3	2	16	83.8	1750		2.763597	
4	3	16	53.8	1851	1750	3.09075	
5	2	16	50.2	1741		3.624483	
6	3	16	98.1	1811	1408	4.37765	
7	1	16	53.7			5.40621	
8	3	16	58	1028	1033	6.176472	
9	2	16	55.7	1778		6.566804	
10	2	16	69	1539		7.11281	
11	1	16	92.6			7.905917	
12	3	16	90.1	1425	1944	9.135341	
13	3	16	70.8	1157	1849	9.786505	
14	2	16	92.4	1811		10.29665	
15	1	16	74.8			11.27684	
16	1	16	82.9			11.78967	

Radar Type 6 Statistical Performance

Trial #	Fc (MHz)	Pulse /Burst	Pulse Width (µS)	PRI (µs)	Detection (1:yes; 0:no)	Hopping Sequence (MHz)
1	5530	9	1	333	1	5503.0, 5588.0, 5531.0, 5288.0, 5356.0, 5428.0, 5638.0, 5311.0, 5723.0, 5702.0, 5399.0, 5715.0, 5565.0, 5258.0, 5361.0, 5647.0, 5635.0, 5518.0, 5292.0, 5314.0, 5353.0, 5389.0, 5630.0, 5540.0, 5584.0, 5274.0, 5476.0, 5468.0, 5256.0, 5343.0, 5371.0, 5558.0, 5425.0, 5438.0, 5378.0, 5259.0, 5280.0, 5636.0, 5277.0, 5414.0, 5295.0, 5526.0, 5340.0, 5671.0, 5494.0, 5367.0, 5435.0, 5394.0, 5651.0, 5510.0, 5251.0, 5511.0, 5656.0, 5293.0, 5645.0, 5478.0, 5710.0, 5564.0, 5595.0, 5582.0, 5377.0, 5533.0, 5663.0, 5680.0, 5551.0, 5659.0, 5672.0, 5537.0, 5500.0, 5374.0, 5690.0, 5591.0, 5650.0, 5329.0, 5580.0, 5469.0, 5278.0, 5677.0, 5493.0, 5694.0, 5515.0, 5721.0, 5589.0, 5549.0, 5303.0, 5350.0, 5421.0, 5697.0, 5381.0, 5688.0, 5536.0, 5319.0, 5714.0, 5404.0, 5683.0, 5666.0, 5358.0, 5712.0, 5602.0, 5397.0
2	5530	9	1	333	1	5271.0, 5682.0, 5507.0, 5387.0, 5490.0, 5354.0, 5284.0, 5624.0, 5626.0, 5587.0, 5276.0, 5696.0, 5546.0, 5524.0, 5505.0, 5440.0, 5288.0, 5562.0, 5576.0, 5433.0, 5511.0, 5660.0, 5407.0, 5321.0, 5622.0, 5664.0, 5399.0, 5367.0, 5599.0, 5418.0, 5368.0, 5611.0, 5504.0, 5574.0, 5540.0, 5593.0, 5356.0, 5442.0, 5256.0, 5627.0, 5647.0, 5388.0, 5411.0, 5320.0, 5616.0, 5564.0, 5438.0, 5715.0, 5346.0, 5693.0, 5460.0, 5638.0, 5476.0, 5680.0, 5471.0, 5641.0, 5383.0, 5487.0, 5498.0, 5255.0, 5362.0, 5251.0, 5643.0, 5491.0, 5508.0, 5286.0, 5575.0, 5316.0, 5691.0, 5555.0, 5676.0, 5703.0, 5457.0, 5287.0, 5441.0, 5401.0, 5632.0, 5620.0, 5613.0, 5584.0, 5404.0, 5492.0, 5550.0, 5374.0, 5267.0, 5260.0, 5513.0, 5303.0, 5313.0, 5279.0, 5364.0, 5707.0, 5572.0, 5602.0, 5657.0, 5430.0, 5467.0, 5614.0, 5323.0, 5341.0
3	5530	9	1	333	1	5376.0, 5676.0, 5689.0, 5414.0, 5375.0, 5390.0, 5490.0, 5691.0, 5719.0, 5416.0, 5630.0, 5571.0, 5355.0, 5279.0, 5293.0, 5366.0, 5717.0, 5692.0, 5298.0, 5251.0, 5519.0, 5613.0, 5525.0, 5524.0, 5647.0, 5549.0, 5362.0, 5433.0, 5703.0, 5350.0, 5702.0, 5671.0, 5601.0, 5563.0, 5569.0, 5473.0, 5331.0, 5401.0, 5481.0, 5685.0, 5505.0, 5449.0, 5704.0, 5583.0, 5557.0, 5624.0, 5661.0, 5357.0, 5485.0, 5538.0, 5464.0, 5514.0, 5398.0, 5439.0, 5536.0, 5698.0, 5683.0, 5566.0, 5367.0, 5364.0, 5438.0, 5340.0, 5460.0, 5608.0, 5358.0

						5443.0, 5424.0, 5373.0, 5511.0, 5330.0, 5600.0, 5602.0, 5455.0, 5256.0, 5679.0, 5688.0, 5389.0, 5445.0, 5714.0, 5314.0, 5385.0, 5476.0, 5261.0, 5617.0, 5619.0, 5586.0, 5675.0, 5266.0, 5288.0, 5431.0, 5470.0, 5354.0, 5418.0, 5328.0, 5292.0, 5337.0, 5402.0, 5488.0, 5307.0, 5369.0
4	5530	9	1	333	1	5521.0, 5429.0, 5260.0, 5279.0, 5257.0, 5614.0, 5559.0, 5442.0, 5513.0, 5300.0, 5444.0, 5693.0, 5533.0, 5484.0, 5544.0, 5696.0, 5510.0, 5633.0, 5345.0, 5365.0, 5722.0, 5609.0, 5432.0, 5564.0, 5579.0, 5418.0, 5528.0, 5430.0, 5299.0, 5576.0, 5438.0, 5314.0, 5403.0, 5553.0, 5416.0, 5308.0, 5481.0, 5270.0, 5694.0, 5588.0, 5487.0, 5680.0, 5721.0, 5409.0, 5682.0, 5256.0, 5574.0, 5338.0, 5495.0, 5425.0, 5648.0, 5386.0, 5585.0, 5321.0, 5709.0, 5349.0, 5398.0, 5422.0, 5695.0, 5400.0, 5650.0, 5631.0, 5272.0, 5468.0, 5475.0, 5440.0, 5504.0, 5331.0, 5318.0, 5687.0, 5397.0, 5621.0, 5672.0, 5261.0, 5337.0, 5704.0, 5322.0, 5506.0, 5611.0, 5292.0, 5253.0, 5480.0, 5357.0, 5461.0, 5520.0, 5330.0, 5421.0, 5552.0, 5683.0, 5698.0, 5543.0, 5364.0, 5377.0, 5501.0, 5626.0, 5566.0, 5561.0, 5356.0, 5448.0, 5689.0
5	5530	9	1	333	1	5373.0, 5716.0, 5520.0, 5626.0, 5319.0, 5602.0, 5363.0, 5389.0, 5370.0, 5295.0, 5391.0, 5298.0, 5315.0, 5417.0, 5258.0, 5521.0, 5568.0, 5406.0, 5724.0, 5625.0, 5326.0, 5278.0, 5446.0, 5663.0, 5408.0, 5722.0, 5405.0, 5401.0, 5658.0, 5325.0, 5522.0, 5359.0, 5296.0, 5622.0, 5329.0, 5695.0, 5415.0, 5613.0, 5484.0, 5288.0, 5388.0, 5483.0, 5506.0, 5269.0, 5524.0, 5530.0, 5704.0, 5377.0, 5320.0, 5302.0, 5698.0, 5667.0, 5676.0, 5432.0, 5342.0, 5421.0, 5575.0, 5260.0, 5596.0, 5424.0, 5349.0, 5714.0, 5606.0, 5356.0, 5372.0, 5703.0, 5317.0, 5633.0, 5403.0, 5476.0, 5631.0, 5364.0, 5707.0, 5318.0, 5343.0, 5548.0, 5382.0, 5672.0, 5640.0, 5487.0, 5347.0, 5410.0, 5413.0, 5628.0, 5566.0, 5675.0, 5353.0, 5576.0, 5619.0, 5335.0, 5384.0, 5662.0, 5459.0, 5679.0, 5321.0, 5594.0, 5358.0, 5681.0, 5265.0, 5297.0
6	5530	9	1	333	1	5399.0, 5297.0, 5504.0, 5552.0, 5419.0, 5696.0, 5464.0, 5638.0, 5451.0, 5708.0, 5321.0, 5350.0, 5322.0, 5483.0, 5511.0, 5715.0, 5582.0, 5289.0, 5269.0, 5691.0, 5588.0, 5546.0, 5426.0, 5408.0, 5672.0, 5256.0, 5502.0, 5347.0, 5340.0, 5475.0, 5654.0, 5714.0, 5657.0, 5394.0, 5467.0, 5479.0, 5413.0, 5568.0, 5258.0, 5448.0, 5668.0, 5514.0, 5663.0, 5478.0, 5704.0, 5683.0, 5390.0, 5381.0, 5608.0, 5637.0, 5310.0, 5573.0, 5311.0, 5320.0, 5435.0, 5624.0, 5558.0, 5601.0, 5592.0, 5682.0, 5429.0, 5613.0, 5650.0, 5626.0, 5521.0,

						5525.0, 5547.0, 5425.0, 5523.0, 5474.0, 5334.0, 5561.0, 5391.0, 5264.0, 5274.0, 5428.0, 5275.0, 5398.0, 5492.0, 5554.0, 5676.0, 5659.0, 5614.0, 5301.0, 5306.0, 5687.0, 5655.0, 5366.0, 5603.0, 5286.0, 5357.0, 5450.0, 5574.0, 5600.0, 5380.0, 5328.0, 5702.0, 5385.0, 5263.0, 5300.0
7	5530	9	1	333	1	5467.0, 5541.0, 5580.0, 5267.0, 5712.0, 5491.0, 5664.0, 5486.0, 5332.0, 5437.0, 5606.0, 5620.0, 5705.0, 5556.0, 5364.0, 5546.0, 5455.0, 5353.0, 5634.0, 5512.0, 5309.0, 5713.0, 5385.0, 5684.0, 5654.0, 5264.0, 5652.0, 5382.0, 5690.0, 5257.0, 5328.0, 5653.0, 5401.0, 5484.0, 5666.0, 5431.0, 5344.0, 5584.0, 5412.0, 5483.0, 5577.0, 5434.0, 5563.0, 5588.0, 5703.0, 5387.0, 5468.0, 5608.0, 5670.0, 5369.0, 5573.0, 5522.0, 5352.0, 5587.0, 5359.0, 5348.0, 5531.0, 5614.0, 5598.0, 5542.0, 5452.0, 5286.0, 5409.0, 5570.0, 5640.0, 5699.0, 5590.0, 5568.0, 5488.0, 5526.0, 5544.0, 5322.0, 5671.0, 5534.0, 5565.0, 5274.0, 5552.0, 5284.0, 5299.0, 5414.0, 5688.0, 5330.0, 5668.0, 5324.0, 5530.0, 5722.0, 5400.0, 5536.0, 5403.0, 5553.0, 5279.0, 5460.0, 5707.0, 5507.0, 5355.0, 5456.0, 5422.0, 5380.0, 5600.0, 5415.0
8	5530	9	1	333	1	5455.0, 5635.0, 5449.0, 5339.0, 5605.0, 5433.0, 5306.0, 5304.0, 5307.0, 5384.0, 5593.0, 5310.0, 5415.0, 5578.0, 5500.0, 5295.0, 5364.0, 5285.0, 5718.0, 5361.0, 5543.0, 5383.0, 5321.0, 5678.0, 5592.0, 5539.0, 5696.0, 5435.0, 5571.0, 5717.0, 5707.0, 5668.0, 5528.0, 5525.0, 5332.0, 5365.0, 5645.0, 5278.0, 5675.0, 5386.0, 5719.0, 5662.0, 5367.0, 5314.0, 5347.0, 5499.0, 5392.0, 5514.0, 5688.0, 5569.0, 5615.0, 5279.0, 5288.0, 5722.0, 5710.0, 5714.0, 5534.0, 5462.0, 5401.0, 5521.0, 5533.0, 5720.0, 5547.0, 5577.0, 5407.0, 5519.0, 5663.0, 5434.0, 5664.0, 5621.0, 5649.0, 5620.0, 5459.0, 5503.0, 5511.0, 5282.0, 5300.0, 5582.0, 5653.0, 5566.0, 5508.0, 5349.0, 5626.0, 5651.0, 5390.0, 5441.0, 5319.0, 5359.0, 5562.0, 5458.0, 5600.0, 5312.0, 5479.0, 5515.0, 5588.0, 5447.0, 5482.0, 5596.0, 5546.0, 5701.0
9	5530	9	1	333	1	5495.0, 5623.0, 5524.0, 5492.0, 5525.0, 5312.0, 5425.0, 5334.0, 5282.0, 5294.0, 5491.0, 5342.0, 5502.0, 5412.0, 5411.0, 5277.0, 5519.0, 5552.0, 5377.0, 5432.0, 5293.0, 5602.0, 5511.0, 5676.0, 5522.0, 5610.0, 5669.0, 5517.0, 5581.0, 5324.0, 5499.0, 5659.0, 5333.0, 5263.0, 5716.0, 5529.0, 5322.0, 5326.0, 5711.0, 5372.0, 5470.0, 5533.0, 5532.0, 5451.0, 5663.0, 5549.0, 5587.0, 5392.0, 5510.0, 5634.0, 5546.0, 5291.0, 5709.0, 5609.0, 5649.0, 5387.0, 5404.0, 5560.0, 5720.0, 5358.0, 5433.0, 5438.0, 5548.0, 5679.0, 5635.0,

						5455.0, 5551.0, 5325.0, 5646.0, 5464.0, 5530.0, 5681.0, 5442.0, 5666.0, 5689.0, 5434.0, 5417.0, 5449.0, 5413.0, 5346.0, 5586.0, 5498.0, 5378.0, 5629.0, 5656.0, 5590.0, 5568.0, 5620.0, 5611.0, 5677.0, 5457.0, 5337.0, 5363.0, 5528.0, 5366.0, 5604.0, 5407.0, 5694.0, 5405.0, 5690.0
10	5530	9	1	333	1	5585.0, 5424.0, 5442.0, 5635.0, 5642.0, 5724.0, 5693.0, 5667.0, 5632.0, 5348.0, 5690.0, 5625.0, 5393.0, 5641.0, 5591.0, 5644.0, 5715.0, 5609.0, 5554.0, 5563.0, 5601.0, 5323.0, 5354.0, 5571.0, 5602.0, 5537.0, 5535.0, 5269.0, 5446.0, 5361.0, 5465.0, 5533.0, 5687.0, 5622.0, 5638.0, 5299.0, 5551.0, 5710.0, 5588.0, 5565.0, 5379.0, 5685.0, 5586.0, 5468.0, 5324.0, 5454.0, 5712.0, 5656.0, 5717.0, 5505.0, 5346.0, 5456.0, 5320.0, 5583.0, 5485.0, 5491.0, 5580.0, 5373.0, 5287.0, 5451.0, 5484.0, 5375.0, 5471.0, 5404.0, 5514.0, 5437.0, 5444.0, 5619.0, 5378.0, 5702.0, 5263.0, 5291.0, 5425.0, 5658.0, 5271.0, 5276.0, 5334.0, 5553.0, 5489.0, 5436.0, 5339.0, 5273.0, 5640.0, 5390.0, 5289.0, 5381.0, 5494.0, 5358.0, 5595.0, 5714.0, 5392.0, 5296.0, 5488.0, 5251.0, 5530.0, 5521.0, 5431.0, 5350.0, 5539.0, 5713.0
11	5530	9	1	333	1	5444.0, 5670.0, 5390.0, 5519.0, 5397.0, 5347.0, 5502.0, 5520.0, 5330.0, 5513.0, 5314.0, 5667.0, 5609.0, 5287.0, 5260.0, 5372.0, 5498.0, 5699.0, 5540.0, 5616.0, 5472.0, 5646.0, 5380.0, 5462.0, 5430.0, 5697.0, 5566.0, 5413.0, 5577.0, 5589.0, 5362.0, 5597.0, 5422.0, 5662.0, 5338.0, 5610.0, 5499.0, 5485.0, 5598.0, 5558.0, 5363.0, 5376.0, 5711.0, 5251.0, 5660.0, 5398.0, 5719.0, 5683.0, 5546.0, 5464.0, 5708.0, 5412.0, 5470.0, 5328.0, 5493.0, 5627.0, 5305.0, 5405.0, 5501.0, 5265.0, 5583.0, 5374.0, 5427.0, 5512.0, 5669.0, 5313.0, 5661.0, 5396.0, 5389.0, 5543.0, 5384.0, 5277.0, 5351.0, 5525.0, 5307.0, 5542.0, 5310.0, 5590.0, 5253.0, 5539.0, 5483.0, 5367.0, 5296.0, 5388.0, 5416.0, 5592.0, 5333.0, 5707.0, 5704.0, 5675.0, 5665.0, 5252.0, 5572.0, 5256.0, 5439.0, 5632.0, 5531.0, 5480.0, 5475.0, 5631.0
12	5530	9	1	333	1	5586.0, 5376.0, 5348.0, 5690.0, 5563.0, 5502.0, 5373.0, 5357.0, 5715.0, 5260.0, 5438.0, 5404.0, 5616.0, 5428.0, 5288.0, 5473.0, 5490.0, 5592.0, 5651.0, 5547.0, 5266.0, 5472.0, 5442.0, 5503.0, 5713.0, 5450.0, 5647.0, 5304.0, 5331.0, 5419.0, 5412.0, 5262.0, 5440.0, 5378.0, 5708.0, 5423.0, 5370.0, 5646.0, 5497.0, 5649.0, 5605.0, 5487.0, 5610.0, 5318.0, 5448.0, 5329.0, 5338.0, 5526.0, 5504.0, 5439.0, 5485.0, 5661.0, 5441.0, 5587.0, 5364.0, 5670.0, 5576.0, 5656.0, 5617.0, 5611.0, 5444.0, 5483.0, 5624.0, 5319.0, 5676.0

						5495.0, 5631.0, 5306.0, 5341.0, 5582.0, 5515.0, 5520.0, 5544.0, 5606.0, 5658.0, 5493.0, 5287.0, 5511.0, 5619.0, 5707.0, 5411.0, 5494.0, 5263.0, 5697.0, 5709.0, 5527.0, 5593.0, 5255.0, 5344.0, 5597.0, 5541.0, 5553.0, 5585.0, 5296.0, 5602.0, 5564.0, 5359.0, 5615.0, 5641.0, 5513.0
13	5530	9	1	333	1	5283.0, 5381.0, 5523.0, 5533.0, 5323.0, 5452.0, 5528.0, 5657.0, 5496.0, 5274.0, 5468.0, 5598.0, 5279.0, 5471.0, 5447.0, 5689.0, 5317.0, 5591.0, 5691.0, 5292.0, 5637.0, 5706.0, 5568.0, 5522.0, 5549.0, 5609.0, 5436.0, 5538.0, 5339.0, 5402.0, 5497.0, 5583.0, 5363.0, 5303.0, 5645.0, 5658.0, 5266.0, 5705.0, 5460.0, 5697.0, 5656.0, 5587.0, 5318.0, 5561.0, 5714.0, 5261.0, 5366.0, 5519.0, 5371.0, 5506.0, 5693.0, 5374.0, 5421.0, 5541.0, 5424.0, 5310.0, 5520.0, 5388.0, 5415.0, 5305.0, 5514.0, 5490.0, 5707.0, 5430.0, 5501.0, 5643.0, 5464.0, 5352.0, 5475.0, 5309.0, 5275.0, 5553.0, 5576.0, 5354.0, 5403.0, 5499.0, 5301.0, 5594.0, 5513.0, 5340.0, 5372.0, 5606.0, 5297.0, 5330.0, 5281.0, 5376.0, 5498.0, 5566.0, 5491.0, 5375.0, 5640.0, 5313.0, 5253.0, 5683.0, 5511.0, 5386.0, 5356.0, 5626.0, 5405.0, 5258.0
14	5530	9	1	333	1	5326.0, 5316.0, 5495.0, 5516.0, 5259.0, 5350.0, 5663.0, 5502.0, 5397.0, 5476.0, 5413.0, 5348.0, 5353.0, 5651.0, 5382.0, 5450.0, 5498.0, 5324.0, 5622.0, 5391.0, 5678.0, 5325.0, 5412.0, 5289.0, 5665.0, 5576.0, 5306.0, 5599.0, 5477.0, 5492.0, 5629.0, 5346.0, 5307.0, 5488.0, 5439.0, 5364.0, 5691.0, 5699.0, 5610.0, 5446.0, 5646.0, 5571.0, 5564.0, 5367.0, 5673.0, 5440.0, 5360.0, 5471.0, 5503.0, 5518.0, 5706.0, 5705.0, 5406.0, 5300.0, 5687.0, 5292.0, 5320.0, 5372.0, 5543.0, 5535.0, 5620.0, 5274.0, 5581.0, 5263.0, 5615.0, 5714.0, 5587.0, 5585.0, 5369.0, 5532.0, 5265.0, 5693.0, 5434.0, 5291.0, 5436.0, 5580.0, 5400.0, 5653.0, 5281.0, 5591.0, 5489.0, 5478.0, 5574.0, 5711.0, 5548.0, 5555.0, 5484.0, 5588.0, 5560.0, 5546.0, 5381.0, 5302.0, 5303.0, 5416.0, 5304.0, 5342.0, 5713.0, 5464.0, 5461.0, 5472.0
15	5530	9	1	333	1	5293.0, 5537.0, 5632.0, 5442.0, 5379.0, 5570.0, 5614.0, 5356.0, 5576.0, 5289.0, 5511.0, 5564.0, 5392.0, 5388.0, 5572.0, 5278.0, 5581.0, 5544.0, 5329.0, 5410.0, 5425.0, 5713.0, 5561.0, 5692.0, 5265.0, 5299.0, 5282.0, 5344.0, 5547.0, 5418.0, 5255.0, 5681.0, 5584.0, 5689.0, 5317.0, 5524.0, 5687.0, 5460.0, 5520.0, 5473.0, 5303.0, 5548.0, 5525.0, 5444.0, 5307.0, 5412.0, 5396.0, 5258.0, 5477.0, 5280.0, 5708.0, 5663.0, 5301.0, 5308.0, 5718.0, 5331.0, 5631.0, 5271.0, 5450.0, 5269.0, 5313.0, 5342.0, 5667.0, 5532.0, 5482.0

						5522.0, 5470.0, 5653.0, 5339.0, 5621.0, 5273.0, 5627.0, 5421.0, 5323.0, 5327.0, 5466.0, 5334.0, 5519.0, 5531.0, 5721.0, 5286.0, 5320.0, 5288.0, 5682.0, 5573.0, 5639.0, 5426.0, 5567.0, 5503.0, 5393.0, 5623.0, 5710.0, 5626.0, 5693.0, 5461.0, 5585.0, 5714.0, 5486.0, 5613.0, 5523.0
16	5530	9	1	333	1	5312.0, 5579.0, 5257.0, 5573.0, 5667.0, 5612.0, 5325.0, 5528.0, 5692.0, 5482.0, 5269.0, 5513.0, 5335.0, 5358.0, 5386.0, 5702.0, 5382.0, 5417.0, 5349.0, 5366.0, 5659.0, 5621.0, 5284.0, 5694.0, 5723.0, 5685.0, 5720.0, 5699.0, 5333.0, 5370.0, 5389.0, 5546.0, 5438.0, 5355.0, 5475.0, 5501.0, 5326.0, 5314.0, 5384.0, 5420.0, 5418.0, 5446.0, 5678.0, 5597.0, 5674.0, 5585.0, 5596.0, 5306.0, 5443.0, 5540.0, 5509.0, 5404.0, 5698.0, 5719.0, 5588.0, 5488.0, 5491.0, 5696.0, 5521.0, 5584.0, 5281.0, 5452.0, 5542.0, 5641.0, 5399.0, 5304.0, 5410.0, 5541.0, 5387.0, 5602.0, 5713.0, 5716.0, 5568.0, 5627.0, 5426.0, 5653.0, 5564.0, 5450.0, 5489.0, 5657.0, 5329.0, 5505.0, 5461.0, 5553.0, 5331.0, 5296.0, 5645.0, 5309.0, 5486.0, 5253.0, 5682.0, 5303.0, 5574.0, 5285.0, 5649.0, 5580.0, 5444.0, 5562.0, 5271.0, 5630.0
17	5530	9	1	333	1	5648.0, 5589.0, 5313.0, 5684.0, 5321.0, 5719.0, 5614.0, 5427.0, 5443.0, 5361.0, 5551.0, 5510.0, 5320.0, 5479.0, 5393.0, 5584.0, 5685.0, 5400.0, 5528.0, 5540.0, 5604.0, 5419.0, 5543.0, 5721.0, 5416.0, 5644.0, 5622.0, 5514.0, 5359.0, 5423.0, 5497.0, 5717.0, 5324.0, 5475.0, 5718.0, 5575.0, 5401.0, 5355.0, 5518.0, 5627.0, 5338.0, 5455.0, 5483.0, 5309.0, 5319.0, 5705.0, 5282.0, 5392.0, 5389.0, 5662.0, 5649.0, 5356.0, 5512.0, 5555.0, 5364.0, 5266.0, 5428.0, 5370.0, 5524.0, 5688.0, 5365.0, 5616.0, 5335.0, 5424.0, 5520.0, 5331.0, 5333.0, 5431.0, 5635.0, 5345.0, 5360.0, 5710.0, 5407.0, 5621.0, 5585.0, 5494.0, 5527.0, 5268.0, 5632.0, 5571.0, 5429.0, 5558.0, 5681.0, 5597.0, 5600.0, 5703.0, 5307.0, 5656.0, 5434.0, 5397.0, 5682.0, 5257.0, 5653.0, 5420.0, 5337.0, 5536.0, 5700.0, 5353.0, 5634.0, 5519.0
18	5530	9	1	333	1	5659.0, 5660.0, 5279.0, 5396.0, 5514.0, 5636.0, 5345.0, 5630.0, 5458.0, 5333.0, 5335.0, 5532.0, 5700.0, 5447.0, 5417.0, 5474.0, 5564.0, 5576.0, 5283.0, 5561.0, 5560.0, 5648.0, 5688.0, 5689.0, 5620.0, 5714.0, 5672.0, 5515.0, 5367.0, 5706.0, 5570.0, 5300.0, 5413.0, 5358.0, 5264.0, 5470.0, 5589.0, 5476.0, 5619.0, 5663.0, 5502.0, 5590.0, 5697.0, 5621.0, 5304.0, 5508.0, 5500.0, 5678.0, 5543.0, 5256.0, 5325.0, 5539.0, 5253.0, 5286.0, 5312.0, 5565.0, 5428.0, 5485.0, 5642.0, 5628.0, 5647.0, 5643.0, 5497.0, 5332.0, 5603.0

						5709.0, 5309.0, 5296.0, 5674.0, 5473.0, 5280.0, 5511.0, 5526.0, 5551.0, 5546.0, 5692.0, 5517.0, 5650.0, 5618.0, 5442.0, 5516.0, 5389.0, 5408.0, 5432.0, 5512.0, 5406.0, 5600.0, 5608.0, 5690.0, 5540.0, 5383.0, 5622.0, 5317.0, 5557.0, 5319.0, 5420.0, 5681.0, 5601.0, 5558.0, 5646.0
19	5530	9	1	333	1	5280.0, 5562.0, 5501.0, 5320.0, 5723.0, 5363.0, 5680.0, 5689.0, 5477.0, 5384.0, 5328.0, 5580.0, 5272.0, 5354.0, 5403.0, 5677.0, 5441.0, 5511.0, 5346.0, 5628.0, 5722.0, 5672.0, 5472.0, 5340.0, 5260.0, 5563.0, 5440.0, 5326.0, 5502.0, 5535.0, 5262.0, 5261.0, 5622.0, 5632.0, 5371.0, 5548.0, 5715.0, 5586.0, 5288.0, 5394.0, 5529.0, 5318.0, 5634.0, 5303.0, 5587.0, 5438.0, 5521.0, 5321.0, 5579.0, 5422.0, 5335.0, 5416.0, 5390.0, 5660.0, 5618.0, 5559.0, 5555.0, 5276.0, 5682.0, 5708.0, 5648.0, 5414.0, 5455.0, 5670.0, 5283.0, 5271.0, 5439.0, 5629.0, 5356.0, 5289.0, 5517.0, 5392.0, 5601.0, 5298.0, 5417.0, 5446.0, 5351.0, 5437.0, 5639.0, 5443.0, 5258.0, 5494.0, 5495.0, 5584.0, 5698.0, 5659.0, 5295.0, 5425.0, 5605.0, 5469.0, 5578.0, 5391.0, 5505.0, 5255.0, 5525.0, 5515.0, 5256.0, 5551.0, 5500.0, 5489.0
20	5530	9	1	333	1	5722.0, 5454.0, 5497.0, 5254.0, 5401.0, 5594.0, 5481.0, 5415.0, 5593.0, 5577.0, 5322.0, 5703.0, 5547.0, 5472.0, 5350.0, 5282.0, 5304.0, 5654.0, 5571.0, 5606.0, 5409.0, 5402.0, 5629.0, 5391.0, 5544.0, 5647.0, 5396.0, 5511.0, 5711.0, 5269.0, 5622.0, 5460.0, 5653.0, 5385.0, 5570.0, 5272.0, 5607.0, 5413.0, 5447.0, 5556.0, 5720.0, 5565.0, 5669.0, 5265.0, 5578.0, 5427.0, 5533.0, 5495.0, 5400.0, 5506.0, 5259.0, 5387.0, 5553.0, 5360.0, 5617.0, 5380.0, 5471.0, 5685.0, 5378.0, 5580.0, 5640.0, 5457.0, 5316.0, 5692.0, 5505.0, 5329.0, 5638.0, 5682.0, 5632.0, 5321.0, 5479.0, 5482.0, 5516.0, 5616.0, 5588.0, 5630.0, 5691.0, 5292.0, 5438.0, 5308.0, 5425.0, 5538.0, 5491.0, 5257.0, 5601.0, 5253.0, 5470.0, 5320.0, 5494.0, 5355.0, 5541.0, 5517.0, 5309.0, 5676.0, 5690.0, 5431.0, 5459.0, 5347.0, 5631.0, 5256.0
21	5530	9	1	333	1	5541.0, 5655.0, 5635.0, 5632.0, 5545.0, 5661.0, 5708.0, 5436.0, 5709.0, 5440.0, 5320.0, 5303.0, 5420.0, 5576.0, 5447.0, 5363.0, 5410.0, 5692.0, 5291.0, 5602.0, 5722.0, 5324.0, 5259.0, 5254.0, 5301.0, 5647.0, 5497.0, 5645.0, 5511.0, 5609.0, 5502.0, 5413.0, 5608.0, 5598.0, 5457.0, 5662.0, 5393.0, 5358.0, 5427.0, 5357.0, 5581.0, 5715.0, 5276.0, 5586.0, 5660.0, 5416.0, 5654.0, 5280.0, 5470.0, 5404.0, 5297.0, 5255.0, 5496.0, 5270.0, 5639.0, 5543.0, 5630.0, 5390.0, 5344.0, 5705.0, 5621.0, 5449.0, 5678.0, 5398.0, 5531.0,

						5347.0, 5494.0, 5418.0, 5315.0, 5532.0, 5434.0, 5658.0, 5466.0, 5695.0, 5617.0, 5646.0, 5471.0, 5443.0, 5350.0, 5399.0, 5671.0, 5570.0, 5713.0, 5426.0, 5672.0, 5329.0, 5271.0, 5389.0, 5518.0, 5257.0, 5706.0, 5675.0, 5627.0, 5365.0, 5684.0, 5643.0, 5546.0, 5614.0, 5319.0, 5326.0
22	5530	9	1	333	1	5492.0, 5723.0, 5342.0, 5450.0, 5712.0, 5580.0, 5323.0, 5252.0, 5363.0, 5441.0, 5607.0, 5419.0, 5266.0, 5355.0, 5341.0, 5536.0, 5636.0, 5480.0, 5289.0, 5335.0, 5614.0, 5631.0, 5424.0, 5291.0, 5348.0, 5375.0, 5692.0, 5296.0, 5412.0, 5600.0, 5538.0, 5451.0, 5293.0, 5464.0, 5379.0, 5420.0, 5258.0, 5267.0, 5705.0, 5392.0, 5331.0, 5513.0, 5483.0, 5256.0, 5619.0, 5322.0, 5393.0, 5466.0, 5302.0, 5516.0, 5602.0, 5664.0, 5663.0, 5407.0, 5681.0, 5649.0, 5442.0, 5519.0, 5494.0, 5700.0, 5469.0, 5306.0, 5455.0, 5328.0, 5613.0, 5638.0, 5476.0, 5251.0, 5307.0, 5634.0, 5679.0, 5391.0, 5534.0, 5556.0, 5623.0, 5687.0, 5591.0, 5622.0, 5430.0, 5694.0, 5380.0, 5657.0, 5347.0, 5628.0, 5437.0, 5665.0, 5370.0, 5329.0, 5448.0, 5526.0, 5645.0, 5261.0, 5350.0, 5386.0, 5269.0, 5387.0, 5703.0, 5595.0, 5716.0, 5684.0
23	5530	9	1	333	1	5304.0, 5667.0, 5256.0, 5499.0, 5619.0, 5664.0, 5259.0, 5418.0, 5522.0, 5419.0, 5357.0, 5635.0, 5490.0, 5506.0, 5465.0, 5489.0, 5661.0, 5274.0, 5300.0, 5584.0, 5340.0, 5410.0, 5470.0, 5607.0, 5450.0, 5408.0, 5335.0, 5710.0, 5263.0, 5655.0, 5548.0, 5674.0, 5519.0, 5295.0, 5563.0, 5271.0, 5343.0, 5290.0, 5708.0, 5683.0, 5688.0, 5701.0, 5673.0, 5503.0, 5680.0, 5624.0, 5356.0, 5474.0, 5432.0, 5440.0, 5267.0, 5666.0, 5428.0, 5415.0, 5299.0, 5297.0, 5550.0, 5298.0, 5377.0, 5442.0, 5312.0, 5438.0, 5530.0, 5526.0, 5539.0, 5630.0, 5482.0, 5554.0, 5714.0, 5258.0, 5500.0, 5382.0, 5686.0, 5321.0, 5662.0, 5472.0, 5527.0, 5393.0, 5521.0, 5553.0, 5352.0, 5656.0, 5351.0, 5705.0, 5555.0, 5473.0, 5582.0, 5456.0, 5598.0, 5371.0, 5400.0, 5712.0, 5510.0, 5639.0, 5659.0, 5326.0, 5451.0, 5525.0, 5275.0, 5375.0
24	5530	9	1	333	1	5369.0, 5649.0, 5332.0, 5566.0, 5646.0, 5657.0, 5322.0, 5524.0, 5639.0, 5698.0, 5443.0, 5401.0, 5571.0, 5709.0, 5387.0, 5434.0, 5419.0, 5481.0, 5439.0, 5471.0, 5335.0, 5319.0, 5613.0, 5486.0, 5373.0, 5254.0, 5321.0, 5689.0, 5590.0, 5324.0, 5509.0, 5697.0, 5465.0, 5362.0, 5484.0, 5565.0, 5329.0, 5315.0, 5497.0, 5672.0, 5470.0, 5520.0, 5420.0, 5632.0, 5293.0, 5381.0, 5382.0, 5615.0, 5349.0, 5323.0, 5477.0, 5550.0, 5347.0, 5490.0, 5622.0, 5412.0, 5272.0, 5495.0, 5260.0, 5521.0, 5584.0, 5363.0, 5480.0, 5636.0, 5492.0,

						5718.0, 5641.0, 5547.0, 5673.0, 5567.0, 5553.0, 5265.0, 5511.0, 5587.0, 5700.0, 5544.0, 5359.0, 5365.0, 5595.0, 5603.0, 5546.0, 5712.0, 5713.0, 5372.0, 5340.0, 5273.0, 5527.0, 5692.0, 5652.0, 5269.0, 5664.0, 5665.0, 5262.0, 5685.0, 5683.0, 5536.0, 5640.0, 5543.0, 5710.0, 5441.0
25	5530	9	1	333	1	5607.0, 5260.0, 5474.0, 5290.0, 5671.0, 5485.0, 5656.0, 5534.0, 5661.0, 5660.0, 5577.0, 5460.0, 5411.0, 5707.0, 5717.0, 5447.0, 5622.0, 5499.0, 5439.0, 5330.0, 5491.0, 5591.0, 5297.0, 5431.0, 5385.0, 5673.0, 5716.0, 5702.0, 5590.0, 5665.0, 5304.0, 5395.0, 5305.0, 5477.0, 5335.0, 5691.0, 5642.0, 5715.0, 5349.0, 5486.0, 5544.0, 5250.0, 5264.0, 5432.0, 5267.0, 5359.0, 5482.0, 5699.0, 5399.0, 5421.0, 5376.0, 5433.0, 5262.0, 5463.0, 5258.0, 5628.0, 5487.0, 5677.0, 5564.0, 5641.0, 5514.0, 5592.0, 5679.0, 5276.0, 5446.0, 5279.0, 5530.0, 5595.0, 5462.0, 5550.0, 5582.0, 5493.0, 5670.0, 5498.0, 5443.0, 5289.0, 5597.0, 5301.0, 5476.0, 5377.0, 5648.0, 5449.0, 5651.0, 5658.0, 5320.0, 5652.0, 5720.0, 5678.0, 5415.0, 5434.0, 5529.0, 5367.0, 5494.0, 5693.0, 5555.0, 5519.0, 5275.0, 5323.0, 5535.0, 5270.0
26	5530	9	1	333	1	5460.0, 5304.0, 5682.0, 5559.0, 5473.0, 5661.0, 5644.0, 5403.0, 5610.0, 5385.0, 5558.0, 5411.0, 5483.0, 5691.0, 5384.0, 5628.0, 5401.0, 5539.0, 5701.0, 5702.0, 5631.0, 5626.0, 5491.0, 5540.0, 5659.0, 5354.0, 5580.0, 5492.0, 5324.0, 5328.0, 5289.0, 5723.0, 5502.0, 5453.0, 5436.0, 5519.0, 5445.0, 5710.0, 5531.0, 5479.0, 5573.0, 5665.0, 5393.0, 5520.0, 5311.0, 5477.0, 5550.0, 5305.0, 5599.0, 5272.0, 5642.0, 5586.0, 5718.0, 5476.0, 5544.0, 5714.0, 5462.0, 5670.0, 5381.0, 5276.0, 5352.0, 5270.0, 5373.0, 5601.0, 5553.0, 5594.0, 5613.0, 5681.0, 5719.0, 5257.0, 5467.0, 5625.0, 5612.0, 5521.0, 5433.0, 5577.0, 5339.0, 5387.0, 5623.0, 5282.0, 5570.0, 5499.0, 5496.0, 5355.0, 5362.0, 5386.0, 5370.0, 5313.0, 5596.0, 5464.0, 5413.0, 5687.0, 5441.0, 5656.0, 5605.0, 5652.0, 5513.0, 5482.0, 5669.0, 5432.0
27	5530	9	1	333	1	5576.0, 5274.0, 5697.0, 5671.0, 5516.0, 5385.0, 5472.0, 5362.0, 5400.0, 5370.0, 5643.0, 5306.0, 5706.0, 5285.0, 5657.0, 5541.0, 5558.0, 5600.0, 5352.0, 5514.0, 5373.0, 5369.0, 5428.0, 5577.0, 5609.0, 5585.0, 5567.0, 5631.0, 5282.0, 5668.0, 5355.0, 5489.0, 5272.0, 5473.0, 5535.0, 5350.0, 5318.0, 5721.0, 5669.0, 5679.0, 5589.0, 5479.0, 5524.0, 5444.0, 5379.0, 5255.0, 5465.0, 5262.0, 5598.0, 5523.0, 5529.0, 5544.0, 5485.0, 5394.0, 5265.0, 5696.0, 5581.0, 5636.0, 5493.0, 5586.0, 5680.0, 5411.0, 5497.0, 5661.0, 5406.0

						5492.0, 5511.0, 5570.0, 5712.0, 5642.0, 5287.0, 5565.0, 5297.0, 5604.0, 5383.0, 5414.0, 5646.0, 5251.0, 5438.0, 5477.0, 5404.0, 5422.0, 5617.0, 5359.0, 5363.0, 5259.0, 5351.0, 5434.0, 5575.0, 5655.0, 5319.0, 5375.0, 5459.0, 5615.0, 5446.0, 5607.0, 5722.0, 5374.0, 5703.0, 5321.0
28	5530	9	1	333	1	5703.0, 5632.0, 5653.0, 5559.0, 5679.0, 5363.0, 5347.0, 5479.0, 5596.0, 5604.0, 5620.0, 5701.0, 5415.0, 5602.0, 5538.0, 5429.0, 5391.0, 5496.0, 5542.0, 5720.0, 5594.0, 5691.0, 5667.0, 5344.0, 5670.0, 5365.0, 5434.0, 5387.0, 5714.0, 5567.0, 5499.0, 5320.0, 5568.0, 5353.0, 5478.0, 5603.0, 5431.0, 5506.0, 5523.0, 5298.0, 5631.0, 5702.0, 5665.0, 5294.0, 5406.0, 5686.0, 5546.0, 5335.0, 5498.0, 5520.0, 5316.0, 5692.0, 5444.0, 5587.0, 5308.0, 5255.0, 5710.0, 5485.0, 5370.0, 5261.0, 5398.0, 5601.0, 5583.0, 5329.0, 5324.0, 5621.0, 5388.0, 5273.0, 5700.0, 5615.0, 5698.0, 5647.0, 5592.0, 5590.0, 5535.0, 5521.0, 5271.0, 5578.0, 5566.0, 5524.0, 5675.0, 5505.0, 5312.0, 5260.0, 5419.0, 5519.0, 5390.0, 5608.0, 5427.0, 5439.0, 5642.0, 5633.0, 5510.0, 5648.0, 5661.0, 5417.0, 5490.0, 5396.0, 5304.0, 5460.0
29	5530	9	1	333	1	5418.0, 5670.0, 5402.0, 5683.0, 5258.0, 5311.0, 5686.0, 5568.0, 5357.0, 5551.0, 5696.0, 5682.0, 5513.0, 5684.0, 5448.0, 5581.0, 5702.0, 5653.0, 5269.0, 5717.0, 5570.0, 5599.0, 5370.0, 5553.0, 5691.0, 5643.0, 5421.0, 5685.0, 5265.0, 5470.0, 5437.0, 5404.0, 5692.0, 5322.0, 5667.0, 5531.0, 5348.0, 5492.0, 5468.0, 5718.0, 5503.0, 5296.0, 5597.0, 5340.0, 5292.0, 5548.0, 5283.0, 5627.0, 5700.0, 5419.0, 5392.0, 5367.0, 5483.0, 5534.0, 5462.0, 5680.0, 5661.0, 5320.0, 5417.0, 5652.0, 5641.0, 5533.0, 5595.0, 5488.0, 5304.0, 5430.0, 5291.0, 5490.0, 5466.0, 5458.0, 5674.0, 5487.0, 5545.0, 5681.0, 5604.0, 5698.0, 5672.0, 5423.0, 5295.0, 5520.0, 5376.0, 5373.0, 5455.0, 5266.0, 5268.0, 5642.0, 5354.0, 5587.0, 5556.0, 5465.0, 5405.0, 5260.0, 5694.0, 5626.0, 5289.0, 5559.0, 5571.0, 5349.0, 5612.0, 5716.0
30	5530	9	1	333	1	5550.0, 5326.0, 5553.0, 5320.0, 5400.0, 5300.0, 5372.0, 5603.0, 5366.0, 5670.0, 5534.0, 5565.0, 5362.0, 5719.0, 5651.0, 5459.0, 5363.0, 5645.0, 5314.0, 5499.0, 5508.0, 5703.0, 5380.0, 5426.0, 5595.0, 5558.0, 5262.0, 5699.0, 5397.0, 5403.0, 5277.0, 5371.0, 5472.0, 5334.0, 5584.0, 5573.0, 5254.0, 5597.0, 5602.0, 5365.0, 5464.0, 5593.0, 5282.0, 5580.0, 5536.0, 5289.0, 5606.0, 5687.0, 5502.0, 5519.0, 5539.0, 5382.0, 5683.0, 5532.0, 5336.0, 5614.0, 5359.0, 5465.0, 5716.0, 5395.0, 5393.0, 5405.0, 5401.0, 5639.0, 5517.0

						5317.0, 5445.0, 5689.0, 5552.0, 5567.0, 5538.0, 5562.0, 5402.0, 5337.0, 5253.0, 5498.0, 5619.0, 5488.0, 5632.0, 5292.0, 5438.0, 5328.0, 5453.0, 5281.0, 5514.0, 5496.0, 5541.0, 5675.0, 5309.0, 5411.0, 5685.0, 5285.0, 5506.0, 5594.0, 5381.0, 5563.0, 5256.0, 5529.0, 5684.0, 5260.0
--	--	--	--	--	--	--

BRIDGE AND/OR MESH MODE

Test Standard:

Networks Access Points with Bridge and/or MESH modes of operation are permitted to operate in the DFS bands but must employ a DFS function. The functionality of the Bridge mode as specified in §15.403(a) must be validated in the DFS test report. Devices operating as relays where they act as master and client must also employ DFS function for the master. The method used to validate the functionality must be documented and validation data must be documented. Bridge mode can be validated by performing a test statistical performance check (Section 7.8.4) on any one of the radar types. This is an abbreviated test to verify DFS functionality. MESH mode operational methodology must be submitted in the application for certification for evaluation by the FCC.

Test Result:

Compliance, please refer the the below data.

5500MHz**Radar Type 2 Statistical Performance**

Trial #	Fc (MHz)	Pulse/Burst	Pulse Width (μS)	PRI (μs)	Detection (1:yes; 0:no)
1	5500	29	3.6	202	1
2	5500	25	4.4	172	0
3	5500	29	2.2	157	1
4	5500	27	1	150	1
5	5500	29	2.8	177	1
6	5500	25	4.9	186	1
7	5500	28	2.1	186	1
8	5500	27	4.8	208	1
9	5500	24	1.8	220	1
10	5500	23	3.2	176	1
11	5500	29	1.3	215	1
12	5500	29	2	160	1
13	5500	24	2.3	154	1
14	5500	28	4.2	155	1
15	5500	29	3.4	224	1
16	5500	26	3	204	1
17	5500	27	2.7	171	1
18	5500	27	2	180	1
19	5500	27	4.5	166	1
20	5500	29	4	200	1
21	5500	24	3.7	228	1
22	5500	28	4.6	223	1
23	5500	24	4.7	202	1
24	5500	24	3.3	165	1
25	5500	26	1.4	208	1
26	5500	26	4.3	186	1
27	5500	24	2.9	179	1
28	5500	29	3.8	210	1
29	5500	23	2	177	1
30	5500	27	4.3	195	1
Detection Percentage: 96.7 % (>60%)					

Directions

1. The information marked # is provided by the applicant, the laboratory is not responsible for its authenticity and this information can affect the validity of the result in the test report.
2. Unless otherwise stated the results shown in this test report refer only to the sample(s) tested.
3. Otherwise required by the applicant or Product Regulations, Decision Rule in this report did not consider the uncertainty.
4. The extended uncertainty given in this report is obtained by combining the standard uncertainty times the coverage factor K with the 95% confidence interval.
5. This report cannot be reproduced except in full, without prior written approval of the Company.
6. This report is valid only with a valid digital signature. The digital signature may be available only under the Adobe software above version 7.0.
7. This report may contain data that are not covered by the accreditation scope and shall be marked with an asterisk “★” .
8. This report must not be used by the customer to claim product certification, approval, or endorsement by A2LA, or any agency of the U.S. Government.

******* END OF REPORT *******