

# GWN7624 ANT2 Antenna Specification

## 设计规格 specifications

频率范围 Frequency (MHz)	2.4G:2400~2500	5G: 5150~5850
电压驻波比 VSWR	$\leq 2.0: 1$	
增益 Gain (dBi)	2.4G: 2.5	5G: 4.5
效率 Efficiency (%)	$\geq 60$	$\geq 65$
天线类型 Type	Dipole Antenna	
辐射方向 Radiation Properties	全向 Omni-directional	
最大输入功率 Max Input Power(Watts)	2	
阻抗 Impedance (Ohms)	50	
外形尺寸 Dimensions (mm)	L36.0*W9.2*H0.6mm	
射频同轴电缆 Cable	RF1.13mm mini coax	
射频连接器 Connector	ECT 818000089	
材质 Material	PCB_FR4	
工作温度 Operation Temperature	-40°C to 85°C	
储存温度 Storage Temperature	-40°C to 85°C	
相对湿度 Relative Humidity	40% to 95%	
环保认证 ROHS Compliant	通过 Yes	

## 辐射方向图 Radiation Pattern

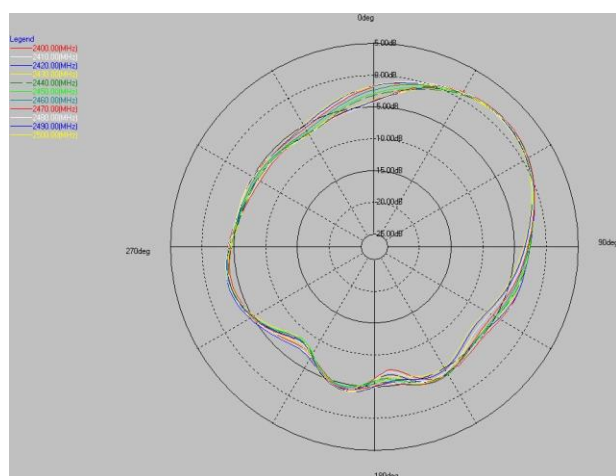

2.4G phi=0deg

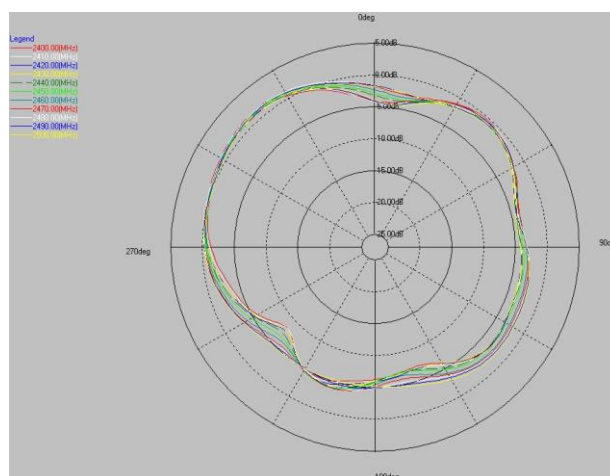

2.4G phi=90deg

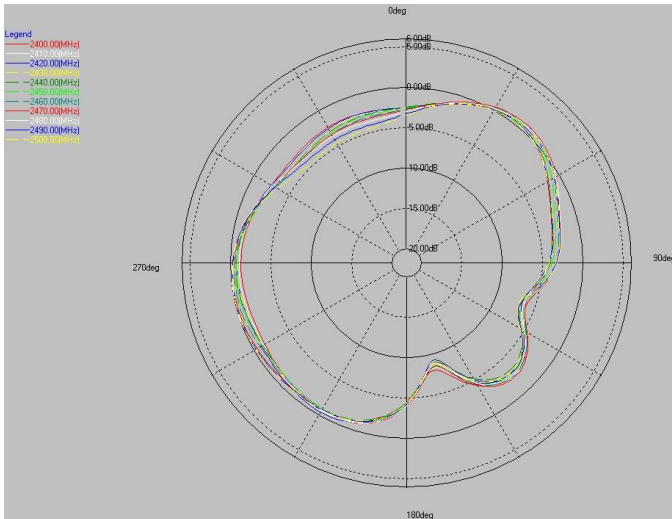

2.4G theta=90deg

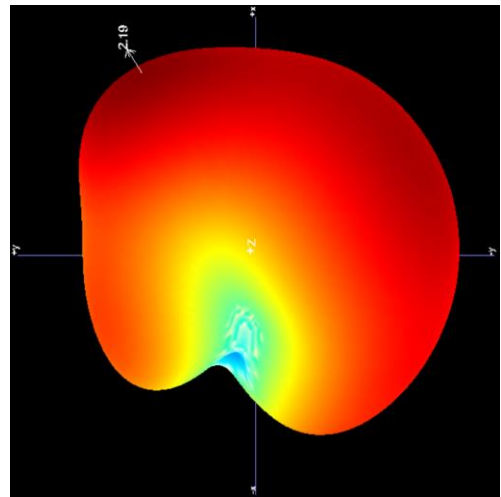

2.4G 3D

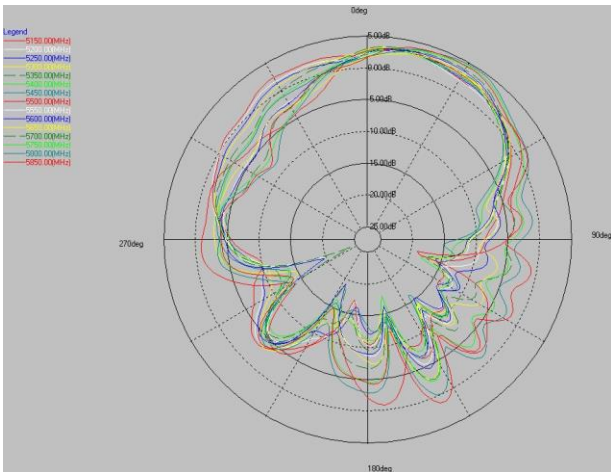

5G phi=0deg

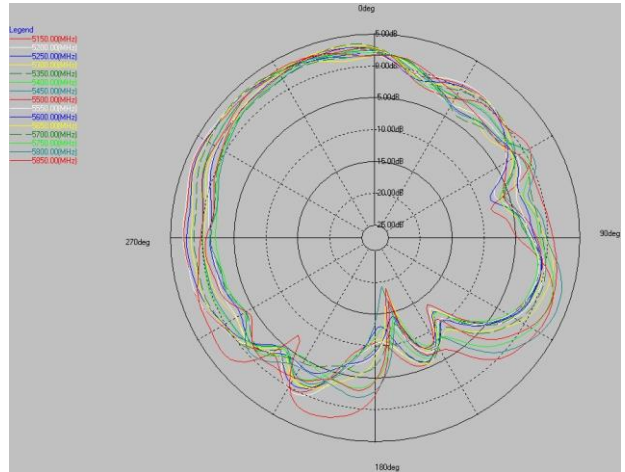

5G phi=90deg

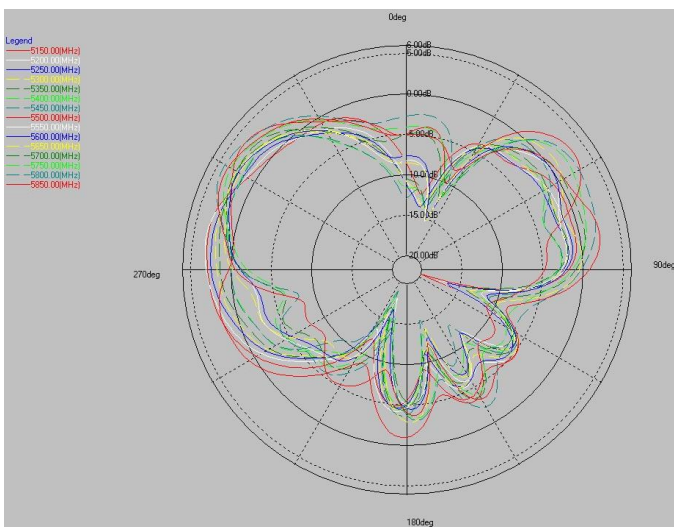

5G theta=90deg

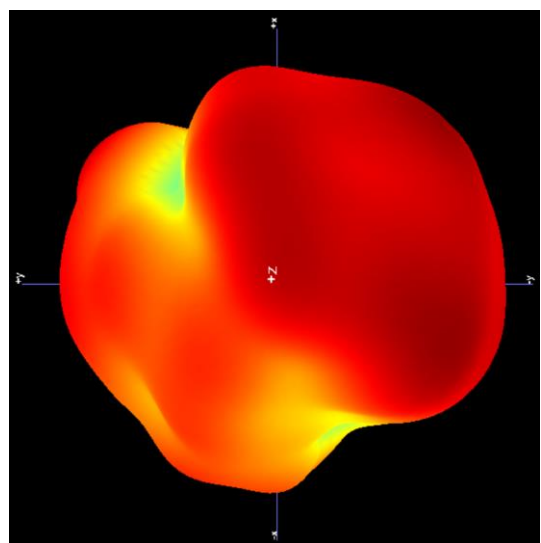

5G 3D

总成图 Mechanical Drawing

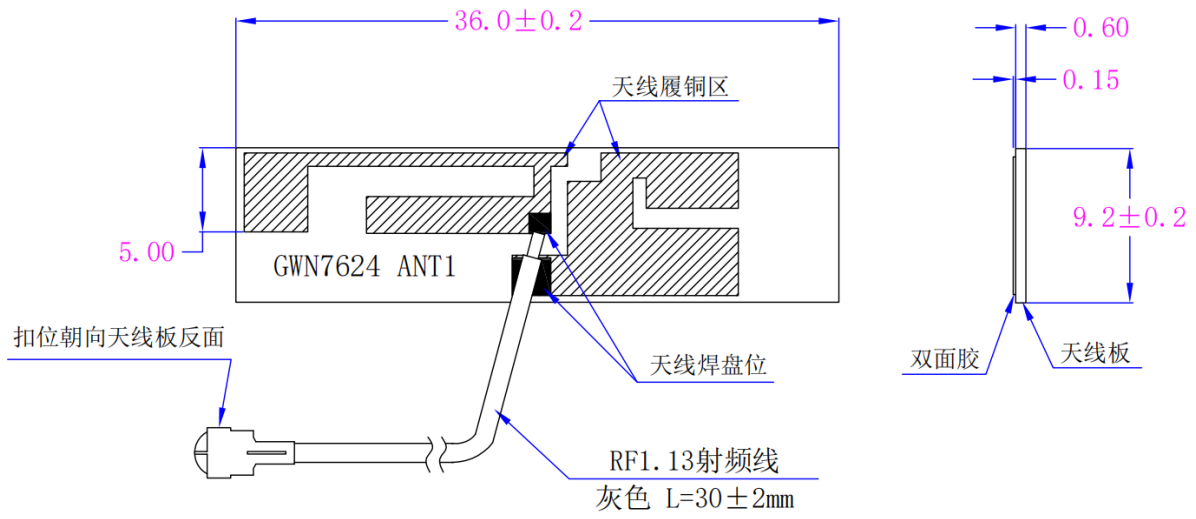

▲规格书到此结束 END OF THE SPECIFICATION.