



FCC PART 15.407
RSS-247, ISSUE 2, FEBRUARY 2017
DYNAMIC FREQUENCY SELECTION
TEST REPORT

For

Grandstream Networks, Inc.

126 Brookline Ave., 3rd Floor Boston, MA 02215, USA

FCC ID: YZZGWN7605LR
IC:11964A-GWN7605LR

Report Type: Original Report	Product Type: Outdoor Long-Range Wi-Fi Access Point
Report Number:	RSZ200312010-00
Report Date:	2020-04-13
Reviewed By:	Jerry Zhang EMC Manager
Test Laboratory:	Bay Area Compliance Laboratories Corp. (Dongguan) No.69 Pulongcun, Puxinhu Industry Area, Tangxia, Dongguan, Guangdong, China Tel: +86-769-86858888 Fax: +86-769-86858891 www.baclcorp.com.cn

TABLE OF CONTENTS

GENERAL INFORMATION.....	3
PRODUCT DESCRIPTION FOR EQUIPMENT UNDER TEST (EUT)	3
OBJECTIVE	3
TEST METHODOLOGY	3
TEST FACILITY	3
DECLARATIONS.....	3
SYSTEM TEST CONFIGURATION.....	5
DESCRIPTION OF TEST CONFIGURATION	5
EUT EXERCISE SOFTWARE	5
EQUIPMENT MODIFICATIONS	5
SUPPORT EQUIPMENT LIST AND DETAILS	5
EXTERNAL CABLE.....	5
SUMMARY OF TEST RESULTS	6
APPLICABLE STANDARDS.....	7
DFS REQUIREMENT	7
DFS MEASUREMENT SYSTEM.....	11
SYSTEM BLOCK DIAGRAM.....	11
CONDUCTED METHOD	12
RADIATED METHOD.....	13
TEST PROCEDURE	13
TEST RESULTS.....	14
DESCRIPTION OF EUT	14
TEST EQUIPMENT LIST AND DETAILS.....	14
RADAR WAVEFORM CALIBRATION	15
TEST ENVIRONMENTAL CONDITIONS	15
CHANNEL AVAILABILITY CHECK TIME (CAC)	21
TEST PROCEDURE	21
CHANNEL MOVE TIME AND CHANNEL CLOSING TRANSMISSION TIME	24
TEST PROCEDURE	24
TEST RESULTS	24
NON-OCCUPANCY PERIOD.....	27
TEST PROCEDURE	27
TEST RESULT	27
DETECTION BANDWIDTH.....	28
TEST PROCEDURE	28
TEST RESULT	29
STATISTICAL PERFORMANCE CHECK	33
BRIDGE AND/OR MESH MODE.....	127

GENERAL INFORMATION

Product Description for Equipment under Test (EUT)

Product	Outdoor Long-Range Wi-Fi Access Point
EUT Model:	GWN7605LR
Frequency Range	5150-5250 MHz; 5250-5350 MHz; 5470-5725 MHz, 5725-5850 MHz
Modulation Technique	OFDM
Rated Input Voltage:	DC 48V from PoE
Serial Number:	RSZ200312010
EUT Received Date:	2020.4.2
EUT Received Status:	Good

Objective

This report is prepared on behalf of *Grandstream Networks, Inc.* in accordance with Part 2-Subpart J, Part 15-Subparts E of the Federal Communications Commission's rules, and RSS-247, Issue 2, February 2017 of the Innovation, Science and Economic Development Canada.

The objective is to determine compliance with Dynamic Frequency Selection (DFS) of the FCC Part 15, Subpart E, section 15.407 and and RSS-247, Issue 2, February 2017 of the Innovation, Science and Economic Development Canada.

Test Methodology

FCC KDB 905462 D02 UNII DFS Compliance Procedures New Rules v02.

Test Facility

The Test site used by Bay Area Compliance Laboratories Corp. (Dongguan) to collect test data is located on the No.69 Pulongcun, Puxinhu Industry Area, Tangxia, Dongguan, Guangdong, China.

The lab has been recognized as the FCC accredited lab under the KDB 974614 D01 and is listed in the FCC Public Access Link (PAL) database, FCC Registration No. : 897218, the FCC Designation No. : CN1220.

The lab has been recognized by Innovation, Science and Economic Development Canada to test to Canadian radio equipment requirements, the CAB identifier: CN0022.

Declarations

BACL is not responsible for the authenticity of any test data provided by the applicant. Data included from the applicant that may affect test results are marked with a triangle symbol "Δ". Customer model name, addresses, names, trademarks etc. are not considered data.

Unless otherwise stated the results shown in this test report refer only to the sample(s) tested.

Otherwise required by the applicant or Product Regulations, Decision Rule in this report did not consider the uncertainty.

The extended uncertainty given in this report is obtained by combining the standard uncertainty times the coverage factor K with the 95% confidence interval.

This report cannot be reproduced except in full, without prior written approval of the Company.

This report is valid only with a valid digital signature. The digital signature may be available only under the e software above version 7.0.

This report may contain data that are not covered by the accreditation scope and shall be marked with an asterisk “★”.

SYSTEM TEST CONFIGURATION

Description of Test Configuration

The EUT was configured for testing in an engineering mode which was provided by the manufacturer.

EUT Exercise Software

The test was performed under: 'IPOP.exe', which was provided by the manufacturer.

Equipment Modifications

N/A

Support Equipment List and Details

Manufacturer	Description	Model	Serial Number
Dell	Laptop	E6410	00426-OEM-8992662-00497
Dell	Laptop	PP11L	QDS-BRCM133

External Cable

Cable Description	Shielding Type	Ferrite Core	Length (m)	From Port	To
RJ45	NO	NO	10	Laptop	EUT
RJ45	NO	NO	2	Laptop	EUT

SUMMARY OF TEST RESULTS

The following result table represents the list of measurements required under the CFR §47 Part 15.407(h) and RSS-247, Issue 2, February 2017, KDB: 905462 D02 UNII DFS Compliance Procedures New Rules v02

Items	Description of Test	Result
Detection Bandwidth	UNII Detection Bandwidth	Compliance
Performance Requirements Check	Initial Channel Availability Check Time (CAC)	Compliance
	Radar Burst at the Beginning of the CAC	Compliance
	Radar Burst at the End of the CAC	Compliance
In-Service Monitoring	Channel Move Time	Compliance
	Channel Closing Transmission Time	Compliance
	Non-Occupancy Period	Compliance
Radar Detection	Statistical Performance Check	Compliance

APPLICABLE STANDARDS

DFS Requirement

CFR §47 Part 15.407(h)& RSS-247, Issue 2, February 2017

FCC KDB 905462 D02 UNII DFS Compliance Procedures New Rules v02

Table 1: Applicability of DFS Requirements Prior to Use of a Channel

Requirement	Operational Mode		
	Master	Client Without Radar Detection	Client With Radar Detection
<i>Non-Occupancy Period</i>	Yes	Not required	Yes
<i>DFS Detection Threshold</i>	Yes	Not required	Yes
<i>Channel Availability Check Time</i>	Yes	Not required	Not required
<i>U-NII Detection Bandwidth</i>	Yes	Not required	Yes

Table 2: Applicability of DFS requirements during normal operation

Requirement	Operational Mode	
	Master Device or Client with Radar Detection	Client Without Radar Detection
<i>DFS Detection Threshold</i>	Yes	Not required
<i>Channel Closing Transmission Time</i>	Yes	Yes
<i>Channel Move Time</i>	Yes	Yes
<i>U-NII Detection Bandwidth</i>	Yes	Not required

Additional requirements for devices with multiple bandwidth modes	Master Device or Client with Radar Detection	Client Without Radar Detection
<i>U-NII Detection Bandwidth and Statistical Performance Check</i>	All BW modes must be tested	Not required
<i>Channel Move Time and Channel Closing Transmission Time</i>	Test using widest BW mode available	Test using the widest BW mode available for the link
<i>All other tests</i>	Any single BW mode	Not required
Note: Frequencies selected for statistical performance check (Section 7.8.4) should include several frequencies within the radar detection bandwidth and frequencies near the edge of the radar detection bandwidth. For 802.11 devices it is suggested to select frequencies in each of the bonded 20 MHz channels and the channel center frequency.		

Table 3: DFS Detection Thresholds for Master Devices and Client Devices With Radar Detection

Maximum Transmit Power	Value (See Notes 1, 2, and 3)
EIRP \geq 200 milliwatt	-64 dBm
EIRP < 200 milliwatt and power spectral density < 10 dBm/MHz	-62 dBm
EIRP < 200 milliwatt that do not meet the power spectral density requirement	-64 dBm
<p>Note 1: This is the level at the input of the receiver assuming a 0 dBi receive antenna.</p> <p>Note 2: Throughout these test procedures an additional 1 dB has been added to the amplitude of the test transmission waveforms to account for variations in measurement equipment. This will ensure that the test signal is at or above the detection threshold level to trigger a DFS response.</p> <p>Note3: EIRP is based on the highest antenna gain. For MIMO devices refer to KDB Publication 662911 D01.</p>	

Table 4: DFS Response Requirement Values

Parameter	Value
<i>Non-occupancy period</i>	Minimum 30 minutes
<i>Channel Availability Check Time</i>	60 seconds
<i>Channel Move Time</i>	10 seconds See Note 1.
<i>Channel Closing Transmission Time</i>	200 milliseconds + an aggregate of 60 milliseconds over remaining 10 second period. See Notes 1 and 2.
<i>U-NII Detection Bandwidth</i>	Minimum 100% of the U-NII 99% transmission power bandwidth. See Note 3.
<p>Note 1: <i>Channel Move Time</i> and the <i>Channel Closing Transmission Time</i> should be performed with Radar Type 0. The measurement timing begins at the end of the Radar Type 0 burst.</p> <p>Note 2: The <i>Channel Closing Transmission Time</i> is comprised of 200 milliseconds starting at the beginning of the <i>Channel Move Time</i> plus any additional intermittent control signals required to facilitate a <i>Channel</i> move (an aggregate of 60 milliseconds) during the remainder of the 10 second period. The aggregate duration of control signals will not count quiet periods in between transmissions.</p> <p>Note 3: During the <i>U-NII Detection Bandwidth</i> detection test, radar type 0 should be used. For each frequency step the minimum percentage of detection is 90 percent. Measurements are performed with no data traffic.</p>	

Table 5 – Short Pulse Radar Test Waveforms

Radar Type	Pulse Width (μsec)	PRI (μsec)	Number of Pulses	Minimum Percentage of Successful Detection	Minimum Number of Trials
0	1	1428	18	See Note 1	See Note 1
1	1	Test A: 15 unique PRI values randomly selected from the list of 23 PRI values in Table 5a	Roundup $\left\{ \left(\frac{1}{360} \right) \cdot \left(\frac{19 \cdot 10^6}{PRI_{\mu sec}} \right) \right\}$	60%	30
		Test B: 15 unique PRI values randomly selected within the range of 518-3066 μsec, with a minimum increment of 1 μsec, excluding PRI values selected in Test A			
2	1-5	150-230	23-29	60%	30
3	6-10	200-500	16-18	60%	30
4	11-20	200-500	12-16	60%	30
Aggregate (Radar Types 1-4)				80%	120
Note 1: Short Pulse Radar Type 0 should be used for the detection bandwidth test, channel move time, and channel closing time tests.					

A minimum of 30 unique waveforms are required for each of the Short Pulse Radar Types 2 through 4. If more than 30 waveforms are used for Short Pulse Radar Types 2 through 4, then each additional waveform must also be unique and not repeated from the previous waveforms. If more than 30 waveforms are used for Short Pulse Radar Type 1, then each additional waveform is generated with Test B and must also be unique and not repeated from the previous waveforms in Tests A or B.

For example if in Short Pulse Radar Type 1 Test B a PRI of 3066 usec is selected, the number of pulses

would be $Roundup \left\{ \left(\frac{1}{360} \right) \cdot \left(\frac{19 \cdot 10^6}{3066} \right) \right\} = Roundup \{17.2\} = 18.$

Table 5a - Pulse Repetition Intervals Values for Test A

Pulse Repetition Frequency Number	Pulse Repetition Frequency (Pulses Per Second)	Pulse Repetition Interval (Microseconds)
1	1930.5	518
2	1858.7	538
3	1792.1	558
4	1730.1	578
5	1672.2	598
6	1618.1	618
7	1567.4	638
8	1519.8	658
9	1474.9	678
10	1432.7	698
11	1392.8	718
12	1355	738
13	1319.3	758
14	1285.3	778
15	1253.1	798
16	1222.5	818
17	1193.3	838
18	1165.6	858
19	1139	878
20	1113.6	898
21	1089.3	918
22	1066.1	938
23	326.2	3066

The aggregate is the average of the percentage of successful detections of Short Pulse Radar Types 1-4. For example, the following table indicates how to compute the aggregate of percentage of successful detections.

Radar Type	Number of Trials	Number of Successful Detections	Minimum Percentage of Successful Detection
1	35	29	82.9%
2	30	18	60%
3	30	27	90%
4	50	44	88%
Aggregate $(82.9\% + 60\% + 90\% + 88\%)/4 = 80.2\%$			

Table 6 – Long Pulse Radar Test Waveform

Radar Type	Pulse Width (μsec)	Chirp Width (MHz)	PRI (μsec)	Number of Pulses per <i>Burst</i>	Number of <i>Bursts</i>	Minimum Percentage of Successful Detection	Minimum Number of Trials
5	50-100	5-20	1000-2000	1-3	8-20	80%	30

Table 7 – Frequency Hopping Radar Test Waveform

Radar Type	Pulse Width (μsec)	PRI (μsec)	Pulses per Hop	Hopping Rate (kHz)	Hopping Sequence Length (msec)	Minimum Percentage of Successful Detection	Minimum Number of Trials
6	1	333	9	0.333	300	70%	30

DFS Measurement System

BACL DFS measurement system consists of two subsystems: (1) The radar signal generating subsystem and (2) the traffic monitoring subsystem.

System Block Diagram

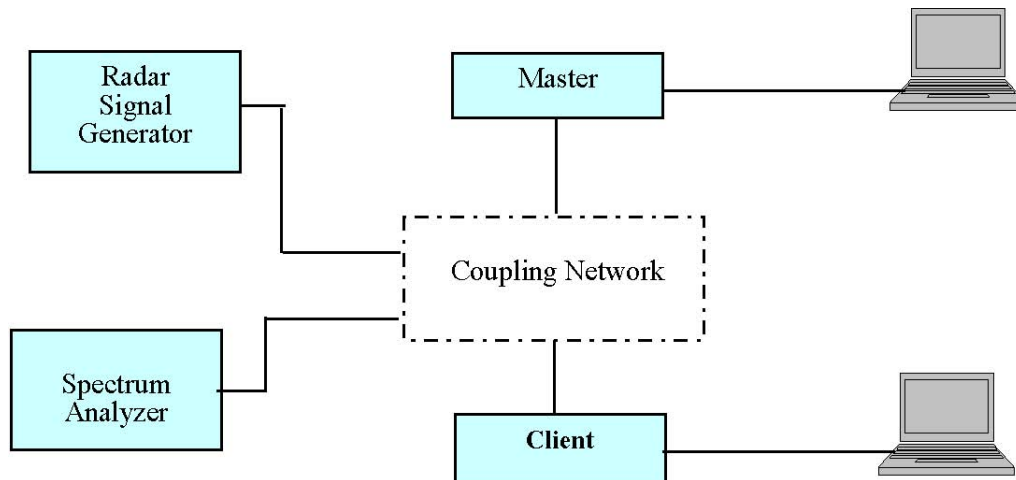

Conducted Method

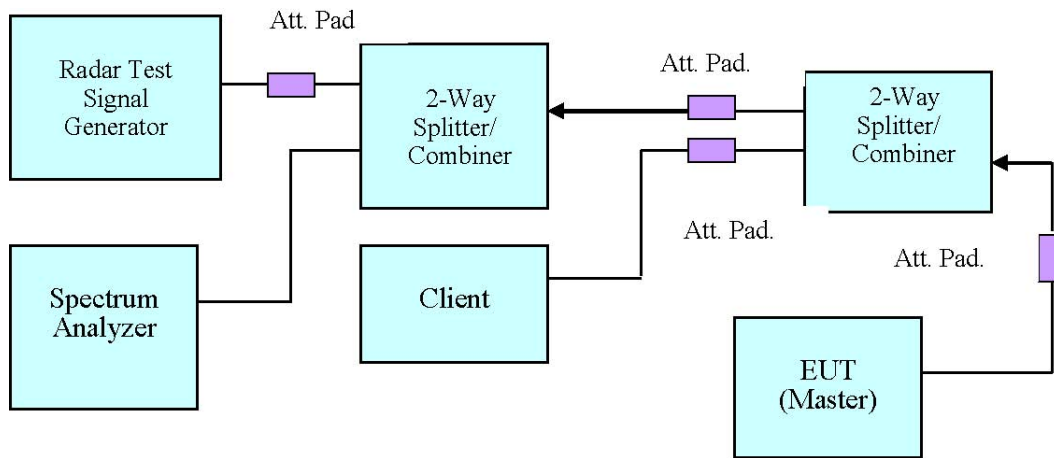

Setup for Master with injection at the Master

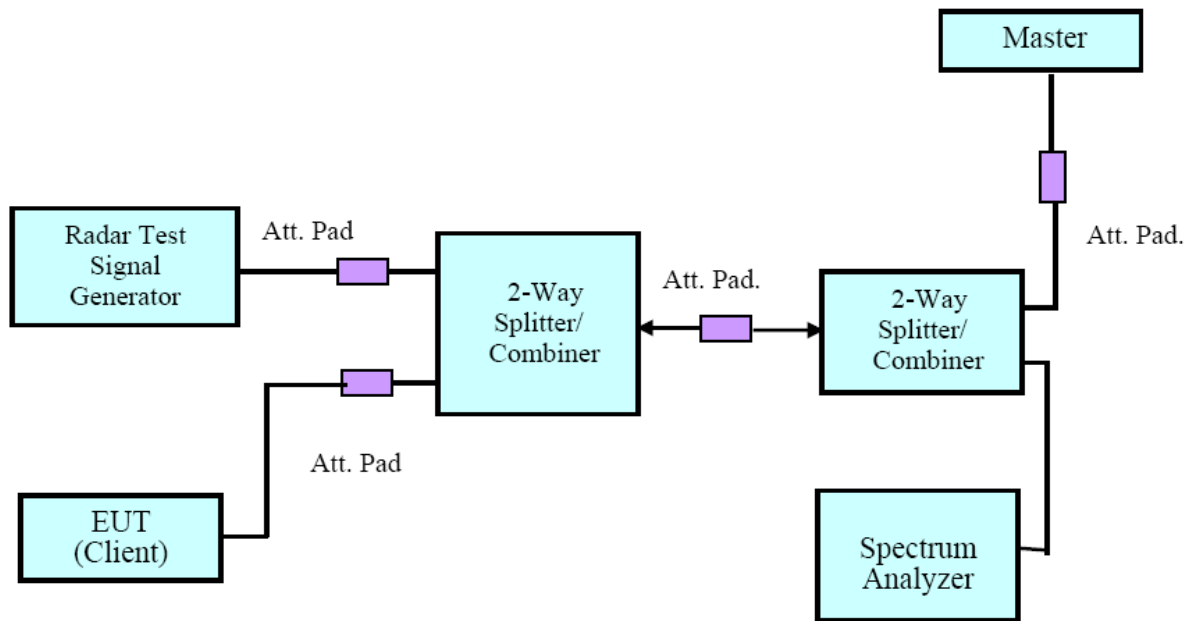

Setup for Client with injection at the Master

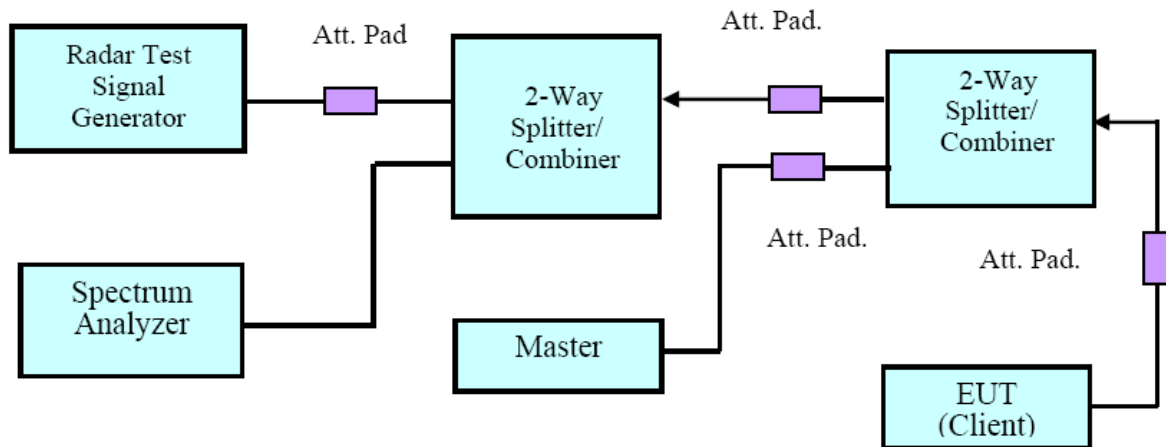

Setup for Client with injection at the Client

Radiated Method

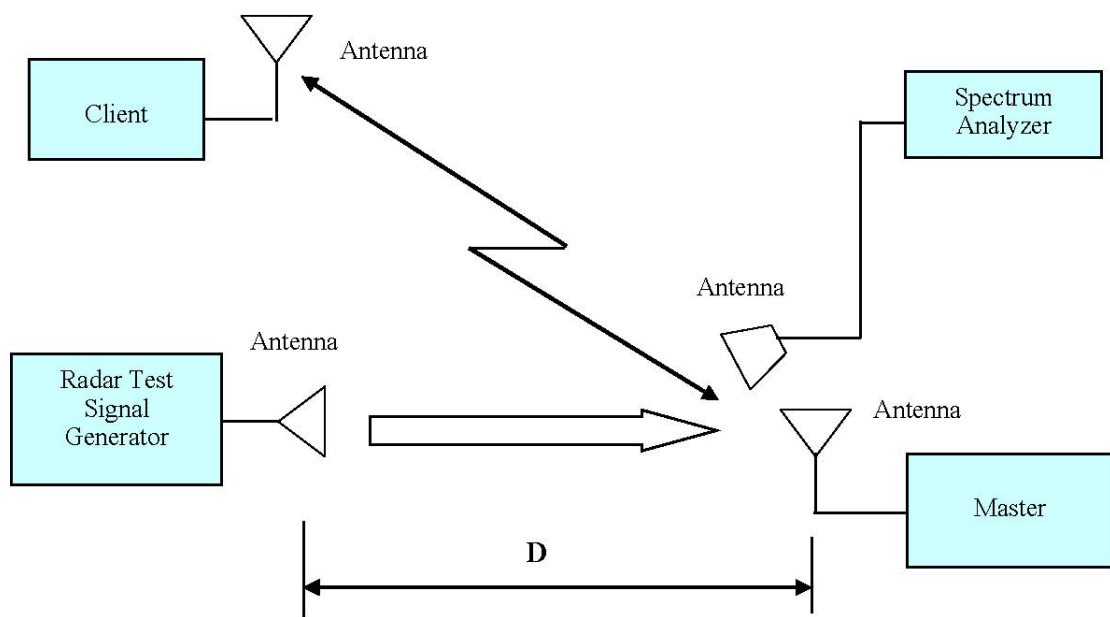

Test Procedure

A spectrum analyzer is used as a monitor verifies that the EUT status including Channel Closing Transmission Time and Channel Move Time, and does not transmit on a Channel during the Non-Occupancy Period after the diction and Channel move. It is also used to monitor EUT transmissions during the Channel Availability Check Time.

TEST RESULTS

Description of EUT

The calibrated radiated DFS detection threshold level is set to -64 dBm is more stringent.

WLAN traffic is generated by streaming the video file TestFile.mpg, this file is used by IP and Frame based systems for loading the test channel during the In-service compliance testing of the U-NII device. The file is streamed from the Access Point to the Client in full motion video mode using the media player with the V2.61 Codec package.

Test Equipment List and Details

Manufacturer	Description	Model	Serial Number	Calibration Date	Calibration Due Date
National Instruments	NI PXI-1042 8-Slot chassis	PXI-1042	VOBX40FBD	N/A	N/A
National Instruments	Arbitrary Waveform Generator	PXI-5421	N/A	N/A	N/A
National Instruments	RF Upconverter	PXI-5610	N/A	N/A	N/A
ASCOR	Upconverter	AS-7202	N/A	N/A	N/A
Agilent	Spectrum Analyzer	E4440A	SG43360054	2019-05-09	2020-05-09
Ditorn	Splitter/Combiner	D3C4080	SN2244	N/A	N/A
TDK RF	Horn Antenna	HRN-0118	130 084	2017-01-05	2020-01-04
ETS LINDGREN	Horn Antenna	3115	000 527 35	2017-01-05	2020-01-04

* **Statement of Traceability:** Bay Area Compliance Laboratories Corp. (Dongguan) attests that all calibrations have been performed, traceable to National Primary Standards and International System of Units (SI).

Radar Waveform Calibration

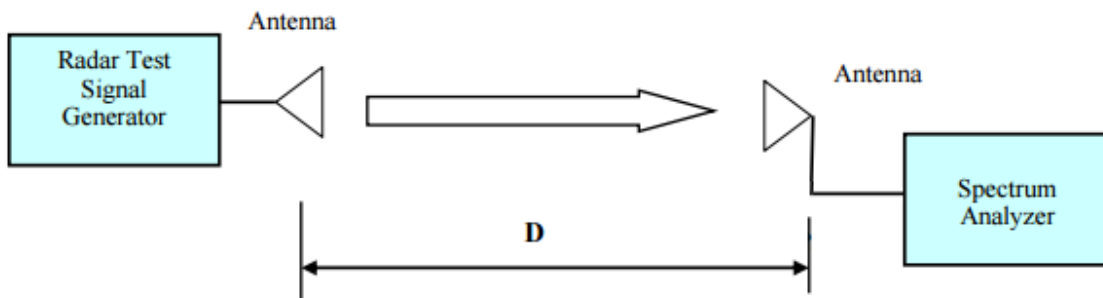

Radiated Calibration Setup Block Diagram

Test Environmental Conditions

Temperature:	22.8~23.4 °C
Relative Humidity:	35~59 %
ATM Pressure:	101.2 kPa
Tester:	Vern Shen
Test Date:	2020-04-02~2020-04-10

Plots of Radar Waveforms

5500 MHz:

Radar Type 0

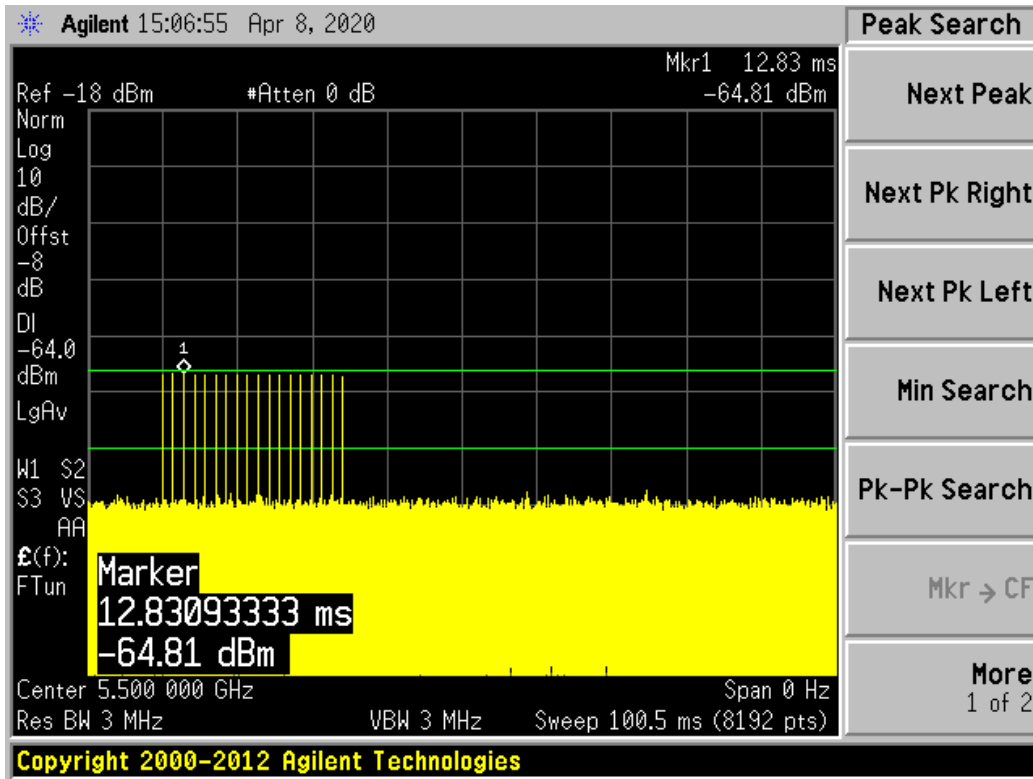

Radar Type 1A

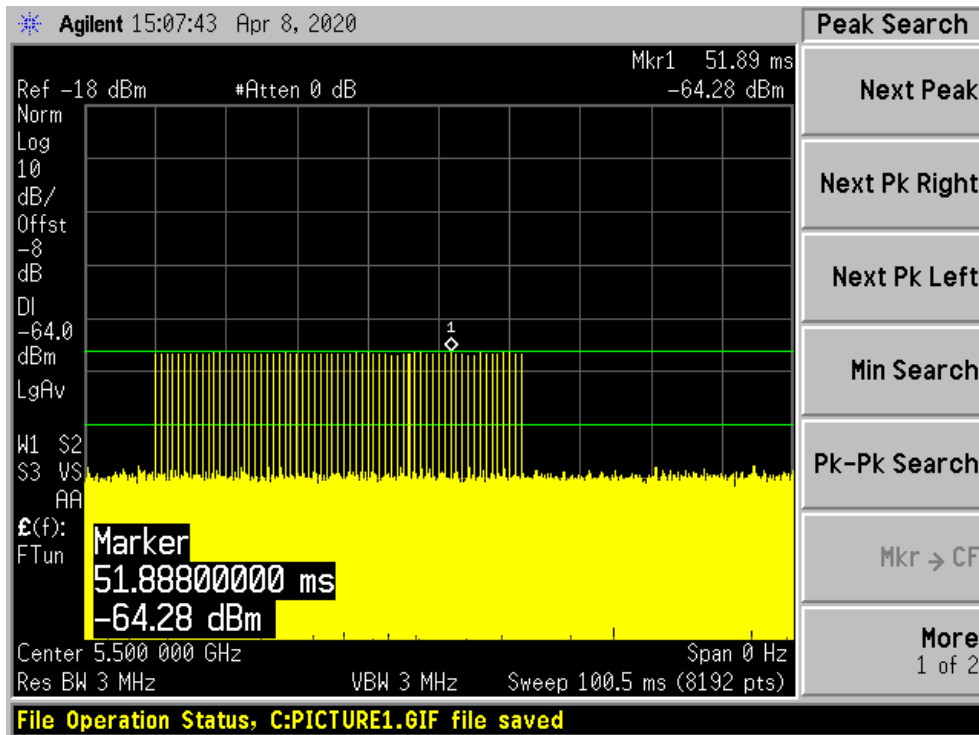

Radar Type 1B

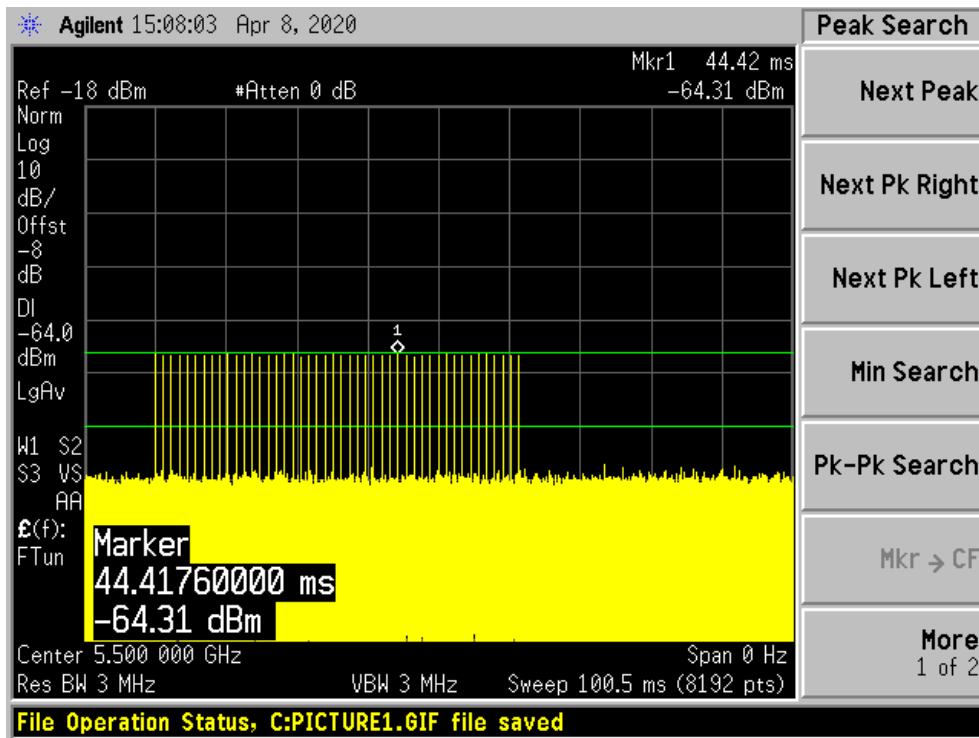

Radar Type 2

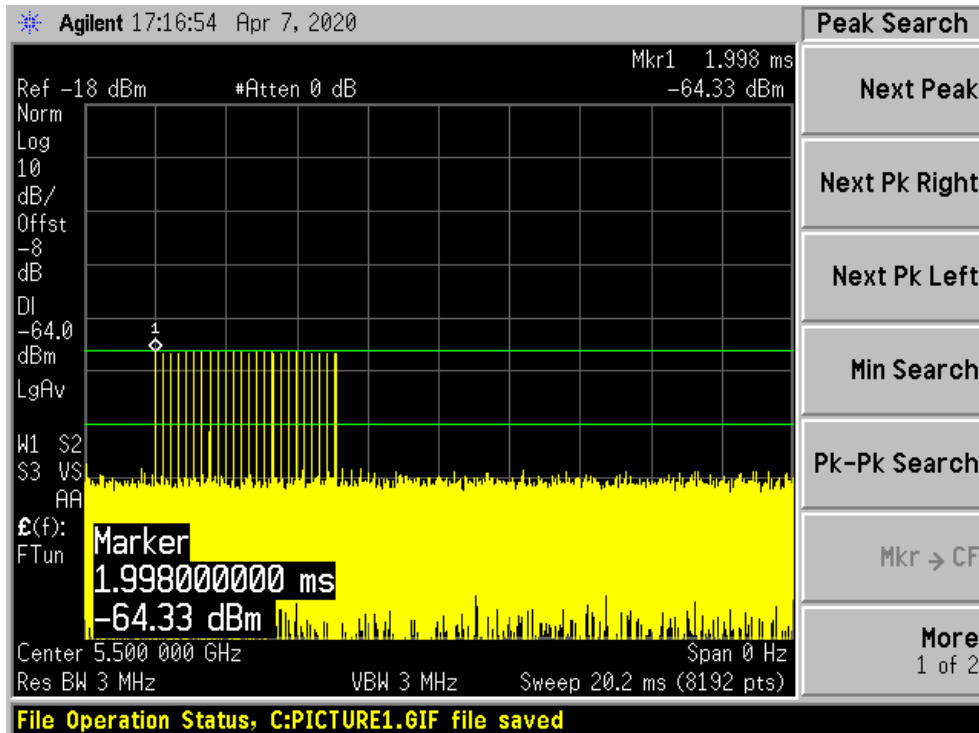

Radar Type 3

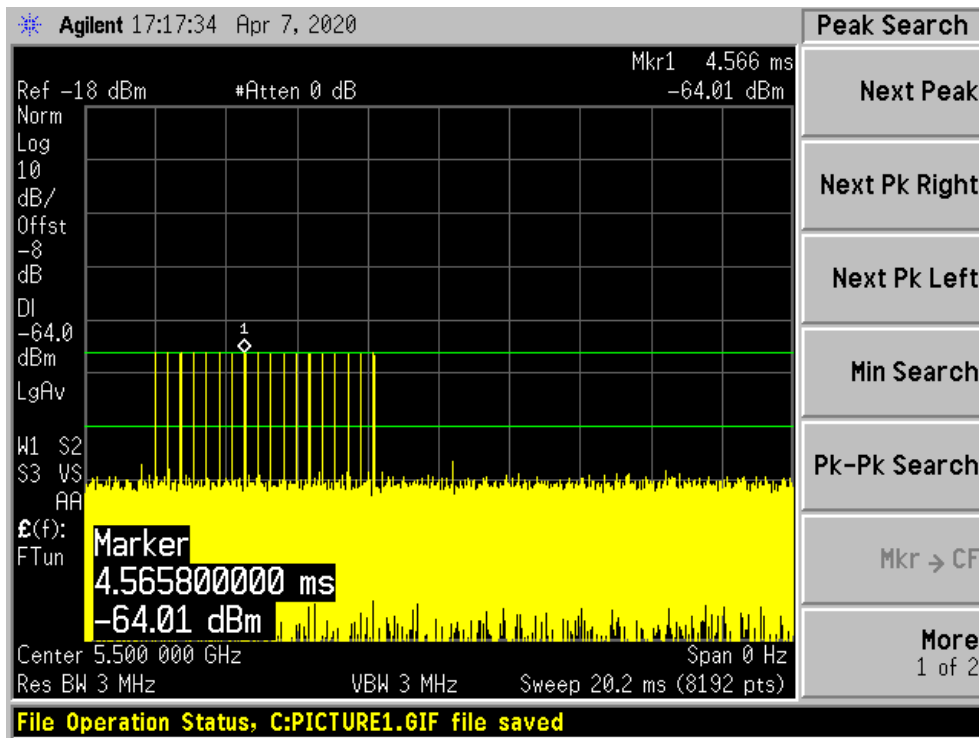

Radar Type 4

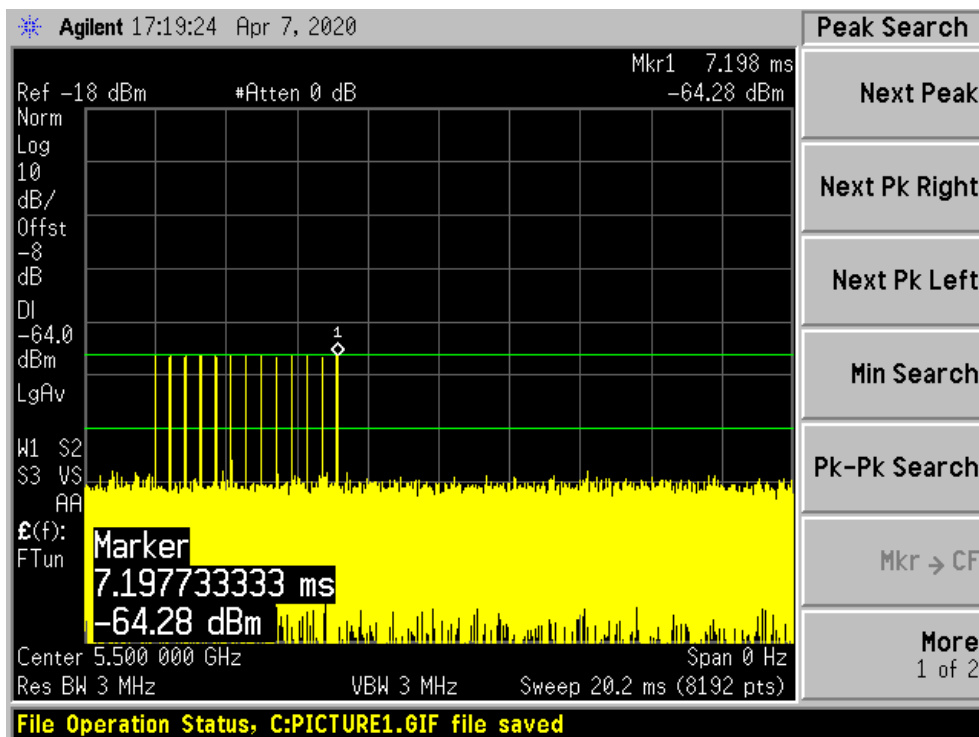

Radar Type 5 Case 1

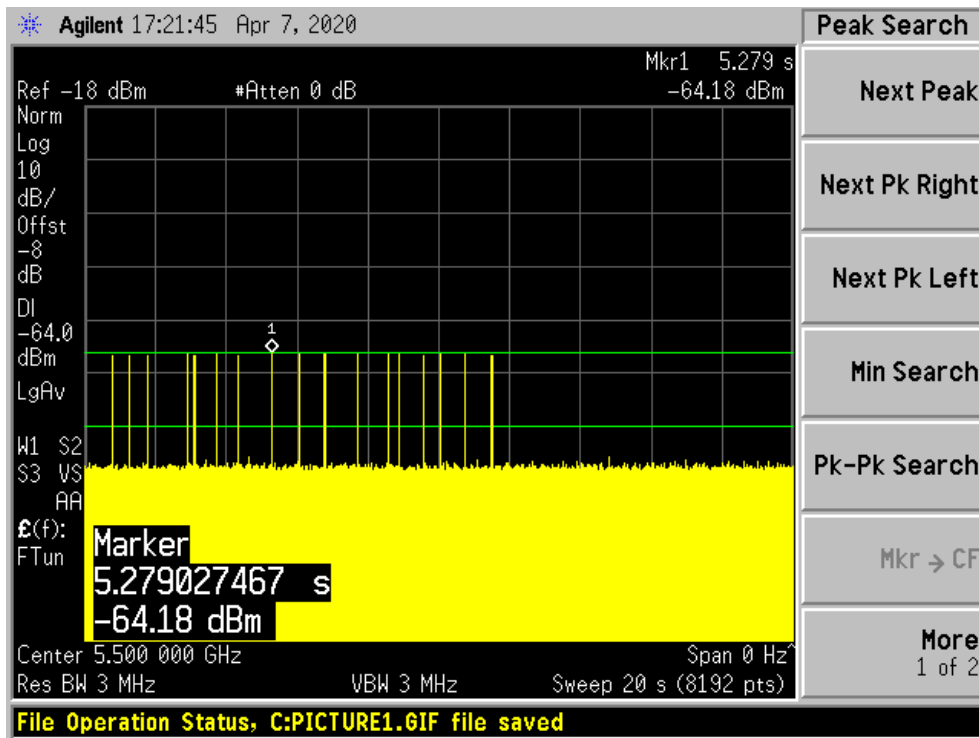

Radar Type 5 Case 2

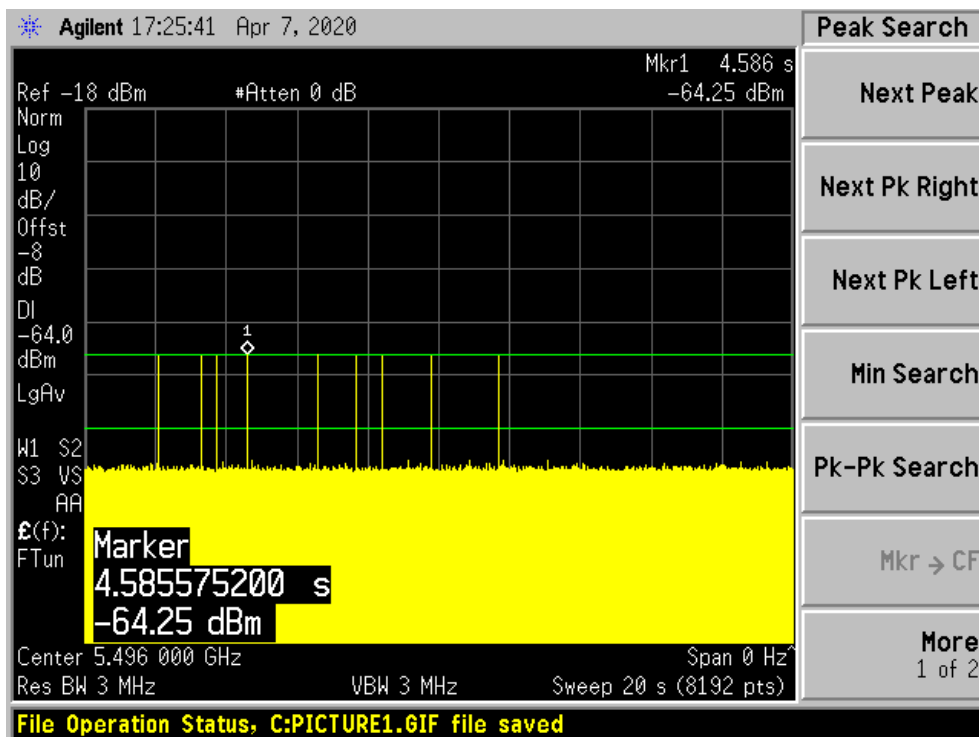

Radar Type 5 Case 3

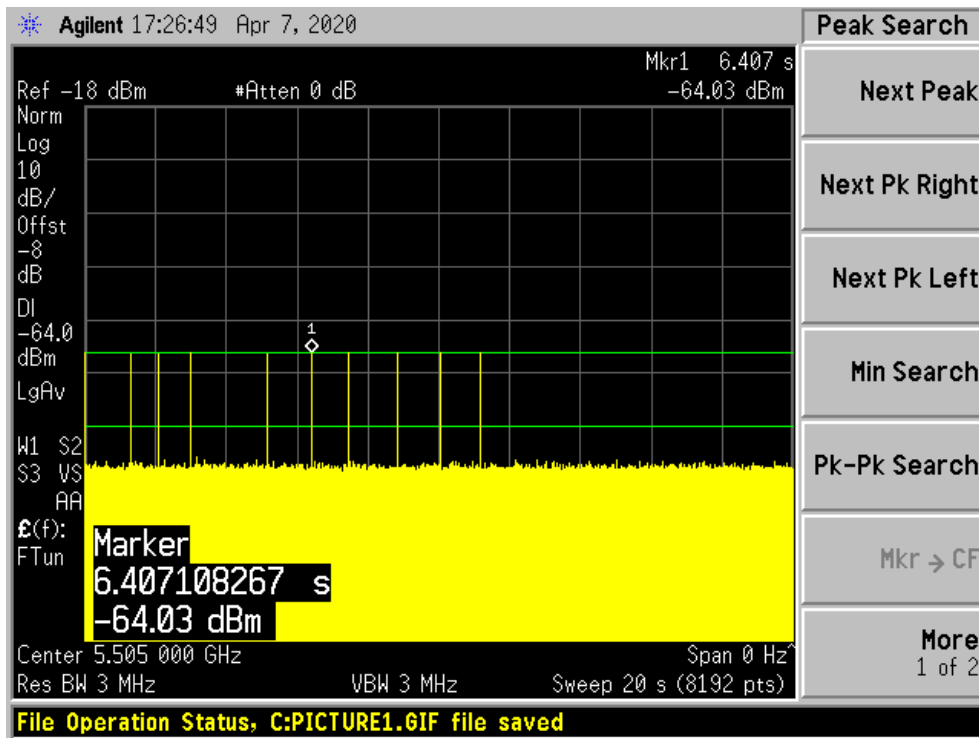

Radar Type 6

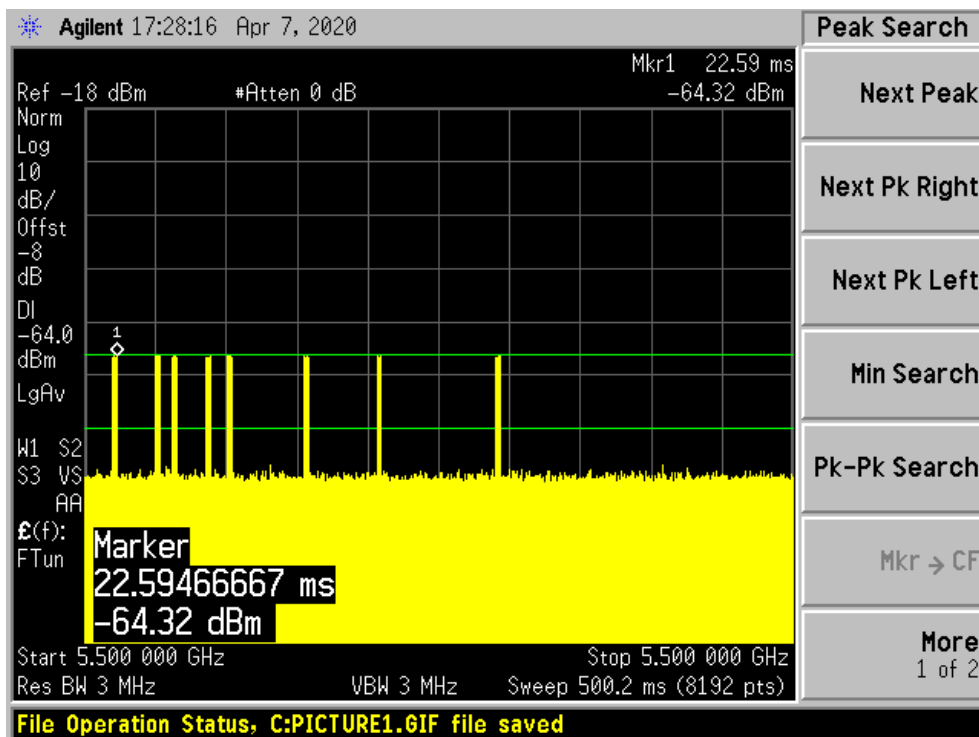

CHANNEL AVAILABILITY CHECK TIME (CAC)

Test Procedure

- 1) Channel Availability Check Time (CAC)
- 2) With link established on channel, apply a radar signal within 0~6 seconds after the initial power-up period; monitor the transmissions on channel from the spectrum analyzer.
- 3) Reboot EUT, with a link established on channel, apply a radar signal within 54~60 seconds after the initial power-up period, and monitor the transmission on channel from the spectrum analyzer.

EUT Initial power-up Cycle Time

Test Frequency (MHz)	EUT initial Power-up cycle (Second)
5500	88.85

Results:

Timing of Radar Burst	Spectrum Analyzer Display
No Radar Triggered	Transmission begin after power-up cycle +60 seconds CAC
Within 6 seconds of the CAC starting	No transmission
Within the last 6 seconds of the CAC	No transmission

Please refer to the following plots.

Plot of without Radar signal applied

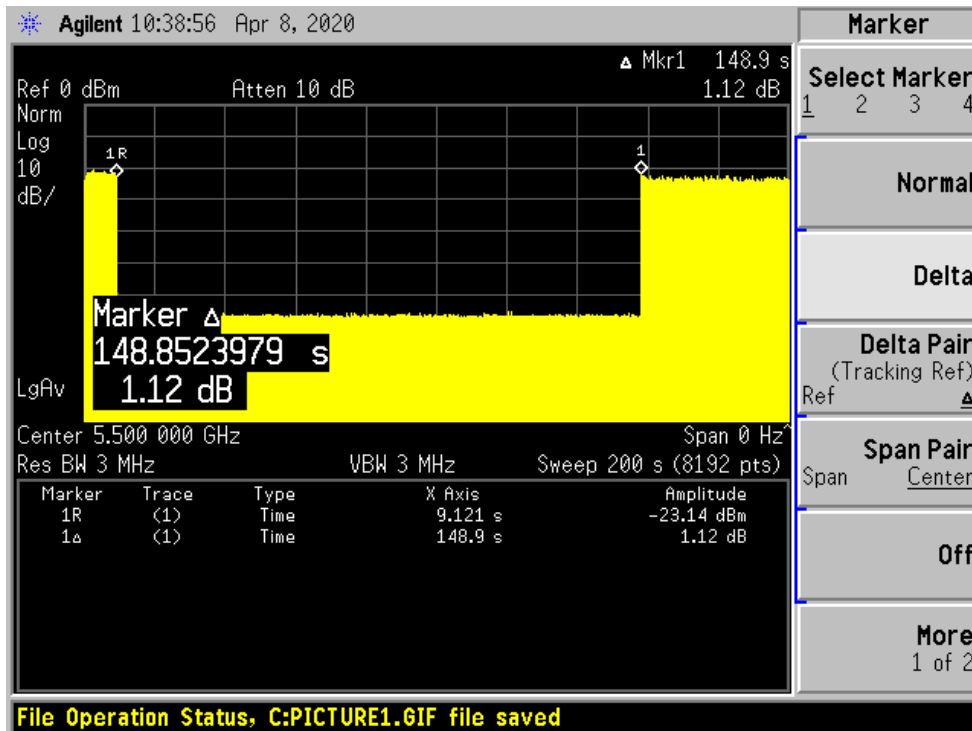

Note: The power-up cycle is 88.85 seconds.

Plot of Radar signal applied within 6 seconds of start of CAC

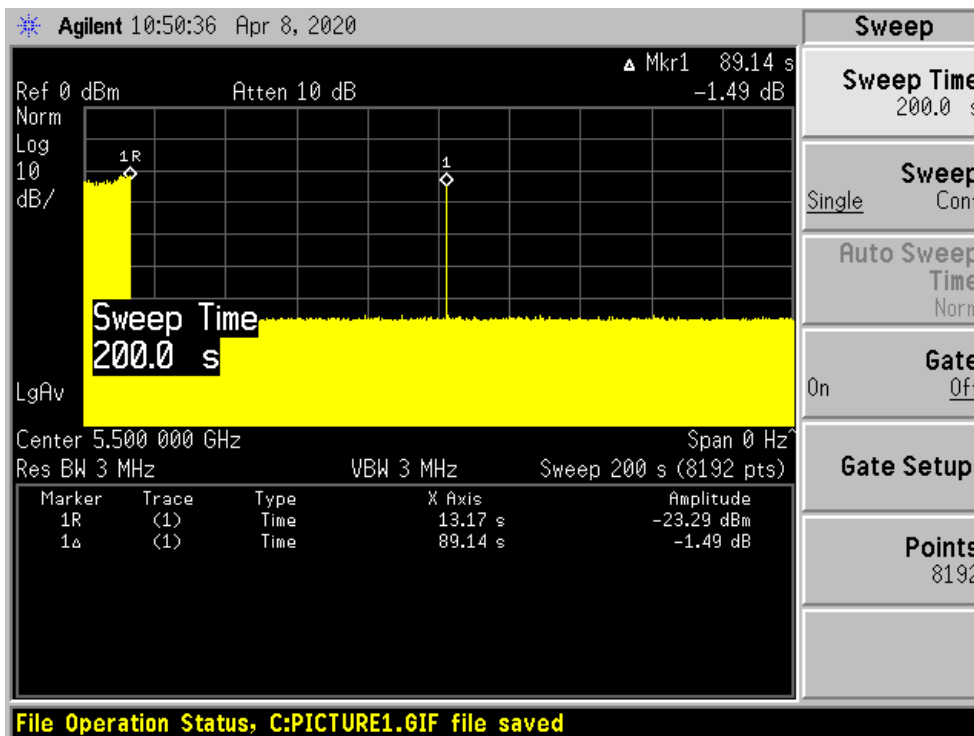

No transmissions found after radar signal applied.

Plot of Radar signal applied at the end of 6 seconds of CAC

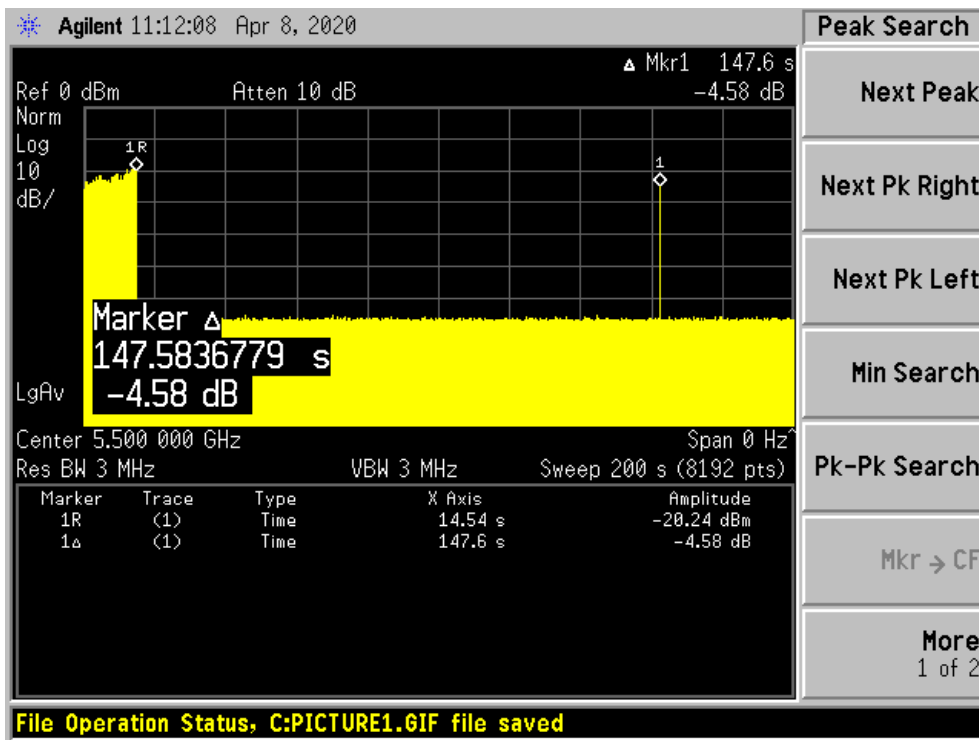

No transmissions found after radar signal applied.

CHANNEL MOVE TIME AND CHANNEL CLOSING TRANSMISSION TIME

Test Procedure

Perform type 0 short pulse radar waveform.

The aggregate channel closing transmission time is calculated as follows:

Aggregate Transmission Time = N*Dwell Time

N is the number of spectrum analyzer bins showing a device transmission Dwell Time is the dwell time per bin (i.e. Dwell Time = S/B, S is the sweep time and B is the number of bin, i.e. 8192)

Test Results

Frequency (MHz)	Bandwidth (MHz)	Radar Type	Results
5530	80	Type 0	Compliant

Please refer to the following tables and plots.

5530 MHz

Type 0 radar channel move time result:

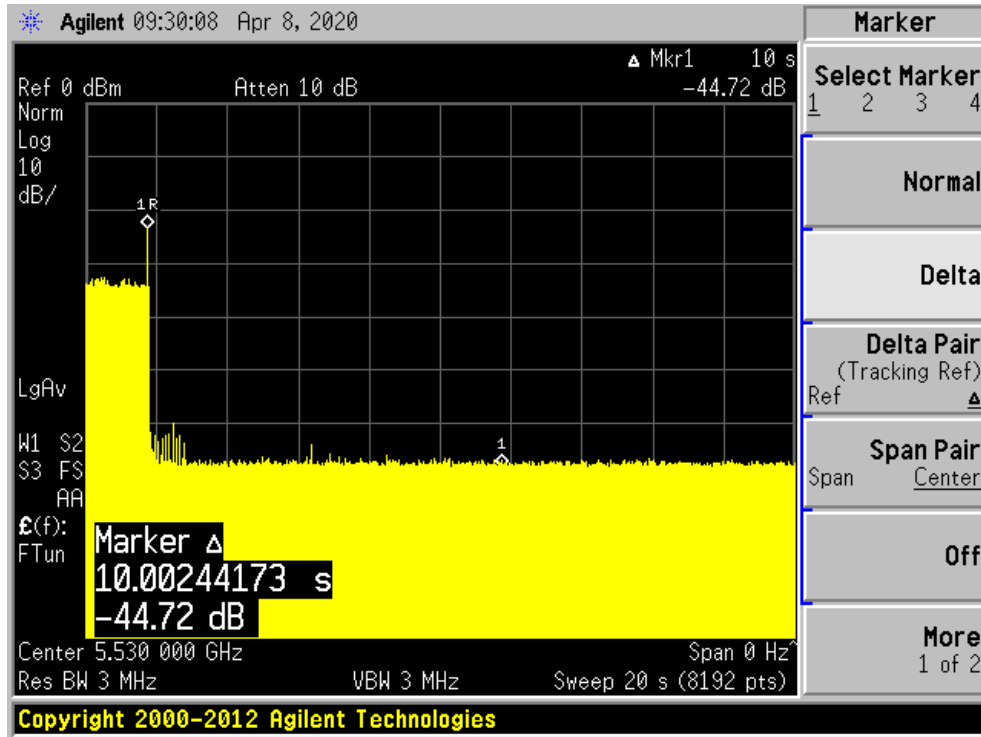

Type0 radar channel closing transmission time result:

Transmission After 200ms	Aggregate Transmission Time After 200ms Delay (ms)	Limit for Aggregate Transmission Time After 200ms Delay (ms)	Result
Yes	21.97	60	Pass

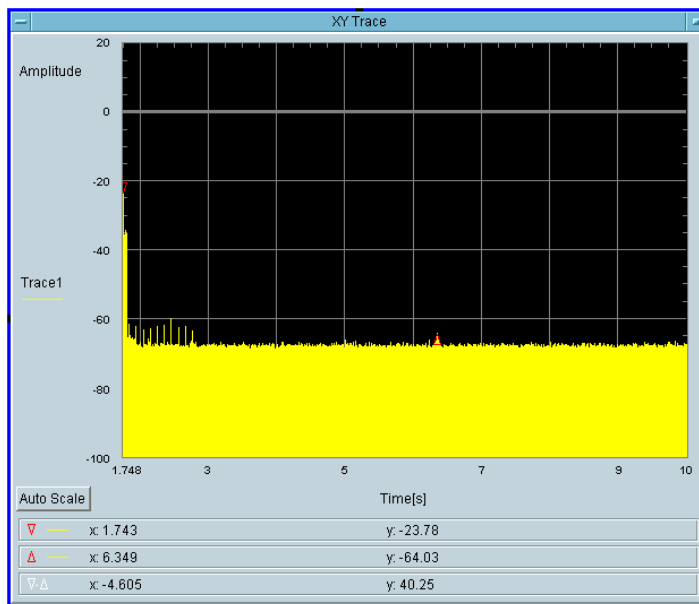

Total On Time [s]
48.83m

Total On Time After Delay [s]
21.97m

NON-OCCUPANCY PERIOD

Test Procedure

Measure the EUT for more than 30 minutes following the channel close/move time to verify that the EUT does not resume any transmissions on this channel. Provide one plot to demonstrate no transmission on the channel for the non-occupancy period (30 minutes observation time)

Test Result

Frequency(MHz)	Bandwidth (MHz)	Spectrum Analyzer Display
5530	80	No transmission within 30 minutes

Please refer to the following plots.

5530 MHz

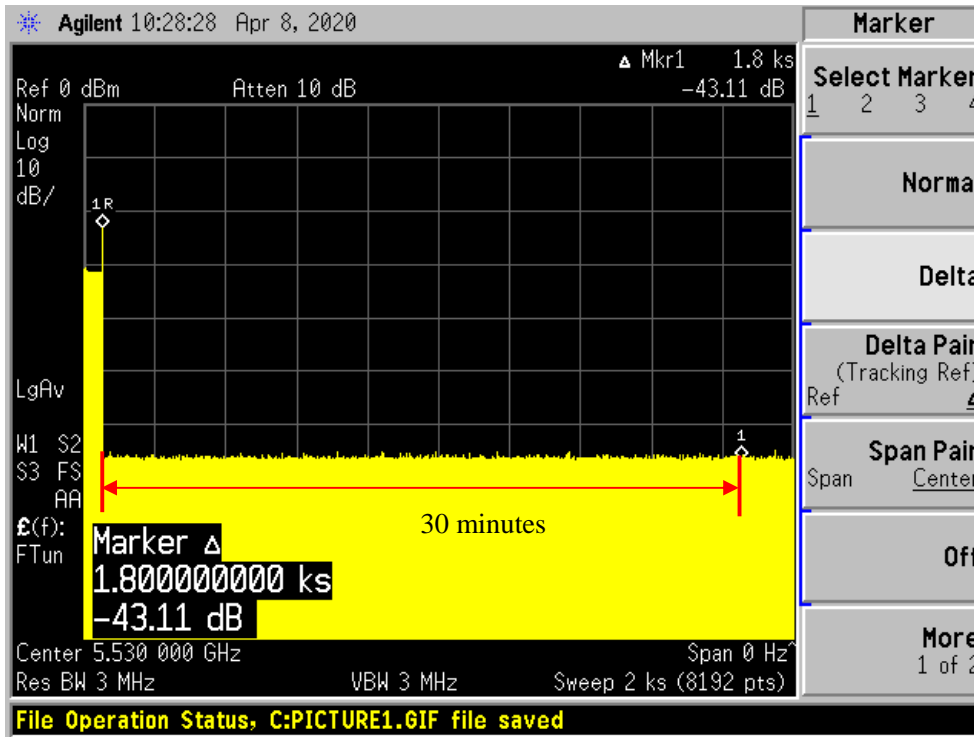

DETECTION BANDWIDTH

Test Procedure

Performed with Type 0 radar waveforms

Starting at the center frequency of the UUT operating *Channel*, increase the radar frequency in 5 MHz steps, repeating the above test sequence, until the detection rate falls below the *U-NII Detection Bandwidth* criterion specified in **Table 4**. Repeat this measurement in 1MHz steps at frequencies 5 MHz below where the detection rate begins to fall. Record the highest frequency (denote as F_H) at which detection is greater than or equal to the *U-NII Detection Bandwidth* criterion. Recording the detection rate at frequencies above F_H is not required to demonstrate compliance.

Starting at the center frequency of the UUT operating *Channel*, decrease the radar frequency in 5 MHz steps, repeating the above test sequence, until the detection rate falls below the *U-NII Detection Bandwidth* criterion specified in **Table 4**. Repeat this measurement in 1MHz steps at frequencies 5 MHz above where the detection rate begins to fall. Record the lowest frequency (denote as F_L) at which detection is greater than or equal to the *U-NII Detection Bandwidth* criterion. Recording the detection rate at frequencies below F_L is not required to demonstrate compliance.

The *U-NII Detection Bandwidth* is calculated as follows:

$$U-NII\ Detection\ Bandwidth = F_H - F_L$$

The *U-NII Detection Bandwidth* must meet the *U-NII Detection Bandwidth* criterion specified in **Table 4**. Otherwise, the UUT does not comply with DFS requirements. This is essential to ensure that the UUT is capable of detecting *Radar Waveforms* across the same frequency spectrum that contains the significant energy from the system. In the case that the *U-NII Detection Bandwidth* is greater than or equal to the 99 percent power bandwidth for the measured F_H and F_L , the test can be truncated and the *U-NII Detection Bandwidth* can be reported as the measured F_H and F_L .

Test Result

Frequency (MHz)	Bandwidth Systems (MHz)	F _L (MHz)	F _H (MHz)	Detection Bandwidth (MHz)	99% Occupied Bandwidth (MHz)	Minimum Limit	Result
5500	20	5490	5510	20	18.53	100%	Compliance
5510	40	5490	5530	40	36.92	100%	Compliance
5530	80	5490	5570	80	75.90	100%	Compliance

Please refer to the following tables and plots.

Results of Detection Bandwidth:

20MHz Bandwidth, EUT Frequency = 5500MHz											
DFS Detection Trials (1 = Detected, 0 = No Detected)											
Radar Frequency (MHz)	1	2	3	4	5	6	7	8	9	10	Detection Rate (%)
5490(F_L)	1	1	1	1	1	1	1	1	1	1	100 %
5491	1	1	1	1	1	1	1	1	1	1	100 %
5492	1	1	1	1	1	1	1	1	1	1	100 %
5493	1	1	1	1	1	1	1	1	1	1	100 %
5494	1	1	1	1	1	1	1	1	1	1	100 %
5495	1	1	1	1	1	1	1	1	1	1	100 %
5500	1	1	1	1	1	1	1	1	1	1	100 %
5505	1	1	1	1	1	1	1	1	1	1	100 %
5506	1	1	1	1	1	1	1	1	1	1	100 %
5507	1	1	1	1	1	1	1	1	1	1	100 %
5508	1	1	1	1	1	1	1	1	1	1	100 %
5509	1	1	1	1	1	1	1	1	1	1	100 %
5510(F_H)	1	1	1	1	1	1	1	1	1	1	100 %
Detection Bandwidth = F _H - F _L = 5510-5490 = 20 MHz											
EUT 99% BW = 18.53 MHz;											Result: Pass

40MHz Bandwidth, EUT Frequency = 5510 MHz											
DFS Detection Trials (1 = Detected, 0 = No Detected)											
Radar Frequency (MHz)	1	2	3	4	5	6	7	8	9	10	Detection Rate (%)
5490(F_L)	1	1	1	1	1	1	1	1	1	1	100 %
5491	1	1	1	1	1	1	1	1	1	1	100 %
5492	1	1	1	1	1	1	1	1	1	1	100 %
5493	1	1	1	1	1	1	1	1	1	1	100 %
5494	1	1	1	1	1	1	1	1	1	1	100 %
5495	1	1	1	1	1	1	1	1	1	1	100 %
5500	1	1	1	1	1	1	1	1	1	1	100 %
5505	1	1	1	1	1	1	1	1	1	1	100 %
5510	1	1	1	1	1	1	1	1	1	1	100 %
5515	1	1	1	1	1	1	1	1	1	1	100 %
5520	1	1	1	1	1	1	1	1	1	1	100 %
5525	1	1	1	1	1	1	1	1	1	1	100 %
5526	1	1	1	1	1	1	1	1	1	1	100 %
5527	1	1	1	1	1	1	1	1	1	1	100 %
5528	1	1	1	1	1	1	1	1	1	1	100 %
5529	1	1	1	1	1	1	1	1	1	1	100 %
5530(F_H)	1	1	1	1	1	1	1	1	1	1	100 %
Detection Bandwidth = F _H - F _L = 5530-5490 = 40 MHz											
EUT 99% BW = 36.92 MHz;										Result: Pass	

80MHz Bandwidth, EUT Frequency = 5530 MHz											
DFS Detection Trials (1 = Detected, 0 = No Detected)											
Radar Frequency (MHz)	1	2	3	4	5	6	7	8	9	10	Detection Rate (%)
5490(F_L)	1	1	1	1	1	1	1	1	1	1	100 %
5491	1	1	1	1	1	1	1	1	1	1	100 %
5492	1	1	1	1	1	1	1	1	1	1	100 %
5493	1	1	1	1	1	1	1	1	1	1	100 %
5494	1	1	1	1	1	1	1	1	1	1	100 %
5495	1	1	1	1	1	1	1	1	1	1	100 %
5500	1	1	1	1	1	1	1	1	1	1	100 %
5505	1	1	1	1	1	1	1	1	1	1	100 %
5510	1	1	1	1	1	1	1	1	1	1	100 %
5515	1	1	1	1	1	1	1	1	1	1	100 %
5520	1	1	1	1	1	1	1	1	1	1	100 %
5525	1	1	1	1	1	1	1	1	1	1	100 %
5530	1	1	1	1	1	1	1	1	1	1	100 %
5535	1	1	1	1	1	1	1	1	1	1	100 %
5540	1	1	1	1	1	1	1	1	1	1	100 %
5545	1	1	1	1	1	1	1	1	1	1	100 %
5550	1	1	1	1	1	1	1	1	1	1	100 %
5555	1	1	1	1	1	1	1	1	1	1	100 %
5560	1	1	1	1	1	1	1	1	1	1	100 %
5565	1	1	1	1	1	1	1	1	1	1	100 %
5566	1	1	1	1	1	1	1	1	1	1	100 %
5567	1	1	1	1	1	1	1	1	1	1	100 %
5568	1	1	1	1	1	1	1	1	1	1	100 %
5569	1	1	1	1	1	1	1	1	1	1	100 %
5570(F_H)	1	1	1	1	1	1	1	1	1	1	100 %
Detection Bandwidth = F_H – F_L = 5570-5490 = 80 MHz											
EUT 99% BW =75.90 MHz;											Result: Pass

STATISTICAL PERFORMANCE CHECK

Procedure:

The steps below define the procedure to determine the minimum percentage of successful detection requirements found in **Tables 5-7** when a radar burst with a level equal to the *DFS Detection Threshold* + 1dB is generated on the *Operating Channel* of the U-NII device (*In-Service Monitoring*).

- a) One frequency will be chosen from the *Operating Channels* of the UUT within the 5250-5350 MHz or 5470-5725 MHz bands.
- b) In case the UUT is a U-NII device operating as a Client Device (with or without Radar Detection), a U-NII device operating as a Master Device will be used to allow the UUT (Client device) to Associate with the Master Device. In case the UUT is a Master Device, a U-NII device operating as a Client Device will be used and it is assumed that the Client will Associate with the UUT (Master). In both cases for conducted tests, the Radar Waveform generator will be connected to the Master Device. For radiated tests, the emissions of the Radar Waveform generator will be directed towards the Master Device. If the Master Device has antenna gain, the main beam of the antenna will be directed toward the radar emitter. Vertical polarization is used for testing.
- c) Stream the channel loading test file from the *Master Device* to the Client Device on the test *Channel* for the entire period of the test.
- d) At time T_0 the *Radar Waveform* generator sends the individual waveform for each of the Radar Types 1- 6 in **Tables 5-7**, at levels defined in **Table 3**, on the *Operating Channel*. An additional 1 dB is added to the radar test signal to ensure it is at or above the *DFS Detection Threshold*, accounting for equipment variations/errors.
- e) Observe the transmissions of the UUT at the end of the Burst on the *Operating Channel* for duration greater than 10 seconds for Radar Type 0 to ensure detection occurs.
- f) Observe the transmissions of the UUT at the end of the Burst on the *Operating Channel* for duration greater than 22 seconds for Long Pulse Radar Type 5 to ensure detection occurs.
- g) In case the UUT is a U-NII device operating as a *Client Device* with *In-Service Monitoring*, perform steps a) to f).

Result:**20MHz**

Radar SignalType	Waveform/Trial Number	Detection (%)	Limit (%)	Pass/Fail
Type 1A	15	100%	60%	pass
Type 1B	15	100%	60%	pass
Type 2	30	96.7%	60%	Pass
Type 3	30	96.7%	60%	Pass
Type 4	30	83.3%	60%	Pass
Aggregate (Type1 to 4)	120	94.17 %	80%	Pass
Type 5	30	100 %	80%	Pass
Type 6	30	100 %	70%	Pass

Please refer to the following statistical tables:

5500MHz**Radar Type 1A Statistical Performance**

Trial #	Fc (MHz)	Pulse/Burst	Pulse Width (μS)	PRI (μs)	Detection (1:yes; 0:no)
1	5500	78	1	678	1
2	5500	76	1	698	1
3	5500	67	1	798	1
4	5500	59	1	898	1
5	5500	72	1	738	1
6	5500	58	1	918	1
7	5500	63	1	838	1
8	5500	65	1	818	1
9	5500	99	1	538	1
10	5500	92	1	578	1
11	5500	70	1	758	1
12	5500	83	1	638	1
13	5500	18	1	3066	1
14	5500	89	1	598	1
15	5500	95	1	558	1
Detection Percentage: 100 % (>60%)					

Radar Type 1B Statistical Performance

Trial #	Fc (MHz)	Pulse/Burst	Pulse Width (μS)	PRI (μs)	Detection (1:yes; 0:no)
1	5500	35	1	1528	1
2	5500	38	1	1406	1
3	5500	33	1	1623	1
4	5500	64	1	831	1
5	5500	19	1	2903	1
6	5500	34	1	1564	1
7	5500	73	1	729	1
8	5500	85	1	626	1
9	5500	63	1	850	1
10	5500	36	1	1467	1
11	5500	44	1	1221	1
12	5500	62	1	857	1
13	5500	25	1	2185	1
14	5500	37	1	1453	1
15	5500	23	1	2379	1
Detection Percentage: 100 % (>60%)					

Radar Type 2 Statistical Performance

Trial #	Fc (MHz)	Pulse/Burst	Pulse Width (μS)	PRI (μs)	Detection (1:yes; 0:no)
1	5500	28	3.1	156	1
2	5500	23	3.6	223	1
3	5500	26	2.6	173	0
4	5500	25	1.4	167	1
5	5500	25	2.7	151	1
6	5500	25	3.5	215	1
7	5500	23	2.2	152	1
8	5500	28	1.4	189	1
9	5500	25	3.7	181	1
10	5500	23	2.2	197	1
11	5500	24	4.2	155	1
12	5500	23	2.4	226	1
13	5500	24	1	181	1
14	5500	24	2.7	165	1
15	5500	25	1.2	152	1
16	5500	24	1.7	209	1
17	5500	23	4.5	205	1
18	5500	28	5	195	1
19	5500	29	4.5	183	1
20	5500	24	3.3	185	1
21	5500	27	3.8	207	1
22	5500	23	1.1	187	1
23	5500	29	5	185	1
24	5500	23	4.9	198	1
25	5500	25	5	155	1
26	5500	26	3.7	160	1
27	5500	27	3.3	159	1
28	5500	28	3	157	1
29	5500	24	2.1	182	1
30	5500	23	2.3	224	1
Detection Percentage: 96.7 % (>60%)					

Radar Type 3 Statistical Performance

Trial #	Fc (MHz)	Pulse/Burst	Pulse Width (μS)	PRI (μs)	Detection (1:yes; 0:no)
1	5500	17	7.5	317	1
2	5500	18	7	310	1
3	5500	18	8.8	381	1
4	5500	16	6.6	276	1
5	5500	18	10	359	1
6	5500	17	6.5	309	1
7	5500	18	7.4	288	1
8	5500	17	9.8	283	1
9	5500	16	6.7	342	1
10	5500	18	6.5	420	1
11	5500	17	6.2	385	1
12	5500	16	6	313	1
13	5500	16	7.5	421	1
14	5500	18	9.4	462	1
15	5500	17	8.1	467	1
16	5500	18	8.5	268	1
17	5500	17	9.9	211	1
18	5500	18	6.2	446	1
19	5500	16	9.3	372	1
20	5500	17	7.6	457	1
21	5500	17	7.8	487	1
22	5500	16	6.8	493	1
23	5500	17	8.9	300	0
24	5500	18	9.8	326	1
25	5500	18	8.4	491	1
26	5500	18	6.9	499	1
27	5500	17	9.6	250	1
28	5500	16	10	380	1
29	5500	17	6.8	222	1
30	5500	16	7.4	411	1
Detection Percentage: 96.7 % (>60%)					

Radar Type 4 Statistical Performance

Trial #	Fc (MHz)	Pulse/Burst	Pulse Width (μS)	PRI (μs)	Detection (1:yes; 0:no)
1	5500	14	13.3	291	1
2	5500	15	17.3	392	1
3	5500	15	17.1	474	1
4	5500	12	13.4	215	1
5	5500	16	12.7	498	1
6	5500	12	18.2	419	1
7	5500	12	17.3	345	1
8	5500	12	11	256	1
9	5500	14	13.6	450	0
10	5500	12	13.7	338	1
11	5500	16	15.1	433	1
12	5500	14	16	281	0
13	5500	12	16.7	304	1
14	5500	12	13	418	0
15	5500	15	12.8	362	1
16	5500	16	13.6	322	1
17	5500	15	13.6	219	1
18	5500	16	13.1	431	1
19	5500	16	15.7	327	1
20	5500	13	18.5	498	1
21	5500	15	13.7	439	1
22	5500	16	18	308	1
23	5500	14	14.2	349	0
24	5500	16	18.4	386	1
25	5500	14	13.9	367	1
26	5500	14	17.3	237	1
27	5500	14	19.4	248	0
28	5500	12	15.5	344	1
29	5500	13	18	447	1
30	5500	14	11.4	331	1
31	5500	13	14.3	438	1
32	5500	15	17.9	267	1
33	5500	13	18	465	1
34	5500	16	17.3	335	1
35	5500	15	17.5	486	1
36	5500	12	13.7	370	1
37	5500	16	19.1	322	1
38	5500	12	11.8	286	1
39	5500	15	16.4	352	1
40	5500	12	15.8	454	1
Detection Percentage: 83.3 % (>60%)					

Radar Type 5 Case 1 Statistical Performance

Statistics 1 (ChirpCenter Frequency: 5500.0MHz)

Trial #	Pulse	Chirp(MHz)	Pulse Width (µS)	Pulse 1-2 spacing(µS)	Pulse 2-3 spacing(µS)	Pulse Start(S)	Detection (1:yes;0:no)
0	3	8	88.3	1749	1313	0.189355	1
1	3	8	81.8	1537	1339	1.479249	
2	3	8	93.6	1805	1145	2.520359	
3	3	8	81.8	1421	1702	3.503655	
4	2	8	50.6	1313		3.700604	
5	2	8	87.2	1628		5.214485	
6	2	8	93.4	1892		5.967846	
7	3	8	98	1192	1539	7.153631	
8	1	8	87.1			7.478709	
9	3	8	62.1	1304	1061	8.557487	
10	2	8	74.8	1557		9.357568	
11	2	8	57.2	1531		10.57426	
12	1	8	89.9			11.67632	

Statistics 2 (ChirpCenter Frequency: 5500.0 MHz)

Trial #	Pulse	Chirp(MHz)	Pulse Width (µS)	Pulse 1-2 spacing(µS)	Pulse 2-3 spacing(µS)	Pulse Start(S)	Detection (1:yes;0:no)
0	1	15	98.1			0.364046	1
1	3	15	50.1	1576	1689	1.264862	
2	2	15	70.4	1800		2.006408	
3	3	15	57	1956	1159	3.06141	
4	3	15	80.6	1427	1459	3.528913	
5	3	15	60.7	1905	1191	4.293534	
6	2	15	63.1	1736		5.381722	
7	2	15	59	1120		6.254123	
8	3	15	62	1344	1337	7.16703	
9	1	15	64.7			8.274249	
10	1	15	84.4			8.871345	
11	2	15	53	1999		10.1915	
12	3	15	70	1068	1976	10.90041	
13	2	15	58.5	1401		11.17993	

Statistics 3 (ChirpCenter Frequency: 5500.0 MHz)

Trial #	Pulse	Chirp(MHz)	Pulse Width (μS)	Pulse 1-2 spacing(μS)	Pulse 2-3 spacing(μS)	Pulse Start(S)	Detection (1:yes;0:no)
0	3	7	71.9	1996	1487	0.041198	1
1	1	7	61.3			0.778687	
2	2	7	59.8	1564		1.726744	
3	2	7	62.2	1944		2.023459	
4	3	7	67.1	1208	1938	2.973285	
5	3	7	51.6	1189	1078	3.237735	
6	3	7	91.6	1587	1313	4.231782	
7	2	7	83.5	1476		4.701441	
8	2	7	89.5	1796		5.587	
9	2	7	94.4	1490		6.126446	
10	2	7	98.3	1860		6.66644	
11	1	7	79.3			7.551154	
12	1	7	59.2			7.624565	
13	2	7	82.6	1571		8.64132	
14	2	7	57	1340		8.993584	
15	1	7	60			9.566577	
16	2	7	70.9	1204		10.49717	
17	3	7	82.5	1916	1944	10.91494	
18	2	7	90.7	1484		11.52753	

Statistics 4 (ChirpCenter Frequency: 5500.0 MHz)

Trial #	Pulse	Chirp(MHz)	Pulse Width (μS)	Pulse 1-2 spacing(μS)	Pulse 2-3 spacing(μS)	Pulse Start(S)	Detection (1:yes;0:no)
0	3	11	57.1	1735	1942	0.902323	1
1	2	11	82.6	1406		1.760615	
2	3	11	93.9	1185	1440	2.729832	
3	2	11	80	1873		4.195118	
4	1	11	95.2			5.966052	
5	1	11	87.8			7.073716	
6	2	11	64.9	1650		8.076502	
7	3	11	72.7	1176	1499	10.36059	
8	1	11	72.3			10.89833	

Statistics 5(ChirpCenter Frequency: 5500.0 MHz)

Trial #	Pulse	Chirp(MHz)	Pulse Width (μS)	Pulse 1-2 spacing(μS)	Pulse 2-3 spacing(μS)	Pulse Start(S)	Detection (1:yes;0:no)
0	1	14	77.8			0.346274	1
1	1	14	70.3			1.411215	
2	3	14	78.5	1957	1305	3.172095	
3	2	14	71.8	1190		3.880029	
4	2	14	86.9	1888		5.06625	
5	1	14	98.3			6.812483	
6	1	14	64.6			7.23253	
7	2	14	82.3	1222		8.558276	
8	1	14	56.6			10.08411	
9	2	14	72.2	1996		11.02679	

Statistics 6 (ChirpCenter Frequency: 5500.0 MHz)

Trial #	Pulse	Chirp(MHz)	Pulse Width (μS)	Pulse 1-2 spacing(μS)	Pulse 2-3 spacing(μS)	Pulse Start(S)	Detection (1:yes;0:no)
0	3	14	99.2	1059	1615	0.696329	1
1	1	14	73.9			1.37839	
2	2	14	89.5	1299		2.467684	
3	1	14	98			3.47565	
4	1	14	71.9			4.148488	
5	2	14	63.9	1169		5.990165	
6	1	14	68.7			6.922395	
7	3	14	76.2	1639	1336	7.869634	
8	2	14	60.5	1319		8.181044	
9	3	14	93.1	1650	1148	9.746451	
10	2	14	74.3	1636		10.79475	
11	3	14	95.5	1332	1701	11.42781	

Statistics 7(ChirpCenter Frequency: 5500.0 MHz)

Trial #	Pulse	Chirp(MHz)	Pulse Width (μS)	Pulse 1-2 spacing(μS)	Pulse 2-3 spacing(μS)	Pulse Start(S)	Detection (1:yes;0:no)
0	2	11	76.4	1933		0.710057	1
1	1	11	53.7			0.883133	
2	1	11	52.9			2.156535	
3	2	11	77.6	1268		3.151846	
4	3	11	71.4	1183	1564	4.265968	
5	2	11	85.8	1720		4.769446	
6	3	11	90.9	1247	1723	5.924309	
7	2	11	96.1	1090		6.145088	
8	1	11	57.1			7.510688	
9	2	11	59.2	1315		8.513303	
10	2	11	74.1	1783		8.853431	
11	1	11	91.5			9.553536	
12	3	11	88.2	1266	1793	10.38084	
13	3	11	83.4	1664	1609	11.91853	

Statistics 8 (ChirpCenter Frequency: 5500.0 MHz)

Trial #	Pulse	Chirp(MHz)	Pulse Width (μS)	Pulse 1-2 spacing(μS)	Pulse 2-3 spacing(μS)	Pulse Start(S)	Detection (1:yes;0:no)
0	2	8	66.4	1977		0.513996	1
1	3	8	90	1233	1682	1.458936	
2	2	8	92.5	1102		2.690643	
3	1	8	90.2			3.955943	
4	1	8	61.4			4.251262	
5	3	8	56.5	1855	1088	5.024496	
6	2	8	72.4	1949		6.11785	
7	2	8	96.4	1272		7.636604	
8	3	8	56.1	1705	1761	8.657573	
9	3	8	63.4	1305	1957	9.332827	
10	2	8	82.5	1714		10.22308	
11	2	8	78.1	1986		11.51616	

Statistics 9 (ChirpCenter Frequency: 5500.0 MHz)

Trial #	Pulse	Chirp(MHz)	Pulse Width (μS)	Pulse 1-2 spacing(μS)	Pulse 2-3 spacing(μS)	Pulse Start(S)	Detection (1:yes;0:no)
0	2	13	90.8	1388		0.512023	1
1	3	13	73.9	1800	1076	1.064254	
2	2	13	64.6	1707		2.067262	
3	2	13	84.6	1475		3.129029	
4	2	13	67.1	1275		4.511254	
5	1	13	67			5.260497	
6	2	13	52.2	1151		6.111322	
7	1	13	83.2			7.225834	
8	3	13	74.8	1833	1990	8.101079	
9	3	13	89.4	1734	1473	8.819228	
10	2	13	74.1	1727		9.32472	
11	2	13	58.4	1133		10.89054	
12	3	13	95.9	1816	1380	11.26573	

Statistics 10 (ChirpCenter Frequency: 5500.0 MHz)

Trial #	Pulse	Chirp(MHz)	Pulse Width (μS)	Pulse 1-2 spacing(μS)	Pulse 2-3 spacing(μS)	Pulse Start(S)	Detection (1:yes;0:no)
0	3	6	53.5	1088	1251	0.442793	1
1	3	6	56.3	1833	1262	0.818857	
2	2	6	96.8	1338		1.43538	
3	1	6	98.8			2.516921	
4	1	6	82.8			2.884397	
5	2	6	97.4	1832		3.935126	
6	3	6	84.2	1822	1212	4.439979	
7	3	6	64.8	1035	1830	5.304358	
8	3	6	90.6	1231	1481	5.869833	
9	2	6	82.6	1757		6.801399	
10	2	6	86.7	1534		7.57259	
11	2	6	91.3	1058		8.062339	
12	2	6	80.3	1547		8.733942	
13	2	6	67.9	1520		9.635751	
14	3	6	51.3	1184	1616	10.18243	
15	2	6	55.9	1188		10.99113	
16	1	6	55.9			11.87487	

Radar Type 5 Case 2 Statistical Performance

Statistics 1 (ChirpCenter Frequency: 5498.0 MHz)

Trial #	Pulse	Chirp(MHz)	Pulse Width (μS)	Pulse 1-2 spacing(μS)	Pulse 2-3 spacing(μS)	Pulse Start(S)	Detection (1:yes;0:no)
0	1	19	89.9			0.146142	1
1	2	19	82.9	1301		1.579626	
2	3	19	84.6	1537	1542	1.856966	
3	2	19	65.8	1333		3.309025	
4	2	19	57.9	1230		3.803173	
5	2	19	64.9	1728		4.591058	
6	1	19	95.1			5.509565	
7	2	19	86.2	1075		6.392553	
8	3	19	89.8	1776	1948	7.487263	
9	1	19	54.9			8.241282	
10	1	19	90.3			8.703094	
11	1	19	50.9			9.821185	
12	3	19	82.7	1427	1483	10.82091	
13	3	19	75.5	1118	1041	11.63664	

Statistics 2 (ChirpCenter Frequency: 5492.0 MHz)

Trial #	Pulse	Chirp(MHz)	Pulse Width (μS)	Pulse 1-2 spacing(μS)	Pulse 2-3 spacing(μS)	Pulse Start(S)	Detection (1:yes;0:no)
0	2	5	92.5	1564		0.056842	1
1	1	5	90.7			0.713556	
2	1	5	56.3			1.546353	
3	3	5	98.4	1832	1542	2.359883	
4	3	5	54.7	1508	1434	3.142227	
5	3	5	96.1	1642	1091	3.165988	
6	2	5	76.4	1939		4.055698	
7	2	5	63.3	1604		4.764008	
8	1	5	70.2			5.336284	
9	2	5	53.9	1287		6.220028	
10	1	5	63.5			6.386035	
11	1	5	64.8			7.480755	
12	2	5	98.4	1504		8.103519	
13	2	5	74.8	1502		8.638132	
14	2	5	54.1	1945		9.368921	
15	1	5	54.1			9.949463	
16	2	5	83.4	1806		10.26694	
17	3	5	58.7	1060	1088	10.97241	
18	2	5	86.8	1969		11.86491	

Statistics 3 (ChirpCenter Frequency: 5496.0 MHz)

Trial #	Pulse	Chirp(MHz)	Pulse Width (µS)	Pulse 1-2 spacing(µS)	Pulse 2-3 spacing(µS)	Pulse Start(S)	Detection (1:yes;0:no)
0	3	15	99.3	1171	1654	0.634085	1
1	2	15	66.2	1514		1.914854	
2	1	15	98.6			2.602827	
3	3	15	50.9	1468	1264	3.226183	
4	2	15	72.5	1123		4.178851	
5	1	15	50.8			5.685152	
6	2	15	63.1	1828		6.644851	
7	2	15	54.8	1225		7.416259	
8	2	15	51.8	1555		8.236377	
9	1	15	77.1			9.742636	
10	2	15	97.6	1328		10.38455	
11	3	15	96.1	1728	1152	11.89809	

Statistics 4 (ChirpCenter Frequency: 5498.0 MHz)

Trial #	Pulse	Chirp(MHz)	Pulse Width (µS)	Pulse 1-2 spacing(µS)	Pulse 2-3 spacing(µS)	Pulse Start(S)	Detection (1:yes;0:no)
0	2	19	67.5	1493		0.591077	1
1	3	19	89.9	1199	1823	1.177029	
2	1	19	70.6			2.154394	
3	2	19	75.1	1073		2.781346	
4	2	19	70.1	1543		3.713435	
5	3	19	76.9	1713	1316	4.341661	
6	2	19	86.6	1877		4.769558	
7	3	19	65.5	1485	1758	5.70888	
8	1	19	56			6.636018	
9	1	19	50.7			7.477505	
10	2	19	64.2	1312		8.00161	
11	3	19	59.1	1525	1818	8.947219	
12	2	19	93.2	1493		9.18984	
13	3	19	93	1016	1087	9.78972	
14	3	19	63.8	1051	1722	11.11191	
15	2	19	76.7	1668		11.44002	

Statistics 5 (ChirpCenter Frequency: 5498.0 MHz)

Trial #	Pulse	Chirp(MHz)	Pulse Width (µS)	Pulse 1-2 spacing(µS)	Pulse 2-3 spacing(µS)	Pulse Start(S)	Detection (1:yes;0:no)
0	1	20	92.8			0.037105	1
1	3	20	76.6	1178	1380	0.725083	
2	2	20	52.1	1261		1.982838	
3	2	20	95.6	1379		2.194775	
4	2	20	78.2	1616		2.92206	
5	3	20	79.1	1844	1338	4.036495	
6	2	20	88	1756		4.835174	
7	3	20	63.1	1874	1674	5.230023	
8	3	20	91.2	1102	1541	6.091367	
9	2	20	52.4	1624		6.661705	
10	3	20	75.8	1531	1550	7.193653	
11	2	20	56.1	1910		8.298341	
12	1	20	85.8			8.75517	
13	2	20	64.8	1438		9.812419	
14	3	20	96.1	1803	1763	10.36062	
15	2	20	82.4	1363		10.97065	
16	3	20	70.6	1164	1151	11.97276	

Statistics 6 (ChirpCenter Frequency: 5496.0 MHz)

Trial #	Pulse	Chirp(MHz)	Pulse Width (µS)	Pulse 1-2 spacing(µS)	Pulse 2-3 spacing(µS)	Pulse Start(S)	Detection (1:yes;0:no)
0	3	14	58.6	1068	1011	0.333654	1
1	2	14	58.3	1329		1.111371	
2	2	14	75.2	1700		1.570638	
3	1	14	59.5			2.030231	
4	1	14	83.1			2.401863	
5	2	14	82.1	1996		3.09541	
6	2	14	72.2	1352		4.018532	
7	3	14	76.2	1998	1235	4.205245	
8	2	14	85.7	1756		4.872958	
9	2	14	69.4	1787		5.753298	
10	1	14	54			6.260725	
11	2	14	51.7	1350		6.729358	
12	3	14	71.6	1895	1927	7.745641	
13	2	14	88.9	1705		8.259831	
14	3	14	94.4	1237	1277	8.660714	
15	3	14	95.5	1689	1950	9.038734	
16	2	14	59.5	1269		10.07384	
17	1	14	56.2			10.55938	
18	1	14	61.2			11.16867	
19	2	14	92.4	1719		11.77264	

Statistics 7 (ChirpCenter Frequency: 5493.0 MHz)

Trial #	Pulse	Chirp(MHz)	Pulse Width (μS)	Pulse 1-2 spacing(uS)	Pulse 2-3 spacing(uS)	Pulse Start(S)	Detection (1:yes;0:no)
0	1	7	60.8			0.05924	1
1	1	7	98.3			2.338271	
2	3	7	81.7	1658	1525	3.241231	
3	3	7	78.8	1465	1205	4.57797	
4	2	7	79.4	1223		5.636003	
5	2	7	73.4	1959		7.767773	
6	3	7	76.4	1110	1530	8.476147	
7	1	7	52.7			10.55938	
8	2	7	60.3	1654		11.48194	

Statistics 8 (ChirpCenter Frequency: 5494.0 MHz)

Trial #	Pulse	Chirp(MHz)	Pulse Width (μS)	Pulse 1-2 spacing(μS)	Pulse 2-3 spacing(μS)	Pulse Start(S)	Detection (1:yes;0:no)
0	2	9	66.3	1441		0.737784	1
1	2	9	74.5	1095		2.063488	
2	1	9	52.7			3.078212	
3	1	9	96.7			3.838423	
4	3	9	50.6	1905	1461	5.801993	
5	2	9	77.8	1054		6.836721	
6	2	9	74.3	1283		7.939788	
7	1	9	58.2			8.952503	
8	3	9	61.5	1444	1670	10.07873	
9	2	9	99.3	1998		10.93591	

Statistics 9 (ChirpCenter Frequency: 5498.0 MHz)

Trial #	Pulse	Chirp(MHz)	Pulse Width (μS)	Pulse 1-2 spacing(μS)	Pulse 2-3 spacing(μS)	Pulse Start(S)	Detection (1:yes;0:no)
0	3	19	80.3	1561	1901	0.476995	1
1	1	19	97.8			1.56038	
2	2	19	91.9	1075		3.034491	
3	2	19	59.6	1804		4.264052	
4	3	19	79.8	1211	1001	5.602011	
5	2	19	71.8	1493		6.09921	
6	3	19	93.7	1925	1822	8.012548	
7	2	19	78	1346		8.81584	
8	3	19	67.2	1284	1795	9.720089	
9	2	19	92.4	1616		11.19397	

Statistics 10 (ChirpCenter Frequency: 5493.0 MHz)

Trial #	Pulse	Chirp(MHz)	Pulse Width (µS)	Pulse 1-2 spacing(µS)	Pulse 2-3 spacing(µS)	Pulse Start(S)	Detection (1:yes;0:no)
0	1	7	67.3			0.508245	1
1	2	7	66.4	1737		0.906457	
2	2	7	84.7	1530		1.410528	
3	1	7	54.8			2.436774	
4	2	7	63.7	1203		3.034922	
5	3	7	98.5	1799	1164	3.305549	
6	2	7	86	1450		4.322779	
7	2	7	73.3	1392		4.973355	
8	2	7	94.3	1863		5.335316	
9	2	7	55.5	1148		5.777296	
10	3	7	51.9	1143	1860	6.422147	
11	2	7	93.3	1999		7.224745	
12	2	7	91.4	1319		7.789574	
13	1	7	51.1			8.742744	
14	2	7	83.2	1467		9.255543	
15	2	7	76.5	1531		9.937183	
16	3	7	81.2	1928	1454	10.22702	
17	2	7	53	1948		11.19712	
18	2	7	73.2	1745		11.46748	

Radar Type 5 Case 3 Statistical Performance

Statistics 1 (ChirpCenter Frequency: 5506.0 MHz)

Trial #	Pulse	Chirp(MHz)	Pulse Width (µS)	Pulse 1-2 spacing(µS)	Pulse 2-3 spacing(µS)	Pulse Start(S)	Detection (1:yes;0:no)
0	1	9	56.3			0.221699	1
1	2	9	76.2	1006		0.891931	
2	1	9	76.3			2.145243	
3	2	9	91.4	1300		3.316562	
4	3	9	61.9	1393	1865	4.232533	
5	3	9	71.7	1976	1384	5.078395	
6	2	9	95.5	1848		5.249019	
7	1	9	84.3			6.657689	
8	1	9	61.5			7.352787	
9	1	9	80.9			7.750069	
10	2	9	85	1969		9.360547	
11	2	9	65.7	1974		10.08345	
12	1	9	80.1			10.61697	
13	2	9	56.4	1581		11.20241	

Statistics 2 (ChirpCenter Frequency: 5508.0 MHz)

Trial #	Pulse	Chirp(MHz)	Pulse Width (μS)	Pulse 1-2 spacing(μS)	Pulse 2-3 spacing(μS)	Pulse Start(S)	Detection (1:yes;0:no)
0	3	5	51.4	1394	1848	0.068911	1
1	2	5	95.7	1561		1.493866	
2	2	5	91.2	1396		2.254823	
3	3	5	70	1248	1680	3.435071	
4	2	5	83	1182		4.536828	
5	2	5	77.7	1112		5.155395	
6	1	5	77.7			6.109229	
7	1	5	66.3			7.113216	
8	2	5	71.6	1118		7.558492	
9	1	5	62.2			8.342814	
10	1	5	70.5			9.900522	
11	2	5	51.4	1732		10.43797	
12	2	5	50.9	1424		11.59093	

Statistics 3 (ChirpCenter Frequency: 5506.0 MHz)

Trial #	Pulse	Chirp(MHz)	Pulse Width (μS)	Pulse 1-2 spacing(μS)	Pulse 2-3 spacing(μS)	Pulse Start(S)	Detection (1:yes;0:no)
0	2	10	85.6	1504		0.788151	1
1	3	10	99.3	1970	1246	1.706396	
2	1	10	96.2			2.317366	
3	2	10	87.8	1435		3.054909	
4	2	10	94.8	1341		4.185599	
5	3	10	97.6	1775	1101	5.213142	
6	2	10	94.8	1352		5.739119	
7	3	10	93.1	1893	1484	6.845251	
8	2	10	95.1	1360		7.829228	
9	1	10	56			8.707837	
10	3	10	54	1370	1621	9.678336	
11	2	10	65	1523		11.03627	
12	3	10	60.1	1053	1243	11.63291	

Statistics 4 (ChirpCenter Frequency: 5508.0 MHz)

Trial #	Pulse	Chirp(MHz)	Pulse Width (μS)	Pulse 1-2 spacing(μS)	Pulse 2-3 spacing(μS)	Pulse Start(S)	Detection (1:yes;0:no)
0	3	10	57	1928	1194	0.445046	1
1	2	10	70.5	1701		0.693904	
2	3	10	78.8	1350	1999	1.966786	
3	3	10	52.1	1285	1068	2.014853	
4	3	10	97.4	1444	1406	3.094531	
5	2	10	63.4	1960		3.758641	
6	1	10	79.5			4.296129	
7	3	10	68.7	1063	1539	5.063658	
8	3	10	80	1238	1937	5.878575	
9	2	10	92.8	1266		6.601679	
10	2	10	51.8	1027		7.050874	
11	2	10	89.5	1931		7.704453	
12	2	10	83.4	1949		8.380808	
13	2	10	73.1	1734		9.144924	
14	2	10	69.4	1520		9.482326	
15	2	10	66.1	1894		10.63286	
16	3	10	61.3	1936	1935	11.23245	
17	1	10	94.7			11.64594	

Statistics 5 (ChirpCenter Frequency: 5508.0 MHz)

Trial #	Pulse	Chirp(MHz)	Pulse Width (μS)	Pulse 1-2 spacing(μS)	Pulse 2-3 spacing(μS)	Pulse Start(S)	Detection (1:yes;0:no)
0	2	6	78.8	1028		0.513084	1
1	3	6	90.4	1888	1034	0.853988	
2	2	6	70.2	1666		1.530507	
3	1	6	89.1			2.564416	
4	2	6	89.1	1445		3.449372	
5	1	6	66.3			3.713081	
6	2	6	72.8	1572		4.521783	
7	3	6	98.8	1979	1289	5.336983	
8	2	6	87.7	1847		5.796985	
9	2	6	61.2	1087		6.650696	
10	2	6	84.7	1853		7.465766	
11	2	6	73.3	1844		7.765271	
12	2	6	98.4	1771		8.690278	
13	2	6	56.3	1481		9.255451	
14	2	6	82.3	1114		9.888312	
15	3	6	76.7	1005	1163	10.59242	
16	2	6	60.5	1614		11.32689	

Statistics 6 (ChirpCenter Frequency: 5504.0 MHz)

Trial #	Pulse	Chirp(MHz)	Pulse Width (μ S)	Pulse 1-2 spacing(μ S)	Pulse 2-3 spacing(μ S)	Pulse Start(S)	Detection (1:yes;0:no)
0	2	16	57.3	1336		0.520795	1
1	1	16	98.8			1.876879	
2	1	16	81.9			3.107745	
3	3	16	71.2	1441	1109	3.637173	
4	1	16	52.5			5.445438	
5	2	16	71.1	1843		6.372665	
6	3	16	93	1365	1896	7.902752	
7	3	16	61.2	1668	1258	9.361084	
8	2	16	75.9	1096		10.66259	
9	3	16	63.8	1419	1162	11.81404	

Statistics 7 (ChirpCenter Frequency: 5505.0 MHz)

Trial #	Pulse	Chirp(MHz)	Pulse Width (μ S)	Pulse 1-2 spacing(μ S)	Pulse 2-3 spacing(μ S)	Pulse Start(S)	Detection (1:yes;0:no)
0	2	13	90.8	1133		0.344719	1
1	3	13	78.1	1390	1454	0.615629	
2	2	13	89.5	1594		1.612369	
3	2	13	59.3	1974		1.874177	
4	2	13	93.8	1109		2.47115	
5	2	13	69.6	1172		3.036067	
6	2	13	81.6	1003		3.740122	
7	2	13	55.5	1902		4.558799	
8	1	13	72.2			5.119806	
9	3	13	90.5	1767	1355	5.610505	
10	3	13	95.2	1391	1171	6.196101	
11	2	13	91.6	1017		6.697039	
12	2	13	98.8	1868		7.366631	
13	2	13	91.3	1139		8.003051	
14	2	13	88.9	1986		8.690274	
15	1	13	95.7			9.452819	
16	3	13	63	1054	1512	9.604143	
17	1	13	75.3			10.45893	
18	1	13	74.6			11.04685	
19	2	13	56.4	1448		11.45877	

Statistics 8 (ChirpCenter Frequency: 5504.0 MHz)

Trial #	Pulse	Chirp(MHz)	Pulse Width (μS)	Pulse 1-2 spacing(μS)	Pulse 2-3 spacing(μS)	Pulse Start(S)	Detection (1:yes;0:no)
0	2	15	93.7	1287		0.114191	1
1	2	15	50.4	1267		1.024155	
2	2	15	53.8	1665		1.997832	
3	3	15	55.2	1120	1189	2.294883	
4	2	15	59.4	1933		3.088793	
5	3	15	96.8	1283	1721	4.209567	
6	3	15	59.4	1915	1757	4.413045	
7	3	15	50.6	1847	1942	5.079767	
8	2	15	95.5	1783		5.915606	
9	3	15	64.9	1584	1749	6.795499	
10	1	15	54.6			7.073959	
11	2	15	94.1	1969		7.945129	
12	2	15	86.2	1600		9.131421	
13	2	15	95.8	1230		9.409155	
14	1	15	64.1			10.52153	
15	1	15	65.5			10.60902	
16	3	15	71.8	1231	1978	11.71676	

Statistics 9 (ChirpCenter Frequency: 5504.0 MHz)

Trial #	Pulse	Chirp(MHz)	Pulse Width (μS)	Pulse 1-2 spacing(μS)	Pulse 2-3 spacing(μS)	Pulse Start(S)	Detection (1:yes;0:no)
0	1	15	92.7			0.75063	1
1	2	15	65.3	1896		1.252024	
2	2	15	95	1658		2.262579	
3	2	15	51.2	1077		3.44486	
4	1	15	77			4.024667	
5	1	15	99.9			4.674428	
6	2	15	93.4	1499		6.181214	
7	2	15	55.8	1260		6.658876	
8	2	15	54.9	1275		7.950178	
9	2	15	78.8	1879		8.735443	
10	1	15	75.1			9.65256	
11	1	15	99.5			10.74832	
12	3	15	81.5	1139	1620	11.73608	

Statistics 10 (ChirpCenter Frequency: 5504.0 MHz)

Trial #	Pulse	Chirp(MHz)	Pulse Width (µS)	Pulse 1-2 spacing(µS)	Pulse 2-3 spacing(µS)	Pulse Start(S)	Detection (1:yes;0:no)
0	2	16	57.5	1917		0.212383	1
1	2	16	57.1	1640		1.132002	
2	2	16	91.4	1634		2.010113	
3	2	16	96	1511		2.403781	
4	2	16	77.2	1639		3.768331	
5	2	16	71.2	1942		4.16948	
6	1	16	78.1			5.246366	
7	2	16	90.5	1379		6.289807	
8	2	16	55.7	1833		6.657213	
9	1	16	92.3			7.741053	
10	2	16	52.9	1327		8.060645	
11	3	16	72.4	1163	1280	9.50072	
12	3	16	66.7	1697	1079	10.2303	
13	2	16	78.8	1799		10.89907	
14	3	16	57.4	1322	1926	11.70933	

Radar Type 6 Statistical Performance

Trial #	Fc (MHz)	Pulse /Burst	Pulse Width (µS)	PRI (µs)	Detection (1:yes; 0:no)	Hopping Sequence (MHz)
1	5500	9	1	333	1	5544.0, 5633.0, 5627.0, 5621.0, 5324.0, 5585.0, 5459.0, 5690.0, 5419.0, 5296.0, 5606.0, 5565.0, 5262.0, 5662.0, 5629.0, 5433.0, 5416.0, 5511.0, 5564.0, 5672.0, 5453.0, 5572.0, 5665.0, 5575.0, 5582.0, 5603.0, 5279.0, 5397.0, 5623.0, 5705.0, 5365.0, 5345.0, 5655.0, 5709.0, 5501.0, 5437.0, 5516.0, 5529.0, 5578.0, 5547.0, 5711.0, 5499.0, 5594.0, 5643.0, 5382.0, 5330.0, 5658.0, 5389.0, 5287.0, 5468.0, 5430.0, 5332.0, 5589.0, 5609.0, 5504.0, 5556.0, 5267.0, 5510.0, 5408.0, 5571.0, 5284.0, 5392.0, 5318.0, 5488.0, 5616.0, 5413.0, 5489.0, 5277.0, 5290.0, 5361.0, 5301.0, 5596.0, 5599.0, 5586.0, 5264.0, 5562.0, 5353.0, 5325.0, 5689.0, 5651.0, 5701.0, 5341.0, 5619.0, 5475.0, 5294.0, 5559.0, 5520.0, 5680.0, 5702.0, 5591.0, 5545.0, 5422.0, 5387.0, 5411.0, 5356.0, 5666.0, 5588.0, 5714.0, 5478.0, 5506.0 (number of hits: 4)
2	5500	9	1	333	1	5589.0, 5470.0, 5577.0, 5546.0, 5318.0, 5370.0, 5640.0, 5638.0, 5525.0, 5559.0, 5533.0, 5722.0, 5381.0, 5626.0, 5664.0, 5592.0, 5386.0, 5679.0, 5630.0, 5527.0, 5384.0, 5572.0, 5334.0, 5327.0, 5645.0, 5606.0, 5680.0, 5704.0, 5627.0, 5636.0, 5393.0, 5682.0, 5710.0, 5367.0, 5502.0, 5336.0, 5311.0, 5364.0, 5285.0, 5369.0, 5424.0, 5273.0, 5687.0, 5348.0, 5558.0, 5624.0, 5703.0, 5684.0, 5665.0, 5404.0,

						5341.0, 5484.0, 5447.0, 5416.0, 5283.0, 5250.0, 5567.0, 5380.0, 5695.0, 5515.0, 5465.0, 5671.0, 5426.0, 5661.0, 5708.0, 5444.0, 5259.0, 5602.0, 5691.0, 5375.0, 5677.0, 5544.0, 5473.0, 5697.0, 5663.0, 5522.0, 5583.0, 5611.0, 5323.0, 5511.0, 5706.0, 5329.0, 5383.0, 5512.0, 5646.0, 5443.0, 5307.0, 5358.0, 5328.0, 5714.0, 5536.0, 5332.0, 5547.0, 5382.0, 5692.0, 5418.0, 5498.0, 5618.0, 5258.0, 5647.0 (number of hits: 2)
3	5500	9	1	333	1	5577.0, 5312.0, 5647.0, 5426.0, 5633.0, 5390.0, 5649.0, 5594.0, 5499.0, 5449.0, 5691.0, 5459.0, 5524.0, 5513.0, 5653.0, 5576.0, 5323.0, 5431.0, 5308.0, 5505.0, 5680.0, 5474.0, 5445.0, 5615.0, 5424.0, 5458.0, 5515.0, 5334.0, 5275.0, 5545.0, 5442.0, 5566.0, 5598.0, 5674.0, 5584.0, 5491.0, 5526.0, 5623.0, 5273.0, 5564.0, 5537.0, 5662.0, 5651.0, 5710.0, 5494.0, 5418.0, 5251.0, 5302.0, 5259.0, 5253.0, 5385.0, 5645.0, 5546.0, 5690.0, 5531.0, 5332.0, 5444.0, 5289.0, 5375.0, 5602.0, 5462.0, 5369.0, 5632.0, 5718.0, 5472.0, 5417.0, 5657.0, 5695.0, 5403.0, 5280.0, 5603.0, 5702.0, 5549.0, 5570.0, 5664.0, 5522.0, 5675.0, 5480.0, 5504.0, 5589.0, 5550.0, 5532.0, 5596.0, 5661.0, 5534.0, 5556.0, 5319.0, 5689.0, 5630.0, 5440.0, 5411.0, 5396.0, 5507.0, 5685.0, 5282.0, 5271.0, 5555.0, 5371.0, 5509.0, 5593.0 (number of hits: 7)
4	5500	9	1	333	1	5336.0, 5355.0, 5615.0, 5657.0, 5548.0, 5475.0, 5568.0, 5296.0, 5688.0, 5466.0, 5438.0, 5344.0, 5363.0, 5287.0, 5710.0, 5704.0, 5478.0, 5597.0, 5589.0, 5641.0, 5277.0, 5360.0, 5571.0, 5700.0, 5693.0, 5284.0, 5642.0, 5628.0, 5619.0, 5699.0, 5644.0, 5354.0, 5603.0, 5600.0, 5388.0, 5522.0, 5632.0, 5358.0, 5387.0, 5392.0, 5554.0, 5581.0, 5690.0, 5274.0, 5341.0, 5308.0, 5400.0, 5534.0, 5489.0, 5588.0, 5383.0, 5419.0, 5560.0, 5574.0, 5261.0, 5723.0, 5371.0, 5698.0, 5684.0, 5662.0, 5375.0, 5667.0, 5401.0, 5604.0, 5450.0, 5257.0, 5362.0, 5514.0, 5413.0, 5633.0, 5486.0, 5300.0, 5502.0, 5443.0, 5617.0, 5445.0, 5545.0, 5348.0, 5602.0, 5444.0, 5509.0, 5706.0, 5269.0, 5367.0, 5270.0, 5549.0, 5670.0, 5262.0, 5529.0, 5320.0, 5639.0, 5692.0, 5430.0, 5252.0, 5668.0, 5464.0, 5611.0, 5521.0, 5328.0, 5679.0 (number of hits: 2)
5	5500	9	1	333	1	5300.0, 5615.0, 5551.0, 5671.0, 5708.0, 5289.0, 5348.0, 5389.0, 5711.0, 5667.0, 5560.0, 5279.0, 5594.0, 5305.0, 5633.0, 5416.0, 5310.0, 5511.0, 5466.0, 5565.0, 5404.0, 5568.0, 5399.0, 5506.0, 5470.0, 5714.0, 5282.0, 5523.0, 5351.0, 5270.0, 5341.0, 5299.0, 5328.0, 5643.0, 5716.0,

						5383.0, 5295.0, 5596.0, 5448.0, 5509.0, 5378.0, 5455.0, 5515.0, 5480.0, 5639.0, 5288.0, 5621.0, 5433.0, 5340.0, 5274.0, 5355.0, 5600.0, 5402.0, 5496.0, 5290.0, 5324.0, 5538.0, 5461.0, 5537.0, 5649.0, 5421.0, 5645.0, 5555.0, 5648.0, 5532.0, 5660.0, 5699.0, 5579.0, 5611.0, 5666.0, 5567.0, 5315.0, 5521.0, 5447.0, 5419.0, 5444.0, 5487.0, 5641.0, 5450.0, 5394.0, 5673.0, 5268.0, 5488.0, 5333.0, 5335.0, 5322.0, 5293.0, 5689.0, 5616.0, 5585.0, 5379.0, 5286.0, 5507.0, 5453.0, 5427.0, 5593.0, 5438.0, 5297.0, 5303.0, 5571.0 (number of hits: 4)
6	5500	9	1	333	1	5484.0, 5648.0, 5477.0, 5442.0, 5649.0, 5397.0, 5383.0, 5256.0, 5318.0, 5414.0, 5374.0, 5264.0, 5634.0, 5640.0, 5599.0, 5576.0, 5270.0, 5287.0, 5303.0, 5564.0, 5695.0, 5653.0, 5628.0, 5563.0, 5545.0, 5607.0, 5302.0, 5295.0, 5432.0, 5671.0, 5633.0, 5517.0, 5410.0, 5685.0, 5700.0, 5669.0, 5460.0, 5480.0, 5548.0, 5280.0, 5641.0, 5692.0, 5526.0, 5536.0, 5713.0, 5473.0, 5311.0, 5595.0, 5598.0, 5289.0, 5389.0, 5269.0, 5317.0, 5290.0, 5639.0, 5597.0, 5433.0, 5492.0, 5504.0, 5630.0, 5586.0, 5604.0, 5347.0, 5277.0, 5716.0, 5448.0, 5667.0, 5364.0, 5562.0, 5377.0, 5500.0, 5556.0, 5359.0, 5635.0, 5534.0, 5636.0, 5613.0, 5510.0, 5416.0, 5292.0, 5612.0, 5425.0, 5585.0, 5525.0, 5676.0, 5486.0, 5588.0, 5629.0, 5288.0, 5566.0, 5441.0, 5452.0, 5506.0, 5584.0, 5396.0, 5542.0, 5476.0, 5646.0, 5575.0, 5475.0 (number of hits: 4)
7	5500	9	1	333	1	5504.0, 5313.0, 5432.0, 5489.0, 5537.0, 5288.0, 5284.0, 5274.0, 5526.0, 5540.0, 5709.0, 5666.0, 5522.0, 5363.0, 5371.0, 5395.0, 5397.0, 5668.0, 5595.0, 5546.0, 5289.0, 5717.0, 5330.0, 5541.0, 5374.0, 5706.0, 5452.0, 5631.0, 5344.0, 5591.0, 5624.0, 5435.0, 5708.0, 5694.0, 5298.0, 5608.0, 5257.0, 5340.0, 5683.0, 5521.0, 5680.0, 5409.0, 5303.0, 5509.0, 5427.0, 5369.0, 5457.0, 5464.0, 5456.0, 5693.0, 5527.0, 5539.0, 5503.0, 5573.0, 5570.0, 5532.0, 5305.0, 5711.0, 5279.0, 5600.0, 5572.0, 5517.0, 5443.0, 5523.0, 5613.0, 5658.0, 5470.0, 5705.0, 5283.0, 5448.0, 5524.0, 5387.0, 5277.0, 5394.0, 5606.0, 5339.0, 5406.0, 5357.0, 5622.0, 5315.0, 5691.0, 5314.0, 5604.0, 5461.0, 5712.0, 5578.0, 5718.0, 5646.0, 5657.0, 5632.0, 5316.0, 5507.0, 5439.0, 5398.0, 5258.0, 5587.0, 5681.0, 5594.0, 5588.0, 5617.0 (number of hits: 4)
8	5500	9	1	333	1	5568.0, 5630.0, 5524.0, 5704.0, 5252.0, 5463.0, 5633.0, 5614.0, 5607.0, 5396.0, 5616.0, 5611.0, 5356.0, 5470.0, 5569.0, 5367.0, 5526.0, 5517.0, 5588.0, 5719.0,

						5662.0, 5404.0, 5687.0, 5489.0, 5397.0, 5694.0, 5590.0, 5479.0, 5716.0, 5565.0, 5532.0, 5328.0, 5551.0, 5482.0, 5302.0, 5667.0, 5452.0, 5460.0, 5327.0, 5605.0, 5483.0, 5383.0, 5549.0, 5492.0, 5269.0, 5714.0, 5510.0, 5493.0, 5550.0, 5566.0, 5559.0, 5380.0, 5357.0, 5718.0, 5711.0, 5296.0, 5643.0, 5594.0, 5522.0, 5585.0, 5281.0, 5721.0, 5368.0, 5414.0, 5364.0, 5655.0, 5440.0, 5461.0, 5272.0, 5670.0, 5593.0, 5690.0, 5674.0, 5712.0, 5720.0, 5619.0, 5506.0, 5264.0, 5699.0, 5624.0, 5254.0, 5642.0, 5644.0, 5618.0, 5338.0, 5456.0, 5577.0, 5629.0, 5684.0, 5285.0, 5431.0, 5466.0, 5303.0, 5343.0, 5322.0, 5578.0, 5575.0, 5570.0, 5388.0, 5347.0 (number of hits: 3)
9	5500	9	1	333	1	5332.0, 5702.0, 5597.0, 5715.0, 5337.0, 5472.0, 5714.0, 5678.0, 5414.0, 5688.0, 5577.0, 5521.0, 5331.0, 5507.0, 5400.0, 5629.0, 5696.0, 5593.0, 5707.0, 5433.0, 5427.0, 5348.0, 5325.0, 5285.0, 5682.0, 5570.0, 5415.0, 5432.0, 5479.0, 5300.0, 5569.0, 5454.0, 5580.0, 5360.0, 5535.0, 5571.0, 5545.0, 5642.0, 5306.0, 5281.0, 5693.0, 5428.0, 5527.0, 5344.0, 5488.0, 5718.0, 5541.0, 5445.0, 5589.0, 5505.0, 5490.0, 5468.0, 5705.0, 5390.0, 5250.0, 5594.0, 5301.0, 5612.0, 5455.0, 5565.0, 5650.0, 5647.0, 5418.0, 5586.0, 5402.0, 5579.0, 5469.0, 5408.0, 5534.0, 5501.0, 5557.0, 5459.0, 5464.0, 5330.0, 5282.0, 5655.0, 5262.0, 5335.0, 5385.0, 5266.0, 5267.0, 5592.0, 5533.0, 5371.0, 5423.0, 5475.0, 5277.0, 5374.0, 5397.0, 5484.0, 5634.0, 5625.0, 5462.0, 5437.0, 5703.0, 5478.0, 5255.0, 5626.0, 5446.0, 5441.0 (number of hits: 4)
10	5500	9	1	333	1	5332.0, 5702.0, 5597.0, 5715.0, 5337.0, 5472.0, 5714.0, 5678.0, 5414.0, 5688.0, 5577.0, 5521.0, 5331.0, 5507.0, 5400.0, 5629.0, 5696.0, 5593.0, 5707.0, 5433.0, 5427.0, 5348.0, 5325.0, 5285.0, 5682.0, 5570.0, 5415.0, 5432.0, 5479.0, 5300.0, 5569.0, 5454.0, 5580.0, 5360.0, 5535.0, 5571.0, 5545.0, 5642.0, 5306.0, 5281.0, 5693.0, 5428.0, 5527.0, 5344.0, 5488.0, 5718.0, 5541.0, 5445.0, 5589.0, 5505.0, 5490.0, 5468.0, 5705.0, 5390.0, 5250.0, 5594.0, 5301.0, 5612.0, 5455.0, 5565.0, 5650.0, 5647.0, 5418.0, 5586.0, 5402.0, 5579.0, 5469.0, 5408.0, 5534.0, 5501.0, 5557.0, 5459.0, 5464.0, 5330.0, 5282.0, 5655.0, 5262.0, 5335.0, 5385.0, 5266.0, 5267.0, 5592.0, 5533.0, 5371.0, 5423.0, 5475.0, 5277.0, 5374.0, 5397.0, 5484.0, 5634.0, 5625.0, 5462.0, 5437.0, 5703.0, 5478.0, 5255.0, 5626.0, 5446.0, 5441.0 (number of hits: 4)
11	5500	9	1	333	1	5705.0, 5268.0, 5359.0, 5651.0, 5515.0,

						5461.0, 5350.0, 5629.0, 5380.0, 5579.0, 5678.0, 5496.0, 5531.0, 5455.0, 5325.0, 5279.0, 5552.0, 5417.0, 5655.0, 5715.0, 5374.0, 5614.0, 5370.0, 5362.0, 5344.0, 5550.0, 5324.0, 5653.0, 5507.0, 5410.0, 5605.0, 5489.0, 5322.0, 5379.0, 5569.0, 5333.0, 5377.0, 5562.0, 5492.0, 5529.0, 5517.0, 5546.0, 5645.0, 5435.0, 5662.0, 5574.0, 5721.0, 5392.0, 5525.0, 5607.0, 5423.0, 5361.0, 5270.0, 5450.0, 5609.0, 5563.0, 5434.0, 5457.0, 5319.0, 5580.0, 5717.0, 5396.0, 5341.0, 5381.0, 5298.0, 5690.0, 5414.0, 5723.0, 5282.0, 5689.0, 5468.0, 5621.0, 5539.0, 5471.0, 5453.0, 5520.0, 5330.0, 5442.0, 5675.0, 5500.0, 5536.0, 5591.0, 5360.0, 5334.0, 5388.0, 5677.0, 5411.0, 5627.0, 5528.0, 5295.0, 5523.0, 5347.0, 5472.0, 5395.0, 5368.0, 5419.0, 5464.0, 5446.0, 5320.0, 5716.0 (number of hits: 4)
12	5500	9	1	333	1	5598.0, 5650.0, 5345.0, 5572.0, 5423.0, 5715.0, 5362.0, 5485.0, 5264.0, 5564.0, 5499.0, 5294.0, 5359.0, 5676.0, 5395.0, 5471.0, 5574.0, 5580.0, 5456.0, 5594.0, 5421.0, 5418.0, 5616.0, 5690.0, 5385.0, 5514.0, 5642.0, 5647.0, 5656.0, 5337.0, 5477.0, 5670.0, 5613.0, 5306.0, 5450.0, 5669.0, 5682.0, 5546.0, 5257.0, 5622.0, 5570.0, 5272.0, 5276.0, 5718.0, 5602.0, 5368.0, 5422.0, 5600.0, 5382.0, 5635.0, 5638.0, 5723.0, 5361.0, 5371.0, 5369.0, 5545.0, 5593.0, 5315.0, 5375.0, 5634.0, 5328.0, 5381.0, 5339.0, 5478.0, 5452.0, 5299.0, 5298.0, 5506.0, 5495.0, 5453.0, 5334.0, 5308.0, 5404.0, 5417.0, 5374.0, 5347.0, 5461.0, 5702.0, 5281.0, 5400.0, 5571.0, 5541.0, 5644.0, 5619.0, 5591.0, 5280.0, 5674.0, 5484.0, 5567.0, 5457.0, 5724.0, 5581.0, 5319.0, 5556.0, 5467.0, 5658.0, 5350.0, 5532.0, 5606.0, 5566.0 (number of hits: 3)
13	5500	9	1	333	1	5456.0, 5453.0, 5550.0, 5645.0, 5700.0, 5393.0, 5659.0, 5466.0, 5514.0, 5416.0, 5426.0, 5329.0, 5706.0, 5355.0, 5553.0, 5582.0, 5295.0, 5697.0, 5403.0, 5265.0, 5619.0, 5660.0, 5460.0, 5547.0, 5611.0, 5394.0, 5312.0, 5649.0, 5267.0, 5315.0, 5709.0, 5475.0, 5435.0, 5387.0, 5418.0, 5561.0, 5511.0, 5681.0, 5716.0, 5363.0, 5440.0, 5297.0, 5695.0, 5577.0, 5341.0, 5626.0, 5607.0, 5531.0, 5705.0, 5338.0, 5414.0, 5484.0, 5568.0, 5427.0, 5515.0, 5391.0, 5260.0, 5491.0, 5603.0, 5673.0, 5717.0, 5411.0, 5679.0, 5640.0, 5575.0, 5703.0, 5349.0, 5306.0, 5379.0, 5664.0, 5470.0, 5647.0, 5461.0, 5266.0, 5576.0, 5566.0, 5459.0, 5562.0, 5301.0, 5642.0, 5493.0, 5699.0, 5595.0, 5334.0, 5388.0, 5293.0, 5683.0, 5300.0, 5686.0, 5646.0, 5417.0, 5546.0, 5555.0, 5668.0, 5606.0,

						5333.0, 5529.0, 5476.0, 5504.0, 5395.0 (number of hits: 3)
14	5500	9	1	333	1	5348.0, 5395.0, 5534.0, 5465.0, 5303.0, 5262.0, 5436.0, 5443.0, 5367.0, 5714.0, 5650.0, 5552.0, 5350.0, 5334.0, 5454.0, 5439.0, 5378.0, 5479.0, 5700.0, 5406.0, 5602.0, 5371.0, 5309.0, 5366.0, 5413.0, 5433.0, 5494.0, 5407.0, 5321.0, 5483.0, 5409.0, 5723.0, 5692.0, 5265.0, 5370.0, 5499.0, 5515.0, 5343.0, 5702.0, 5455.0, 5377.0, 5500.0, 5622.0, 5257.0, 5553.0, 5423.0, 5543.0, 5340.0, 5346.0, 5260.0, 5256.0, 5664.0, 5685.0, 5684.0, 5638.0, 5637.0, 5589.0, 5268.0, 5661.0, 5569.0, 5628.0, 5308.0, 5656.0, 5686.0, 5315.0, 5318.0, 5575.0, 5532.0, 5565.0, 5254.0, 5581.0, 5452.0, 5523.0, 5681.0, 5570.0, 5460.0, 5529.0, 5646.0, 5270.0, 5287.0, 5600.0, 5386.0, 5388.0, 5428.0, 5599.0, 5471.0, 5561.0, 5489.0, 5404.0, 5704.0, 5493.0, 5505.0, 5537.0, 5670.0, 5693.0, 5456.0, 5361.0, 5540.0, 5392.0, 5451.0 (number of hits: 5)
15	5500	9	1	333	1	5655.0, 5460.0, 5562.0, 5415.0, 5513.0, 5321.0, 5423.0, 5603.0, 5621.0, 5297.0, 5662.0, 5661.0, 5507.0, 5394.0, 5287.0, 5535.0, 5332.0, 5525.0, 5493.0, 5276.0, 5392.0, 5664.0, 5382.0, 5589.0, 5320.0, 5315.0, 5414.0, 5291.0, 5469.0, 5611.0, 5284.0, 5639.0, 5353.0, 5467.0, 5714.0, 5256.0, 5429.0, 5340.0, 5431.0, 5454.0, 5645.0, 5356.0, 5527.0, 5667.0, 5663.0, 5445.0, 5447.0, 5385.0, 5592.0, 5537.0, 5505.0, 5545.0, 5480.0, 5310.0, 5503.0, 5405.0, 5285.0, 5716.0, 5319.0, 5676.0, 5402.0, 5274.0, 5711.0, 5451.0, 5335.0, 5345.0, 5265.0, 5610.0, 5495.0, 5679.0, 5638.0, 5282.0, 5270.0, 5471.0, 5508.0, 5468.0, 5491.0, 5630.0, 5712.0, 5533.0, 5574.0, 5593.0, 5264.0, 5644.0, 5628.0, 5443.0, 5299.0, 5651.0, 5316.0, 5449.0, 5375.0, 5624.0, 5648.0, 5583.0, 5362.0, 5670.0, 5718.0, 5594.0, 5490.0, 5708.0 (number of hits: 8)
16	5500	9	1	333	1	5271.0, 5589.0, 5426.0, 5253.0, 5410.0, 5309.0, 5373.0, 5478.0, 5424.0, 5543.0, 5302.0, 5317.0, 5257.0, 5346.0, 5644.0, 5380.0, 5376.0, 5647.0, 5513.0, 5383.0, 5476.0, 5563.0, 5252.0, 5469.0, 5355.0, 5444.0, 5374.0, 5460.0, 5665.0, 5327.0, 5431.0, 5312.0, 5646.0, 5494.0, 5448.0, 5297.0, 5524.0, 5425.0, 5350.0, 5345.0, 5395.0, 5300.0, 5413.0, 5301.0, 5597.0, 5311.0, 5631.0, 5711.0, 5434.0, 5712.0, 5416.0, 5575.0, 5284.0, 5464.0, 5516.0, 5686.0, 5553.0, 5637.0, 5503.0, 5442.0, 5579.0, 5308.0, 5539.0, 5470.0, 5702.0, 5384.0, 5556.0, 5719.0, 5436.0, 5577.0, 5480.0, 5527.0, 5391.0, 5468.0, 5255.0, 5512.0, 5274.0, 5613.0, 5419.0, 5593.0,

						5316.0, 5528.0, 5638.0, 5496.0, 5459.0, 5538.0, 5658.0, 5552.0, 5558.0, 5540.0, 5509.0, 5697.0, 5565.0, 5603.0, 5407.0, 5522.0, 5595.0, 5495.0, 5404.0, 5402.0 (number of hits: 5)
17	5500	9	1	333	1	5585.0, 5350.0, 5625.0, 5564.0, 5491.0, 5601.0, 5297.0, 5605.0, 5544.0, 5462.0, 5406.0, 5432.0, 5459.0, 5628.0, 5421.0, 5685.0, 5519.0, 5518.0, 5251.0, 5672.0, 5444.0, 5329.0, 5604.0, 5458.0, 5386.0, 5699.0, 5338.0, 5380.0, 5555.0, 5539.0, 5260.0, 5673.0, 5677.0, 5381.0, 5704.0, 5318.0, 5337.0, 5400.0, 5614.0, 5331.0, 5397.0, 5483.0, 5574.0, 5411.0, 5723.0, 5479.0, 5724.0, 5494.0, 5577.0, 5578.0, 5630.0, 5655.0, 5275.0, 5495.0, 5469.0, 5413.0, 5496.0, 5382.0, 5542.0, 5524.0, 5642.0, 5536.0, 5388.0, 5332.0, 5327.0, 5602.0, 5477.0, 5427.0, 5340.0, 5606.0, 5529.0, 5377.0, 5315.0, 5451.0, 5399.0, 5571.0, 5634.0, 5700.0, 5559.0, 5554.0, 5531.0, 5650.0, 5272.0, 5561.0, 5603.0, 5404.0, 5570.0, 5714.0, 5624.0, 5697.0, 5464.0, 5619.0, 5521.0, 5398.0, 5461.0, 5276.0, 5457.0, 5668.0, 5333.0, 5295.0 (number of hits: 4)
18	5500	9	1	333	1	5368.0, 5523.0, 5362.0, 5550.0, 5380.0, 5706.0, 5301.0, 5269.0, 5320.0, 5434.0, 5548.0, 5565.0, 5573.0, 5556.0, 5640.0, 5405.0, 5525.0, 5352.0, 5436.0, 5273.0, 5484.0, 5676.0, 5264.0, 5509.0, 5666.0, 5334.0, 5481.0, 5409.0, 5354.0, 5721.0, 5626.0, 5345.0, 5412.0, 5499.0, 5624.0, 5364.0, 5331.0, 5514.0, 5497.0, 5575.0, 5641.0, 5604.0, 5585.0, 5295.0, 5311.0, 5527.0, 5542.0, 5634.0, 5589.0, 5324.0, 5690.0, 5287.0, 5284.0, 5652.0, 5662.0, 5501.0, 5488.0, 5255.0, 5683.0, 5300.0, 5616.0, 5517.0, 5389.0, 5703.0, 5593.0, 5333.0, 5667.0, 5621.0, 5449.0, 5401.0, 5271.0, 5341.0, 5711.0, 5622.0, 5251.0, 5312.0, 5336.0, 5422.0, 5307.0, 5629.0, 5299.0, 5280.0, 5686.0, 5377.0, 5699.0, 5387.0, 5510.0, 5256.0, 5384.0, 5470.0, 5692.0, 5408.0, 5424.0, 5679.0, 5339.0, 5450.0, 5611.0, 5606.0, 5722.0, 5317.0 (number of hits: 4)
19	5500	9	1	333	1	5303.0, 5420.0, 5559.0, 5573.0, 5361.0, 5600.0, 5636.0, 5265.0, 5278.0, 5287.0, 5595.0, 5349.0, 5398.0, 5706.0, 5450.0, 5336.0, 5589.0, 5657.0, 5503.0, 5685.0, 5409.0, 5582.0, 5460.0, 5301.0, 5571.0, 5396.0, 5471.0, 5456.0, 5655.0, 5651.0, 5635.0, 5473.0, 5404.0, 5564.0, 5292.0, 5455.0, 5648.0, 5513.0, 5427.0, 5353.0, 5262.0, 5554.0, 5645.0, 5694.0, 5536.0, 5630.0, 5252.0, 5346.0, 5472.0, 5574.0, 5363.0, 5611.0, 5440.0, 5717.0, 5527.0, 5572.0, 5370.0, 5544.0, 5659.0, 5403.0, 5397.0, 5340.0, 5387.0, 5436.0, 5318.0,

						5429.0, 5492.0, 5354.0, 5431.0, 5670.0, 5410.0, 5646.0, 5445.0, 5681.0, 5324.0, 5547.0, 5381.0, 5641.0, 5261.0, 5338.0, 5382.0, 5389.0, 5711.0, 5634.0, 5719.0, 5331.0, 5309.0, 5315.0, 5493.0, 5686.0, 5308.0, 5399.0, 5541.0, 5466.0, 5376.0, 5316.0, 5524.0, 5504.0, 5383.0, 5592.0 (number of hits: 4)
20	5500	9	1	333	1	5357.0, 5376.0, 5550.0, 5427.0, 5534.0, 5709.0, 5701.0, 5493.0, 5353.0, 5405.0, 5673.0, 5439.0, 5475.0, 5399.0, 5527.0, 5544.0, 5582.0, 5325.0, 5551.0, 5322.0, 5296.0, 5692.0, 5657.0, 5559.0, 5609.0, 5658.0, 5340.0, 5395.0, 5720.0, 5442.0, 5557.0, 5622.0, 5329.0, 5563.0, 5364.0, 5543.0, 5583.0, 5274.0, 5362.0, 5358.0, 5302.0, 5667.0, 5532.0, 5400.0, 5566.0, 5293.0, 5370.0, 5535.0, 5719.0, 5320.0, 5409.0, 5309.0, 5580.0, 5416.0, 5708.0, 5479.0, 5613.0, 5441.0, 5715.0, 5494.0, 5480.0, 5577.0, 5343.0, 5363.0, 5313.0, 5689.0, 5471.0, 5489.0, 5472.0, 5521.0, 5262.0, 5333.0, 5273.0, 5576.0, 5285.0, 5328.0, 5703.0, 5385.0, 5444.0, 5398.0, 5336.0, 5425.0, 5324.0, 5437.0, 5503.0, 5290.0, 5421.0, 5486.0, 5477.0, 5291.0, 5611.0, 5717.0, 5556.0, 5617.0, 5623.0, 5380.0, 5644.0, 5287.0, 5565.0, 5414.0 (number of hits: 3)
21	5500	9	1	333	1	5675.0, 5539.0, 5434.0, 5711.0, 5284.0, 5462.0, 5317.0, 5313.0, 5646.0, 5633.0, 5555.0, 5691.0, 5490.0, 5500.0, 5700.0, 5572.0, 5320.0, 5362.0, 5678.0, 5661.0, 5259.0, 5450.0, 5484.0, 5636.0, 5659.0, 5470.0, 5506.0, 5338.0, 5583.0, 5697.0, 5256.0, 5401.0, 5709.0, 5418.0, 5375.0, 5436.0, 5688.0, 5689.0, 5724.0, 5626.0, 5451.0, 5343.0, 5629.0, 5258.0, 5532.0, 5396.0, 5523.0, 5367.0, 5373.0, 5657.0, 5632.0, 5459.0, 5693.0, 5270.0, 5630.0, 5369.0, 5562.0, 5580.0, 5705.0, 5578.0, 5596.0, 5363.0, 5654.0, 5251.0, 5606.0, 5476.0, 5527.0, 5508.0, 5417.0, 5416.0, 5650.0, 5296.0, 5393.0, 5592.0, 5603.0, 5631.0, 5625.0, 5309.0, 5637.0, 5300.0, 5577.0, 5635.0, 5432.0, 5722.0, 5567.0, 5312.0, 5469.0, 5600.0, 5448.0, 5723.0, 5605.0, 5294.0, 5648.0, 5275.0, 5718.0, 5409.0, 5271.0, 5692.0, 5391.0, 5492.0 (number of hits: 5)
22	5500	9	1	333	1	5552.0, 5410.0, 5443.0, 5303.0, 5503.0, 5554.0, 5606.0, 5411.0, 5511.0, 5433.0, 5276.0, 5251.0, 5599.0, 5663.0, 5402.0, 5424.0, 5354.0, 5566.0, 5296.0, 5308.0, 5598.0, 5255.0, 5331.0, 5619.0, 5319.0, 5589.0, 5471.0, 5323.0, 5423.0, 5257.0, 5635.0, 5422.0, 5288.0, 5543.0, 5517.0, 5359.0, 5427.0, 5390.0, 5662.0, 5464.0, 5329.0, 5358.0, 5451.0, 5633.0, 5601.0, 5578.0, 5519.0, 5399.0, 5338.0, 5672.0,

						5409.0, 5597.0, 5679.0, 5452.0, 5575.0, 5479.0, 5608.0, 5252.0, 5567.0, 5683.0, 5541.0, 5320.0, 5518.0, 5482.0, 5363.0, 5426.0, 5301.0, 5475.0, 5309.0, 5270.0, 5577.0, 5483.0, 5429.0, 5278.0, 5414.0, 5434.0, 5256.0, 5314.0, 5627.0, 5346.0, 5332.0, 5324.0, 5632.0, 5369.0, 5321.0, 5579.0, 5705.0, 5362.0, 5512.0, 5520.0, 5302.0, 5524.0, 5630.0, 5317.0, 5480.0, 5371.0, 5292.0, 5392.0, 5628.0, 5516.0 (number of hits: 1)
23	5500	9	1	333	1	5713.0, 5348.0, 5412.0, 5628.0, 5637.0, 5662.0, 5643.0, 5680.0, 5545.0, 5648.0, 5565.0, 5675.0, 5377.0, 5312.0, 5542.0, 5383.0, 5611.0, 5305.0, 5502.0, 5719.0, 5645.0, 5576.0, 5433.0, 5351.0, 5530.0, 5515.0, 5450.0, 5635.0, 5362.0, 5541.0, 5584.0, 5630.0, 5444.0, 5524.0, 5691.0, 5543.0, 5304.0, 5402.0, 5591.0, 5375.0, 5254.0, 5478.0, 5461.0, 5487.0, 5286.0, 5411.0, 5388.0, 5632.0, 5420.0, 5270.0, 5274.0, 5460.0, 5631.0, 5677.0, 5339.0, 5258.0, 5508.0, 5669.0, 5269.0, 5408.0, 5453.0, 5326.0, 5297.0, 5329.0, 5596.0, 5264.0, 5392.0, 5434.0, 5700.0, 5321.0, 5296.0, 5518.0, 5604.0, 5528.0, 5603.0, 5563.0, 5558.0, 5252.0, 5446.0, 5445.0, 5463.0, 5330.0, 5599.0, 5317.0, 5658.0, 5349.0, 5469.0, 5325.0, 5593.0, 5567.0, 5290.0, 5559.0, 5668.0, 5556.0, 5520.0, 5493.0, 5573.0, 5608.0, 5521.0, 5257.0 (number of hits: 3)
24	5500	9	1	333	1	5468.0, 5286.0, 5316.0, 5487.0, 5395.0, 5483.0, 5434.0, 5505.0, 5556.0, 5562.0, 5307.0, 5700.0, 5359.0, 5337.0, 5577.0, 5515.0, 5425.0, 5417.0, 5271.0, 5623.0, 5567.0, 5275.0, 5501.0, 5655.0, 5678.0, 5419.0, 5349.0, 5360.0, 5692.0, 5573.0, 5527.0, 5361.0, 5548.0, 5460.0, 5331.0, 5446.0, 5303.0, 5606.0, 5694.0, 5520.0, 5559.0, 5424.0, 5381.0, 5490.0, 5628.0, 5711.0, 5516.0, 5338.0, 5319.0, 5563.0, 5376.0, 5718.0, 5554.0, 5366.0, 5538.0, 5335.0, 5545.0, 5491.0, 5620.0, 5499.0, 5496.0, 5541.0, 5429.0, 5256.0, 5324.0, 5723.0, 5284.0, 5685.0, 5398.0, 5263.0, 5378.0, 5564.0, 5693.0, 5581.0, 5323.0, 5498.0, 5698.0, 5433.0, 5591.0, 5640.0, 5720.0, 5652.0, 5600.0, 5557.0, 5302.0, 5377.0, 5586.0, 5407.0, 5503.0, 5690.0, 5444.0, 5521.0, 5436.0, 5475.0, 5585.0, 5340.0, 5463.0, 5699.0, 5488.0, 5497.0 (number of hits: 9)
25	5500	9	1	333	1	5343.0, 5320.0, 5713.0, 5525.0, 5573.0, 5433.0, 5342.0, 5354.0, 5314.0, 5366.0, 5719.0, 5309.0, 5665.0, 5606.0, 5383.0, 5659.0, 5416.0, 5505.0, 5711.0, 5437.0, 5443.0, 5264.0, 5675.0, 5627.0, 5488.0, 5495.0, 5718.0, 5466.0, 5459.0, 5524.0, 5535.0, 5449.0, 5315.0, 5474.0, 5367.0,

						5638.0, 5651.0, 5697.0, 5306.0, 5448.0, 5656.0, 5681.0, 5304.0, 5567.0, 5491.0, 5537.0, 5671.0, 5401.0, 5430.0, 5502.0, 5312.0, 5469.0, 5462.0, 5579.0, 5679.0, 5589.0, 5503.0, 5632.0, 5565.0, 5613.0, 5582.0, 5492.0, 5568.0, 5329.0, 5321.0, 5362.0, 5372.0, 5640.0, 5612.0, 5274.0, 5530.0, 5666.0, 5678.0, 5569.0, 5279.0, 5335.0, 5271.0, 5590.0, 5295.0, 5655.0, 5628.0, 5446.0, 5553.0, 5258.0, 5712.0, 5544.0, 5705.0, 5605.0, 5598.0, 5455.0, 5715.0, 5523.0, 5467.0, 5650.0, 5361.0, 5529.0, 5375.0, 5634.0, 5327.0, 5514.0 (number of hits: 6)
26	5500	9	1	333	1	5416.0, 5502.0, 5464.0, 5406.0, 5422.0, 5281.0, 5682.0, 5373.0, 5309.0, 5493.0, 5260.0, 5644.0, 5310.0, 5714.0, 5515.0, 5324.0, 5618.0, 5410.0, 5313.0, 5716.0, 5633.0, 5686.0, 5614.0, 5336.0, 5678.0, 5398.0, 5322.0, 5284.0, 5590.0, 5372.0, 5480.0, 5279.0, 5356.0, 5412.0, 5312.0, 5371.0, 5394.0, 5458.0, 5361.0, 5259.0, 5348.0, 5512.0, 5706.0, 5654.0, 5306.0, 5370.0, 5570.0, 5511.0, 5277.0, 5262.0, 5642.0, 5307.0, 5637.0, 5626.0, 5698.0, 5425.0, 5507.0, 5418.0, 5396.0, 5569.0, 5554.0, 5352.0, 5275.0, 5302.0, 5429.0, 5404.0, 5573.0, 5482.0, 5555.0, 5288.0, 5649.0, 5517.0, 5299.0, 5588.0, 5304.0, 5703.0, 5253.0, 5611.0, 5650.0, 5664.0, 5254.0, 5419.0, 5392.0, 5351.0, 5471.0, 5331.0, 5523.0, 5321.0, 5704.0, 5605.0, 5332.0, 5399.0, 5376.0, 5261.0, 5434.0, 5474.0, 5353.0, 5274.0, 5271.0, 5543.0 (number of hits: 3)
27	5500	9	1	333	1	5644.0, 5634.0, 5695.0, 5289.0, 5297.0, 5319.0, 5486.0, 5689.0, 5342.0, 5581.0, 5598.0, 5436.0, 5463.0, 5377.0, 5275.0, 5559.0, 5685.0, 5418.0, 5439.0, 5353.0, 5290.0, 5563.0, 5340.0, 5354.0, 5409.0, 5713.0, 5666.0, 5323.0, 5643.0, 5359.0, 5648.0, 5619.0, 5708.0, 5449.0, 5633.0, 5570.0, 5538.0, 5266.0, 5595.0, 5474.0, 5283.0, 5321.0, 5356.0, 5624.0, 5673.0, 5650.0, 5339.0, 5378.0, 5381.0, 5637.0, 5445.0, 5465.0, 5702.0, 5521.0, 5566.0, 5416.0, 5472.0, 5396.0, 5351.0, 5384.0, 5435.0, 5415.0, 5317.0, 5706.0, 5542.0, 5523.0, 5288.0, 5453.0, 5711.0, 5257.0, 5292.0, 5593.0, 5478.0, 5531.0, 5412.0, 5663.0, 5660.0, 5636.0, 5591.0, 5557.0, 5612.0, 5698.0, 5551.0, 5544.0, 5324.0, 5555.0, 5448.0, 5632.0, 5640.0, 5271.0, 5331.0, 5280.0, 5371.0, 5403.0, 5495.0, 5389.0, 5574.0, 5603.0, 5517.0, 5382.0 (number of hits: 1)
28	5500	9	1	333	1	5648.0, 5426.0, 5289.0, 5597.0, 5443.0, 5475.0, 5419.0, 5637.0, 5259.0, 5543.0, 5365.0, 5374.0, 5583.0, 5678.0, 5451.0, 5435.0, 5434.0, 5561.0, 5712.0, 5636.0,

						5626.0, 5694.0, 5406.0, 5383.0, 5526.0, 5605.0, 5650.0, 5377.0, 5600.0, 5706.0, 5641.0, 5256.0, 5405.0, 5501.0, 5702.0, 5396.0, 5592.0, 5523.0, 5360.0, 5486.0, 5330.0, 5338.0, 5458.0, 5716.0, 5548.0, 5606.0, 5653.0, 5382.0, 5273.0, 5381.0, 5518.0, 5525.0, 5251.0, 5581.0, 5461.0, 5336.0, 5271.0, 5263.0, 5488.0, 5576.0, 5452.0, 5264.0, 5318.0, 5469.0, 5299.0, 5640.0, 5570.0, 5492.0, 5519.0, 5388.0, 5347.0, 5445.0, 5432.0, 5654.0, 5481.0, 5368.0, 5295.0, 5584.0, 5531.0, 5557.0, 5453.0, 5429.0, 5528.0, 5541.0, 5529.0, 5476.0, 5616.0, 5389.0, 5647.0, 5633.0, 5710.0, 5667.0, 5491.0, 5348.0, 5611.0, 5255.0, 5404.0, 5620.0, 5554.0, 5343.0 (number of hits: 3)
29	5500	9	1	333	1	5380.0, 5530.0, 5668.0, 5717.0, 5546.0, 5326.0, 5263.0, 5270.0, 5276.0, 5596.0, 5341.0, 5620.0, 5685.0, 5523.0, 5666.0, 5543.0, 5528.0, 5489.0, 5305.0, 5371.0, 5480.0, 5314.0, 5419.0, 5688.0, 5706.0, 5332.0, 5396.0, 5444.0, 5649.0, 5324.0, 5516.0, 5611.0, 5291.0, 5720.0, 5393.0, 5646.0, 5718.0, 5634.0, 5442.0, 5261.0, 5354.0, 5517.0, 5709.0, 5655.0, 5662.0, 5376.0, 5258.0, 5344.0, 5423.0, 5669.0, 5346.0, 5438.0, 5456.0, 5268.0, 5485.0, 5691.0, 5695.0, 5429.0, 5675.0, 5576.0, 5325.0, 5547.0, 5633.0, 5500.0, 5297.0, 5461.0, 5539.0, 5650.0, 5716.0, 5632.0, 5595.0, 5647.0, 5700.0, 5525.0, 5470.0, 5476.0, 5320.0, 5690.0, 5372.0, 5454.0, 5415.0, 5282.0, 5724.0, 5256.0, 5390.0, 5417.0, 5518.0, 5678.0, 5614.0, 5671.0, 5453.0, 5323.0, 5405.0, 5337.0, 5404.0, 5549.0, 5250.0, 5507.0, 5443.0, 5411.0 (number of hits: 2)
30	5500	9	1	333	1	5535.0, 5580.0, 5401.0, 5347.0, 5430.0, 5513.0, 5484.0, 5376.0, 5645.0, 5321.0, 5705.0, 5678.0, 5548.0, 5503.0, 5509.0, 5442.0, 5274.0, 5355.0, 5305.0, 5646.0, 5665.0, 5453.0, 5426.0, 5251.0, 5397.0, 5449.0, 5564.0, 5333.0, 5327.0, 5538.0, 5536.0, 5258.0, 5460.0, 5331.0, 5651.0, 5319.0, 5266.0, 5682.0, 5440.0, 5324.0, 5413.0, 5462.0, 5586.0, 5417.0, 5704.0, 5464.0, 5605.0, 5300.0, 5537.0, 5547.0, 5672.0, 5577.0, 5708.0, 5491.0, 5543.0, 5628.0, 5625.0, 5329.0, 5257.0, 5671.0, 5358.0, 5260.0, 5644.0, 5582.0, 5617.0, 5439.0, 5492.0, 5436.0, 5609.0, 5615.0, 5292.0, 5419.0, 5526.0, 5364.0, 5643.0, 5262.0, 5371.0, 5468.0, 5507.0, 5252.0, 5576.0, 5320.0, 5631.0, 5690.0, 5559.0, 5263.0, 5379.0, 5616.0, 5286.0, 5707.0, 5562.0, 5432.0, 5518.0, 5539.0, 5575.0, 5332.0, 5377.0, 5552.0, 5479.0, 5278.0 (number of hits: 5)

40MHz

Radar SignalType	Waveform/Trial Number	Detection (%)	Limit (%)	Pass/Fail
Type 1A	15	100%	60%	pass
Type 1B	15	100%	60%	pass
Type 2	30	96.7 %	60%	Pass
Type 3	30	96.7 %	60%	Pass
Type 4	30	96.7 %	60%	Pass
Aggregate(Type1 to 4)	120	97.5%	80%	Pass
Type 5	30	100 %	80%	Pass
Type 6	30	100 %	70%	Pass

Please refer to the following statistical tables:

5510MHz**Radar Type 1A Statistical Performance**

Trial #	Fc (MHz)	Pulse/Burst	Pulse Width (μS)	PRI (μs)	Detection (1:yes; 0:no)
1	5510	95	1	558	1
2	5510	70	1	758	1
3	5510	86	1	618	1
4	5510	18	1	3066	1
5	5510	89	1	598	1
6	5510	83	1	638	1
7	5510	92	1	578	1
8	5510	99	1	538	1
9	5510	74	1	718	1
10	5510	65	1	818	1
11	5510	78	1	678	1
12	5510	67	1	798	1
13	5510	62	1	858	1
14	5510	102	1	518	1
15	5510	63	1	838	1
Detection Percentage: 100 % (>60%)					

Radar Type 1B Statistical Performance

Trial #	Fc (MHz)	Pulse/Burst	Pulse Width (μS)	PRI (μs)	Detection (1:yes; 0:no)
1	5510	25	1	2127	1
2	5510	32	1	1678	1
3	5510	24	1	2215	1
4	5510	19	1	2835	1
5	5510	27	1	1964	1
6	5510	45	1	1189	1
7	5510	45	1	1195	1
8	5510	24	1	2272	1
9	5510	31	1	1739	1
10	5510	26	1	2073	1
11	5510	28	1	1894	1
12	5510	36	1	1475	1
13	5510	59	1	907	1
14	5510	27	1	2010	1
15	5510	21	1	2578	1
Detection Percentage: 100 % (>60%)					

Radar Type 2 Statistical Performance

Trial #	Fc (MHz)	Pulse/Burst	Pulse Width (μS)	PRI (μs)	Detection (1:yes; 0:no)
1	5510	28	4	217	1
2	5510	27	4.4	202	1
3	5510	28	1.2	153	1
4	5510	29	4.2	193	1
5	5510	26	3	164	1
6	5510	29	4.7	221	1
7	5510	29	1.1	207	1
8	5510	28	2.6	184	1
9	5510	28	1.2	216	1
10	5510	29	1.9	198	1
11	5510	29	5	155	1
12	5510	29	2.5	158	1
13	5510	25	1	161	1
14	5510	29	1.4	160	1
15	5510	23	4.5	164	1
16	5510	27	4.9	196	1
17	5510	25	3.6	199	1
18	5510	29	2.9	188	1
19	5510	28	1.5	182	1
20	5510	26	2.3	220	1
21	5510	29	4.5	190	1
22	5510	29	4	212	1
23	5510	24	3.6	221	1
24	5510	23	2.8	176	1
25	5510	27	4.9	166	1
26	5510	26	1.1	191	1
27	5510	23	1.9	164	1
28	5510	27	4.5	208	1
29	5510	29	3.2	163	1
30	5510	23	1.3	192	0
31	5510	24	2.5	193	1
32	5510	26	4.3	168	1
33	5510	25	3.6	185	1
34	5510	25	2.3	224	1
35	5510	23	2.4	211	1
36	5510	25	2	166	1
37	5510	23	4	186	1
38	5510	27	4.5	176	1
39	5510	24	3.7	165	1
40	5510	24	1.8	151	1
Detection Percentage: 96.7 % (>60%)					

Radar Type 3 Statistical Performance

Trial #	Fc (MHz)	Pulse/Burst	Pulse Width (μS)	PRI (μs)	Detection (1:yes; 0:no)
1	5510	16	9	267	1
2	5510	17	8.7	215	1
3	5510	18	6.2	443	1
4	5510	16	6.4	277	1
5	5510	16	9.8	318	1
6	5510	16	9.5	234	1
7	5510	17	9.1	211	1
8	5510	16	9.7	401	1
9	5510	18	9	417	1
10	5510	16	9.4	212	1
11	5510	18	7.4	491	1
12	5510	17	6.8	304	1
13	5510	18	9	386	1
14	5510	17	6.6	333	1
15	5510	16	9.5	343	1
16	5510	17	8.5	395	1
17	5510	17	8.2	445	1
18	5510	17	9.2	232	1
19	5510	17	6.5	242	1
20	5510	17	8.3	350	1
21	5510	18	8.3	355	1
22	5510	16	9.2	229	1
23	5510	17	8.4	429	1
24	5510	16	8.9	456	1
25	5510	18	9.5	415	1
26	5510	16	6.7	300	0
27	5510	17	6.1	352	1
28	5510	18	6.2	333	1
29	5510	17	7.4	460	1
30	5510	16	6.2	491	1
Detection Percentage: 96.7 % (>60%)					

Radar Type 4 Statistical Performance

Trial #	Fc (MHz)	Pulse/Burst	Pulse Width (μS)	PRI (μs)	Detection (1:yes; 0:no)
1	5510	14	19.6	424	1
2	5510	12	13.5	219	1
3	5510	13	12.9	203	1
4	5510	14	18.5	277	1
5	5510	15	16.4	305	1
6	5510	12	15.6	309	1
7	5510	14	15.9	228	0
8	5510	12	12.4	276	1
9	5510	16	11.4	473	1
10	5510	13	16.9	248	1
11	5510	15	16.1	349	1
12	5510	14	16.4	337	1
13	5510	16	19.6	420	1
14	5510	14	11.3	496	1
15	5510	13	14.1	236	1
16	5510	12	13.7	248	1
17	5510	13	12.1	348	1
18	5510	12	13	299	1
19	5510	15	16.8	492	1
20	5510	16	13.5	471	1
21	5510	14	16.2	355	1
22	5510	12	17.3	249	1
23	5510	12	15.7	431	1
24	5510	16	17	440	1
25	5510	12	15.6	267	1
26	5510	15	16.4	494	1
27	5510	12	13.8	297	1
28	5510	16	18.9	369	1
29	5510	13	12.7	381	1
30	5510	12	16.2	273	1
Detection Percentage: 96.7 % (>60%)					

Radar Type 5 Case 1 Statistical Performance

Statistics 1 (ChirpCenter Frequency: 5510.0MHz)

Trial #	Pulse	Chirp(MHz)	Pulse Width (µS)	Pulse 1-2 spacing(µS)	Pulse 2-3 spacing(µS)	Pulse Start(S)	Detection (1:yes;0:no)
0	2	8	54.1	1828		0.770308	1
1	1	8	85.2			0.965084	
2	2	8	62.1	1111		2.366516	
3	2	8	64.3	1836		2.649647	
4	2	8	76.9	1655		3.568086	
5	3	8	75.2	1646	1681	4.688587	
6	1	8	64.2			5.345607	
7	1	8	97.3			6.187045	
8	1	8	75.9			7.424343	
9	2	8	83.9	1258		7.908064	
10	1	8	74.1			9.040579	
11	2	8	64.5	1526		10.27634	
12	2	8	73.8	1637		10.59702	
13	1	8	89.2			11.56196	

Statistics 2 (ChirpCenter Frequency: 5510.0 MHz)

Trial #	Pulse	Chirp(MHz)	Pulse Width (µS)	Pulse 1-2 spacing(µS)	Pulse 2-3 spacing(µS)	Pulse Start(S)	Detection (1:yes;0:no)
0	1	8	93.8			0.230686	1
1	2	8	56.5	1101		2.470725	
2	2	8	90.2	1462		3.493483	
3	2	8	64.5	1776		4.751128	
4	2	8	65.2	1538		6.643447	
5	2	8	86.1	1609		7.766082	
6	2	8	72.2	1056		8.128415	
7	1	8	75.9			9.525873	
8	2	8	54.3	1529		11.29595	

Statistics 3 (ChirpCenter Frequency: 5510.0 MHz)

Trial #	Pulse	Chirp(MHz)	Pulse Width (μS)	Pulse 1-2 spacing(μS)	Pulse 2-3 spacing(μS)	Pulse Start(S)	Detection (1:yes;0:no)
0	1	9	88			0.66293	1
1	2	9	71.2	1747		1.358655	
2	2	9	50.7	1023		1.917193	
3	1	9	98.4			2.429118	
4	1	9	69.2			3.372992	
5	3	9	60	1910	1677	3.995955	
6	2	9	59.3	1031		4.559273	
7	1	9	91.3			5.41869	
8	2	9	68.5	1001		6.16217	
9	2	9	57.6	1925		6.961099	
10	3	9	74.4	1349	1962	7.448934	
11	2	9	77.5	1795		8.427148	
12	2	9	65.2	1637		8.859646	
13	2	9	88.8	1296		9.185638	
14	2	9	70.6	1062		9.947813	
15	3	9	56.3	1153	1521	11.15376	
16	2	9	59.2	1409		11.64492	

Statistics 4 (ChirpCenter Frequency: 5510.0 MHz)

Trial #	Pulse	Chirp(MHz)	Pulse Width (μS)	Pulse 1-2 spacing(μS)	Pulse 2-3 spacing(μS)	Pulse Start(S)	Detection (1:yes;0:no)
0	2	16	77.5	1141		0.210487	1
1	1	16	74.2			1.994088	
2	3	16	58.1	1764	1921	2.56711	
3	3	16	85.7	1131	1496	3.871672	
4	1	16	58.8			4.775105	
5	1	16	54.6			5.462981	
6	2	16	61.4	1654		6.947234	
7	1	16	70.8			8.67293	
8	2	16	93.2	1014		8.779346	
9	2	16	84.2	1479		10.34682	
10	2	16	54.3	1291		11.74483	

Statistics 5(ChirpCenter Frequency: 5510.0 MHz)

Trial #	Pulse	Chirp(MHz)	Pulse Width (µS)	Pulse 1-2 spacing(µS)	Pulse 2-3 spacing(µS)	Pulse Start(S)	Detection (1:yes;0:no)
0	2	5	66	1635		0.615557	1
1	2	5	50.3	1622		1.544095	
2	1	5	94.2			2.357304	
3	3	5	76.3	1359	1779	2.660568	
4	1	5	54.8			3.578788	
5	2	5	73.9	1047		4.423603	
6	2	5	78.1	1136		5.101645	
7	3	5	87.7	1094	1802	6.013862	
8	2	5	73.8	1347		6.550882	
9	2	5	78.4	1148		7.422437	
10	2	5	66.8	1652		8.223708	
11	3	5	78.9	1471	1901	9.446804	
12	2	5	99.1	1530		10.03255	
13	1	5	95.3			11.01592	
14	3	5	67.8	1683	1332	11.65624	

Statistics 6 (ChirpCenter Frequency: 5510.0 MHz)

Trial #	Pulse	Chirp(MHz)	Pulse Width (µS)	Pulse 1-2 spacing(µS)	Pulse 2-3 spacing(µS)	Pulse Start(S)	Detection (1:yes;0:no)
0	2	9	52	1593		0.301669	1
1	1	9	75.3			1.252252	
2	1	9	88.1			1.798503	
3	1	9	61.8			2.62047	
4	3	9	85	1238	1058	4.078906	
5	2	9	60.9	1820		4.663523	
6	2	9	51.2	1433		5.645203	
7	1	9	87.8			6.784743	
8	3	9	95	1768	1254	7.029649	
9	3	9	71.4	1980	1412	8.283456	
10	2	9	64.7	1857		8.776456	
11	2	9	86.3	1117		9.86643	
12	3	9	69.6	1114	1530	10.68674	
13	1	9	80.9			11.89515	

Statistics 7(ChirpCenter Frequency: 5510.0 MHz)

Trial #	Pulse	Chirp(MHz)	Pulse Width (μS)	Pulse 1-2 spacing(μS)	Pulse 2-3 spacing(μS)	Pulse Start(S)	Detection (1:yes;0:no)
0	1	11	64.8			0.590824	1
1	1	11	56.5			0.763764	
2	3	11	58.7	1131	1514	1.977267	
3	3	11	70.5	1096	1461	2.458341	
4	2	11	65.3	1091		2.772289	
5	1	11	50.9			3.77988	
6	3	11	59.5	1582	1966	4.341322	
7	2	11	72.6	1623		5.062487	
8	2	11	69.9	1984		5.872238	
9	2	11	86	1447		6.635588	
10	3	11	62.7	1733	1841	6.963722	
11	2	11	93.3	1995		7.384197	
12	2	11	63.4	1712		8.565851	
13	3	11	59.8	1050	1072	9.096535	
14	2	11	86.7	1030		9.858028	
15	2	11	52.6	1465		10.32565	
16	1	11	99.6			11.31508	
17	2	11	60.4	1042		11.38785	

Statistics 8 (ChirpCenter Frequency: 5510.0 MHz)

Trial #	Pulse	Chirp(MHz)	Pulse Width (μS)	Pulse 1-2 spacing(μS)	Pulse 2-3 spacing(μS)	Pulse Start(S)	Detection (1:yes;0:no)
0	3	14	52.6	1315	1211	0.508805	1
1	1	14	52.3			1.580115	
2	2	14	61.1	1908		2.72859	
3	2	14	72.6	1767		3.050138	
4	3	14	68.7	1985	1457	3.874519	
5	3	14	58	1391	1738	5.514825	
6	2	14	91.6	1239		5.985594	
7	1	14	74.3			6.743872	
8	2	14	60.8	1107		7.819276	
9	2	14	74.2	1311		8.68545	
10	2	14	68.5	1820		9.330169	
11	3	14	83.3	1845	1390	10.16716	
12	1	14	52.2			11.35026	

Statistics 9 (ChirpCenter Frequency: 5510.0 MHz)

Trial #	Pulse	Chirp(MHz)	Pulse Width (μS)	Pulse 1-2 spacing(μS)	Pulse 2-3 spacing(μS)	Pulse Start(S)	Detection (1:yes;0:no)
0	2	14	82.3	1904		0.538274	1
1	2	14	91.3	1330		1.084133	
2	2	14	62.8	1060		2.428937	
3	1	14	79.1			2.967135	
4	2	14	75.7	1963		3.927089	
5	1	14	96			4.410127	
6	3	14	53.5	1011	1542	5.668834	
7	1	14	81.8			6.614958	
8	2	14	67	1182		6.940526	
9	1	14	61.8			8.012912	
10	2	14	98.9	1688		8.834974	
11	2	14	96.1	1072		9.554582	
12	2	14	59.1	1818		10.45501	
13	2	14	98.2	1448		11.59011	

Statistics 10 (ChirpCenter Frequency: 5510.0 MHz)

Trial #	Pulse	Chirp(MHz)	Pulse Width (μS)	Pulse 1-2 spacing(μS)	Pulse 2-3 spacing(μS)	Pulse Start(S)	Detection (1:yes;0:no)
0	3	12	99.6	1724	1728	0.395204	1
1	1	12	73.1			1.161811	
2	2	12	52.3	1564		1.871231	
3	1	12	87.9			2.996077	
4	1	12	66.5			3.794962	
5	3	12	79.7	1205	1902	4.787922	
6	3	12	52	1318	1892	5.289376	
7	2	12	52.6	1973		6.261273	
8	3	12	93.6	1152	1579	6.786073	
9	1	12	79.7			7.341801	
10	1	12	61.8			8.604981	
11	1	12	67.5			9.153145	
12	3	12	90.7	1611	1537	9.704296	
13	1	12	53.4			10.8707	
14	1	12	50.5			11.51938	

Radar Type 5 Case 2 Statistical Performance

Statistics 1 (ChirpCenter Frequency: 5496.0 MHz)

Trial #	Pulse	Chirp(MHz)	Pulse Width (μS)	Pulse 1-2 spacing(μS)	Pulse 2-3 spacing(μS)	Pulse Start(S)	Detection (1:yes;0:no)
0	3	9	60.8	1261	1183	0.526218	1
1	2	9	96.8	1729		0.965973	
2	2	9	80.9	1015		2.048682	
3	1	9	61.2			2.848425	
4	2	9	71.5	1059		3.904576	
5	1	9	96.4			4.246592	
6	1	9	58.9			5.043816	
7	1	9	77.4			6.287374	
8	3	9	79.8	1217	1698	6.492841	
9	3	9	72.7	1153	1595	7.264131	
10	1	9	51.4			8.541451	
11	2	9	67.3	1571		8.976248	
12	1	9	55.9			10.24453	
13	3	9	54.1	1580	1418	10.40591	
14	2	9	58.1	1477		11.68197	

Statistics 2 (ChirpCenter Frequency: 5496.0 MHz)

Trial #	Pulse	Chirp(MHz)	Pulse Width (μS)	Pulse 1-2 spacing(μS)	Pulse 2-3 spacing(μS)	Pulse Start(S)	Detection (1:yes;0:no)
0	2	16	95.1	1836		0.618238	1
1	1	16	70.7			2.356253	
2	3	16	51.6	1350	1302	2.615055	
3	2	16	50.4	1640		4.257817	
4	3	16	89.2	1422	1130	4.854893	
5	1	16	63.4			6.928189	
6	2	16	50.9	1087		8.172904	
7	2	16	97.4	1040		9.03548	
8	2	16	86.8	1845		10.40027	
9	2	16	84.2	1858		11.19966	

Statistics 3 (ChirpCenter Frequency: 5493.0 MHz)

Trial #	Pulse	Chirp(MHz)	Pulse Width (μS)	Pulse 1-2 spacing(μS)	Pulse 2-3 spacing(μS)	Pulse Start(S)	Detection (1:yes;0:no)
0	2	8	92.3	1212		0.088683	1
1	2	8	65.2	1030		1.063926	
2	2	8	74.4	1570		1.924598	
3	1	8	60.4			2.463916	
4	1	8	55.3			3.266193	
5	2	8	89.3	1978		3.733506	
6	2	8	58.9	1800		4.560731	
7	2	8	67.1	1572		5.416832	
8	2	8	82.6	1142		5.85149	
9	1	8	67.9			6.699911	
10	2	8	86.4	1419		7.522703	
11	2	8	53.3	1765		8.243826	
12	3	8	84.2	1119	1745	8.681174	
13	1	8	92.6			9.775985	
14	2	8	63.3	1918		10.51014	
15	2	8	63.1	1111		10.6248	
16	3	8	57.1	1891	1173	11.70566	

Statistics 4 (ChirpCenter Frequency: 5492.0 MHz)

Trial #	Pulse	Chirp(MHz)	Pulse Width (μS)	Pulse 1-2 spacing(μS)	Pulse 2-3 spacing(μS)	Pulse Start(S)	Detection (1:yes;0:no)
0	1	6	81.2			0.224727	1
1	2	6	54.2	1107		1.026281	
2	1	6	84			1.733996	
3	1	6	84			2.470173	
4	3	6	79.9	1437	1138	3.950451	
5	3	6	85.9	1046	1907	4.315077	
6	2	6	93.3	1370		5.021592	
7	3	6	84.2	1890	1709	6.256847	
8	3	6	67.5	1983	1286	6.9575	
9	3	6	96.9	1314	1029	7.204577	
10	2	6	83.9	1685		8.26427	
11	3	6	80.2	1800	1979	9.543374	
12	1	6	92.4			10.22485	
13	1	6	95.2			10.72621	
14	1	6	62.2			11.4325	

Statistics 5 (ChirpCenter Frequency: 5497.0 MHz)

Trial #	Pulse	Chirp(MHz)	Pulse Width (μS)	Pulse 1-2 spacing(μS)	Pulse 2-3 spacing(μS)	Pulse Start(S)	Detection (1:yes;0:no)
0	2	17	65	1975		0.494112	1
1	3	17	55.8	1739	1506	0.948237	
2	1	17	50.7			2.323856	
3	2	17	64	1418		3.4886	
4	2	17	76.6	1119		4.59997	
5	1	17	68.6			5.497872	
6	2	17	99.8	1399		5.664289	
7	1	17	97.9			7.10485	
8	2	17	97.9	1254		7.582033	
9	2	17	55.6	1843		8.550511	
10	1	17	83.4			9.845728	
11	1	17	64.3			10.95905	
12	2	17	91.3	1695		11.2893	

Statistics 6 (ChirpCenter Frequency: 5495.0 MHz)

Trial #	Pulse	Chirp(MHz)	Pulse Width (μS)	Pulse 1-2 spacing(μS)	Pulse 2-3 spacing(μS)	Pulse Start(S)	Detection (1:yes;0:no)
0	2	13	54.1	1985		1.05276	1
1	2	13	71.6	1815		2.49402	
2	2	13	78.8	1583		3.034316	
3	2	13	65.6	1661		4.888964	
4	3	13	95.4	1832	1930	5.424486	
5	3	13	51.2	1701	1818	7.349732	
6	1	13	99.9			8.717065	
7	1	13	94.5			10.35116	
8	2	13	54.5	1991		11.79109	

Statistics 7 (ChirpCenter Frequency: 5493.0 MHz)

Trial #	Pulse	Chirp(MHz)	Pulse Width (μS)	Pulse 1-2 spacing(uS)	Pulse 2-3 spacing(uS)	Pulse Start(S)	Detection (1:yes;0:no)
0	3	7	56.2	1433	1283	0.769749	1
1	3	7	88.8	1745	1168	1.68013	
2	1	7	68.6			2.661305	
3	2	7	85.5	1092		3.440952	
4	2	7	53.5	1560		4.029732	
5	3	7	90.2	1918	1930	5.362853	
6	2	7	65.4	1382		6.131787	
7	2	7	74.9	1198		7.099095	
8	2	7	94.4	1286		8.013066	
9	3	7	56.2	1478	1190	8.744402	
10	2	7	65.8	1321		9.386225	
11	1	7	65.5			10.71328	
12	3	7	86.3	1779	1327	11.20802	

Statistics 8 (ChirpCenter Frequency: 5495.0 MHz)

Trial #	Pulse	Chirp(MHz)	Pulse Width (μS)	Pulse 1-2 spacing(μS)	Pulse 2-3 spacing(μS)	Pulse Start(S)	Detection (1:yes;0:no)
0	3	13	85.7	1627	1846	0.680295	1
1	3	13	58.3	1849	1552	0.830352	
2	2	13	60	1421		1.510305	
3	1	13	51.9			2.363861	
4	3	13	95.4	1674	1516	3.60375	
5	3	13	95.1	1852	1649	4.451789	
6	3	13	93.5	1324	1904	4.79588	
7	2	13	55.7	1206		5.632618	
8	1	13	72.7			6.33397	
9	3	13	68.1	1433	1028	6.879588	
10	2	13	61.2	1983		8.104802	
11	2	13	93.2	1893		8.551468	
12	2	13	76.8	1464		9.306456	
13	1	13	69			10.2658	
14	1	13	92.6			10.92246	
15	3	13	79.7	1600	1850	11.41654	

Statistics 9 (ChirpCenter Frequency: 5493.0 MHz)

Trial #	Pulse	Chirp(MHz)	Pulse Width (μS)	Pulse 1-2 spacing(μS)	Pulse 2-3 spacing(μS)	Pulse Start(S)	Detection (1:yes;0:no)
0	2	7	84.2	1351		0.026014	1
1	3	7	99.5	1770	1868	1.935044	
2	2	7	66.7	1700		2.426838	
3	1	7	74.5			3.754098	
4	2	7	99.6	1302		4.446533	
5	2	7	64.5	1048		5.347238	
6	2	7	82.8	1256		6.442336	
7	3	7	79.7	1796	1993	7.852893	
8	2	7	85.7	1172		8.234467	
9	2	7	90.2	1635		9.89831	
10	3	7	82.2	1805	1114	10.86314	
11	2	7	82.6	1522		11.55243	

Statistics 10 (ChirpCenter Frequency: 5495.0 MHz)

Trial #	Pulse	Chirp(MHz)	Pulse Width (µS)	Pulse 1-2 spacing(µS)	Pulse 2-3 spacing(µS)	Pulse Start(S)	Detection (1:yes;0:no)
0	2	12	87.5	1683		0.559988	1
1	1	12	74.9			1.53307	
2	2	12	79.9	1863		1.780371	
3	1	12	66.5			2.685542	
4	2	12	76.6	1882		3.929315	
5	3	12	92	1445	1044	4.495	
6	2	12	75.2	1496		5.571574	
7	3	12	76.2	1612	1562	6.155623	
8	3	12	85.6	1886	1488	7.396933	
9	2	12	66.4	1946		8.483172	
10	2	12	62.4	1500		9.2341	
11	2	12	98.7	1054		9.485418	
12	2	12	78.8	1011		10.65368	
13	2	12	51.7	1928		11.38891	

Radar Type 5 Case 3 Statistical Performance

Statistics 1 (ChirpCenter Frequency: 5226.0 MHz)

Trial #	Pulse	Chirp(MHz)	Pulse Width (µS)	Pulse 1-2 spacing(µS)	Pulse 2-3 spacing(µS)	Pulse Start(S)	Detection (1:yes;0:no)
0	3	11	61.9	1170	1304	0.419503	1
1	2	11	52	1967		0.910526	
2	1	11	80.1			1.894623	
3	1	11	50.6			3.228703	
4	2	11	66.7	1574		3.992965	
5	1	11	97.6			4.610539	
6	2	11	57.4	1300		5.985592	
7	2	11	56.5	1169		6.748343	
8	2	11	64.3	1643		7.226723	
9	2	11	93.8	1945		7.97934	
10	3	11	52.2	1346	1993	9.414931	
11	3	11	52.3	1649	1084	9.713948	
12	2	11	66.8	1177		10.68301	
13	2	11	64.1	1521		11.90009	

Statistics 2 (ChirpCenter Frequency: 5525.0 MHz)

Trial #	Pulse	Chirp(MHz)	Pulse Width (μS)	Pulse 1-2 spacing(μS)	Pulse 2-3 spacing(μS)	Pulse Start(S)	Detection (1:yes;0:no)
0	2	12	62.6	1869		0.165364	1
1	1	12	87.4			1.283024	
2	3	12	50.3	1502	1666	1.536944	
3	1	12	55.5			2.131955	
4	3	12	52	1236	1661	3.216467	
5	3	12	82	1682	1911	3.776671	
6	1	12	50.6			4.641156	
7	3	12	64.2	1042	1162	5.041345	
8	1	12	65.9			5.951407	
9	2	12	87.1	1261		6.272286	
10	2	12	97.1	1430		7.267336	
11	3	12	54.4	1684	1550	7.416809	
12	1	12	56.8			8.602188	
13	2	12	57.2	1209		9.268808	
14	3	12	52.2	1502	1768	9.859013	
15	1	12	74.6			10.63009	
16	2	12	67.3	1751		11.16237	
17	2	12	97.1	1062		11.9764	

Statistics 3 (ChirpCenter Frequency: 5525.0 MHz)

Trial #	Pulse	Chirp(MHz)	Pulse Width (μS)	Pulse 1-2 spacing(μS)	Pulse 2-3 spacing(μS)	Pulse Start(S)	Detection (1:yes;0:no)
0	3	12	79.8	1467	1288	0.428195	1
1	3	12	94.5	1082	1840	1.223874	
2	2	12	78.1	1942		1.627819	
3	1	12	93			2.244074	
4	1	12	81.1			2.760142	
5	2	12	83.5	1467		3.363817	
6	2	12	91	1417		3.995962	
7	2	12	93.1	1950		4.856521	
8	2	12	62.2	1800		5.121787	
9	1	12	92.7			5.781799	
10	2	12	91.3	1269		6.583136	
11	1	12	87.3			7.003237	
12	2	12	52.3	1658		8.039912	
13	2	12	58.5	1763		8.808975	
14	3	12	87.2	1242	1627	9.05538	
15	2	12	57.3	1978		9.9941	
16	2	12	70.1	1987		10.69108	
17	2	12	58.7	1670		10.76582	
18	2	12	70.2	1274		11.98315	

Statistics 4 (ChirpCenter Frequency: 5524.0 MHz)

Trial #	Pulse	Chirp(MHz)	Pulse Width (µS)	Pulse 1-2 spacing(µS)	Pulse 2-3 spacing(µS)	Pulse Start(S)	Detection (1:yes;0:no)
0	2	16	81.1	1213		0.405965	1
1	1	16	56.8			0.845469	
2	2	16	79.5	1331		1.951096	
3	3	16	64.3	1844	1550	2.774127	
4	3	16	74	1902	1554	3.443569	
5	2	16	63.9	1137		4.032135	
6	2	16	55	1454		4.906929	
7	2	16	51	1149		5.87738	
8	3	16	52.1	1875	1866	6.623722	
9	1	16	57.4			7.098748	
10	2	16	89.5	1357		7.904867	
11	3	16	73.3	1452	1413	8.980034	
12	3	16	50.2	1749	1865	9.548301	
13	2	16	83.1	1599		10.28278	
14	2	16	89.9	1282		10.70843	
15	2	16	52.7	1257		11.76641	

Statistics 5 (ChirpCenter Frequency: 5523.0 MHz)

Trial #	Pulse	Chirp(MHz)	Pulse Width (µS)	Pulse 1-2 spacing(µS)	Pulse 2-3 spacing(µS)	Pulse Start(S)	Detection (1:yes;0:no)
0	2	17	56.9	1130		0.969015	1
1	1	17	78.6			1.62231	
2	2	17	55.4	1003		3.133249	
3	2	17	96.2	1940		3.282086	
4	2	17	84	1053		4.97273	
5	2	17	95	1807		6.159311	
6	2	17	57.1	1537		7.452742	
7	2	17	86.6	1930		8.650229	
8	2	17	88.8	1199		9.098206	
9	1	17	69.2			10.3919	
10	1	17	60.9			11.06699	

Statistics 6 (ChirpCenter Frequency: 5524.0 MHz)

Trial #	Pulse	Chirp(MHz)	Pulse Width (µS)	Pulse 1-2 spacing(µS)	Pulse 2-3 spacing(µS)	Pulse Start(S)	Detection (1:yes;0:no)
0	2	14	63.2	1036		0.584097	1
1	1	14	74.7			1.872577	
2	1	14	79.8			3.080005	
3	2	14	73	1074		5.323343	
4	2	14	74.6	1656		5.344172	
5	2	14	66.9	1449		7.90455	
6	3	14	51.5	1187	1258	9.126166	
7	1	14	74.6			9.937217	
8	1	14	68.2			11.89737	

Statistics 7 (ChirpCenter Frequency: 5528.0 MHz)

Trial #	Pulse	Chirp(MHz)	Pulse Width (μS)	Pulse 1-2 spacing(μS)	Pulse 2-3 spacing(μS)	Pulse Start(S)	Detection (1:yes;0:no)
0	1	6	88.3			0.014124	1
1	2	6	59	1554		1.115965	
2	1	6	53.1			1.405353	
3	1	6	94.8			2.246899	
4	2	6	90.4	1108		2.79211	
5	1	6	56.1			3.425059	
6	1	6	83.5			4.382452	
7	3	6	76.8	1491	1255	5.023087	
8	2	6	95.8	1776		5.382845	
9	3	6	87	1684	1114	6.136284	
10	3	6	55.5	1379	1736	6.443799	
11	1	6	91.5			7.302443	
12	2	6	85.7	1527		7.624066	
13	1	6	75.8			8.681295	
14	1	6	90.1			9.436844	
15	3	6	59.3	1593	1878	9.754968	
16	3	6	80.1	1857	1609	10.67664	
17	2	6	94	1807		10.94341	
18	2	6	50.1	1220		11.84151	

Statistics 8 (ChirpCenter Frequency: 5526.0 MHz)

Trial #	Pulse	Chirp(MHz)	Pulse Width (μS)	Pulse 1-2 spacing(μS)	Pulse 2-3 spacing(μS)	Pulse Start(S)	Detection (1:yes;0:no)
0	3	9	54.8	1371	1066	0.516752	1
1	2	9	84.3	1945		0.820215	
2	2	9	88.8	1514		1.472485	
3	2	9	57	1668		2.413477	
4	2	9	83.2	1113		2.678541	
5	3	9	75.7	1011	1683	3.331356	
6	2	9	51.5	1472		4.229934	
7	2	9	97	1630		4.857012	
8	2	9	94.5	1836		5.370892	
9	2	9	92.3	1191		5.710002	
10	3	9	63.4	1006	1665	6.690295	
11	2	9	90.9	1471		7.361764	
12	1	9	52.1			7.81253	
13	3	9	66.3	1213	1301	8.651703	
14	3	9	53.6	1833	1361	8.940017	
15	2	9	90.1	1094		9.502711	
16	2	9	68.8	1701		10.33324	
17	3	9	56	1867	1357	11.01645	
18	2	9	67.1	1356		11.89254	

Statistics 9 (ChirpCenter Frequency: 5524.0 MHz)

Trial #	Pulse	Chirp(MHz)	Pulse Width (μS)	Pulse 1-2 spacing(μS)	Pulse 2-3 spacing(μS)	Pulse Start(S)	Detection (1:yes;0:no)
0	3	14	55.2	1235	1327	0.313281	1
1	1	14	87.8			1.385483	
2	2	14	58	1411		2.38724	
3	2	14	94.6	1771		2.771633	
4	3	14	59.5	1810	1530	4.131564	
5	3	14	57.9	1470	1686	5.083088	
6	2	14	93	1322		6.418633	
7	3	14	65.1	1092	1156	7.089607	
8	3	14	63.9	1736	1696	7.997372	
9	3	14	76.8	1192	1280	8.435974	
10	3	14	67.8	1082	1745	9.824625	
11	2	14	97	1555		10.2395	
12	1	14	71.9			11.27923	

Statistics 10 (ChirpCenter Frequency: 5526.0 MHz)

Trial #	Pulse	Chirp(MHz)	Pulse Width (μS)	Pulse 1-2 spacing(μS)	Pulse 2-3 spacing(μS)	Pulse Start(S)	Detection (1:yes;0:no)
0	2	9	54.6	1129		0.095455	1
1	3	9	98.7	1179	1093	0.786003	
2	2	9	87.9	1717		1.846498	
3	2	9	70	1362		2.427878	
4	1	9	57.3			3.115362	
5	2	9	67.1	1762		3.481444	
6	3	9	69.2	1551	1659	4.379548	
7	2	9	60.2	1042		4.584244	
8	1	9	99.7			5.102256	
9	2	9	55.8	1697		5.886408	
10	1	9	91.7			6.790948	
11	1	9	58.7			7.097074	
12	1	9	90.5			8.150653	
13	1	9	63.5			8.831934	
14	1	9	69.1			9.173111	
15	2	9	67.9	1081		9.61478	
16	1	9	68.2			10.40681	
17	2	9	69.2	1992		10.86362	
18	2	9	69.8	1141		11.71155	

Radar Type 6 Statistical Performance

Trial #	Fc (MHz)	Pulse /Burst	Pulse Width (µS)	PRI (µs)	Detection (1:yes; 0:no)	Hopping Sequence (MHz)
1	5510	9	1	333	1	5365.0, 5657.0, 5503.0, 5256.0, 5338.0, 5283.0, 5280.0, 5326.0, 5686.0, 5367.0, 5295.0, 5260.0, 5555.0, 5596.0, 5495.0, 5383.0, 5421.0, 5423.0, 5455.0, 5272.0, 5289.0, 5370.0, 5659.0, 5385.0, 5490.0, 5612.0, 5642.0, 5285.0, 5628.0, 5416.0, 5376.0, 5687.0, 5605.0, 5417.0, 5258.0, 5576.0, 5655.0, 5460.0, 5653.0, 5284.0, 5540.0, 5710.0, 5533.0, 5265.0, 5623.0, 5281.0, 5251.0, 5516.0, 5271.0, 5641.0, 5464.0, 5404.0, 5461.0, 5684.0, 5616.0, 5620.0, 5590.0, 5397.0, 5437.0, 5543.0, 5658.0, 5708.0, 5580.0, 5714.0, 5582.0, 5577.0, 5693.0, 5627.0, 5613.0, 5405.0, 5359.0, 5508.0, 5428.0, 5696.0, 5652.0, 5697.0, 5572.0, 5608.0, 5294.0, 5313.0, 5456.0, 5342.0, 5522.0, 5444.0, 5422.0, 5654.0, 5487.0, 5323.0, 5719.0, 5664.0, 5615.0, 5252.0, 5609.0, 5395.0, 5482.0, 5675.0, 5291.0, 5667.0, 5523.0, 5715.0 (number of hits: 7)
2	5510	9	1	333	1	5552.0, 5685.0, 5265.0, 5303.0, 5636.0, 5559.0, 5621.0, 5309.0, 5605.0, 5568.0, 5704.0, 5598.0, 5635.0, 5623.0, 5633.0, 5274.0, 5492.0, 5500.0, 5324.0, 5444.0, 5541.0, 5261.0, 5549.0, 5443.0, 5486.0, 5346.0, 5382.0, 5588.0, 5426.0, 5660.0, 5348.0, 5683.0, 5688.0, 5252.0, 5627.0, 5583.0, 5707.0, 5447.0, 5718.0, 5262.0, 5505.0, 5595.0, 5398.0, 5414.0, 5263.0, 5424.0, 5459.0, 5572.0, 5327.0, 5574.0, 5523.0, 5364.0, 5509.0, 5466.0, 5328.0, 5433.0, 5353.0, 5531.0, 5687.0, 5254.0, 5652.0, 5480.0, 5717.0, 5338.0, 5622.0, 5654.0, 5457.0, 5617.0, 5584.0, 5452.0, 5575.0, 5412.0, 5666.0, 5580.0, 5270.0, 5339.0, 5498.0, 5291.0, 5294.0, 5571.0, 5357.0, 5662.0, 5362.0, 5694.0, 5721.0, 5715.0, 5383.0, 5287.0, 5536.0, 5420.0, 5530.0, 5299.0, 5408.0, 5306.0, 5573.0, 5517.0, 5524.0, 5618.0, 5602.0, 5512.0 (number of hits: 9)
3	5510	9	1	333	1	5276.0, 5313.0, 5361.0, 5442.0,

						5338.0, 5607.0, 5716.0, 5587.0, 5592.0, 5453.0, 5380.0, 5677.0, 5432.0, 5297.0, 5623.0, 5340.0, 5516.0, 5305.0, 5343.0, 5478.0, 5601.0, 5341.0, 5368.0, 5582.0, 5590.0, 5699.0, 5427.0, 5647.0, 5640.0, 5575.0, 5301.0, 5721.0, 5664.0, 5499.0, 5409.0, 5308.0, 5591.0, 5598.0, 5508.0, 5556.0, 5302.0, 5416.0, 5462.0, 5467.0, 5522.0, 5483.0, 5714.0, 5446.0, 5481.0, 5685.0, 5419.0, 5286.0, 5345.0, 5660.0, 5424.0, 5460.0, 5370.0, 5312.0, 5291.0, 5548.0, 5566.0, 5675.0, 5319.0, 5363.0, 5452.0, 5332.0, 5497.0, 5309.0, 5517.0, 5399.0, 5270.0, 5657.0, 5612.0, 5480.0, 5526.0, 5627.0, 5535.0, 5693.0, 5610.0, 5498.0, 5358.0, 5613.0, 5434.0, 5289.0, 5712.0, 5605.0, 5470.0, 5389.0, 5373.0, 5584.0, 5486.0, 5342.0, 5280.0, 5692.0, 5614.0, 5519.0, 5281.0, 5718.0, 5410.0, 5417.0 (number of hits: 9)
4	5510	9	1	333	1	5310.0, 5466.0, 5706.0, 5258.0, 5698.0, 5541.0, 5619.0, 5509.0, 5525.0, 5472.0, 5504.0, 5354.0, 5352.0, 5265.0, 5612.0, 5291.0, 5315.0, 5443.0, 5361.0, 5251.0, 5657.0, 5718.0, 5490.0, 5383.0, 5684.0, 5426.0, 5444.0, 5681.0, 5410.0, 5340.0, 5306.0, 5285.0, 5653.0, 5424.0, 5553.0, 5680.0, 5425.0, 5695.0, 5376.0, 5671.0, 5345.0, 5717.0, 5623.0, 5689.0, 5411.0, 5390.0, 5586.0, 5529.0, 5508.0, 5697.0, 5423.0, 5578.0, 5324.0, 5318.0, 5445.0, 5455.0, 5547.0, 5642.0, 5254.0, 5696.0, 5533.0, 5514.0, 5605.0, 5554.0, 5637.0, 5673.0, 5276.0, 5482.0, 5646.0, 5626.0, 5357.0, 5446.0, 5290.0, 5451.0, 5632.0, 5365.0, 5304.0, 5415.0, 5460.0, 5693.0, 5585.0, 5362.0, 5332.0, 5470.0, 5600.0, 5296.0, 5465.0, 5500.0, 5435.0, 5568.0, 5515.0, 5297.0, 5667.0, 5641.0, 5367.0, 5314.0, 5403.0, 5386.0, 5661.0, 5493.0 (number of hits: 10)
5	5510	9	1	333	1	5571.0, 5253.0, 5543.0, 5640.0, 5388.0, 5524.0, 5558.0, 5336.0, 5516.0, 5411.0, 5656.0, 5261.0, 5648.0, 5380.0, 5501.0, 5631.0, 5370.0, 5537.0, 5510.0, 5678.0, 5664.0, 5437.0, 5561.0, 5654.0, 5643.0, 5266.0, 5506.0, 5467.0, 5394.0, 5592.0, 5556.0, 5491.0, 5270.0, 5532.0, 5618.0, 5585.0,

						5705.0, 5560.0, 5706.0, 5496.0, 5433.0, 5575.0, 5468.0, 5493.0, 5326.0, 5354.0, 5413.0, 5469.0, 5316.0, 5545.0, 5577.0, 5711.0, 5483.0, 5696.0, 5265.0, 5300.0, 5697.0, 5440.0, 5258.0, 5708.0, 5356.0, 5544.0, 5548.0, 5257.0, 5665.0, 5693.0, 5474.0, 5488.0, 5432.0, 5673.0, 5527.0, 5709.0, 5597.0, 5311.0, 5565.0, 5636.0, 5313.0, 5355.0, 5342.0, 5531.0, 5614.0, 5691.0, 5632.0, 5505.0, 5302.0, 5587.0, 5555.0, 5309.0, 5461.0, 5452.0, 5463.0, 5385.0, 5449.0, 5405.0, 5536.0, 5296.0, 5554.0, 5603.0, 5259.0, 5588.0 (number of hits: 10)
6	5510	9	1	333	1	5589.0, 5578.0, 5394.0, 5303.0, 5673.0, 5406.0, 5401.0, 5457.0, 5606.0, 5352.0, 5690.0, 5636.0, 5689.0, 5574.0, 5301.0, 5483.0, 5701.0, 5554.0, 5371.0, 5513.0, 5381.0, 5568.0, 5705.0, 5595.0, 5529.0, 5638.0, 5538.0, 5389.0, 5363.0, 5687.0, 5279.0, 5600.0, 5481.0, 5652.0, 5626.0, 5569.0, 5332.0, 5251.0, 5566.0, 5471.0, 5642.0, 5519.0, 5367.0, 5625.0, 5596.0, 5505.0, 5624.0, 5629.0, 5323.0, 5309.0, 5467.0, 5493.0, 5369.0, 5378.0, 5486.0, 5504.0, 5616.0, 5564.0, 5415.0, 5281.0, 5344.0, 5373.0, 5345.0, 5257.0, 5514.0, 5488.0, 5503.0, 5658.0, 5604.0, 5400.0, 5576.0, 5348.0, 5698.0, 5509.0, 5312.0, 5525.0, 5640.0, 5581.0, 5278.0, 5715.0, 5328.0, 5448.0, 5571.0, 5615.0, 5477.0, 5681.0, 5428.0, 5712.0, 5474.0, 5292.0, 5304.0, 5340.0, 5665.0, 5527.0, 5643.0, 5444.0, 5588.0, 5534.0, 5314.0, 5613.0 (number of hits: 11)
7	5510	9	1	333	1	5415.0, 5541.0, 5574.0, 5591.0, 5253.0, 5615.0, 5323.0, 5307.0, 5326.0, 5277.0, 5625.0, 5303.0, 5412.0, 5310.0, 5558.0, 5330.0, 5568.0, 5562.0, 5595.0, 5578.0, 5723.0, 5417.0, 5434.0, 5407.0, 5515.0, 5673.0, 5441.0, 5281.0, 5514.0, 5552.0, 5674.0, 5594.0, 5659.0, 5312.0, 5480.0, 5298.0, 5256.0, 5457.0, 5258.0, 5569.0, 5697.0, 5542.0, 5293.0, 5614.0, 5690.0, 5551.0, 5527.0, 5451.0, 5329.0, 5684.0, 5696.0, 5409.0, 5488.0, 5598.0, 5370.0, 5619.0, 5371.0, 5617.0, 5282.0, 5519.0, 5604.0, 5510.0, 5633.0, 5379.0, 5463.0, 5662.0, 5503.0, 5481.0,

						5652.0, 5516.0, 5492.0, 5254.0, 5419.0, 5612.0, 5411.0, 5525.0, 5709.0, 5268.0, 5486.0, 5265.0, 5385.0, 5328.0, 5720.0, 5406.0, 5398.0, 5374.0, 5648.0, 5388.0, 5676.0, 5426.0, 5580.0, 5493.0, 5627.0, 5349.0, 5502.0, 5357.0, 5592.0, 5276.0, 5442.0, 5704.0 (number of hits: 11)
8	5510	9	1	333	1	5364.0, 5636.0, 5311.0, 5316.0, 5340.0, 5265.0, 5594.0, 5707.0, 5529.0, 5413.0, 5427.0, 5591.0, 5713.0, 5336.0, 5564.0, 5647.0, 5600.0, 5635.0, 5387.0, 5714.0, 5608.0, 5655.0, 5410.0, 5643.0, 5419.0, 5501.0, 5656.0, 5539.0, 5318.0, 5482.0, 5615.0, 5692.0, 5315.0, 5628.0, 5658.0, 5651.0, 5261.0, 5612.0, 5437.0, 5719.0, 5283.0, 5513.0, 5438.0, 5508.0, 5433.0, 5507.0, 5568.0, 5682.0, 5498.0, 5590.0, 5487.0, 5716.0, 5489.0, 5624.0, 5284.0, 5481.0, 5693.0, 5581.0, 5447.0, 5361.0, 5444.0, 5663.0, 5327.0, 5477.0, 5604.0, 5256.0, 5312.0, 5322.0, 5338.0, 5701.0, 5723.0, 5566.0, 5510.0, 5391.0, 5347.0, 5672.0, 5323.0, 5689.0, 5550.0, 5547.0, 5614.0, 5295.0, 5563.0, 5422.0, 5335.0, 5712.0, 5587.0, 5690.0, 5685.0, 5250.0, 5648.0, 5495.0, 5686.0, 5706.0, 5530.0, 5445.0, 5459.0, 5544.0, 5255.0, 5631.0 (number of hits: 8)
9	5510	9	1	333	1	5715.0, 5429.0, 5518.0, 5367.0, 5426.0, 5460.0, 5408.0, 5385.0, 5441.0, 5262.0, 5348.0, 5310.0, 5627.0, 5425.0, 5457.0, 5695.0, 5471.0, 5488.0, 5612.0, 5420.0, 5252.0, 5717.0, 5353.0, 5491.0, 5636.0, 5696.0, 5421.0, 5652.0, 5681.0, 5567.0, 5538.0, 5427.0, 5354.0, 5326.0, 5587.0, 5434.0, 5478.0, 5437.0, 5383.0, 5630.0, 5708.0, 5338.0, 5333.0, 5312.0, 5690.0, 5676.0, 5481.0, 5543.0, 5419.0, 5287.0, 5502.0, 5295.0, 5688.0, 5325.0, 5381.0, 5455.0, 5415.0, 5646.0, 5613.0, 5650.0, 5698.0, 5662.0, 5443.0, 5569.0, 5442.0, 5645.0, 5673.0, 5649.0, 5454.0, 5459.0, 5687.0, 5331.0, 5628.0, 5321.0, 5719.0, 5465.0, 5626.0, 5482.0, 5468.0, 5397.0, 5718.0, 5282.0, 5492.0, 5678.0, 5402.0, 5524.0, 5659.0, 5285.0, 5562.0, 5395.0, 5559.0, 5495.0, 5398.0, 5431.0, 5412.0, 5288.0, 5713.0, 5510.0, 5526.0, 5255.0

						(number of hits: 8)
10	5510	9	1	333	1	5634.0, 5492.0, 5303.0, 5722.0, 5470.0, 5348.0, 5452.0, 5571.0, 5515.0, 5603.0, 5368.0, 5491.0, 5288.0, 5428.0, 5608.0, 5481.0, 5675.0, 5302.0, 5666.0, 5651.0, 5557.0, 5567.0, 5708.0, 5715.0, 5264.0, 5374.0, 5431.0, 5598.0, 5391.0, 5639.0, 5261.0, 5435.0, 5455.0, 5564.0, 5445.0, 5514.0, 5376.0, 5640.0, 5355.0, 5565.0, 5502.0, 5333.0, 5362.0, 5482.0, 5624.0, 5379.0, 5413.0, 5408.0, 5556.0, 5286.0, 5568.0, 5301.0, 5683.0, 5361.0, 5544.0, 5635.0, 5483.0, 5422.0, 5271.0, 5560.0, 5252.0, 5432.0, 5292.0, 5346.0, 5581.0, 5597.0, 5359.0, 5258.0, 5285.0, 5665.0, 5331.0, 5523.0, 5562.0, 5300.0, 5476.0, 5382.0, 5426.0, 5467.0, 5397.0, 5555.0, 5335.0, 5262.0, 5356.0, 5672.0, 5647.0, 5430.0, 5578.0, 5404.0, 5589.0, 5267.0, 5669.0, 5653.0, 5569.0, 5532.0, 5504.0, 5550.0, 5584.0, 5659.0, 5485.0, 5611.0
						(number of hits: 7)
11	5510	9	1	333	1	5404.0, 5440.0, 5558.0, 5402.0, 5618.0, 5459.0, 5313.0, 5307.0, 5376.0, 5302.0, 5577.0, 5518.0, 5708.0, 5545.0, 5635.0, 5464.0, 5289.0, 5400.0, 5470.0, 5299.0, 5702.0, 5628.0, 5691.0, 5279.0, 5479.0, 5593.0, 5680.0, 5598.0, 5601.0, 5575.0, 5501.0, 5604.0, 5502.0, 5336.0, 5532.0, 5418.0, 5461.0, 5274.0, 5325.0, 5687.0, 5672.0, 5507.0, 5480.0, 5432.0, 5355.0, 5595.0, 5556.0, 5304.0, 5650.0, 5589.0, 5583.0, 5323.0, 5424.0, 5703.0, 5629.0, 5363.0, 5658.0, 5659.0, 5315.0, 5272.0, 5364.0, 5663.0, 5388.0, 5294.0, 5494.0, 5345.0, 5696.0, 5327.0, 5320.0, 5688.0, 5306.0, 5516.0, 5665.0, 5700.0, 5268.0, 5723.0, 5596.0, 5314.0, 5539.0, 5446.0, 5321.0, 5634.0, 5550.0, 5377.0, 5407.0, 5333.0, 5525.0, 5317.0, 5510.0, 5380.0, 5469.0, 5574.0, 5348.0, 5412.0, 5655.0, 5324.0, 5614.0, 5562.0, 5616.0, 5436.0
						(number of hits: 8)
12	5510	9	1	333	1	5547.0, 5590.0, 5350.0, 5295.0, 5615.0, 5262.0, 5433.0, 5338.0, 5402.0, 5419.0, 5719.0, 5372.0, 5687.0, 5632.0, 5250.0, 5407.0, 5531.0, 5704.0, 5581.0, 5355.0, 5586.0, 5488.0, 5544.0, 5366.0, 5628.0, 5424.0, 5512.0, 5584.0,

						5334.0, 5384.0, 5455.0, 5406.0, 5498.0, 5396.0, 5712.0, 5672.0, 5723.0, 5298.0, 5284.0, 5559.0, 5312.0, 5601.0, 5320.0, 5574.0, 5258.0, 5376.0, 5443.0, 5653.0, 5477.0, 5367.0, 5431.0, 5289.0, 5568.0, 5351.0, 5630.0, 5429.0, 5645.0, 5297.0, 5552.0, 5519.0, 5614.0, 5622.0, 5546.0, 5307.0, 5476.0, 5381.0, 5481.0, 5333.0, 5256.0, 5472.0, 5389.0, 5364.0, 5588.0, 5500.0, 5413.0, 5629.0, 5623.0, 5272.0, 5442.0, 5611.0, 5540.0, 5575.0, 5646.0, 5697.0, 5538.0, 5587.0, 5684.0, 5517.0, 5595.0, 5459.0, 5346.0, 5608.0, 5673.0, 5386.0, 5612.0, 5288.0, 5514.0, 5616.0, 5534.0, 5451.0 (number of hits: 6)
13	5510	9	1	333	1	5616.0, 5427.0, 5318.0, 5682.0, 5442.0, 5541.0, 5707.0, 5623.0, 5351.0, 5638.0, 5612.0, 5696.0, 5676.0, 5580.0, 5594.0, 5603.0, 5280.0, 5690.0, 5494.0, 5534.0, 5681.0, 5556.0, 5439.0, 5418.0, 5518.0, 5276.0, 5379.0, 5417.0, 5600.0, 5475.0, 5625.0, 5340.0, 5430.0, 5695.0, 5391.0, 5473.0, 5332.0, 5353.0, 5517.0, 5509.0, 5278.0, 5669.0, 5713.0, 5308.0, 5364.0, 5659.0, 5560.0, 5451.0, 5502.0, 5250.0, 5684.0, 5361.0, 5279.0, 5719.0, 5432.0, 5350.0, 5526.0, 5388.0, 5629.0, 5283.0, 5592.0, 5655.0, 5621.0, 5321.0, 5608.0, 5644.0, 5652.0, 5552.0, 5575.0, 5302.0, 5574.0, 5266.0, 5315.0, 5324.0, 5631.0, 5397.0, 5662.0, 5383.0, 5591.0, 5506.0, 5254.0, 5589.0, 5403.0, 5544.0, 5426.0, 5497.0, 5528.0, 5425.0, 5445.0, 5310.0, 5636.0, 5312.0, 5303.0, 5522.0, 5314.0, 5269.0, 5557.0, 5514.0, 5327.0, 5376.0 (number of hits: 11)
14	5510	9	1	333	1	5545.0, 5553.0, 5580.0, 5478.0, 5311.0, 5508.0, 5298.0, 5465.0, 5707.0, 5512.0, 5557.0, 5623.0, 5443.0, 5483.0, 5720.0, 5278.0, 5272.0, 5675.0, 5436.0, 5486.0, 5701.0, 5558.0, 5672.0, 5631.0, 5540.0, 5487.0, 5554.0, 5269.0, 5662.0, 5524.0, 5316.0, 5396.0, 5616.0, 5294.0, 5455.0, 5645.0, 5426.0, 5581.0, 5440.0, 5565.0, 5597.0, 5521.0, 5402.0, 5505.0, 5686.0, 5281.0, 5289.0, 5605.0, 5399.0, 5333.0, 5538.0, 5344.0, 5361.0, 5618.0, 5574.0, 5577.0, 5427.0, 5551.0, 5514.0, 5314.0,

						5273.0, 5610.0, 5471.0, 5392.0, 5323.0, 5560.0, 5349.0, 5393.0, 5518.0, 5460.0, 5428.0, 5653.0, 5262.0, 5354.0, 5529.0, 5503.0, 5382.0, 5462.0, 5548.0, 5255.0, 5282.0, 5275.0, 5656.0, 5563.0, 5681.0, 5570.0, 5373.0, 5671.0, 5634.0, 5364.0, 5588.0, 5710.0, 5363.0, 5492.0, 5322.0, 5609.0, 5391.0, 5351.0, 5615.0, 5668.0 (number of hits: 10)
15	5510	9	1	333	1	5312.0, 5686.0, 5488.0, 5306.0, 5348.0, 5626.0, 5345.0, 5429.0, 5305.0, 5510.0, 5265.0, 5629.0, 5424.0, 5533.0, 5304.0, 5676.0, 5587.0, 5400.0, 5287.0, 5301.0, 5608.0, 5492.0, 5322.0, 5640.0, 5480.0, 5377.0, 5273.0, 5574.0, 5588.0, 5669.0, 5385.0, 5404.0, 5617.0, 5570.0, 5448.0, 5366.0, 5589.0, 5605.0, 5476.0, 5362.0, 5437.0, 5398.0, 5280.0, 5320.0, 5387.0, 5298.0, 5432.0, 5453.0, 5548.0, 5566.0, 5553.0, 5562.0, 5691.0, 5549.0, 5270.0, 5483.0, 5255.0, 5648.0, 5423.0, 5459.0, 5702.0, 5572.0, 5559.0, 5624.0, 5522.0, 5708.0, 5707.0, 5471.0, 5578.0, 5670.0, 5646.0, 5413.0, 5661.0, 5275.0, 5667.0, 5560.0, 5303.0, 5664.0, 5703.0, 5467.0, 5627.0, 5297.0, 5607.0, 5606.0, 5699.0, 5622.0, 5630.0, 5611.0, 5598.0, 5637.0, 5595.0, 5302.0, 5518.0, 5567.0, 5465.0, 5256.0, 5285.0, 5652.0, 5641.0, 5341.0 (number of hits: 4)
16	5510	9	1	333	1	5458.0, 5574.0, 5640.0, 5277.0, 5710.0, 5698.0, 5717.0, 5266.0, 5370.0, 5600.0, 5684.0, 5694.0, 5417.0, 5620.0, 5722.0, 5495.0, 5377.0, 5340.0, 5527.0, 5618.0, 5509.0, 5328.0, 5613.0, 5653.0, 5330.0, 5382.0, 5410.0, 5497.0, 5565.0, 5304.0, 5542.0, 5326.0, 5629.0, 5471.0, 5590.0, 5254.0, 5596.0, 5255.0, 5607.0, 5271.0, 5357.0, 5397.0, 5554.0, 5724.0, 5260.0, 5630.0, 5387.0, 5258.0, 5292.0, 5445.0, 5669.0, 5364.0, 5679.0, 5519.0, 5478.0, 5500.0, 5419.0, 5659.0, 5496.0, 5422.0, 5282.0, 5289.0, 5544.0, 5534.0, 5264.0, 5671.0, 5637.0, 5257.0, 5580.0, 5348.0, 5302.0, 5711.0, 5468.0, 5643.0, 5502.0, 5259.0, 5488.0, 5561.0, 5665.0, 5308.0, 5427.0, 5315.0, 5349.0, 5660.0, 5562.0, 5443.0, 5693.0, 5313.0, 5504.0, 5510.0, 5311.0, 5540.0

						5452.0, 5632.0, 5305.0, 5283.0, 5408.0, 5588.0, 5414.0, 5685.0 (number of hits: 10)
17	5510	9	1	333	1	5589.0, 5638.0, 5667.0, 5496.0, 5571.0, 5580.0, 5588.0, 5494.0, 5679.0, 5525.0, 5645.0, 5691.0, 5402.0, 5274.0, 5317.0, 5506.0, 5273.0, 5347.0, 5315.0, 5444.0, 5333.0, 5585.0, 5700.0, 5406.0, 5539.0, 5634.0, 5256.0, 5271.0, 5356.0, 5611.0, 5285.0, 5695.0, 5519.0, 5336.0, 5415.0, 5514.0, 5655.0, 5457.0, 5358.0, 5335.0, 5564.0, 5669.0, 5699.0, 5523.0, 5469.0, 5568.0, 5463.0, 5643.0, 5328.0, 5569.0, 5663.0, 5255.0, 5615.0, 5575.0, 5703.0, 5372.0, 5292.0, 5288.0, 5410.0, 5460.0, 5462.0, 5630.0, 5708.0, 5704.0, 5536.0, 5581.0, 5310.0, 5449.0, 5665.0, 5651.0, 5316.0, 5535.0, 5628.0, 5520.0, 5421.0, 5413.0, 5658.0, 5606.0, 5596.0, 5464.0, 5672.0, 5376.0, 5325.0, 5262.0, 5656.0, 5423.0, 5653.0, 5373.0, 5427.0, 5517.0, 5542.0, 5253.0, 5481.0, 5485.0, 5712.0, 5614.0, 5566.0, 5417.0, 5549.0, 5312.0 (number of hits: 9)
18	5510	9	1	333	1	5646.0, 5538.0, 5649.0, 5683.0, 5579.0, 5444.0, 5298.0, 5272.0, 5663.0, 5668.0, 5522.0, 5597.0, 5261.0, 5596.0, 5721.0, 5472.0, 5429.0, 5326.0, 5373.0, 5410.0, 5267.0, 5357.0, 5591.0, 5505.0, 5480.0, 5696.0, 5644.0, 5389.0, 5655.0, 5347.0, 5461.0, 5570.0, 5586.0, 5512.0, 5420.0, 5310.0, 5435.0, 5390.0, 5494.0, 5466.0, 5422.0, 5308.0, 5257.0, 5328.0, 5477.0, 5364.0, 5638.0, 5498.0, 5354.0, 5263.0, 5650.0, 5376.0, 5631.0, 5676.0, 5334.0, 5356.0, 5633.0, 5682.0, 5275.0, 5481.0, 5567.0, 5554.0, 5469.0, 5672.0, 5406.0, 5618.0, 5394.0, 5539.0, 5309.0, 5548.0, 5621.0, 5623.0, 5483.0, 5416.0, 5303.0, 5722.0, 5392.0, 5685.0, 5545.0, 5388.0, 5590.0, 5603.0, 5330.0, 5344.0, 5589.0, 5475.0, 5400.0, 5637.0, 5705.0, 5689.0, 5667.0, 5711.0, 5265.0, 5560.0, 5612.0, 5458.0, 5493.0, 5371.0, 5657.0, 5564.0 (number of hits: 6)
19	5510	9	1	333	1	5476.0, 5306.0, 5376.0, 5691.0, 5665.0, 5577.0, 5356.0, 5616.0, 5492.0, 5609.0, 5359.0, 5695.0, 5310.0, 5384.0, 5342.0, 5410.0, 5293.0, 5269.0, 5565.0, 5314.0,

						5383.0, 5519.0, 5521.0, 5488.0, 5472.0, 5373.0, 5267.0, 5377.0, 5369.0, 5321.0, 5581.0, 5450.0, 5432.0, 5693.0, 5679.0, 5292.0, 5671.0, 5613.0, 5635.0, 5719.0, 5381.0, 5614.0, 5582.0, 5672.0, 5615.0, 5528.0, 5467.0, 5362.0, 5641.0, 5422.0, 5419.0, 5664.0, 5617.0, 5274.0, 5555.0, 5265.0, 5380.0, 5353.0, 5585.0, 5673.0, 5368.0, 5524.0, 5289.0, 5678.0, 5375.0, 5662.0, 5261.0, 5451.0, 5264.0, 5262.0, 5677.0, 5624.0, 5699.0, 5316.0, 5343.0, 5366.0, 5354.0, 5526.0, 5312.0, 5657.0, 5337.0, 5328.0, 5358.0, 5687.0, 5371.0, 5487.0, 5706.0, 5355.0, 5445.0, 5506.0, 5459.0, 5414.0, 5605.0, 5651.0, 5502.0, 5436.0, 5493.0, 5391.0, 5656.0, 5295.0 (number of hits: 9)
20	5510	9	1	333	1	5694.0, 5559.0, 5281.0, 5483.0, 5363.0, 5371.0, 5532.0, 5408.0, 5423.0, 5618.0, 5713.0, 5433.0, 5447.0, 5364.0, 5485.0, 5340.0, 5464.0, 5297.0, 5431.0, 5417.0, 5533.0, 5331.0, 5686.0, 5351.0, 5467.0, 5471.0, 5411.0, 5421.0, 5680.0, 5691.0, 5624.0, 5637.0, 5368.0, 5362.0, 5518.0, 5493.0, 5679.0, 5700.0, 5692.0, 5337.0, 5526.0, 5305.0, 5648.0, 5453.0, 5416.0, 5402.0, 5683.0, 5361.0, 5583.0, 5572.0, 5563.0, 5611.0, 5487.0, 5445.0, 5489.0, 5292.0, 5600.0, 5668.0, 5436.0, 5406.0, 5588.0, 5665.0, 5333.0, 5438.0, 5608.0, 5322.0, 5372.0, 5586.0, 5475.0, 5570.0, 5353.0, 5257.0, 5384.0, 5682.0, 5639.0, 5286.0, 5632.0, 5397.0, 5599.0, 5329.0, 5540.0, 5270.0, 5321.0, 5367.0, 5721.0, 5277.0, 5461.0, 5252.0, 5685.0, 5696.0, 5261.0, 5640.0, 5426.0, 5488.0, 5347.0, 5316.0, 5285.0, 5590.0, 5391.0, 5346.0 (number of hits: 3)
21	5510	9	1	333	1	5684.0, 5371.0, 5260.0, 5694.0, 5483.0, 5467.0, 5655.0, 5536.0, 5620.0, 5578.0, 5703.0, 5669.0, 5650.0, 5679.0, 5421.0, 5270.0, 5571.0, 5283.0, 5329.0, 5586.0, 5600.0, 5488.0, 5393.0, 5587.0, 5405.0, 5372.0, 5662.0, 5450.0, 5541.0, 5606.0, 5616.0, 5364.0, 5686.0, 5439.0, 5551.0, 5496.0, 5663.0, 5592.0, 5306.0, 5254.0, 5252.0, 5347.0, 5296.0, 5264.0, 5588.0, 5391.0, 5555.0, 5430.0, 5251.0, 5384.0, 5279.0, 5608.0,

						5504.0, 5696.0, 5658.0, 5418.0, 5470.0, 5276.0, 5516.0, 5612.0, 5595.0, 5473.0, 5689.0, 5546.0, 5512.0, 5476.0, 5290.0, 5425.0, 5537.0, 5256.0, 5705.0, 5720.0, 5675.0, 5302.0, 5363.0, 5624.0, 5672.0, 5357.0, 5298.0, 5300.0, 5531.0, 5490.0, 5456.0, 5519.0, 5378.0, 5591.0, 5547.0, 5574.0, 5414.0, 5411.0, 5398.0, 5494.0, 5603.0, 5458.0, 5336.0, 5525.0, 5635.0, 5432.0, 5387.0, 5498.0 (number of hits: 9)
22	5510	9	1	333	1	5651.0, 5487.0, 5348.0, 5463.0, 5685.0, 5459.0, 5396.0, 5405.0, 5602.0, 5631.0, 5260.0, 5372.0, 5444.0, 5261.0, 5281.0, 5705.0, 5495.0, 5326.0, 5315.0, 5539.0, 5436.0, 5388.0, 5455.0, 5616.0, 5597.0, 5721.0, 5380.0, 5722.0, 5549.0, 5320.0, 5471.0, 5587.0, 5711.0, 5251.0, 5583.0, 5676.0, 5613.0, 5256.0, 5313.0, 5339.0, 5302.0, 5286.0, 5551.0, 5469.0, 5525.0, 5678.0, 5267.0, 5478.0, 5476.0, 5642.0, 5536.0, 5414.0, 5336.0, 5422.0, 5296.0, 5707.0, 5724.0, 5527.0, 5653.0, 5553.0, 5543.0, 5352.0, 5697.0, 5681.0, 5264.0, 5391.0, 5668.0, 5605.0, 5357.0, 5567.0, 5508.0, 5480.0, 5358.0, 5486.0, 5497.0, 5531.0, 5682.0, 5548.0, 5699.0, 5499.0, 5643.0, 5262.0, 5322.0, 5573.0, 5690.0, 5635.0, 5468.0, 5280.0, 5318.0, 5563.0, 5564.0, 5429.0, 5654.0, 5279.0, 5343.0, 5274.0, 5679.0, 5593.0, 5304.0, 5578.0 (number of hits: 6)
23	5510	9	1	333	1	5568.0, 5269.0, 5686.0, 5564.0, 5408.0, 5355.0, 5506.0, 5588.0, 5507.0, 5533.0, 5714.0, 5520.0, 5650.0, 5394.0, 5710.0, 5397.0, 5484.0, 5572.0, 5560.0, 5363.0, 5510.0, 5436.0, 5340.0, 5718.0, 5322.0, 5466.0, 5402.0, 5595.0, 5687.0, 5504.0, 5477.0, 5502.0, 5396.0, 5452.0, 5305.0, 5654.0, 5679.0, 5253.0, 5640.0, 5296.0, 5585.0, 5313.0, 5625.0, 5482.0, 5492.0, 5295.0, 5318.0, 5701.0, 5642.0, 5377.0, 5613.0, 5323.0, 5631.0, 5392.0, 5643.0, 5405.0, 5571.0, 5496.0, 5428.0, 5361.0, 5251.0, 5697.0, 5254.0, 5521.0, 5418.0, 5404.0, 5442.0, 5285.0, 5422.0, 5676.0, 5443.0, 5400.0, 5425.0, 5289.0, 5391.0, 5447.0, 5331.0, 5301.0, 5549.0, 5274.0, 5385.0, 5395.0, 5337.0, 5461.0,

						5381.0, 5579.0, 5532.0, 5268.0, 5675.0, 5255.0, 5374.0, 5488.0, 5660.0, 5352.0, 5641.0, 5271.0, 5416.0, 5398.0, 5586.0, 5393.0 (number of hits: 9)
24	5510	9	1	333	1	5356.0, 5643.0, 5674.0, 5489.0, 5281.0, 5264.0, 5638.0, 5369.0, 5315.0, 5711.0, 5314.0, 5600.0, 5335.0, 5458.0, 5390.0, 5618.0, 5366.0, 5527.0, 5377.0, 5400.0, 5561.0, 5627.0, 5385.0, 5514.0, 5358.0, 5354.0, 5712.0, 5371.0, 5686.0, 5334.0, 5722.0, 5265.0, 5518.0, 5372.0, 5541.0, 5570.0, 5652.0, 5610.0, 5261.0, 5453.0, 5646.0, 5443.0, 5298.0, 5479.0, 5687.0, 5668.0, 5521.0, 5279.0, 5694.0, 5556.0, 5456.0, 5282.0, 5677.0, 5425.0, 5684.0, 5619.0, 5693.0, 5548.0, 5325.0, 5480.0, 5342.0, 5455.0, 5611.0, 5665.0, 5584.0, 5568.0, 5345.0, 5483.0, 5536.0, 5529.0, 5263.0, 5477.0, 5515.0, 5376.0, 5393.0, 5284.0, 5368.0, 5535.0, 5439.0, 5700.0, 5626.0, 5484.0, 5531.0, 5399.0, 5709.0, 5426.0, 5526.0, 5516.0, 5671.0, 5498.0, 5572.0, 5503.0, 5562.0, 5331.0, 5658.0, 5460.0, 5717.0, 5620.0, 5577.0, 5617.0 (number of hits: 10)
25	5510	9	1	333	1	5414.0, 5535.0, 5639.0, 5416.0, 5587.0, 5289.0, 5529.0, 5608.0, 5630.0, 5615.0, 5263.0, 5415.0, 5640.0, 5393.0, 5600.0, 5622.0, 5276.0, 5596.0, 5651.0, 5341.0, 5621.0, 5406.0, 5606.0, 5269.0, 5375.0, 5716.0, 5565.0, 5562.0, 5461.0, 5454.0, 5442.0, 5540.0, 5362.0, 5327.0, 5541.0, 5290.0, 5558.0, 5636.0, 5386.0, 5409.0, 5561.0, 5648.0, 5381.0, 5681.0, 5464.0, 5267.0, 5637.0, 5272.0, 5377.0, 5350.0, 5456.0, 5720.0, 5584.0, 5478.0, 5458.0, 5372.0, 5475.0, 5444.0, 5616.0, 5686.0, 5723.0, 5598.0, 5607.0, 5537.0, 5291.0, 5673.0, 5510.0, 5449.0, 5307.0, 5462.0, 5268.0, 5265.0, 5577.0, 5472.0, 5446.0, 5261.0, 5694.0, 5418.0, 5348.0, 5274.0, 5532.0, 5380.0, 5271.0, 5574.0, 5397.0, 5498.0, 5546.0, 5717.0, 5515.0, 5605.0, 5663.0, 5387.0, 5480.0, 5520.0, 5624.0, 5323.0, 5357.0, 5667.0, 5633.0, 5602.0 (number of hits: 5)
26	5510	9	1	333	1	5597.0, 5296.0, 5586.0, 5314.0, 5303.0, 5398.0, 5619.0, 5432.0, 5334.0, 5721.0, 5293.0, 5528.0,

						5637.0, 5270.0, 5417.0, 5690.0, 5377.0, 5572.0, 5406.0, 5356.0, 5629.0, 5540.0, 5265.0, 5426.0, 5585.0, 5633.0, 5720.0, 5333.0, 5559.0, 5328.0, 5338.0, 5569.0, 5530.0, 5256.0, 5457.0, 5251.0, 5714.0, 5505.0, 5253.0, 5563.0, 5354.0, 5527.0, 5418.0, 5626.0, 5700.0, 5483.0, 5694.0, 5388.0, 5662.0, 5350.0, 5290.0, 5407.0, 5419.0, 5666.0, 5476.0, 5539.0, 5493.0, 5498.0, 5325.0, 5693.0, 5496.0, 5474.0, 5302.0, 5555.0, 5636.0, 5561.0, 5523.0, 5448.0, 5639.0, 5332.0, 5339.0, 5591.0, 5716.0, 5545.0, 5687.0, 5459.0, 5649.0, 5621.0, 5688.0, 5254.0, 5393.0, 5614.0, 5266.0, 5722.0, 5494.0, 5285.0, 5411.0, 5478.0, 5582.0, 5405.0, 5570.0, 5710.0, 5401.0, 5689.0, 5515.0, 5524.0, 5510.0, 5409.0, 5410.0, 5616.0 (number of hits: 11)
27	5510	9	1	333	1	5380.0, 5550.0, 5610.0, 5697.0, 5555.0, 5311.0, 5419.0, 5654.0, 5331.0, 5634.0, 5487.0, 5706.0, 5438.0, 5468.0, 5309.0, 5364.0, 5720.0, 5299.0, 5541.0, 5602.0, 5578.0, 5618.0, 5582.0, 5488.0, 5512.0, 5604.0, 5345.0, 5359.0, 5296.0, 5377.0, 5600.0, 5322.0, 5464.0, 5253.0, 5289.0, 5362.0, 5495.0, 5361.0, 5643.0, 5272.0, 5637.0, 5437.0, 5395.0, 5594.0, 5257.0, 5557.0, 5339.0, 5456.0, 5294.0, 5678.0, 5551.0, 5588.0, 5391.0, 5376.0, 5400.0, 5360.0, 5399.0, 5639.0, 5324.0, 5574.0, 5640.0, 5518.0, 5379.0, 5461.0, 5571.0, 5576.0, 5356.0, 5675.0, 5442.0, 5696.0, 5538.0, 5443.0, 5333.0, 5630.0, 5523.0, 5712.0, 5572.0, 5528.0, 5585.0, 5344.0, 5431.0, 5455.0, 5516.0, 5723.0, 5367.0, 5564.0, 5617.0, 5619.0, 5258.0, 5267.0, 5686.0, 5290.0, 5428.0, 5265.0, 5620.0, 5613.0, 5412.0, 5699.0, 5553.0, 5477.0 (number of hits: 6)
28	5510	9	1	333	1	5446.0, 5254.0, 5274.0, 5575.0, 5397.0, 5323.0, 5568.0, 5534.0, 5273.0, 5401.0, 5632.0, 5661.0, 5715.0, 5379.0, 5383.0, 5458.0, 5704.0, 5459.0, 5428.0, 5682.0, 5411.0, 5266.0, 5548.0, 5657.0, 5301.0, 5389.0, 5494.0, 5321.0, 5540.0, 5341.0, 5635.0, 5539.0, 5544.0, 5415.0, 5412.0, 5652.0, 5520.0, 5518.0, 5405.0, 5447.0, 5686.0, 5448.0, 5331.0, 5351.0,

						5355.0, 5526.0, 5530.0, 5461.0, 5381.0, 5370.0, 5314.0, 5426.0, 5665.0, 5588.0, 5317.0, 5347.0, 5487.0, 5371.0, 5252.0, 5610.0, 5491.0, 5576.0, 5284.0, 5407.0, 5372.0, 5279.0, 5358.0, 5409.0, 5410.0, 5281.0, 5466.0, 5528.0, 5601.0, 5681.0, 5488.0, 5630.0, 5441.0, 5440.0, 5309.0, 5465.0, 5692.0, 5289.0, 5396.0, 5714.0, 5257.0, 5590.0, 5694.0, 5303.0, 5667.0, 5424.0, 5388.0, 5270.0, 5302.0, 5671.0, 5605.0, 5643.0, 5346.0, 5478.0, 5277.0, 5256.0 (number of hits: 6)
29	5510	9	1	333	1	5701.0, 5514.0, 5477.0, 5391.0, 5647.0, 5428.0, 5360.0, 5424.0, 5513.0, 5435.0, 5665.0, 5542.0, 5584.0, 5645.0, 5517.0, 5601.0, 5706.0, 5686.0, 5452.0, 5276.0, 5567.0, 5483.0, 5561.0, 5530.0, 5280.0, 5266.0, 5272.0, 5715.0, 5332.0, 5479.0, 5655.0, 5650.0, 5294.0, 5308.0, 5315.0, 5632.0, 5253.0, 5309.0, 5494.0, 5409.0, 5456.0, 5609.0, 5503.0, 5471.0, 5448.0, 5414.0, 5459.0, 5306.0, 5303.0, 5535.0, 5599.0, 5506.0, 5378.0, 5255.0, 5257.0, 5510.0, 5619.0, 5383.0, 5551.0, 5635.0, 5680.0, 5299.0, 5597.0, 5643.0, 5588.0, 5354.0, 5395.0, 5721.0, 5320.0, 5487.0, 5685.0, 5507.0, 5636.0, 5625.0, 5314.0, 5401.0, 5663.0, 5304.0, 5431.0, 5682.0, 5653.0, 5374.0, 5348.0, 5718.0, 5644.0, 5662.0, 5347.0, 5259.0, 5296.0, 5670.0, 5570.0, 5495.0, 5502.0, 5497.0, 5441.0, 5358.0, 5421.0, 5269.0, 5669.0, 5571.0 (number of hits: 11)
30	5510	9	1	333	1	5292.0, 5586.0, 5510.0, 5383.0, 5571.0, 5430.0, 5696.0, 5332.0, 5519.0, 5605.0, 5682.0, 5659.0, 5305.0, 5507.0, 5515.0, 5621.0, 5266.0, 5685.0, 5516.0, 5287.0, 5545.0, 5538.0, 5419.0, 5333.0, 5394.0, 5687.0, 5655.0, 5549.0, 5583.0, 5267.0, 5651.0, 5389.0, 5703.0, 5701.0, 5279.0, 5477.0, 5475.0, 5255.0, 5483.0, 5649.0, 5584.0, 5374.0, 5573.0, 5411.0, 5379.0, 5707.0, 5450.0, 5437.0, 5439.0, 5481.0, 5391.0, 5271.0, 5476.0, 5645.0, 5453.0, 5528.0, 5679.0, 5322.0, 5599.0, 5482.0, 5479.0, 5400.0, 5285.0, 5527.0, 5408.0, 5676.0, 5275.0, 5282.0, 5290.0, 5492.0, 5346.0, 5441.0, 5705.0, 5641.0, 5622.0, 5598.0,

						5643.0, 5529.0, 5469.0, 5449.0, 5489.0, 5309.0, 5388.0, 5562.0, 5390.0, 5251.0, 5462.0, 5369.0, 5429.0, 5506.0, 5357.0, 5415.0, 5375.0, 5664.0, 5397.0, 5521.0, 5692.0, 5410.0, 5342.0, 5518.0 (number of hits: 12)
--	--	--	--	--	--	--

80MHz

Radar SignalType	Waveform/Trial Number	Detection (%)	Limit (%)	Pass/Fail
Type 1A	15	100%	60%	pass
Type 1B	15	100%	60%	pass
Type 2	30	96.7 %	60%	Pass
Type 3	30	90 %	60%	Pass
Type 4	30	96.7 %	60%	Pass
Aggregate(Type1 to 4)	120	95.8%	80%	Pass
Type 5	30	93.3 %	80%	Pass
Type 6	30	100 %	70%	Pass

Please refer to the following statistical tables:

5530MHz**Radar Type 1A Statistical Performance**

Trial #	Fc (MHz)	Pulse/Burst	Pulse Width (μS)	PRI (μs)	Detection (1:yes; 0:no)
1	5530	63	1	838	1
2	5530	18	1	3066	1
3	5530	61	1	878	1
4	5530	86	1	618	1
5	5530	59	1	898	1
6	5530	78	1	678	1
7	5530	76	1	698	1
8	5530	83	1	638	1
9	5530	72	1	738	1
10	5530	67	1	798	1
11	5530	58	1	918	1
12	5530	95	1	558	1
13	5530	81	1	658	1
14	5530	74	1	718	1
15	5530	92	1	578	1
Detection Percentage: 100 % (>60%)					

Radar Type 1B Statistical Performance

Trial #	Fc (MHz)	Pulse/Burst	Pulse Width (μS)	PRI (μs)	Detection (1:yes; 0:no)
1	5530	21	1	2616	1
2	5530	39	1	1383	1
3	5530	60	1	885	1
4	5530	94	1	562	1
5	5530	46	1	1158	1
6	5530	26	1	2088	1
7	5530	78	1	682	1
8	5530	21	1	2558	1
9	5530	24	1	2266	1
10	5530	49	1	1079	1
11	5530	85	1	627	1
12	5530	44	1	1222	1
13	5530	25	1	2153	1
14	5530	23	1	2321	1
15	5530	28	1	1914	1
Detection Percentage: 100 % (>60%)					

Radar Type 2 Statistical Performance

Trial #	Fc (MHz)	Pulse/Burst	Pulse Width (μS)	PRI (μs)	Detection (1:yes; 0:no)
1	5530	28	1.3	182	1
2	5530	27	1	210	1
3	5530	27	4.5	161	1
4	5530	28	4	165	1
5	5530	24	4.2	170	1
6	5530	23	2.5	223	1
7	5530	23	4.6	159	1
8	5530	26	2.6	208	1
9	5530	27	4.6	158	1
10	5530	24	1	181	1
11	5530	25	2.5	225	1
12	5530	27	3.6	155	1
13	5530	27	1.9	171	1
14	5530	28	3	214	1
15	5530	29	2.9	192	1
16	5530	23	2.3	168	1
17	5530	24	2.8	174	1
18	5530	26	4.3	153	1
19	5530	28	3.9	193	1
20	5530	23	1.3	174	1
21	5530	29	1.8	176	1
22	5530	29	4.4	219	1
23	5530	25	4.4	153	1
24	5530	24	3.7	209	1
25	5530	23	1.2	227	1
26	5530	26	2.8	222	1
27	5530	28	1.2	223	1
28	5530	25	3.1	150	0
29	5530	24	4.3	211	1
30	5530	28	2.3	211	1
Detection Percentage: 96.7 % (>60%)					

Radar Type 3 Statistical Performance

Trial #	Fc (MHz)	Pulse/Burst	Pulse Width (µS)	PRI (µs)	Detection (1:yes; 0:no)
1	5530	17	8.7	344	1
2	5530	16	6	473	1
3	5530	18	7.3	203	1
4	5530	16	9.1	223	1
5	5530	17	6.1	267	1
6	5530	18	9.5	272	1
7	5530	17	8.4	466	1
8	5530	17	6.8	324	1
9	5530	18	8.3	464	1
10	5530	17	7.6	301	1
11	5530	18	6.8	200	1
12	5530	16	8.1	465	1
13	5530	16	7.9	224	1
14	5530	16	7.1	489	1
15	5530	16	7.1	415	1
16	5530	16	6.9	427	1
17	5530	17	9	378	0
18	5530	16	8.1	334	1
19	5530	16	6.4	266	1
20	5530	17	6.9	262	1
21	5530	18	9.4	259	1
22	5530	17	8.1	483	1
23	5530	17	6.9	493	1
24	5530	18	6.8	404	0
25	5530	18	9.2	379	1
26	5530	16	6.7	496	1
27	5530	18	8.2	421	0
28	5530	18	9.7	225	1
29	5530	17	7.9	232	1
30	5530	18	7.8	270	1
Detection Percentage: 90 % (>60%)					

Radar Type 4 Statistical Performance

Trial #	Fc (MHz)	Pulse/Burst	Pulse Width (µS)	PRI (µs)	Detection (1:yes; 0:no)
1	5530	16	12.5	273	1
2	5530	16	18.1	410	0
3	5530	16	17.7	395	1
4	5530	14	16.9	361	1
5	5530	14	13.8	363	1
6	5530	13	15.4	281	1
7	5530	12	13.7	389	1
8	5530	15	19.4	423	1
9	5530	14	15.7	224	1
10	5530	13	13.1	462	1
11	5530	16	13.7	277	1
12	5530	14	11.4	242	1
13	5530	16	20	426	1
14	5530	15	17.1	273	1
15	5530	12	18.5	312	1
16	5530	14	13	472	1
17	5530	12	15.4	384	1
18	5530	14	14.3	275	1
19	5530	16	17.9	303	1
20	5530	12	19.3	244	1
21	5530	12	12.8	269	1
22	5530	13	14.4	224	1
23	5530	16	11.2	299	1
24	5530	16	17.9	462	1
25	5530	12	13.6	205	1
26	5530	16	14.4	433	1
27	5530	15	13.9	295	1
28	5530	14	17.8	406	1
29	5530	14	13.3	420	1
30	5530	13	13	223	1
Detection Percentage: 96.7 % (>60%)					

Radar Type 5 Case 1 Statistical Performance

Statistics 1 (ChirpCenter Frequency: 5530.0MHz)

Trial #	Pulse	Chirp(MHz)	Pulse Width (μS)	Pulse 1-2 spacing(μS)	Pulse 2-3 spacing(μS)	Pulse Start(S)	Detection (1:yes;0:no)
0	3	13	89.8	1213	1050	0.230974	1
1	1	13	55.9			1.159202	
2	2	13	62.9	1653		2.319084	
3	2	13	76.6	1586		2.917641	
4	2	13	91	1896		3.412241	
5	3	13	71.1	1080	1108	4.026587	
6	3	13	65.1	1814	1267	4.966246	
7	1	13	79.9			6.217114	
8	1	13	51.7			6.902938	
9	1	13	83.1			7.526138	
10	2	13	60.5	1139		8.533862	
11	2	13	86.9	1677		9.211642	
12	1	13	83.1			9.943507	
13	3	13	85.7	1762	1353	10.59121	
14	2	13	52.7	1780		11.49329	

Statistics 2 (ChirpCenter Frequency: 5530.0 MHz)

Trial #	Pulse	Chirp(MHz)	Pulse Width (μS)	Pulse 1-2 spacing(μS)	Pulse 2-3 spacing(μS)	Pulse Start(S)	Detection (1:yes;0:no)
0	2	7	60.6	1408		0.69947	1
1	2	7	53	1152		2.215397	
2	3	7	92.6	1799	1974	3.542017	
3	1	7	93			4.586145	
4	1	7	68.1			5.253747	
5	2	7	88	1886		6.414579	
6	1	7	98.8			8.023458	
7	1	7	65.8			8.643648	
8	2	7	62.1	1634		10.29724	
9	3	7	69.9	1617	1569	11.83912	

Statistics 3 (ChirpCenter Frequency: 5530.0 MHz)

Trial #	Pulse	Chirp(MHz)	Pulse Width (μS)	Pulse 1-2 spacing(μS)	Pulse 2-3 spacing(μS)	Pulse Start(S)	Detection (1:yes;0:no)
0	3	8	55.2	1828	1928	0.389648	1
1	2	8	99.9	1052		1.139641	
2	1	8	95.1			1.908228	
3	3	8	57	1906	1749	3.454558	
4	3	8	75.2	1249	1211	3.753655	
5	2	8	65.6	1308		5.478482	
6	2	8	59.4	1610		5.821068	
7	2	8	99.1	1173		6.837789	
8	2	8	76.3	1438		7.639366	
9	2	8	76.2	1371		9.041342	
10	1	8	95.1			9.681248	
11	3	8	57.3	1878	1202	10.95703	
12	2	8	93.9	1524		11.85212	

Statistics 4 (ChirpCenter Frequency: 5530.0 MHz)

Trial #	Pulse	Chirp(MHz)	Pulse Width (μS)	Pulse 1-2 spacing(μS)	Pulse 2-3 spacing(μS)	Pulse Start(S)	Detection (1:yes;0:no)
0	2	15	73.7	1970		0.480167	1
1	3	15	72	1935	1370	1.25666	
2	1	15	80.9			2.186159	
3	3	15	53.6	1041	1414	2.976331	
4	2	15	56.7	1857		3.734513	
5	2	15	81	1083		4.510789	
6	3	15	69.5	1831	1875	4.972972	
7	3	15	51.9	1455	1019	6.12579	
8	3	15	66.6	1118	1065	6.507739	
9	2	15	60.1	1611		7.427916	
10	3	15	92.9	1110	1139	8.621983	
11	3	15	59.2	1445	1949	9.530065	
12	3	15	65.9	1547	1118	9.663139	
13	3	15	76.8	1238	1162	10.71774	
14	2	15	75.1	1998		11.40934	

Statistics 5(ChirpCenter Frequency: 5530.0 MHz)

Trial #	Pulse	Chirp(MHz)	Pulse Width (μS)	Pulse 1-2 spacing(μS)	Pulse 2-3 spacing(μS)	Pulse Start(S)	Detection (1:yes;0:no)
0	2	7	74.7	1064		0.219209	1
1	2	7	60.4	1255		1.09198	
2	2	7	80	1206		2.653772	
3	3	7	71.2	1197	1742	2.875482	
4	3	7	98.6	1379	1547	3.886956	
5	1	7	79.3			5.158235	
6	2	7	79.9	1030		5.664711	
7	3	7	67.4	1044	1992	6.55137	
8	1	7	79.3			7.517333	
9	1	7	76			9.030897	
10	3	7	71.7	1610	1968	9.474537	
11	3	7	84.5	1163	1302	10.83492	
12	1	7	96.7			11.75104	

Statistics 6 (ChirpCenter Frequency: 5530.0 MHz)

Trial #	Pulse	Chirp(MHz)	Pulse Width (μS)	Pulse 1-2 spacing(μS)	Pulse 2-3 spacing(μS)	Pulse Start(S)	Detection (1:yes;0:no)
0	2	8	61.5	1996		0.375767	1
1	1	8	58			1.01831	
2	1	8	60			1.577743	
3	2	8	59.7	1129		2.246398	
4	2	8	86	1963		2.689493	
5	1	8	74.1			3.887589	
6	2	8	71.5	1032		4.050806	
7	1	8	65.6			4.924735	
8	3	8	79.1	1914	1889	5.846119	
9	3	8	57.2	1795	1327	6.374221	
10	2	8	65.8	1371		6.720217	
11	1	8	58.8			7.809967	
12	2	8	79.3	1674		8.478696	
13	3	8	65.3	1477	1151	9.134359	
14	3	8	71.8	1890	1759	9.510966	
15	2	8	90.5	1316		10.18206	
16	2	8	67.3	1024		10.96567	
17	3	8	57.7	1544	1229	11.52559	

Statistics 7(ChirpCenter Frequency: 5530.0 MHz)

Trial #	Pulse	Chirp(MHz)	Pulse Width (μS)	Pulse 1-2 spacing(μS)	Pulse 2-3 spacing(μS)	Pulse Start(S)	Detection (1:yes;0:no)
0	2	7	94.4	1959		0.729159	1
1	2	7	75.4	1156		1.227138	
2	3	7	85.7	1499	1878	2.320159	
3	1	7	57.3			3.262725	
4	2	7	60.2	1610		4.29563	
5	3	7	65	1688	1801	5.357269	
6	1	7	76.7			6.064578	
7	1	7	92			6.699499	
8	2	7	64.1	1869		7.920087	
9	2	7	86.2	1216		8.327973	
10	1	7	52.9			9.45385	
11	2	7	51.4	1412		10.21194	
12	2	7	73.5	1393		11.22636	

Statistics 8 (ChirpCenter Frequency: 5530.0 MHz)

Trial #	Pulse	Chirp(MHz)	Pulse Width (μS)	Pulse 1-2 spacing(μS)	Pulse 2-3 spacing(μS)	Pulse Start(S)	Detection (1:yes;0:no)
0	2	9	87.3	1838		0.665536	1
1	3	9	54.1	1281	1900	1.119018	
2	3	9	57.1	1969	1030	2.143866	
3	3	9	53.2	1798	1116	3.472098	
4	2	9	92.2	1606		4.546929	
5	1	9	54.8			5.011919	
6	2	9	80.6	1839		6.559215	
7	2	9	86.8	1608		7.033622	
8	2	9	57.7	1702		8.331185	
9	2	9	74.7	1120		9.531255	
10	2	9	64	1132		10.0514	
11	3	9	70.7	1785	1508	11.87669	

Statistics 9 (ChirpCenter Frequency: 5530.0 MHz)

Trial #	Pulse	Chirp(MHz)	Pulse Width (μS)	Pulse 1-2 spacing(μS)	Pulse 2-3 spacing(μS)	Pulse Start(S)	Detection (1:yes;0:no)
0	2	7	84.2	1289		0.256587	1
1	3	7	75.1	1141	1769	1.189442	
2	1	7	88.2			1.694934	
3	3	7	72.3	1439	1042	2.819244	
4	1	7	71.4			3.788945	
5	1	7	59.5			4.584247	
6	2	7	93.9	1079		5.46123	
7	2	7	75.9	1390		5.79653	
8	2	7	52.9	1801		6.565336	
9	2	7	92.9	1731		7.657683	
10	2	7	54.9	1319		8.01763	
11	1	7	64.7			9.215251	
12	2	7	75.1	1072		10.21792	
13	2	7	63.5	1449		10.74363	
14	1	7	90.3			11.41033	

Statistics 10 (ChirpCenter Frequency: 5530.0 MHz)

Trial #	Pulse	Chirp(MHz)	Pulse Width (μS)	Pulse 1-2 spacing(μS)	Pulse 2-3 spacing(μS)	Pulse Start(S)	Detection (1:yes;0:no)
0	2	8	94.5	1257		0.579924	1
1	3	8	75.9	1710	1112	1.358354	
2	2	8	99.7	1832		1.806205	
3	2	8	77.7	1774		2.406382	
4	3	8	51.1	1234	1796	3.822094	
5	2	8	62	1093		4.301802	
6	1	8	67.9			4.849673	
7	2	8	52.8	1416		5.952605	
8	2	8	82.8	1181		6.728657	
9	1	8	81.4			7.598265	
10	2	8	97.5	1277		8.215203	
11	2	8	68.1	1443		8.842285	
12	2	8	95	1611		9.606321	
13	2	8	95	1507		10.66705	
14	1	8	85.8			11.71	

Radar Type 5 Case 2 Statistical Performance

Statistics 1 (ChirpCenter Frequency: 5493.0MHz)

Trial #	Pulse	Chirp(MHz)	Pulse Width (μS)	Pulse 1-2 spacing(μS)	Pulse 2-3 spacing(μS)	Pulse Start(S)	Detection (1:yes;0:no)
0	2	8	77.9	1866		0.22538	1
1	3	8	79.6	1654	1905	0.691398	
2	2	8	86.5	1582		1.622973	
3	2	8	62.7	1679		2.167919	
4	2	8	61.6	1421		3.308444	
5	1	8	80.3			3.70598	
6	2	8	61.5	1877		4.119164	
7	2	8	73.2	1303		5.015604	
8	2	8	86.6	1102		5.637833	
9	2	8	95.2	1712		6.23167	
10	2	8	67.4	1967		6.79	
11	1	8	64.5			7.475547	
12	3	8	50.6	1842	1596	8.331606	
13	1	8	89.1			8.781529	
14	2	8	97	1712		9.687107	
15	2	8	89.1	1491		10.49339	
16	3	8	95.6	1503	1810	10.81444	
17	1	8	64.4			11.46301	

Statistics 2 (ChirpCenter Frequency: 5497.0 MHz)

Trial #	Pulse	Chirp(MHz)	Pulse Width (μS)	Pulse 1-2 spacing(μS)	Pulse 2-3 spacing(μS)	Pulse Start(S)	Detection (1:yes;0:no)
0	3	17	62.7	1273	1304	0.271962	1
1	3	17	96.3	1256	1545	1.12963	
2	2	17	80.9	1541		2.048069	
3	1	17	94			3.235629	
4	2	17	78.4	1870		3.820137	
5	3	17	54.3	1686	1993	5.326553	
6	2	17	78.6	1831		5.904959	
7	2	17	75.3	1517		6.802943	
8	2	17	76.9	1765		7.73458	
9	2	17	50.8	1276		8.357429	
10	2	17	66	1327		9.718909	
11	2	17	72.6	1103		10.67634	
12	3	17	71.6	1187	1245	11.48655	

Statistics 3 (ChirpCenter Frequency: 5494.0 MHz)

Trial #	Pulse	Chirp(MHz)	Pulse Width (μS)	Pulse 1-2 spacing(μS)	Pulse 2-3 spacing(μS)	Pulse Start(S)	Detection (1:yes;0:no)
0	1	10	71.4			1.179615	1
1	3	10	91.3	1846	1815	2.222406	
2	1	10	94.3			3.073368	
3	2	10	50	1821		4.642416	
4	2	10	81.8	1336		6.187437	
5	3	10	78.9	1449	1163	7.87627	
6	2	10	78.6	1843		8.937781	
7	2	10	67.5	1376		9.359828	
8	3	10	95.8	1646	1394	10.79857	

Statistics 4 (ChirpCenter Frequency: 5495.0 MHz)

Trial #	Pulse	Chirp(MHz)	Pulse Width (μS)	Pulse 1-2 spacing(μS)	Pulse 2-3 spacing(μS)	Pulse Start(S)	Detection (1:yes;0:no)
0	2	12	93.2	1745		0.417858	1
1	2	12	83.6	1341		1.159489	
2	2	12	53.9	1502		2.258614	
3	1	12	90.9			3.766097	
4	3	12	93.3	1938	1965	4.063048	
5	2	12	64	1246		5.709937	
6	3	12	75.4	1474	1598	6.281582	
7	1	12	90.7			7.067113	
8	3	12	67.8	1155	1955	8.97622	
9	2	12	51.2	1633		9.161365	
10	2	12	72.4	1360		10.99182	
11	2	12	62.5	1520		11.22003	

Statistics 5(ChirpCenter Frequency: 5494.0 MHz)

Trial #	Pulse	Chirp(MHz)	Pulse Width (μS)	Pulse 1-2 spacing(μS)	Pulse 2-3 spacing(μS)	Pulse Start(S)	Detection (1:yes;0:no)
0	3	9	88.6	1032	1033	0.44426	0
1	2	9	62.4	1701		1.311195	
2	2	9	65	1755		2.305011	
3	1	9	94.1			2.886105	
4	3	9	88.5	1288	1700	3.772098	
5	2	9	57.8	1245		4.957795	
6	3	9	54.9	1911	1431	5.805183	
7	2	9	54.3	1050		6.918182	
8	3	9	53	1289	1603	8.173662	
9	1	9	96.6			9.011264	
10	3	9	65.2	1327	1678	10.13351	
11	3	9	86.2	1169	1568	10.31975	
12	3	9	59	1690	1913	11.32405	

Statistics 6 (ChirpCenter Frequency: 5494.0 MHz)

Trial #	Pulse	Chirp(MHz)	Pulse Width (μS)	Pulse 1-2 spacing(μS)	Pulse 2-3 spacing(μS)	Pulse Start(S)	Detection (1:yes;0:no)
0	1	10	87.2			0.186245	0
1	3	10	67.5	1007	1621	0.900926	
2	1	10	83.7			2.007749	
3	3	10	94.8	1811	1536	2.359584	
4	1	10	79.4			3.007635	
5	2	10	85.3	1778		3.998448	
6	2	10	62.7	1078		4.868366	
7	2	10	89	1635		5.758164	
8	1	10	99.4			6.404363	
9	1	10	59.8			7.483929	
10	1	10	51			7.927528	
11	3	10	92.9	1415	1796	8.393806	
12	2	10	99.9	1049		9.177101	
13	1	10	59.6			10.43851	
14	2	10	88.4	1112		10.85489	
15	2	10	68.3	1257		11.46644	

Statistics 7(ChirpCenter Frequency: 5495.0 MHz)

Trial #	Pulse	Chirp(MHz)	Pulse Width (μS)	Pulse 1-2 spacing(μS)	Pulse 2-3 spacing(μS)	Pulse Start(S)	Detection (1:yes;0:no)
0	3	12	96.1	1819	1377	0.809009	1
1	1	12	65.3			1.891801	
2	2	12	94.1	1500		2.62653	
3	3	12	68.8	1636	1560	3.00835	
4	3	12	95.1	1179	1823	4.725251	
5	2	12	57.4	1374		5.765966	
6	3	12	70.7	1471	1188	6.23265	
7	1	12	84.2			7.551576	
8	2	12	67.4	1841		8.796031	
9	2	12	81.8	1830		9.474706	
10	3	12	64.5	1856	1240	10.38487	
11	1	12	55.2			11.57181	

Statistics 8 (ChirpCenter Frequency: 5498.0 MHz)

Trial #	Pulse	Chirp(MHz)	Pulse Width (μS)	Pulse 1-2 spacing(μS)	Pulse 2-3 spacing(μS)	Pulse Start(S)	Detection (1:yes;0:no)
0	2	19	74.8	1969		1.123888	1
1	1	19	74.6			2.23614	
2	1	19	55.5			3.82382	
3	1	19	77.4			4.844756	
4	1	19	92.7			6.033929	
5	1	19	73.8			6.931747	
6	2	19	90.1	1354		9.261561	
7	2	19	95.7	1711		10.33468	
8	1	19	93.3			11.95187	

Statistics 9 (ChirpCenter Frequency: 5497.0 MHz)

Trial #	Pulse	Chirp(MHz)	Pulse Width (μS)	Pulse 1-2 spacing(μS)	Pulse 2-3 spacing(μS)	Pulse Start(S)	Detection (1:yes;0:no)
0	3	18	66.7	1795	1550	0.588347	1
1	2	18	51.2	1946		1.398563	
2	3	18	53	1244	1644	2.439152	
3	1	18	59.8			3.224911	
4	1	18	78.6			4.120339	
5	2	18	73.3	1813		5.058573	
6	2	18	88.1	1918		6.230905	
7	2	18	68.6	1475		6.764072	
8	3	18	80.8	1330	1561	7.552125	
9	1	18	87.9			8.693658	
10	3	18	51.3	1882	1451	9.719413	
11	3	18	94.6	1625	1747	10.95257	
12	2	18	58.9	1937		11.48565	

Statistics 10 (ChirpCenter Frequency: 5498.0 MHz)

Trial #	Pulse	Chirp(MHz)	Pulse Width (μS)	Pulse 1-2 spacing(μS)	Pulse 2-3 spacing(μS)	Pulse Start(S)	Detection (1:yes;0:no)
0	2	19	66.8	1819		1.058561	1
1	3	19	95.6	1149	1271	1.626829	
2	2	19	54.8	1574		2.499462	
3	1	19	89.9			3.645751	
4	1	19	75.1			5.943974	
5	2	19	67.8	1982		6.699779	
6	2	19	78.1	1553		8.132164	
7	3	19	50.4	1727	1417	9.244484	
8	2	19	69.6	1968		10.24499	
9	1	19	83.8			11.06309	

Radar Type 5 Case 3 Statistical Performance

Statistics 1 (ChirpCenter Frequency: 5566.0MHz)

Trial #	Pulse	Chirp(MHz)	Pulse Width (µS)	Pulse 1-2 spacing(µS)	Pulse 2-3 spacing(µS)	Pulse Start(S)	Detection (1:yes;0:no)
0	1	9	89.2			0.685455	1
1	2	9	92	1497		1.545917	
2	2	9	70.5	1031		1.883294	
3	1	9	95.6			2.629662	
4	2	9	94.2	1283		4.153128	
5	1	9	68			4.549097	
6	1	9	97.7			5.516518	
7	2	9	85.7	1544		6.598009	
8	3	9	50.8	1375	1103	7.442716	
9	1	9	63.7			8.017196	
10	2	9	84.8	1579		9.364205	
11	3	9	53.5	1658	1504	9.741353	
12	2	9	99.1	1296		10.43494	
13	2	9	90.6	1518		11.49351	

Statistics 2 (ChirpCenter Frequency: 5566.0 MHz)

Trial #	Pulse	Chirp(MHz)	Pulse Width (µS)	Pulse 1-2 spacing(µS)	Pulse 2-3 spacing(µS)	Pulse Start(S)	Detection (1:yes;0:no)
0	2	9	89	1099		0.284116	1
1	2	9	71.9	1015		0.935936	
2	2	9	59.8	1362		1.978734	
3	3	9	67.8	1509	1580	2.567687	
4	2	9	58.7	1120		3.507147	
5	2	9	84.5	1951		4.130332	
6	1	9	96.6			4.326909	
7	1	9	76			5.215148	
8	2	9	95.4	1036		6.345571	
9	2	9	73.8	1649		6.956671	
10	2	9	68.6	1251		7.439718	
11	2	9	68.6	1524		7.809597	
12	2	9	65.7	1204		8.603386	
13	2	9	78.1	1014		9.177755	
14	1	9	75.9			10.34037	
15	1	9	75.5			11.03043	
16	1	9	86			11.61821	

Statistics 3 (ChirpCenter Frequency: 5564.0 MHz)

Trial #	Pulse	Chirp(MHz)	Pulse Width (μS)	Pulse 1-2 spacing(μS)	Pulse 2-3 spacing(μS)	Pulse Start(S)	Detection (1:yes;0:no)
0	3	14	84.8	1400	1965	0.473116	1
1	2	14	57.8	1162		0.655005	
2	2	14	92.7	1561		1.611417	
3	3	14	55.4	1134	1138	2.3088	
4	2	14	79.1	1215		3.095266	
5	3	14	99.1	1982	1143	3.400791	
6	2	14	51.1	1245		4.155391	
7	3	14	94.8	1662	1887	4.446697	
8	2	14	67.4	1080		5.431427	
9	1	14	69			6.195769	
10	1	14	59.4			6.651817	
11	3	14	74.5	1827	1281	7.062118	
12	2	14	79.7	1003		7.892885	
13	3	14	79.8	1154	1867	8.717666	
14	3	14	74	1825	1439	8.851349	
15	1	14	69.9			9.630319	
16	1	14	63.1			10.50515	
17	1	14	87.8			10.79849	
18	2	14	75.9	1687		11.84699	

Statistics 4 (ChirpCenter Frequency: 5563.0 MHz)

Trial #	Pulse	Chirp(MHz)	Pulse Width (μS)	Pulse 1-2 spacing(μS)	Pulse 2-3 spacing(μS)	Pulse Start(S)	Detection (1:yes;0:no)
0	2	18	89	1203		0.457529	1
1	2	18	93.5	1007		0.855059	
2	3	18	62.9	1477	1687	1.694619	
3	3	18	93.7	1790	1243	2.397395	
4	2	18	95.5	1226		2.677067	
5	3	18	50.7	1385	1837	3.559001	
6	2	18	97.4	1143		4.003158	
7	3	18	87.7	1244	1524	4.741611	
8	2	18	76.1	1666		5.739376	
9	3	18	86.9	1222	1693	6.124708	
10	3	18	53.1	1480	1598	7.248857	
11	1	18	83.7			7.851283	
12	3	18	92.9	1861	1351	8.021169	
13	3	18	80.7	1621	1037	8.837041	
14	1	18	84			9.699599	
15	2	18	53.3	1195		10.20441	
16	2	18	87.6	1659		10.77525	
17	2	18	77.9	1309		11.81445	

Statistics 5(ChirpCenter Frequency: 5567.0 MHz)

Trial #	Pulse	Chirp(MHz)	Pulse Width (μS)	Pulse 1-2 spacing(μS)	Pulse 2-3 spacing(μS)	Pulse Start(S)	Detection (1:yes;0:no)
0	2	7	64.5	1860		0.212163	1
1	2	7	74.9	1522		1.841105	
2	2	7	80.6	1261		2.271034	
3	1	7	75.9			3.635309	
4	1	7	57.1			4.361022	
5	3	7	99.9	1584	1863	5.637848	
6	2	7	89.4	1202		6.881431	
7	2	7	72.3	1349		7.99214	
8	1	7	96.3			8.472002	
9	1	7	97			9.191829	
10	2	7	82.8	1614		10.81481	
11	1	7	64.8			11.52546	

Statistics 6 (ChirpCenter Frequency: 5564.0 MHz)

Trial #	Pulse	Chirp(MHz)	Pulse Width (μS)	Pulse 1-2 spacing(μS)	Pulse 2-3 spacing(μS)	Pulse Start(S)	Detection (1:yes;0:no)
0	2	14	78.4	1255		0.050861	1
1	2	14	61.8	1128		0.921871	
2	3	14	77.4	1004	1453	1.472643	
3	2	14	54.1	1941		1.941443	
4	1	14	69.5			3.101176	
5	3	14	60	1061	1749	3.1927	
6	3	14	54.1	1559	1148	4.326592	
7	1	14	78.3			4.91083	
8	1	14	70.3			5.476	
9	1	14	85.5			5.769058	
10	1	14	91.3			6.814942	
11	2	14	89.9	1980		7.003866	
12	2	14	83	1089		7.91941	
13	3	14	88.6	1786	1213	8.612408	
14	1	14	93.4			8.945782	
15	2	14	75	1314		9.891469	
16	2	14	81.1	1382		10.26386	
17	2	14	75.4	1310		10.9967	
18	1	14	86.1			11.8421	

Statistics 7(ChirpCenter Frequency: 5563.0 MHz)

Trial #	Pulse	Chirp(MHz)	Pulse Width (μS)	Pulse 1-2 spacing(μS)	Pulse 2-3 spacing(μS)	Pulse Start(S)	Detection (1:yes;0:no)
0	2	18	89.8	1553		0.591343	1
1	3	18	88.3	1436	1700	2.297718	
2	1	18	77.7			3.177827	
3	2	18	78.3	1209		4.626203	
4	2	18	54.5	1288		5.833209	
5	1	18	95.4			7.055691	
6	2	18	85.8	1582		8.674749	
7	1	18	88.8			9.766945	
8	2	18	69.6	1901		11.92603	

Statistics 8 (ChirpCenter Frequency: 5566.0 MHz)

Trial #	Pulse	Chirp(MHz)	Pulse Width (μS)	Pulse 1-2 spacing(μS)	Pulse 2-3 spacing(μS)	Pulse Start(S)	Detection (1:yes;0:no)
0	2	9	69.5	1009		0.148502	1
1	2	9	87.7	1359		1.438215	
2	2	9	66.7	1653		2.66295	
3	2	9	69.4	1579		4.244182	
4	3	9	86.9	1468	1922	5.691365	
5	2	9	84.8	1432		7.108407	
6	2	9	75.3	1049		7.595782	
7	3	9	97.3	1570	1277	8.451606	
8	2	9	73.9	1946		10.63955	
9	2	9	99.6	1758		11.45853	

Statistics 9 (ChirpCenter Frequency: 5566.0 MHz)

Trial #	Pulse	Chirp(MHz)	Pulse Width (μS)	Pulse 1-2 spacing(μS)	Pulse 2-3 spacing(μS)	Pulse Start(S)	Detection (1:yes;0:no)
0	2	10	67.1	1184		0.523596	1
1	2	10	84.1	1884		1.123814	
2	2	10	50.5	1525		2.198867	
3	1	10	91.5			3.239551	
4	2	10	51.2	1056		4.600664	
5	2	10	89.6	1268		5.16162	
6	1	10	85.6			6.407869	
7	1	10	77.1			6.53871	
8	3	10	62.5	1691	1179	7.940248	
9	2	10	97.8	1718		8.437685	
10	3	10	73	1365	1858	9.613307	
11	2	10	98.4	1966		10.81684	
12	1	10	83.3			11.1883	

Statistics 10 (ChirpCenter Frequency: 5563.0 MHz)

Trial #	Pulse	Chirp(MHz)	Pulse Width (μ S)	Pulse 1-2 spacing(μ S)	Pulse 2-3 spacing(μ S)	Pulse Start(S)	Detection (1:yes;0:no)
0	2	17	89	1916		0.321442	1
1	1	17	80.3			2.190011	
2	1	17	93.2			4.045822	
3	3	17	71.5	1307	1463	5.449587	
4	2	17	89.1	1557		7.460863	
5	2	17	52.9	1524		7.579741	
6	3	17	56	1891	1885	10.31744	
7	2	17	88.1	1210		11.90984	

Radar Type 6 Statistical Performance

Trial #	Fc (MHz)	Pulse /Burst	Pulse Width (µS)	PRI (µs)	Detection (1:yes; 0:no)	Hopping Sequence (MHz)
1	5530	9	1	333	1	5498.0, 5254.0, 5434.0, 5695.0, 5370.0, 5397.0, 5563.0, 5390.0, 5264.0, 5689.0, 5655.0, 5425.0, 5469.0, 5391.0, 5630.0, 5312.0, 5567.0, 5574.0, 5480.0, 5686.0, 5306.0, 5635.0, 5341.0, 5646.0, 5381.0, 5305.0, 5706.0, 5642.0, 5301.0, 5431.0, 5443.0, 5559.0, 5690.0, 5645.0, 5701.0, 5375.0, 5492.0, 5516.0, 5405.0, 5300.0, 5575.0, 5353.0, 5674.0, 5339.0, 5444.0, 5481.0, 5612.0, 5554.0, 5537.0, 5601.0, 5351.0, 5543.0, 5657.0, 5632.0, 5423.0, 5524.0, 5250.0, 5677.0, 5552.0, 5678.0, 5609.0, 5489.0, 5479.0, 5302.0, 5253.0, 5637.0, 5659.0, 5581.0, 5556.0, 5643.0, 5708.0, 5436.0, 5569.0, 5329.0, 5478.0, 5568.0, 5459.0, 5307.0, 5633.0, 5486.0, 5416.0, 5623.0, 5570.0, 5547.0, 5257.0, 5713.0, 5427.0, 5595.0, 5592.0, 5261.0, 5345.0, 5522.0, 5484.0, 5666.0, 5717.0, 5528.0, 5724.0, 5392.0, 5665.0, 5651.0 (number of hits: 17)
2	5530	9	1	333	1	5663.0, 5559.0, 5693.0, 5625.0, 5416.0, 5379.0, 5654.0, 5433.0, 5301.0, 5398.0, 5326.0, 5385.0, 5292.0, 5685.0, 5476.0, 5570.0, 5648.0, 5281.0, 5501.0, 5370.0, 5297.0, 5604.0, 5319.0, 5368.0, 5511.0, 5270.0, 5274.0, 5617.0, 5427.0, 5653.0, 5340.0, 5468.0, 5402.0, 5359.0, 5308.0, 5412.0, 5312.0, 5271.0, 5549.0, 5686.0, 5657.0, 5601.0, 5283.0, 5564.0, 5374.0, 5285.0, 5321.0, 5482.0, 5715.0, 5695.0, 5581.0, 5421.0, 5512.0, 5257.0, 5286.0, 5627.0, 5615.0, 5406.0, 5707.0, 5265.0, 5372.0, 5437.0, 5327.0, 5602.0, 5517.0, 5366.0, 5566.0, 5608.0, 5665.0, 5272.0, 5411.0, 5388.0, 5346.0, 5459.0, 5466.0, 5499.0, 5322.0, 5688.0, 5491.0, 5483.0, 5580.0, 5441.0, 5316.0, 5575.0, 5586.0, 5612.0, 5486.0, 5710.0, 5254.0, 5318.0, 5524.0, 5315.0, 5507.0, 5504.0, 5538.0, 5696.0, 5496.0, 5369.0, 5284.0, 5534.0 (number of hits: 16)
3	5530	9	1	333	1	5597.0, 5545.0, 5643.0, 5444.0, 5341.0, 5348.0, 5678.0, 5680.0, 5473.0, 5606.0, 5381.0, 5285.0, 5354.0, 5278.0, 5431.0, 5391.0, 5653.0, 5339.0, 5296.0, 5291.0, 5388.0, 5346.0, 5452.0, 5253.0, 5439.0, 5272.0, 5292.0, 5592.0, 5384.0, 5561.0, 5326.0, 5534.0, 5318.0, 5679.0, 5429.0, 5547.0, 5404.0, 5303.0, 5375.0, 5441.0, 5304.0, 5330.0, 5493.0, 5566.0, 5710.0, 5395.0, 5487.0, 5601.0, 5470.0, 5485.0, 5373.0, 5611.0, 5355.0, 5286.0, 5507.0,

						5625.0, 5695.0, 5722.0, 5502.0, 5390.0, 5351.0, 5288.0, 5460.0, 5322.0, 5436.0, 5316.0, 5367.0, 5551.0, 5315.0, 5664.0, 5368.0, 5455.0, 5624.0, 5380.0, 5605.0, 5648.0, 5517.0, 5347.0, 5406.0, 5718.0, 5672.0, 5588.0, 5563.0, 5428.0, 5616.0, 5410.0, 5642.0, 5719.0, 5306.0, 5445.0, 5372.0, 5562.0, 5655.0, 5669.0, 5273.0, 5709.0, 5516.0, 5360.0, 5687.0, 5638.0 (number of hits: 13)
4	5530	9	1	333	1	5267.0, 5290.0, 5615.0, 5474.0, 5324.0, 5309.0, 5542.0, 5305.0, 5606.0, 5448.0, 5602.0, 5349.0, 5367.0, 5466.0, 5712.0, 5586.0, 5596.0, 5457.0, 5327.0, 5388.0, 5255.0, 5555.0, 5536.0, 5711.0, 5676.0, 5352.0, 5668.0, 5358.0, 5298.0, 5293.0, 5435.0, 5359.0, 5394.0, 5618.0, 5344.0, 5510.0, 5622.0, 5311.0, 5528.0, 5707.0, 5312.0, 5627.0, 5330.0, 5684.0, 5276.0, 5588.0, 5425.0, 5665.0, 5540.0, 5453.0, 5342.0, 5462.0, 5710.0, 5720.0, 5291.0, 5560.0, 5372.0, 5616.0, 5662.0, 5619.0, 5412.0, 5314.0, 5254.0, 5671.0, 5357.0, 5389.0, 5273.0, 5360.0, 5681.0, 5380.0, 5626.0, 5595.0, 5434.0, 5377.0, 5438.0, 5645.0, 5495.0, 5693.0, 5561.0, 5685.0, 5259.0, 5371.0, 5348.0, 5408.0, 5634.0, 5530.0, 5589.0, 5459.0, 5475.0, 5260.0, 5718.0, 5524.0, 5492.0, 5339.0, 5456.0, 5257.0, 5631.0, 5551.0, 5445.0, 5332.0 (number of hits: 13)
5	5530	9	1	333	1	5333.0, 5335.0, 5592.0, 5383.0, 5502.0, 5492.0, 5531.0, 5516.0, 5352.0, 5420.0, 5425.0, 5519.0, 5356.0, 5294.0, 5486.0, 5251.0, 5624.0, 5648.0, 5684.0, 5292.0, 5419.0, 5518.0, 5410.0, 5348.0, 5336.0, 5384.0, 5539.0, 5603.0, 5372.0, 5317.0, 5316.0, 5443.0, 5390.0, 5387.0, 5416.0, 5342.0, 5299.0, 5458.0, 5548.0, 5588.0, 5695.0, 5462.0, 5344.0, 5525.0, 5326.0, 5636.0, 5509.0, 5312.0, 5280.0, 5396.0, 5616.0, 5601.0, 5690.0, 5385.0, 5305.0, 5534.0, 5678.0, 5602.0, 5596.0, 5563.0, 5369.0, 5281.0, 5579.0, 5697.0, 5557.0, 5471.0, 5293.0, 5615.0, 5562.0, 5325.0, 5275.0, 5295.0, 5491.0, 5447.0, 5572.0, 5371.0, 5364.0, 5526.0, 5436.0, 5657.0, 5309.0, 5374.0, 5714.0, 5569.0, 5498.0, 5339.0, 5619.0, 5503.0, 5683.0, 5666.0, 5671.0, 5653.0, 5456.0, 5282.0, 5698.0, 5646.0, 5513.0, 5263.0, 5487.0, 5550.0 (number of hits: 21)
6	5530	9	1	333	1	5322.0, 5336.0, 5507.0, 5309.0, 5283.0, 5373.0, 5524.0, 5481.0, 5605.0, 5470.0, 5522.0, 5561.0, 5385.0, 5632.0, 5408.0, 5550.0, 5263.0, 5609.0, 5691.0, 5564.0, 5354.0, 5279.0, 5551.0, 5274.0, 5343.0, 5364.0, 5608.0, 5464.0, 5497.0, 5255.0, 5446.0, 5559.0, 5429.0, 5396.0, 5299.0, 5489.0, 5479.0, 5301.0, 5617.0, 5483.0,

						5334.0, 5716.0, 5320.0, 5650.0, 5288.0, 5347.0, 5281.0, 5393.0, 5554.0, 5604.0, 5531.0, 5653.0, 5499.0, 5485.0, 5471.0, 5254.0, 5256.0, 5487.0, 5601.0, 5261.0, 5530.0, 5409.0, 5402.0, 5541.0, 5593.0, 5557.0, 5346.0, 5316.0, 5589.0, 5474.0, 5603.0, 5377.0, 5625.0, 5432.0, 5403.0, 5664.0, 5339.0, 5386.0, 5540.0, 5465.0, 5526.0, 5595.0, 5657.0, 5652.0, 5273.0, 5413.0, 5333.0, 5645.0, 5399.0, 5607.0, 5567.0, 5455.0, 5637.0, 5699.0, 5688.0, 5542.0, 5275.0, 5659.0, 5578.0, 5404.0 (number of hits: 19)
7	5530	9	1	333	1	5384.0, 5263.0, 5572.0, 5321.0, 5253.0, 5718.0, 5535.0, 5362.0, 5647.0, 5670.0, 5695.0, 5709.0, 5472.0, 5337.0, 5327.0, 5387.0, 5696.0, 5665.0, 5250.0, 5579.0, 5713.0, 5271.0, 5394.0, 5426.0, 5603.0, 5482.0, 5342.0, 5586.0, 5646.0, 5311.0, 5624.0, 5630.0, 5548.0, 5405.0, 5432.0, 5723.0, 5286.0, 5344.0, 5364.0, 5525.0, 5326.0, 5600.0, 5687.0, 5610.0, 5494.0, 5671.0, 5583.0, 5539.0, 5581.0, 5637.0, 5536.0, 5299.0, 5682.0, 5715.0, 5705.0, 5659.0, 5323.0, 5467.0, 5316.0, 5640.0, 5483.0, 5543.0, 5328.0, 5526.0, 5642.0, 5413.0, 5652.0, 5594.0, 5308.0, 5569.0, 5557.0, 5655.0, 5592.0, 5466.0, 5550.0, 5553.0, 5675.0, 5279.0, 5313.0, 5656.0, 5719.0, 5332.0, 5613.0, 5570.0, 5457.0, 5697.0, 5607.0, 5446.0, 5558.0, 5721.0, 5255.0, 5396.0, 5406.0, 5314.0, 5621.0, 5534.0, 5635.0, 5645.0, 5268.0, 5608.0 (number of hits: 14)
8	5530	9	1	333	1	5651.0, 5613.0, 5509.0, 5289.0, 5428.0, 5494.0, 5720.0, 5358.0, 5691.0, 5368.0, 5671.0, 5533.0, 5436.0, 5326.0, 5489.0, 5521.0, 5676.0, 5501.0, 5498.0, 5709.0, 5590.0, 5458.0, 5537.0, 5606.0, 5611.0, 5665.0, 5261.0, 5504.0, 5286.0, 5260.0, 5517.0, 5449.0, 5312.0, 5624.0, 5688.0, 5309.0, 5609.0, 5586.0, 5568.0, 5321.0, 5288.0, 5531.0, 5474.0, 5284.0, 5302.0, 5333.0, 5471.0, 5599.0, 5268.0, 5431.0, 5348.0, 5353.0, 5306.0, 5419.0, 5495.0, 5272.0, 5442.0, 5425.0, 5620.0, 5317.0, 5254.0, 5625.0, 5450.0, 5328.0, 5536.0, 5255.0, 5500.0, 5518.0, 5483.0, 5686.0, 5370.0, 5355.0, 5541.0, 5308.0, 5562.0, 5374.0, 5301.0, 5464.0, 5429.0, 5421.0, 5473.0, 5456.0, 5472.0, 5631.0, 5252.0, 5277.0, 5337.0, 5680.0, 5466.0, 5635.0, 5632.0, 5529.0, 5619.0, 5652.0, 5484.0, 5435.0, 5323.0, 5576.0, 5371.0, 5713.0 (number of hits: 18)
9	5530	9	1	333	1	5617.0, 5567.0, 5456.0, 5646.0, 5621.0, 5520.0, 5369.0, 5606.0, 5554.0, 5722.0, 5380.0, 5417.0, 5524.0, 5309.0, 5526.0, 5314.0, 5702.0, 5283.0, 5704.0, 5650.0, 5514.0, 5355.0, 5498.0, 5573.0, 5560.0,

						5439.0, 5395.0, 5381.0, 5721.0, 5513.0, 5468.0, 5449.0, 5686.0, 5390.0, 5288.0, 5539.0, 5693.0, 5623.0, 5656.0, 5455.0, 5668.0, 5568.0, 5687.0, 5592.0, 5521.0, 5419.0, 5612.0, 5360.0, 5705.0, 5452.0, 5627.0, 5313.0, 5315.0, 5338.0, 5303.0, 5616.0, 5660.0, 5579.0, 5361.0, 5347.0, 5601.0, 5523.0, 5666.0, 5499.0, 5719.0, 5525.0, 5655.0, 5349.0, 5515.0, 5408.0, 5480.0, 5322.0, 5365.0, 5723.0, 5413.0, 5263.0, 5463.0, 5377.0, 5351.0, 5447.0, 5448.0, 5565.0, 5428.0, 5326.0, 5416.0, 5510.0, 5367.0, 5493.0, 5657.0, 5608.0, 5460.0, 5489.0, 5420.0, 5275.0, 5269.0, 5677.0, 5402.0, 5689.0, 5251.0, 5301.0 (number of hits: 19)
10	5530	9	1	333	1	5489.0, 5577.0, 5527.0, 5686.0, 5394.0, 5519.0, 5371.0, 5359.0, 5564.0, 5709.0, 5649.0, 5671.0, 5672.0, 5372.0, 5404.0, 5491.0, 5454.0, 5630.0, 5483.0, 5462.0, 5497.0, 5345.0, 5684.0, 5706.0, 5250.0, 5675.0, 5533.0, 5269.0, 5696.0, 5492.0, 5722.0, 5422.0, 5480.0, 5496.0, 5304.0, 5428.0, 5510.0, 5268.0, 5416.0, 5557.0, 5712.0, 5599.0, 5349.0, 5346.0, 5645.0, 5312.0, 5335.0, 5540.0, 5451.0, 5278.0, 5305.0, 5723.0, 5461.0, 5411.0, 5642.0, 5486.0, 5631.0, 5493.0, 5683.0, 5287.0, 5459.0, 5283.0, 5713.0, 5700.0, 5405.0, 5414.0, 5667.0, 5275.0, 5655.0, 5633.0, 5260.0, 5410.0, 5333.0, 5511.0, 5477.0, 5429.0, 5532.0, 5651.0, 5717.0, 5266.0, 5638.0, 5463.0, 5413.0, 5567.0, 5593.0, 5407.0, 5447.0, 5573.0, 5258.0, 5606.0, 5254.0, 5290.0, 5479.0, 5624.0, 5444.0, 5610.0, 5456.0, 5636.0, 5582.0, 5505.0 (number of hits: 16)
11	5530	9	1	333	1	5313.0, 5335.0, 5384.0, 5352.0, 5366.0, 5448.0, 5423.0, 5678.0, 5557.0, 5422.0, 5344.0, 5545.0, 5633.0, 5498.0, 5416.0, 5489.0, 5411.0, 5371.0, 5524.0, 5461.0, 5309.0, 5656.0, 5439.0, 5450.0, 5690.0, 5517.0, 5564.0, 5637.0, 5507.0, 5330.0, 5440.0, 5287.0, 5519.0, 5674.0, 5565.0, 5445.0, 5651.0, 5684.0, 5346.0, 5595.0, 5711.0, 5476.0, 5578.0, 5374.0, 5299.0, 5491.0, 5555.0, 5261.0, 5320.0, 5685.0, 5563.0, 5539.0, 5691.0, 5403.0, 5708.0, 5646.0, 5368.0, 5284.0, 5252.0, 5307.0, 5375.0, 5253.0, 5475.0, 5413.0, 5538.0, 5576.0, 5291.0, 5512.0, 5312.0, 5361.0, 5626.0, 5542.0, 5509.0, 5337.0, 5339.0, 5513.0, 5393.0, 5665.0, 5672.0, 5369.0, 5526.0, 5546.0, 5515.0, 5405.0, 5717.0, 5305.0, 5494.0, 5641.0, 5478.0, 5677.0, 5506.0, 5695.0, 5536.0, 5427.0, 5325.0, 5436.0, 5353.0, 5328.0, 5362.0, 5548.0 (number of hits: 25)
12	5530	9	1	333	1	5304.0, 5489.0, 5724.0, 5517.0, 5260.0, 5540.0, 5270.0, 5401.0, 5551.0, 5423.0,

						5250.0, 5620.0, 5446.0, 5555.0, 5455.0, 5301.0, 5704.0, 5364.0, 5575.0, 5515.0, 5639.0, 5707.0, 5576.0, 5487.0, 5572.0, 5292.0, 5550.0, 5686.0, 5508.0, 5530.0, 5518.0, 5542.0, 5514.0, 5342.0, 5632.0, 5311.0, 5337.0, 5426.0, 5696.0, 5418.0, 5441.0, 5288.0, 5531.0, 5596.0, 5594.0, 5678.0, 5546.0, 5521.0, 5416.0, 5528.0, 5708.0, 5584.0, 5273.0, 5259.0, 5447.0, 5626.0, 5510.0, 5598.0, 5506.0, 5369.0, 5387.0, 5663.0, 5284.0, 5400.0, 5371.0, 5398.0, 5567.0, 5428.0, 5291.0, 5553.0, 5373.0, 5424.0, 5290.0, 5655.0, 5299.0, 5641.0, 5306.0, 5493.0, 5303.0, 5525.0, 5666.0, 5471.0, 5478.0, 5279.0, 5522.0, 5349.0, 5394.0, 5382.0, 5454.0, 5372.0, 5429.0, 5353.0, 5672.0, 5691.0, 5488.0, 5335.0, 5612.0, 5634.0, 5308.0, 5268.0 (number of hits: 22)
13	5530	9	1	333	1	5466.0, 5271.0, 5643.0, 5646.0, 5505.0, 5344.0, 5373.0, 5582.0, 5380.0, 5292.0, 5296.0, 5719.0, 5589.0, 5261.0, 5648.0, 5486.0, 5378.0, 5331.0, 5321.0, 5453.0, 5480.0, 5630.0, 5645.0, 5275.0, 5600.0, 5601.0, 5661.0, 5683.0, 5312.0, 5714.0, 5576.0, 5629.0, 5549.0, 5541.0, 5451.0, 5569.0, 5286.0, 5304.0, 5374.0, 5587.0, 5293.0, 5512.0, 5721.0, 5421.0, 5620.0, 5407.0, 5433.0, 5326.0, 5675.0, 5305.0, 5359.0, 5627.0, 5672.0, 5283.0, 5413.0, 5264.0, 5666.0, 5578.0, 5499.0, 5501.0, 5471.0, 5474.0, 5282.0, 5274.0, 5581.0, 5598.0, 5332.0, 5570.0, 5372.0, 5430.0, 5256.0, 5545.0, 5385.0, 5411.0, 5633.0, 5254.0, 5432.0, 5658.0, 5628.0, 5347.0, 5638.0, 5295.0, 5311.0, 5281.0, 5678.0, 5473.0, 5514.0, 5599.0, 5285.0, 5619.0, 5636.0, 5611.0, 5313.0, 5318.0, 5694.0, 5513.0, 5443.0, 5700.0, 5546.0, 5364.0 (number of hits: 11)
14	5530	9	1	333	1	5264.0, 5483.0, 5297.0, 5429.0, 5613.0, 5668.0, 5497.0, 5336.0, 5618.0, 5407.0, 5666.0, 5651.0, 5393.0, 5650.0, 5379.0, 5270.0, 5414.0, 5594.0, 5474.0, 5370.0, 5371.0, 5657.0, 5615.0, 5563.0, 5691.0, 5354.0, 5534.0, 5682.0, 5281.0, 5322.0, 5604.0, 5609.0, 5634.0, 5375.0, 5302.0, 5404.0, 5611.0, 5566.0, 5591.0, 5681.0, 5291.0, 5409.0, 5450.0, 5456.0, 5614.0, 5461.0, 5275.0, 5653.0, 5332.0, 5287.0, 5542.0, 5686.0, 5280.0, 5662.0, 5487.0, 5399.0, 5599.0, 5705.0, 5397.0, 5364.0, 5646.0, 5342.0, 5649.0, 5701.0, 5612.0, 5724.0, 5669.0, 5421.0, 5267.0, 5606.0, 5460.0, 5561.0, 5284.0, 5355.0, 5706.0, 5274.0, 5273.0, 5560.0, 5254.0, 5283.0, 5395.0, 5367.0, 5408.0, 5512.0, 5659.0, 5477.0, 5522.0, 5360.0, 5459.0, 5347.0, 5717.0, 5582.0, 5521.0, 5428.0, 5299.0, 5517.0, 5323.0, 5418.0, 5531.0, 5261.0

						(number of hits: 12)
15	5530	9	1	333	1	5611.0, 5530.0, 5451.0, 5633.0, 5492.0, 5412.0, 5675.0, 5407.0, 5283.0, 5382.0, 5518.0, 5574.0, 5422.0, 5439.0, 5378.0, 5640.0, 5317.0, 5562.0, 5516.0, 5557.0, 5346.0, 5605.0, 5471.0, 5533.0, 5281.0, 5698.0, 5667.0, 5615.0, 5612.0, 5329.0, 5448.0, 5461.0, 5639.0, 5429.0, 5355.0, 5674.0, 5457.0, 5538.0, 5526.0, 5671.0, 5576.0, 5411.0, 5586.0, 5271.0, 5493.0, 5452.0, 5466.0, 5593.0, 5544.0, 5313.0, 5320.0, 5432.0, 5387.0, 5282.0, 5614.0, 5657.0, 5578.0, 5315.0, 5348.0, 5259.0, 5344.0, 5386.0, 5312.0, 5274.0, 5444.0, 5699.0, 5651.0, 5642.0, 5693.0, 5704.0, 5592.0, 5525.0, 5679.0, 5494.0, 5682.0, 5617.0, 5254.0, 5475.0, 5532.0, 5263.0, 5505.0, 5479.0, 5709.0, 5324.0, 5409.0, 5560.0, 5405.0, 5660.0, 5624.0, 5260.0, 5253.0, 5480.0, 5529.0, 5401.0, 5580.0, 5503.0, 5478.0, 5665.0, 5426.0, 5536.0
						(number of hits: 19)
16	5530	9	1	333	1	5688.0, 5577.0, 5405.0, 5361.0, 5257.0, 5678.0, 5699.0, 5269.0, 5679.0, 5718.0, 5494.0, 5424.0, 5687.0, 5677.0, 5403.0, 5290.0, 5546.0, 5279.0, 5285.0, 5280.0, 5549.0, 5621.0, 5482.0, 5573.0, 5656.0, 5340.0, 5371.0, 5388.0, 5642.0, 5660.0, 5278.0, 5252.0, 5526.0, 5317.0, 5619.0, 5592.0, 5723.0, 5692.0, 5335.0, 5506.0, 5310.0, 5399.0, 5376.0, 5590.0, 5366.0, 5436.0, 5650.0, 5520.0, 5628.0, 5501.0, 5325.0, 5472.0, 5497.0, 5351.0, 5262.0, 5499.0, 5322.0, 5606.0, 5481.0, 5719.0, 5364.0, 5558.0, 5675.0, 5459.0, 5608.0, 5466.0, 5646.0, 5377.0, 5707.0, 5569.0, 5353.0, 5504.0, 5643.0, 5662.0, 5702.0, 5291.0, 5357.0, 5665.0, 5700.0, 5596.0, 5527.0, 5631.0, 5534.0, 5531.0, 5302.0, 5261.0, 5373.0, 5545.0, 5623.0, 5475.0, 5336.0, 5437.0, 5714.0, 5715.0, 5578.0, 5349.0, 5686.0, 5286.0, 5445.0, 5430.0
						(number of hits: 16)
17	5530	9	1	333	1	5399.0, 5400.0, 5636.0, 5474.0, 5411.0, 5391.0, 5612.0, 5491.0, 5529.0, 5357.0, 5600.0, 5412.0, 5297.0, 5267.0, 5679.0, 5547.0, 5431.0, 5714.0, 5673.0, 5499.0, 5355.0, 5618.0, 5555.0, 5336.0, 5590.0, 5654.0, 5507.0, 5362.0, 5671.0, 5358.0, 5436.0, 5448.0, 5279.0, 5542.0, 5440.0, 5661.0, 5339.0, 5680.0, 5252.0, 5652.0, 5563.0, 5372.0, 5341.0, 5254.0, 5285.0, 5495.0, 5666.0, 5527.0, 5456.0, 5695.0, 5535.0, 5521.0, 5298.0, 5468.0, 5502.0, 5294.0, 5585.0, 5599.0, 5605.0, 5574.0, 5309.0, 5318.0, 5410.0, 5266.0, 5682.0, 5558.0, 5511.0, 5657.0, 5265.0, 5560.0, 5584.0, 5270.0, 5611.0, 5269.0, 5712.0, 5485.0, 5385.0, 5426.0, 5598.0, 5459.0, 5455.0, 5287.0, 5478.0, 5496.0, 5699.0,

						5522.0, 5326.0, 5510.0, 5306.0, 5281.0, 5386.0, 5583.0, 5596.0, 5665.0, 5570.0, 5639.0, 5597.0, 5537.0, 5625.0, 5472.0 (number of hits: 20)
18	5530	9	1	333	1	5426.0, 5551.0, 5664.0, 5276.0, 5541.0, 5409.0, 5527.0, 5404.0, 5253.0, 5367.0, 5410.0, 5509.0, 5476.0, 5570.0, 5586.0, 5360.0, 5556.0, 5254.0, 5555.0, 5282.0, 5375.0, 5302.0, 5305.0, 5266.0, 5403.0, 5437.0, 5455.0, 5489.0, 5659.0, 5338.0, 5498.0, 5369.0, 5657.0, 5406.0, 5496.0, 5467.0, 5280.0, 5341.0, 5343.0, 5717.0, 5262.0, 5390.0, 5697.0, 5448.0, 5617.0, 5393.0, 5402.0, 5508.0, 5355.0, 5558.0, 5351.0, 5630.0, 5337.0, 5674.0, 5669.0, 5559.0, 5546.0, 5445.0, 5460.0, 5680.0, 5357.0, 5274.0, 5326.0, 5311.0, 5723.0, 5400.0, 5673.0, 5578.0, 5279.0, 5418.0, 5715.0, 5521.0, 5480.0, 5292.0, 5503.0, 5583.0, 5259.0, 5718.0, 5606.0, 5670.0, 5592.0, 5721.0, 5662.0, 5722.0, 5528.0, 5456.0, 5371.0, 5424.0, 5600.0, 5291.0, 5382.0, 5705.0, 5381.0, 5634.0, 5301.0, 5344.0, 5576.0, 5502.0, 5714.0, 5629.0 (number of hits: 16)
19	5530	9	1	333	1	5530.0, 5662.0, 5510.0, 5700.0, 5304.0, 5270.0, 5603.0, 5473.0, 5430.0, 5266.0, 5653.0, 5307.0, 5548.0, 5578.0, 5696.0, 5261.0, 5671.0, 5290.0, 5405.0, 5340.0, 5532.0, 5646.0, 5625.0, 5415.0, 5315.0, 5431.0, 5404.0, 5421.0, 5612.0, 5718.0, 5281.0, 5447.0, 5569.0, 5699.0, 5330.0, 5511.0, 5592.0, 5341.0, 5445.0, 5580.0, 5516.0, 5356.0, 5419.0, 5608.0, 5348.0, 5567.0, 5272.0, 5497.0, 5435.0, 5255.0, 5396.0, 5267.0, 5577.0, 5707.0, 5355.0, 5251.0, 5324.0, 5502.0, 5492.0, 5314.0, 5627.0, 5258.0, 5485.0, 5590.0, 5543.0, 5536.0, 5256.0, 5464.0, 5425.0, 5303.0, 5537.0, 5582.0, 5640.0, 5674.0, 5388.0, 5560.0, 5442.0, 5309.0, 5690.0, 5280.0, 5424.0, 5685.0, 5327.0, 5724.0, 5386.0, 5444.0, 5439.0, 5374.0, 5383.0, 5493.0, 5400.0, 5358.0, 5659.0, 5630.0, 5571.0, 5689.0, 5352.0, 5576.0, 5586.0, 5285.0 (number of hits: 16)
20	5530	9	1	333	1	5453.0, 5521.0, 5715.0, 5622.0, 5433.0, 5695.0, 5464.0, 5562.0, 5636.0, 5358.0, 5415.0, 5473.0, 5555.0, 5265.0, 5680.0, 5403.0, 5533.0, 5716.0, 5310.0, 5723.0, 5654.0, 5572.0, 5584.0, 5386.0, 5461.0, 5673.0, 5565.0, 5634.0, 5418.0, 5352.0, 5573.0, 5324.0, 5645.0, 5405.0, 5635.0, 5434.0, 5470.0, 5389.0, 5484.0, 5400.0, 5532.0, 5375.0, 5346.0, 5381.0, 5589.0, 5390.0, 5613.0, 5568.0, 5345.0, 5412.0, 5368.0, 5443.0, 5543.0, 5696.0, 5288.0, 5607.0, 5334.0, 5428.0, 5637.0, 5266.0, 5458.0, 5396.0, 5677.0, 5323.0, 5655.0, 5571.0, 5710.0, 5666.0, 5285.0, 5378.0,

						5547.0, 5542.0, 5416.0, 5625.0, 5377.0, 5672.0, 5339.0, 5439.0, 5698.0, 5689.0, 5581.0, 5431.0, 5642.0, 5284.0, 5365.0, 5430.0, 5615.0, 5315.0, 5724.0, 5449.0, 5422.0, 5580.0, 5280.0, 5262.0, 5354.0, 5663.0, 5322.0, 5550.0, 5515.0, 5289.0 (number of hits: 12)
21	5530	9	1	333	1	5618.0, 5353.0, 5606.0, 5417.0, 5428.0, 5462.0, 5412.0, 5716.0, 5499.0, 5327.0, 5308.0, 5267.0, 5346.0, 5444.0, 5257.0, 5363.0, 5568.0, 5343.0, 5396.0, 5388.0, 5429.0, 5381.0, 5419.0, 5504.0, 5354.0, 5528.0, 5524.0, 5721.0, 5687.0, 5489.0, 5658.0, 5501.0, 5287.0, 5709.0, 5310.0, 5433.0, 5647.0, 5482.0, 5268.0, 5374.0, 5600.0, 5557.0, 5364.0, 5610.0, 5653.0, 5663.0, 5719.0, 5579.0, 5509.0, 5584.0, 5280.0, 5699.0, 5649.0, 5648.0, 5526.0, 5714.0, 5717.0, 5313.0, 5331.0, 5696.0, 5640.0, 5675.0, 5662.0, 5639.0, 5718.0, 5703.0, 5339.0, 5367.0, 5358.0, 5365.0, 5344.0, 5637.0, 5312.0, 5291.0, 5538.0, 5440.0, 5332.0, 5698.0, 5330.0, 5402.0, 5459.0, 5560.0, 5681.0, 5480.0, 5615.0, 5621.0, 5518.0, 5443.0, 5554.0, 5406.0, 5378.0, 5672.0, 5306.0, 5567.0, 5676.0, 5629.0, 5481.0, 5450.0, 5376.0, 5288.0 (number of hits: 14)
22	5530	9	1	333	1	5435.0, 5454.0, 5433.0, 5525.0, 5473.0, 5285.0, 5392.0, 5374.0, 5494.0, 5289.0, 5604.0, 5702.0, 5660.0, 5256.0, 5704.0, 5416.0, 5323.0, 5564.0, 5602.0, 5429.0, 5722.0, 5505.0, 5290.0, 5254.0, 5395.0, 5421.0, 5699.0, 5391.0, 5669.0, 5398.0, 5307.0, 5516.0, 5723.0, 5521.0, 5279.0, 5675.0, 5380.0, 5622.0, 5583.0, 5611.0, 5666.0, 5710.0, 5413.0, 5480.0, 5303.0, 5498.0, 5436.0, 5272.0, 5373.0, 5535.0, 5497.0, 5301.0, 5520.0, 5673.0, 5486.0, 5347.0, 5434.0, 5399.0, 5355.0, 5518.0, 5259.0, 5294.0, 5484.0, 5288.0, 5624.0, 5446.0, 5608.0, 5691.0, 5559.0, 5496.0, 5708.0, 5558.0, 5715.0, 5643.0, 5678.0, 5640.0, 5455.0, 5638.0, 5509.0, 5500.0, 5251.0, 5629.0, 5432.0, 5397.0, 5627.0, 5493.0, 5671.0, 5542.0, 5662.0, 5278.0, 5709.0, 5703.0, 5569.0, 5555.0, 5277.0, 5532.0, 5483.0, 5322.0, 5579.0, 5461.0 (number of hits: 21)
23	5530	9	1	333	1	5701.0, 5722.0, 5584.0, 5636.0, 5377.0, 5470.0, 5712.0, 5288.0, 5264.0, 5274.0, 5316.0, 5716.0, 5578.0, 5521.0, 5595.0, 5627.0, 5542.0, 5645.0, 5493.0, 5430.0, 5574.0, 5606.0, 5346.0, 5601.0, 5405.0, 5522.0, 5466.0, 5419.0, 5376.0, 5603.0, 5481.0, 5320.0, 5404.0, 5496.0, 5282.0, 5338.0, 5620.0, 5413.0, 5577.0, 5654.0, 5359.0, 5557.0, 5327.0, 5312.0, 5587.0, 5370.0, 5349.0, 5708.0, 5397.0, 5642.0, 5583.0, 5467.0, 5341.0, 5585.0, 5643.0,

						5287.0, 5365.0, 5331.0, 5304.0, 5598.0, 5566.0, 5609.0, 5458.0, 5600.0, 5492.0, 5283.0, 5461.0, 5390.0, 5265.0, 5328.0, 5699.0, 5394.0, 5313.0, 5294.0, 5389.0, 5438.0, 5520.0, 5633.0, 5549.0, 5527.0, 5721.0, 5412.0, 5506.0, 5372.0, 5539.0, 5451.0, 5385.0, 5553.0, 5707.0, 5614.0, 5393.0, 5640.0, 5591.0, 5270.0, 5594.0, 5661.0, 5254.0, 5507.0, 5336.0, 5515.0 (number of hits: 16)
24	5530	9	1	333	1	5312.0, 5427.0, 5359.0, 5483.0, 5377.0, 5543.0, 5343.0, 5407.0, 5486.0, 5254.0, 5563.0, 5378.0, 5629.0, 5372.0, 5709.0, 5457.0, 5488.0, 5699.0, 5352.0, 5661.0, 5691.0, 5610.0, 5473.0, 5581.0, 5492.0, 5335.0, 5412.0, 5633.0, 5415.0, 5664.0, 5590.0, 5624.0, 5452.0, 5384.0, 5722.0, 5443.0, 5531.0, 5439.0, 5529.0, 5511.0, 5387.0, 5613.0, 5414.0, 5399.0, 5646.0, 5366.0, 5430.0, 5713.0, 5534.0, 5313.0, 5460.0, 5628.0, 5497.0, 5677.0, 5265.0, 5499.0, 5383.0, 5431.0, 5291.0, 5381.0, 5348.0, 5649.0, 5565.0, 5304.0, 5685.0, 5587.0, 5659.0, 5253.0, 5299.0, 5704.0, 5370.0, 5697.0, 5447.0, 5353.0, 5602.0, 5420.0, 5328.0, 5637.0, 5279.0, 5268.0, 5404.0, 5410.0, 5717.0, 5623.0, 5331.0, 5272.0, 5455.0, 5364.0, 5479.0, 5721.0, 5306.0, 5634.0, 5538.0, 5584.0, 5361.0, 5262.0, 5480.0, 5505.0, 5347.0, 5632.0 (number of hits: 12)
25	5530	9	1	333	1	5683.0, 5448.0, 5292.0, 5464.0, 5340.0, 5684.0, 5357.0, 5366.0, 5462.0, 5544.0, 5346.0, 5480.0, 5706.0, 5350.0, 5527.0, 5303.0, 5677.0, 5672.0, 5261.0, 5322.0, 5300.0, 5581.0, 5334.0, 5482.0, 5509.0, 5473.0, 5556.0, 5378.0, 5359.0, 5316.0, 5294.0, 5301.0, 5547.0, 5302.0, 5383.0, 5394.0, 5457.0, 5669.0, 5610.0, 5685.0, 5285.0, 5584.0, 5467.0, 5666.0, 5569.0, 5525.0, 5506.0, 5596.0, 5328.0, 5504.0, 5356.0, 5415.0, 5339.0, 5352.0, 5417.0, 5381.0, 5570.0, 5704.0, 5485.0, 5653.0, 5429.0, 5649.0, 5439.0, 5459.0, 5442.0, 5630.0, 5505.0, 5628.0, 5541.0, 5578.0, 5533.0, 5282.0, 5663.0, 5572.0, 5657.0, 5433.0, 5648.0, 5373.0, 5552.0, 5543.0, 5705.0, 5660.0, 5428.0, 5395.0, 5531.0, 5503.0, 5398.0, 5314.0, 5367.0, 5288.0, 5667.0, 5479.0, 5446.0, 5558.0, 5441.0, 5517.0, 5271.0, 5259.0, 5623.0, 5579.0 (number of hits: 18)
26	5530	9	1	333	1	5367.0, 5652.0, 5617.0, 5425.0, 5635.0, 5273.0, 5627.0, 5514.0, 5674.0, 5560.0, 5335.0, 5497.0, 5484.0, 5347.0, 5265.0, 5279.0, 5552.0, 5389.0, 5704.0, 5544.0, 5264.0, 5318.0, 5268.0, 5562.0, 5464.0, 5510.0, 5694.0, 5348.0, 5480.0, 5621.0, 5437.0, 5618.0, 5498.0, 5420.0, 5371.0, 5360.0, 5461.0, 5385.0, 5556.0, 5278.0,

						5269.0, 5438.0, 5366.0, 5546.0, 5355.0, 5370.0, 5563.0, 5384.0, 5716.0, 5535.0, 5533.0, 5462.0, 5317.0, 5623.0, 5398.0, 5255.0, 5463.0, 5590.0, 5657.0, 5475.0, 5416.0, 5431.0, 5710.0, 5315.0, 5345.0, 5417.0, 5394.0, 5521.0, 5524.0, 5507.0, 5331.0, 5361.0, 5570.0, 5600.0, 5419.0, 5604.0, 5632.0, 5721.0, 5494.0, 5566.0, 5306.0, 5285.0, 5700.0, 5490.0, 5467.0, 5261.0, 5354.0, 5453.0, 5681.0, 5705.0, 5554.0, 5601.0, 5296.0, 5297.0, 5724.0, 5429.0, 5565.0, 5327.0, 5481.0, 5714.0 (number of hits: 21)
27	5530	9	1	333	1	5358.0, 5520.0, 5316.0, 5694.0, 5397.0, 5623.0, 5278.0, 5660.0, 5573.0, 5276.0, 5714.0, 5532.0, 5542.0, 5383.0, 5563.0, 5556.0, 5674.0, 5678.0, 5452.0, 5390.0, 5401.0, 5553.0, 5467.0, 5591.0, 5432.0, 5267.0, 5443.0, 5253.0, 5706.0, 5416.0, 5513.0, 5332.0, 5719.0, 5704.0, 5525.0, 5350.0, 5259.0, 5720.0, 5283.0, 5289.0, 5359.0, 5645.0, 5412.0, 5697.0, 5521.0, 5256.0, 5338.0, 5661.0, 5281.0, 5536.0, 5560.0, 5685.0, 5312.0, 5637.0, 5703.0, 5389.0, 5371.0, 5691.0, 5255.0, 5597.0, 5324.0, 5471.0, 5328.0, 5709.0, 5509.0, 5570.0, 5362.0, 5495.0, 5333.0, 5305.0, 5625.0, 5534.0, 5544.0, 5621.0, 5671.0, 5594.0, 5376.0, 5540.0, 5475.0, 5492.0, 5717.0, 5421.0, 5517.0, 5583.0, 5422.0, 5587.0, 5342.0, 5426.0, 5505.0, 5391.0, 5677.0, 5349.0, 5399.0, 5313.0, 5693.0, 5275.0, 5337.0, 5612.0, 5462.0, 5561.0 (number of hits: 20)
28	5530	9	1	333	1	5613.0, 5453.0, 5559.0, 5288.0, 5468.0, 5296.0, 5679.0, 5684.0, 5429.0, 5517.0, 5256.0, 5493.0, 5695.0, 5304.0, 5539.0, 5341.0, 5465.0, 5595.0, 5702.0, 5286.0, 5437.0, 5257.0, 5698.0, 5715.0, 5533.0, 5692.0, 5523.0, 5336.0, 5377.0, 5266.0, 5415.0, 5628.0, 5597.0, 5305.0, 5593.0, 5278.0, 5358.0, 5509.0, 5673.0, 5311.0, 5581.0, 5372.0, 5714.0, 5467.0, 5600.0, 5542.0, 5619.0, 5520.0, 5689.0, 5310.0, 5403.0, 5649.0, 5652.0, 5578.0, 5269.0, 5379.0, 5605.0, 5347.0, 5416.0, 5421.0, 5480.0, 5518.0, 5302.0, 5406.0, 5535.0, 5386.0, 5332.0, 5633.0, 5250.0, 5592.0, 5721.0, 5668.0, 5659.0, 5723.0, 5399.0, 5430.0, 5552.0, 5448.0, 5432.0, 5717.0, 5485.0, 5325.0, 5572.0, 5563.0, 5650.0, 5547.0, 5521.0, 5397.0, 5322.0, 5436.0, 5366.0, 5519.0, 5477.0, 5290.0, 5491.0, 5375.0, 5704.0, 5490.0, 5299.0, 5626.0 (number of hits: 18)
29	5530	9	1	333	1	5573.0, 5252.0, 5696.0, 5381.0, 5365.0, 5505.0, 5554.0, 5476.0, 5344.0, 5634.0, 5463.0, 5320.0, 5367.0, 5405.0, 5680.0, 5348.0, 5368.0, 5450.0, 5265.0, 5282.0, 5260.0, 5345.0, 5315.0, 5422.0, 5504.0,

						5386.0, 5532.0, 5270.0, 5336.0, 5536.0, 5497.0, 5518.0, 5481.0, 5314.0, 5663.0, 5582.0, 5568.0, 5603.0, 5614.0, 5411.0, 5266.0, 5513.0, 5457.0, 5589.0, 5326.0, 5415.0, 5647.0, 5479.0, 5677.0, 5262.0, 5355.0, 5708.0, 5571.0, 5537.0, 5615.0, 5372.0, 5440.0, 5552.0, 5533.0, 5460.0, 5599.0, 5596.0, 5565.0, 5601.0, 5395.0, 5620.0, 5403.0, 5339.0, 5498.0, 5649.0, 5651.0, 5692.0, 5658.0, 5550.0, 5459.0, 5256.0, 5271.0, 5604.0, 5382.0, 5621.0, 5435.0, 5383.0, 5404.0, 5556.0, 5352.0, 5414.0, 5512.0, 5303.0, 5608.0, 5691.0, 5635.0, 5538.0, 5584.0, 5461.0, 5453.0, 5416.0, 5655.0, 5535.0, 5474.0, 5290.0 (number of hits: 19)
30	5530	9	1	333	1	5489.0, 5669.0, 5599.0, 5665.0, 5496.0, 5372.0, 5579.0, 5633.0, 5527.0, 5333.0, 5653.0, 5418.0, 5352.0, 5316.0, 5391.0, 5410.0, 5663.0, 5610.0, 5660.0, 5291.0, 5708.0, 5606.0, 5312.0, 5339.0, 5543.0, 5411.0, 5265.0, 5526.0, 5705.0, 5480.0, 5359.0, 5494.0, 5388.0, 5495.0, 5439.0, 5647.0, 5319.0, 5601.0, 5604.0, 5488.0, 5258.0, 5448.0, 5559.0, 5441.0, 5625.0, 5537.0, 5529.0, 5717.0, 5475.0, 5508.0, 5296.0, 5458.0, 5501.0, 5591.0, 5651.0, 5294.0, 5414.0, 5315.0, 5492.0, 5299.0, 5314.0, 5523.0, 5485.0, 5507.0, 5306.0, 5413.0, 5576.0, 5303.0, 5688.0, 5446.0, 5490.0, 5269.0, 5577.0, 5697.0, 5264.0, 5452.0, 5699.0, 5642.0, 5358.0, 5615.0, 5502.0, 5658.0, 5710.0, 5696.0, 5469.0, 5602.0, 5552.0, 5348.0, 5711.0, 5545.0, 5297.0, 5568.0, 5382.0, 5393.0, 5385.0, 5682.0, 5336.0, 5451.0, 5547.0, 5570.0 (number of hits: 20)

BRIDGE AND/OR MESH MODE

Test Standard:

Networks Access Points with Bridge and/or MESH modes of operation are permitted to operate in the DFS bands but must employ a DFS function. The functionality of the Bridge mode as specified in §15.403(a) must be validated in the DFS test report. Devices operating as relays where they act as master and client must also employ DFS function for the master. The method used to validate the functionality must be documented and validation data must be documented. Bridge mode can be validated by performing a test statistical performance check (Section 7.8.4) on any one of the radar types. This is an abbreviated test to verify DFS functionality. MESH mode operational methodology must be submitted in the application for certification for evaluation by the FCC.

Test Result:

Compliance, please refer the the below data.

5530MHz**Radar Type 4 Statistical Performance**

Trial #	Fc (MHz)	Pulse/Burst	Pulse Width (μS)	PRI (μs)	Detection (1:yes; 0:no)
1	5530	12	19.7	447	1
2	5530	14	17.5	303	1
3	5530	13	18.3	292	1
4	5530	15	12.4	276	1
5	5530	12	13.3	239	1
6	5530	16	15.1	431	1
7	5530	12	17.6	362	1
8	5530	13	17.8	399	1
9	5530	12	18.7	471	1
10	5530	12	15.1	306	1
11	5530	15	14	217	1
12	5530	16	16.5	369	1
13	5530	12	14.3	377	1
14	5530	14	19.6	254	1
15	5530	16	18.7	320	1
16	5530	15	16.8	496	1
17	5530	15	14	461	1
18	5530	16	15.1	265	1
19	5530	12	11.7	256	1
20	5530	16	16.7	486	1
21	5530	12	13.9	403	1
22	5530	12	16.7	322	1
23	5530	13	11.8	373	1
24	5530	16	15.3	203	1
25	5530	12	18.3	346	1
26	5530	14	17.6	407	1
27	5530	15	18.6	218	1
28	5530	16	14.4	224	1
29	5530	15	12.5	354	1
30	5530	13	18.1	384	1
Detection Percentage: 100 % (>60%)					

******* END OF REPORT *******