

# GWN7604-ANT1 Antenna Specification

Brand Name: GRANDSTREAM

Manufacture: SHENZHEN CHAOLIU NETWORK TECHNOLOGIES CO., LTD

Manufacturing address: 14th Floor, Building-C, Coolpad Building, Gaoxin North District, Science Park,  
Nanshan District, Shenzhen

Product Number (or model Name) : 118-00070-00

## 设计规格 specifications

频率范围 Frequency (MHz)	2.4G: 2400~2500	5G: 5150~5895
电压驻波比 VSWR	$\leq 2.0: 1$	
峰值增益 Peak Gain (dBi)	2.4G: 3.97	5G: 3.54
效率 Efficiency (%)	$\geq 60$	
天线类型 Type	Dipole Antenna	
辐射方向 Radiation Properties	全向 Omni-directional	
最大输入功率 Max Input Power (Watts)	2	
极化方式 Polarization	垂直 Vertical	
阻抗 Impedance (Ohms)	50	
工作温度 Operation Temperature	-40°C to 85°C	
储存温度 Storage Temperature	-40°C to 85°C	
相对湿度 Relative Humidity	40% to 95%	
环保认证 ROHS Compliant	通过 Yes	

## 辐射方向图 Radiation Patterns (unit: dB)

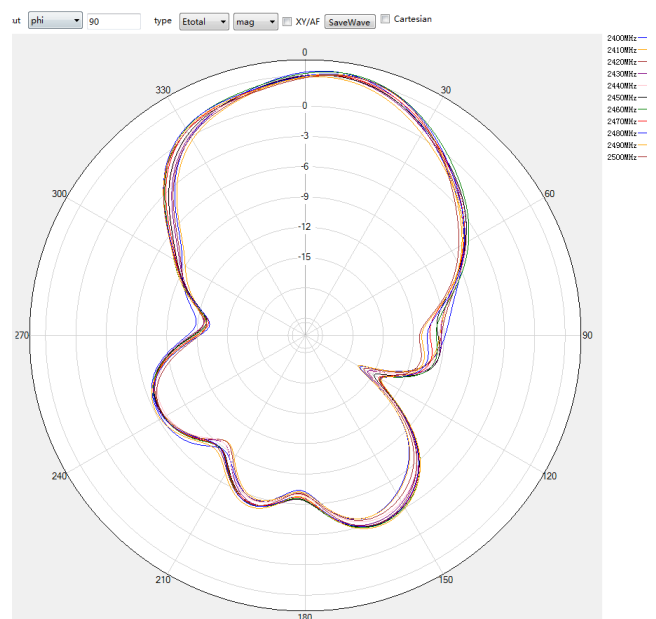
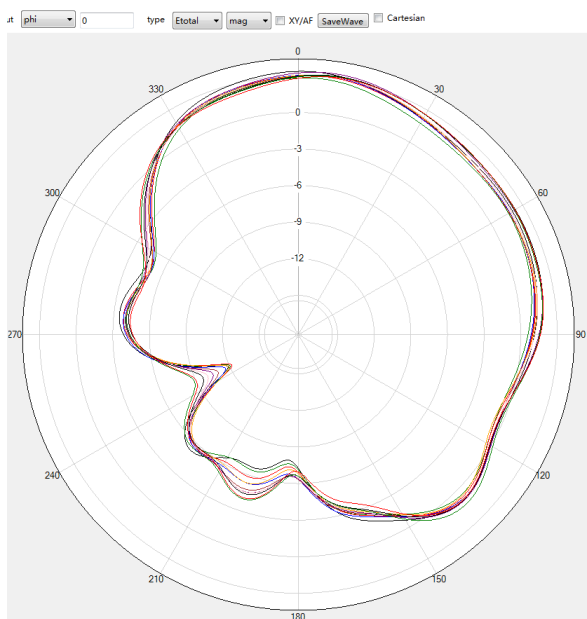

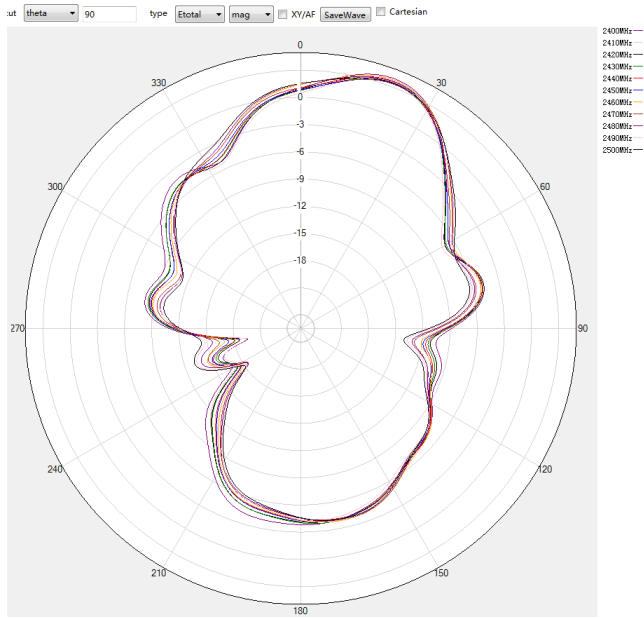

2.4G theta=90deg

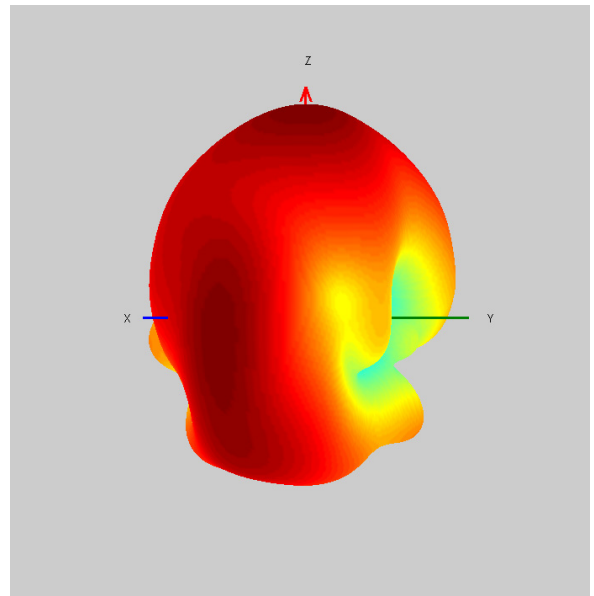

2.4G 3D

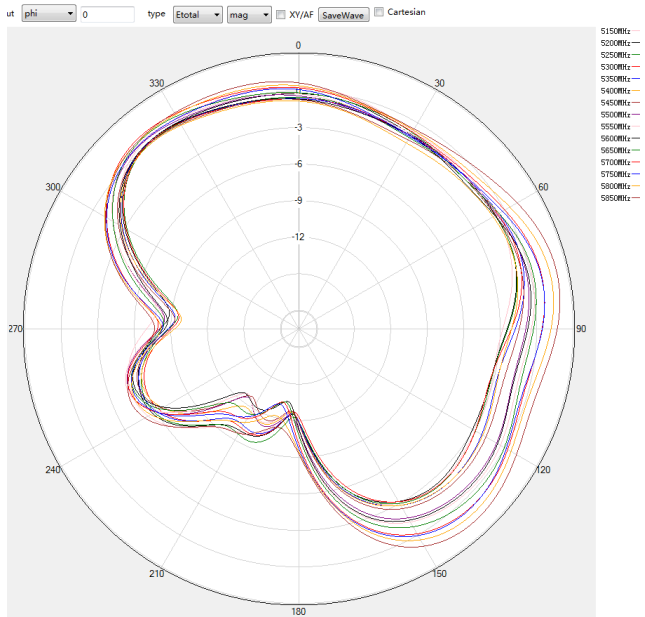

5G phi=0deg

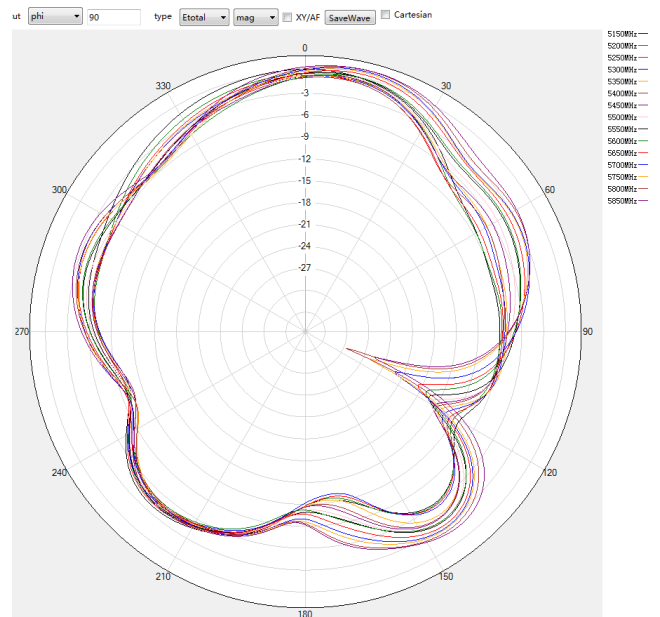

5G phi=90deg

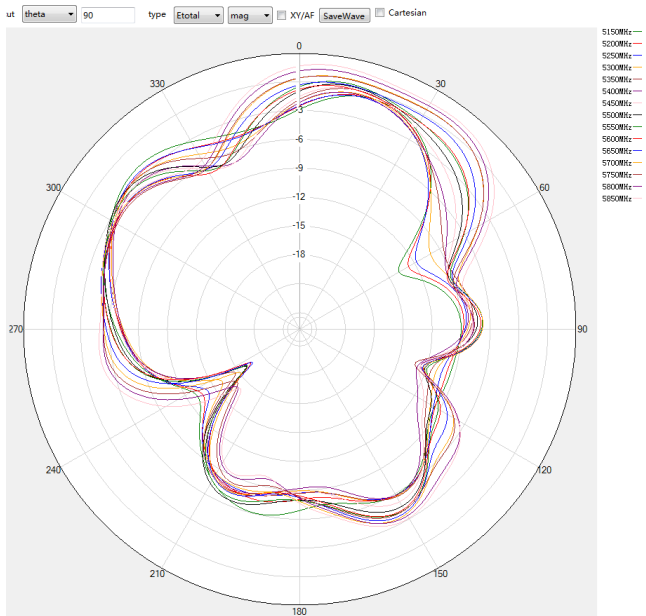

5G theta=90deg

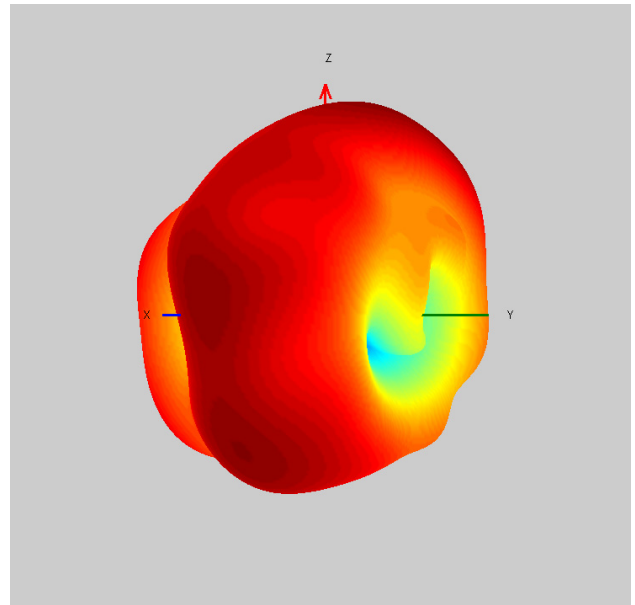

5G 3D

总成图 Mechanical Drawing (unit:mm)

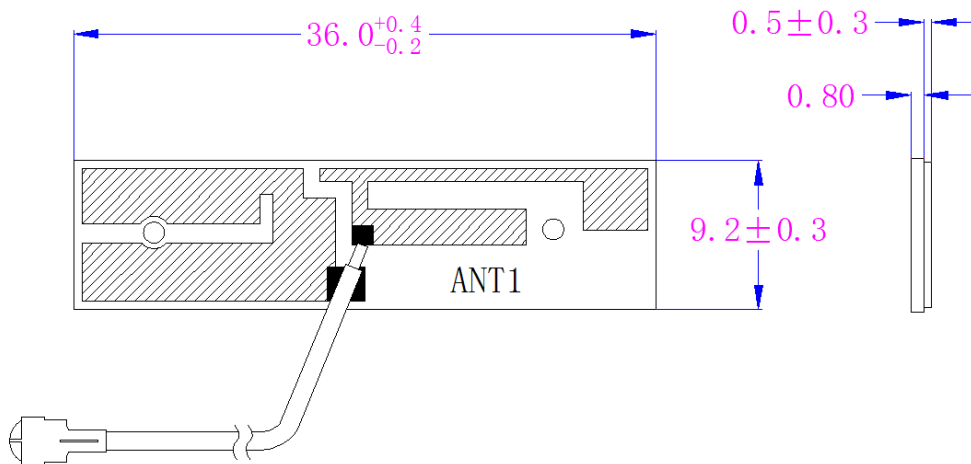

▲ 规格书到此结束 END OF THE SPECIFICATION.