

FCC TEST REPORT

Under :
FCC Part 15, Class B

Prepared For :

Grandstream Networks, Inc.

5F, Bldg #1, No.2 Kefa Rd., Science & Technology Park, Shenzhen, China

FCC ID: YZZGVR3552

EUT: Network Video Recorded

Model: GVR3552

July 15, 2015

Issue Date:

Original Report

Report Type:

Eric Guo

Test Engineer: Eric Guo

Apollo Liu

Review By: Apollo Liu / Manager

TABLE OF CONTENTS

1. General Information	3
1. 1 Notes.....	3
1. 2 Testing Laboratory.....	3
1. 3 Details of Applicant.....	3
1. 4 Application Details	3
1. 5 Test Item	3
1. 6 Test Standards.....	3
2. Technical Test.....	4
2. 1 Summary of Test Results	4
3. EUT Modifications	4
4. Conducted Power Line Test.....	5
4. 1 Test Equipment.....	5
4. 2 Test Procedure	5
4. 3 Test Setup	5
4. 4 Configuration of The EUT.....	5
4. 5 EUT Operating Condition.....	7
4. 6 Conducted Power Line Emission Limits	7
4. 7 Conducted Power Line Test Result.....	7
5. Radiated Emission Test.....	11
5. 1 Test Equipment.....	11
5. 2 Test Procedure	11
5. 3 Radiated Test Setup	11
5. 4 Configuration of The EUT.....	12
5. 5 EUT Operating Condition.....	12
5. 6 Radiated Emission Limit	12
5. 7 Radiated Emission Test Result.....	13
6. Photo of Testing.....	18
6.1 Emission test view.....	18
6.2 Photograph - EUT.....	20
7. FCC Label.....	28
8. Test Equipment.....	29

1. General Information

1.1 Notes

The test results of this report relate exclusively to the test item specified in 1.5. The KMO Lab does not assume responsibility for any conclusions and generalizations drawn from the test results with regard to other specimens or samples of the type of the equipment represented by the test item. The test report may only be reproduced or published in full. Reproduction or publication of extracts from the report requires the prior written approval of the KMO Lab.

1.2 Testing Laboratory

Ke Mei Ou Laboratory Co., Ltd.

ANSI-ASQ National Accreditation Board/ACLASS ISO/IEC 17025 Accredited Lab for telecommunication standards. The Registration Number is AT-1532. The testing quality system meets with ISO/IEC-17025 requirements, This approval results is accepted by MRA of ILAC.

FCC Test Site Registration Number: 962205

IC Test Site Registration Number: 4986A-2

Email: kmo@kmolab.com

Internet: www.kmolab.com

1.3 Details of Applicant

Name : Grandstream Networks, Inc.

Address : 5F, Bldg #1, No.2 Kefa Rd., Science & Technology Park, Shenzhen, China

1.4 Application Details

Date of Receipt of Application : June 4, 2015
 Date of Receipt of Test Item : June 4, 2015
 Date of Test : July 01~July 06, 2015

1.5 Test Item

Manufacturer : Same as applicant
 Address : Same as applicant
 Trade Name : Grandstream
 Model No.(Base) : GVR3552
 Model No.(Extension) : N/A
 Description : Network Video Recorder

Additional Information

Frequency : N/A
 Number of Channels : N/A
 Power Supply : 1#MODEL:F24US1200200A
 INPUT:AC 100-240V 50/60Hz,1.0A max
 OUTPUT:DC 12.0V/2A
 2#MODEL:NBS24J120200HU
 INPUT: AC 100-240V 50/60Hz,0.6A
 OUTPUT:DC 12.0V/2.0A
 Operation Distance : N/A
 Resolution : N/A

1.6 Test Standards

FCC 15 Subpart B

Note: All radiated measurements were made in all three orthogonal planes. The values reported are the maximum values.

2. Technical Test

2.1 Summary of Test Results

The EUT has been tested according to the following specifications:

FCC 15 Subpart B: 2014, Class B

Standard	Test Type	Result	Notes
FCC Part 15, Paragraph 15.107	Conducted Test	PASS	Complies
FCC Part 15, Paragraph 15.109	Radiated Test	PASS	Complies

3. EUT Modifications

No modification by Ke Mei Ou Laboratory Co., Ltd.

4. Conducted Power Line Test

4.1 Test Equipment

Please refer to Section 8 this report.

4.2 Test Procedure

The EUT was tested according to ANSI C63.4 - 2003. The frequency spectrum from 0.15 MHz to 30 MHz was investigated. The LISN used was 50 ohm / 50 u-Henry as specified by section 5.1 OF ANSI C63.4 - 2003. cables and peripherals were moved to find the maximum emission levels for each frequency.

4.3 Test Setup

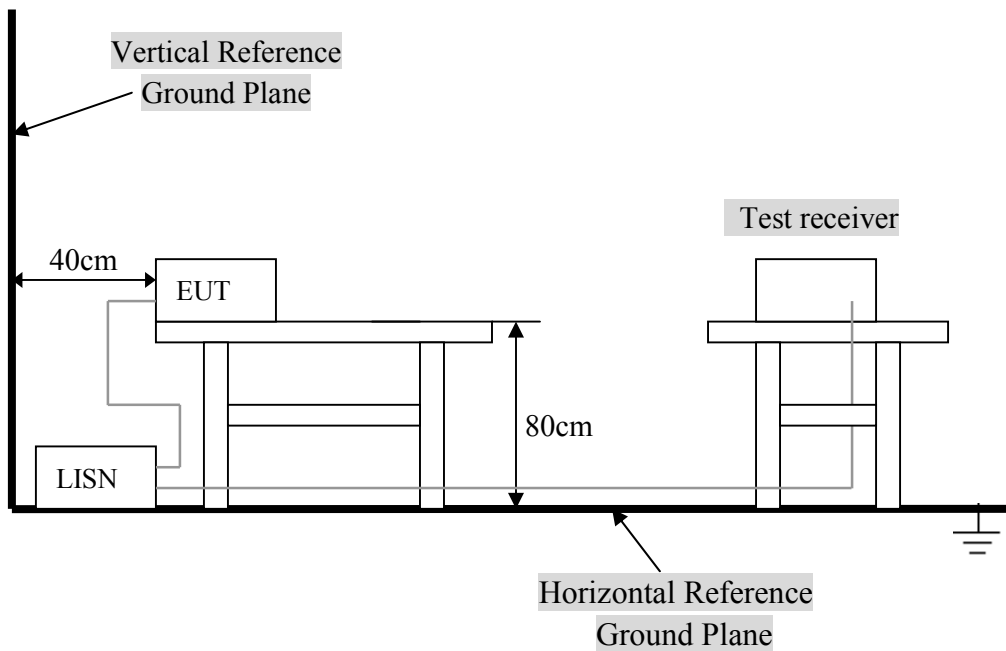

For the actual test configuration, Please refer to the related items – Photos of Testing.

C.

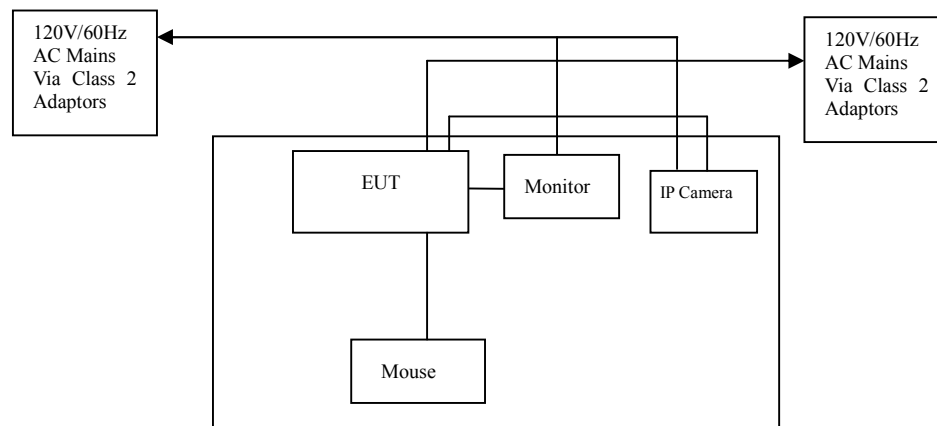

4. 4 Configuration of The EUT

The EUT was configured according to ANSI C63.4-2003. All interface ports were connected to the appropriate peripherals. All peripherals and cables are listed below.

A. EUT

Device	Manufacturer	Model #	Type
Network Video Recorder	Same as applicant	GVR3552	YZZGVR3552

B. Internal Devices

Device	Manufacturer	Model #	FCCID / DoC
N/A			

C. Peripherals

Device	Manufacturer	Model # Serial #	FCC ID/ DoC	Cable
Printer	HP	HP930C	DoC	1.5m unshielded power cord 1.2m unshielded data cable.
Modem	GVC	N/A	DoC	1.5m unshielded power cord 1.2m unshielded data cable.
Notebook	DELL	PP10L	DoC	1.5m unshielded power cord
PC	Dell	2400n	DoC	1.5m unshielded power cord
IP Camera	Granstream	GXV3611IR-HD	YZZGXV3611IR -HD	1.5m unshielded power cord
LED Display	AOC	24PFL3545/T3	DoC	1.5m unshielded power cord 1.5m unshielded data cable.
Mouse	Dell	MO56UOA	DoC	1.5m unshielded data cable

4.5 EUT Operating Condition

The EUT was configured according to ANSI C63.4-2003. All interface ports were connected to the appropriate peripherals. All peripherals and cables are listed below.

4.6 Conducted Power Line Emission Limits

Frequency Range (MHz)	Class A QP/AV (dBuV)	Class B QP/AV (dBuV)
0.15 – 0.5	79/66	66 –56/56 –46
0.5 – 5.0	73/60	56/46
5.0 – 30	73/60	60/50

Note: In the above table, the tighter limit applies at the band edges.

4.7 Conducted Power Line Test Result

The frequency spectrum from 0.15 MHz to 30 MHz was investigated. All readings are quasi -peak values with a resolution bandwidth of 9 KHz.

- Temperature : 29 °C
- Humidity : 36 % RH
- Result : **PASS**

Adapter Model:NBS24J120200HU HDMI Mode

FCC Part 15 Paragraph 15.107							
Frequency (MHz)	Emission (dBuV)		LINE/NEUTRAL	Limit (dBuV)		Margin (dB)	
	QP	AV		QP	AV	QP	AV
0.174	48.16	35.96	Line	64.77	54.77	-16.61	-18.81
0.186	46.17	34.36	Neutral	64.21	54.21	-18.04	-19.85
0.206	42.94	33.27	Line	63.37	53.37	-20.43	-20.10
8.802	52.73	43.47	Neutral	60.00	50.00	-7.27	-6.53
8.802	52.46	43.37	Line	60.00	50.00	-7.54	-6.63
9.318	41.92	31.76	Neutral	60.00	50.00	-18.08	-18.24

Note: NF = No Significant Peak was Found.

Adapter Model:F24US1200200A HDMI Mode

FCC Part 15 Paragraph 15.107							
Frequency (MHz)	Emission (dBuV)		LINE/NEUTRAL	Limit (dBuV)		Margin (dB)	
	QP	AV		QP	AV	QP	AV
0.166	47.43	33.42	Line	65.16	55.16	-17.73	-21.74
0.154	48.36	33.43	Neutral	65.78	55.78	-17.42	-22.35
0.374	47.42	34.57	Line	58.41	48.41	-10.99	-13.84
0.378	40.43	33.85	Neutral	58.32	48.32	-17.89	-14.47
8.846	53.62	44.15	Line	60.00	50.00	-6.38	-5.85
8.886	53.26	43.42	Neutral	60.00	50.00	-6.74	-6.58

Note: NF = No Significant Peak was Found.

Adapter Model:NBS24J120200HU VGA Mode

FCC Part 15 Paragraph 15.107							
Frequency (MHz)	Emission (dBuV)		LINE/NEUTRAL	Limit (dBuV)		Margin (dB)	
	QP	AV		QP	AV	QP	AV
0.166	49.72	36.35	Line	65.16	55.16	-15.44	-18.81
0.186	46.59	33.36	Neutral	64.21	54.21	-17.62	-20.85
3.826	44.63	34.96	Line	56.00	46.00	-11.37	-11.04
3.782	43.26	34.89	Neutral	56.00	46.00	-12.74	-11.11
8.846	50.73	40.94	Line	60.00	50.00	-9.27	-9.06
8.726	50.64	41.26	Neutral	60.00	50.00	-9.36	-8.74

Note: NF = No Significant Peak was Found.

Adapter Model:F24US1200200A VGA Mode

FCC Part 15 Paragraph 15.107							
Frequency (MHz)	Emission (dBuV)		LINE/NEUTRAL	Limit (dBuV)		Margin (dB)	
	QP	AV		QP	AV	QP	AV
0.158	45.53	31.68	Line	65.57	55.57	-20.04	-23.89
0.166	45.35	32.34	Neutral	65.16	55.16	-19.81	-22.82
3.846	45.26	36.08	Line	56.00	46.00	-10.74	-9.92
3.806	45.92	36.83	Neutral	56.00	46.00	-10.08	-9.17
8.762	51.65	42.63	Line	60.00	50.00	-8.35	-7.37
8.802	50.83	41.82	Neutral	60.00	50.00	-9.17	-8.18

Note: NF = No Significant Peak was Found.

Remarks :

- 1.Uncertainty in conducted emission measured is $\leq \pm 0.2$ dB.
- 2.QP and AV are abbreviations of quasi-peak and average individually.
- 3.The emission levels of other frequencies were very low against the limit.
- 4.The Quasi-peak emission level also meets average limit and measurement with the average detector is unnecessary.
- 5.Margin Value= Emission Level – Limit Value.

Conducted Emission

FCC15.107

EUT: Network Video Recorder

M/N: GVR3552

Manufacturer:

Test Specification: LINE&NEUTRAL

Comment: HDMI Mode

Power Adapter Model: NBS24J120200HU

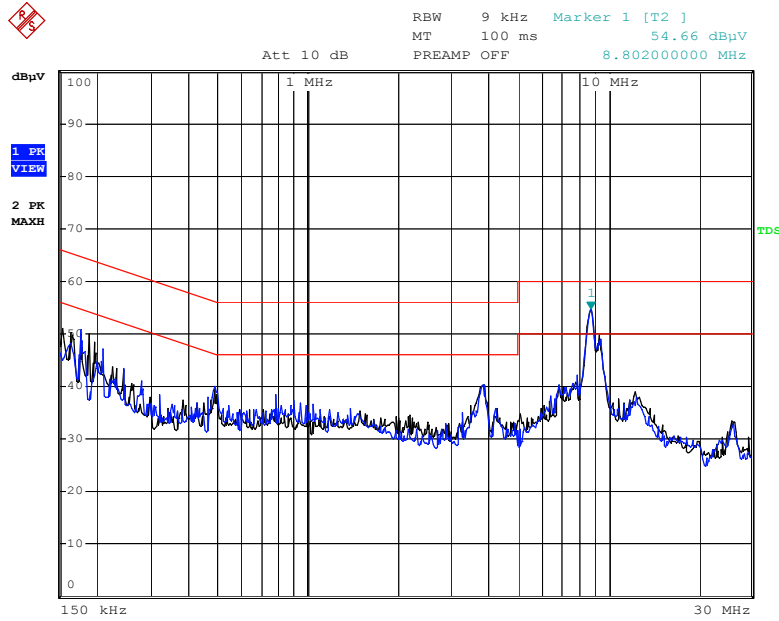

Date: 1.JUL.2015 17:08:16

Comment: HDMI Mode

Power Adapter Model: F24US1200200A

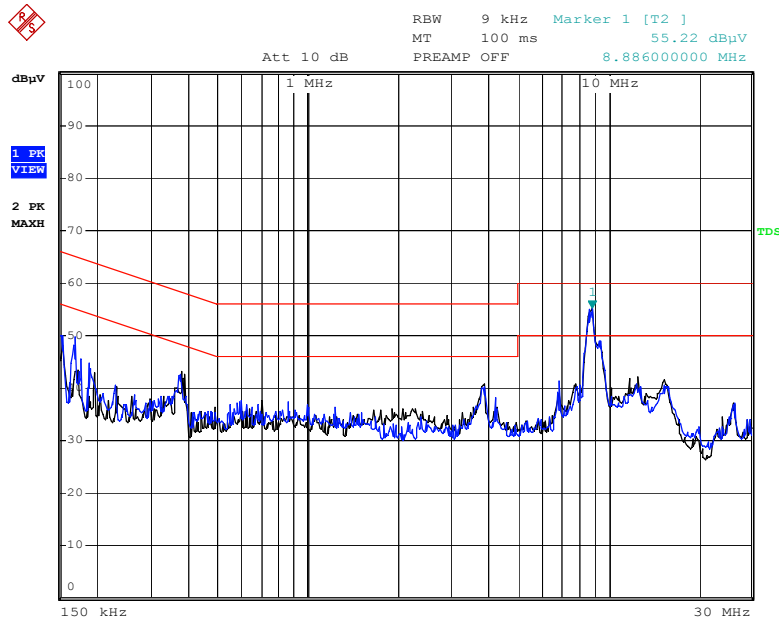

Date: 1.JUL.2015 17:18:01

Comment: VGA Mode

Power Adapter Model: NBS24J120200HU

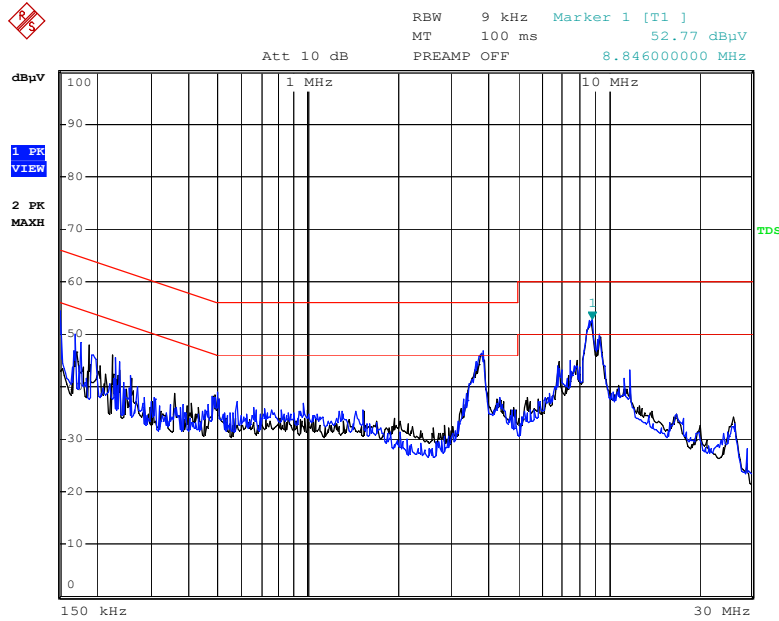

Date: 1.JUL.2015 16:52:36

Comment: VGA Mode

Power Adapter Model: F24US1200200A

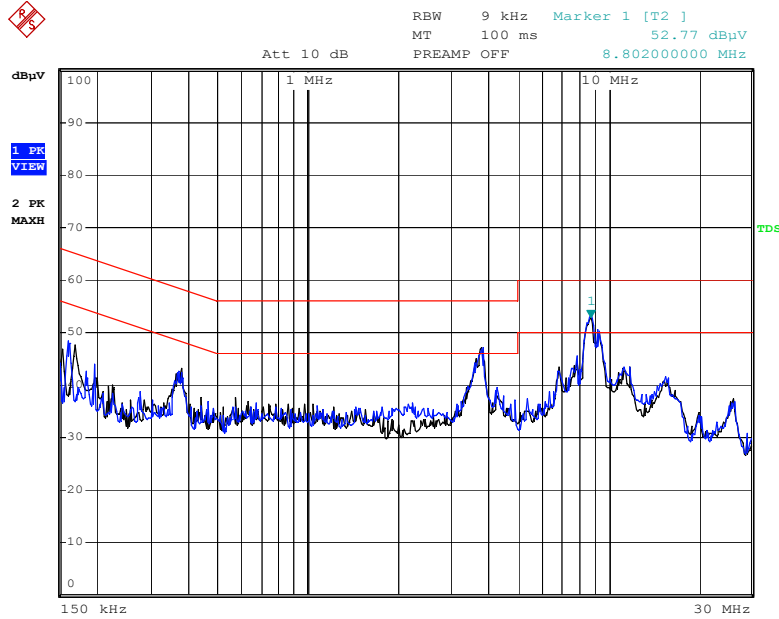

Date: 1.JUL.2015 16:42:40

5. Radiated Emission Test

5.1 Test Equipment

Please refer to Section 8 this report.

5.2 Test Procedure

1. The EUT was tested according to ANSI C63.4 - 2003.
2. The EUT, peripherals were put on the turntable which table size is 1m x 1.5 m, table high 0.8 m. All set up is according to ANSI C63.4-2003.
3. The frequency spectrum from 9 kHz to 25 GHz was investigated. All readings from 9 kHz to 150 kHz are quasi-peak values with a resolution bandwidth of 200 Hz. All readings from 150 kHz to 30 MHz are quasi-peak values with a resolution bandwidth of 9 KHz. All readings from 30 MHz to 1 GHz are quasi-peak values with a resolution bandwidth of 120 KHz. All readings are above 1 GHz , peak values with a resolution bandwidth of 1 MHz . Measurements were made at 3 meters.
4. The emissions from the EUT were measured continuously at every azimuth by rotating the turntable. The Receiving antenna high is varied from 1 m to 4 m high to find the maximum emission for each frequency. Emissions below 30MHz were measured with a loop antenna while emission above 30MHz were measured using a broadband E-field antenna.
5. Maximizing procedure was performed on the six (6) highest emissions to ensure EUT compliance is with all installation combinations. All data was recorded in the peak detection mode. Quasi-peak readings was performed only when an emission was found to be marginal (within -4 dB of specification limit), and are distinguished with a "QP" in the data table.
6. Each emission was to be maximized by changing the polarization of receiving antenna both horizontal and vertical. In order to find out the max. emission, the relative positions of this transmitter(EUT) was rotated through three orthogonal axes according to the requirements in Section 8 and 13 of ANSI C63.4 - 2003.

5.3 Radiated Test Setup

For Frequencies below 30 MHz

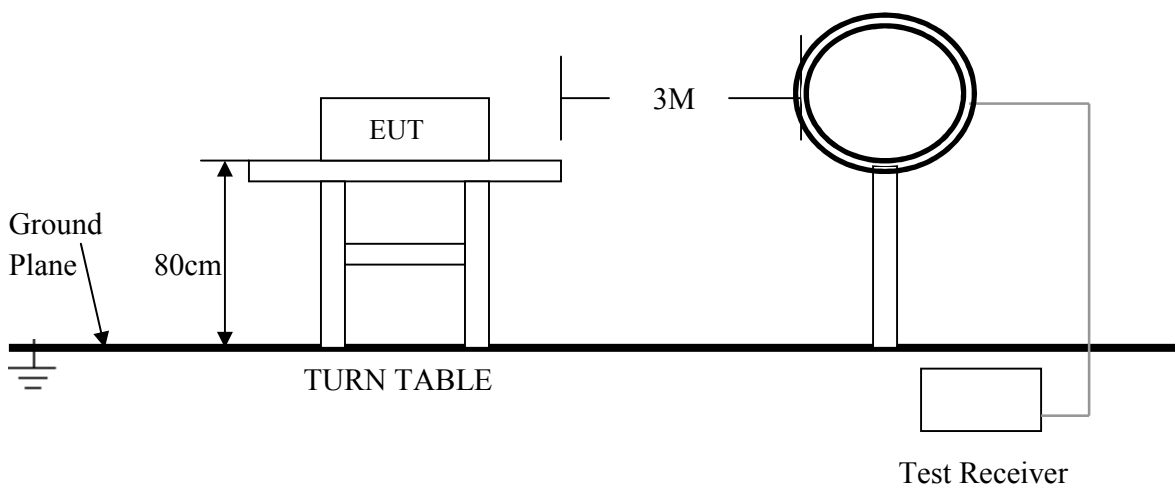

For the actual test configuration , please refer to the related items – Photos of Testing

For Frequencies above 30 MHz

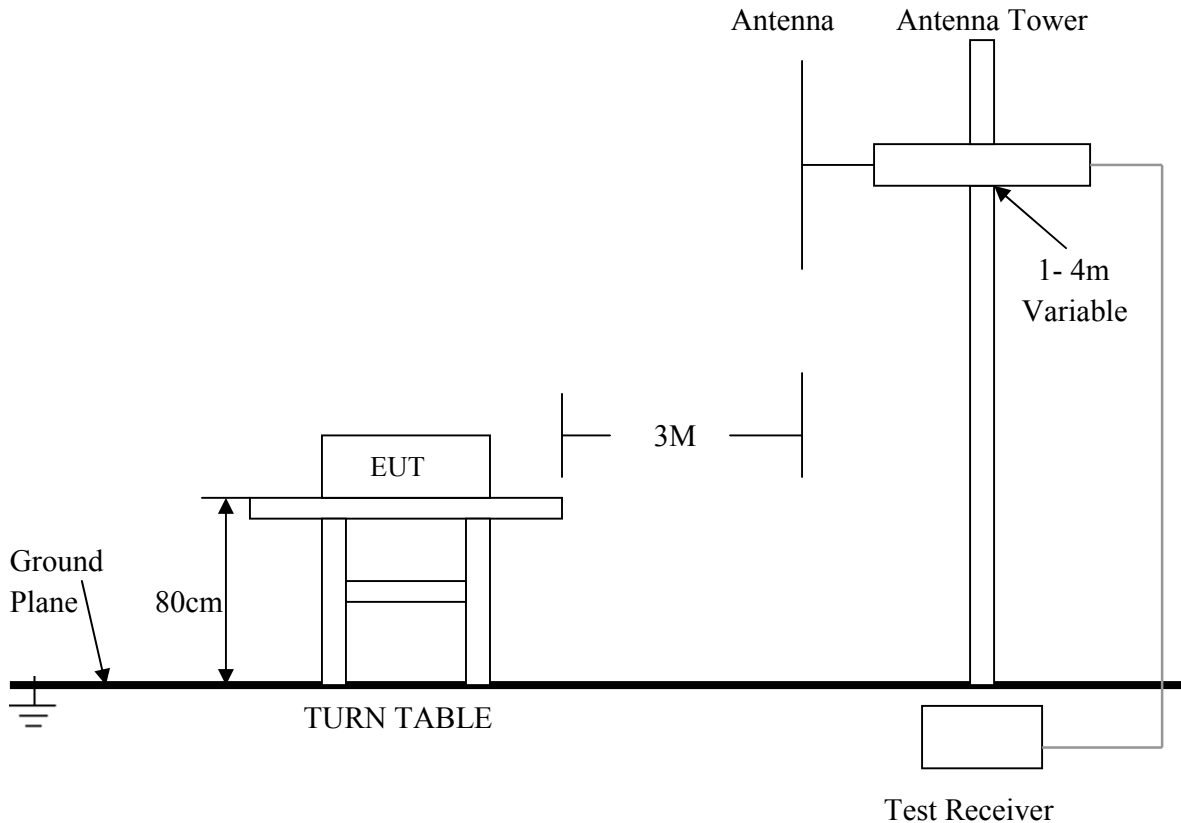

For the actual test configuration , please refer to the related items – Photos of Testing

5.4 Configuration of The EUT

Same as section 4.4 of this report

5.5 EUT Operating Condition

Same as section 4.5 of this report

5.6 Radiated Emission Limit

All emission from a digital device, including any network of conductors and apparatus connected thereto, shall not exceed the level of field strength specified below:

Frequencies in restricted band are complied to limit on Paragraph 15.109.

Frequency (MHz)	Distance (m)	Field Strength (dBuV/m)
30 - 88	3	40.0
88 - 216	3	43.5
216 - 960	3	46.0
Above 960	3	54.0

Note:

1. In the emission tables above, the tighter limit applies at the band edges.
2. Distance refers to the distance between measuring instrument, antenna, and the closest point of any part of the device or system.
3. The lower limit shall apply at the transition frequencies.

5.7 Radiated Emission Test Result

The frequency spectrum from 30 MHz to 1 GHz was investigated. All readings from 30 MHz to 1 GHz are quasi-peak values with a resolution bandwidth of 120 KHz. All readings are above 1 GHz, peak values with a resolution bandwidth of 1 MHz. Measurements were made at 3 meters.

- Temperature : 24 °C
- Humidity : 56 %RH
- Result : **PASS**

For Frequency Below 30MHz

Adapter Model: F24US1200200A VGA Mode

Freq. (MHz)	Reading Level (dBuV)	Emission (dBuV/m)	Factor	Polarity	Limits (dBuV/m)	Margin (dB)
0.048	29.83	50.300	20.47	Horiz.	113.800	-63.500
0.106	23.77	44.160	20.39	Horiz.	107.180	-63.020
2.512	10.90	31.250	20.35	Horiz.	69.500	-38.250
7.042	11.12	31.360	20.24	Horiz.	69.500	-38.140

- Note:**
- (1) All Readings below 1GHz are Quasi-Peak, above are performed with peak and/or average measurements as necessary.
 - (2) "N/A" remark, if no specific emissions from the EUT are recorded (ie: margin>20dB from the applicable limit) and considered that's already beyond the background noise floor.
 - (3) Emission Level = Reading Level + Probe Factor + Cable Loss.
 - (4) Factor = Probe Factor + Cable Loss.

For Frequency Above 30MHz

Adapter Model: NBS24J120200HU HDMI Mode

FCC15 Class B						
Freq. (MHz)	Reading Level (dBuV)	Emission (dBuV/m)	Factor	HORIZ / VERT	Limits (dBuV/m)	Margin (dB)
40.960	19.67	32.08	12.41	Horiz./	40.0	-7.92
41.080	18.42	30.83	12.41	Vert.	40.0	-9.17
367.600	20.34	37.46	17.13	Horiz./	46.0	-8.54
151.600	18.45	35.72	17.27	Vert.	43.5	-7.78
594.040	22.29	39.58	17.29	Horiz./	46.0	-6.42
770.520	12.83	39.78	26.96	Vert.	46.0	-6.22

Note: NF = No Significant Peak was Found.

Adapter Model: F24US1200200A HDMI Mode

FCC15 Class B						
Freq. (MHz)	Reading Level (dBuV)	Emission (dBuV/m)	Factor	HORIZ / VERT	Limits (dBuV/m)	Margin (dB)
47.800	22.48	34.62	12.14	Horiz./	40.0	-5.38
31.360	17.79	28.94	11.15	Vert.	40.0	-11.06
151.560	18.57	35.84	17.27	Horiz./	43.5	-7.66
580.440	13.79	31.08	17.29	Vert.	46.0	-14.92
742.520	13.33	40.28	26.96	Horiz./	46.0	-5.72
747.560	11.12	38.07	26.96	Vert.	46.0	-7.93

Note: NF = No Significant Peak was Found.

Adapter Model: NBS24J120200HU VGA Mode

FCC15 Class B						
Freq. (MHz)	Reading Level (dBuV)	Emission (dBuV/m)	Factor	HORIZ / VERT	Limits (dBuV/m)	Margin (dB)
61.800	22.36	33.85	11.50	Horiz./	40.0	-6.15
61.680	18.59	30.08	11.50	Vert.	40.0	-9.92
375.000	25.07	42.19	17.13	Horiz./	46.0	-3.81
375.000	21.53	38.65	17.13	Vert.	46.0	-7.35
500.000	23.36	40.65	17.29	Horiz./	46.0	-5.35
625.000	10.92	35.39	24.47	Vert.	46.0	-10.62

Note: NF = No Significant Peak was Found.

Adapter Model: F24US1200200A VGA Mode

FCC15 Class B						
Freq. (MHz)	Reading Level (dBuV)	Emission (dBuV/m)	Factor	HORIZ / VERT	Limits (dBuV/m)	Margin (dB)
40.000	20.61	33.02	12.41	Horiz./	40.0	-6.98
40.000	21.17	33.58	12.41	Vert.	40.0	-6.42
47.800	23.75	35.89	12.14	Horiz./	40.0	-4.11
47.800	23.39	35.53	12.14	Vert.	40.0	-4.47
305.320	20.36	37.48	17.13	Horiz./	46.0	-8.52
152.160	15.51	32.78	17.27	Vert.	43.5	-10.72

Note: NF = No Significant Peak was Found.
Above 1GHz

Adapter Model: NBS24J120200HU HDMI Mode

FCC 15 Class B										
Frequency (MHz)	Reading Level(dBuV)		Factor (dB)	Emission(dBuV/m)		Horiz./ Vert.	Limit (dBuV/m)		Margin(dB)	
	PK	AV		PK	AV		PK	AV	PK	AV
	1492.00	21.59		-	26.98		48.57	-	Horiz./	74.0
1485.20	23.85	-	26.98	50.83	-	Vert.	74.0	54.0	-23.17	-
1923.20	22.34	-	27.44	49.78	-	Horiz./	74.0	54.0	-24.22	-
1860.80	23.13	-	27.22	50.35	-	Vert.	74.0	54.0	-23.65	-
2227.60	21.32	-	30.51	51.83	-	Horiz./	74.0	54.0	-22.17	-
2227.60	22.62	-	30.51	53.13	-	Vert.	74.0	54.0	-20.87	-

Note: NF = No Significant Peak was Found.

- Note:**
- (1) All Readings below 1GHz are Quasi-Peak, above are performed with peak and/or average measurements as necessary.
 - (2) "N/A" remark, if no specific emissions from the EUT are recorded (ie: margin>20dB from the applicable limit) and considered that's already beyond the background noise floor.
 - (3) Emission Level = Reading Level + Probe Factor + Cable Loss.
 - (4) Factor = Probe Factor + Cable Loss.

Radiated Emission

FCC15.109

EUT: Network Video Recorder

M/N: GVR3552

Manufacturer:

Fication: LINE&NEUTRAL

Comment: HDMI Mode

Power Adapter Model: NBS24J120200HU

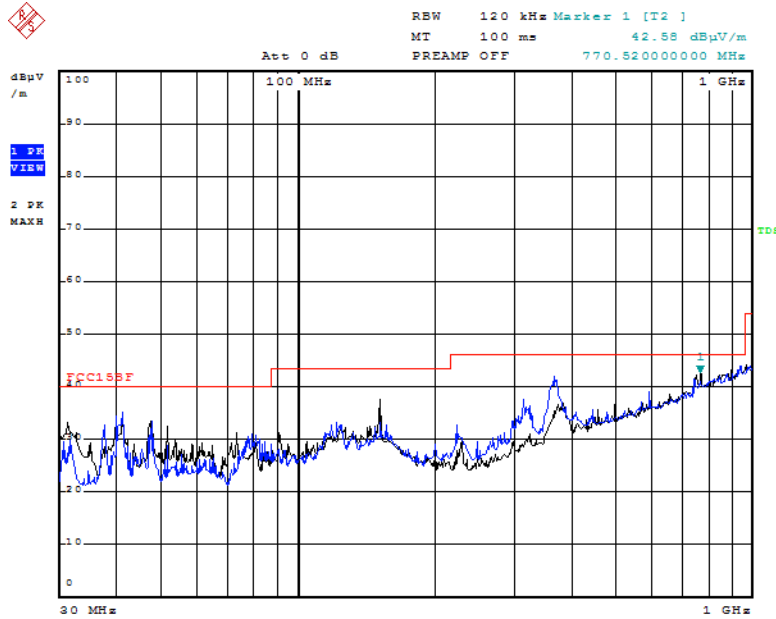

Date: 3.JUL.2015 15:09:46

Comment: HDMI Mode

Power Adapter Model: F24US1200200A

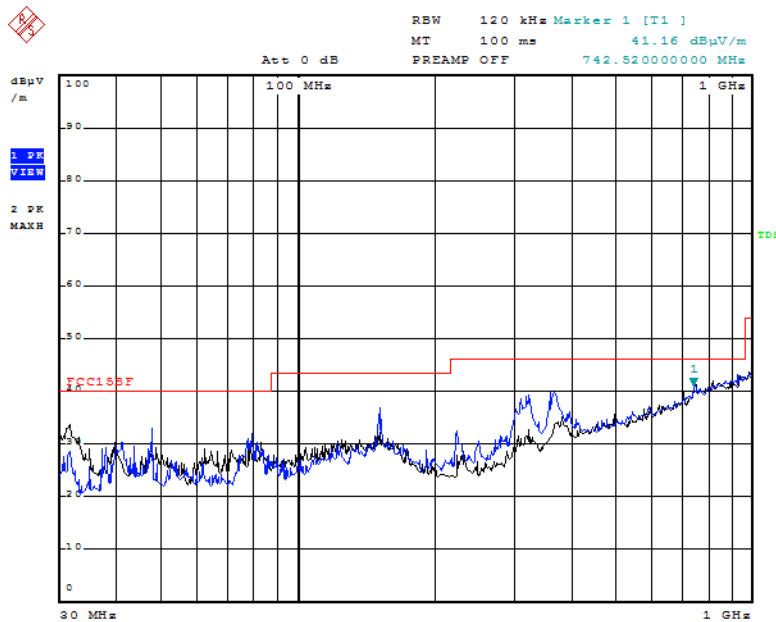

Date: 3.JUL.2015 14:38:09

Comment: VGA Mode

Power Adapter Model: NBS24J120200HU

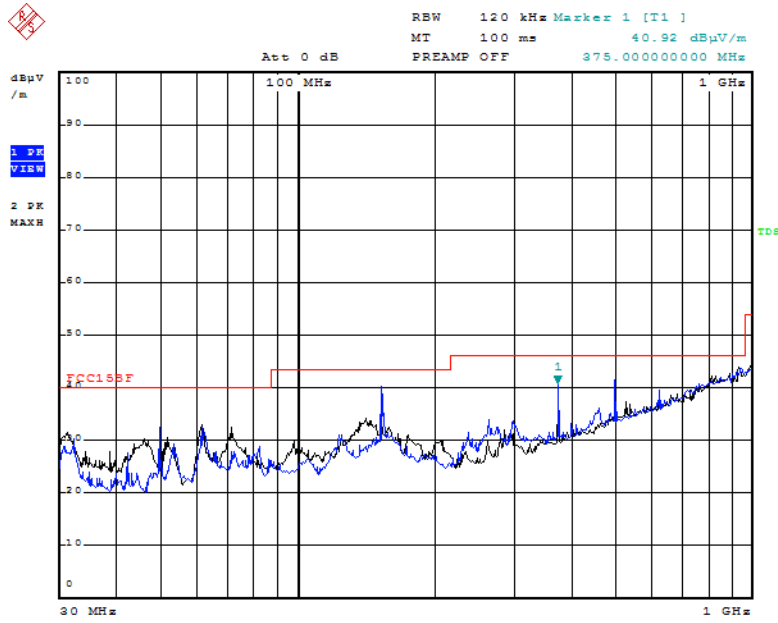

Date: 1.JUL.2015 16:09:18

Comment: VGA Mode

Power Adapter Model: F24US1200200A

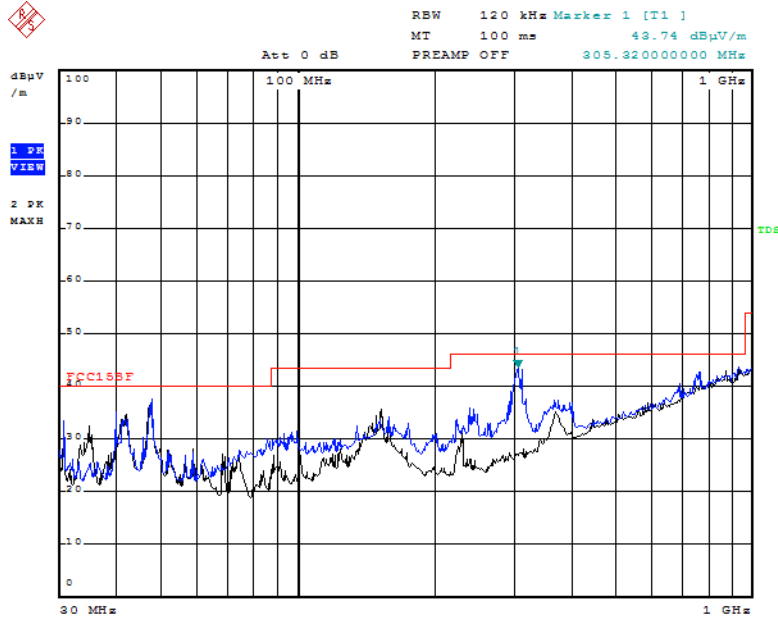

Date: 6.JUL.2015 14:28:18

Comment: 1GHz Above

Adapter Model: NBS24J120200HU HDMI Mode

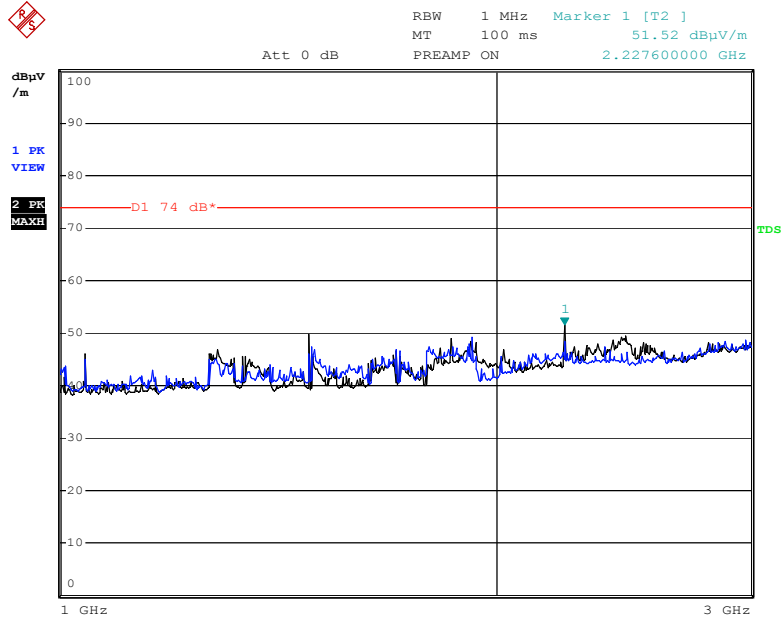

Date: 6.JUL.2015 10:34:54

6. Photo of Testing

6.1 Emission test view

Conducted Emission



Radiated Emission (30MHz~1GHz)



Radiated Emission (1GHz Above)



6.2 Photograph - EUT

EUT top view





EUT bottom view





EUT inside whole view

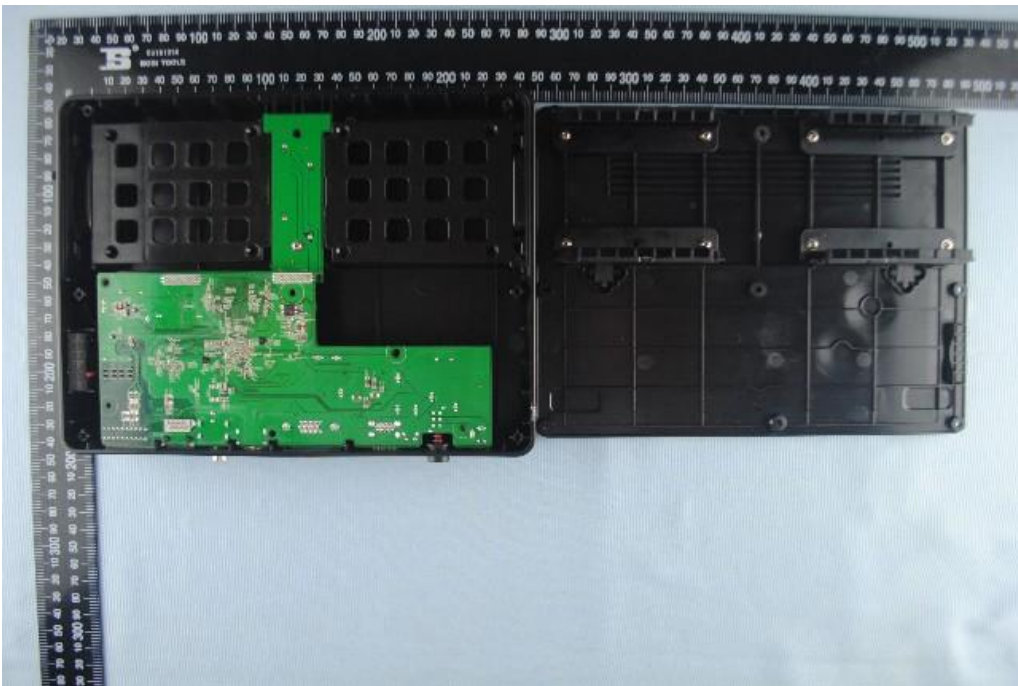

Main board component side

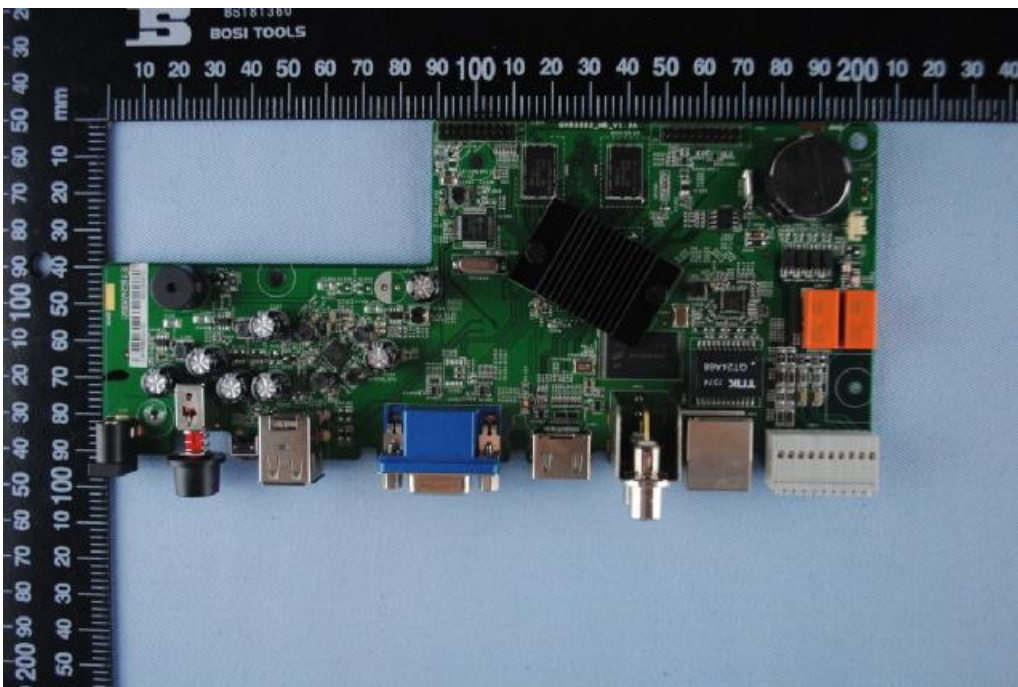

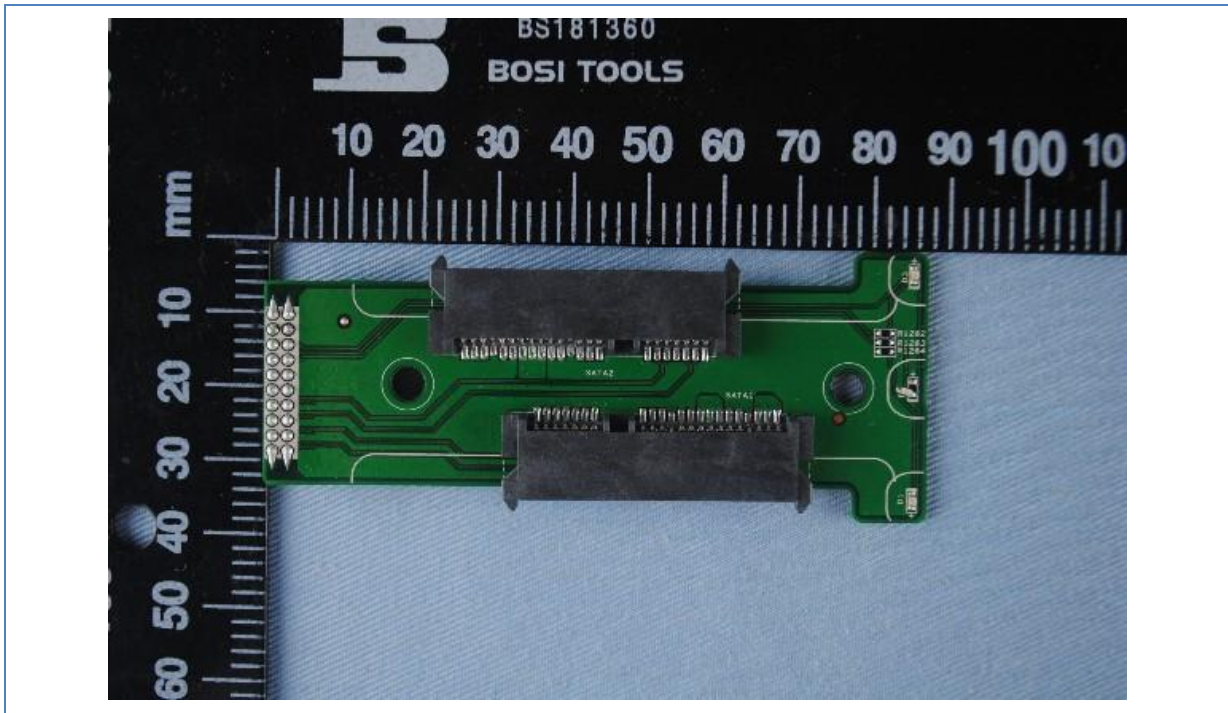

Main board solder side

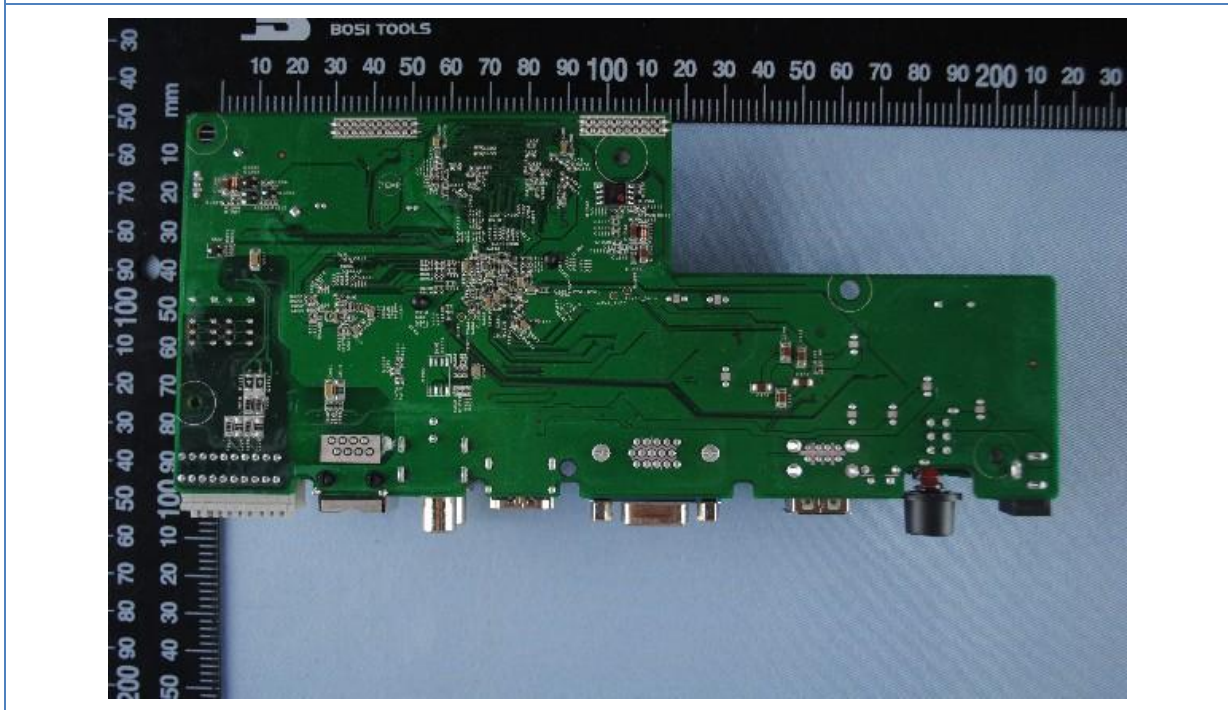

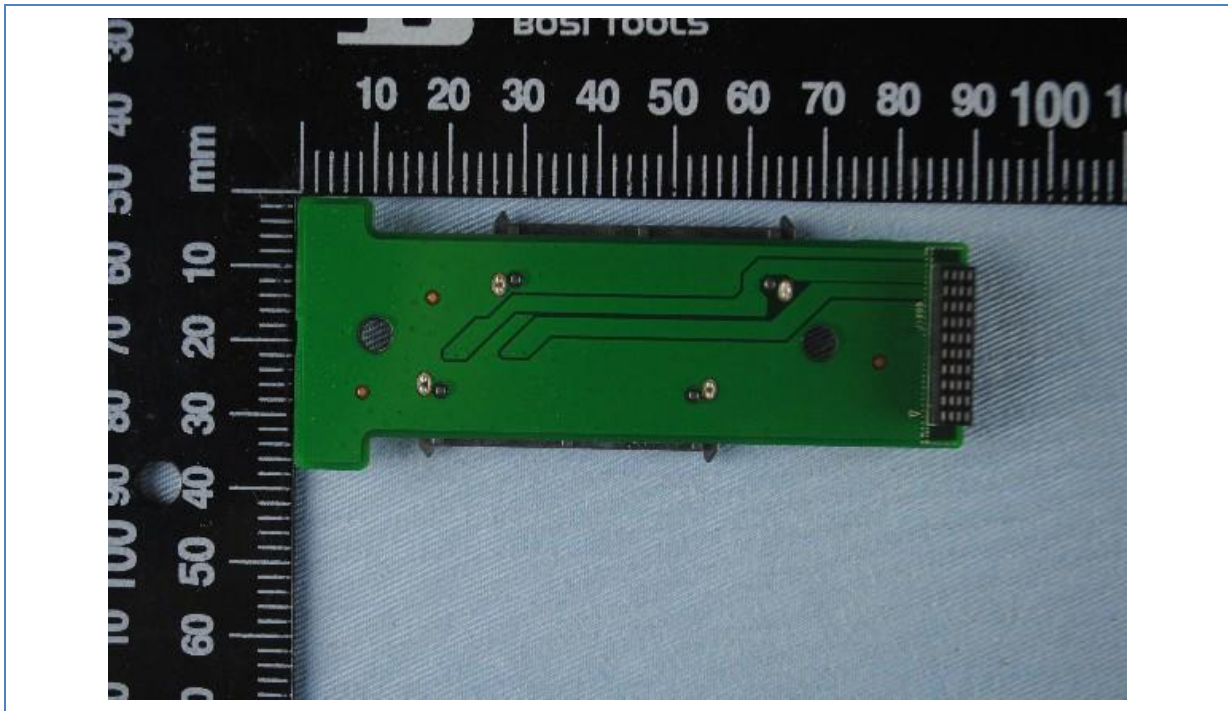

Adapter top view (Mass Power Supply-USA)



Adapter side view (MASS Power Supply-USA)



Adapter top view (Sunlight Power Supply-USA)



Adapter side view (Sunlight Power Supply-USA)



7. FCC Label

This device complies with Part 15 of the FCC Rules. Operation is subject to the following two conditions: (1) this device may not cause harmful interference, and (2) this device must accept any interference received, including interference that may cause undesired operation.

The Label must not be a stick-on paper label. The Label on these products must be permanently affixed to the product and readily visible at the time of purchase and must last the expected lifetime of the equipment not be readily detachable.

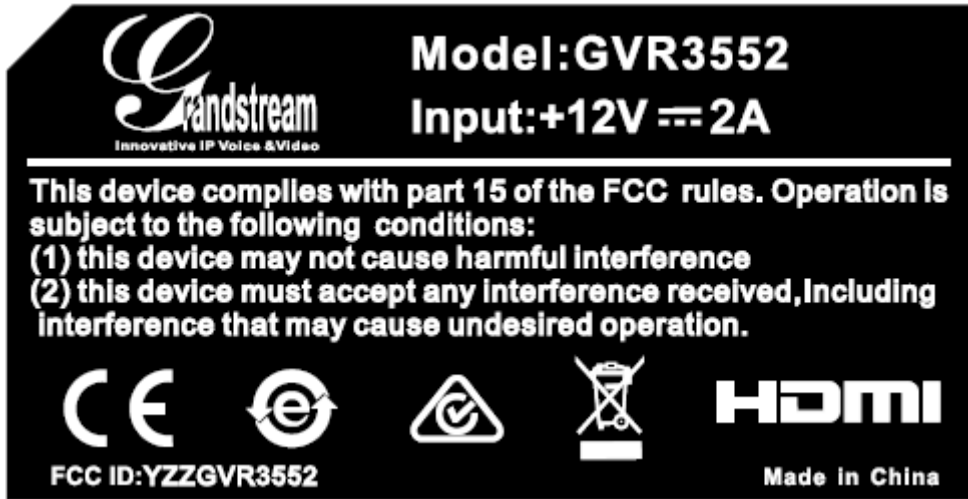

Proposed Label Location on EUT



8. Test Equipment

The following test equipments were used during the radiated & conducted emission test:

Equipment/ Facilities	Manufacturer	Model #	Serial No.	Due Date
Turntable	Innco systems GmbH	CT-0801	KMO-SZ114	NCR
Antenna Tower	Innco systems GmbH	MM4000-PP	KMO-SZ115	NCR
Controller	Innco systems GmbH	CO2000	KMO-SZ116	NCR
Pre-Amplifier	Agilent	87405C	KMO-SZ155	Dec.6, 2015
Pre-Amplifier	Com-Power	PAM-840	KMO-SZ156	Dec.6, 2015
Horn Antenna	Com-Power	AH-840	KMO-SZ157	Dec.6, 2015
EMI Test Receiver	Rohde & Schwarz	ESPI7	KMO-SZ002	June 27, 2015
Spectrum Analyzer	Rohde & Schwarz	FSP40	KMO-SZ003	June 27, 2015
Signal Generator	FLUKE	PM5418+Y/C	KMO-SZ020	May 27, 2016
Loop Antenna	Rohde & Schwarz	HFH2-Z2	KMO-SZ004	Jan. 30, 2016
Trilog-Super Broadband Antenna	SCHWARZBECK	VULB9161	KMO-SZ005	Sep.18, 2015
Trilog-Super Broadband Antenna	SCHWARZBECK	VULB9161	KMO-SZ006	Sep.18, 2015
Broad-Band Horn Antenna	SCHWARZBECK	BBHA 9120D	KMO-SZ007	Sep.18, 2015
Broad-Band Horn Antenna	SCHWARZBECK	BBHA 9120D	KMO-SZ008	Sep.18, 2015
AMN	Rohde & Schwarz	ESH3-Z5	KMO-SZ009	June 27, 2015
Pulse Limiter	SCHWARZBECK	VTSD 9561-F	KMO-SZ077	Nov.29, 2015
ISN	SCHWARZBECK	NTFM 8158 CAT3	KMO-SZ070	Nov.19, 2015
ISN	SCHWARZBECK	NTFM 8158 CAT5	KMO-SZ071	Nov.19, 2015
ISN	SCHWARZBECK	NTFM 8158 CAT6	KMO-SZ072	Nov.19, 2015
KMO Shielded Room	KMO	KMO-001	KMO-SZ036	NCR
Coaxial Cable with N-Connectors	SCHWARZBECK	AK9515H	KMO-SZ037	Sep.18, 2015
AC Power Source / Analyzer	Agilent	6813B	KMO-SZ166	July 22, 2015
Power Meter	Rohde & Schwarz	OSP-B157	KMO-HK015	Nov.6, 2015
Digital Radio Communication Tester	Rohde & Schwarz	CMD60	KMO-SZ169	April 10, 2016
Universal Radio Communication Tester	Rohde & Schwarz	CMU200	KMO-SZ170	April 10, 2016
Program Control Telephone Exchanger	Excelltel	CDX8000-M	KMO-SZ221	NCR
3m Anechoic Chamber	KMO	KMO-3AC	KMO-3AC-1	Nov.12, 2016
Temperature Chamber	TABAI	PSL-4GTW	N/A	Feb.10, 2016