



Grandstream Networks, Inc.

---

GVC3210/ GVC3210RMT

Video Conference System for Android™

**User Guide**

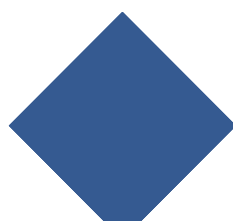

## **COPYRIGHT**

©2017 Grandstream Networks, Inc. <http://www.grandstream.com>

All rights reserved. Information in this document is subject to change without notice. Reproduction or transmittal of the entire or any part, in any form or by any means, electronic or print, for any purpose without the express written permission of Grandstream Networks, Inc. is not permitted.

The latest electronic version of this guide is available for download here:

<http://www.grandstream.com/support>

Grandstream is a registered trademark and Grandstream logo is trademark of Grandstream Networks, Inc. in the United States, Europe and other countries.

## **CAUTION**

Changes or modifications to this product not expressly approved by Grandstream, or operation of this product in any way other than as detailed by this guide, could void your manufacturer warranty.

## **WARNING**

Please do not use a different power adaptor with devices as it may cause damage to the products and void the manufacturer warranty.



## FCC Authentication

For Video Conference System, model: GVC3210  
FCC ID: YZZGVC3210

For Bluetooth Remote Control, model: GVC3210 RMT  
FCC ID: YZZGVC3210RMT

Any Changes or modifications not expressly approved by the party responsible for compliance could void the user's authority to operate the equipment.

This device complies with part 15 of the FCC Rules. Operation is subject to the following two conditions: (1) This device may not cause harmful interference, and (2) this device must accept any interference received, including interference that may cause undesired operation.

Note: This equipment has been tested and found to comply with the limits for a Class B digital device, pursuant to part 15 of the FCC Rules. These limits are designed to provide reasonable protection against harmful interference in a residential installation. This equipment generates uses and can radiate radio frequency energy and, if not installed and used in accordance with the instructions, may cause harmful interference to radio communications. However, there is no guarantee that interference will not occur in a particular installation. If this equipment does cause harmful interference to radio or television reception, which can be determined by turning the equipment off and on, the user is encouraged to try to correct the interference by one or more of the following measures:

- Reorient or relocate the receiving antenna.
- Increase the separation between the equipment and receiver.
- Connect the equipment into an outlet on a circuit different from that to which the receiver is connected.
- Consult the dealer or an experienced radio/TV technician for help.

### **FCC Radiation Exposure Statement:**

For GVC3210

This equipment complies with FCC radiation exposure limits set forth for an uncontrolled environment. This equipment should be installed and operated with minimum distance 20cm between the radiator & your body.

This transmitter must not be co-located or operating in conjunction with any other antenna or transmitter.



For GVC3210 RMT

This equipment complies with FCC radiation exposure limits set forth for an uncontrolled environment.

This transmitter must not be co-located or operating in conjunction with any other antenna or transmitter.

## CE Authentication

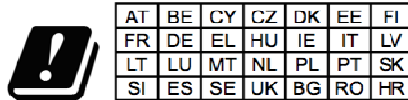

In all EU member states, operation of 5150  
- 5350 MHz is restricted to indoor use only.

Hereby, Grandstream Networks, Inc. declares that the radio equipment GVC3210 and GVC3210 RMT are in compliance with Directive 2014/53/EU.

The full text of the EU declaration of conformity is available at the following internet address:

<http://www.grandstream.com/support/resources/>





## **GNU GPL INFORMATION**

GVC3210 firmware contains third-party software licensed under the GNU General Public License (GPL). Grandstream uses software under the specific terms of the GPL. Please see the GNU General Public License (GPL) for the exact terms and conditions of the license.

Grandstream GNU GPL related source code can be downloaded from Grandstream Web site from:  
<http://www.grandstream.com/sites/default/files/Resources/gvc32xx-gpl.tar.gz>



## Table of Contents

<b>DOCUMENT PURPOSE .....</b>	<b>16</b>
<b>CHANGE LOG .....</b>	<b>17</b>
Firmware Version 1.0.1.13 .....	17
Firmware Version 1.0.1.6 .....	17
<b>WELCOME .....</b>	<b>18</b>
<b>PRODUCT OVERVIEW .....</b>	<b>19</b>
Safety Compliances .....	21
Warranty.....	21
<b>INSTALLING GVC3210 .....</b>	<b>22</b>
Equipment Package Content.....	22
Connecting GVC3210.....	23
<b>GETTING TO KNOW GVC3210 .....</b>	<b>27</b>
Remote Control.....	27
<i>Remote Control Keys and Touchpad.....</i>	<i>27</i>
<i>Using the Remote Control .....</i>	<i>30</i>
<i>Capturing Screenshot using the Remote Control.....</i>	<i>30</i>
Using Mouse & Keyboard .....	31
Using the LED Indicator .....	31
Status Icons .....	32
Using the Onscreen Keyboard.....	33
<i>English Keyboard.....</i>	<i>33</i>
<i>Numbers and Symbols .....</i>	<i>34</i>
Home Screen .....	34
Screen Lock .....	35
<b>CONNECTING TO NETWORK AND DEVICES .....</b>	<b>36</b>



Ethernet .....	36
<i>Using IPv4</i> .....	37
<i>Using IPv6</i> .....	37
Wi-Fi.....	38
<i>Connecting to Wi-Fi Network</i> .....	38
<i>Wi-Fi Protected Setup (WPS)</i> .....	38
<i>Add Network</i> .....	40
<i>Wi-Fi Direct</i> .....	40
<i>Advanced Settings</i> .....	41
Wi-Fi Display .....	42
Bluetooth.....	43
<i>Pairing GVC3210 with a Bluetooth Device</i> .....	43
<i>Connecting to a Bluetooth Device</i> .....	43
<i>Using Bluetooth Remote Control</i> .....	44
<i>Transfer Files with Bluetooth</i> .....	45
<i>Using Bluetooth Headset</i> .....	45
VPN Settings.....	45
VLAN Settings.....	47
LLDP Settings .....	48
802.1X Mode.....	48
<b>CAMERA .....</b>	<b>49</b>
Preset.....	50
<i>Add Preset</i> .....	50
<i>Edit Preset</i> .....	50
<i>Delete Preset</i> .....	50
<i>Apply Preset</i> .....	51
<i>Initial Position</i> .....	51
Camera Parameters Configurations .....	51
<b>PERIPHERAL .....</b>	<b>53</b>



External USB Device .....	53
<i>Using USB Mouse/Keyboard</i> .....	53
<i>Using USB Storage Device</i> .....	53
Micro SD Card .....	53
Microphone and Speaker.....	54
<b>MAKING PHONE CALLS .....</b>	<b>55</b>
Account .....	55
Dial Screen .....	55
<i>Dialing a Number Directly</i> .....	56
<i>Redial</i> .....	56
<i>Dialing a Number via Contact</i> .....	56
<i>Dialing a Number via Call History</i> .....	57
<i>Direct IP Call</i> .....	57
<i>Paging/Intercom</i> .....	58
Answering a Call .....	58
Call Hold .....	59
Mute Local Audio .....	59
Call Recording .....	59
DND (Do Not Disturb) .....	60
Missed Call .....	60
Call Forward.....	60
Remote Camera Control in Call (FECC).....	60
<b>IPVIDEOTALK CONFERENCE .....</b>	<b>62</b>
Device Layout .....	62
Initiating Conference.....	62
Answering an Incoming Call in Conference.....	62
Conference Management .....	63
Invite Members to Conference.....	66
Conference Control.....	66



Pause Conference .....	67
Custom PIP .....	67
Presentation Sharing .....	68
Conference Recording .....	69
Call Details .....	70
Participants List.....	71
Open Dial Keyboard.....	71
End Conference .....	71
Power Off During a Conference Call .....	72
IPVideoTalk Application.....	72
<i>Contacts</i> .....	73
<i>Notices</i> .....	74
<i>Settings</i> .....	76
<i>Join an IPVideoTalk Meeting</i> .....	77
<i>Busy Tone Responses</i> .....	77
<i>Manually Start IPVideoTalk Tip</i> .....	78
<i>Hand Down/Up in IPVideoTalk Meeting</i> .....	78
<i>Stop Sharing Local Camera</i> .....	80
<i>Stop Video Upload Icon</i> .....	80
<i>Start Cloud Recording</i> .....	80
Schedule .....	81
<i>View Conference Details</i> .....	82
<i>Add Scheduled Conference</i> .....	83
<i>Edit Scheduled Conference</i> .....	84
<i>Reschedule Conference</i> .....	85
<i>Delete Scheduled Conference</i> .....	85
Voicemail.....	85
Call Features.....	86
<b>ADDITIONAL FUNCTIONS .....</b>	<b>89</b>
GVC Remote Client Application .....	89



BlueJeans .....	90
<b>APPLICATIONS.....</b>	<b>91</b>
Contacts .....	91
<i>Add Contact</i> .....	92
<i>Search Contacts</i> .....	95
<i>Manage Contacts</i> .....	95
<i>Groups</i> .....	96
LDAP contacts .....	98
<i>LDAP Settings</i> .....	98
<i>Search LDAP Contacts</i> .....	101
<i>Add Search Result into Local Contacts</i> .....	101
Call History .....	102
<i>Add Contact from Call History</i> .....	103
<i>Delete Call History</i> .....	104
<i>Conference Schedule via Call History</i> .....	104
File Manager .....	104
<i>Copy File</i> .....	105
<i>Send File</i> .....	105
<i>Delete File</i> .....	105
<i>Rename File</i> .....	106
Recording.....	106
<i>Recording Settings</i> .....	107
Setup Wizard .....	107
Backup .....	109
<i>Backup Data</i> .....	109
<i>Restore Backup Data</i> .....	112
<i>Set Backup Path</i> .....	112
Diagnosis .....	112
Browser .....	113
Sync Local Schedule with Google Calendar .....	113



Custom App on Home Screen .....	117
Uninstall Application.....	119
<b>GS MARKET.....</b>	<b>120</b>
Search Apps.....	120
Download and Install Apps .....	120
Update Apps .....	120
<b>GVC3210 WEB UI FEATURES.....</b>	<b>122</b>
Accessing GVC3210 Web GUI.....	122
Saving Changes.....	123
Definitions .....	123
Toolbar .....	124
Call Page .....	124
<i>Making a Call.....</i>	<i>125</i>
<i>Conference Control.....</i>	<i>126</i>
Contacts Page .....	127
<i>Contacts.....</i>	<i>127</i>
<i>Groups.....</i>	<i>128</i>
<i>Schedule.....</i>	<i>129</i>
<i>Call History.....</i>	<i>130</i>
<i>LDAP.....</i>	<i>130</i>
Device Control Page.....	131
<i>Video Control.....</i>	<i>131</i>
<i>Audio Control.....</i>	<i>132</i>
<b>FACTORY RESET .....</b>	<b>134</b>
Reset via LCD.....	134
Reset via Web UI.....	135
Reset via Reset Hole .....	135
<b>EXPERIENCING GVC3210 .....</b>	<b>136</b>



## Table of Tables

Table 1: GVC3210 Technical Specifications .....	19
Table 2: GVC3210 Package List .....	22
Table 3: GVC3210 Front Panel .....	23
Table 4: GVC3210 Back Panel .....	24
Table 5: GVC3210 Remote Control Keys .....	27
Table 6: GVC3210 LED Indicator Status Descriptions.....	31
Table 7: GVC3210 Status Icons Descriptions.....	32
Table 8: GVC3210 VPN File Parameters.....	47
Table 9: GVC3210 VLAN Configuration Parameters.....	47
Table 10: GVC3210 LLDP Configuration Parameters .....	48
Table 11: 802.1x Mode Parameters on GVC3210 .....	48
Table 12: GVC3210 Camera Parameters .....	52
Table 13: GVC3210 IPVT Call Screen Bottom Menu Icons.....	63
Table 14: GVC3210 Conference Member Status Descriptions.....	65
Table 15: GVC3210 Add Conference Parameters .....	84
Table 16: GVC3210 Feature Code for SIP Account.....	86
Table 17: GVC3210 Import Contacts Parameters .....	93
Table 18: GVC3210 Download Contacts Parameters.....	94
Table 19: GVC3210 Export Contacts Parameters .....	96
Table 20: GVC3210 LDAP Settings Parameters.....	98
Table 21: GVC3210 Web Access .....	123
Table 22: GVC3210 Web UI - Call Settings .....	125
Table 23: GVC3210 Web UI - Audio Control Parameters .....	132





## Table of Figures

Figure 1:GVC3210 Package Content .....	22
Figure 2:GVC3210 Front/Top/Bottom Panel .....	23
Figure 3: GVC3210 Right/Left Panel .....	24
Figure 4: GVC3210 Right/Left Panel Connection Diagram .....	26
Figure 5: Deploy GVC3210 with other Devices .....	26
Figure 6: GVC3210 Remote Control .....	27
Figure 7: GVC3210 Top Status Bar Dropdown Menu .....	32
Figure 8: Soft Keyboard - English Input Method .....	33
Figure 9: English Input Method – Capslock .....	34
Figure 10: Soft Keyboard - Symbols and Numbers .....	34
Figure 11: Soft Keyboard - More Symbols and Numbers .....	34
Figure 12: GVC3210 Home Screen .....	35
Figure 13: Ethernet Settings .....	36
Figure 14: GVC3210 Add Wi-Fi Screen .....	38
Figure 15: GVC3210 Push button WPS feature .....	39
Figure 16: GVC3210 PIN Entry WPS feature .....	39
Figure 17: GVC3210 Add network feature .....	40
Figure 18: GVC3210 Wi-Fi Direct feature .....	41
Figure 19: GVC3210 Wi-Fi Advanced Settings page .....	41
Figure 20: Wi-Fi Display feature .....	42
Figure 21: Select display screen .....	42
Figure 22: GVC3210 Bluetooth - Paired Device .....	44
Figure 23: GVC3210 Add VPN Files Screen .....	46
Figure 24: GVC3210 VPN Validation Screen .....	46
Figure 25: GVC3210 Camera Screen .....	49
Figure 26: GVC3210 Add Preset Screen .....	50
Figure 27: Initial Position .....	51
Figure 28: GVC3210 Camera Parameters Setting Screen .....	52
Figure 29: GVC3210 SIP Account .....	55
Figure 30: GVC3210 Call Screen .....	56
Figure 31: GVC3210 Single Incoming Call Screen .....	58
Figure 32: GVC3210 Single Incoming H.323 Call Screen .....	59
Figure 33: FECC – Remote Camera Control .....	61
Figure 34: GVC3210 3-Way IPVT Conference .....	63
Figure 35: GVC3210 Conference Control Screen .....	66
Figure 36: Select Video Feed .....	67



Figure 37: Layout Customization for multiple HDMI Outputs.....	67
Figure 38: Choose HDMI Output .....	68
Figure 39: GVC3210 3-Way Conference with Presentation .....	68
Figure 40: Web UI Conference Recording .....	69
Figure 41: GVC3210 Call Details Screen .....	70
Figure 42: GVC3210 Participants List.....	71
Figure 43: End Conference.....	72
Figure 44: Power Off During a Call .....	72
Figure 45: GVC3210 IPVideoTalk Application.....	73
Figure 46: IPVideoTalk Application → Enterprise Directory .....	73
Figure 47: IPVideoTalk Application → Enterprise Directory: Batch Call .....	74
Figure 48: IPVideoTalk Application→Notices.....	74
Figure 49: IPVideoTalk Application → Notices: Message Prompt .....	75
Figure 50: Message Indicator for IPVideoTalk Application.....	76
Figure 51: IPVideoTalk Account Settings .....	76
Figure 52: Busy Tone when the Callee is the Host of another Meeting .....	77
Figure 53: Busy Tone when the Callee is already a Meeting's Member .....	78
Figure 54: Manually Start Scheduled Meeting .....	78
Figure 55: Hand up - IPVideoTalk .....	79
Figure 56: Participants list.....	79
Figure 57: Hand down - IPVideoTalk .....	79
Figure 58: Hand down by Host - IPVideoTalk .....	79
Figure 59: Stop Camera Sharing .....	80
Figure 60: Stop Video Uploading .....	80
Figure 61 : Start Cloud Recording .....	81
Figure 62 : IPVideoTalk Recordings.....	81
Figure 63: GVC3210 Schedule Screen.....	82
Figure 64: GVC3210 Conference Details Screen.....	83
Figure 65: GVC3210 Add Conference Screen.....	83
Figure 66: GVC3210 Voice Mail Application .....	86
Figure 67: “GVC Remote” apk in GVC3210 LCD Menu → Settings → Status → Remote Control.....	89
Figure 68: GVC3210 Remote Control Application on Android Device .....	90
Figure 69: GVC3210 Contacts Screen .....	91
Figure 70: GVC3210 Add New Contact Screen.....	92
Figure 71: GVC3210 Import Contacts Screen .....	93
Figure 72: GVC3210 Download Contacts Screen .....	94
Figure 73: GVC3210 Export Contacts Screen.....	95
Figure 74: GVC3210 Groups Screen .....	96
Figure 75: GVC3210 Add Group Screen .....	97
Figure 76: LDAP Contacts Interface .....	98
Figure 77: LDAP Settings Example in Web UI.....	100
Figure 78: Search LDAP Contacts.....	101



Figure 79: Add LDAP Search Result to Local Contacts.....	101
Figure 80: Batch Add LDAP Search Results to Local Contacts.....	102
Figure 81: GVC3210 Call History Screen .....	102
Figure 82: GVC3210 Call History Details.....	103
Figure 83: GVC3210 Add Contact Screen.....	104
Figure 84: GVC3210 Recording Screen .....	106
Figure 85: GVC3210 Recording Settings.....	107
Figure 86: Applications→Setup Wizard .....	108
Figure 87: Interface Detection.....	109
Figure 88: GVC3210 Backup App.....	110
Figure 89: GVC3210 Automatic Backup Screen.....	111
Figure 90: Backup Commonly Used Apps .....	111
Figure 91: GVC3210 Restore Backup Data Screen .....	112
Figure 92: GVC3210 Diagnosis Screen.....	113
Figure 93: LCD Menu → Settings → System → Accounts .....	114
Figure 94: Enable Calendar Sync for the Google Account .....	114
Figure 95: GVC3210 Schedule → Settings .....	115
Figure 96: Enable Google Account for Schedule and Set Sync Interval .....	115
Figure 97: Creating New Event in Google Calendar.....	116
Figure 98: Google Calendar Event Synced in Schedule .....	116
Figure 99: Set “Related Account” to Google Account .....	117
Figure 100: System → Apps .....	118
Figure 101: Move App to SD card.....	118
Figure 102: Move App to Device Storage .....	119
Figure 103: GVC3210 GS Market.....	120
Figure 104: GVC3210 Web GUI - Login .....	122
Figure 105: GVC3210 Web UI Tool Bar.....	124
Figure 106: GVC3210 Web UI – Call.....	125
Figure 107: GVC3210 Web UI - Conference Status.....	126
Figure 108: GVC3210 Web UI - Conference Control.....	126
Figure 109: GVC3210 Web UI - Contacts.....	127
Figure 110: GVC3210 Web UI - Groups .....	128
Figure 111: GVC3210 Web Page - Schedule.....	129
Figure 112: GVC3210 Web UI - Call History.....	130
Figure 113: GVC3210 Web UI - Video Control .....	131
Figure 114: Factory Reset via LCD.....	134
Figure 115: GVC3210 Web UI - Factory Reset.....	135
Figure 116: GVC3210 Web UI - Factory Reset Confirmation .....	135



## DOCUMENT PURPOSE

This User Guide describes the basic concept and tasks necessary to use and configure your GVC3210. This document covers the topics of device installation, making basic conference calls and using basic call features.

To learn the advanced features and configurations, please visit <http://www.grandstream.com/support> to download the latest "GVC3210 Administration Guide".

This guide covers following topics:

- [Product Overview](#)
- [Installing GVC3210](#)
- [Getting to know GVC3210](#)
- [Connecting to Network and Devices](#)
- [Camera](#)
- [Peripheral](#)
- [Making Phone Calls](#)
- [IPVideoTalk Conference](#)
- [Additional Functions](#)
- [Applications](#)
- [GS Market](#)
- [GVC3210 Web UI Features](#)
- [Factory Reset](#)
- [Experiencing GVC3210](#)



## CHANGE LOG

This section documents significant changes from previous versions of the GVC3210 user manuals. Only major new features or major document updates are listed here. Minor updates for corrections or editing are not documented here.

### **Firmware Version 1.0.1.13**

- Added the option to check the Participants List on GVC3210 during an IPVideoTalk meeting. Users could check all participants in the current IPVideoTalk meeting. [Participants List]

### **Firmware Version 1.0.1.6**

- This is the initial version.



## WELCOME

Thank you for purchasing GrandstreamGVC3210 Android™Video Conferencing System. This document introduces the LCD settings, web UI settings and advanced configurations of GVC3210. To learn the basic configuration and how to use GVC3210, please visit <http://www.grandstream.com/support> to download the latest "GVC3210 User Guide".

GVC3210 is a ground-breaking solution that offers small-to-medium businesses a revolutionary video conferencing system with unprecedented flexibility and the power of support for multiple popular video conferencing protocols and platforms right out of the box. The SIP-basedGVC3210 supports Grandstream's robust IPVideoTalk cloud platform for plug and play video conferencing. Additionally,since it is based on Android™6.0.1, the GVC3210 offers full access to all video conferencing apps in the Google™ Play Store.

The GVC3210 eliminates the traditional barriers to video conferencing and sets a new bar for business-class video conferencingsolutions by offering industry-leading flexibility, interoperability, system compatibility, application richness and ease of use.



## PRODUCT OVERVIEW

Table 1: GVC3210 Technical Specifications

Specification	Description
<b>Protocols / Standards</b>	SIP RFC3261, BFCP, TIP, RTP/RTCP, HTTP/HTTPS, ARP, ICMP, DNS (A record, SRV, NAPTR), DHCP, PPPoE, SSH, TFTP, NTP, STUN, LLDP-MED, LDAP, TR-069, 802.1x, TLS, SRTP, TCP/IP/UDP, IPv6, H.323
<b>Camera</b>	1/2.3", 16 Megapixel CMOS, 4K (2160p) Output
<b>Lens</b>	90°field of view, ePTZ (3x digital zoom)
<b>Network Interface</b>	1× RJ45 10/ 100/ 1000 Mbps
<b>Wi-Fi</b>	Integrated dual-band 802.11 a/b/g/n/ac (2.4GHz & 5GHz)
<b>Bluetooth</b>	Integrated Bluetooth 4.0 + EDR
<b>Video Outputs</b>	2x HDMI 1.4 up to 4K (2160p) with CEC
<b>Video Input</b>	1x HDMI 1.4 with resolution up to 1080p
<b>MIC/Speaker</b>	Built-in 4x MIC array
<b>Remote Control</b>	Bluetooth and infrared remote control with multi-touch touchpad
<b>Auxiliary Ports</b>	2x USB 2.0, micro-SD, Reset
<b>Voice Codecs</b>	Support for G.711μ/a, G.722 (wide-band), iLBC, OPUS, G.722.1, G.722.1c, G729A/B, in-band and out-of-band DTMF (In audio, RFC2833, SIP INFO)
<b>Video Codecs</b>	HEVC(H.265) and H.264 BP/MP/HP, video resolution up to 4K (2160p), frame rate up to 30 fps, bitrate up to 16Mbps
<b>Video Resolutions</b>	4K (2160p@30fps) from 4096Kbps, 1080p@30fps from 1024Kbps, 720p@30fps from 512 Kbps, 4SIF/4CIF from 128 Kbps, SIF/CIF from 64 Kbps
<b>Content Resolutions (Screen Sharing)</b>	Input: VGA, SVGA, XGA, 1280×600, WXGA, WXGA, SXGA, 1440×900, XGA+, 720p, 1600×1200, 1080p(HDMI), up to 60fps Encoding: 800×600, 1024×768, 1280×1024, 1280×720, 1920×1080 Output: 720p, 1080p
<b>Dual-Stream</b>	BFCP, video resolution (up to 4K 2160p@30fps) + content resolution (up to 1080p@15fps)
<b>Audio Features</b>	AEC, ANS, AGC, Noise Shield, PLC, CNG/VAD
<b>Video Features</b>	FEC, dynamic display layout, picture-in-picture, picture-outside-picture, digital caption
<b>Telephony Features</b>	Hold, forward (unconditional/no-answer/busy), downloadable phone book (XML, LDAP), call waiting, call history, flexible dial plan, personalized music ringtones, server redundancy & fail-over
<b>Sample Applications</b>	Skype, Google Hangouts, Microsoft Lync, Web browser, Adobe Flash, Facebook, Twitter, YouTube, Google calendar, mobile phone data import/export via Bluetooth, etc. API/SDK available for advanced custom



	application development
<b>Applications Deployment</b>	Allow various Android operation system 6.0 compliant applications to be developed, downloaded and run in the embedded device with provisioning control
<b>QoS</b>	Layer 2 QoS (802.1Q, 802.1p) and Layer 3 (ToS, DiffServ, MPLS) QoS
<b>Security</b>	User and administrator level passwords, MD5 and MD5-session based authentication, 256-bit AES encrypted configuration file, TLS, 128/256-bit SRTP, HTTPS, 802.1x media access control
<b>Multi-language</b>	English, German, Italian, French, Spanish, Portuguese, Russian, Turkish, Polish, Chinese, Korean, Japanese, and more
<b>Upgrade/Provisioning</b>	Firmware upgrade via TFTP / HTTP / HTTPS or local HTTP upload, mass provisioning using TR-069 or AES encrypted XML configuration file
<b>Power &amp; Green Energy Efficiency</b>	Input: 100~240VAC 50/60hz; output: 12V/2A 24W
<b>Package Content</b>	GVC3210 video conference system, remote control, 4 AAA batteries, universal power supply, network cable (1.5 meters), 2 HDMI cables (1.5-meter and 5-meter), lens cleaning cloth, mounting kit, quick installation guide, GPL license
<b>Temperature and Humidity</b>	Operation: 0°C to 40°C, Storage: -10°C to 60°C, Humidity: 10% to 90% Non-condensing
<b>Compliance</b>	FCC: FCC Part 15B; FCC Part 15C; FCC Part 15E; UL 60950 (power adapter)  CE: EN 55032; EN 55024; EN 61000-3-2; EN 61000-3-3; EN 60950-1; EN 301 489-1/17; EN 300 328; EN 301 893; EN 62311; EN 62479; RoHS  RCM: AS/NZS CISPR 32/24; AS/NZS 60950.1; AS/NZS 4268;  ANATEL
<b>CE approval</b>	Output power: GVC3210: BT: 2.98dBm (BT 3.0), 6.05dBm (BT 4.0) 2.4G wifi: 16.58dBm (802.11 b), 17.23dBm (802.11 g), 16.84dBm (802.11 n20)  5G Wifi: 5150-5250 MHz: 802.11a: 17.66dBm; 802.11n-HT20: 17.19 dBm; 802.11n-HT40: 16.76dBm; 802.11ac20: 17.13dBm; 802.11ac40: 16.68 dBm; 802.11ac80: 16.58dBm; 5250-5350 MHz: 802.11a: 16.26dBm; 802.11n-HT20: 16.09 dBm; 802.11n-HT40: 16.22dBm; 802.11ac20: 16.01dBm; 802.11ac40: 16.31 dBm; 802.11ac80: 16.86dBm; 5470-5725 MHz: 802.11a: 16.18dBm; 802.11n-HT20: 15.77 dBm;





802.11n-HT40: 16.13dBm; 802.11ac20: 15.84dBm; 802.11ac40: 15.93 dBm;  
802.11ac80: 16.59dBm;  
GVC3210 RMT: 2.13dBm (BT)

## Safety Compliances

GVC3210 complies with FCC/CE and various safety standards. GVC3210 power adapter is compliant with the UL standard. Use the universal power adapter provided with GVC3210 package only. The manufacturer's warranty does not cover damages to the device caused by unsupported power adapters.

## Warranty

If GVC3210 is purchased from a reseller, please contact the company where the device is purchased for replacement, repair or refund. If the device is purchased directly from Grandstream, please contact Grandstream Support for a RMA (Return Materials Authorization) number before the product is returned. Grandstream reserves the right to remedy warranty policy without prior notification.



## INSTALLING GVC3210

### Equipment Package Content

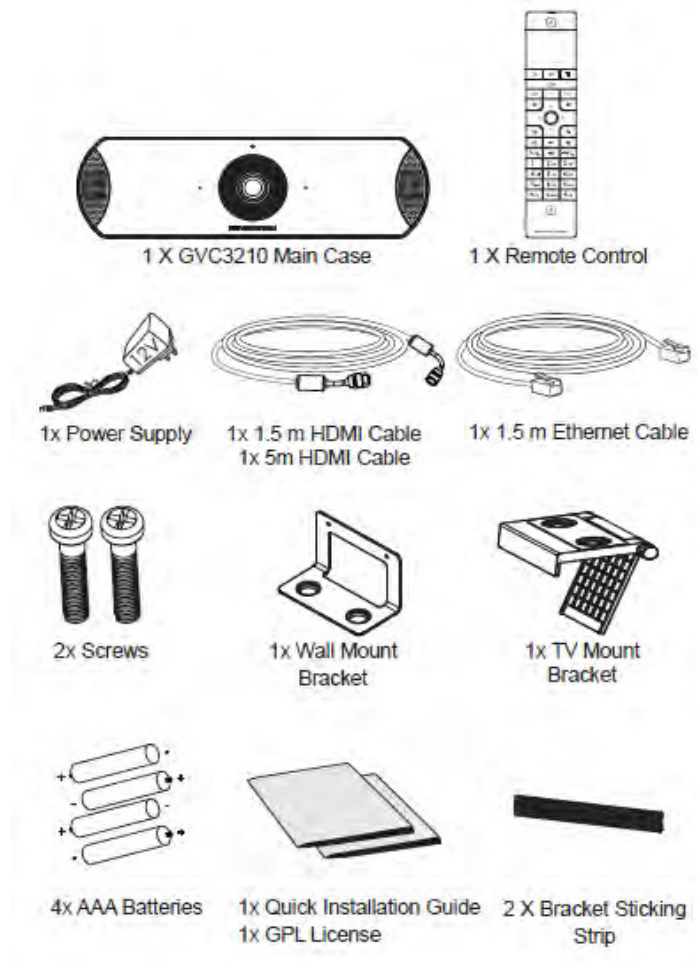

Figure 1: GVC3210 Package Content

Table 2: GVC3210 Package List

GVC3210	
1x GVC3210 Main Case	1x TV mount bracket (Plastic bracket)
1x Remote Control	2x screws
1x 12V Universal Power Supply	1x Lens Cleaning Cloth
1x 1.5m Ethernet Cable	1x Quick Installation Guide
1x 1.5m HDMI Cable	1x GPL license
1x 5m HDMI Cable	2x Bracket Sticking Strip
1x Wall mount bracket (Metal bracket)	4x AAA batteries



### Connecting GVC3210

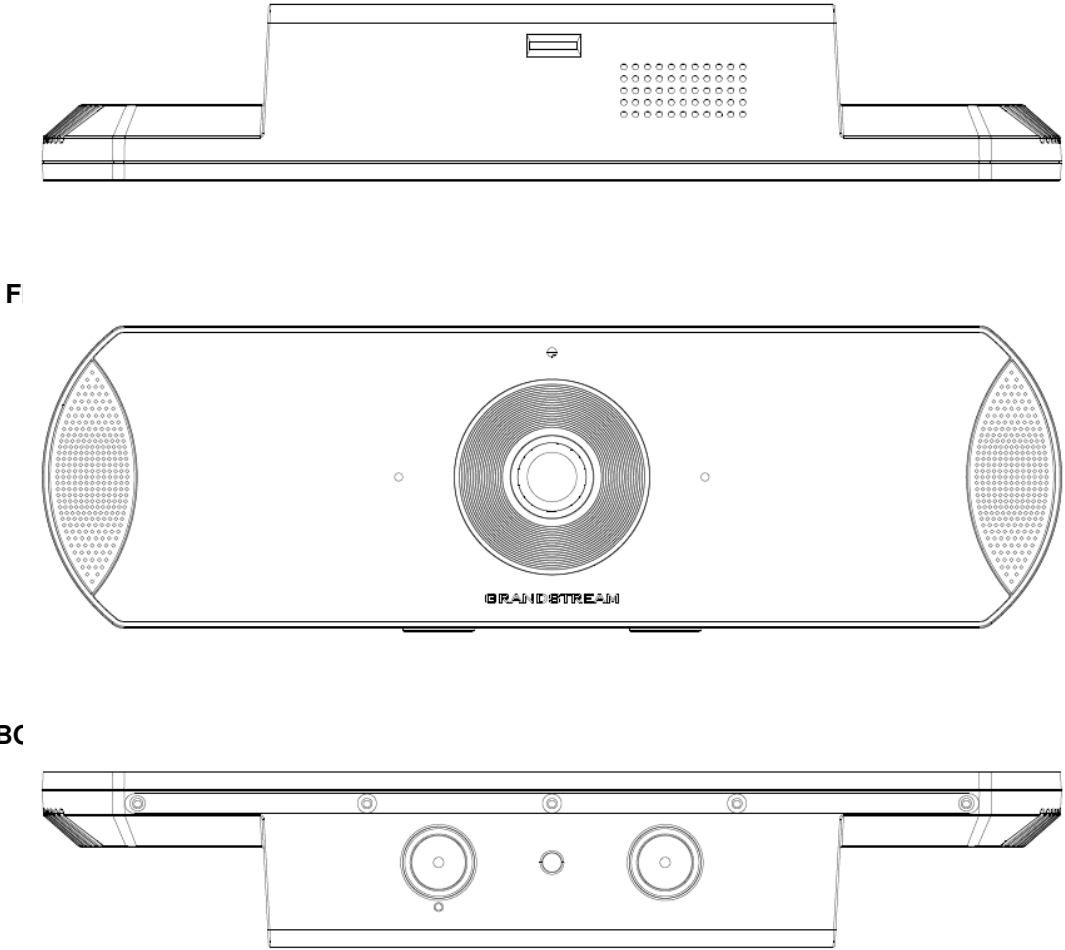

Figure 2: GVC3210 Front/Top/Bottom Panel

Table 3: GVC3210 Front Panel

NO.	Name	Description
1	<b>MicroSD Card Slot</b>	Insert microSD card to store call recordings and other necessary files.
2	<b>LED Indicator</b>	Power on / Normal Running: Green Standby: Flash red Shutdown: Red Pressing any key on the remote control - Green light flashes once.
3	<b>Camera</b>	1/2.3", 16 Megapixel CMOS, 4K (2160p) Output
4	<b>Factory Reset</b>	When GVC3210 is powered up, use a small pin to press the button one time to reboot or for more than 10 seconds to restore to factory settings.



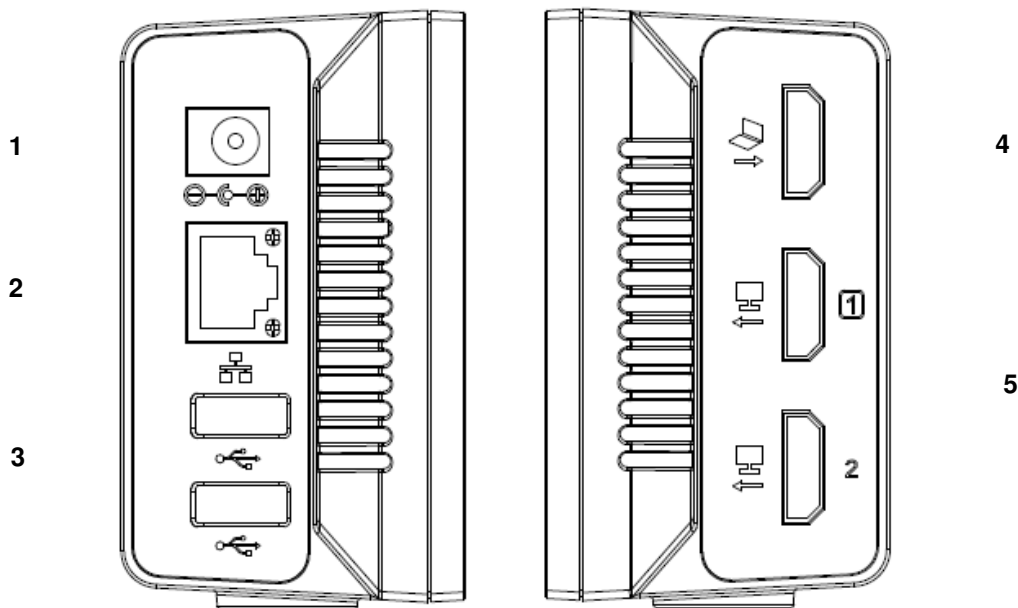

Figure 3: GVC3210Right/Left Panel

Table 4: GVC3210 Back Panel

NO.	Name	Description
1	<b>Power Interface</b>	Connect to power adapter. The arrow indicator on the power adapter should face upwards when the power adapter is plugged in.
2	<b>Network Interface</b>	Connect to LAN port.
3	<b>USB Interfaces</b>	Connect to USB cable or external speakerphone.
4	<b>HDMI Input Interface</b>	Connect to HDMI input devices.
5	<b>HDMI Output Interface</b>	<p>Connect to HDMI display devices.</p> <p><b>Note:</b>            There are 2 HDMI output ports. The interface marked with number "1" is the primary interface to output primary video. Please make sure to follow the port order when connecting HDMI port 1 and 2. When there is only 1 HDMI output, it has to use HDMI output 1 and then HDMI port 2 if you have additional display devices. GVC3210 will not work correctly if connecting HDMI port 2 without HDMI port 1 connected.</p>

Please connect GVC3210 according to the following procedures:

1. Connect the LAN port of the GVC3210 to the RJ-45 socket of a hub/switch or a router (LAN side of the router) using the Ethernet cable.



**Note:** The GVC3210 supports Wi-Fi as well. It can be used to connect the GVC3210 to the network.

2. Connect the HDMI [1] port of the GVC3210 to the HDMI port of the main display device (e.g., TV) using the HDMI cable. Connect HDMI port 2 if you have additional display devices.

**Note:** Please make sure to follow the port order when connecting HDMI port 1 and 2. The GVC3210 will not work correctly if connecting HDMI port 2 without HDMI port 1 connected.

3. Connect the 12V DC output plug to the power jack on the GVC3210 and then plug the power adapter into an electrical outlet.
4. The LED Indicator in the front of the GVC3210 will show if the device is ready to be used by changing the color from red to green.

**Note:** The display device (e.g., TV) will show the idle HOME screen with IP address on the top status bar as well.

5. Insert your microSD card into the microSD card slot. The recording files will be saved in Micro SD card.
6. (Optional) Connect presentation device (e.g., a laptop) to the GVC3210 HDMI IN port for presentation purpose during conference call.
7. (Optional) Connect USB accessory (e.g., mouse, keyboard, USB flash drive, ... etc) to the USB port.



**Note:**

For detailed instructions about installing GVC3210 on wall mount and TV/Monitor mount etc., please refer to the GVC3210 quick installation guide on [www.grandstream.com](http://www.grandstream.com).

---

A sample of GVC3210 Right/Left panel connection is shown below:



Connect with the network cable



Connect with HDMI Cable

Connect with USB extension

Connect with HDMI cable

**Figure 4: GVC3210Right/Left Panel Connection Diagram**

The following figure shows multiple GVC3210 devices deployed with other VoIP/network devices for video conference and collaboration.

GVC3210

GVC3210

**Figure 5: Deploy GVC3210 with other Devices**



## GETTING TO KNOW GVC3210

### Remote Control

#### Remote Control Keys and Touchpad

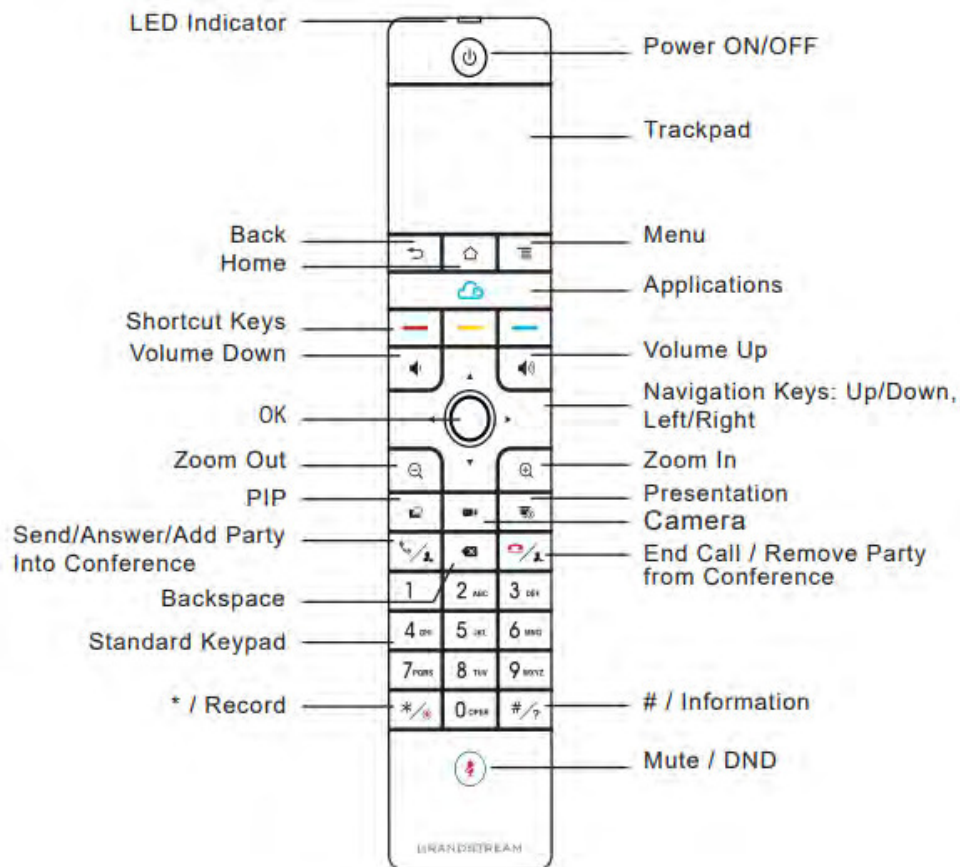











Figure 6: GVC3210 Remote Control

Table 5: GVC3210 Remote Control Keys













Key	Name	Description
1, 2, 3, 4...9	Digital Keys	Input number 1-9 and letters.  The letter input using digital keys will not be displayed as letter, but it can be used to search for contacts in Call interface. For example, typing 5 (JKL), 6 (MNO), 4 (GHI), 6 (MNO) can look for John if it exists in GVC3210 contacts list.



	<b>Camera</b>	Switch to EPTZ control mode during a call or in idle status.
	<b>PIP</b>	Switch screen layout in conference.
	<b>Mute/DND</b>	<ul style="list-style-type: none"> <li>• Mute GVC3210 in conference.</li> <li>• Press the MUTE key to enable/disable DND mode when GVC3210 is in idle.</li> </ul>
	<b>Presentation</b>	<ul style="list-style-type: none"> <li>• Enable/Disable presentation function to send presentation to all members in the conference.</li> <li>• Enable/Disable presentation function to show presentation on displayed device which is connected to HDMI output 1 as projection when GVC3210 is in standby mode.</li> </ul>
	<b>Send/Answer/Add Party into Conference</b>	<ul style="list-style-type: none"> <li>• Access the dial screen by default when GVC3210 is in idle mode.</li> <li>• Enter phone number and press the key to dial out.</li> <li>• Access the invite screen to add members in a conference.</li> <li>• Press the key to bring out the backstage conference.</li> <li>• Press the key to redial the last outgoing call.</li> </ul>
	<b>End Call/Remove Party from Conference</b>	<ul style="list-style-type: none"> <li>• Delete members in conference.</li> <li>• Hang up the conference.</li> </ul>
	<b>Backspace</b>	Press the key to delete input characters.
	<b>NavigationKeys: Up/Down/Left/Right</b>	<ul style="list-style-type: none"> <li>• Press to adjust cursor movement.</li> <li>• Control EPTZ movement in camera mode.</li> </ul>
	<b>OK</b>	<ul style="list-style-type: none"> <li>• Press to confirm operations.</li> <li>• Bring up the soft keypad when the cursor is in an input box.</li> </ul>
	<b>Power On/Off</b>	<p>LCD prompt shows following three options after pressing this key:</p> <ul style="list-style-type: none"> <li>• Switch GVC3210 into sleep mode.</li> <li>• Power Off</li> </ul>





		<ul style="list-style-type: none"> <li>• Reboot</li> </ul>
	<b>*/Record</b>	<ul style="list-style-type: none"> <li>• Input * in input field.</li> <li>• Used as "." when dialing direct IP call. For example, 192.168.40.5.</li> <li>• Start/stop recording in camera control mode.</li> <li>• Start/stop recording in a call.</li> </ul>
	<b>#/Details</b>	<ul style="list-style-type: none"> <li>• Input "#" in input field.</li> <li>• Used as ":" when dialing direct IP Call e.g., 192.168.40.5:5060.</li> <li>• Input "#" on dialing screen to use it as REDIAL key.</li> <li>• Display call details on call screen during a call.</li> </ul>
	<b>Shortcut Key: Red</b>	
	<b>Shortcut Key: Yellow</b>	Press each shortcut key for designated functions on different screen context.
	<b>Shortcut Key: Blue</b>	
	<b>Home</b>	Press the key to go back to home screen.
	<b>Menu</b>	Press the key to view more options.
	<b>Back</b>	Press the key to go back to the previous screen or exit the current screen.
	<b>Volume Down</b>	Turn down the device volume.
	<b>Volume Up</b>	Turn up the device volume.
	<b>Zoom In</b>	Zoom in screen or adjust close focus.
	<b>Zoom Out</b>	Zoom out screen or adjust distant focus.
	<b>Trackpad</b>	<ul style="list-style-type: none"> <li>• Slide on the trackpad to move the mouse cursor.</li> <li>• Press the trackpad to confirm operations.</li> <li>• Using two fingers to press on the trackpad and slide up/down for page up/down.</li> </ul>



## Using the Remote Control

GVC3210 remote control is connected to GVC3210 via Bluetooth or infrared connection, and it automatically uses infrared connection when the user receives GVC3210 package, then he may connect it to GVC3210 via Bluetooth.

Before using the remote control, please make sure that 4x AAA batteries are correctly installed on the back of the remote control.

### 1. Infrared connection:

Infrared signals are automatically used to connect the remote control to GVC3210. Users need to keep the two devices in front of each other without any substantial obstruction in between. The LED on the remote control is green when using infrared connection mode.

### 2. Bluetooth Connection

If the remote control is not paired with the GVC3210 anymore (e.g., a factory reset is made), press OK button and number 5 button at the same time for about 4 seconds. This will initiate pairing process on the remote control.



**Note:** The remote control needs to be placed within the Bluetooth effective range, i.e., 10m from GVC3210.

If the remote control fails to connect to GVC3210, please follow the steps below to troubleshoot:

- Check the battery polarity when placed into the battery case. Make sure the batteries are placed in the correct direction in the remote control.
- Check the battery power.
- Long pressing "OK" button and number "5" button at the same time for about 4 seconds.

If GVC3210 remote control still does not work with the diagnosis above, please try another remote control or contact the device provider.

## Capturing Screenshot using the Remote Control

To capture a screenshot on GVC3210, the users can press the red shortcut key  and blue shortcutkey  at the same time for about 3 seconds. The screenshot picture will be saved in the internal storage of GVC3210. The users can access the screenshot in GVC3210 LCD menu → **Applications** → **FileManager** → **InternalStorage** → **Pictures** → **Screenshot**.

Please note that the screenshot captured here does not have the image captured from the camera in the background. If you would like the image captured from camera, you can press the CAMERA button on the remote control and then press the blue shortcut key.



## Using Mouse & Keyboard

When the USB mouse is plugged into GVC3210, users could make the following operations with the mouse.

- Single click the left key of the USB mouse to perform the following operations:
  - Access menu.
  - Check in the checkbox or enable/disable an option.
  - Bring up the drop-down list when clicking on a combo box.
  - Switch input methods in the input box, tap on the corresponding buttons on the soft keyboard to input characters.
- Double left clicks  on the soft keyboard can switch to "Always use upper case" in English input method.
- Single click the right key of the USB mouse to exit the current displayed menu. It will go back to the previous menu without saving the configurations.

## Using the LED Indicator

GVC3210 LED indicator is located right above the camera lens. It can be used to notify the users with current status of the device. Please refer to the status description below.

**Table 6: GVC3210 LED Indicator Status Descriptions**

LED Indicator Status	Descriptions
<b>Solid Green</b>	Booting or the device is already booted up
<b>Flash Green (per 0.5s)</b>	Pressing any button on the remote control
<b>Flash Red (per 1s)</b>	<ul style="list-style-type: none"> <li>● Rebooting</li> <li>● Upgrading</li> <li>● Factory Reset</li> </ul>
<b>Flash Red (per 0.2s)</b>	<ul style="list-style-type: none"> <li>● Temperature &gt; 80 degree</li> <li>● Camera connection failed</li> </ul>
<b>Flash Red (per 2s)</b>	Sleep mode
<b>Solid Blue</b>	<ul style="list-style-type: none"> <li>● Recording</li> <li>● The device is in a call</li> </ul>
<b>Flash Blue (per 0.5s)</b>	Pairing the remote control
<b>Blue/Red Alternately</b>	Aging test
<b>OFF</b>	Power off



## Status Icons

GVC3210 status icons are displayed on the right side of top status bar on GVC3210 LCD display device. The users can view the top status bar notification details in drop-down panel by long-pressing the MENU key on the GVC remote control or pressing DOWN button when the GVC3210 is in home screen.

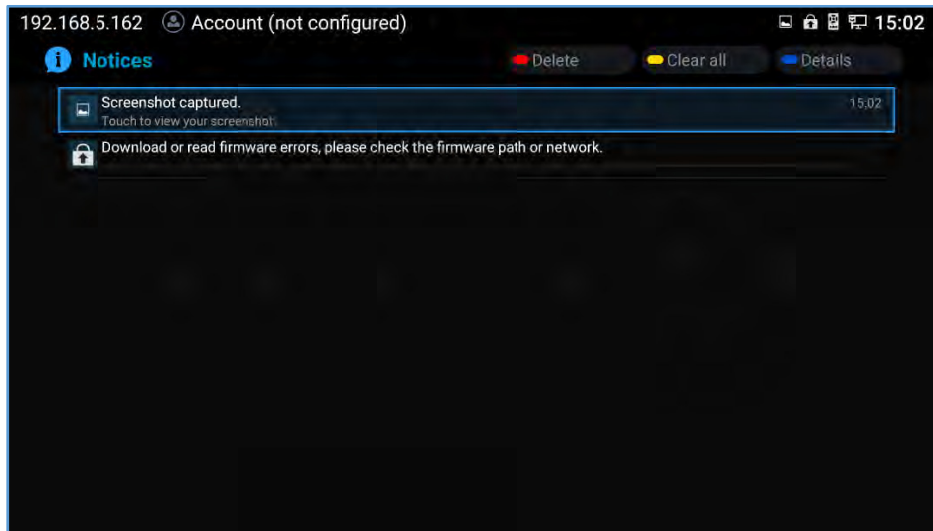

















Figure 7: GVC3210Top Status Bar Dropdown Menu



















For some notifications such as Voice Mail, the users can use the GVC remote control trackpad to select it. It will navigate the users to the corresponding app.

The following table lists the main status icons used on GVC3210.

Table 7: GVC3210Status Icons Descriptions

Icon	Descriptions	Icon	Descriptions	Icon	Descriptions
	Missed Call		Ongoing call		Auto answer is enabled
	Ethernet is connected		Ethernet is disconnected		Trying to connect to the Ethernet
	PPPoE is connected		PPPoE connection is failed		PPPoE is disconnected
	VLAN is successfully configured		VLAN is being configured		Unread voicemail
	VPN is connected		VPN connection is failed		Using thirdparty applications for mixing calls



	Bluetooth is connected		DND mode is enabled		Download or read firmware errors
	Remote control Low battery		Remote control is connected and paired		Remotecontrol is not connected and paired
	Micro SD Card is inserted		USB flash drive is inserted		Speaker is being used
	Call recording storage is full		Contacts storage is full		Micro SD card storage is full
	Wi-Fi is connected.		Wi-Fi is disconnected		Volume is turned to silent
	Call forward is set up	 Wi-Fi signal strength			Unknown Wi-Fi
	Wi-Fi-Display is opened				

## Using the Onscreen Keyboard

### English Keyboard

This is the default keyboard on GVC3210. The English keyboard supports multiple languages input methods. Users could tap on  to switch among different languages. See figure below.

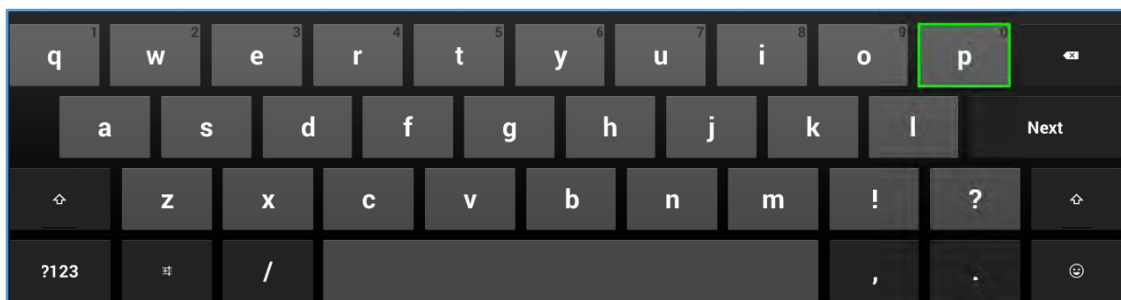

Figure 8: Soft Keyboard - English Input Method

Tap on  to switch Caps Lock:





Figure 9: English Input Method – Capslock

## Numbers and Symbols

To input numbers and symbols, tap on button **?123** on the default keyboard to switch to numbers/symbols. Tap on **~\|** for more numbers/symbols.



Figure 10: Soft Keyboard - Symbols and Numbers

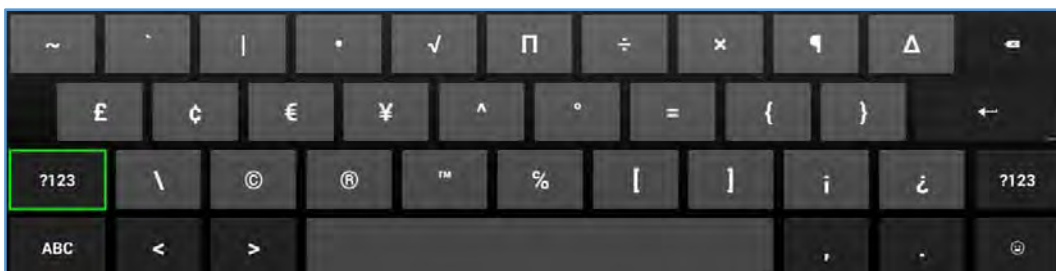

Figure 11: Soft Keyboard - More Symbols and Numbers

## Home Screen

GVC3210 Home screen displays the icons for users to easily access applications, camera, schedule, call, contacts, settings and custom applications. Press the Left/Right keys on the GVC3210 remote control to navigate.

If there is no activity on main screen, the icons will be hidden and the video local loopback is displayed. Press OK button on the GVC3210 remote control to bring up the icons to display again.





Figure 12: GVC3210 Home Screen

## Screen Lock

The GVC3210 supports screen lock. When it's enabled and configured, the user will be required to enter the lock code to unlock on the home screen.

To use this feature:

1. On GVC3210 LCD menu→**Settings**→**System**→**Security**, select Screen Lock and set Screen Lock code.
2. Reboot, enter sleep mode or power off the GVC3210.
3. When the GVC3210 boots up again, a screen lock code will be required. The user can unlock the screen by entering the code using the GVC remote control.





## CONNECTING TO NETWORK AND DEVICES

GVC3210 supports a variety of network connections (Ethernet, Wi-Fi) and device connections, including USB, Micro SD card and Bluetooth devices. When the GVC3210 boots up for the first time, a setup wizard will guide the users to pair and connect the remote control to GVC3210 and get started with the basic configurations.

### Ethernet

If the user would like to use Ethernet connection for network access, please plug the Ethernet cable into the LAN port on the back of GVC3210. Ethernet connection is turned on as DHCP by default on both IPv4 and IPv6 protocols.

To configure Ethernet settings on GVC3210, go to LCD menu → **Settings** → **Network** → **Ethernet**.

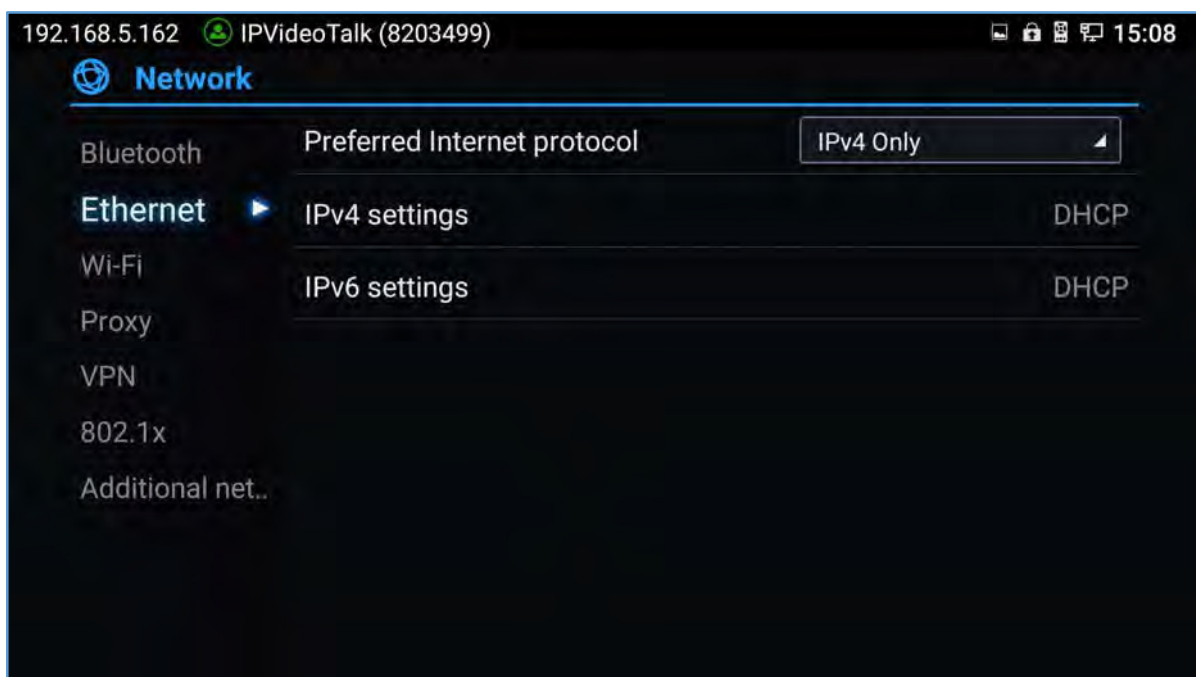

Figure 13: Ethernet Settings

The GVC3210 offers the possibility to prioritize a protocol over another by setting Preferred Internet protocol to “IPv4”, “IPv6”, “Both, prefer IPv4” or “Both, prefer IPv6”.





## Using IPv4

To configure the GVC3210 using IPv4 protocol, follow the below steps:

1. Plug the Ethernet cable into the LAN port on the back of GVC3210.
2. Go to LCD menu→**Settings**→**Network**→**Ethernet**→**IPv4 Settings**.
3. Tap on "Address Type" to select DHCP, Static IP or PPPoE as the address type.
  - For DHCP, save the setting and GVC3210 should be able to get IP address from the DHCP server in the network.
  - For static IP, enter IP Address, Subnet Mask, Default router, DNS Server 1 and DNS server 2 for GVC3210 to correctly connect to the network.
  - For PPPoE, enter PPPoE account ID and password so that GVC3210 can get IP address from the PPPoE server.

## Using IPv6

To configure the GVC3210 using IPv6 protocol, follow the below steps:

1. Plug the Ethernet cable into the LAN port on the back of the GVC3210
2. Go to LCD menu→**Settings**→**Network**→**Ethernet**→**IPv6 Settings**.
3. Tap "Address Type" to select DHCP or Static IP as the address type.
  - For DHCP, save the setting and GVC3210 should be able to get IP address from the DHCP server in the network.
  - For static IP, configure IPv6 address, DNS server 1, DNS server 2 and Preferred DNS server, enter the IPv6 address in the format of 2001:db8:1:2::3.

### Note:

The same steps are applied in the case of using "Both, prefer IPv4" and "Both, prefer IPv6" and the user needs to configure the options of both protocols IPv4 and IPv6.



## Wi-Fi

### Connecting to Wi-Fi Network

On the LCD display, go to **Settings**→**Network**→**Wi-Fi** to turn on and configure Wi-Fi.



Figure 14: GVC3210 Add Wi-Fi Screen

Once Wi-Fi is turned on, GVC3210 will automatically start the scanning within the range. A list of Wi-Fi networks will be displayed as scanning result. Tap on the SSID and enter the correct password information to connect to the selected Wi-Fi network.

Follow the steps below for static IP usage under Wi-Fi environment:

1. Tap on one Wi-Fi network in the scanned Wi-Fi list to bring up the dialog that shows signal strength, security, password and option "Show advanced options".
2. Select "Show advanced options". The dialog will show additional option "IP settings".
3. In "IP settings", select Static IP, enter IP Address, Subnet Mask, and Defaultrouter for GVC3210 to correctly connect to the network.

### Wi-Fi Protected Setup (WPS)

In order to connect the GVC3210 to a secure Wireless Network without selecting the network name and entering the password, WPS can be used in two ways to perform this feature:



- **Push button WPS**

On the Wi-Fi page, press the MENU key  on the remote control, and select "Push button WPS". Then, look on your Wi-Fi Router to see if it has a WPS button. Once the WPS button is found, press it to establish the connection with the GVC3210.

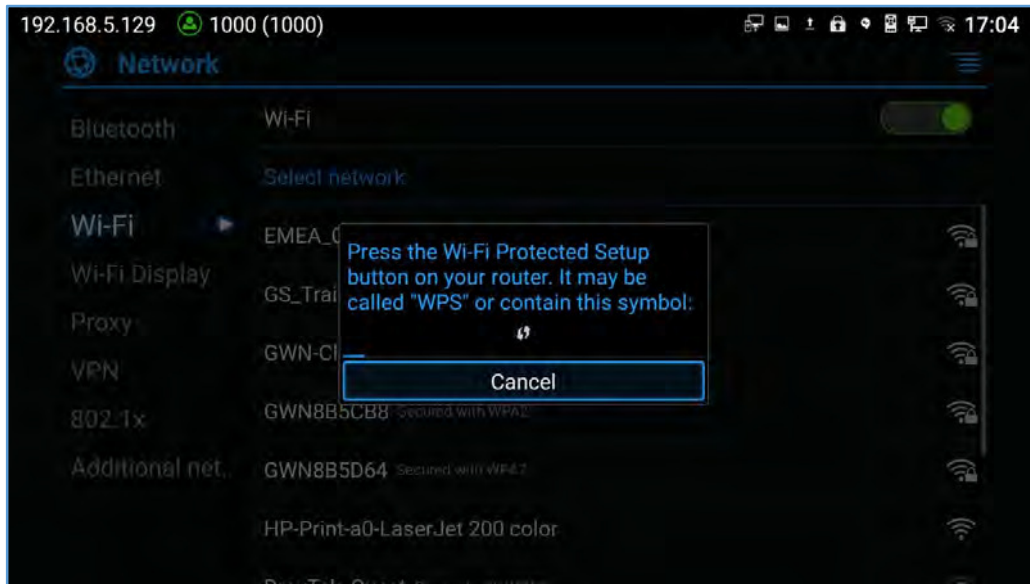



Figure 15: GVC3210 Push button WPS feature

- **PIN Entry WPS**

On the **Wi-Fi** page, press the MENU key  on the remote control, and select "PIN Entry WPS". A PIN code will be generated by GVC3210 and the user will need to enter it and register it in the "Wi-Fi Protected Setup" page of the Wi-Fi Router.

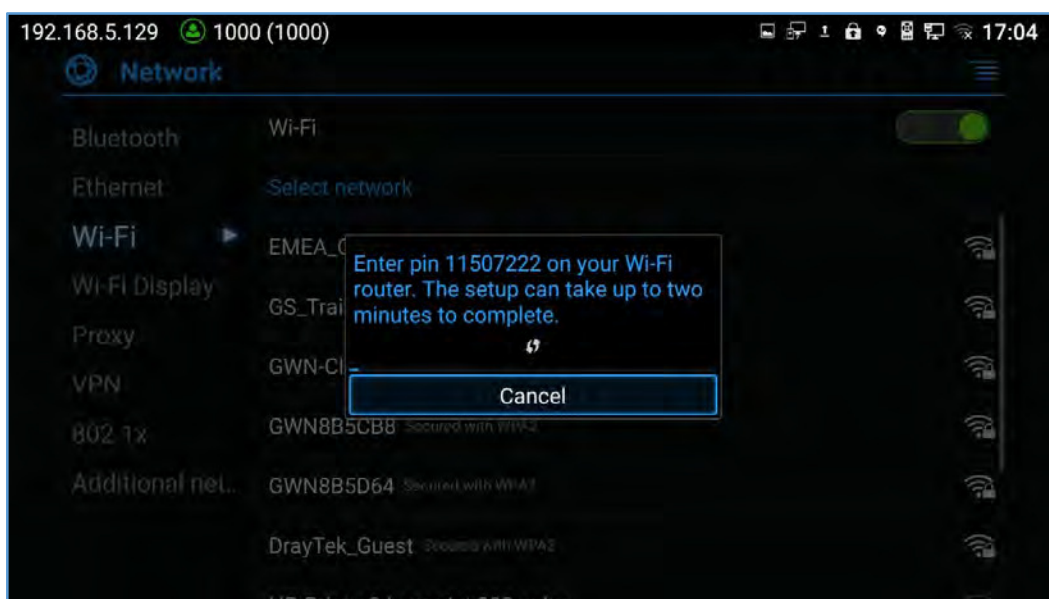

Figure 16: GVC3210 PIN Entry WPS feature



## Add Network

The user can automatically connect the GVC3210 to the network using Wi-Fi by adding the network on your GVC3210. To do so, Please, refer to the following steps:

1. Go to the Wi-Fi page and press the MENU key  $\equiv$  on the remote control, then select "Add Network"
2. Enter the Network SSID.
3. Tap the security type that your network is using (None, WEP, WPA/WPA2 PSK, 802.1x EAP)
4. Enter the Password.
5. Click on "Save".

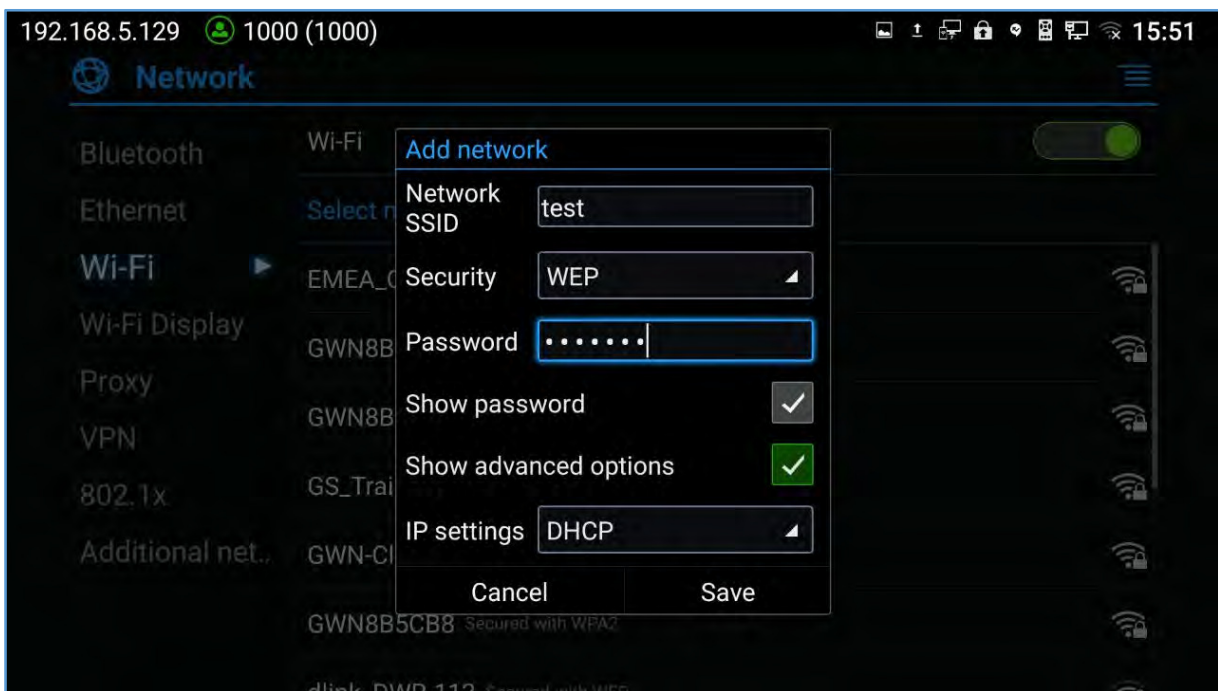

Figure 17: GVC3210 Add network feature

## Wi-Fi Direct

The Wi-Fi Direct feature gives the ability to the user to connect the GVC3210 with another device supporting Wi-Fi direct as well with no requirement of the Wi-Fi Router, and it is generally used for "file transfer" between the two devices. At the same time, Wi-Fi Direct only works in 2.4G Wi-Fi mode.





Figure 18: GVC3210 Wi-Fi Direct feature

**Advanced Settings**

On the **Wi-Fi** page, press the MENU key  on the remote control, and select "Advanced Settings". In this page, the user can enable/disable "Network Notifications" and to set the "Wi-Fi frequency band" to Auto, 5GHz only or 2.4 GHz only.

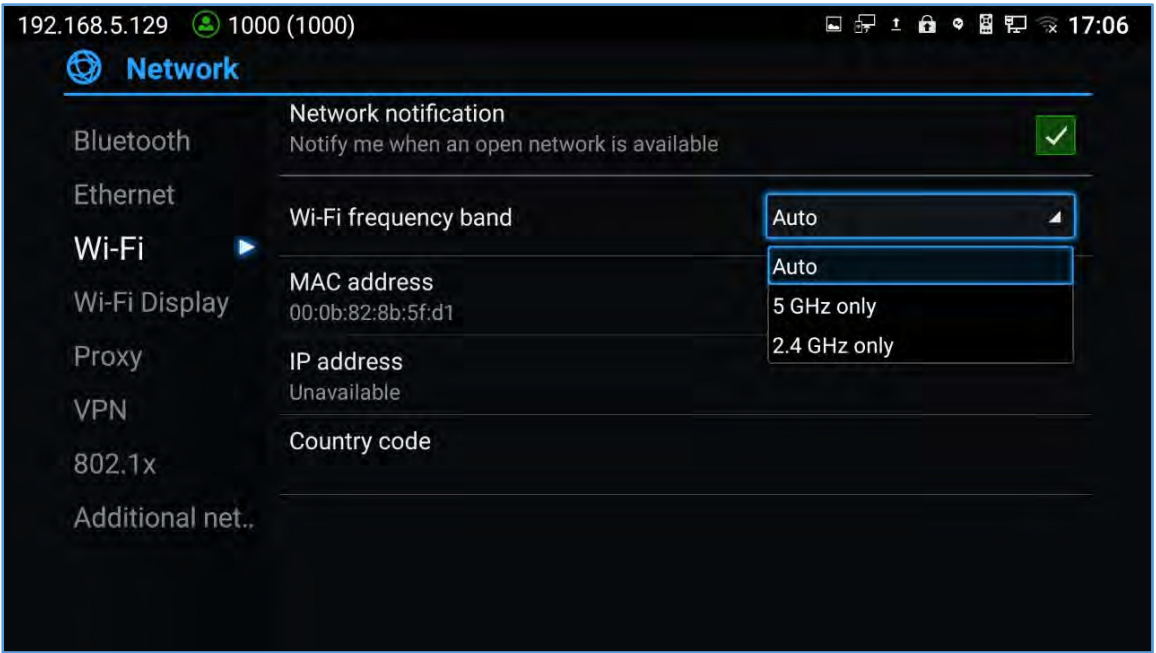

Figure 19: GVC3210 Wi-Fi Advanced Settings page



## Wi-Fi Display

Wi-Fi Display feature is used for screen stream mirroring of other devices in the GVC3210 via Wi-Fi. Please refer to the following steps to display your device's screen on the GVC3210 screen:

1. On the LCD display, go to **Settings**→**Network**→**Wi-Fi** to turn on Wi-Fi.
2. Go to **Settings**→**Network**→**Wi-Fi Display** and enable Wi-Fi Display.



Figure 20: Wi-Fi Display feature

3. On the device you want to cast its screen, go to “Screen mirroring” feature page and enable Wireless display.
4. The phone will show the GVC3210 in the devices list. Select the GVC3210.
5. On the GVC3210, select the display screen and the screen mirroring will start immediately.

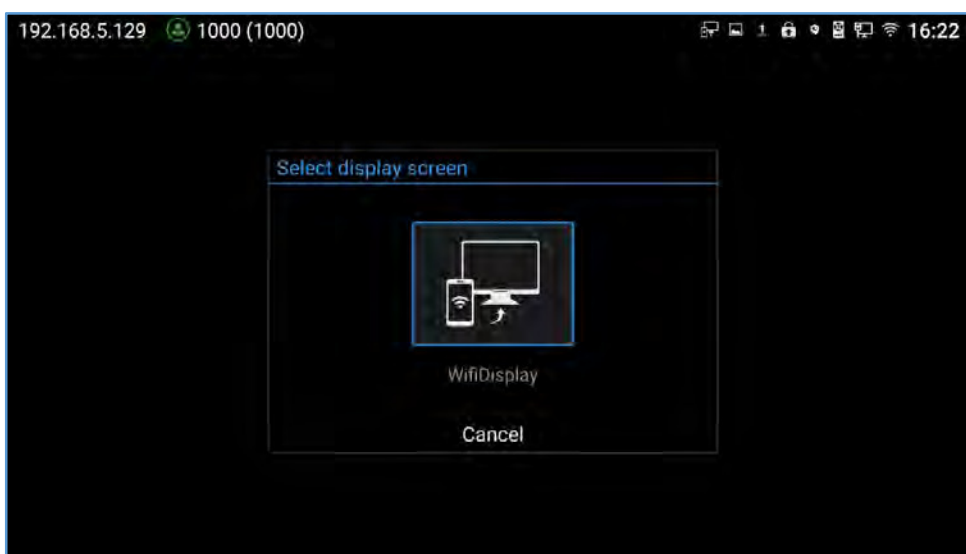

Figure 21: Select display screen





## Bluetooth

On GVC3210, Bluetooth is enabled by default. Users could connect Bluetooth by remote control, send or receive files to cellphone, or use Bluetooth speaker and etc on GVC3210.

### Pairing GVC3210 with a Bluetooth Device

Before connecting GVC3210 with other Bluetooth device, users must pair them first. They will stay paired afterwards unless they are manually unpaired. To pair Bluetooth device:

1. On the LCD display device, go to **Settings**→**Network**→**Bluetooth**.
2. Press  button on the remote control and select "Search for devices".
3. GVC3210 scans and displays the IDs of all available Bluetooth devices in range. Once the Bluetooth device shows up in the result, tap on it to start pairing.
4. Confirm the passkey in the prompted message (if any). Or, if passcode is required, please refer to the device's documentation or contact with the device administrator to obtain the passcode.



#### Note:

The external speaker provided with GVC3210 is not pre-paired to GVC3210. If the user would like to use external speaker via Bluetooth connection with GVC3210, the user must pair and connect it to GVC3210 manually before using it for audio output.

---

### Connecting to a Bluetooth Device

After pairing successfully, the device will be connected to GVC3210 immediately. Users will see this device

listed under "Paired Devices". Tap on  next to the connected device. Users will see options "Rename", "Unpair" and etc.



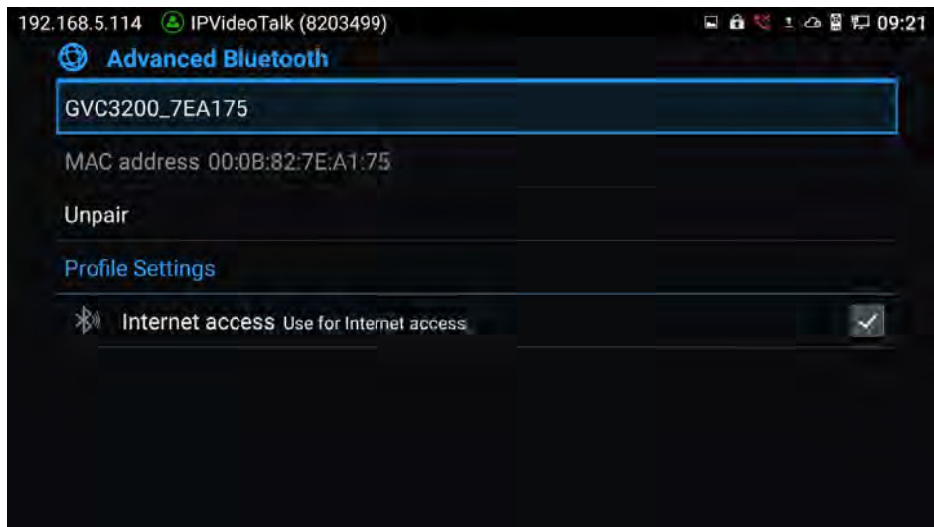



Figure 22: GVC3210 Bluetooth - Paired Device

If the connection is lost between the Bluetooth device and GVC3210, go to LCD menu→**Settings**→**Network**→**Bluetooth** and click on the device name under “Paired devices” again to reconnect.

### Using Bluetooth Remote Control

Users could use GVC3210 Bluetooth remote control that comes with the GVC3210 packaging to control and configure a GVC3210. When the GVC3210 boots up for the first time, a setup wizard will guide the users to pair and connect the remote control to the GVC3210.

When the remote control is connected to GVC3210, users will see  icon on the top status bar of the LCD display device.

If the remote control is not paired with the GVC3210 anymore (e.g., a factory reset is made), press OK button and number 5 button at the same time for about 4 seconds. This will initiate pairing process on the remote control.

**Note:** The remote control needs to be placed within the Bluetooth effective range, i.e., 10m from GVC3210.

If the user needs to pair a different remote control to GVC3210, please follow the methods below:

Connect a second remote control to GVC3210 and both remote controls can be used at the same time.

1. When remote control A is paired and connected to GVC3210, press OK + 5 keys at the same time for about 5 seconds on remote control B to trigger pairing process.
2. Now both remote controls can be used with GVC3210.
3. (Optional) If you wish to use only one remote control, Long press OK+0 keys at the same time for about 5 seconds to trigger unpair process on the remote control. Or you can try this, use the





desired remote control to go to GVC3210 LCD Settings → Network → Bluetooth, Tap on  next to the other connected remote, then click on "Unpair" to disconnect and unpair it from the GVC3210.

---



**Note:** Please use the proprietary factory remote control that comes with the GVC3210 packaging.

---

### Transfer Files with Bluetooth

Users could transfer files, share contacts information with other Bluetooth portable devices after pairing and connection. A prompt for file transferring will be displayed on GVC3210 LCD display device when it receives the file transferring request. Accept the request to receive the file and it will be stored under LCD → **Applications** → **FileManager** → **InternalStorage** → **Bluetooth** folder.

### Using Bluetooth Headset

Once the Bluetooth headset is connected with GVC3210, it will automatically use Bluetooth headset for calls. By default, the ringing tone will be generated in Bluetooth headset when there is an incoming call.

### VPN Settings

Users can add VPN using different protocols (PPTP, L2TP/IPSec PSK, L2TP/IPSec RSA, IPSec Xauth PSK, IPSec Xauth RSA and IPSec Hybrid RSA). Follow the steps below to set up VPN:

1. Access GVC3210 home screen, go to **Applications** → **Settings** → **Network** → **VPN**.
2. Tap on "Add VPN file" to access configuration page as shown below:



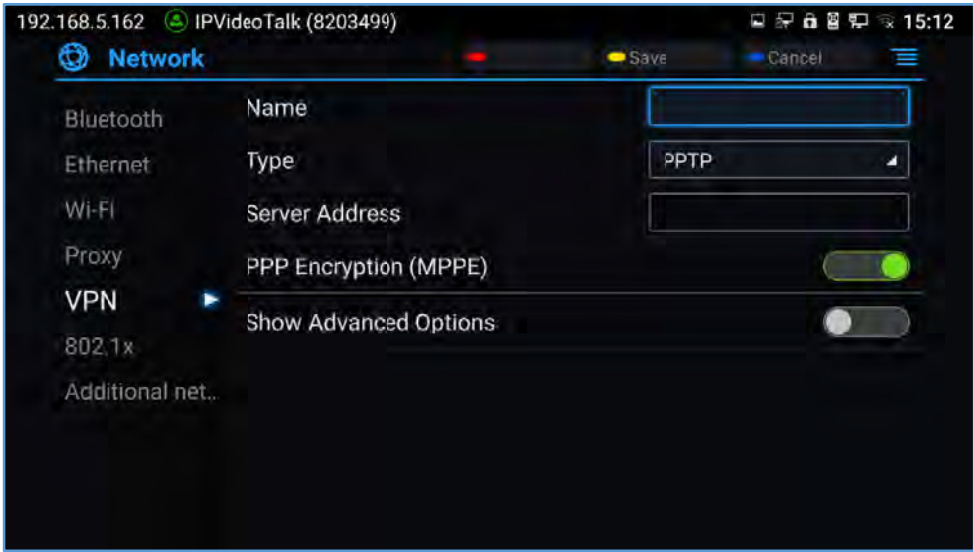

Figure 23: GVC3210 Add VPN Files Screen

3. Fill in and save the configurations, go back to VPN page, you will find the new VPN file you just added.
4. Tap on the VPN file to open the validation page as shown below:

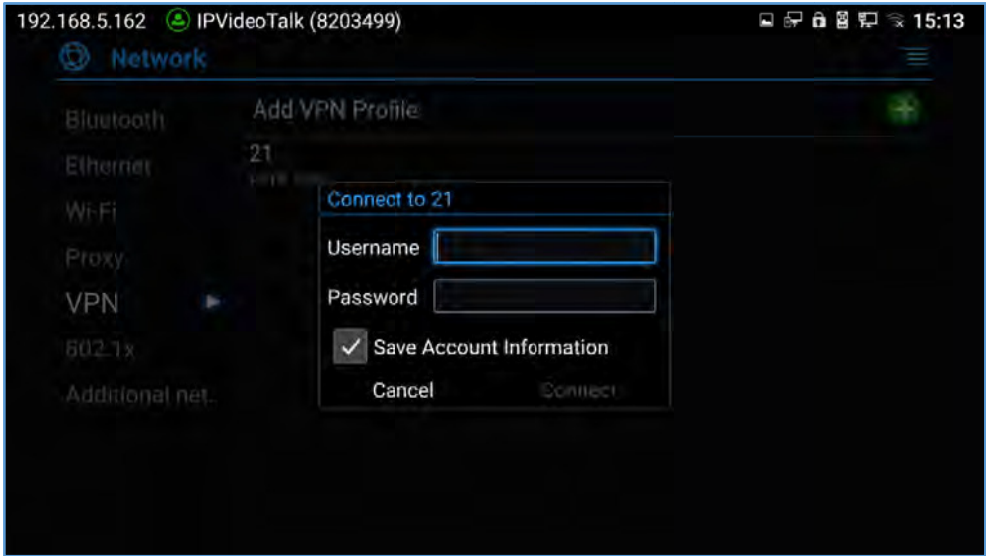





Figure 24: GVC3210 VPN Validation Screen

5. Fill in correct username and password to connect to VPN.

If GVC3210 is connected to VPN successfully, icon  will be shown in the top status bar; if the  connection is failed, a prompt box will pop up to remind users whether to reconnect to VPN. If icon  displays in the top status bar, please check whether if your VPN configuration is correct.



**Table 8: GVC3210 VPN File Parameters**

Parameters	Descriptions
<b>Name</b>	Fill in your company address or the server you are connecting to.
<b>Type</b>	Set to PPTP, L2TP/IPSec PSK, L2TP/IPSec RSA, IPSec Xauth PSK, IPSeXauth RSA or IPSec Hybrid RSA.
<b>Server Address</b>	Fill in the server URL or IP address.
<b>PPP Encryption (MPPE)</b>	Defines whether to use PPP encryption.
<b>Show Advanced Options</b>	Check this option to display more options below.
<b>DNS Search Domains</b>	Enter DNS search domain.
<b>DNS Servers</b>	Enter DNS server address.
<b>Forwarding Routes</b>	Enter Forwarding Routes, for example, 10.0.0.0/8.

## VLANSettings

Access GVC3210 home screen, go to **Applications**→**Settings**→**Network**→**Additional Network Settings**→**VLAN** to configure VLAN settings on GVC3210.

**Table 9: GVC3210 VLAN Configuration Parameters**

Parameters	Descriptions
<b>Layer 2 QoS 802.1q/VLAN Tag</b>	<p>Assigns the VLAN Tag of the Layer 2 QoS packets for LAN port. Default value is 0.</p> <p><b>Note:</b> Please do not change the setting before understanding the VLAN's settings or consulting with the network administrator. Otherwise, the device might not be able to get the correct IP address.</p>
<b>Layer 2 QoS 802.1p Priority</b>	Assigns the priority value of the Layer2 QoS packets. Default value is 0.



## LLDP Settings

Access GVC3210 home screen, go to **Applications→Settings→Network→Additional Network Settings→LLDP** to configure LLDP settings on GVC3210.

**Table 10: GVC3210 LLDP Configuration Parameters**

Parameters	Descriptions
<b>LLDP</b>	Enable or disable LLDP. The default setting is disabled.
<b>Layer 3 QoS for SIP</b>	This field defines the layer 3 QoS parameter for SIP packets. It is the value used for IP Precedence, Diff-Serv or MPLS. The default value is 26.
<b>Layer 3 QoS for Audio</b>	This field defines the layer 3 QoS parameter for audio packets. It is the value used for IP Precedence, Diff-Serv or MPLS. The default value is 46.
<b>Layer 3 QoS for Video</b>	This field defines the layer 3 QoS parameter for video packets. It is the value used for IP Precedence, Diff-Serv or MPLS. The default value is 34.

## 802.1X Mode

Access GVC3210 home screen, go to **Applications→Settings→Network→802.1x**.

By default, 802.1x is disabled. Selecting 802.1x mode to "EAP-MD5", "EAP-TLS" or "EAP-PEAP" to turn on 802.1x. Once it is enabled, the user will be required to enter the identity and password to be authenticated in the network.





**Table 11: 802.1x Mode Parameters on GVC3210**

Parameters	Descriptions
<b>802.1x Mode</b>	Allows the user to enable/disable 802.1x and configure 802.1x mode. The default setting is disabled.
<b>Identity</b>	Enter the Identity information for 802.1x mode.
<b>802.1x Password</b>	Enter the MD5 Password for 802.1x mode.
<b>CA Certificate</b>	Upload the CA certificate for 802.1x mode.
<b>Client Certificate</b>	Upload the CA certificate for 802.1x mode.
<b>Private Key</b>	Upload the private key for 802.1x mode.



## CAMERA

Users could set preset, configure camera parameters, start recording and make screenshots on camera screen. There are 3 ways to access camera screen:

- Click on  icon on home screen.
- Press key  on the remote control.
- Select  on home screen to access Applications, then click on .

GVC3210 camera screen has the following options:

- Press recording button on the remote control to start or stop local recording.
- Press the red shortcut button on the remote control to edit preset.
- Press the yellow shortcut button on the remote control to edit image parameters such as scene, white balance, etc.
- Press the blue shortcut button on the remote control for screenshot.
- Press digit key on the remote control to apply a pre-configured preset.

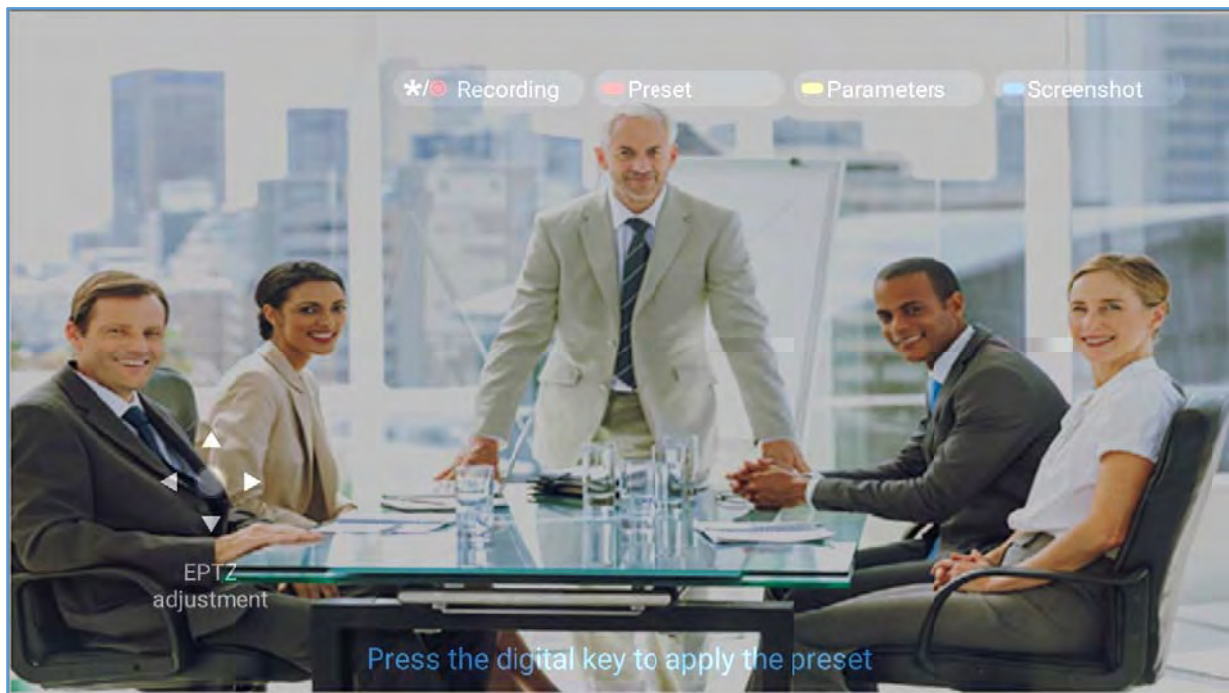

Figure 25: GVC3210 Camera Screen



## Preset

### Add Preset

Users can create and save maximum of 24 camera presets, with each preset storing the camera position and focal length. Follow the steps below to add preset:

1. Access camera screen and press the red shortcut key on the remote control to access preset screen.

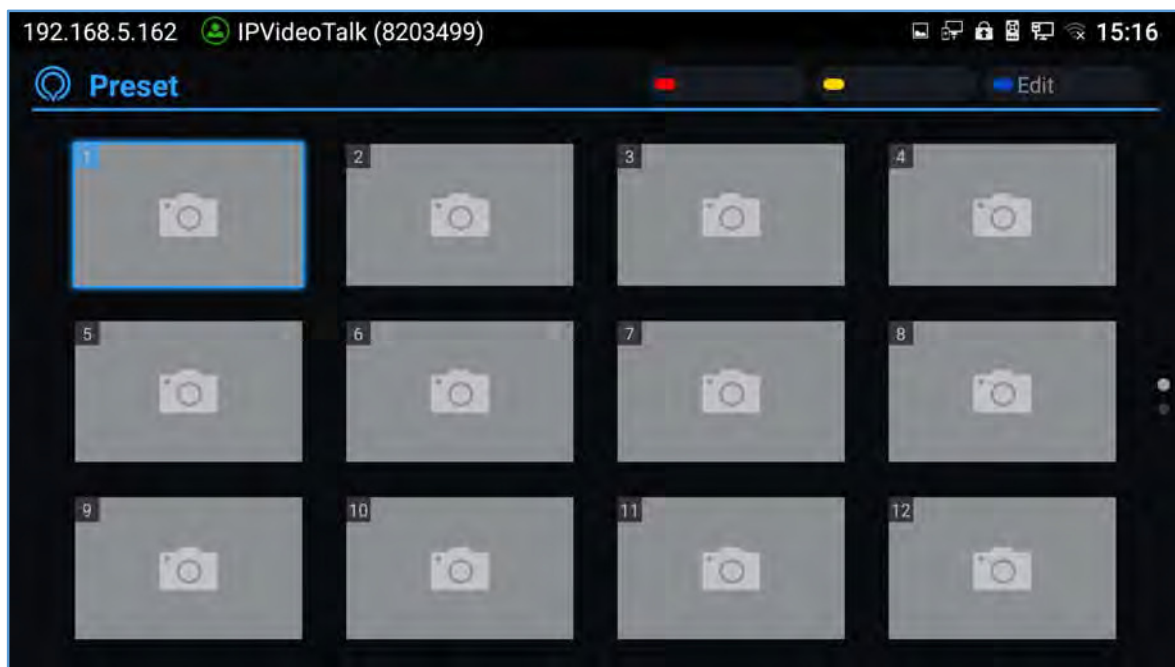



Figure 26: GVC3210 Add Preset Screen

2. Select the preset window and press the blue shortcut key on the remote control to access the editing screen.
3. Adjust camera position and zoom in/zoom out using the remote control.
4. On GVC3210 remote control, press "OK" key to save the preset, or press Back key  to cancel.

### Edit Preset

To edit an existing preset, press the blue shortcut key on the remote control to access the editing screen to edit. The created preset can also be renamed by pressing the yellow shortcut key on the remote control for better identification purpose.

### Delete Preset

Access the preset editing screen, select preset and press the red shortcut key on GVC3210 remote control to delete it.



## Apply Preset

If you have already set preset on camera, you can apply preset via one of the following two ways:

- Access camera screen and press the digital keys on the remote control to adjust camera to the preset.
- Access preset screen and press the digital keys to switch to the corresponding preset, press the yellow shortcut key to apply.

## Initial Position

Users can also define a preset as initial position when the GVC3210 boots up from LCD menu → Settings → Peripheral → Camera, three options are available:

- **System default position:** The GVC3210 will boot up at default camera position.
- **Position when power off:** The GVC3210 will return to the last position before power off.
- **Custom:** The GVC3210 will boot up at a custom position. When chosen, users will be redirected to Preset settings page to set a custom preset.

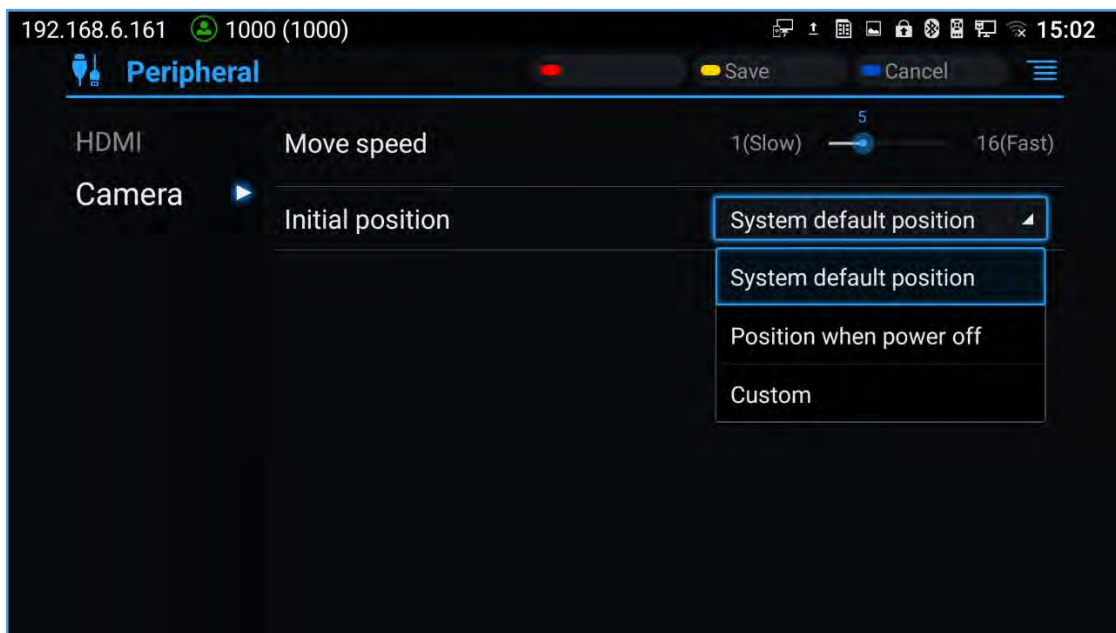

Figure 27: Initial Position

## Camera Parameters Configurations

Press the yellow shortcut key on GVC3210 remote control to bring out camera parameters setting screen as shown below. Refer to the table below and configure the parameters using navigation keys on the remote control.





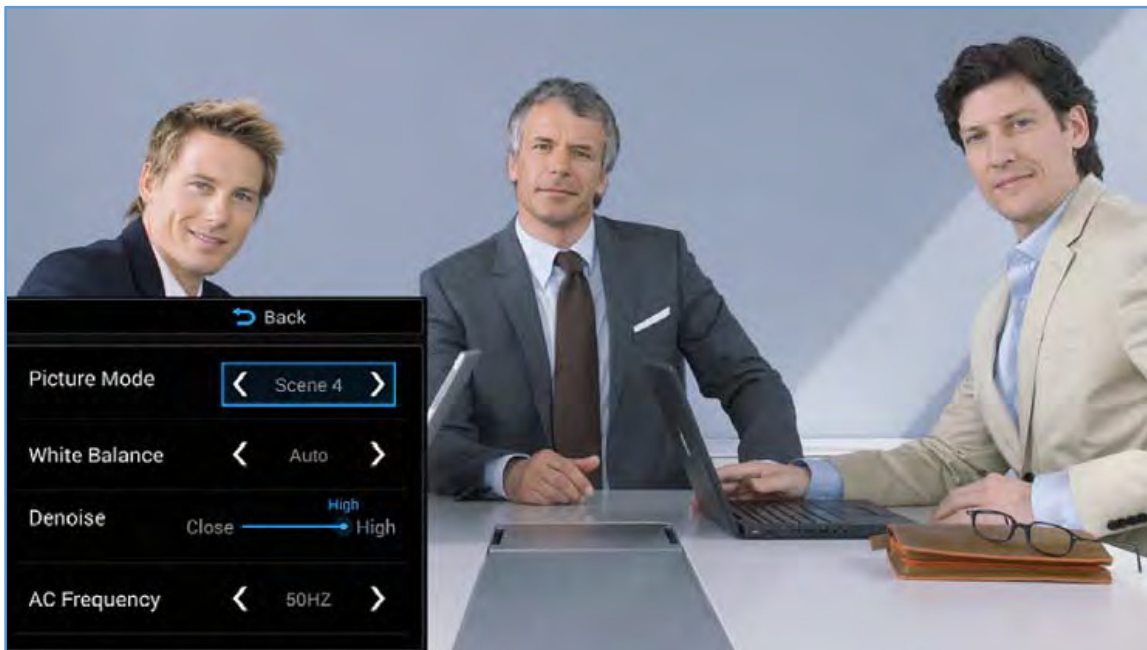

Figure 28: GVC3210 Camera Parameters Setting Screen

Table 12: GVC3210 Camera Parameters

Parameters	Descriptions
<b>Picture Mode</b>	<p>GVC3210 has 4 built-in modes as well as "Manual" for customization. When set to "Manual", press "OK" key to access each setting to configure contrast, saturation, and brightness.</p> <ul style="list-style-type: none"> <li>• <b>Contrast:</b> Higher value brings more distinct color contrast.</li> <li>• <b>Saturation:</b> Higher value brings deeper color.</li> <li>• <b>Brightness:</b> Higher value brings brighter color.</li> </ul>
<b>White Balance</b>	<p>This is used to display accurate images. Users could set to "Manual" or "Auto".</p> <ul style="list-style-type: none"> <li>• When set to "<b>Auto</b>", the device will adjust parameters automatically according to the current environment.</li> <li>• When set to "<b>Manual</b>", the device will disable "Auto" mode. Press "OK" key to access manual setting screen, and adjust red or blue gain manually for better white balance.</li> </ul>
<b>Denoise</b>	<p>Users could set to "off", "low", "medium" or "high". Higher reduction level brings less image noises.</p>
<b>AC Frequency</b>	<p>Users could set to 50HZ or 60HZ.</p>





## PERIPHERAL

### External USB Device

GVC3210 USB interface could be connected with a USB mouse, a USB keyboard, or a USB storage device.

#### Using USB Mouse/Keyboard

When a USB mouse is plugged into GVC3210, users could see the cursor on the screen, move the cursor to perform operations. When a USB keyboard is plugged into GVC3210, users could use GVC3210 remote control to navigate to an input interface, and click on the keys on the keyboard to check if it is installed successfully.

#### Using USB Storage Device

To connect and access USB storage device:

1. Insert USB storage device into one of the GVC3210 USB ports.
2. It will take a few seconds for GVC3210 to prepare the connection.
3. Once it is installed successfully, the USB storage icon will show up on the status bar. Users could go to GVC3210 LCD → **Applications** → **FileManager** → **USB** to access and manage your data.
4. Users could view, copy and paste files by using the USB storage device.

### Micro SD Card

1. Insert your Micro SD card into Micro SD card slot at the back of GVC3210. Please make sure the Micro SD card is inserted with right direction on GVC3210.
2. It will take a few seconds for GVC3210 to prepare the connection. Then, the Micro SD card icon will show up on the status bar.
3. To access the Micro SD Card, go to GVC3210 LCD → **Applications** → **FileManager** → **sdcard**. Tap on it to access and manage your data.



#### Note:

The external Micro SD card must be plugged in if the users would like to record calls and the recording files will be automatically saved in the external Micro SD card. It is recommended to use a Micro SD card with



large capacity for call recording purpose.

---

## Microphone and Speaker

GVC3210 is equipped with a built-in microphone. Alternatively, you can connect external audio devices to GVC3210 as audio input/output sources.

If the external speaker supports Bluetooth, users could also pair and connect the speaker to the GVC3210 via Bluetooth. This will provide better mobility and make cabling easier when deploying the GVC3210 conference system in your conference room.

When there are multiple audio devices connected to the GVC3210, the users could configure the audio device priority from LCD **Menu**→**Settings**→**Audio**→**AudioPriority**, or from web UI→**DeviceControl**→**AudioControl**: “Audio Device”. Please refer to more details in “**Audio Device**” section.



## MAKING PHONE CALLS

### Account

GVC3210 comes with one IPVideoTalk account, supports one configurable SIP account registration, one H.323 account and one BlueJeans account. Please enable the IPVideoTalk account, or register SIP account to a SIP server before making calls. The following figure shows the SIP account is registered successfully (account icon is green). This displays on the left side of the top status bar on your LCD display device.

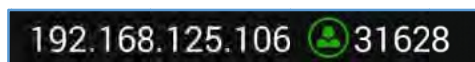





Figure 29: GVC3210 SIP Account

### Dial Screen

Once the account is registered successfully, users could use one of the following 3 ways to bring up dial screen to start making calls.

- Press the DIAL icon  in the lower right corner of the remote control.
- On the LCD display device, click on icon  on home screen.
- On the LCD display device, click on Applications and select  to bring up dial screen.

Enter digits in the dial-up box. If the digits or the letters for the digit match contacts and call history in GVC3210, a dropdown list of numbers will be displayed. For example, entering 5 (JKL), 6 (MNO), 4 (GHI) and 6 (MNO) will display “5646” or “john” if contact “john” exists. The matching characters will be highlighted in red.

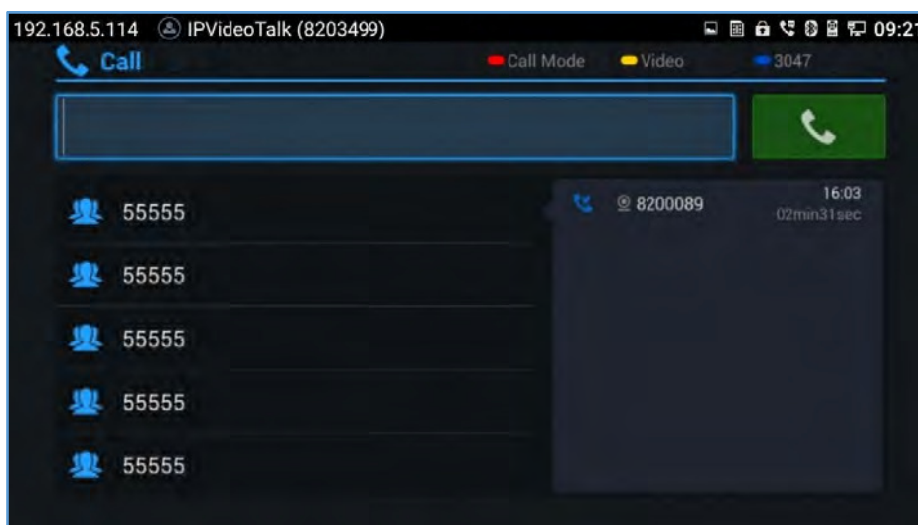





Figure 30: GVC3210 Call Screen

- Press the red shortcut key on the GVC3210 remote control to bring up call mode setting screen, set call mode to Call or IP call.
- Press the yellow shortcut key to set call type to Audio or Video.
- Press the blue shortcut key to switch account among SIP account, H.323 account, IPVideoTalk account and Blue Jeans account.
- Click on "Cancel" icon on the screen, or press  key on the remote control to cancel the call.

### Dialing a Number Directly

1. Open the dial screen.
2. Use the remote control keyboard to enter digits, or click the input box to enter digits using the popout soft keyboard.
3. Press  on the remote control to dial out, or move the cursor to the icon  on dial screen and click it to dial out.



#### Note:

1. By default, GVC3210 allows users to press # key as SEND key. This behavior can be disabled via option "Use # as Dial Key" in web GUI→**SIPAccount**→**Callpage**.
2. When entering initials or full spellings of a name that exists in the contact, this contact will show up in the dropdown list. For example, if the user inputs Amy by pressing the corresponding digits "2" (ABC), "6" (MNO), "9" (WXYZ) on the remote control, Amy's name and number will be displayed in the list if it exists in the contact, users can select it to dial out.

---

### Redial

Users can dial out the last dialed number if there is dialed call log. Access the dial screen, and then press "#" key or  on the remote control to dial out.

### Dialing a Number via Contact



Follow the steps below to dial a number via Contacts.

1. On the LCD display device, access Contacts by tapping on button  on home screen.
2. Navigate and select in the contacts entries using the remote control navigation keys.



3. Press  on the remote control to dial out.

### Dialing a Number via Call History

1. On the LCD display device, access Applications on home screen and access call history by selecting the icon .
2. The LCD will display all call history types. Navigate in the call history list by selecting the call history category. Select the call history entry you would like to dial out.
3. Press  on the remote control to dial out.

### Direct IP Call

Direct IP Call allows GVC3210 and another VoIP device to talk to each other in an ad-hoc fashion without a SIP proxy. Direct IP calls can be made if:

- Both GVC3210 and VoIP phone have public IP addresses, Or
- Both GVC3210 and VoIP phone are under the same LAN / VPN using private or public IP addresses, Or
- NAT is disabled or GVC3210 NAT is disabled.

Both devices can be connected through a router using public or private IP addresses (with necessary port forwarding or DMZ).

To make a direct IP call, please follow the steps below:

1. Access the dial screen on GVC3210 LCD.
2. Press the red shortcut key on the remote control to bring up call mode setting screen, set the mode to "IP Call".
3. Input the target IP address. For example, if the target IP address is 192.168.124.123 and the port is 5062, input the following: 192\*168\*124\*123#5062  
The \* key represents the dot (.) and the # key represents the colon (:).
4. Press the yellow shortcut key on the remote control to select "Audio Call" or "Video Call".
5. Press  on the remote control to dial out.



## Paging/Intercom

Before placing paging/intercom, please make sure the callee has paging/intercom enabled so that it can answer the paging/intercom call automatically. To make paging/intercom call:

1. Access the dial screen on GVC3210.
2. Enter the number to dial followed by \*74. Please refer to **Call Features** for more details.
3. Press the yellow shortcut key on the remote control to select "Audio Call" or "Video Call".
4. Press  on the remote control to dial out.

## Answering a Call

When the device is in idle and there is an incoming video call made by SIP or IPVideoTalk account, the device will show the call screen as below:

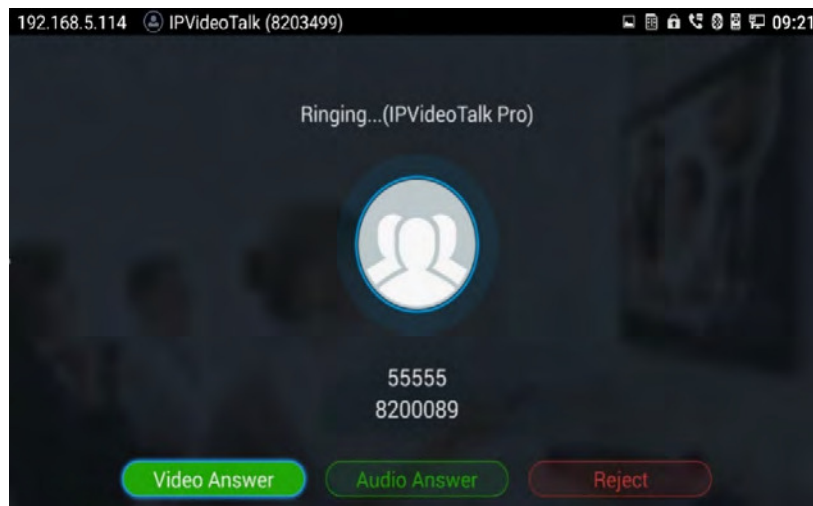
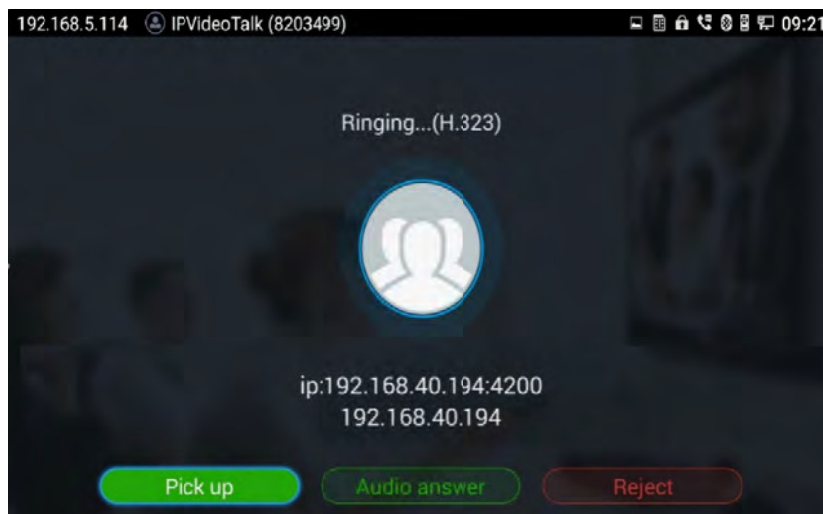

Figure 31: GVC3210 Single Incoming Call Screen

If the incoming video call is made by H.323 account, the call screen will display as below:









**Figure 32: GVC3210 Single Incoming H.323 Call Screen**

Select "Video Answer" or "Pick up" to answer the call with both video and audio, "Audio Answer" to answer the call with audio only, or "Reject" to reject the call.

## Call Hold

During an active call, press HOLD button  to put the call on hold.

- On the LCD display, click on  to resume the call.
- On the LCD display, click on  or press  on the remote control to end the call.

If the current call is a video call, the screen will not display remote video when the call is on hold.

## Mute Local Audio

During an active call, press the MUTE button  to mute the call, press the button again to unmute the call.

## Call Recording

During an active call, users could record the video to the external Micro SD card plugged into GVC3210. Once recorded, users can view the recorded video in Recorder application, and download the video from web UI → **Maintenance** → **Recording**. For more details, please refer to the chapter **Recording**.

1. During an active call, press the recording key  on the remote control. A red Rec icon will show up





on the upper left of the screen.

2. The recording files will be saved to the configured save path automatically when the call is finished.

Users could also press  on the remote control to stop recording anytime.

## DND (Do Not Disturb)

When DND is on, the incoming calls to GVC3210 will be blocked without ringing. Users could see the blocked calls in call history. Once it is enabled, the DND icon  will be displayed in the status bar on the top of the screen.

- When GVC3210 is in idle screen, users can press  button on the remote control to turn on/off DND.
- When GVC3210 is in an active call, users could turn on/off DND in call screen→MORE options. This will not affect the current call, and it will take effect starting from the next incoming call.
- At any time, users could log in GVC3210 web UI and click on “DND” on the top tool bar of the web page to turn on/turn off DND.



### Note:

After enabling DND mode during a conference, the DND mode will remain effective after the call is over.

---

## Missed Call

When there is a missed call, the call icon  on home screen will show the number of missed calls. Once accessed the dial screen, the reminder icon will disappear.

## Call Forward

Call forward (Unconditional/No Answer/Busy/Time Based) can be set up from web GUI. Log in GVC3210 web GUI and go to **Settings**→**SIPAccount**→**Call**. For details, please refer to "GVC3210 Administration Guide".

## Remote Camera Control in Call (FECC)

During the video call, if the local party (GVC3210) and remote party support FECC, the remote camera can





be controlled on the GVC3210.

Here is how to use FECC on the GVC3210 to control remote party's camera:

1. Make sure the GVC3210 and the remote party support FECC and it's enabled on both parties. For GVC3210, FECC setting is under web UI→**Settings**→**AccountSettings**→**Codec**: "Enable FECC". If the remote party is another vendor's video device, please check the documentation from the vendor to enable FECC.
2. Establish video call between GVC3210 and the remote party.
3. On the GVC3210 remote control, press the camera button  and the following prompt pops up on GVC3210 display device.



Figure 33: FECC – Remote Camera Control

4. Use UP/DOWN/OK navigation keys on the GVC3210 remote control to select the remote party, e.g., GVC-LAB in the above figure. This will bring up camera control interface.
5. On the GVC3210 remote control, press the navigation keys and zoom in/zoom out buttons on trackpad to adjust remote camera.



## IPVIDEOTALK CONFERENCE

### Device Layout



GVC3210 supports IPVideoTalk conference and it can be the host to initiate a conference or join other conferences as a member.

Users can connect two HDMI output devices for conference. HDMI 1 interface is the primary output when plugging in the two HDMI display devices. The device connected to HDMI 1 interface will display local site by default while other devices automatically display the remote site.

During a conference, user can tap on  button on GVC3210 remote control trackpad to go back to HOME screen, with the conference video displayed in the background.

### Initiating Conference

The conference can be initiated in multiple ways:

- **From Call Screen:**
  1. Access the call screen, enter the number in the text box or select the member from the list below.
  2. Press  on the remote control or click on button  on the screen to dial out.
- **From Schedule:**

For more details, please refer to section **Schedule**.

### Answering an Incoming Call in Conference

You can specify how your GVC3210 handles incoming calls. Depending on your configuration, your GVC3210 answers a call automatically or prompts you to answer a call manually:

- Log in GVC3210 web GUI and go to **Settings→IPVideoTalkAccount→Callpage**, and set "Auto-answer when idle" option to "Yes". All incoming calls will be answered automatically. If it is an IPVideoTalk call to join a conference, it will be answered with video as well.
- If "Auto Answer when idle" is set to "No", users will need to select to answer with video manually, audio or reject the call using the remote control on the LCD prompt.
- If the conference host answers the call, the caller will join into the current active conference.



## Conference Management

The following figure shows a 3-way IPVT conference:







Figure 34: GVC32103-Way IPVT Conference







On the bottom of the call screen, users will see a list of icons for menu options. This menu will be automatically hidden if there is no operation in 5 seconds. Press any key to bring up the menu options again.

Here are the functions for each icon.



Table 13: GVC3210IPVT Call Screen Bottom Menu Icons

Icons	Name	Definitions
	<b>Add Member</b>	Access dial screen and add more numbers to join conference.
	<b>Record</b>	Start/Stop Local/Cloud recording the ongoing conference. The recording files will be saved to the connected Micro SD card or USB.
	<b>Conference Control</b>	Control video and audio for conference members. It includes the following options for each party:  - The selected party will not be heard by other parties.  - The selected party will not hear other parties.







		 - The video call with the selected party will turn into audio call. If the user clicks on this icon again, a video invitation will be sent to this party. The party has to accept the video request in order to see the video again.  - Suspend video from the video party. Click on it again to resume video.  - Prevent the GVC3210 from uploading local video streaming to IPVideoTalk server during an IPVT conference.
	<p align="center"><b>Layout</b></p>	<p>Adjust the layout for the video display for video call.</p> <p>The layout options might vary depending on how many video participants are in the call, how many HDMI outputs are connected and whether presentation is turned on or not.</p> <p>For example, in a two-way video call on GVC3210 which has one HDMI output connected, after pressing “Layout” icon, users will see options “Average”, “POP” and “PIP”</p>
	<p align="center"><b>Hold</b></p>	<p>Pause/resume conference. Once the conference is paused, the device will stop sending local video/audio to the remote parties.</p>
	<p align="center"><b>Presentation</b></p>	<p>Turn on/off presentation.</p> <p>HDMI IN must be plugged in first. When HDMI IN is plugged in to GVC3210, after the user selects “Presentation”, the user can select mode “Auto” or “PC” to display presentation.</p> <ul style="list-style-type: none"> <li> <b>Presentation Mode: Auto</b>            The GVC3210 that shares presentation will send dual stream. The other participants will receive two streams and can select to display both presentation + video at the same time. If the other participants do not support BFCP, the GVC3210 that shares presentation will only send presentation stream and the participant can show presentation.         </li> <li> <b>Presentation Mode: PC</b>            The GVC3210 that shares presentation will only send presentation stream, no local video stream. The other participants only see presentation.         </li> </ul>



	<p style="text-align: center;"><b>More</b></p>	<p>Bring up more options. The options include:</p> <ul style="list-style-type: none"> <li>• <b>Call details</b> Display call details such as video packet loss rate, video bit rate, video frame rate, video codec, video resolution, audio packet loss rate, audio bit rate and audio codec for both sending and receiving parties.</li> <li>• <b>Open Dial Keyboard</b> To enter DTMF during the call.</li> <li>• <b>Meeting info</b> Display all the information about the call.</li> </ul>
	<p style="text-align: center;"><b>End</b></p>	<p>End conference and go back to home screen.</p>

- If the remote party is also a GVC3210, you can press the camera key  on the remote control to control EPTZ device for the remote party.
- Users could press the red/blue/yellow shortcut keys on the remote control to input DTMF, view notifications and view status.
- During an active conference call, if there is an outgoing call failed or a member hanging up, there will be a prompt box on the left side of the conference screen showing notifications. The notification prompt will be hidden automatically if there is no new notification in 2 seconds.
- On the right side of the video conference screen, users can see member status such as audio/video calls, or whether if the call is being muted.

**Table 14: GVC3210 Conference Member Status Descriptions**



Icons	Descriptions
	<p>The current line is in an audio call.</p>
	<p>The current line is in a video call.</p>
	<p>The current line is being muted.</p>
	<p>The current line is not connected.</p>

- On the upper left side of the video conference screen, users can see an icon  to indicate network unstable condition, which means the current network condition is not good enough for the video call using the selected resolution/bit rate.



## Invite Members to Conference

Users could use one of the following ways to add members:

- Access the dial screen by clicking on the ADD icon  on conference screen. Then, enter the number to dial out. Once the member answers the call, it will be connected into the conference automatically.
- When GVC3210 is on conference screen, press on the remote  control to access the call screen. Then, enter the number to dial out. Once the member answers the call, it will be connected into the conference automatically.
- The member calls the conference number. If the host answers the call, the member will be added into conference automatically.

## Conference Control



Tap on  to make operations such as mute, disable sound, camera control and suspend video. The conference control screen is as shown below:



Figure 35: GVC3210 Conference Control Screen

1. Use Up/Down navigation keys on GVC3210 remote control to select conferencemember.
2. Use Left/Right navigation keys on GVC3210 remote control to make operations, press "OK" key to confirm the operation, press "OK" key again to cancel, e.g. tap on to mute  one member and the  icon will turn to tap on it again to restore.



### Note:

Users could press the shortcut keys on GVC3210 remote control on conference control screen to mute all, block all or suspend videos.



## Pause Conference

The video will be stopped if the conference is paused. You will not see the video view of the members and the other members will not see your video either.



### Note:

The presentation will be displayed normally when the conference is paused.

## Custom PIP

During a video conference, users can customize screen layout when using multiple connected HDMI outputs, to specify particular video feeds to be displayed on each screen.

- Under GVC **Callscreen**→**Layout**→**PIP**, users can choose which video feed to be selected.



Figure 36: Select Video Feed

- Once users choose Custom option, a window will show in order to customize the layout and the video feeds for each HDMI output.



Figure 37: Layout Customization for multiple HDMI Outputs





- A selection window for the available monitors will pop up, in order to select which output will display the video streaming for the feed selected in previous step (In this example “Local” feed will be displayed on “HDMI 1 Output Screen”).



**Figure 38: Choose HDMI Output**

## Presentation Sharing

GVC3210 supports dual stream video, with the presentation sharing function, you can connect HDMI input devices such as a computer, or a DVD player to GVC3210, and share the HDMI input sources with remote parties while he can still view the local video.

The following figure shows 3 TVs used for GVC3210. The one on the top shows presentation, the two on the bottom show remote party video.





**Figure 39: GVC3210 3-Way Conference with Presentation**





**Note:**

1. When HDMI IN interface is connected, GVC3210 will only display the device connected to HDMI IN port.
2. Users could also press PIP button  on GVC3210 remote control to change video display layout.

This will bring up the same options as pressing icon  on the bottom menu.

## Conference Recording

During a video conference, recording feature is supported on the GVC3210, including video and presentation shared by GVC3210, or IPVideoTalk WebRTC clients.

- If Auto presentation mode turns on, only the presentation is recorded.
- If PC presentation mode turns on, the presentation and local video stream are recorded.
- If presentation mode turns off, dual video streams are recorded.

During conference, a new option of cloud recording is added to allow users to control recording, the recording can be done from GVC screen or Web UI as shown below:

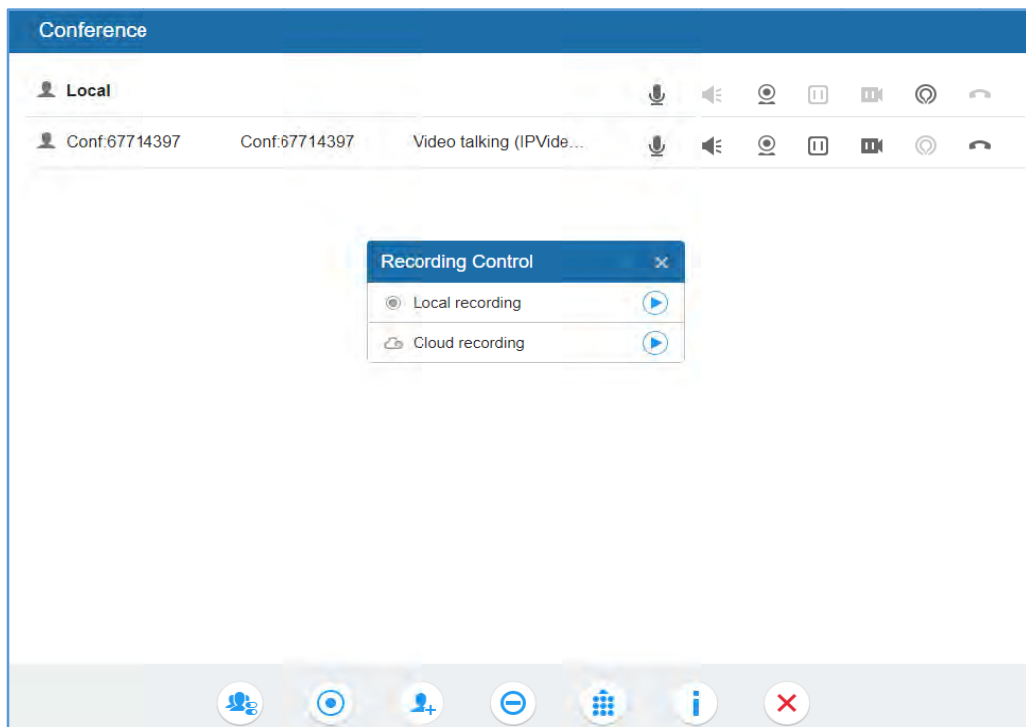





Figure 40: Web UI Conference Recording



For more details about local recording, please refer to **Recording**.

For more details about cloud / IPVideoTalk recording, please refer to the chapter **Start Cloud Recording**.

1. Press  on the GVC3210 remote control or the recording icon  on bottom menu to start recording.
2. The recording files will be saved to the configured save path automatically when the call is finished.  
 Users could also press  on the remote control or the recording icon  on bottom menu to stop recording anytime.



**Note:**

It is strongly recommended to use a MicroSD card or USB storage device with large capacity for call recording purpose.

## Call Details

Users could view audio and video details of the conference members. On the conference screen, click on  and select "Call Details" to check the details.



Figure 41: GVC3210 Call Details Screen



## Participants List

Users could check all participants in the current IPVideoTalk meeting. If the meeting host does not allow the participants to check all members, the participants cannot see all members in the meeting.

During IPVideoTalk meeting, click on "More"  then click on "Participants List". GVC3210 will show all participants in the current IPVideotalk meeting, including all participants with all types of clients.

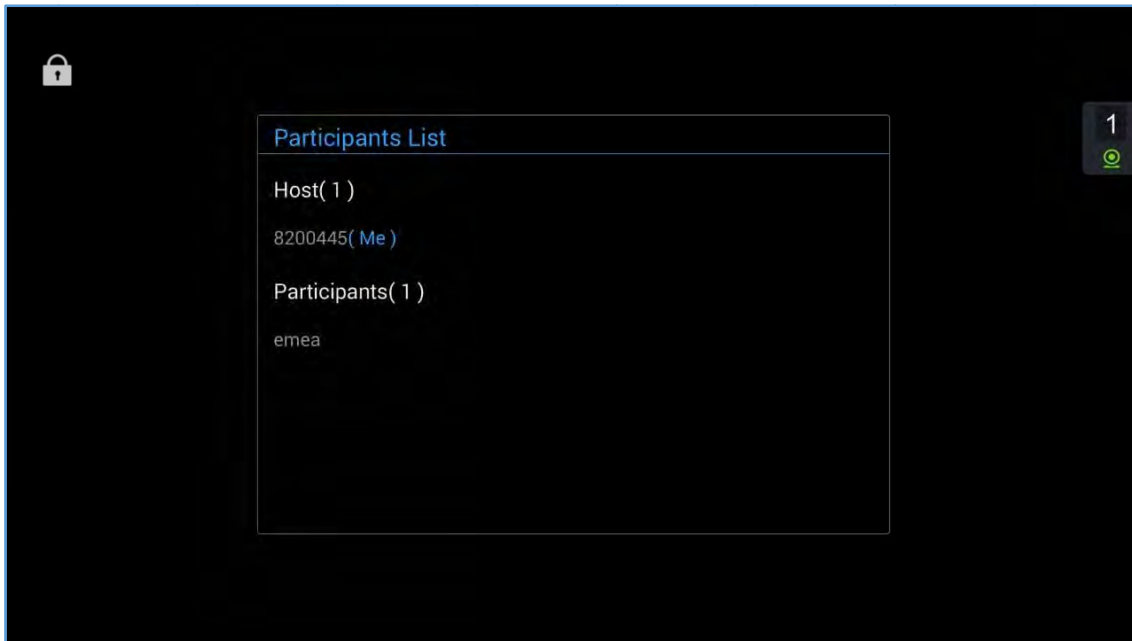



Figure 42: GVC3210 Participants List



## Open Dial Keyboard

Users can send DTMF during a conference using "Open Dial Keyboard" function.

1. On GVC3210 remote control, press the red shortcut key, or click on MORE button  →select "Open Dial Keyboard" on the conference screen to bring up the DTMF input screen.
2. Press the digital keys on the remote control to input DTMF. Press  to cancel the operation if needed.

**Note:** The GVC3210 can join a locked meeting with a PIN Code by using "Open Dial Keyboard" to input the PIN Code followed by #.

## End Conference

To end the conference, tap on END button  or press key  on GVC3210 remote control to either "Exit Conference" or "End Conference". If GVC3210 is the conference host:



- Select “Exit conference” so that the GVC host will leave the conference itself while the IPVT conference will still be going on. The conference can be ended by WebRTC host or admin through web portal afterwards.
- Select “End conference” so that the IPVT conference will be ended and all the other participants will be disconnected from the IPVT server.

If the conference member hangs up the call, it will be disconnected from the conference, but other parties in the conference will stay in the conference.

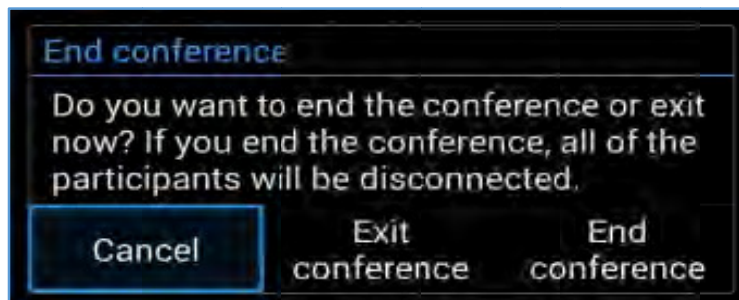

Figure 43: End Conference

## Power Off During a Conference Call

During the meeting, if the user presses Power ON/OFF button, a new dialog will be prompted that allows user to end the current conference and shutdown GVC3210 immediately. Choose “Power off” to end the conference call and power off the GVC3210 immediately, or choose “Sleep” to go on sleep mode, or choose “Reboot” to end the conference and reboot the device.

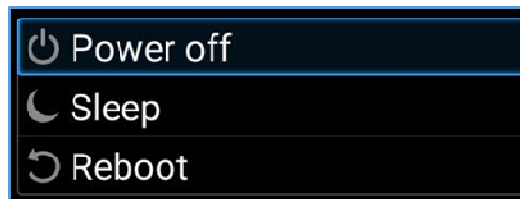

Figure 44: Power Off During a Call

## IPVideoTalk Application

IPVideoTalk application provides an interface for the user to manage this service on the GVC3210, e.g., view enterprise directory contacts, check and reply to notices from IPVideoTalk server as well as change IPVideoTalk settings. The user can access IPVideoTalk application from

LCD → Applications → IPVideoTalk 



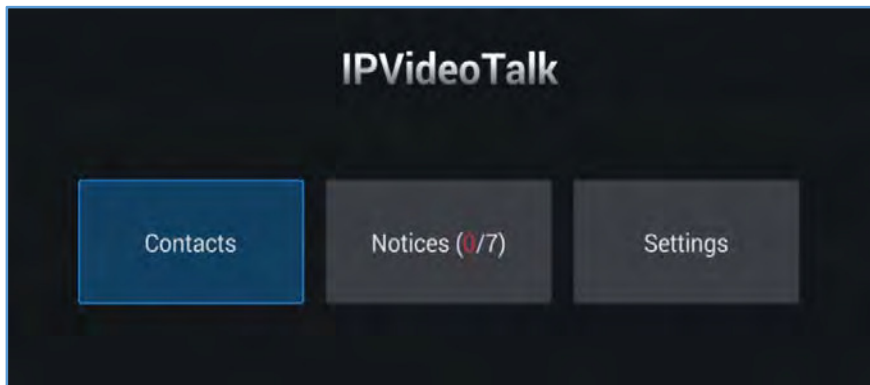







Figure 45: GVC3210 IPVideoTalk Application

## Contacts

The contacts are managed centrally in the server side. Users can access by selecting “Contacts”.



Figure 46: IPVideoTalk Application→Enterprise Directory

- In Contacts, the users can view account status: online - , offline - .
- Users can also view Contacts types:
  - a. Group. 
  - b. Regular contacts with name, phone number, Email address etc. 
  - c. Public GVC3210 Device with an IPVideoTalk ID. 
- Select an entry in the directory and press the Green Call button  on the GVC3210 remote control to call this contact.



- Press the red shortcut key on the GVC3210 remote control to refresh the directory.
- Press the yellow shortcut key on the GVC3210 remote control to search contacts in the directory.
- Press the blue shortcut key on the GVC3210 remote control to select entries and make a batch call to multiple contacts in the directory.

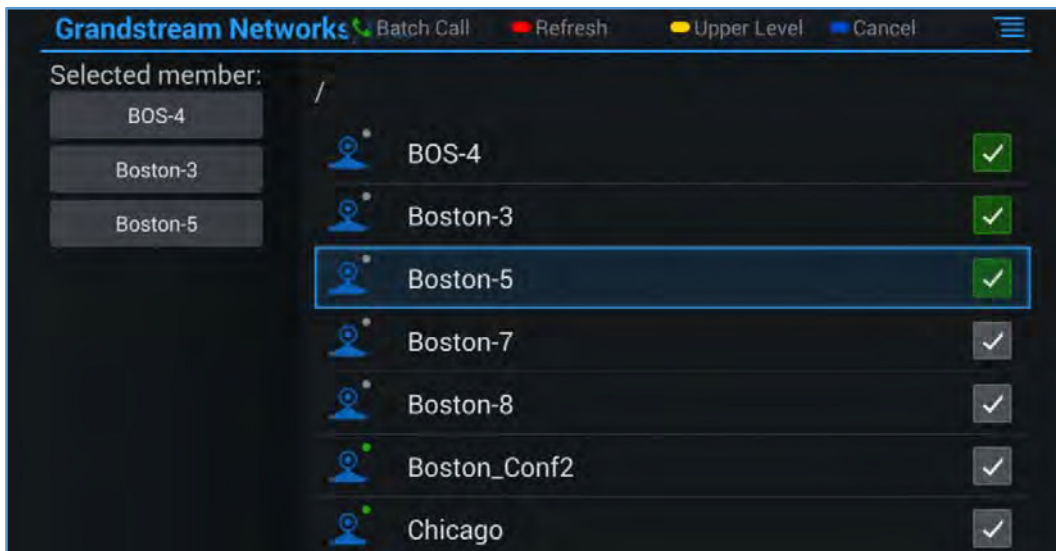

Figure 47: IPVideoTalk Application→Enterprise Directory: Batch Call

## Notices

In the IPVideoTalk application, any incoming messages from the server side will be displayed in “Notices”. In the following figure, “2” indicates the number of new message and “3” indicates the number of total messages.

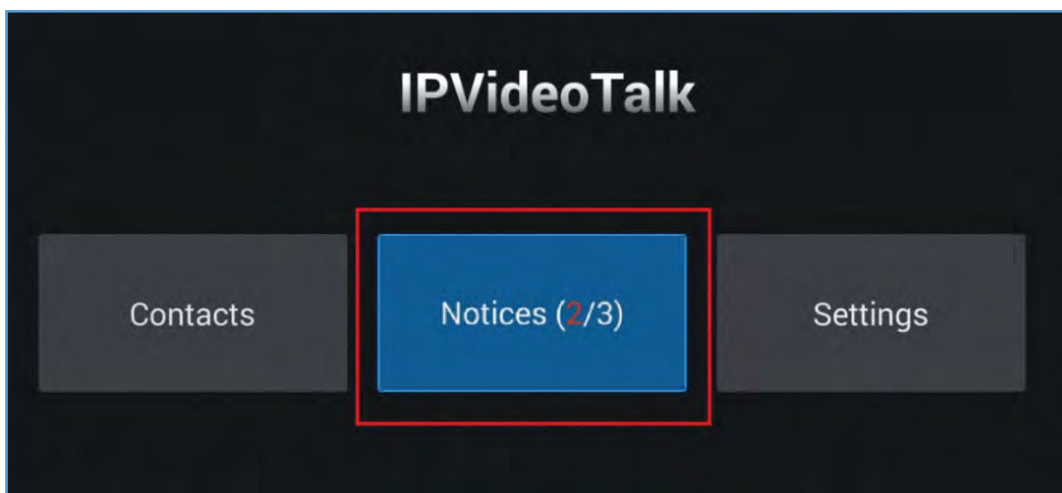

Figure 48: IPVideoTalk Application→Notices



Click on “Notices” to access the messages. Use the navigations keys/OK keys on the GVC3210 remote control to select and read the messages. For the messages that requires user’s reply, a prompt will pop up for the users to make a selection.

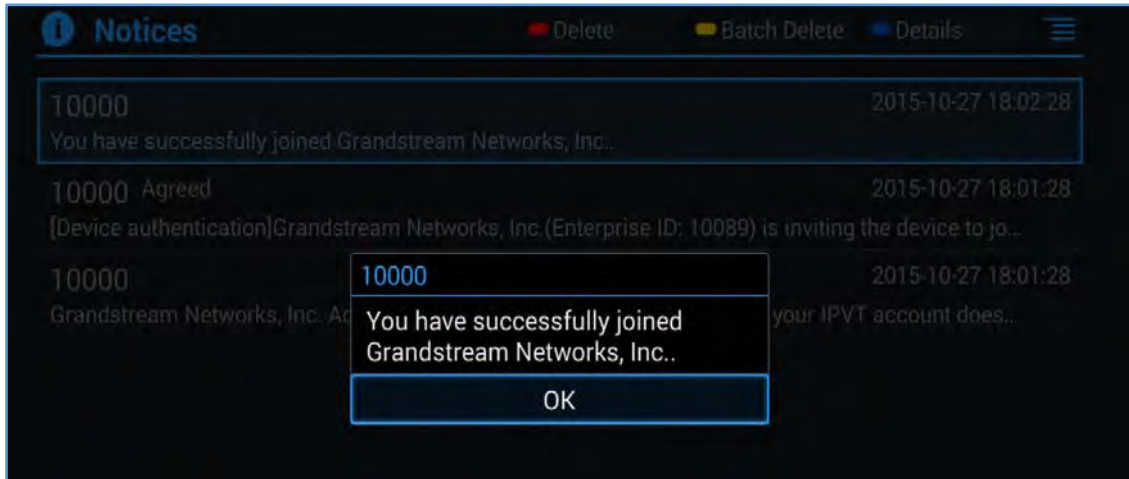
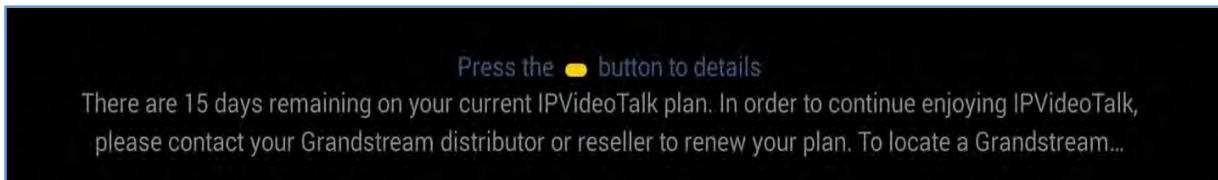
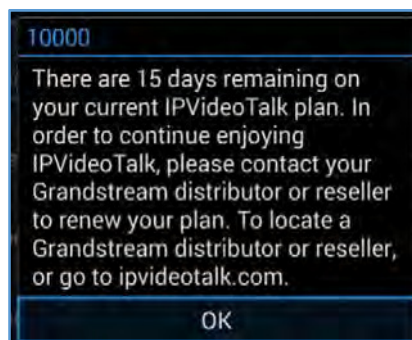



Figure 49: IPVideoTalk Application→Notices: Message Prompt

When IPVideoTalk plan is about to expire or already expired, a message will appear on the bottom of GVC3210 LCD home screen. Press yellow short key to view message details.



Also, detailed information is on GVC3210 LCD  
**menu→Applications→IPVideoTalkapplication→Notices.**



If there are new incoming messages for the IPVideoTalk account, users will see indicator icon  on the top status bar. Also on the upper right corner of the IPVideoTalk application icon in Application menu,





users will see the number of new messages displayed.

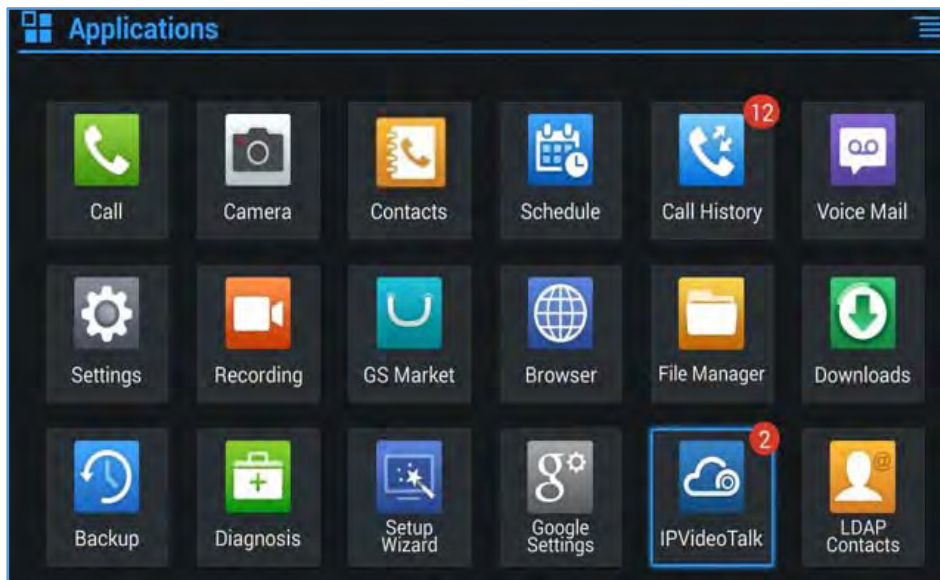

Figure 50: Message Indicator for IPVideoTalk Application

## Settings

In the IPVideoTalk application, click on “Settings” to configure “Account Active” and “Display Name” for the IPVideoTalk account on GVC3210. The users could also click on “Device Code”, “Current plans”, “Business” for more plan details. Besides, current IPVideoTalk version information will be shown under “Application Information”.

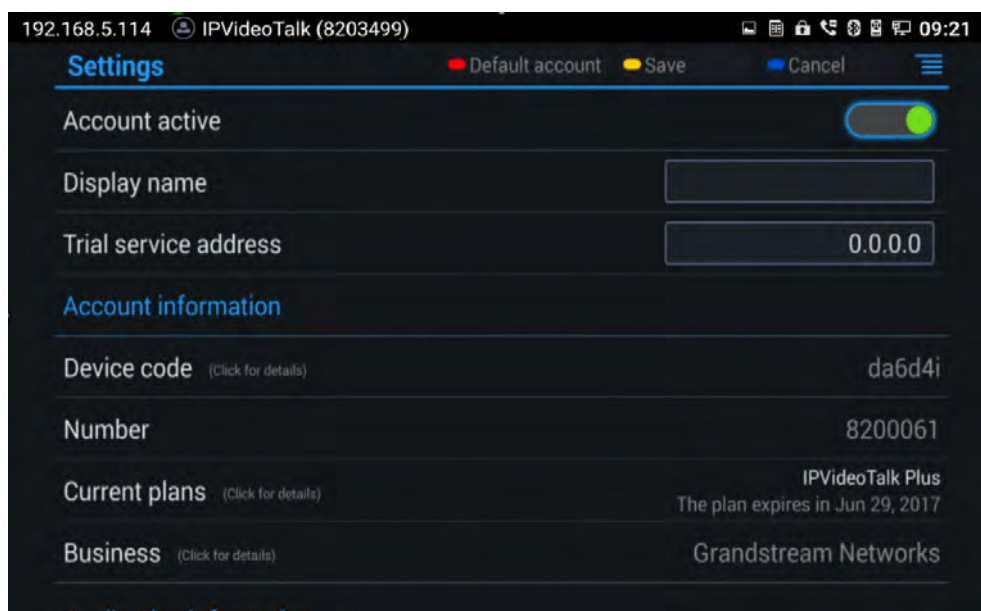

Figure 51: IPVideoTalk Account Settings





## Join an IPVideoTalk Meeting

Users can join an IPVideoTalk meeting by dialing the host GVC3210's IPVideoTalk ID or meeting ID. Please note only after meeting starts, GVC3210 can use this method to join the conference as a participant.

- Dialing host GVC3210's IPVideoTalk ID to join an active meeting

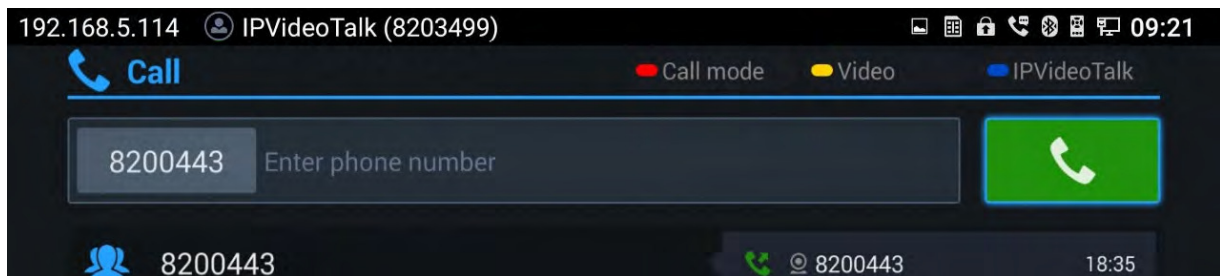

- Dialing meeting ID to join an active meeting.

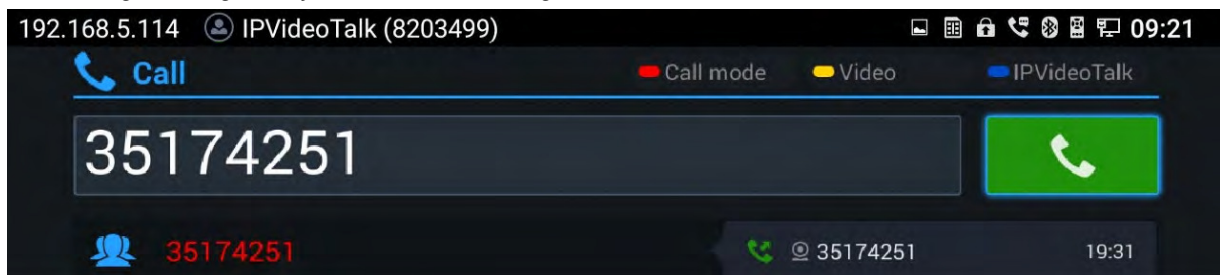

## Busy Tone Responses

Please note GVC3210 can only join one IPVideoTalk meeting at one time.

Note that a specific busy response messages rather than SIP 486 busy error prompt on IPVideoTalk dialing interface when trying “The number you dialed is hosting another meeting”. Host GVC cannot be added as a participant of another IPVideoTalk meeting.

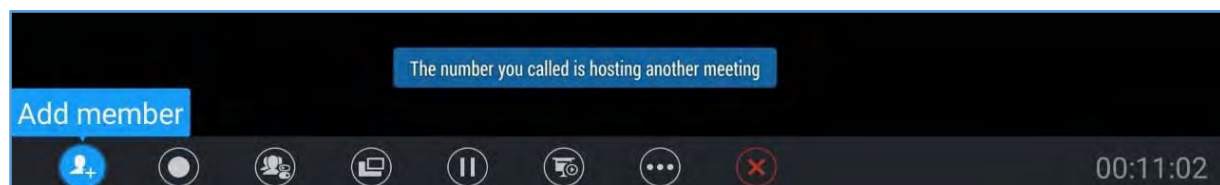

Figure 52: Busy Tone when the Callee is the Host of another Meeting

“The number you dialed is joining another meeting”. Participant GVC of an active IPVideoTalk meeting cannot be added to another meeting.



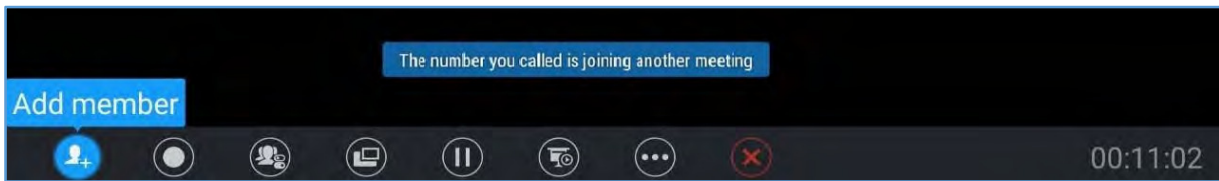

Figure 53: Busy Tone when the Callee is already a Meeting's Member

### Manually Start IPVideoTalk Tip

If a meeting is scheduled from IPVideoTalk Web Portal, then the meeting will sync to host GVC3210 device LCD→Schedule interface. There will be a prompt message “You are about to manually start a pre-scheduled meeting. If you start this meeting the original scheduled meeting date and time will be voided” when pressing CALL button on remoter to start the meeting manually before or after scheduled time.

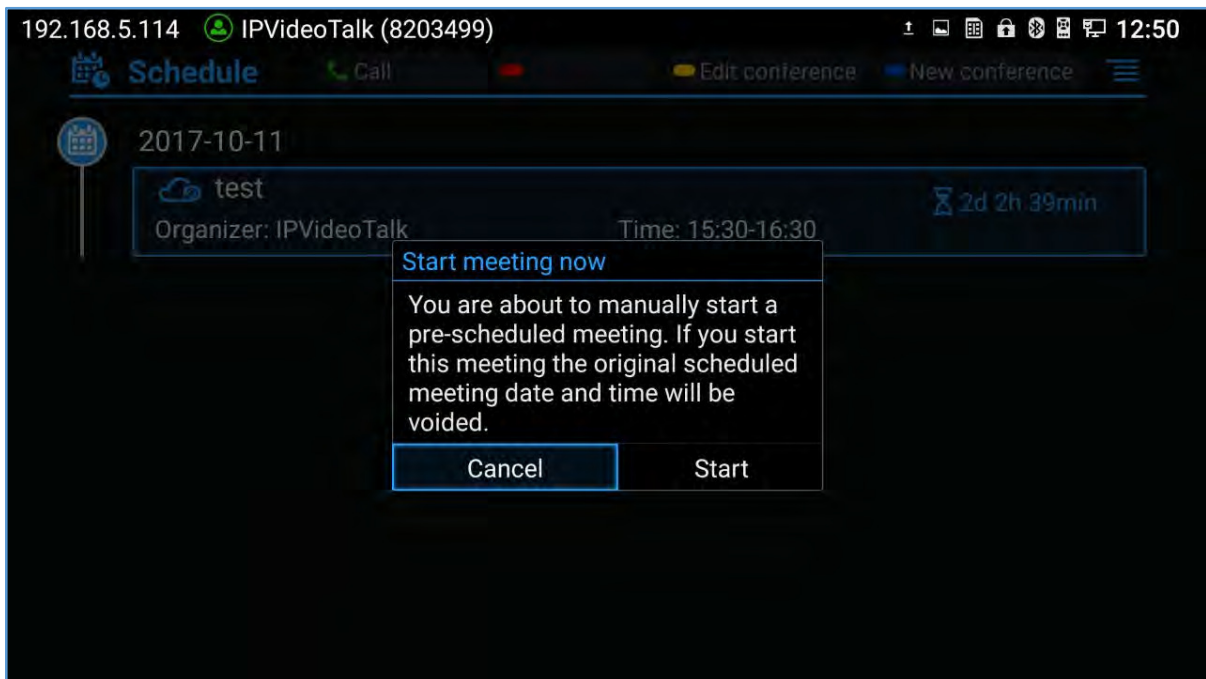

Figure 54: Manually Start Scheduled Meeting

For more information about your IPVideoTalk services, settings, how to manage accounts and schedule meetings, please check IPVideoTalk user manual from <http://www.ipvideotalk.com>

### Hand Down/Up in IPVideoTalk Meeting

If GVC3210 joins an IPVideoTalk meeting as a participant and the host is any WebRTC client, the participant could click on button  on GVC3210 LCD→Call screen to raise hand to attract attention from host thathe/she wants to be unmuted or needs any help.





Figure 55: Hand up - IPVideoTalk

The raised hand status of GVC3210 participants could be checked from Participants List on Host WebRTC Client, as shown in below figure

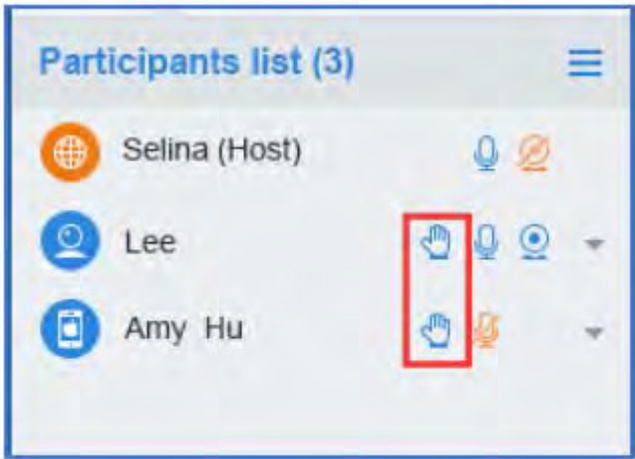

Figure 56: Participants list

The raised hand could be put down by participant itself or WebRTC host.

- Participant GVC3210 could hand down itself by clicking on button  again.



Figure 57: Hand down - IPVideoTalk

- WebRTC Host could put down GVC's hand.

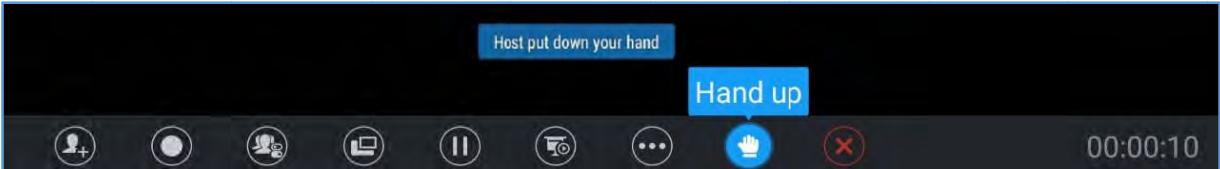

Figure 58: Hand down by Host - IPVideoTalk



### Stop Sharing Local Camera

WebRTC host can stop the camera feed of a GVC attendee to prevent it from uploading its local video streaming to IPVideoTalk Server.

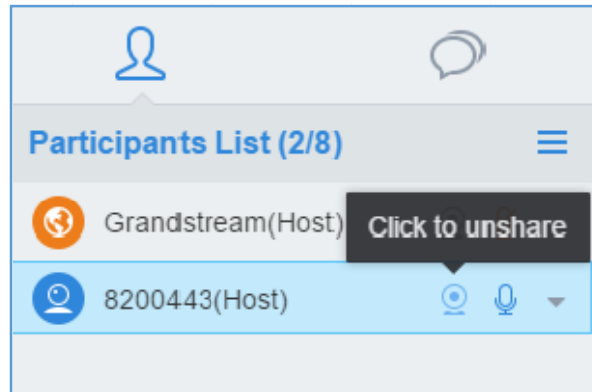

Figure 59: Stop Camera Sharing

### Stop Video Upload Icon



Under GVC3210 LCD → **Call Screen** → **Conf Control**, users could prevent the GVC3210 from uploading local video streaming to IPVideoTalk server during an IPVideoTalk meeting by clicking on . Other participants will not receive any video streaming from this GVC3210, and it will switch to 1-way video.



Figure 60: Stop Video Uploading

### Start Cloud Recording

During an IPVideoTalk meeting/webinar, a new option is added under Call Screen of host GVC to allow users to control cloud recording.

To start/stop cloud recording, users could click on “Record” button under host GVC3210 LCD → Call screen, or press  shortcut key on remote control:



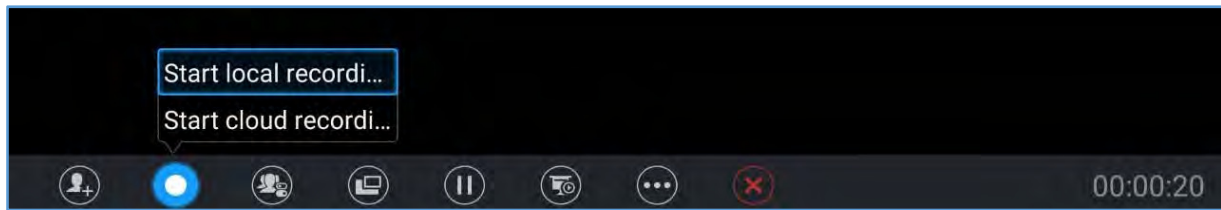

Figure 61 : Start Cloud Recording

There will be an icon **Rec** shown on the left upper corner of host GVC as well as all other participants to indicate the cloud recording is in progress, the screen and record button will also show as follow:

Users can at any time stop the recording by clicking the record button and press: **Stop cloud recording**

Users could log in to IPVideoTalk Enterprise web portal → Recordings page to View/Download/Delete the recordings for the cloud meetings/webinars:

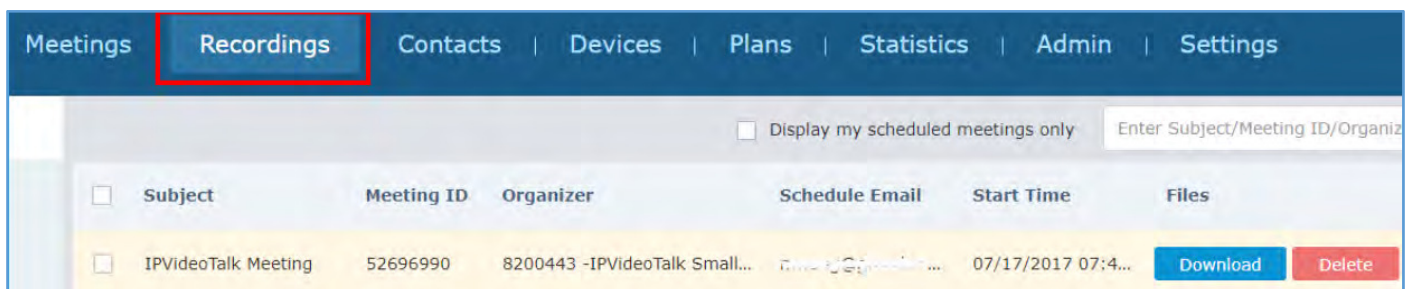

Figure 62 : IPVideoTalk Recordings

**Note:** There are some prerequisites to enable cloud recording features on GVC3210:

- GVC3210 needs to be linked with an IPVideoTalk enterprise account.
- The subscribed IPVideoTalk plan should include cloud recording support and adequate cloud storage space for recording. Please refer to IPVideoTalk website or User Manual for the latest plan information.

## Schedule



Schedule feature allows users to set a specific time to host a conference in advance, with conference reminder and members.





Figure 63: GVC3210 Schedule Screen

Follow one of the ways below to access schedule conference screen:

- On the home screen, click on CONFERENCE button .
- On the home screen, click on APPLICATION button  and select .
- Users will see the scheduled conferences (after the current time) in the schedule screen. Select one conference entry to view details.



Note:

Conferences that have been held in the past will not be displayed in the schedule screen.

### View Conference Details

Users could view scheduled conference details after the current time. Select one conference and press "OK" key on GVC3210 remote control to view conference details.







Figure 64: GVC3210 Conference Details Screen

**Add Scheduled Conference**

Follow the steps below to add a scheduled conference:

1. On the home screen, select  to access schedule screen.
2. On GVC3210 remote control, press the blue shortcut key to create a new conference.

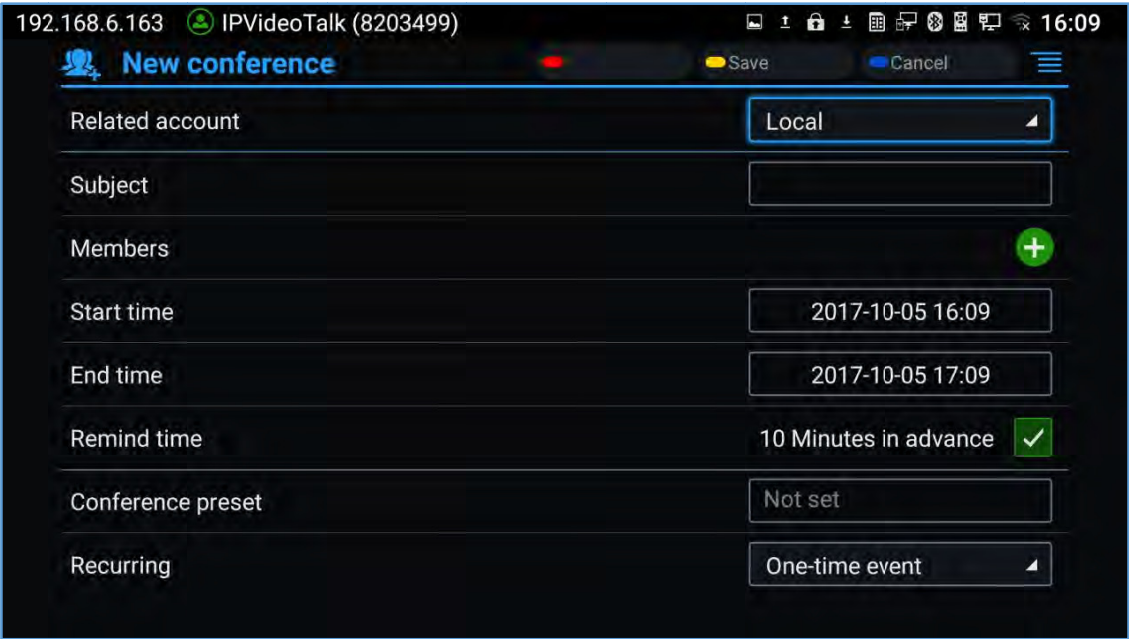



Figure 65: GVC3210 Add Conference Screen



3. Fill in conference name, members, start time, conference duration and etc.
4. Press the yellow shortcut key on the remote control to save the scheduled conference.

**Table 15: GVC3210 Add Conference Parameters**

Parameters	Descriptions
<b>Related Account</b>	Choose the related account for the conference.
<b>Subject</b>	It is used to set the conference name to identify this conference.
<b>Members</b>	Click on button  to access the Add Member screen. Users can add one member or a group of members. Press the yellow key on the remote control to save and go back to schedule screen. Up to 8 members can be added.
<b>Start Time</b>	It is used to configure the start time of the conference.
<b>End Time</b>	It is used to configure the end time of the conference.
<b>Remind Time</b>	It is used to configure whether to remind users in advanced. A prompt dialog box will pop up on GVC3210 screen 10 minutes before the conference starts.
<b>Conference preset</b>	It is used to select a camera preset when the scheduled conference starts, the GVC3210's camera will be automatically placed to the preset position. Click on Conference preset and select "Custom" to be redirected to preset setting interface to configure and set a preset. Default is "Not set".
<b>Recurring</b>	Users could select recurring for the scheduled conference, to repeat the conference depending on the chosen option. The recurring options are: <ul style="list-style-type: none"> <li>• One-time event</li> <li>• Daily</li> <li>• Every Weekday (Mon-Fri)</li> <li>• Weekly</li> <li>• Monthly (by week)</li> <li>• Monthly (by day)</li> <li>• Yearly</li> <li>• Custom</li> </ul>

### Edit Scheduled Conference



Follow the steps below to edit scheduled conference:

1. Access conference schedule screen and select the conference entry users would like to edit.
2. Press the yellow shortcut key on GVC3210 remote control to access edit screen.
3. Press the yellow shortcut key on the remote control to save changes, and go back to schedule screen.





## Reschedule Conference

1. Access schedule screen and select the conference entry users would like to edit.
2. Press the MENU key  on GVC3210 remote control, and select "Reschedule" option.
3. Set new conference start time in the pop out dialog box.
4. Click on SAVE button to save changes. If users would like to cancel the changes, users could press  on the remote control, or click on CANCEL button on the screen.

## Delete Scheduled Conference



Follow the steps below to delete the existing scheduled conference:

1. Access schedule screen and select the conference entry users would like to delete.
2. Press the MENU key  on the remote control, and select "Cancel".

## Voicemail

When there is a new voicemail, voice mail icon  will show up as a notification in the status bar. Users could login the web UI → **Settings** → **Account** → **GeneralSettings** to configure the access number for the voicemail.

Follow the steps below to access voicemail:

1. Access the dial screen and input voicemail access number.
2. Press  on GVC3210 remote control, or click on button  on the call screen to dial into the voicemail box.
3. Follow the Interactive Voice Response (IVR) for the message retrieval process.

Users could also go to **Homescreen** → **Applications** and click on "Voice Mail" to access the voicemail box. The number of new voicemail messages will be shown on the voice mail app icon as well. See figure below:



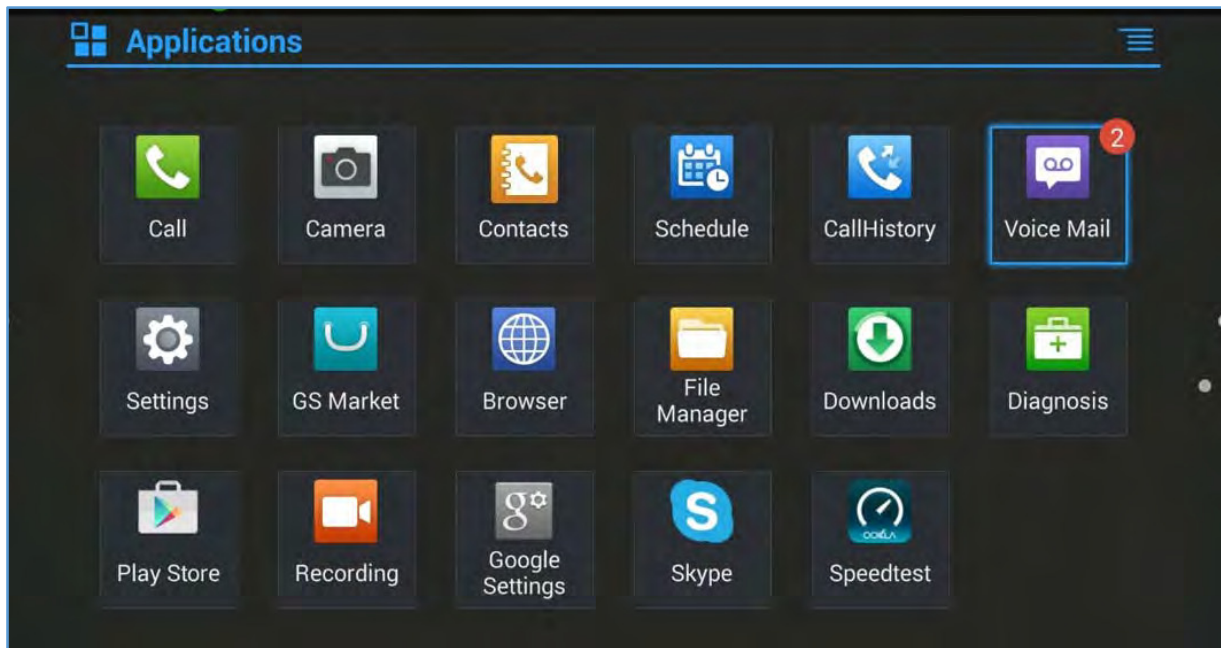

Figure 66: GVC3210Voice Mail Application

## Call Features

The GVC3210 support traditional and advanced telephony features including caller ID, caller ID with caller Name, call waiting, call forward and etc for the SIP account. Before using the following feature code, please make sure "Enable Call Features" option is set to "Yes" under web GUI→**Settings**→**SIP**→**Callpage**. Please note this feature doesn't apply to IPVideoTalk account or BlueJeans account.

Table 16: GVC3210Feature Code for SIP Account

<b>*01</b>	<p>Use Preferred Codec (per call).</p> <ul style="list-style-type: none"> <li>• Dial *01 followed by the preferred codec code and the phone number.</li> <li>• The device will use this codec in the INVITE SDP as the first codec when initiating the call.</li> <li>• <u>Codec code</u>:            PCMU: 7110            PCMA: 7111            G722: 722            G722.1: 7206            G.729AB:729            iLBC: 7201</li> </ul> <p>For example, if the user would like to use PCMA as the preferred codec to call phone number 334455, enter *017111334455. Please note the actual codec being used might be</p>
------------	--



	different, which is the negotiation result between the endpoints and SIP server.
<b>*02</b>	<p>Force Codec (per call).</p> <ul style="list-style-type: none"> <li>• Dial *02 followed by the preferred codec code and the phone number.</li> <li>• The device will be forced to use this codec during the call.</li> <li>• <u>Codec code</u>:            PCMU: 7110            PCMA: 7111            G722: 722            G722.1: 7206            G.729AB:729            iLBC: 7201</li> </ul> <p>For example, if the user would like to force using PCMA to call phone number 334455, enter *027111334455.</p>
<b>*16</b>	Enable and force SRTP for all subsequent calls.
<b>*17</b>	Disable SRTP for all subsequent calls.
<b>*18</b>	Enable SRTP per call.
<b>*19</b>	Disable SRTP per call.
<b>*30</b>	<p>Block Caller ID (for all subsequent calls).</p> <ul style="list-style-type: none"> <li>• Dial *30.</li> </ul>
<b>*31</b>	<p>Send Caller ID (for all subsequent calls).</p> <ul style="list-style-type: none"> <li>• Dial *31.</li> </ul>
<b>*50</b>	<p>Disable Call Waiting.</p> <ul style="list-style-type: none"> <li>• Dial *50.</li> </ul>
<b>*51</b>	<p>Enable Call Waiting.</p> <ul style="list-style-type: none"> <li>• Dial *51.</li> </ul>
<b>*67</b>	<p>Block Caller ID (per call).</p> <ul style="list-style-type: none"> <li>• Dial *67 followed by the phone number.</li> </ul>
<b>*82</b>	<p>Send Caller ID (per call).</p> <ul style="list-style-type: none"> <li>• Dial *82 followed by the phone number.</li> </ul>
<b>*70</b>	<p>Disable Call Waiting (per Call).</p> <ul style="list-style-type: none"> <li>• Dial *70 followed by the phone number.</li> </ul>
<b>*71</b>	<p>Enable Call Waiting (per Call).</p> <ul style="list-style-type: none"> <li>• Dial *71 followed by the phone number.</li> </ul>
<b>*72</b>	<p>Unconditional Call Forward. To set up unconditional call forward:</p> <ul style="list-style-type: none"> <li>• Dial *72 followed by the phone number to forward the call.</li> </ul>



<b>*73</b>	Cancel Unconditional Call Forward. To cancel the unconditional call forward: <ul style="list-style-type: none"><li>• Dial *73.</li></ul>
<b>*74</b>	Paging Call. <ul style="list-style-type: none"><li>• Dial *74 followed by the phone number to send the paging call.</li></ul>
<b>*83</b>	Force Audio Calling (per call). <ul style="list-style-type: none"><li>• Dial *83 followed by the phone number to send the audio call.</li></ul>
<b>*84</b>	Force Video Calling (per call). <ul style="list-style-type: none"><li>• Dial *84 followed by the phone number to send the video call.</li></ul>
<b>*90</b>	Busy Call Forward. To set up busy call forward: <ul style="list-style-type: none"><li>• Dial *90 followed by the phone number to forward the call.</li></ul>
<b>*91</b>	Cancel Busy Call Forward. To cancel the “busy call forward”: <ul style="list-style-type: none"><li>• Dial *91.</li></ul>
<b>*92</b>	Enable Call Forward No Answer. To set up Call Forward No Answer: <ul style="list-style-type: none"><li>• Dial *92 followed by the number to forward the call. The default timeout before the call is forwarded is 20 seconds.</li></ul>
<b>*93</b>	Cancel Call Forward No Answer. To cancel Call Forward No Answer: <ul style="list-style-type: none"><li>• Dial *93.</li></ul>



## ADDITIONAL FUNCTIONS

### GVC Remote Client Application

Besides using GVC3210Bluetooth remote control in the package, users could also download the Grandstream GVC Remote Client application, and install it on an Android device. GVC3210 remote control application is used via Bluetooth protocol. Follow the steps below to install the remote control application:

1. The GVC Remote apk for Android can be found under GVC3210 LCD **menu→Applications→FileManager→InternalStorage→remotefirmware**. Users could also directly send the apk file via Bluetooth to your Android device or use the QR code to download to your Android device. Please go to GVC3210 LCD **menu→Settings→Status→RemoteControl** to send GVC Remote apk to Bluetooth device or scan the QR code.

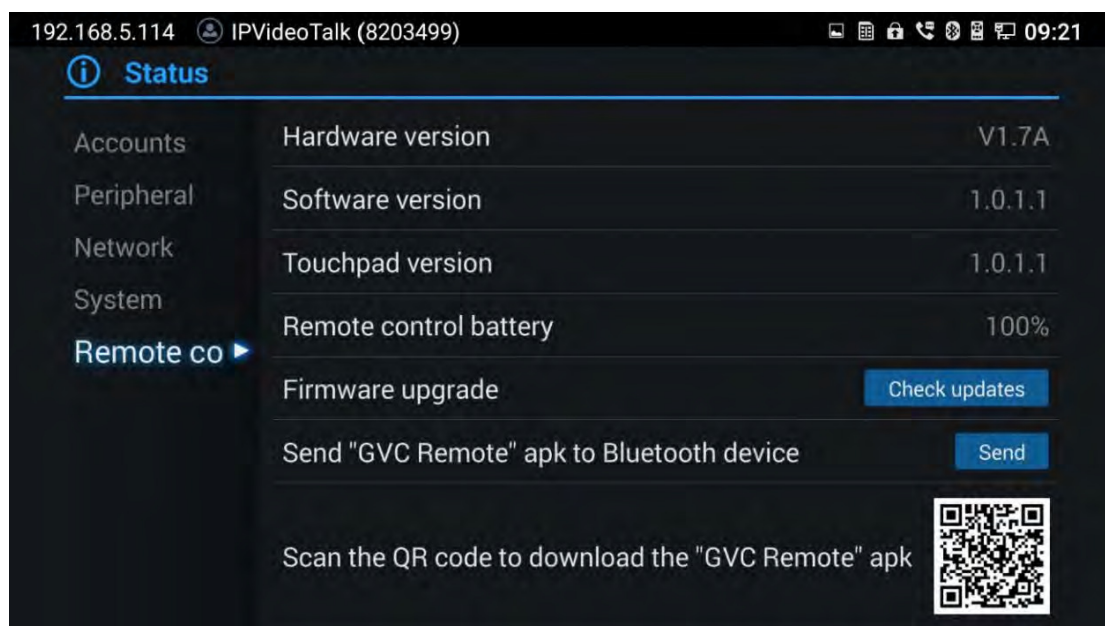

Figure 67: "GVC Remote" apk in GVC3210 LCD Menu→Settings→Status→Remote Control

2. Once GVC Remote app is installed on your Android device, open it and access settings screen.
3. Select the GVC3210 device that users would like to connect to. Each discovered GVC3210 could be distinguished by the last 6 digits of its MAC address.
4. Pair GVC Remote app with GVC3210 via Bluetooth. Users might see prompt on GVC3210, and Android device to confirm the passcode during pairing and connection process.
5. After pairing and connecting the remote control application, users can use the keys and options on the Android device touch screen to control GVC3210.



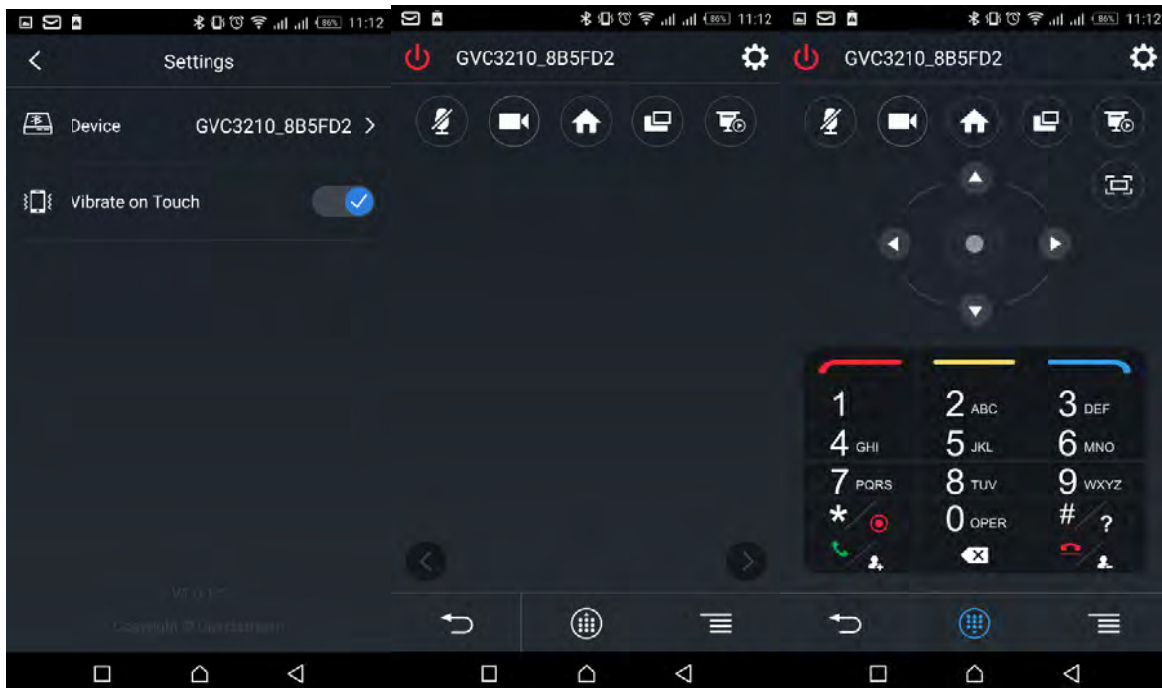







Figure 68: GVC3210Remote Control Application on Android Device

- Tap on button  at the upper right corner to access settings screen as the left figure shows above.
- Tap on button  to go back to home screen as the figure in the middle shows above.
- Tap on button  to bring up navigation panel and digital keyboard as the right figure shows above, tap on  again to hide the keyboard.

## BlueJeans

GVC3210 has built-in BlueJeans access for users to dial BlueJeans calls. Follow the steps below:

1. On the LCD dial screen, press the blue shortcut key on GVC3210 remote control to switch call mode from SIP Call to BlueJeans Call.
2. When the call mode shows BlueJeans, input Blue Jeans conference ID and conference password.
3. Press  on the remote control or click on button  on the screen to dial out.

For more information about how to use BlueJeans on GVC3210, please refer to the link below:

[http://www.grandstream.com/sites/default/files/Resources/gvc320x\\_BlueJeans\\_application\\_note.pdf](http://www.grandstream.com/sites/default/files/Resources/gvc320x_BlueJeans_application_note.pdf)





## APPLICATIONS

GVC3210 provides built-in applications such as Contacts, Call History, File Manager, Browser and etc. Users could also download the apps from GS market or Google Play Store to install on GVC3210.

### Contacts

GVC3210 Contacts app helps users to easily store and manage phone numbers and contacts information. Users can add contacts on GVC3210 or import contacts from external devices as well as download from a server.

On GVC3210 home screen, click on Contacts icon  or go to Applications, and select  to access contacts app.

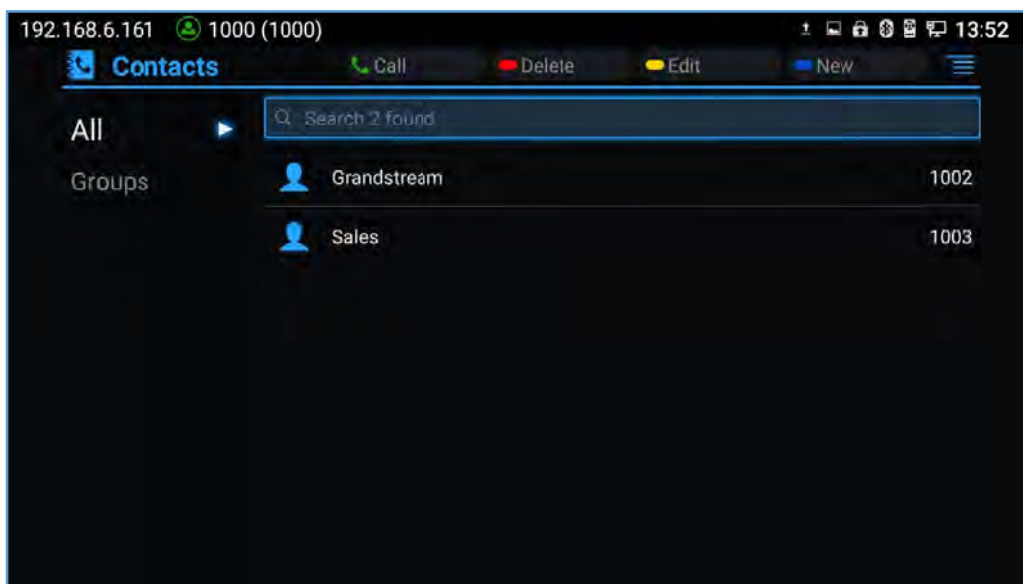



Figure 69: GVC3210 Contacts Screen

- **All**  
It is used to display all contacts.
- **Groups**  
It is used to view groups. Select one group to view group details.
- **Call**  
Select the contact, and press  on GVC3210 remote control or click on button  to dial the contact users would like to call.
- **Delete**





Press the red shortcut key on the remote control to delete contacts.

- **Edit**

Press the yellow shortcut key on the remote control to edit contacts.

- **Add**

Press the blue shortcut key on the remote control to access New Contact screen, fill in contact information and press the yellow shortcut key on the remote control to save it.

- **Menu**

Press  on the remote control to access menu to edit/add/delete/export/import/download contacts.

- **Contact Details**

Select one contact and press "OK" key on the remote control to view contact details.

## Add Contact

### Add Single Contact

Follow the steps below to add one single contact:

1. Press the blue shortcut key on GVC3210 remote control to access New Contact screen.

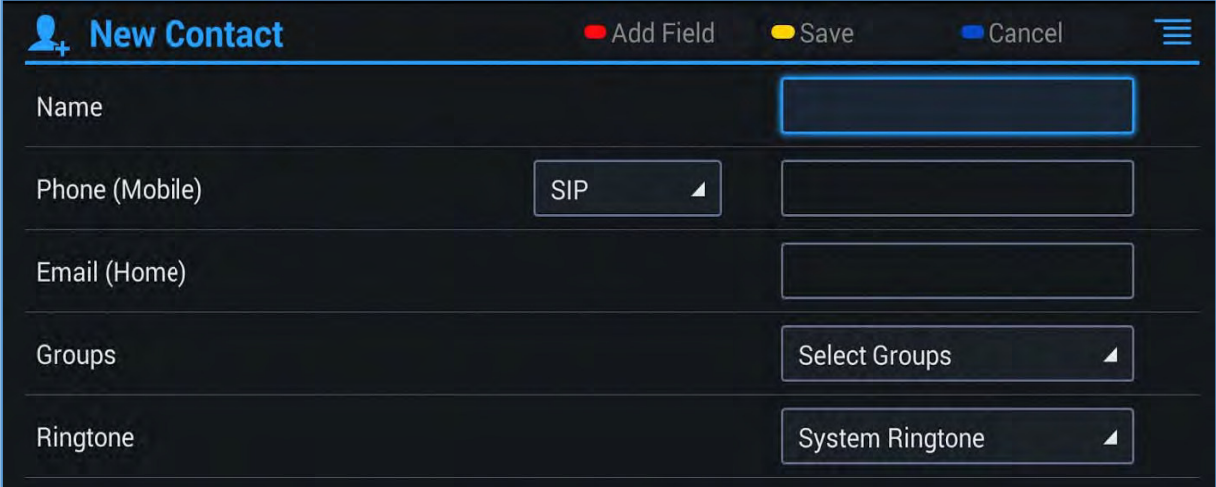

Figure 70: GVC3210 Add New Contact Screen

2. Enter the contact information.
3. Press the red shortcut key to add more fields.
4. Press the yellow shortcut key to save the contact information.

### Batch Import Contacts

Import function allows users to batch import contacts. The phonebook with compatible format needs to be saved to the storage devices like Micro SD card/USB flash drive and plugged into GVC3210.





1. Press the MENU key on Contacts screen, and select "Import" to access Import Contacts screen.



Figure 71: GVC3210 Import Contacts Screen

2. Configure parameters and select the path to save the imported file.
3. Press the yellow shortcut key to save the contact information.

Table 17: GVC3210 Import Contacts Parameters

Parameters	Descriptions
<b>Clear The Old List</b>	If it is enabled, the previous contact records will be deleted when a new phonebook file is loaded into the device. If it is disabled, both the old contacts and new contacts will be kept in GVC3210.
<b>Replace Duplicate Entries</b>	If it is enabled, when the phonebook file is imported to the device, the duplicated entries will be removed. If it is disabled, both the old contacts and new contacts will be kept in GVC3210.
<b>File Encoding</b>	Select the encoding format for XML contact file.
<b>File Type</b>	Select the file format for phonebook file import. The device supports xml, csv and vcard format.
<b>Select The File</b>	Select file from storage device plugged into GVC3210.

### Download Contact

GVC3210 supports downloading phonebook from the file server to batch add contacts. The default file name that GVC3210 looks for is "phonebook.xml". The phonebook XML file should be placed under the file server directory for GVC3210 to retrieve. GVC3210 supports vcard/xml/csv file format.



1. On the Contacts screen, tap on the MENU key and select "Download" to bring up the Download Contacts screen.

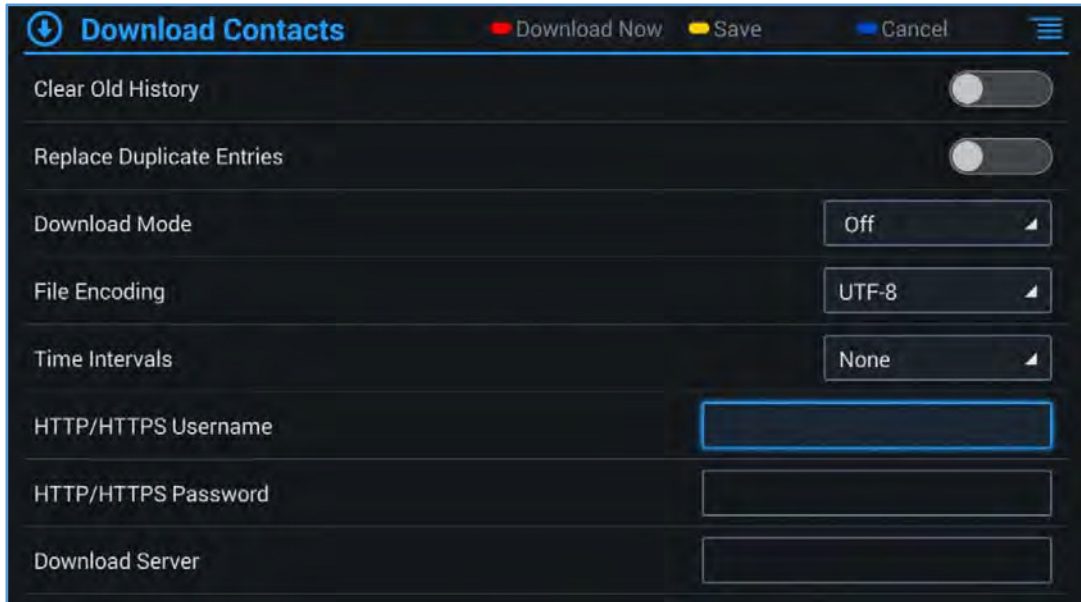

Figure 72: GVC3210 Download Contacts Screen

2. Configure parameters and select the path to save the file.
3. Press the red shortcut key to download the file.

Table 18: GVC3210 Download Contacts Parameters

Parameters	Descriptions
<b>Clear The Old List</b>	If it is enabled, the previous contact records will be deleted when a new phonebook file is loaded into the device. If it is disabled, both the old contacts and new contacts will be kept in GVC3210.
<b>Replace Duplicate Entries</b>	If it is enabled, when the phonebook file is imported to GVC3210, the duplicated entries will be removed. If it is disabled, both the old contacts and new contacts will be kept in GVC3210.
<b>Download Mode</b>	Select the phonebook download mode from TFTP, HTTP or HTTPS.
<b>File Encoding</b>	Select the encoding format for the XML contact file.
<b>Time Intervals</b>	Configure the time interval to download XML contact file.
<b>HTTP/HTTPS Username</b>	Configure the HTTP/HTTPS username for phonebook downloading if it's required by the server.
<b>HTTP/HTTPS Password</b>	Configure the HTTP/HTTPS password for phonebook downloading if it's required by the server.
<b>Download Server</b>	Fill in the server URL or IP address to download the XML contact file to the device.



## Search Contacts

In the Contacts app, users could input keyword to search in the dialog. GVC3210 will display contacts automatically which is related to the search keyword. Fuzzy search and precise search are both supported.

## Manage Contacts

### Delete Contact

1. Access Contacts screen and select the contact users would like to delete.
2. Tap on  and select "Delete" option or press the red shortcut key in order to delete the contact.

### Batch Remove Contacts

To delete more than one contacts,

1. Select "Batch Remove" option.
2. Select the checkbox for the contacts to be deleted, and press the red shortcut key on GVC3210 remote control to delete them. Users could also press the yellow shortcut key on the remote control to select all contacts at once.

### Export Contacts

GVC3210 supports exporting phonebook as vcard/xml/csv files, and save the files to other external storage devices.

1. Press the MENU key on Contacts screen to bring up the Export Contacts screen.

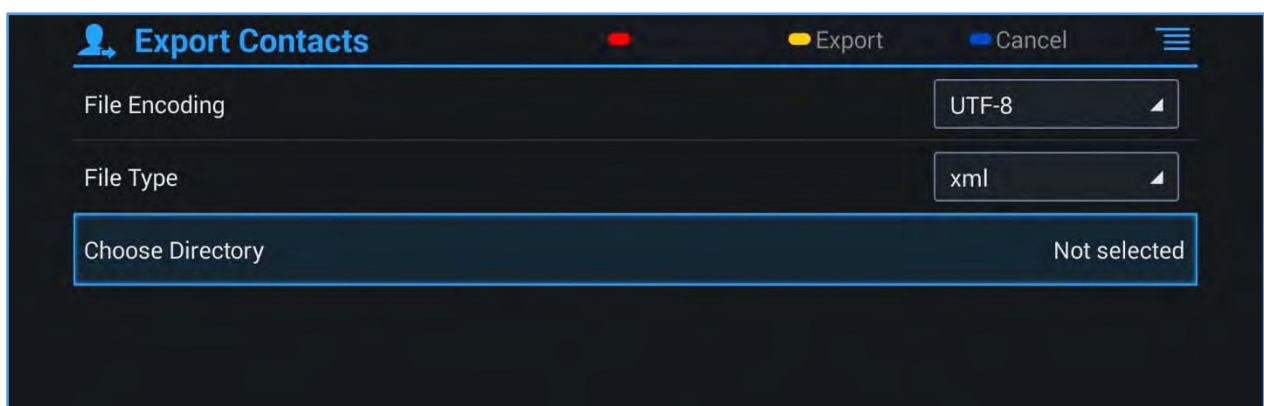

Figure 73: GVC3210 Export Contacts Screen

2. Configure parameters as shown in table below and select the directory to save the exported file.
3. Press the yellow shortcut key to export the file.



Table 19: GVC3210 Export Contacts Parameters

Parameters	Descriptions
<b>File Encoding</b>	Select the encoding format for XML contact file.
<b>File Type</b>	Select the file format for phonebook file export. The device supports xml, csv and vcard.
<b>Choose Directory</b>	Select directory to save file.

## Groups

Users could divide contacts into different groups with specific names. Select one group entry and press "OK" key to view group details.

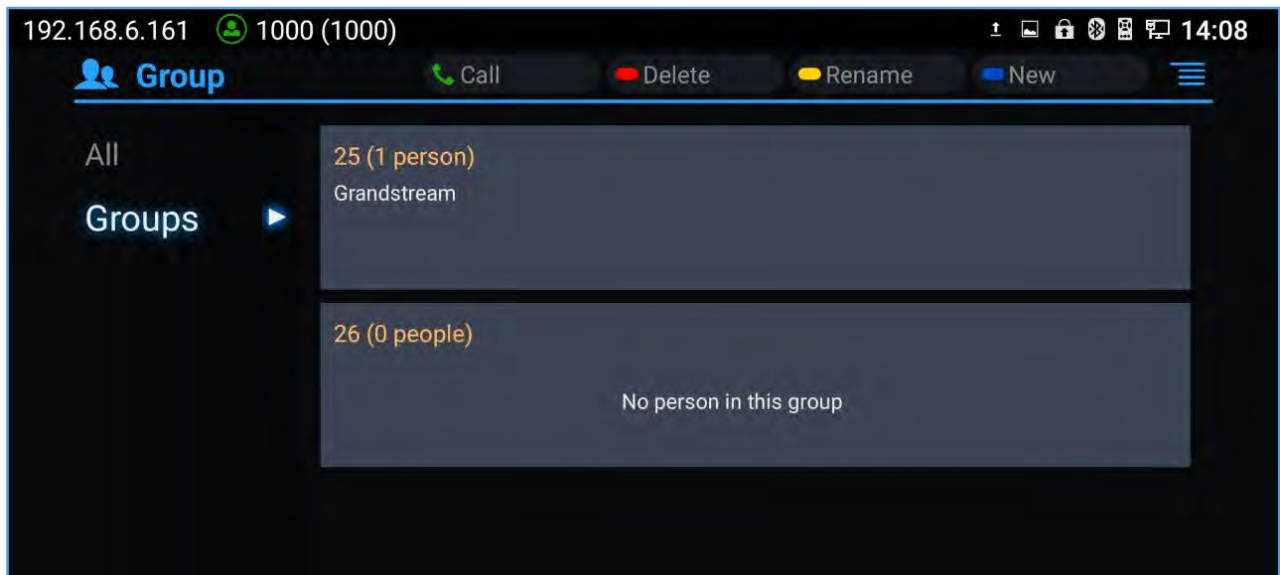



Figure 74: GVC3210 Groups Screen

- **Call**  
Press  on GVC3210 remote control to call the first 8 members in a group to initiate a conference.
- **Delete (red shortcut key)**  
It is used to rename a group.
- **Rename (yellow shortcut key)**  
It is used to delete a group.
- **New (blue shortcut key)**  
It is used to add a group.



## Add New Group

1. Select Groupstabin Contacts screen.
2. Press the blue shortcut key on GVC3210 remote control to bring up the screen below:



Figure 75: GVC3210 Add Group Screen

3. Input a group name and tap on "OK" to add a new group.
4. Go to Contacts Screen to find the group you just added and access it.
5. Press the yellow shortcut key on the remote control to access Groups editing screen.
6. Select the contacts users would add to this group.
7. Press the blue shortcut key on GVC3210 remote control to save the operations.

## Delete Group

Follow the steps below to delete groups.

1. Select Groups on Contacts screen.
2. Select the group users would like to delete.
3. Press the red shortcut key to bring up the dialog box.
4. Press "OK" key to delete.



## LDAP contacts

LDAP contacts application can be accessed in GVC3210 display device LCD→**Applications**→**LDAPContacts**. It helps users access and manage the contacts at ease.

Here is the main interface of LDAP contacts.

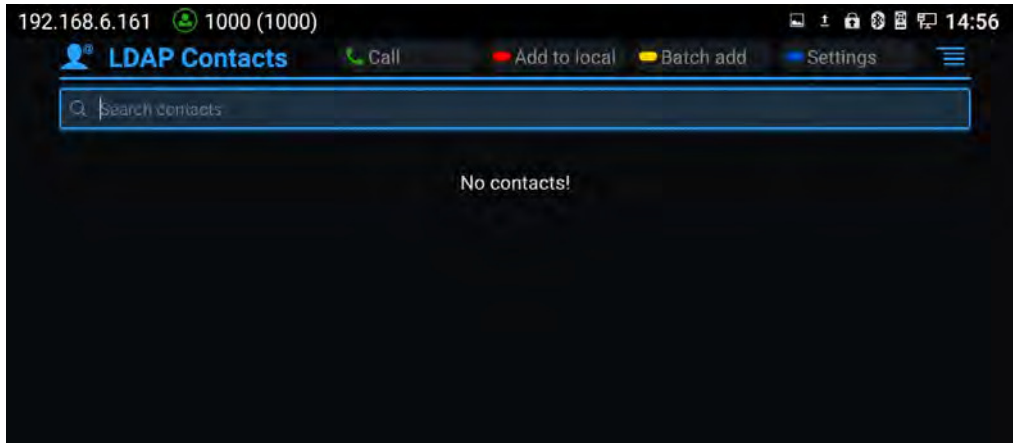

Figure 76: LDAP Contacts Interface

## LDAP Settings

Before starting using LDAP on GVC3210, the users must configure the LDAP settings first. Press the Blue shortcut key on the GVC3210 remote control to access LDAP settings, or the users can configure it under GVC3210 web UI→**Contacts**→**LDAP** page.

Table 20: GVC3210LDAP Settings Parameters

<b>Connection Mode</b>	It is used to select which protocol will be used for LDAP searching, LDAP or LDAPS.
<b>Server Address</b>	It is used to configure the URI of the LDAP (Lightweight Directory Access Protocol) server.
<b>Port</b>	It is used to configure the LDAP server port. The default LDAP port number is 389.
<b>Base DN</b>	It is used to configure the LDAP search base. This is the location in the directory where the search is requested to begin. Example: dc=grandstream, dc=com ou=Boston, dc=grandstream, dc=com
<b>User Name</b>	It is used to configure the bind "Username" for querying LDAP servers. Some LDAP servers allow anonymous binds in which case the setting can be left blank.



<b>Password</b>	It is used to configure the bind "Password" for querying LDAP servers. The field can be left blank if the LDAP server allows anonymous binds.
<b>LDAP Name Attributes</b>	It is used to configure the "name" attributes of each record which are returned in the LDAP search result. This field allows the users to configure multiplespace separated name attributes. Example: gn cn sn description
<b>LDAP Number Attributes</b>	It is used to configure the "number" attributes of each record which are returned in the LDAP search result. This field allows the users to configure multiple space separated number attributes. Example: telephoneNumber telephoneNumber Mobile
<b>LDAP Mail Attributes</b>	It is used to configure the "mail" attributes of each record which are returned in the LDAP search result. Example: mail
<b>LDAP Name Filter</b>	It is used to configure the filter used for name lookups. Examples: ((cn=%)(sn=%)) returns all records which has the "cn" or "sn" field starting with the entered prefix; (!(sn=%)) returns all the records which do not have the "sn" field starting with the entered prefix; (&(cn=%) (telephoneNumber=*)) returns all the records with the "cn" field starting with the entered prefix and "telephoneNumber" field set.
<b>LDAP Number Filter</b>	It is used to configure the filter used for number lookups. Examples: ((telephoneNumber=%)(Mobile=%)) returns all records which has the "telephoneNumber" or "Mobile" field starting with the entered prefix; (&(telephoneNumber=%) (cn=*)) returns all the records with the "telephoneNumber" field starting with the entered prefix and "cn" field set.
<b>LDAP Mail Filter</b>	It is used to configure the filter used for mail lookups. Example: (mail=%)
<b>LDAP Displaying Name Attributes</b>	It is used to configure the entry information to be shown on phone's LCD. Up to 3fields can be displayed. Example: %cn %sn %telephoneNumber





<b>Max Hits</b>	It is used to configure the maximum number of results to be returned by the LDAPserver. If set to 0, server will return all search results. The default setting is 50.
<b>Search Timeout (ms)</b>	It is used to configure the interval (in seconds) for the server to process the requestand client waits for server to return. The default setting is 30 seconds.
<b>LDAP Lookup When Dialing</b>	It is used to set if allow the phone system to do the LDAP number searching when making outgoingcalls. The default setting is "No".
<b>Search LDAP For Incoming Call</b>	It is used to set if allow the phone system to do LDAP number searching for incoming calls. The default setting is "No".

Here is an example configuration on GVC3210 LDAP settings in web UI. The LDAP server is the built-in LDAP server in Grandstream UCM6xxx.

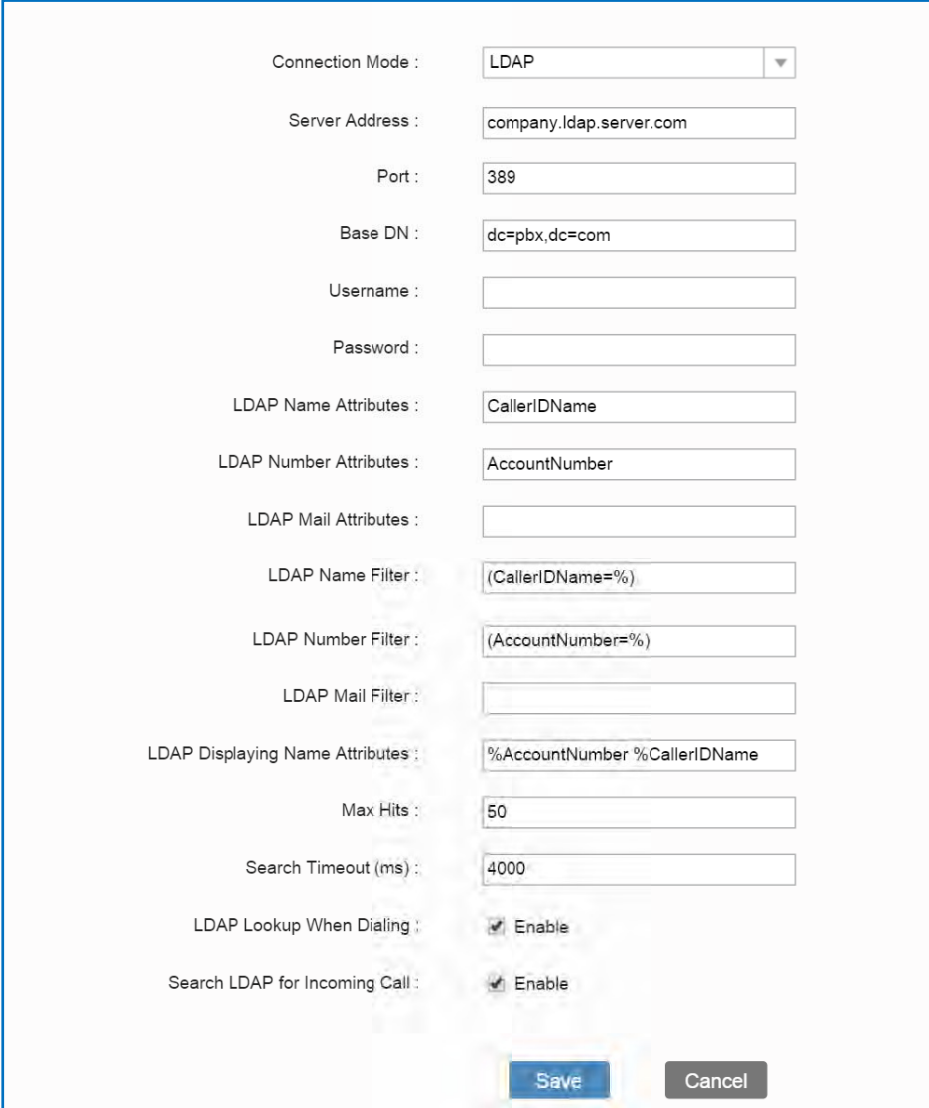

Connection Mode : LDAP  
 Server Address : company.ldap.server.com  
 Port : 389  
 Base DN : dc=pbx,dc=com  
 Username :  
 Password :  
 LDAP Name Attributes : CallerIDName  
 LDAP Number Attributes : AccountNumber  
 LDAP Mail Attributes :  
 LDAP Name Filter : (CallerIDName=%)  
 LDAP Number Filter : (AccountNumber=%)  
 LDAP Mail Filter :  
 LDAP Displaying Name Attributes : %AccountNumber %CallerIDName  
 Max Hits : 50  
 Search Timeout (ms) : 4000  
 LDAP Lookup When Dialing :  Enable  
 Search LDAP for Incoming Call :  Enable  
 Save Cancel

**Figure 77: LDAP Settings Example in Web UI**





## Search LDAPContacts

After configuring LDAP settings, the users could search contacts in LDAP Contacts main interface. In the following example, the users could enter number or name in the Search field. The LDAP result will be displayed dynamically when the key word is entered.

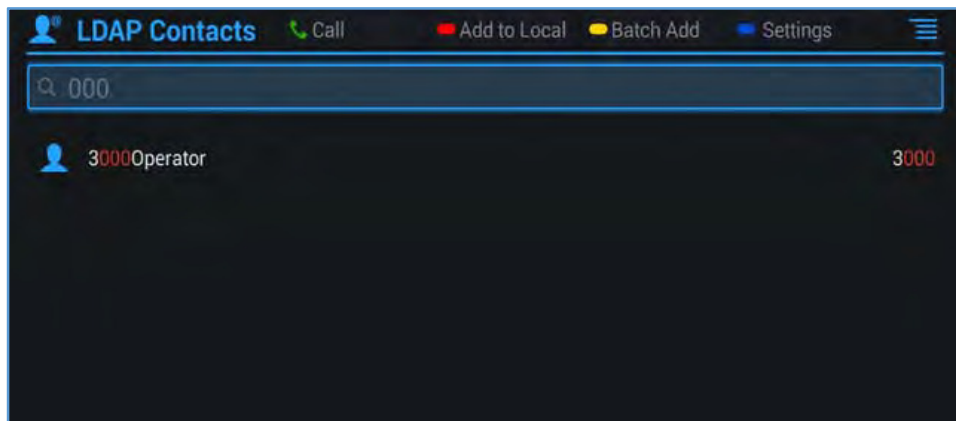



Figure 78: Search LDAP Contacts

If the user presses the Green Call button  on the GVC3210 remote control, the GVC3210 will initiate a call to this contact.

## Add Search Result into Local Contacts

After performing LDAP search, the users could select to add the result into GVC3210 local contacts.

- **Add to Local**

On the search result screen, move the selection to the contact, then press the red shortcut key on the GVC3210 remote control to add single search result to local contacts. Click on OK to confirm Add to Local.

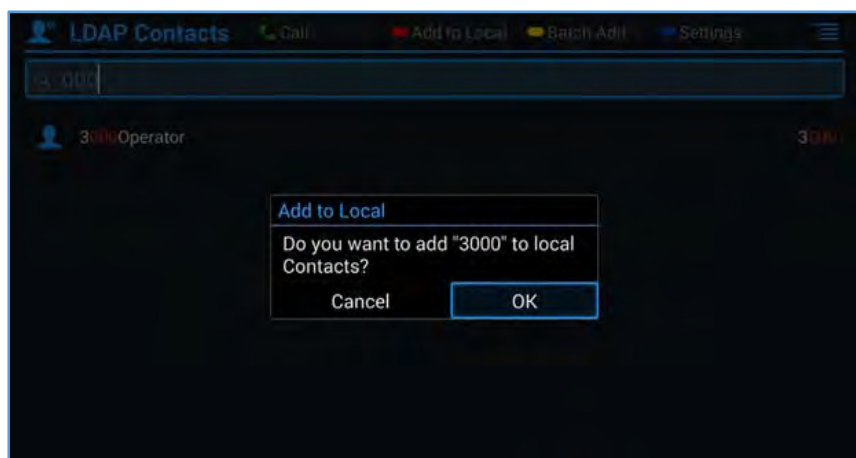

Figure 79: Add LDAP Search Result to Local Contacts



- **Batch Add**

Press the yellow shortcut key on the GVC3210 remote control, then select the checkbox for multiple search results to be added into local contacts. Press the yellow shortcut key again and the following prompt will pop up. Click on OK to confirm Batch Add.

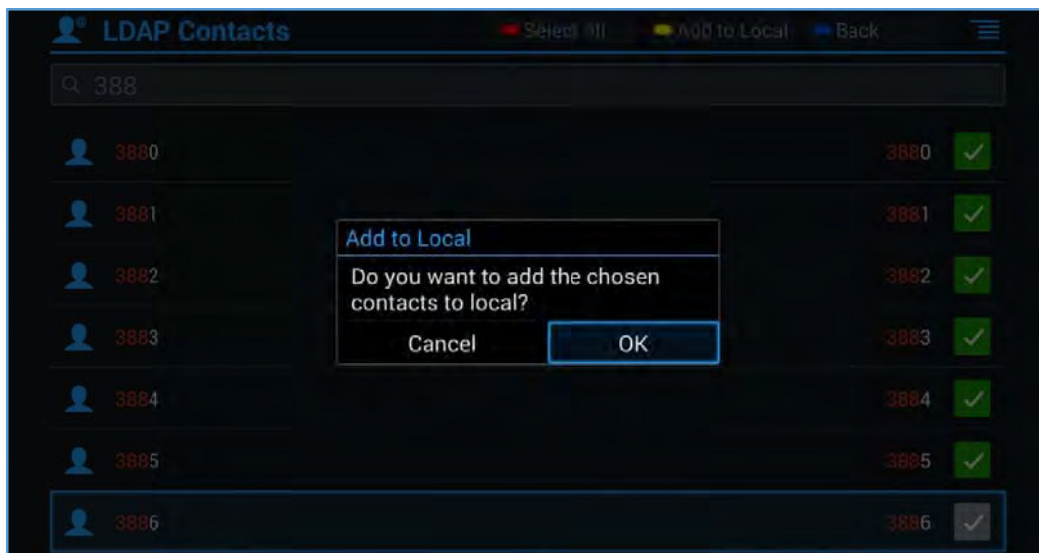



Figure 80: Batch Add LDAP Search Results to Local Contacts

## Call History

Call History provides users access to phone's recent call records. Users can view all records, or select different categories for incoming calls, outgoing calls, missed call and conference.

To access Call History, go to Home screen → **Applications** → .

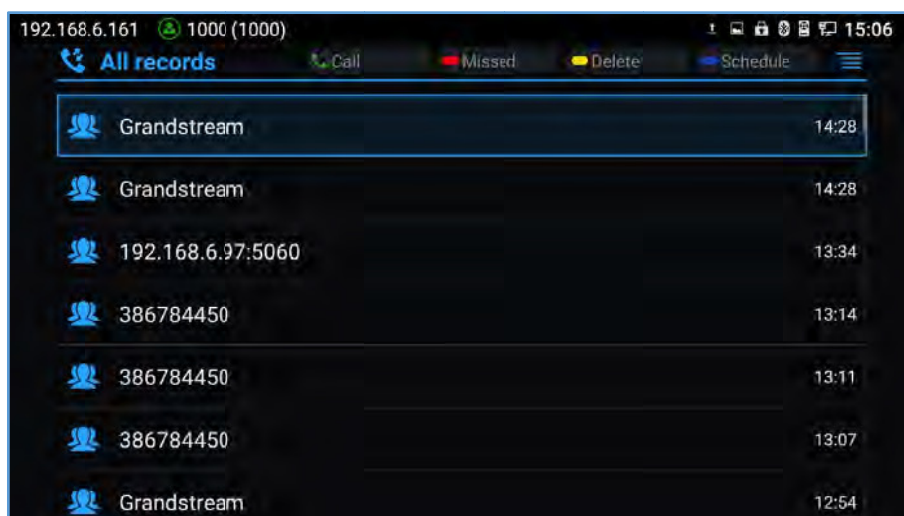

Figure 81: GVC3210 Call History Screen





Click on a record in the call history and press  to dial out this number directly. Press "OK" key on GVC3210 remote control to view call details for this number.



Figure 82: GVC3210 Call History Details



**Note:**

Call history displays all Blue Jeans conference call histories as well. Press "OK" key or  to dial out directly, and there is no need to input the password again. However, if the conference does not exist or the password has been changed, the re-dial will fail.

If an entry in call history already exists in GVC3210 Contacts, when the user clicks on the upper right Menu button  on the Call History screen, the users can see and select "View contact" option in the drop-down list to view the details for this contact.

### Add Contact from Call History

1. Access Call History screen.
2. Select one call history entry.
3. Tap on  and select "Add contact" option to bring up the dialog box.
4. Confirm to add the contacts.



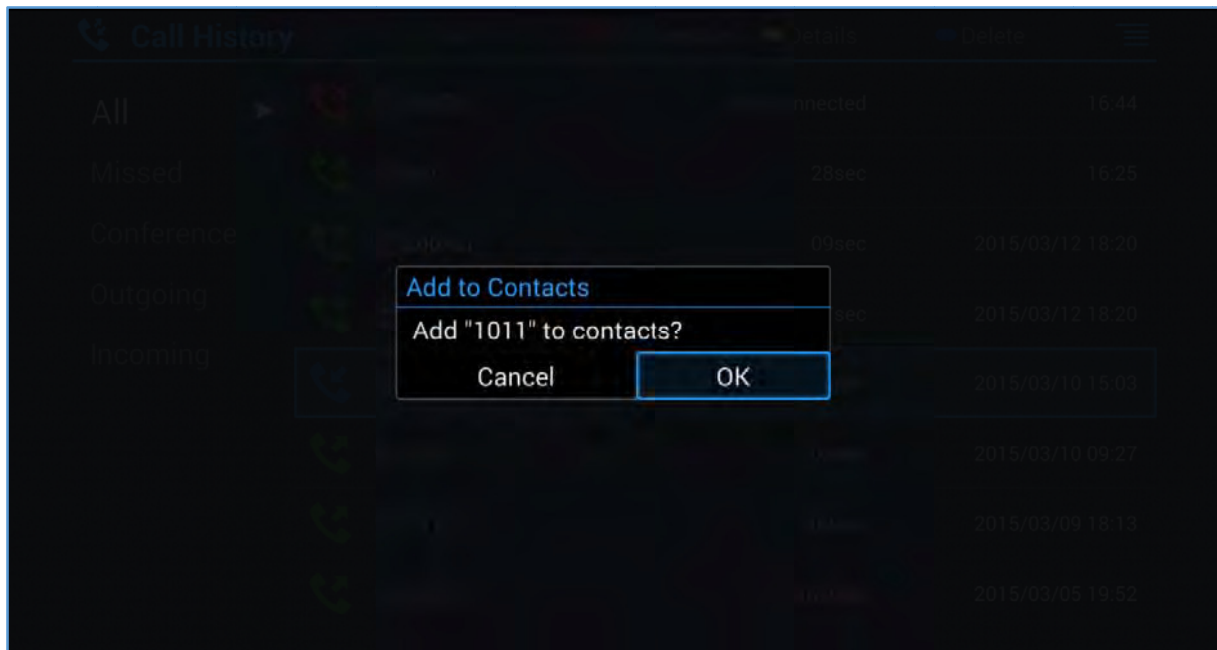

Figure 83: GVC3210 Add Contact Screen

5. Select existing contact or press the blue shortcut key on GVC3210 remote control to access edit screen.
6. Fill in contact information and press the yellow shortcut key on the remote control to save the contact.

### Delete Call History

1. Select the call history entry.
2. Press the yellow shortcut key on GVC3210 remote control to bring up the dialog box.
3. Confirm to delete.

### Conference Schedule via Call History

1. Select one call history entry users would like to add to scheduled conference.
2. Press the blue shortcut key on GVC3210 remote control to access schedule screen.
3. Fill in information and press the yellow shortcut to save.

### FileManager

FileManager allows users to delete, move, copy, paste, send, rename files (including files on storage device such as USB flash drive and Micro SD card), and query file properties on GVC3210.



## Copy File

To copy the file from GVC3210 to USB/SD storage device:

1. Insert USB/SD storage device into USB port on GVC3210. It will take a few seconds for GVC3210 to prepare the connection.
2. The USB storage icon will show up on the status bar.
3. Go to Home screen→**Applications**→**FileManager**.
4. Open the target folder.
5. Press the yellow shortcut key and select the file.
6. Press the blue shortcut key to copy file and press  to go back to the upper level directory.
7. Select target storage device and go to the directory where the file will be pasted to.
8. Press the yellow shortcut key to paste the file.

Users can also select file and press the blue shortcut key to copy one single file or folder.

## Send File

1. Go to Home screen→**Applications**→**File Manager**.
2. Open the target folder.
3. Press the yellow shortcut key and select the file.
4. Press MENU key  on GVC3210 remote control and select "Send" option.
5. Select target location and press "OK" key on GVC3210 remote control to send file. If users need to send the file via Bluetooth, enable and connect Bluetooth device first. Otherwise, the interface will be redirected to the corresponding setting page to configure.

Users can also select file and press the MENU key to send one single file or folder.

## Delete File

1. Go to Home screen→**Applications**→**File Manager**.
2. Open the target folder.
3. Press the yellow shortcut key and select the file.
4. Press the red shortcut key.
5. A dialog will pop out for users to confirm whether to delete the file or not.
6. Press "OK" key to delete the file successfully.

Users can also select file and press the red shortcut key to delete one single file or folder.



## Rename File

1. Go to Home screen→**Applications**→**File Manager**.
2. Open the target folder.
3. Press the yellow shortcut key and select the file.
4. Press MENU key  on GVC3210 remote control and select "Rename".
5. Input the new file name in the pop out dialog and press "OK" key to save.

Press  on GVC3210 remote control to cancel the operation.

## Recording

GVC3210 recording application is used for the storage of call recording files in video conferencing. Users can play, export, lock/unlock, send, rename or delete these recordings and etc. The recording screen is as shown below:

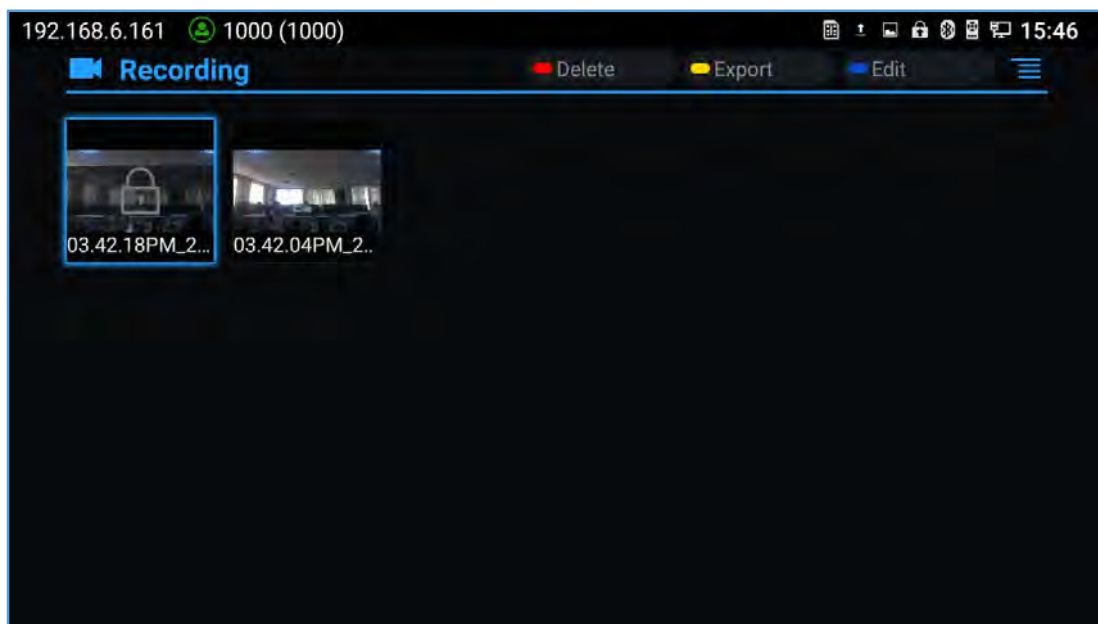



Figure 84: GVC3210 Recording Screen

- Press "OK" key to play recording.
- Press the red shortcut key to delete the chosen recording file.
- Press the yellow shortcut key to export the recording files to the external storage device.
- Press the blue shortcut key to edit (select) recordings.
- Press the MENU key to make other operations to recording files like export, rename, and lock/unlock.



## Recording Settings

Users can change the default save path for recording to internal storage, a plugged Micro SD card or USB storage device:

1. Go to Home screen→**Applications**→**Recording**.
2. Press the MENU key  on remote control and select “Settings”.
3. Plug in external Micro SD card or USB storage device.
4. Press the yellow shortcut key to choose the path of the recordings (Micro SD Card or Flash USB).
5. Press the blue shortcut key to choose the preferred format of your recordings (mkv or mp4).

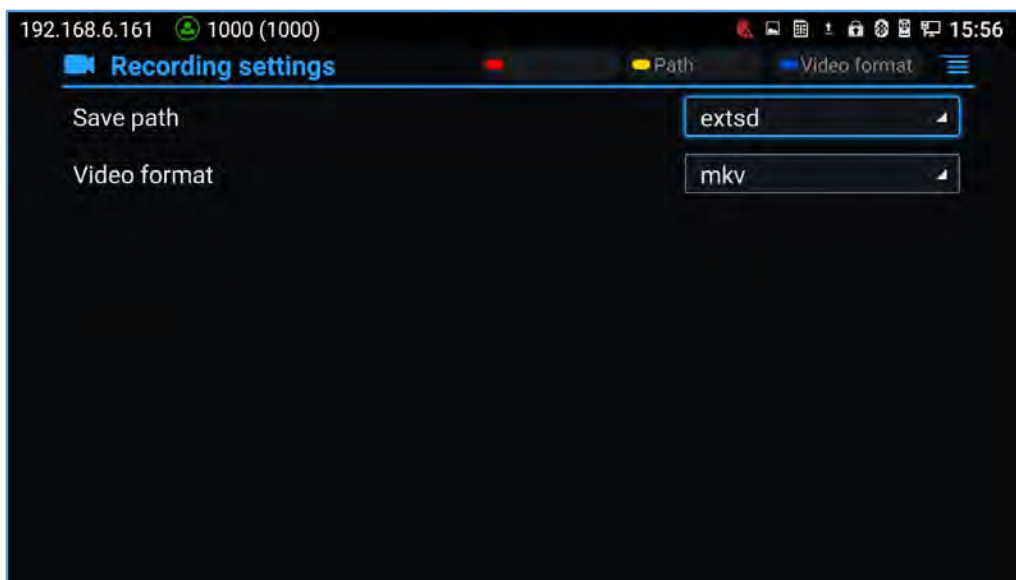

Figure 85: GVC3210Recording Settings



### Note:

- The locked files can't be deleted or overwritten, and cannot be shown in the third-party application, but can be viewed in GVC3210 video application.
- When the recording size exceeds 1.9G, the GVC3210 will create a new file automatically to continue recording. There will be a prompt to indicate the storage space is insufficient if the disk storage is full.

## Setup Wizard

GVC3210 offers a Setup Wizard tool to guide users into configuring their units step by step, the setup wizard appears automatically at factory reset, or it can be accessed anytime from LCD





menu→Applications→SetupWizard.

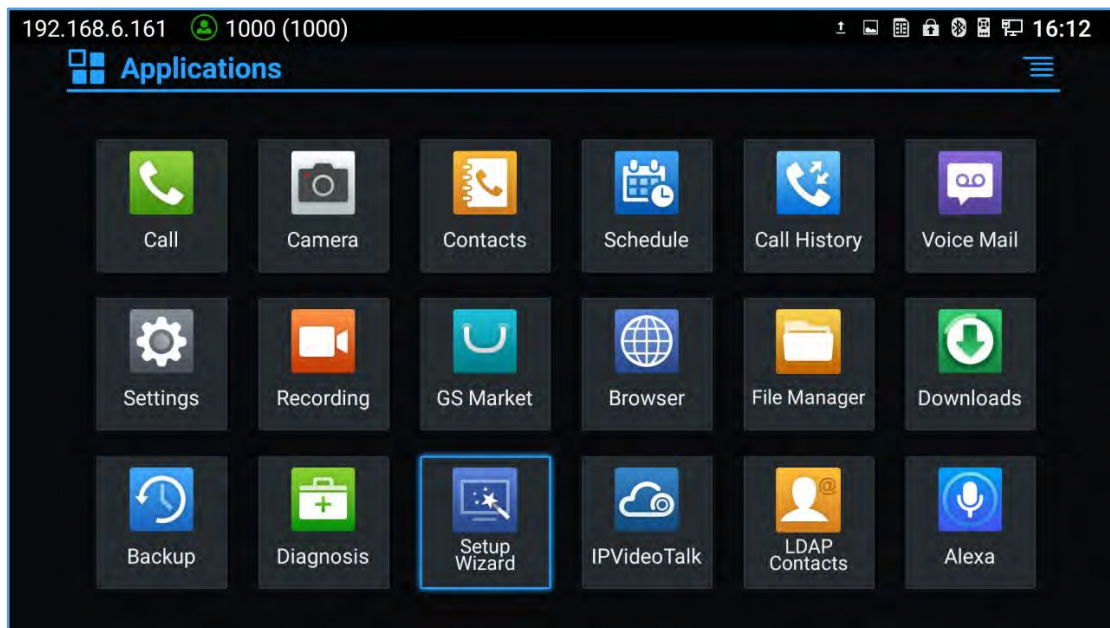

**Figure 86: Applications→Setup Wizard**

Users can follow the steps using the remote control to setup fields, skip, return, or confirm the action. Setup wizard tool is useful to lead users to check and configure the GVC3210 settings such as language, accounts, interface status and etc.





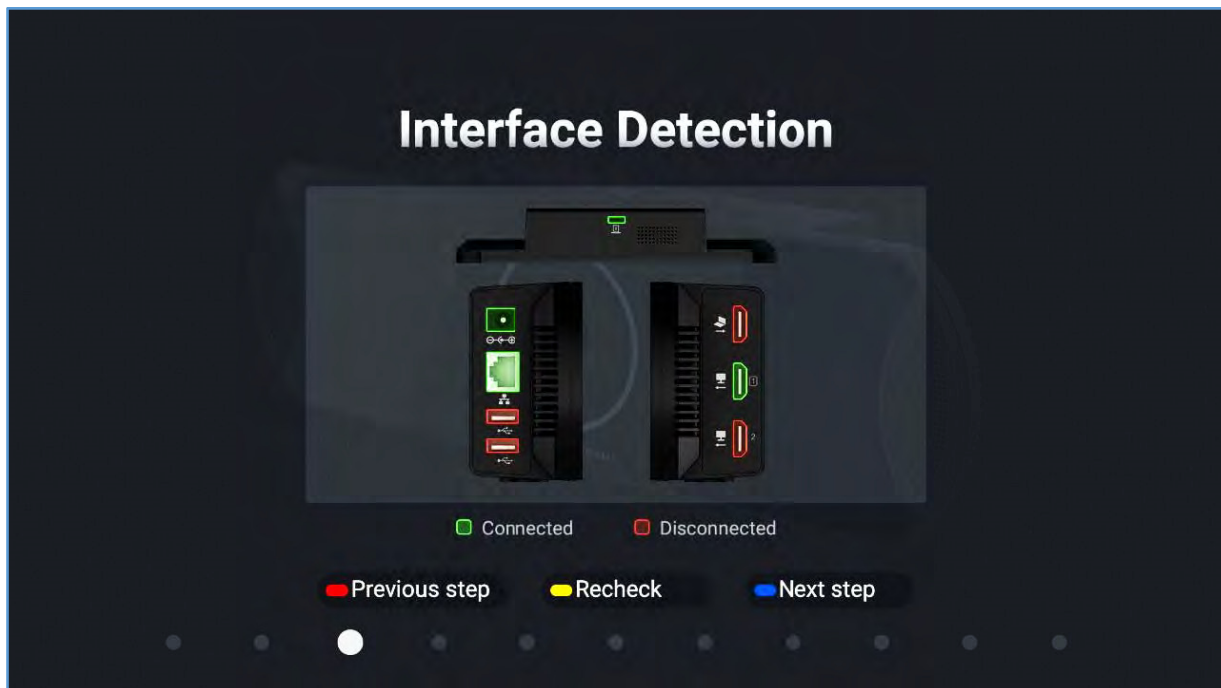

Figure 87: Interface Detection

## Backup

### Backup Data

GVC3210Backup application is used to backup data or import backup files to restore data. It can be accessed from Home **screen**→**Applications**→**Backup**. The default screen will list available backup files (if any) and backup options.



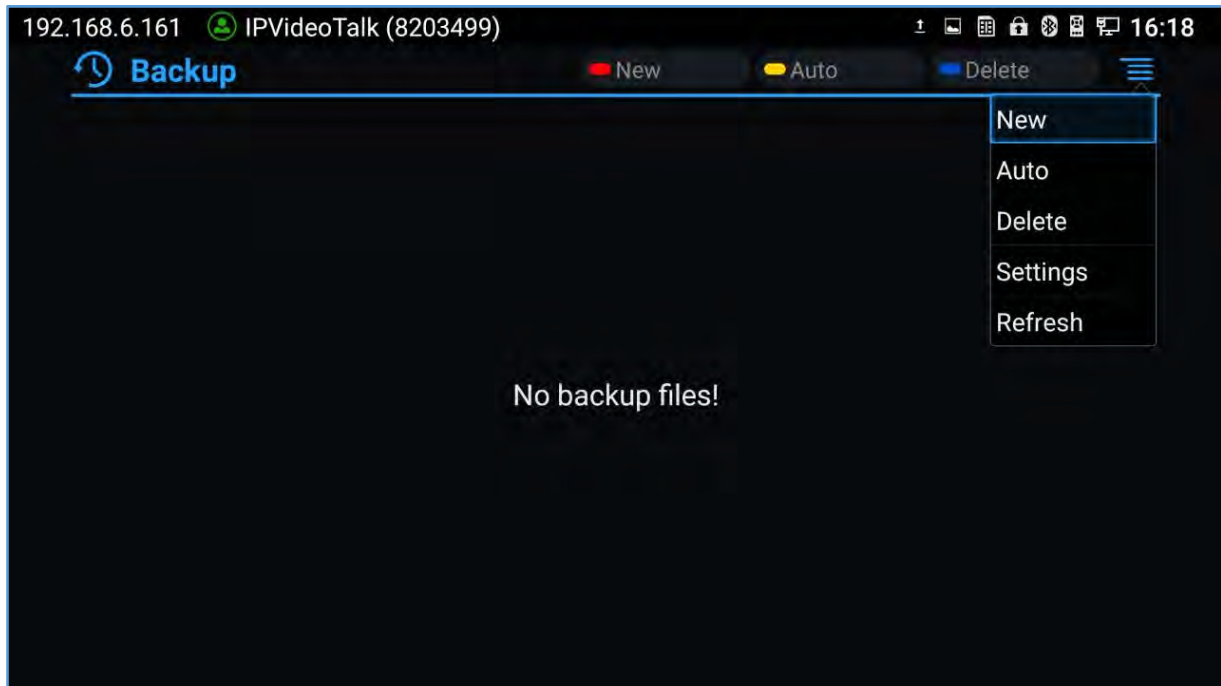

Figure 88: GVC3210Backup App

GVC3210 supports manual backup and automatic backup:

- Press the red shortcut key on the remote control to create new backup manually. The user will select data and press the blue shortcut key to start backup.
- Press the yellow shortcut key on the remote control to access automatic backup. Then configure each parameter for automatic backup.



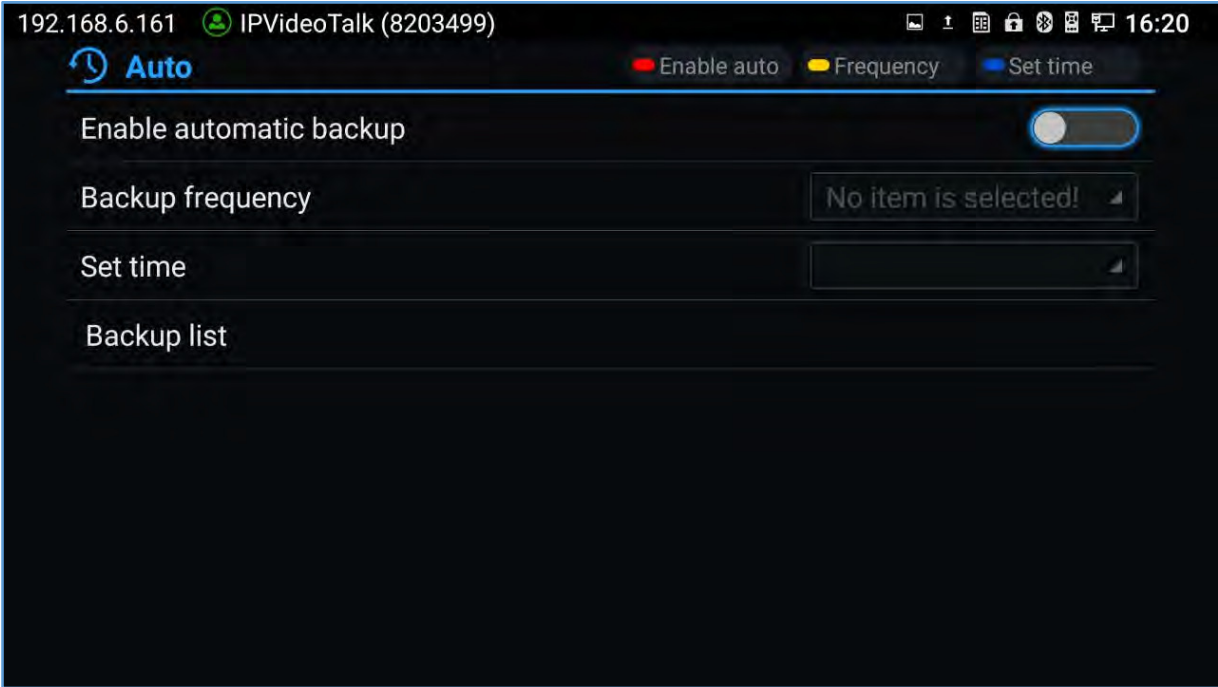

Figure 89: GVC3210 Automatic Backup Screen

**Note:** Users have also the option to choose which commonly used apps need to be backed up, such as contacts, call history.



Figure 90: Backup Commonly Used Apps



## Restore Backup Data

Select one backup data and press "OK" key to access restore screen, select data and press the blue shortcut key to restore the backup data.

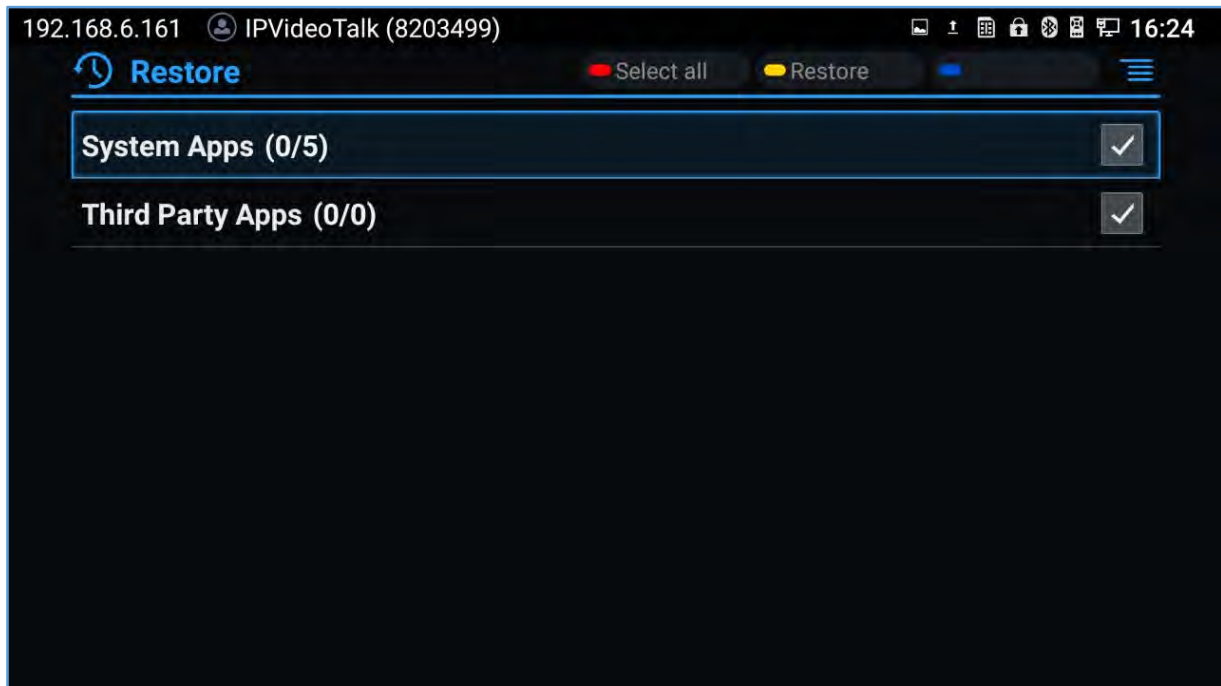

Figure 91: GVC3210 Restore Backup Data Screen

## Set Backup Path

Press the MENU key and select "Settings" on backup screen to access settings screen, set backup path and go back to save automatically.



### Note:

Insert Micro SD card or USB flash drive to the GVC3210 before configuring backup path.

## Diagnosis

When troubleshooting GVC3210, users could go to GVC3210home screen→**Applications**→**Diagnosis**



Tap on the option and follow the instructions on each function to perform Camera Test, Remote Control Key Test, Built-in Speaker Test and etc. During the test, users could press the BACK key or follow the prompt to exit the test.



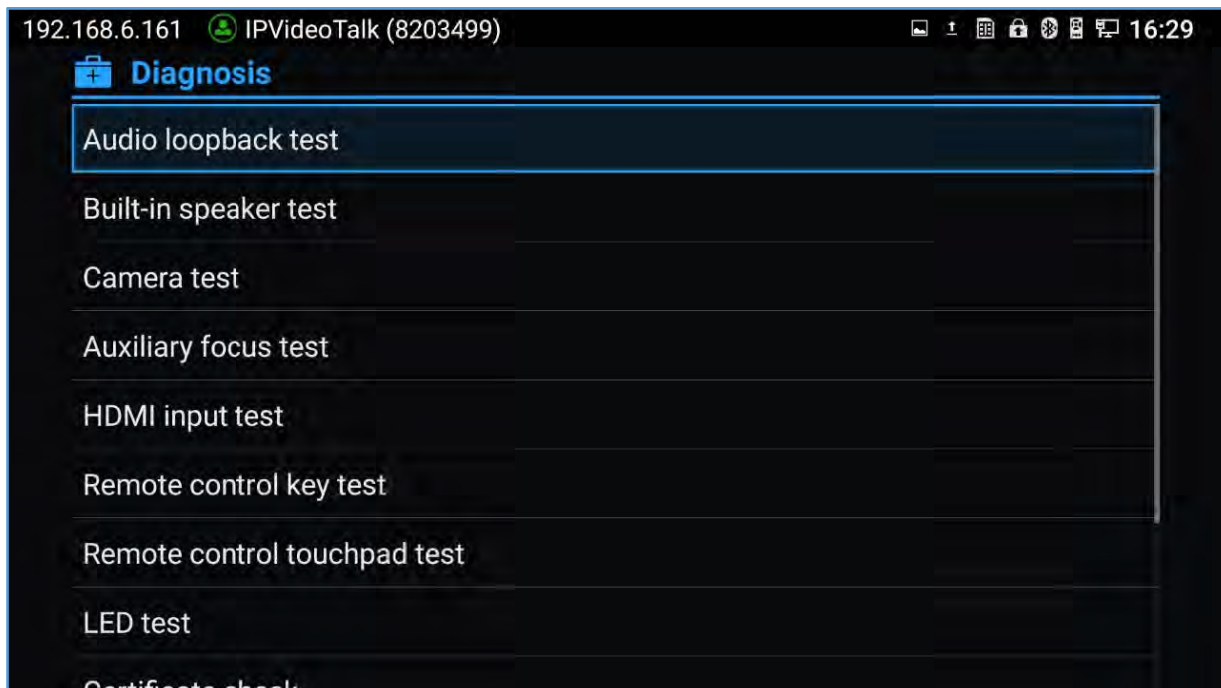



Figure 92: GVC3210 Diagnosis Screen

## Browser

Users could browse web page, view news and watch video via the built-in GVC3210 Browser. On home screen, select **Application**→**Browser** .

- Slide up or down with slide gesture to scroll the screen.
- Zoom in/out the page via zoom gesture.
- Press the MENU key to open the menu bar for more operations.

## Sync Local Schedule with Google Calendar

The GVC3210 supports schedule that can be accessed in LCD menu→**Schedule** (see section [Schedule]). The settings in this schedule are saved locally on GVC3210. If the user downloads and installs Google Calendar from Play Store to GVC3210, the local schedule can be synced up with Google Calendar.

Please follow the steps below to set up Google Calendar sync with GVC3210 schedule:

1. Go to GVC3210 LCD **menu**→**Applications**→**GSMmarket**, download and install Google Play Store.



2. Sign in Google Play Store using your Google account. Download and install Google Calendar to GVC3210.
3. Open Google Calendar on GVC3210. Please update Google Play services if required by the device.
4. Once Google Calendar is successfully installed and opened on GVC3210, it should automatically sign in using the same Google account in step 2.
5. On GVC3210 LCD **menu**→**Settings**→**System**→**Accounts**→**GoogleAccount**, select Google account

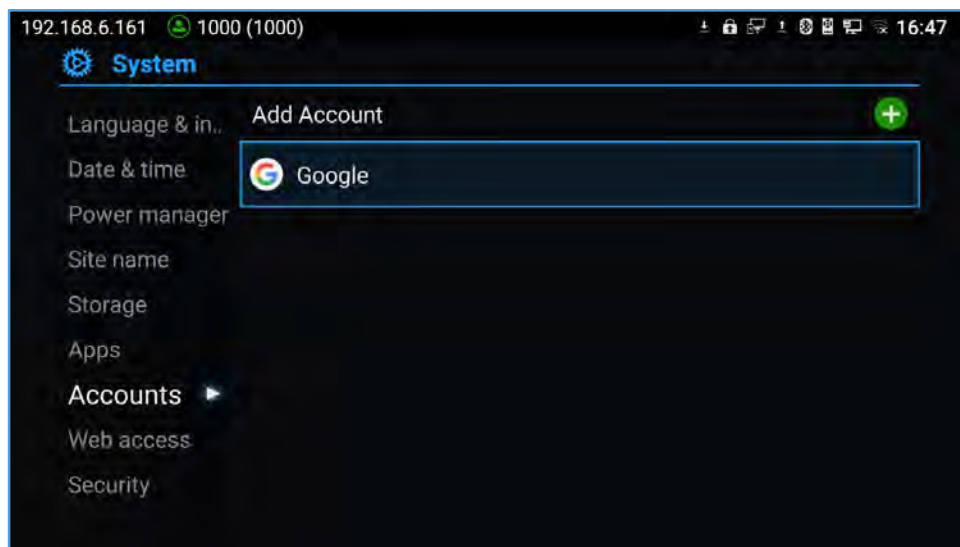

Figure 93: LCD Menu→Settings→System→Accounts

6. Select the Google account under Google accounts.
7. Click on the checkbox for “Calendar” to enable calendar sync for this Google account.

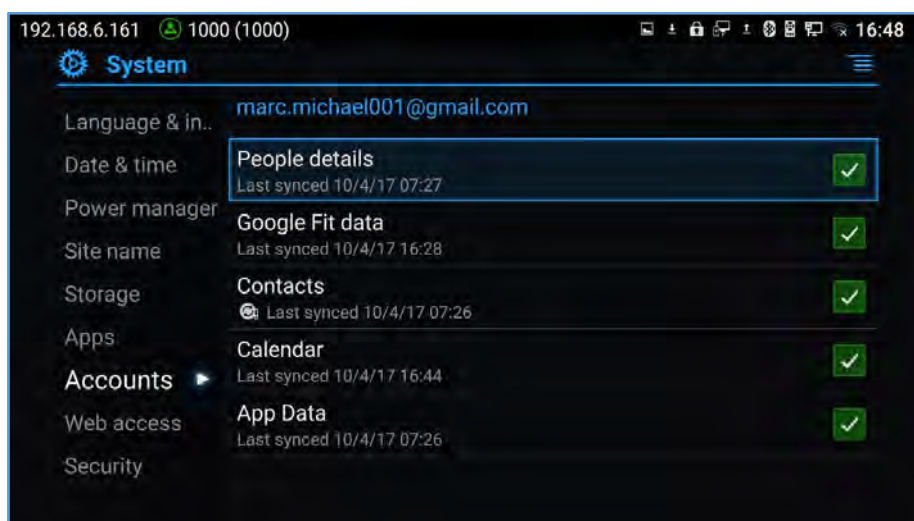

Figure 94: Enable Calendar Sync for the Google Account





8. On GVC3210 LCD menu→**Schedule**, click on the upper right MENU icon→Settings.

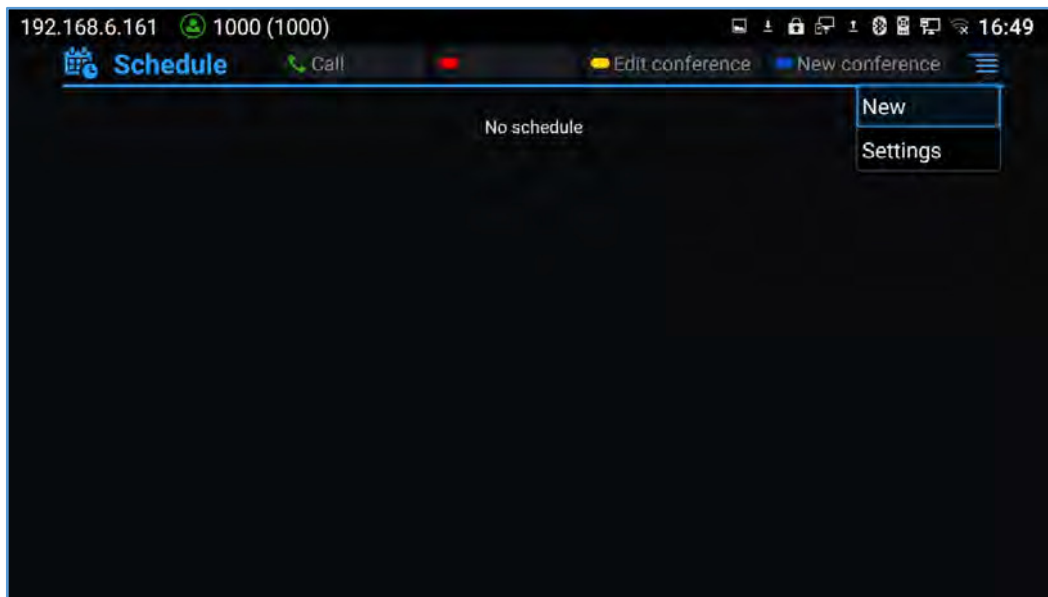

Figure 95: GVC3210 Schedule→Settings

9. Enable Google Calendar by selecting the checkbox for the Google account. Set the sync interval, e.g., Every 5 mins.

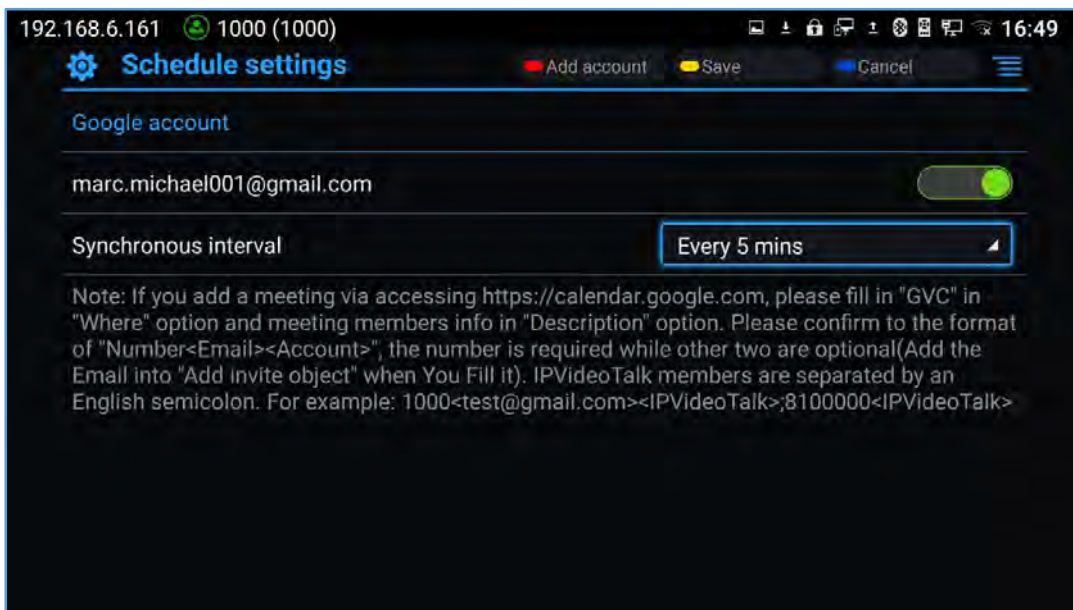

Figure 96: Enable Google Account for Schedule and Set Sync Interval

Now your GVC3210 has Google account successfully associated with schedule. The scheduled conference from GVC3210 or Google Calendar can sync with each other. Here is how to use it.



- To schedule meeting using Google Calendar and then sync up on GVC3210 schedule

1. When creating a new event in Google Calendar, please enter “GVC” in “Where” option.
2. Then enter meeting members in “Description” option. The meeting members should be in the format:**Number<Email><Account>**. “Number” is required while the other two fields are optional. Multiple meeting members need to be separated by semi-colon in English input method. For example, **1000<test@gmail.com><SIP>;810000<IPVideoTalk>;1001**

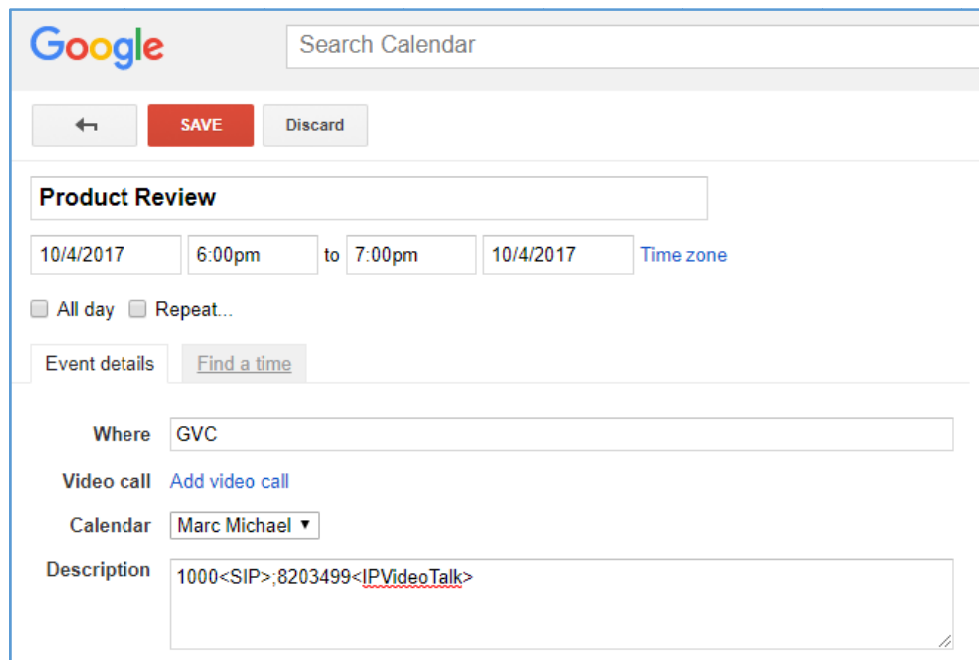

Figure 97: Creating New Event in Google Calendar

3. The new event will be displayed in GVC3210 schedule shortly.

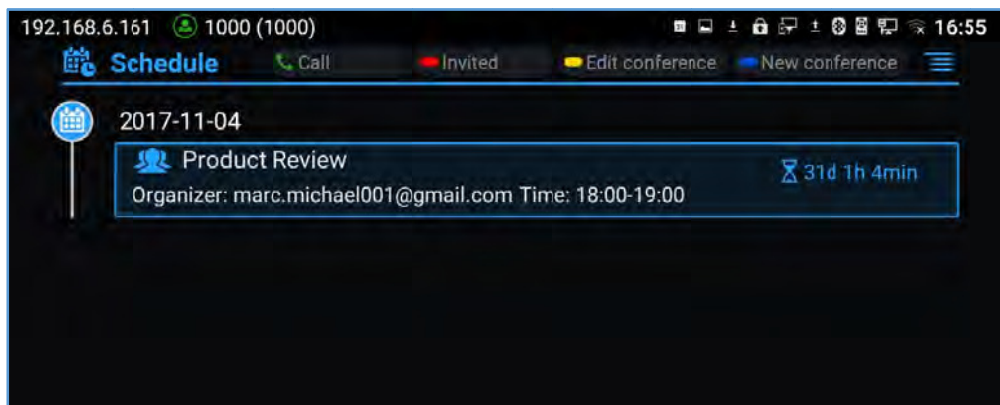

Figure 98: Google Calendar Event Synced in Schedule





- **To schedule meeting on GVC3210 and then sync up with Google Calendar**

On GVC3210 LCD idle screen (or web UI→Contacts)→Schedule, select the Google account as the “Related Account” and fill up other details to schedule the conference using Google account. The created conference will be synced up in Google Calendar.

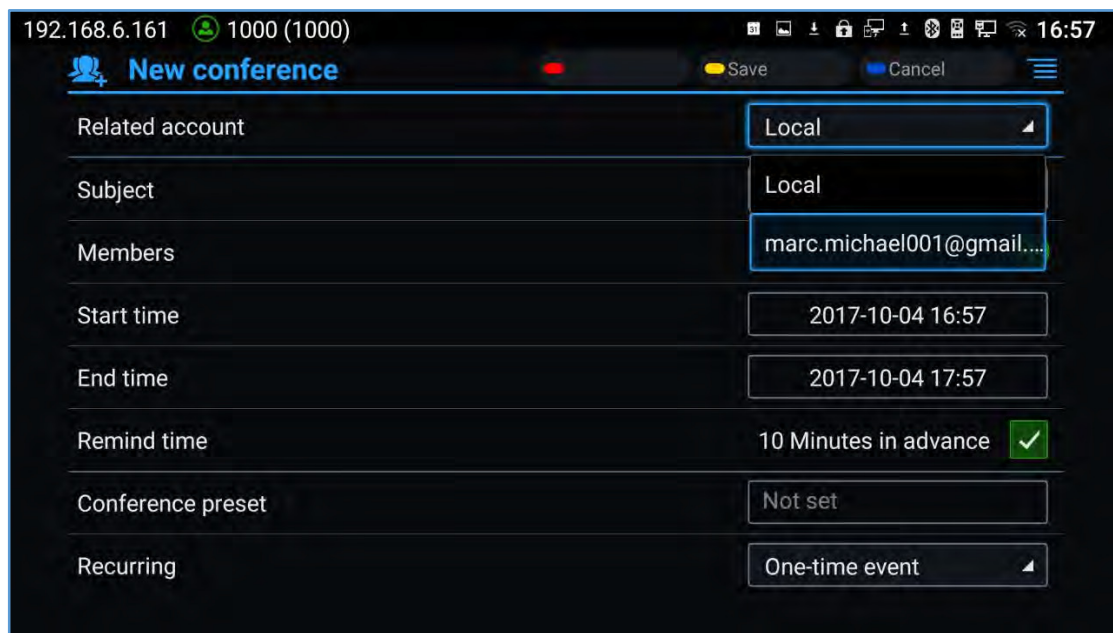

Figure 99: Set “Related Account” to Google Account

## Custom App on Home Screen

Users could add one app to the home screen for easy access. GVC3210 only supports custom one app on home screen. The new app will overwrite the older one.

On the Home screen, click on "Custom Home App" and select one app. Press "OK" key to confirm. The system will go back to Home screen automatically and users could find the app has already been added.

To remove or change the Custom Home App, go to LCD **Home screen**→**Applications**. Click on ☰ and select the option to modify custom app. Users could de-select the existing custom app, or change to a different app.

## Move App to Micro SD Card

The apps that are not built-in on GVC3210 can be moved to an external Micro SD card plugged to the GVC3210 from GVC3210 LCD→**Settings**→**System**→**Apps** page.

- Users could check the apps list on the external Micro SD card by pressing the Blue shortcut key on the GVC3210's remote control.



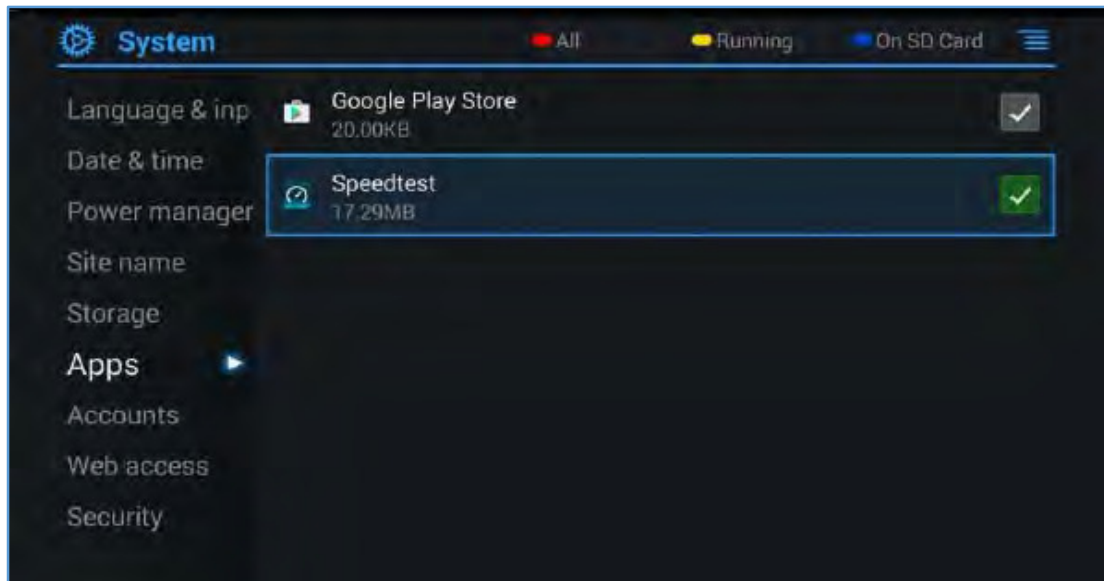

Figure 100: System→ Apps

- Choose the target app that needs to be moved to Micro SD card, it will show its detailed information, then Click on “Move to SD card” to make the change take effect. After configuration change, note that the moved app will not be listed anymore on GVC3210 device after the external Micro SD card is ejected.

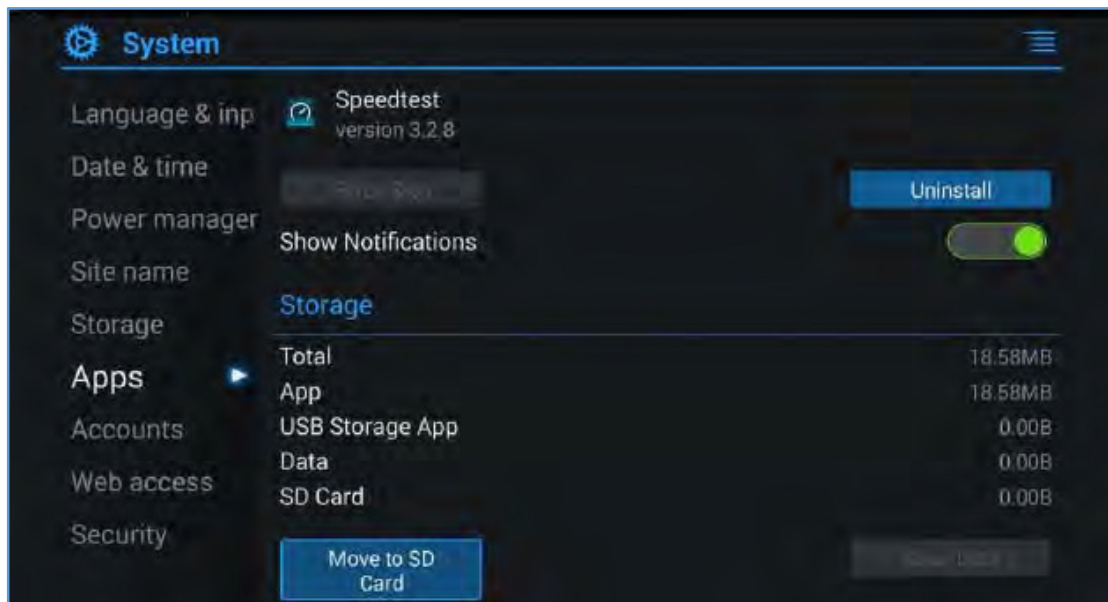

Figure 101: Move App to SD card

- To move the app back to the GVC3210 internal storage, users could click “Move to device” on the detailed information page for the app on GVC3210 LCD→**Settings**→**System**→**Apps** page.



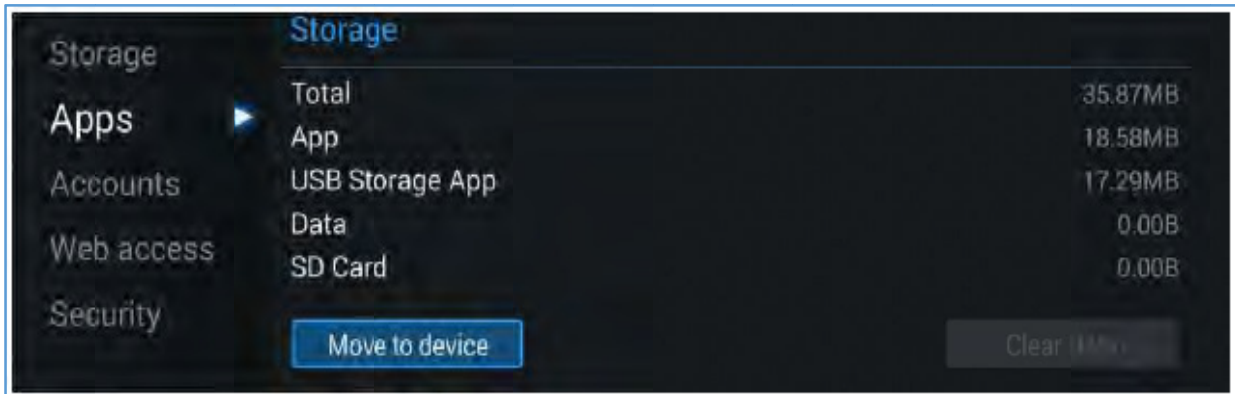

Figure 102: Move App to Device Storage

## Uninstall Application

The applications (except the system applications) on GVC3210 can be uninstalled. Go to LCD Home screen → Applications, click on ☰ and select "Uninstall Mode". Users will see the apps that can be deleted shown with ✕ icon. Select and confirm the uninstallation.

Once done, press ↶ on the remote control, or press ☰ to go back to normal mode.



## GS MARKET

GVC3210 provides access to apps directly via built-in GS market. Users could download the apps from the market and install to GVC3210.

### Search Apps

On GVC3210 Home screen, click on **Applications** → **GS Market** . Users could view the apps by category, or input key words and click on SEARCH icon to search the app.

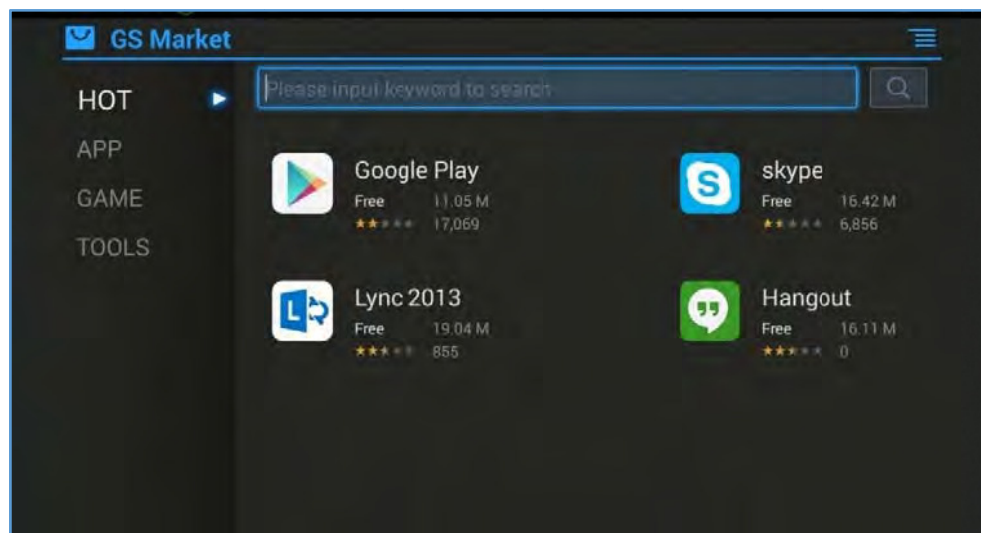



Figure 103: GVC3210GS Market

### Download and Install Apps

- Users could see that if the app has been installed or downloaded by pressing the blue shortcut key.
- Press MENU key  to view the downloaded apps and installed apps.
- Users could press the blue shortcut key on GVC3210 remote control to cancel download in process.
- The installing process will be started automatically after downloading the app.
- Go to Installed screen to view the installed apps, or press the blue shortcut key on the remote control to uninstall the downloaded apps.

### Update Apps

GVC3210 will detect to update automatically if there is new version available for the installed apps when the network connection is normal. Users can view the relevant information, and update apps on the



Installed screen.



## GVC3210 WEB UI FEATURES

GVC3210 embedded Web server responds to HTTP/HTTPS GET/POST requests. Embedded HTML pages allow users to configure the application device through a Web browser such as Mozilla Firefox, Google Chrome™, etc.

### Accessing GVC3210 Web GUI

The IP address of the GVC3210 will show on the top status bar of the connected display device (e.g., TV) via HDMI.

To access GVC3210 Web GUI:

1. Connect the computer to the same network as GVC3210.
2. Make sure GVC3210 is turned on and shows its IP address on the top status bar of the connected display device.
3. Open a Web browser on your computer.
4. Enter GVC3210's IP address in the address bar of the browser, e.g.: `http://192.168.5.162`.
5. Enter the administrator's login and password to access the Web Configuration Menu. The default administrator username and password are "admin" and "admin". The default end user username and password are "user" and "123". The user can select English or other languages in the drop-down menu of language.

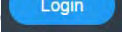

Figure 104: GVC3210 Web GUI - Login

6. Click "Login"  to access the configurations in web UI.



## Saving Changes

When changing any settings on the web UI, always submit them by pressing the “Save” button on the bottom of the page, and then clicking the “Apply” button on the top of the page to apply the configuration changes. For those options with icon  next to it in the web page, users must reboot the GVC3210 for the changes to take effect.

## Definitions

This section describes the options in the GVC3210 Web GUI. As mentioned in the previous section, you can log in as an administrator or a normal user.

- **Call**  
Users could initiate conference and control conference from Web GUI.
- **Contacts**  
Manage contacts and LDAP client configuration, schedule conference and manage call history.
- **Device Control**  
Device Control and Audio Control.
- **Settings**  
Account, Network Settings, Peripheral, Call Features, General Settings and Security Settings.
- **Maintenance**  
Upgrade, Recording, Time & Language, Troubleshooting and Reboot.
- **Status**  
Account Status, Peripheral Status, Network Status, System Info and Remote Control status.

The following table shows the web pages accessible by end user and administrator.

Table 21: GVC3210 Web Access

User Type	Username	Default Password	Accessible Web Pages
Normal User	user	123	<ul style="list-style-type: none"> <li>• Call</li> <li>• Contacts</li> <li>• Device Control</li> <li>• Status</li> <li>• Settings: Network Settings, Peripheral, Security Settings</li> <li>• Maintenance: Recording, Time &amp; Language, Troubleshooting, Reboot</li> </ul>
Administrator	admin	admin	All pages



## Toolbar

The web UI tool bar is on the upper right corner of the web UI page.

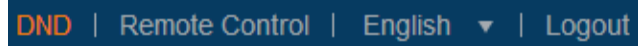

Figure 105: GVC3210 Web UI Tool Bar

- **DND**  
Turn on/off DND mode. Once enabled, the DND text will turn into red in web UI. The LCD for GVC3210 display will show DND indication on the top of the screen and all incoming calls will be rejected.
- **Remote Control**  
Click to bring up virtual remote control panel.
- **English**  
Select the display language for the web UI.
- **Logout**  
Log out from the web UI.

## Call Page

GVC3210 Web UI call page is shown below. Users could make calls and initiate conference from Web UI.





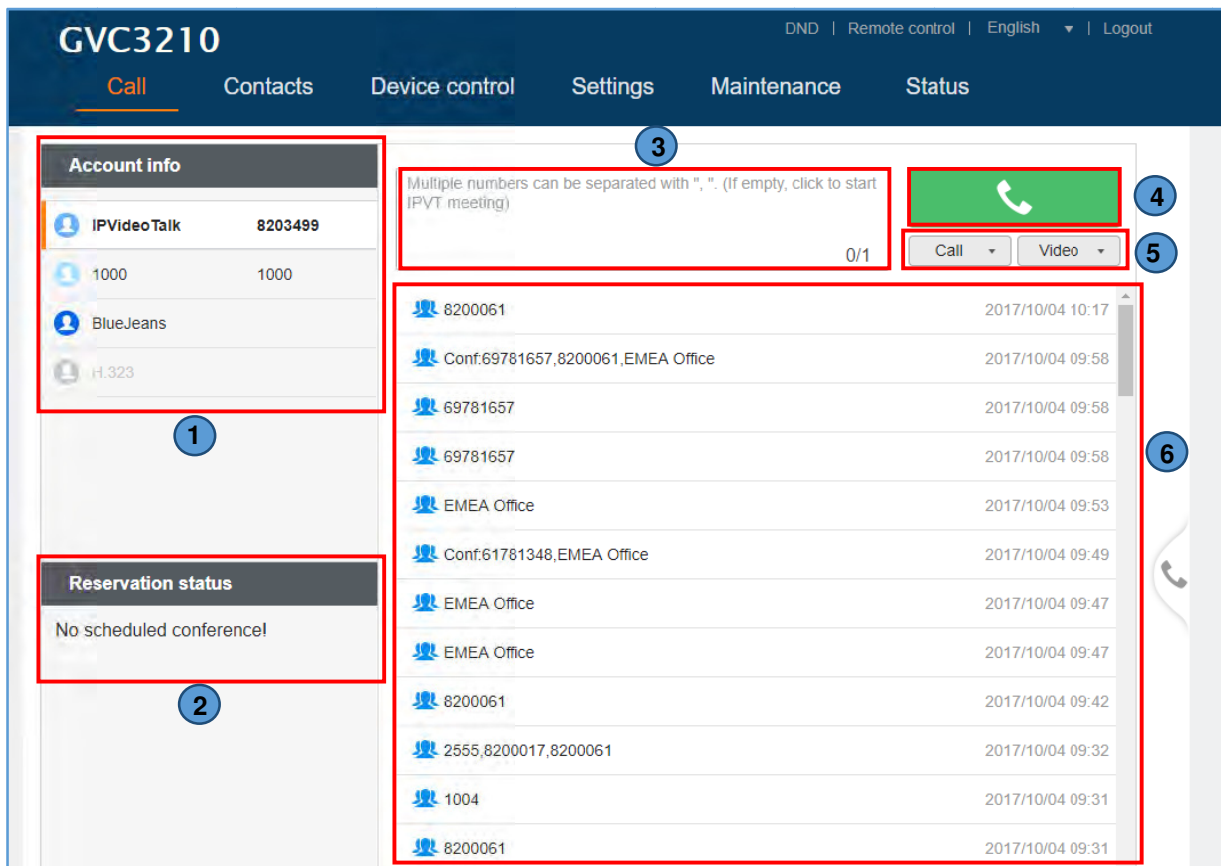



Figure 106: GVC3210 Web UI – Call

Table 22: GVC3210 Web UI - Call Settings

NO.	Explanation
1	Accounts Registration
2	Latest conference schedule information
3	Input Phone Number
4	Dial out.
5	Select call mode
6	Display all call history.

## Making a Call

Enter phone number in input box, and select call mode, tap on button  to dial out; or, select one call

history entry in the list below and click on  to dial out.

### Conference Control

When making a new call, initiating a conference or receiving an incoming call, the conference screen will pop up as shown below.

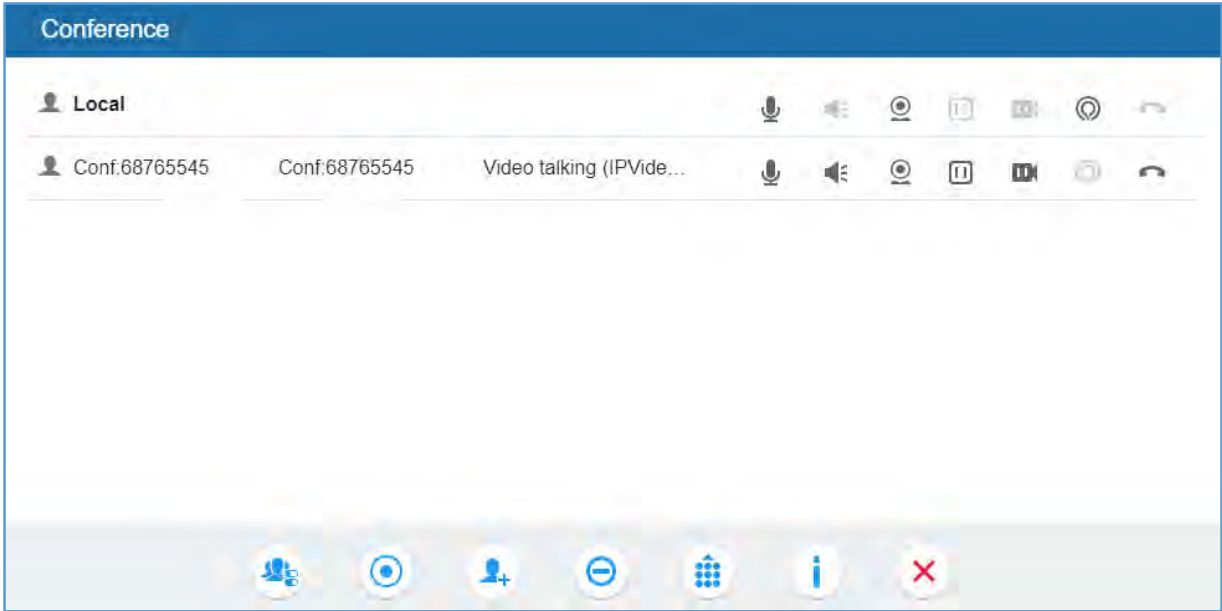

Figure 107: GVC3210 Web UI - Conference Status

Click on the icon for “Conference Control”, users will see a list of control icons on the bottom which are also available in LCD call screen.

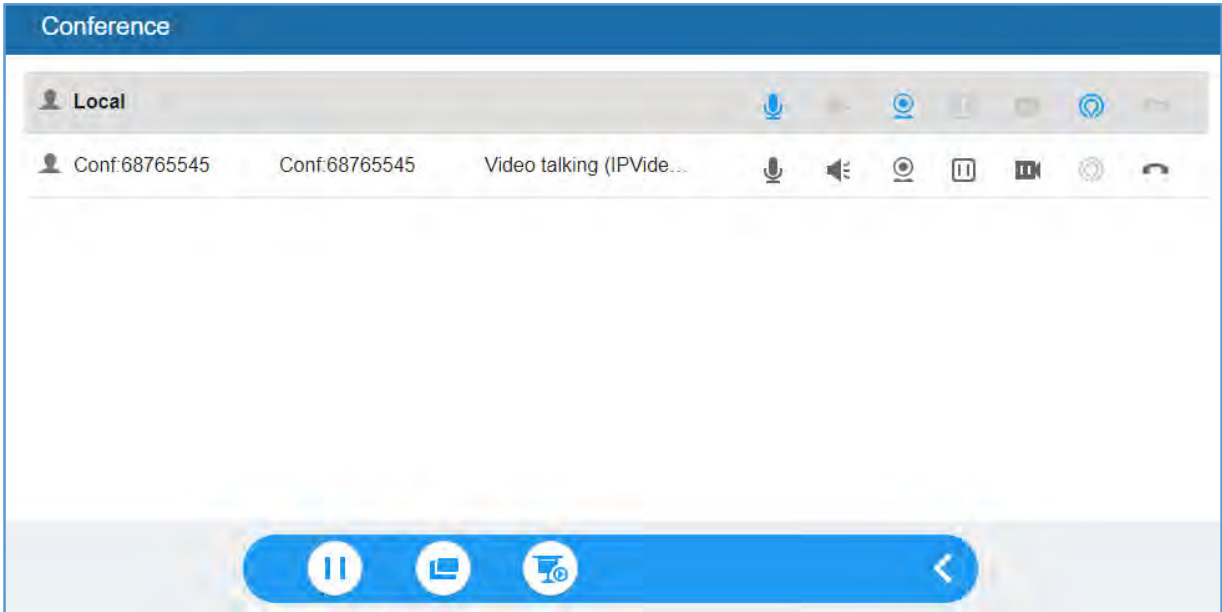

Figure 108: GVC3210 Web UI - Conference Control



## Contacts Page

This page lists Contacts, Schedule, Call History and LDAP Settings.

### Contacts

Users could search/add/delete/edit contacts on web page. The operations will be synchronized and can be viewed from LCD as well. The web UI contacts page is as shown below.

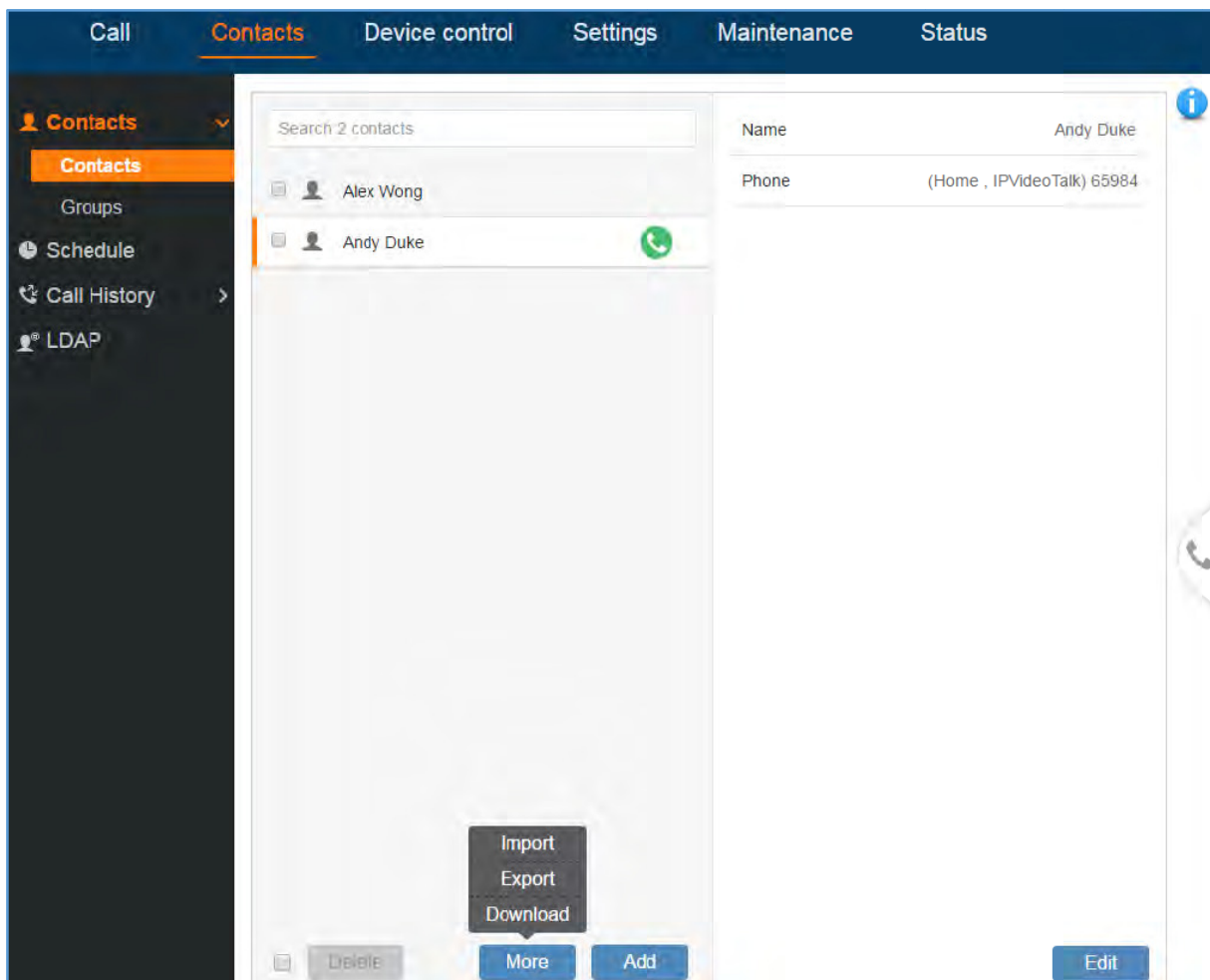



Figure 109: GVC3210 Web UI - Contacts

- Click on  next to the contact to dial the contact.
- Click on "More" to open more options such as export, import and download contact.
- Select "Import" option and users will find import screen on the right. Refer to chapter **Batch Import Contacts** for more details.
- Select "Export" option and users will find export screen on the right. Refer to chapter **Export Contacts** for more details.



Select "Download" option and users will find download screen on the right. Refer to chapter

**Download Contact** for more details.

- Click on **Add** and users will find Add Contact screen on the right. Fill in contact information and save.
- Click on **Edit** and users will find Edit Contact screen on the right. Edit contact information and save.
- Click on the checkbox for "Delete" and users can select the contacts to delete from GVC3210.

## Groups

When IPVideoTalk supports a specific member "N" of contacts who can participate in the conference, the GVC3210 will dial only the "N" first contacts in the group.

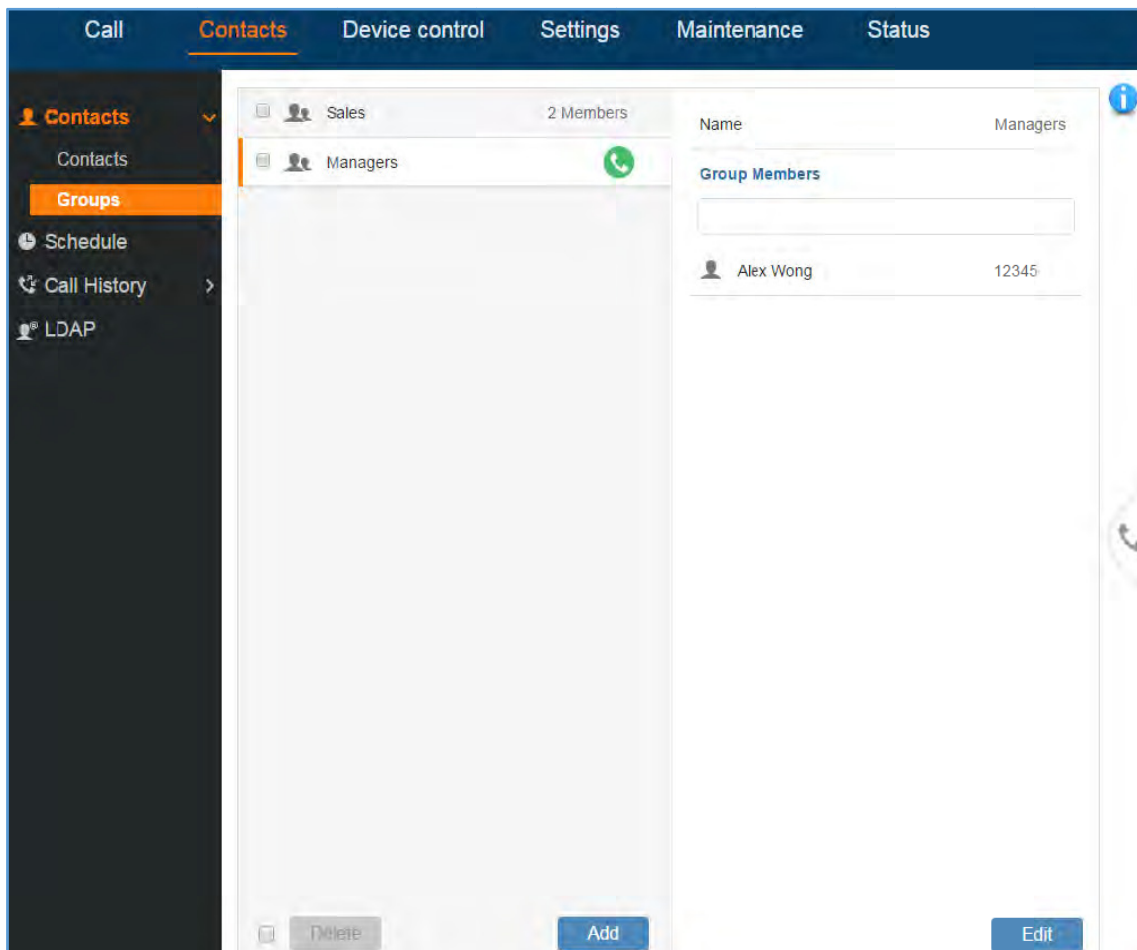



Figure 110: GVC3210 Web UI - Groups

- Click on  next to the group to call the contacts in the group.



- Click on **Add** and users will find Add Group screen on the right. Select group members from existing contacts and save.
- Click on **Edit** and users will find Edit Group screen on the right. Edit Group information and save.
- Click on the checkbox for “Delete” and users can select the groups to delete from GVC3210.

## Schedule

Conference can be scheduled, edited and deleted from web UI. See figure below. Please refer to chapter **Schedule** for more details for each option.

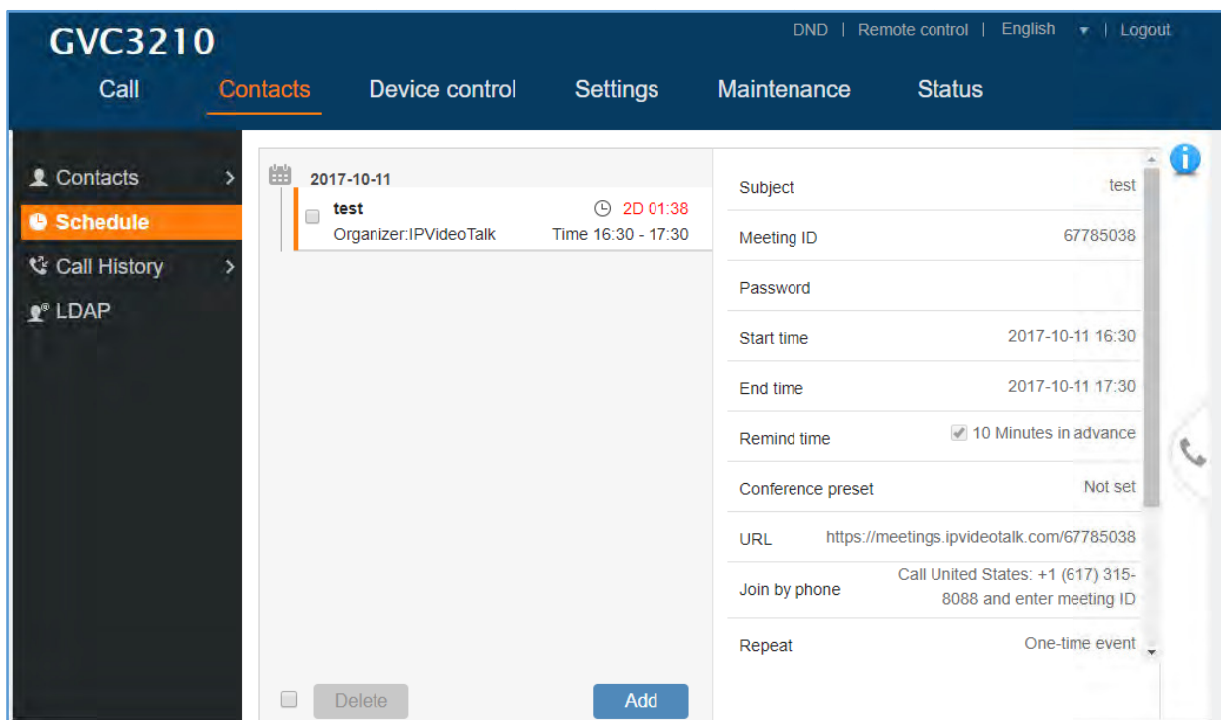

**Figure 111: GVC3210 Web Page - Schedule**

- Click on **Add** and users will find Add Schedule screen on the right. Click on “Save” after configuring the schedule.
- Click on **Edit** and users will find Edit Schedule screen on the right. Click on “Save” after editing the schedule.
- Click on the checkbox for “Delete” and users can select the schedules to delete from GVC3210.
- Move the cursor to the scheduled conference where the scheduled time is displayed, icon  will appear for the user to dial out immediately.



### Call History

From web UI, users could also access Call history, which is synchronized with the call history from LCD.

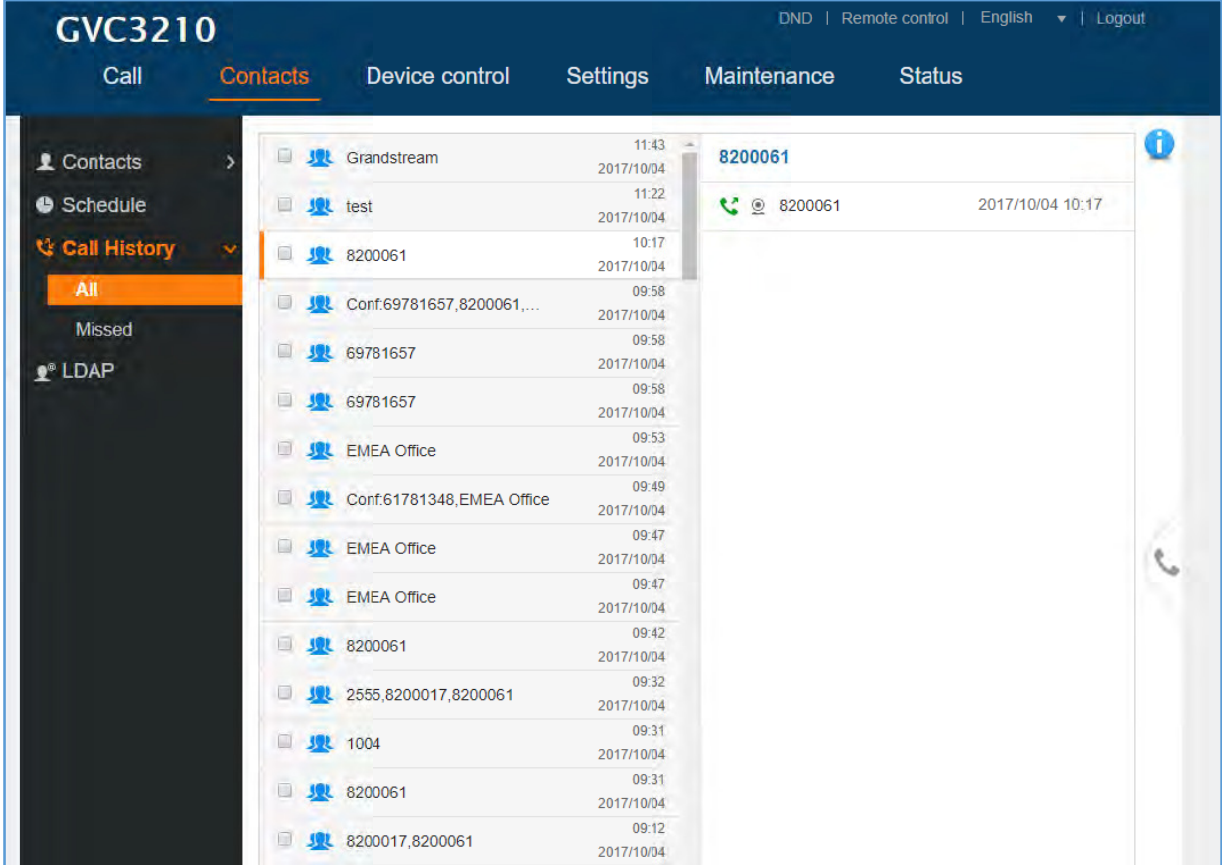



Figure 112: GVC3210 Web UI - Call History

The call history details will be displayed on the right side when there is one entry selected. Users can also move the cursor to the call history time to add this call to schedule by clicking on  , or dial out immediately by clicking on  .

### LDAP

This section is the same as LDAP settings under chapter LDAP contacts. Please refer to **LDAP contacts** for more details.



## Device Control Page

### Video Control

Users could add preset and manipulate EPTZ control on this page.

- Move the cursor to one configured preset to preview preset.
- Click one preset to apply the preset.
- Click the un-configured preset, and adjust via the EPTZ control panel on the right, then save the configurations.

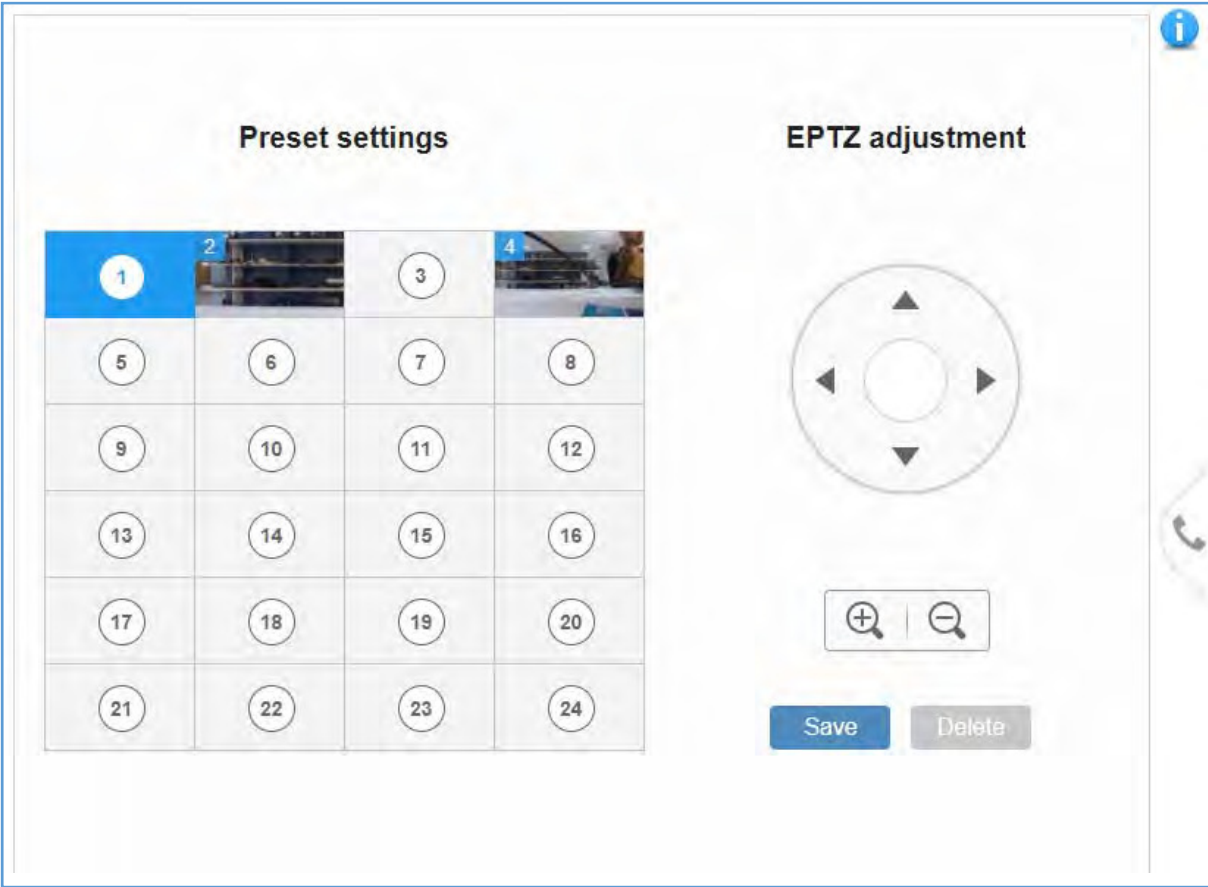

Figure 113: GVC3210 Web UI - Video Control





## Audio Control

Table 23: GVC3210 Web UI - Audio Control Parameters

Parameters	Descriptions
<b>Echo Delay</b>	Configures the device's HDMI audio delay to match the audio latency of different TV sets.
<b>Ringtone Volume</b>	Users can slide left or right to adjust ringtone volume. 0 is the lowest value, 7 is the highest value.
<b>Media Volume</b>	Users can slide left or right to adjust media volume. 0 is the lowest value, 15 is the highest value.
<b>Device Ringtone</b>	Select device ringtone from the dropdown list.
<b>Notification Ringtone</b>	Select device notification ringtone from the dropdown list.
<b>Audio Device</b>	<p>Select the audio device that the GVC3210 will use for audio input and output during call or playing media.</p> <p>The options are "Auto", "Bluetooth", "USB", "HDMI", "Built-in Speaker" and "Gooseneck Mic".</p> <ul style="list-style-type: none"> <li> <b>Auto</b>            GVC3210 will automatically detect whether any USB, Bluetooth or HDMI devices are connected. If only one of them is connected, it will be used as the audio device. If two or three are connected, the priority is "Bluetooth"&gt;"USB"&gt;"HDMI"&gt;"Built-in Speaker"&gt;"Gooseneck Mic".         </li> <li> <b>Bluetooth</b>            The Bluetooth audio device will be used for audio input and output.         </li> <li> <b>USB</b>            The USB audio device will be used for audio input and output.         </li> <li> <b>HDMI</b>            The audio input comes from the built-in MIC in GVC3210 and the audio output comes from HDMI.         </li> <li> <b>Built-in Speaker</b>            The audio output comes from the built-in speaker in GVC3210 and the audio input comes from device with priority "Bluetooth&gt;USB&gt;HDMI&gt;Gooseneck Mic&gt;Built-in Mic"         </li> <li> <b>Gooseneck Mic</b>            The audio input comes from the connected Gooseneck MIC and the audio output comes from device with priority "Bluetooth&gt;USB&gt;HDMI&gt;Built-in speaker"         </li> </ul> <p>The default setting is "Auto".</p>



<b>Call Progress Tones</b>	<p>Using these settings, users can configure ring or tone frequencies based on parameters from the local telecom provider. By default, they are set to the North American standard.</p> <p>Frequencies should be configured with known values to avoid uncomfortable high pitch sounds.</p> <p>Syntax: f1=val, f2=val [,c=on1/off1[-on2/off2[-on3/off3]]];          (Frequencies are in Hz and cadence on and off are in 10ms)</p> <p>ON is the period of ringing ("On time" in 'ms') while OFF is the period of silence. In order to set a continuous ring, OFF should be zero. Otherwise, it will ring ON ms and a pause of OFF ms and then repeat the pattern. Up to three cadences are supported.</p>
	<p><b>Ring Back Tone:</b></p> <p>Users can configure ring back tone which is the tone the caller will hear before the callee answers the call. The default value: f1=440@-19,f2=480@-19,c=2000/4000;</p>
	<p><b>Busy Tone:</b></p> <p>Users can configure busy tone which will be heard if the callee is busy or on DND. The default value: f1=480@-24,f2=620@-24,c=500/500;</p>
	<p><b>Reorder Tone:</b></p> <p>Users can configure reorder tone which will be heard when the call fails to be established such as wrong account number is dialed, or the call is timed out. The default value: f1=480@-24,f2=620@-24,c=250/250;</p>
	<p><b>Confirmation Tone:</b></p> <p>Users can configure confirmation tone which will be heard when the callee enables call recording function or when the SIP account fails to register. The default value: f1=350@-11,f2=440@-11,c=100/100-100/100-100/100.</p>
	<p><b>Call Waiting Tone:</b></p> <p>Users can configure call waiting tone when there is another incoming call during the call. The default value: f1=440@-13,c=300/2000-300/2000-0/0.</p>
<b>Call-Waiting Tone Gain</b>	<p>This configures the call-waiting tone gain. By default, they are set to the North American standard. Users could select "Low", "Medium" or "High". The default setting is "Low".</p>
<b>Ring Cadence</b>	<p>Configure the default ring cadence for the ring back tone. The default setting is c=2000/4000;</p>



## FACTORY RESET

Users could reset GVC3210 to factory settings via the following ways: Reset via local GUI, via Web page, via the reset hole on the back panel of GVC3210. Factory reset will delete configuration info and syslog info.



1. Factory reset will erase all GVC3210 configuration information. Please back up all settings or print useful information before making the following operations. If users lose all parameters or records, Grandstream will not take responsibility for the damage or loss.
  2. After factory reset, the remote control will not be paired to GVC3210 anymore. Once the device reboot after reset, the user needs only to press OK+5 on the remote control at the same time for 4 seconds in order to pair and connect the remote control to GVC3210.
- 

### Reset via LCD

Go to GVC3210 LCD idle screen → **Settings** → **Maintenance** → **FactoryReset**, click on the "Reset" button to bring up the prompt box as shown below. Click "OK" to reboot the device and restore factory settings.

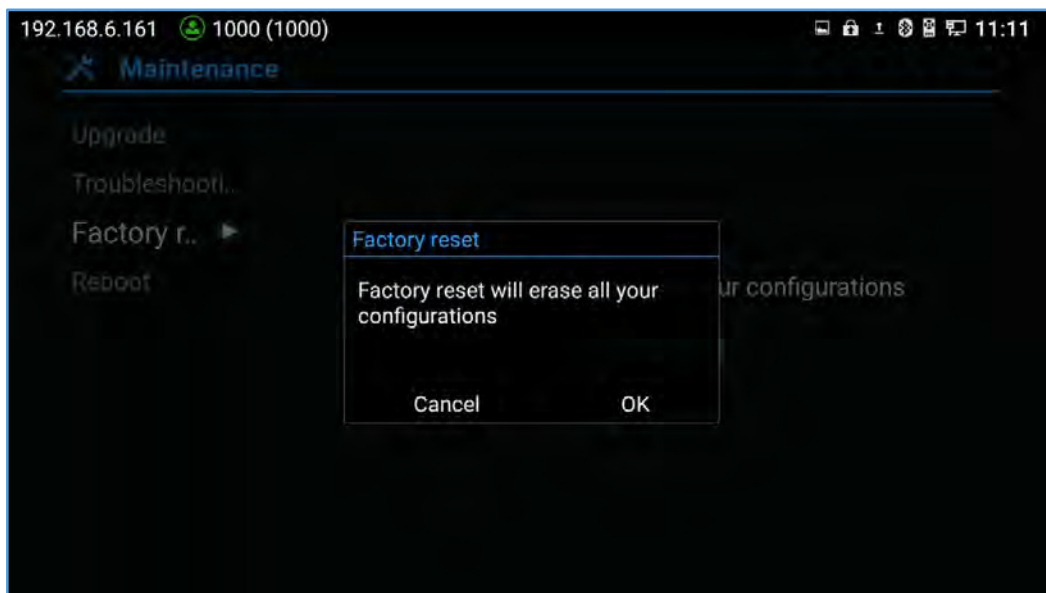

Figure 114: Factory Reset via LCD



## Reset via WebUI

1. Log in GVC3210 Web UI → **Maintenance** → **Upgrade**, the "Factory Reset" option is on the bottom of the page.

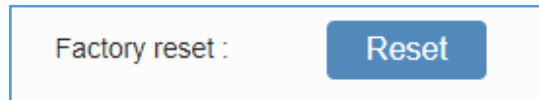

Figure 115: GVC3210 Web UI - Factory Reset

2. Click the "Reset" button to bring up the prompt box as shown below. Click "OK" to reboot the device, and restore factory settings.

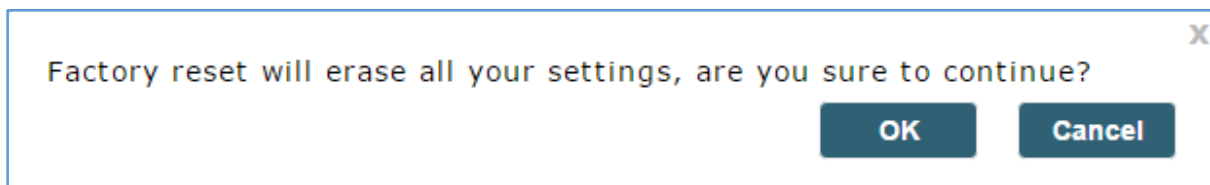

Figure 116: GVC3210 Web UI - Factory Reset Confirmation

## Reset via Reset Hole

There is a Reset hole on the bottom panel of GVC3210, use a small pin to hold against the Reset hole for more than 10 seconds to restore factory settings.



## EXPERIENCING GVC3210

Please visit our website: <http://www.grandstream.com> to receive the most up-to-date updates on firmware releases, additional features, FAQs, documentation and news on new products.

We encourage you to browse our [product related documentation](#), [FAQs](#) and [User and Developer Forum](#) for answers to your general questions. If you have purchased our products through a Grandstream Certified Partner or Reseller, please contact them directly for immediate support.

Our technical support staff is trained and ready to answer all of your questions. Contact a technical support member or [submit a trouble ticket online](#) to receive in-depth support.

Thank you again for purchasing Grandstream Video Conferencing System, it will be sure to bring convenience and color to both your business and personal life.

---

\* Android is a trademark of Google Inc.

\* Skype and Skype for Business are Registered Trademarks of Microsoft Corporation.

**HDMI™** HDMI, the HDMI Logo, and High-Definition Multimedia Interface are trademarks or registered trademarks of HDMI Licensing LLC in the United States and other countries.

---

