

# GRP2616 天线技术规格书 Antenna Specification

Brand Name: GRANDSTREAM

Manufacture: SHENZHEN CHAOLIU NETWORK TECHNOLOGIES CO., LTD

Manufacturing address: 14th Floor, Building-C, Coolpad Building, Gaoxin North District, Science Park, Nanshan District, Shenzhen

Product Number (or model Name) : 118-00061-00

## 设计规格 specifications

频率范围 Frequency (MHz)	2.4G:2400~2500	5G: 5150~5850
电压驻波比 VSWR	$\leq 2.0: 1$	
增益 Gain (dBi)	3.5	4.0
效率 Efficiency (%)	2.4G: $\geq 70$	5G: $\geq 70$
辐射方向 Radiation Properties	全向 Omni-directional	
最大输入功率 Max Input Power (Watts)	2	
极化方式 Polarization	垂直 Vertical	
阻抗 Impedance (Ohms)	50	
外形尺寸 Dimensions (mm)	L36.0*W9.5*H0.8mm	
射频同轴电缆 Cable	RF1.13mm mini coax	
射频连接器 Connector	ECT 818000089	
材质 Material	PCB_FR4	
重量 Weight	1.04g	
工作温度 Operation Temperature	-40°C to 85°C	
储存温度 Storage Temperature	-40°C to 85°C	
相对湿度 Relative Humidity	40% to 95%	
环保认证 ROHS Compliant	通过 Yes	

## 辐射方向图 Radiation Pattern

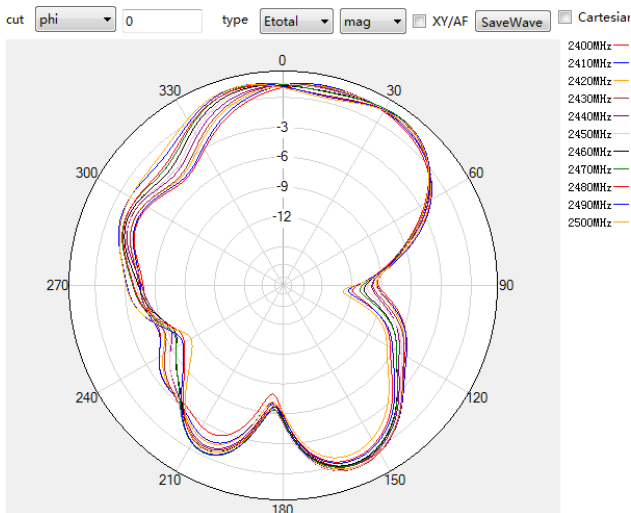

2.4G phi=0deg

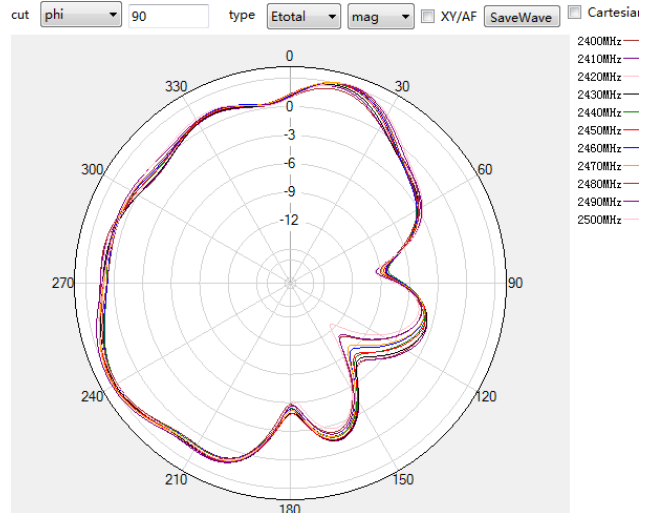

2.4G phi=90deg

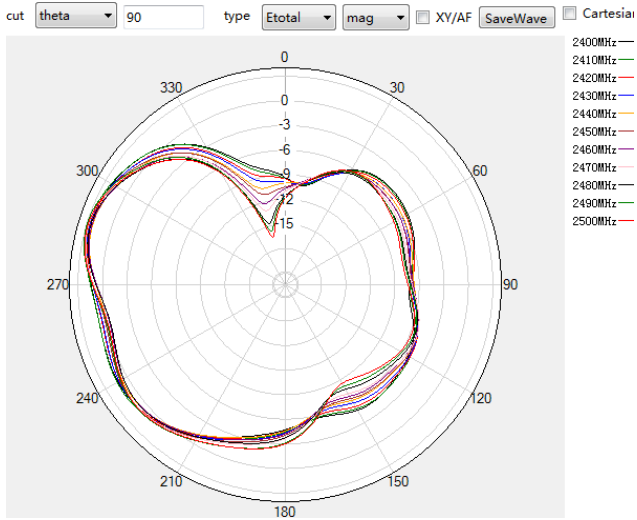

2.4G theta=90deg

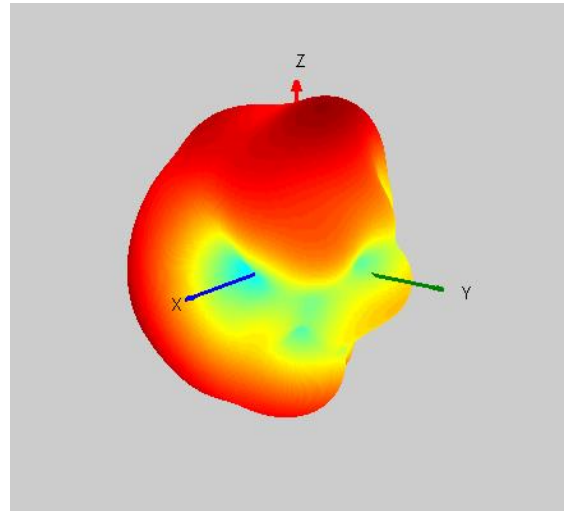

2.4G 3D

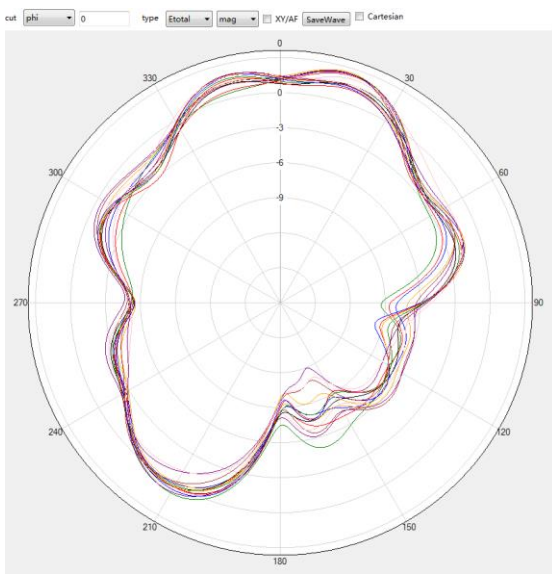

5G phi=0deg

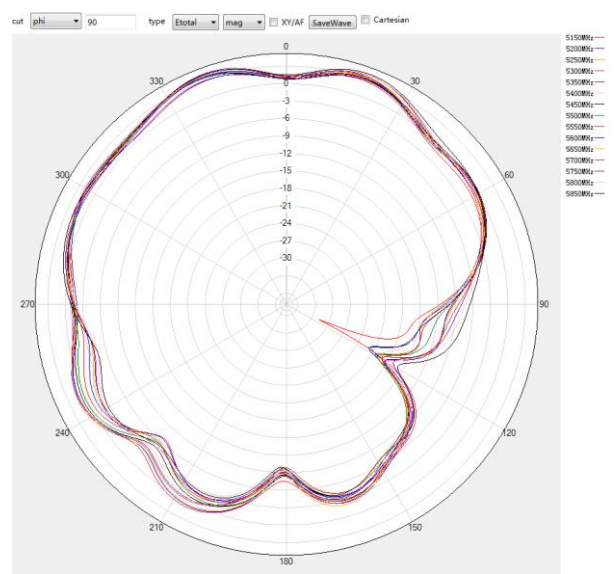

5G phi=90deg

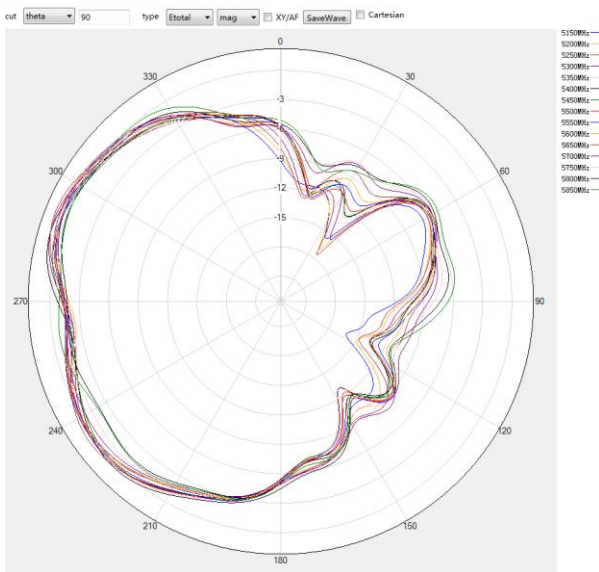

5G theta=90deg

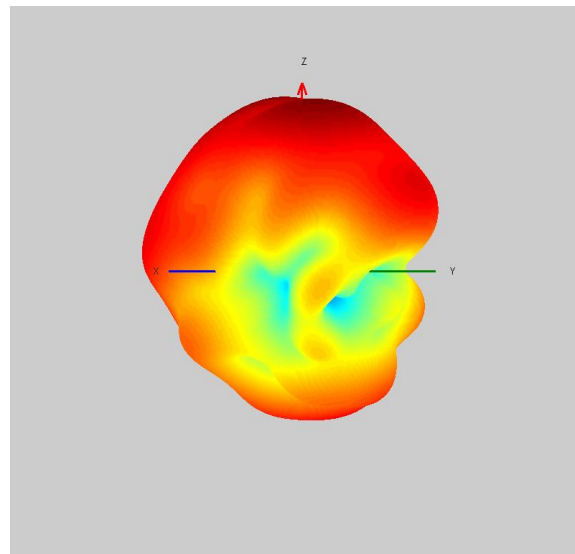

5G 3D

总成图 Mechanical Drawing (Unit: mm)

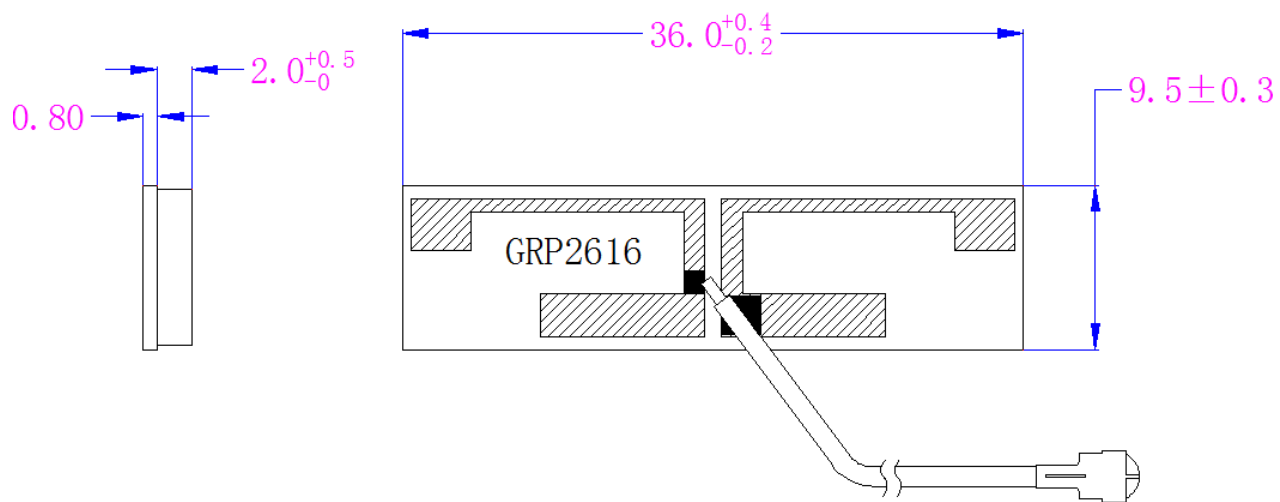

▲规格书到此结束 END OF THE SPECIFICATION.