

### 5.8 DYNAMIC FREQUENCY SELECTION

**Test Requirement:** FCC 47 CFR Part 15 Subpart E Section 15.407 (h)  
RSS-247 Issue 2 Section 6.3

**Test Method:** KDB 905462 D03 Client Without DFS New Rules v01r02

**EUT Operating Mode:**

DFS Operational mode	Operating Frequency Range	
	5250 MHz to 5350 MHz	5470 MHz to 5725 MHz
Slave without radar Interference detection function	✓	✓

**Applicability:**

The following table from KDB905462 and the lists of the applicable requirements for the DFS testing.

**Applicability of DFS Requirements Prior to Use of a Channel:**

Requirement	Operational Mode		
	Master	Client Without Radar Detection	Client With Radar Detection
Non-Occupancy Period	✓	Not required	Yes
DFS Detection Threshold	✓	Not required	Yes
Channel Availability Check Time	✓	Not required	Not required
U-NII Detection Bandwidth	✓	Not required	Yes

**Applicability of DFS requirements during normal operation:**

Requirement	Operational Mode	
	Master Device or Client with Radar Detection	Client Without Radar Detection
DFS Detection Threshold	Yes	Not required
Channel Closing Transmission Time	Yes	Yes
Channel Move Time	Yes	Yes
U-NII Detection Bandwidth	Yes	Not required
<b>Additional requirements for devices with multiple bandwidth modes</b>	<b>Master Device or Client with Radar Detection</b>	<b>Client Without Radar Detection</b>
U-NII Detection Bandwidth and Statistical Performance Check	All BW modes must be tested	Not required
Channel Move Time and Channel Closing Transmission Time	Test using widest BW mode available	Test using the widest BW mode available for the link
All other tests	Any single BW mode	Not required
<b>Note:</b> Frequencies selected for statistical performance check (Section 7.8.4) should include several frequencies within the radar detection bandwidth and frequencies near the edge of the radar detection bandwidth. For 802.11 devices it is suggested to select frequencies in each of the bonded 20 MHz channels and the channel center frequency.		

**DFS Detection Thresholds for Master Devices and Client Devices with Radar Detection:**

Maximum Transmit Power	Value (See Notes 1, 2, and 3)
EIRP ≥ 200 milliwatt	-64 dBm
EIRP < 200 milliwatt and power spectral density < 10 dBm/MHz	-62 dBm
EIRP < 200 milliwatt that do not meet the power spectral density requirement	-64dBm

**Note 1:** This is the level at the input of the receiver assuming a 0 dBi receive antenna.  
**Note 2:** Throughout these test procedures an additional 1 dB has been added to the amplitude of the test transmission waveforms to account for variations in measurement equipment. This will ensure that the test signal is at or above the detection threshold level to trigger a DFS response.  
**Note 3:** EIRP is based on the highest antenna gain. For MIMO devices refer to KDB Publication 662911 D01.

**DFS Radar Signal Parameter Values:**

Parameter	Value
Non-occupancy period	Minimum 30 minutes
Channel Availability Check Time	60 seconds
Channel Move Time	10 seconds (See Note 1.)
Channel Closing Transmission Time	200 milliseconds + an aggregate of 60 milliseconds over remaining 10 second period. (See Notes 1 and 2.)
U-NII Detection Bandwidth	Minimum 100% of the U-NII 99% transmission power bandwidth. (See Note 3.)

**Note 1:** Channel Move Time and the Channel Closing Transmission Time should be performed with Radar Type 0. The measurement timing begins at the end of the Radar Type 0 burst.  
**Note 2:** The Channel Closing Transmission Time is comprised of 200 milliseconds starting at the beginning of the Channel Move Time plus any additional intermittent control signals required to facilitate a Channel move (an aggregate of 60 milliseconds) during the remainder of the 10 second period. The aggregate duration of control signals will not count quiet periods in between transmissions.  
**Note 3:** During the U-NII Detection Bandwidth detection test, radar type 0 should be used. For each frequency step the minimum percentage of detection is 90 percent. Measurements are performed with no data traffic.

**DFS Radar Signal Parameter:**

Radar Type 0 was used in the evaluation of the Client device for the purpose of measuring the Channel Move Time and the Channel Closing Transmission Time

**Table 1-Short Pulse Radar Test Waveforms**

Radar Type	Pulse Width (µsec)	PRI (µsec)	Number of Pulses	Minimum Percentage of Successful Detection	Minimum Trials
0	1	1428	18	See Note 1.	See Note 1.
1	1	Test A Test B	Roundup $\left\{ \begin{matrix} \left( \frac{1}{360} \right) \\ \left( \frac{19 \cdot 10^6}{PRI_{\mu sec}} \right) \end{matrix} \right\}$	60%	30
2	1-5	150-230	23-29	60%	30
3	6-10	200-500	16-18	60%	30
4	11-20	200-500	12-16	60%	30
Aggregate (Radar Types 1-4)				80%	120

**Note 1:** Short Pulse Radar Type 0 should be used for the detection bandwidth test, channel move time, and channel closing time tests.

Test A: 15 unique PRI values randomly selected from the list of 23 PRI values in Table 5a  
 Test B: 15 unique PRI values randomly selected within the range of 518-3066 µsec, with a minimum increment of 1 µsec, excluding PRI values selected in Test A  
 A minimum of 30 unique waveforms are required for each of the Short Pulse Radar Types 2 through 4. If more than 30 waveforms are used for Short Pulse Radar Types 2 through 4, then each additional waveform must also be unique and not repeated from the previous waveforms.  
 If more than 30 waveforms are used for Short Pulse Radar Type 1, then each additional waveform is generated with Test B and must also be unique and not repeated from the previous waveforms in Tests A or B.  
 The aggregate is the average of the percentage of successful detections of short pulse radar types

**Shenzhen UnionTrust Quality and Technology Co., Ltd.**

1-4

Table 2-Long Pulse Radar Test Waveform

Radar Type	Pulse Width (μsec)	Chirp Width (MHz)	PRI (μsec)	Number of Pulses per Burst	Number of Bursts	Minimum Percentage of Successful Detection	Minimum Trials
5	50-100	5-20	1000-2000	1-3	8-20	80%	30

Table 3-Frequency Hopping Radar Test Waveform

Radar Type	Pulse Width (μsec)	PRI (μsec)	Pulses per Hop	Hopping Rate (kHz)	Hopping Sequence Length (msec)	Minimum Percentage of Successful Detection	Minimum Trials
6	1	333	9	0.333	300	70%	30

**In-Service Monitoring: Channel Move Time, Channel Closing Transmission Time and Non-Occupancy Period**

**Limit of In-Service Monitoring:**

Reference to DFS Radar Signal Parameter Values.

**Test Procedures:**

- a) One frequency will be chosen from the Operating Channels of the EUT within the 5250-5350 MHz or 5470-5725 MHz bands. For 802.11 devices, the test frequency must contain control signals. This can be verified by disabling channel loading and monitoring the spectrum analyzer. If no control signals are detected, another frequency must be selected within the emission bandwidth where control signals are detected.
- b) In case the EUT is a Master Device, a U-NII device operating as a Client Device will be used and it is assumed that the Client will associate with the EUT (Master). For radiated tests, the emissions of the Radar Waveform generator will be directed towards the Master Device. If the Master Device has antenna gain, the main beam of the antenna will be directed toward the radar emitter. Vertical polarization is used for testing.
- c) The TCP protocol unicast data stream was generated by the iperf software command line with at least 17% activity ratio over any 100ms period.
- d) Timing plots are reported with calculations demonstrating a minimum channel loading of approximately 17% or greater. For example, channel loading can be estimated by setting the spectrum analyzer for zero span and approximate the Time On/ (Time On + Off Time).
- e) At time T<sub>0</sub> the Radar Waveform generator sends a Burst of pulses for one of the Short Pulse Radar Types 1-4 at DFS Detection Threshold levels on the Operating Channel. An additional 1 dB is added to the radar test signal to ensure it is at or above the DFS Detection Threshold, accounting for equipment variations/errors.
- f) Observe the transmissions of the EUT at the end of the radar Burst on the Operating Channel for duration greater than 10 seconds. Measure and record the transmissions from the EUT during the observation time (Channel Move Time). Measure and record the Channel Move Time and Channel Closing Transmission Time if radar detection occurs.
- g) When operating as a Master Device, monitor the EUT for more than 30 minutes following instant T<sub>2</sub> to verify that the EUT does not resume any transmissions on this Channel. Perform this test once and record the measurement result.

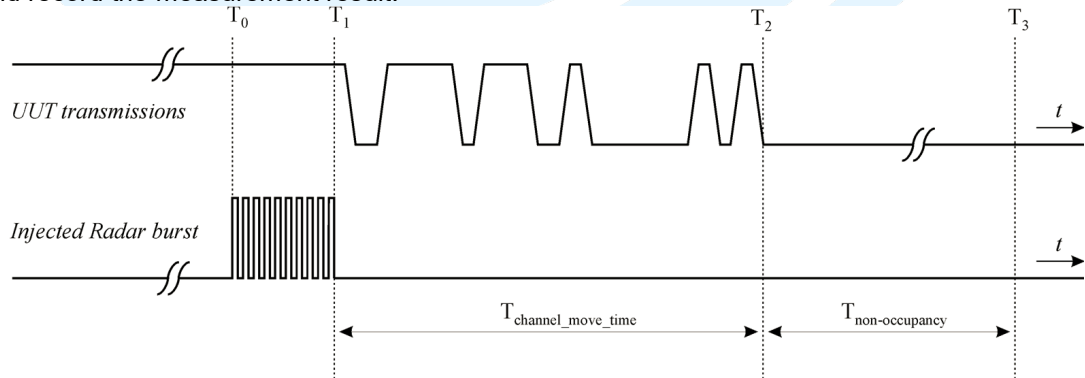
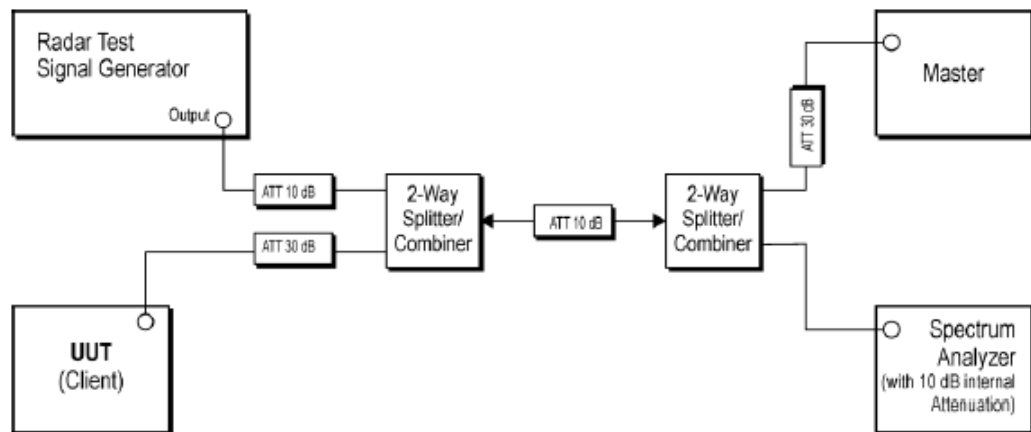

Figure 17: Channel Closing Transmission Time, Channel Move Time and Non-Occupancy Period

**Conducted test setup**



**Setup for Client with injection at the Master**

**Equipment Used:** Refer to section 3 for details.

**Test Result:** Result of Channel Move Time, Channel Closing Transmission Time and Non-Occupancy Period for Client Beacon Test

**The measurement data as follows:**

BW / Channel	Test Item	Test Result	Limit	Pass/Fail
20 MHz / 5300 MHz	Channel Move Time	0.5724 s	< 10s	Pass
	Channel Closing Transmission Time	6.0 ms	< 200+60ms	Pass
	Non-Occupancy Period	No transmission	30 minutes	Pass
20 MHz / 5500 MHz	Channel Move Time	0.5526 s	< 10s	Pass
	Channel Closing Transmission Time	2.4 ms	< 200+60ms	Pass
	Non-Occupancy Period	No transmission	30 minutes	Pass
80 MHz / 5290 MHz	Channel Move Time	0.5392 s	< 10s	Pass
	Channel Closing Transmission Time	0.8 ms	< 200+60ms	Pass
	Non-Occupancy Period	No transmission	30 minutes	Pass
80 MHz / 5530 MHz	Channel Move Time	0.5942 s	< 10s	Pass
	Channel Closing Transmission Time	6.4 ms	< 200+60ms	Pass
	Non-Occupancy Period	No transmission	30 minutes	Pass

Radar Waveform calibration Plot  
Reference DFS test signal

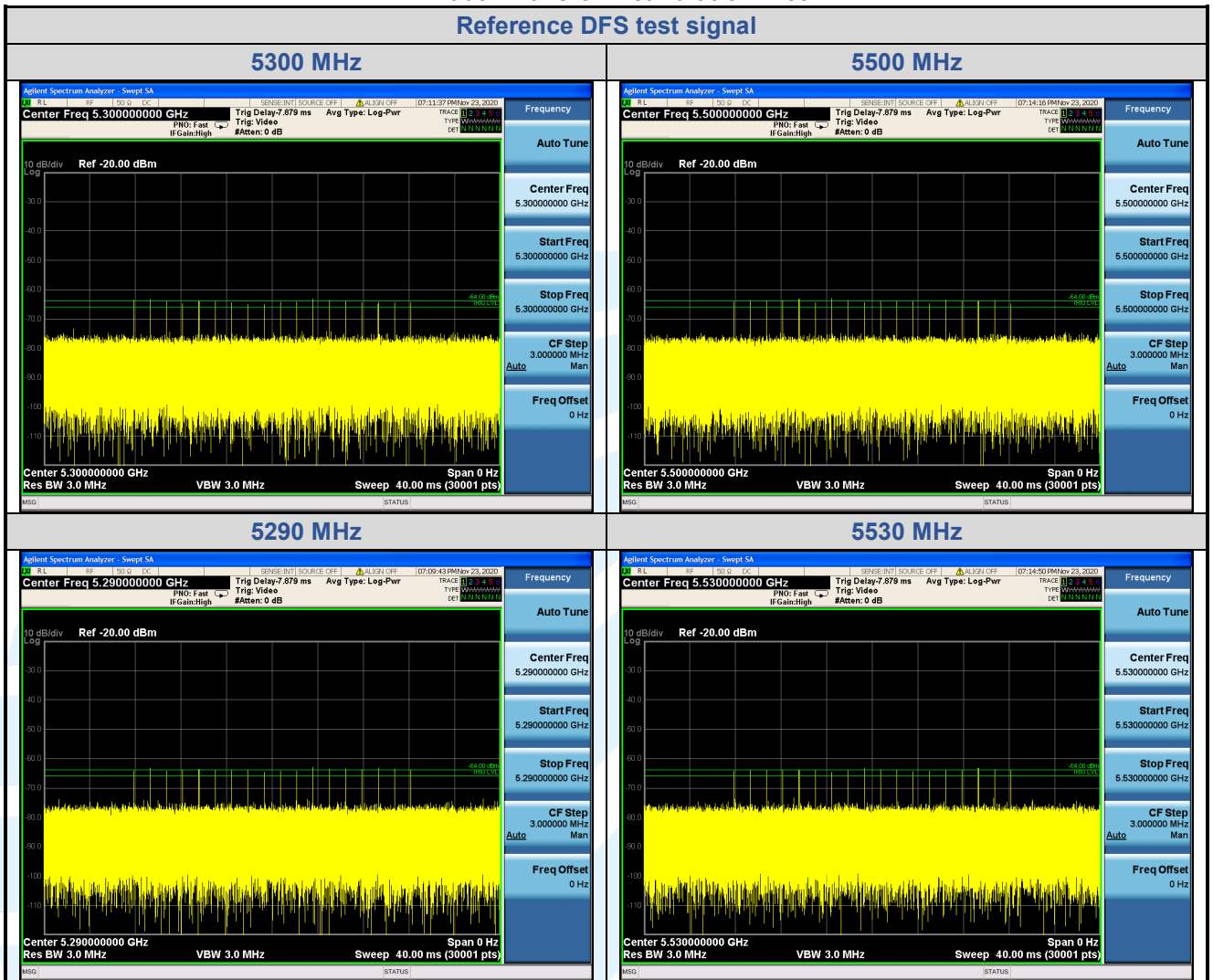

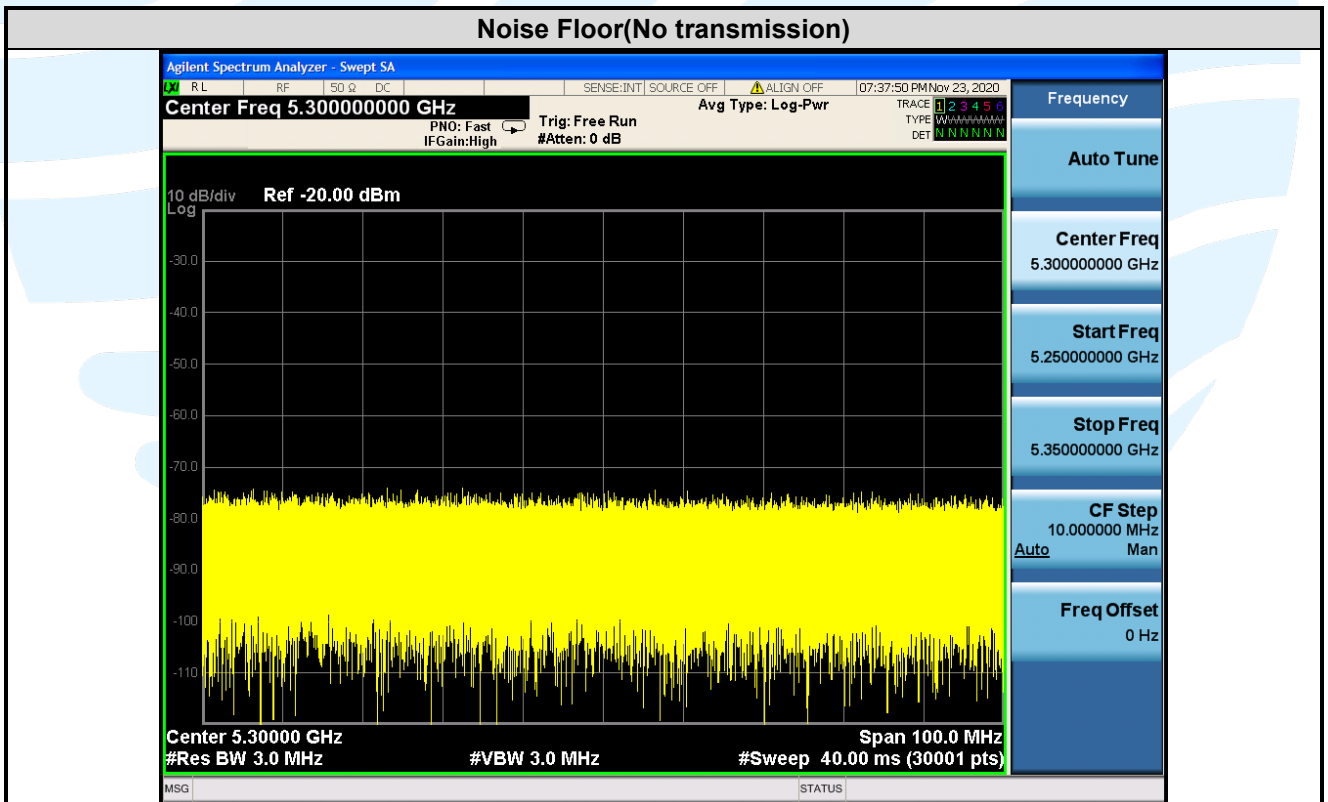
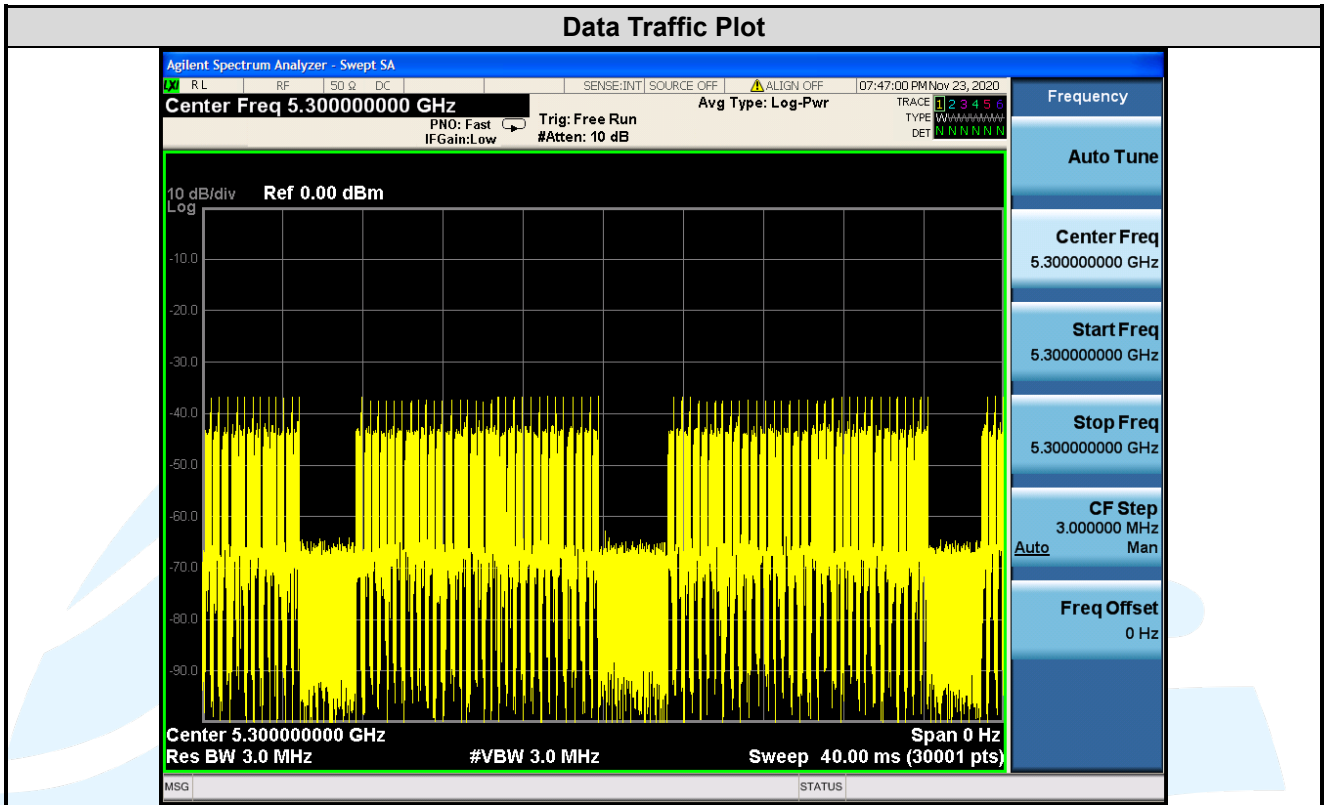

**Shenzhen UnionTrust Quality and Technology Co., Ltd.**

Address: 16/F, Block A, Building 6, Baoneng Science and Technology Park, Qingxiang Road No.1, Longhua New District, Shenzhen, China

Tel: +86-755-28230888

Fax: +86-755-28230886

E-mail: info@uttlab.com

<http://www.uttlab.com>

UTTR-RF-RSS247-V1.0

Channel Move Time & Channel Closing Transmission Time  
802.11a\_5300 MHz



Note:

- 1) Mark1 Time:757.6 ms, Mark2 Time:10757.6ms,Ontime Points: 15
- 2) Dwell = S/B = 12000ms/30001 = 0.4 ms, C = N x Dwell = 15 x 0.4 = 6.0 ms
- 3) CMT = 1.330 s – 0.7576s = 0.5724 s

Non-Occupancy Period\_802.11a\_CH60\_5300 MHz

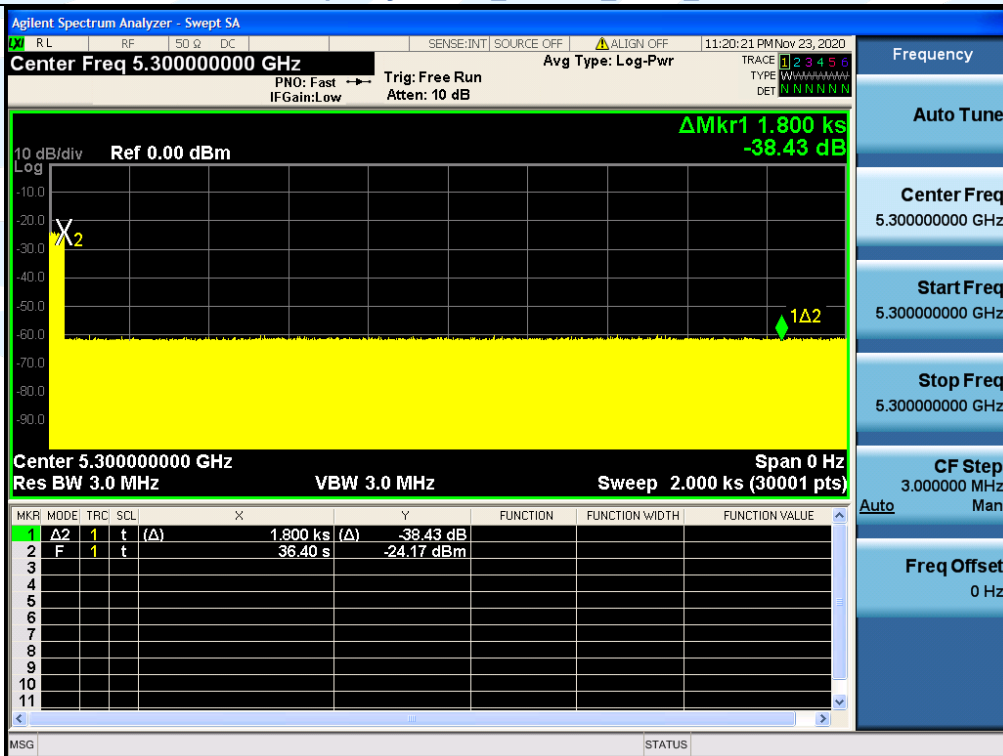

Shenzhen UnionTrust Quality and Technology Co., Ltd.

Address: 16/F, Block A, Building 6, Baoneng Science and Technology Park, Qingxiang Road No.1, Longhua New District, Shenzhen, China

Tel: +86-755-28230888

Fax: +86-755-28230886

E-mail: info@uttlab.com

<http://www.uttlab.com>

UTTR-RF-RSS247-V1.0

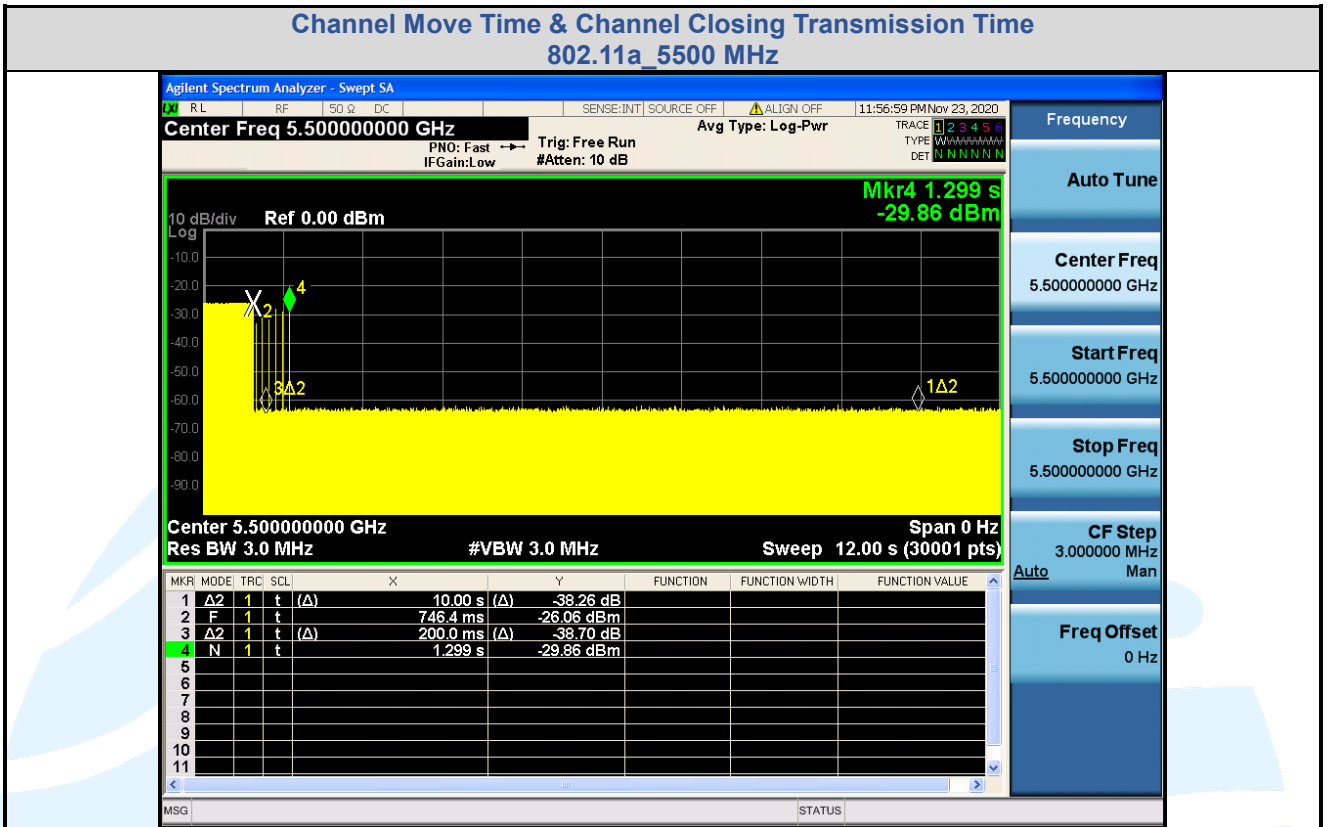

**Note:**

- 1) Mark1 Time:746.4 ms, Mark2 Time: 10746.4 ms, Ontime Points: 6
- 2) Dwell = S/B = 12000ms/30001 = 0.4 ms, C = N x Dwell = 6x 0.4 = 2.4ms
- 3) CMT = 1.299 s – 0.7464s = 0.5526 s

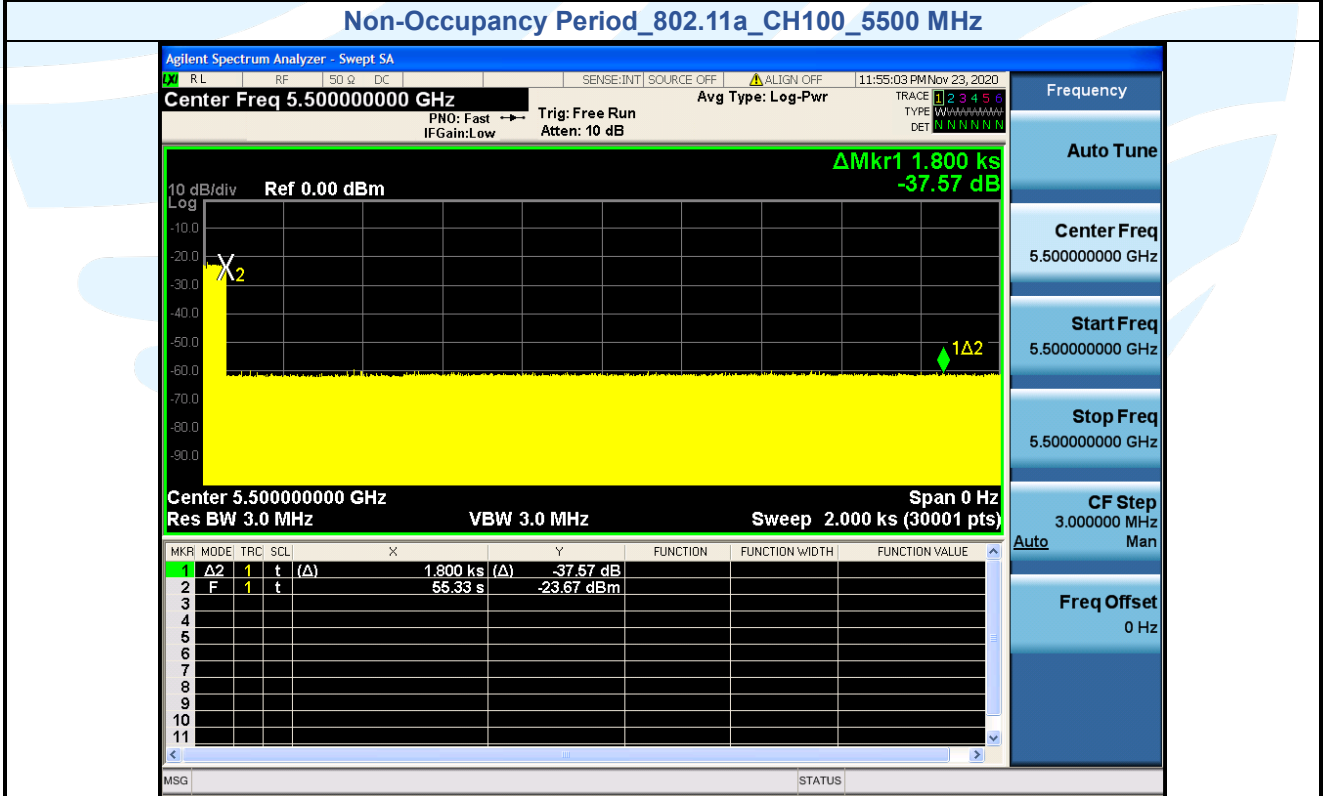

**Shenzhen UnionTrust Quality and Technology Co., Ltd.**

Address: 16/F, Block A, Building 6, Baoneng Science and Technology Park, Qingxiang Road No.1, Longhua New District, Shenzhen, China

Tel: +86-755-28230888

Fax: +86-755-28230886

E-mail: info@uttlab.com

<http://www.uttlab.com>

UTTR-RF-RSS247-V1.0



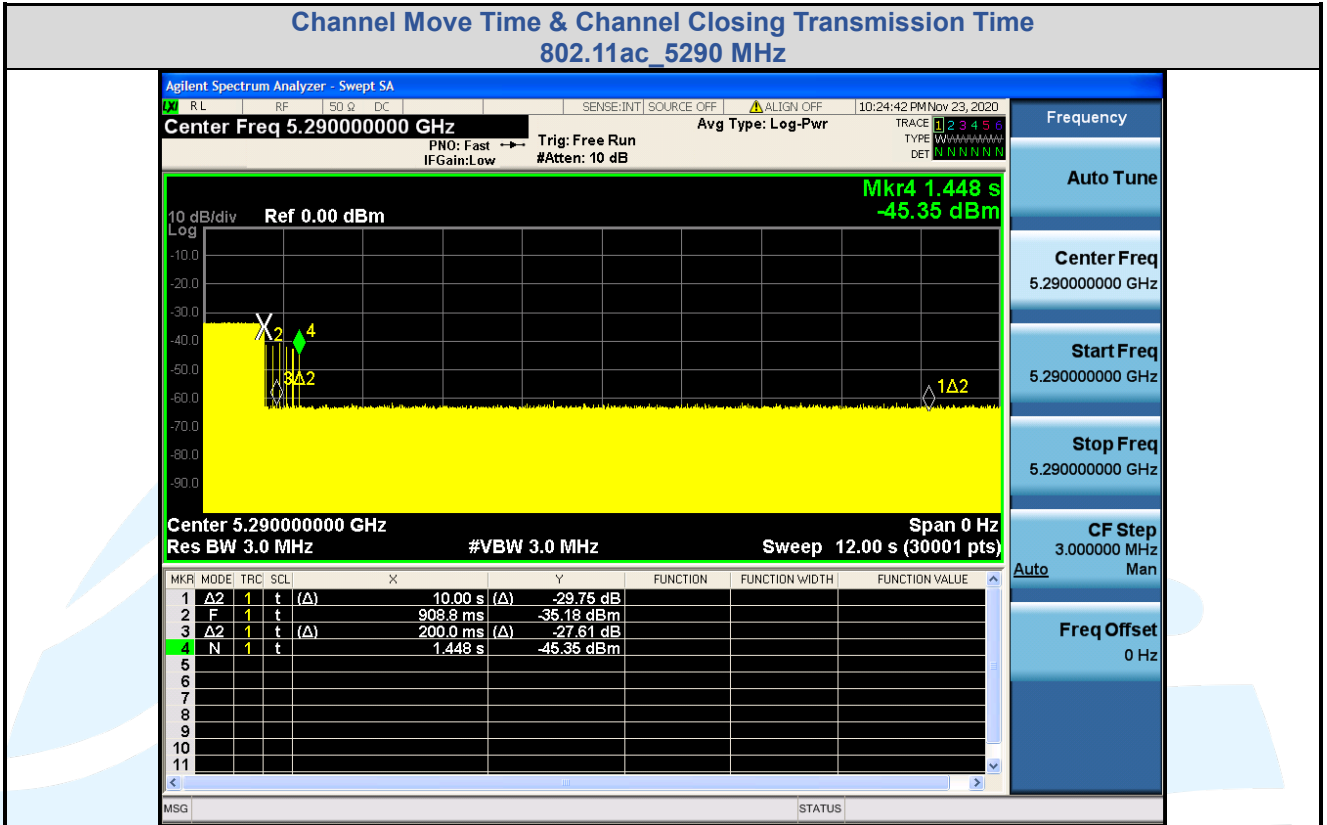

**Note:**

- 1) Mark1 Time: 908.8 ms, Mark2 Time: 10908.8ms, Ontime Points: 2
- 2) Dwell = S/B = 12000ms/30001 = 0.4 ms, C = N x Dwell = 2 x 0.4 = 0.8 ms
- 3) CMT = 1.448s – 0.9088 s = 0.5392 s

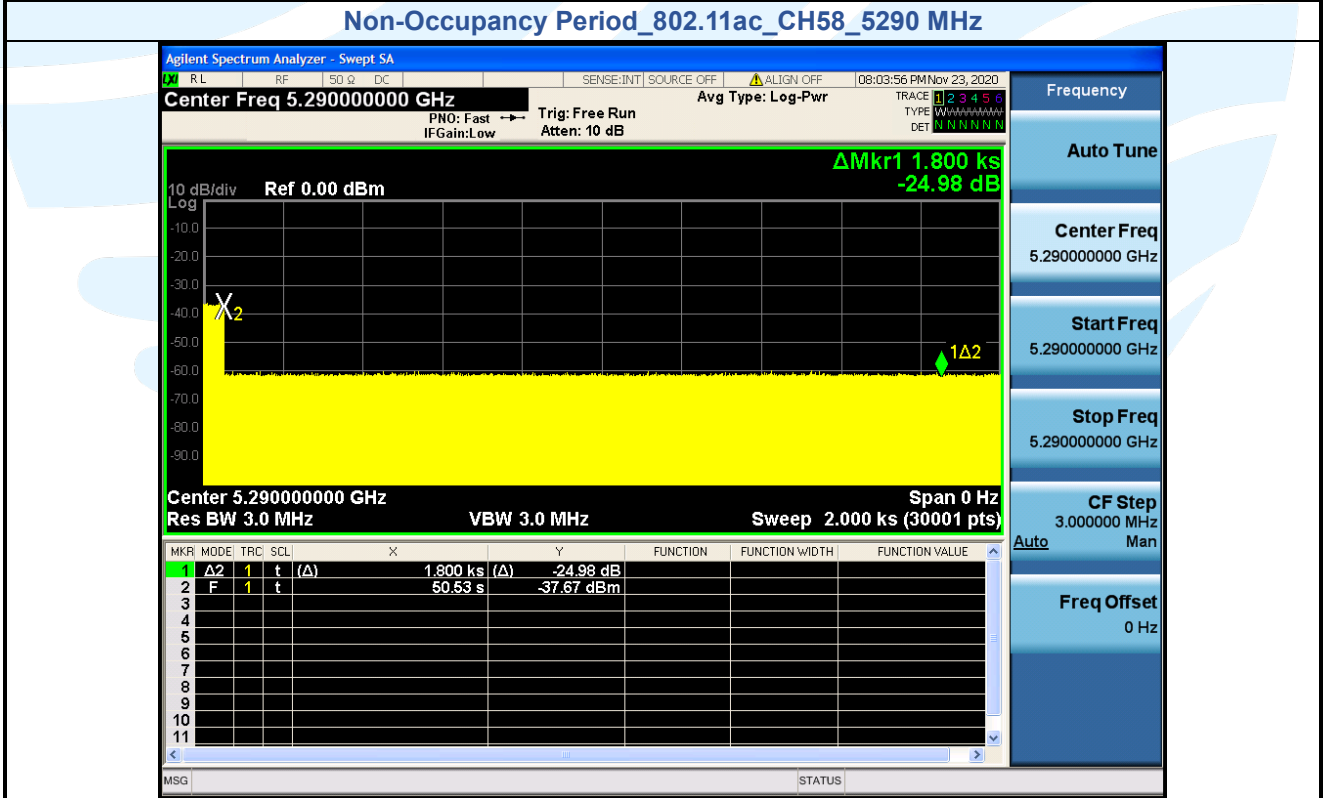

**Shenzhen UnionTrust Quality and Technology Co., Ltd.**

Address: 16/F, Block A, Building 6, Baoneng Science and Technology Park, Qingxiang Road No.1, Longhua New District, Shenzhen, China

Tel: +86-755-28230888

Fax: +86-755-28230886

E-mail: info@uttlab.com

<http://www.uttlab.com>

UTTR-RF-RSS247-V1.0

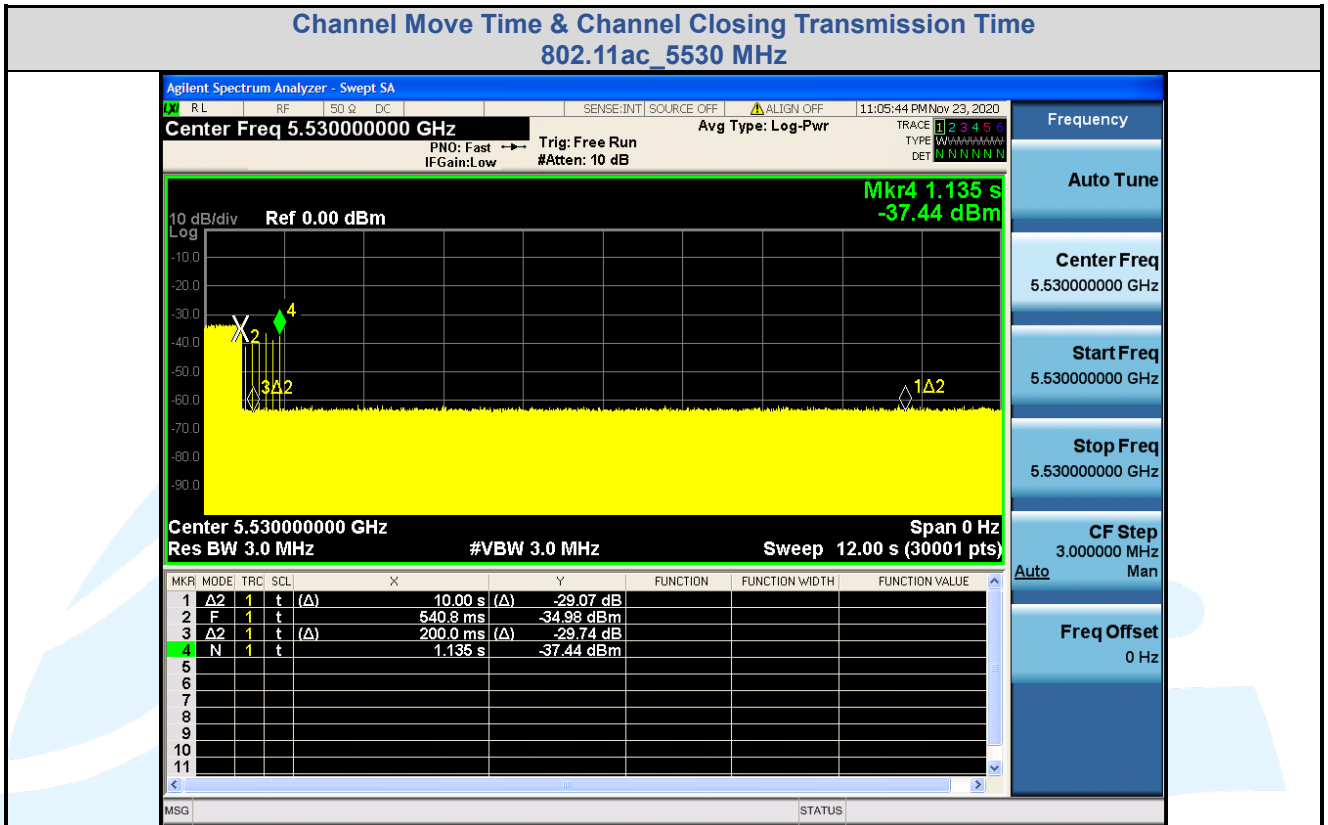

**Note:**

- 1) Mark1 Time: 540.8 ms, Mark2 Time: 10540.8 ms, On-time Points: 16
- 2) Dwell = S/B = 12000ms/30001 = 0.4 ms, C = N x Dwell = 16 x 0.4 = 6.4 ms
- 3) CMT = 1.135s – 0.5408 s = 0.5942 s

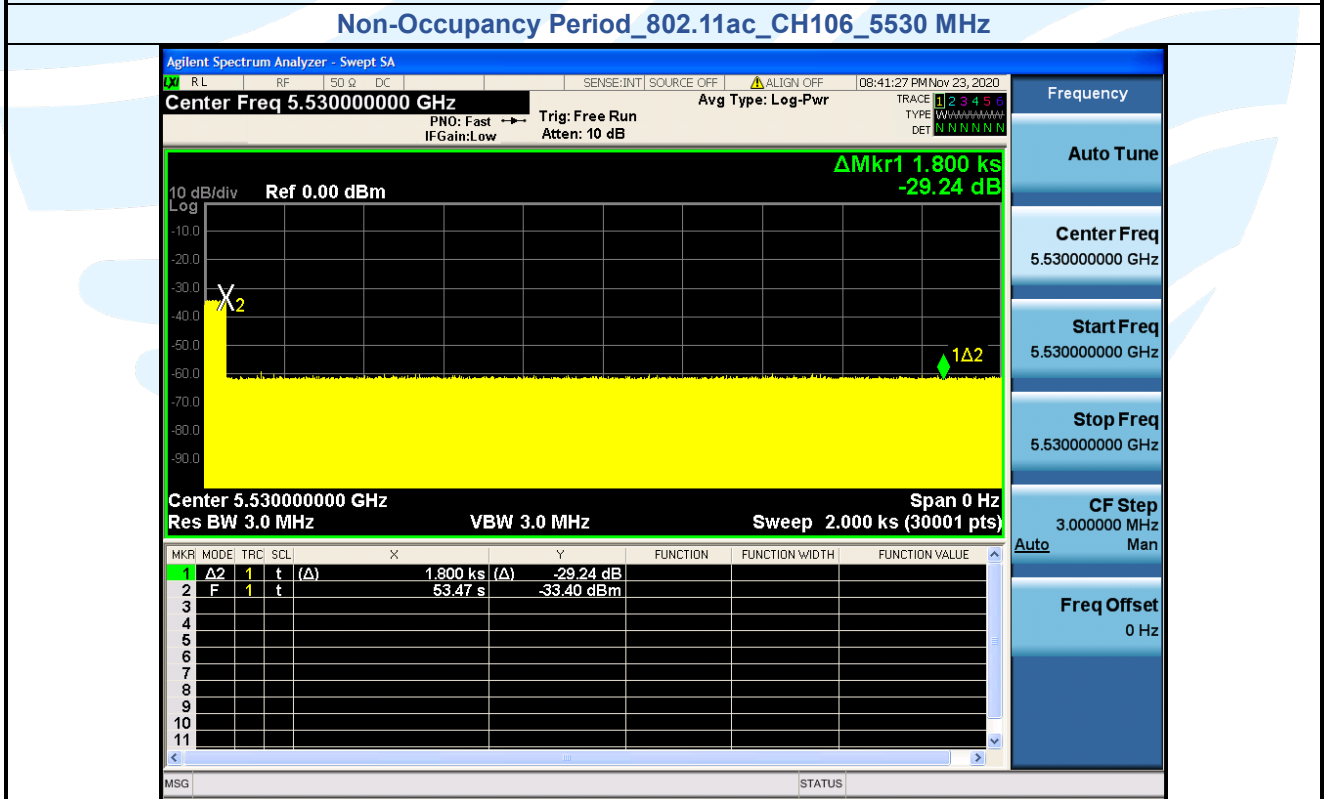

**Shenzhen UnionTrust Quality and Technology Co., Ltd.**

Address: 16/F, Block A, Building 6, Baoneng Science and Technology Park, Qingxiang Road No.1, Longhua New District, Shenzhen, China

Tel: +86-755-28230888

Fax: +86-755-28230886

E-mail: info@uttlab.com

<http://www.uttlab.com>

UTTR-RF-RSS247-V1.0

### 5.9 AC POWER LINE CONDUCTED EMISSION

**Test Requirement:** FCC 47 CFR Part 15 Subpart E Section 15.407 (b)(6)  
 FCC 47 CFR Part 15 Subpart C Section 15.207  
 RSS-Gen Issue 5, Section 8.8

**Test Method:** ANSI C63.10-2013, Section 6.2.

**Limits:**

Frequency range (MHz)	Limits (dB(μV))	
	Quasi-peak	Average
0,15 to 0,50	66 to 56	56 to 46
0,50 to 5	56	46
5 to 30	60	50

**Remark:**

1. The lower limit shall apply at the transition frequencies.
2. The limit decreases linearly with the logarithm of the frequency in the range 0.15 to 0.50 MHz.

**Test Setup:** Refer to section 4.5.2 for details.

**Test Procedures:**

Test frequency range :150KHz-30MHz

- 1) The mains terminal disturbance voltage test was conducted in a shielded room.
- 2) The EUT was connected to AC power source through a LISN 1 (Line Impedance Stabilization Network) which provides a 50Ω/50μH + 5Ω linear impedance. The power cables of all other units of the EUT were connected to a second LISN 2, which was bonded to the ground reference plane in the same way as the LISN 1 for the unit being measured. A multiple socket outlet strip was used to connect multiple power cables to a single LISN provided the rating of the LISN was not exceeded.
- 3) The tabletop EUT was placed upon a non-metallic table 0.8m above the ground reference plane. And for floor-standing arrangement, the EUT was placed on the horizontal ground reference plane,
- 4) The test was performed with a vertical ground reference plane. The rear of the EUT shall be 0.4 m from the vertical ground reference plane. The vertical ground reference plane was bonded to the horizontal ground reference plane. The LISN 1 was placed 0.8 m from the boundary of the unit under test and bonded to a ground reference plane for LISNs mounted on top of the ground reference plane. This distance was between the closest points of the LISN 1 and the EUT. All other units of the EUT and associated equipment was at least 0.8 m from the LISN 2.
- 5) In order to find the maximum emission, the relative positions of equipment and all of the interface cables must be changed according to ANSI C63.10 on conducted measurement.

**Equipment Used:** Refer to section 3 for details.

**Test Result:** Pass

The measurement data as follows:  
 Quasi Peak and Average:  
 Mode: WIFI Link

Live Line

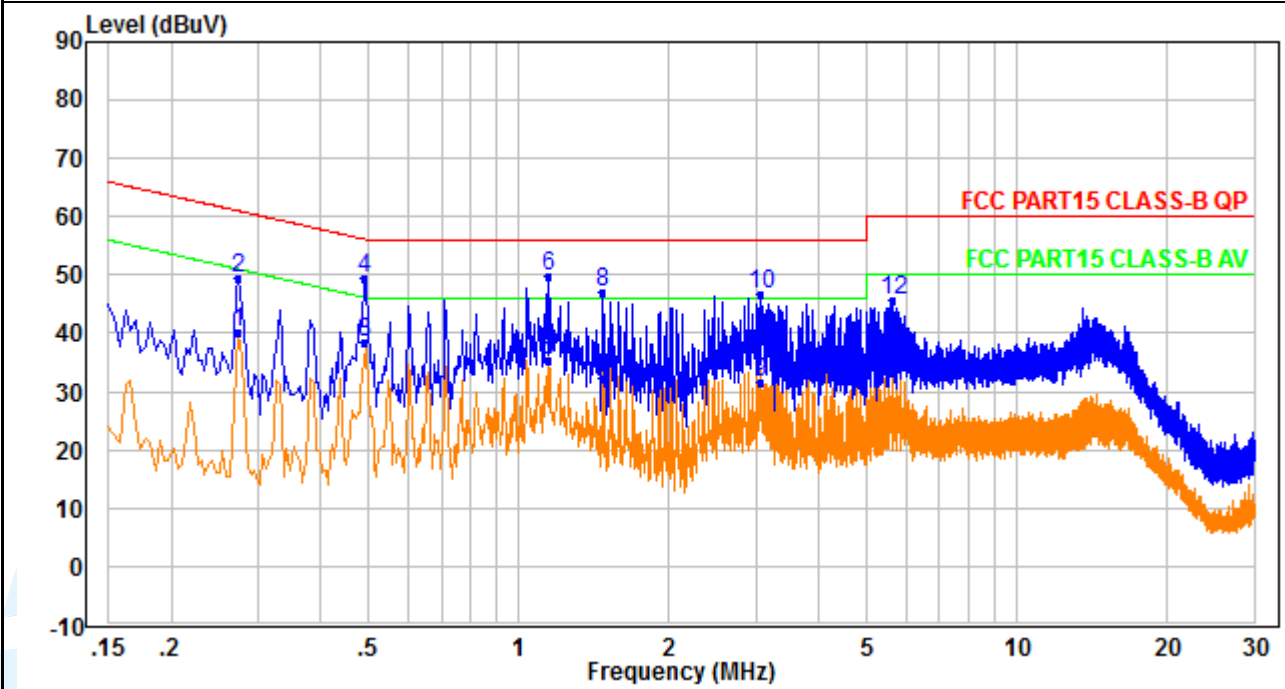

No.	Frequency (MHz)	Reading (dB $\mu$ V)	Correction factor (dB)	Result (dB $\mu$ V)	Limit (dB $\mu$ V)	Margin (dB)	Detector
1	0.274	31.10	9.17	40.27	51.00	-10.73	Average
2	0.274	40.31	9.17	49.48	61.00	-11.52	QP
3	0.490	29.28	9.30	38.58	46.17	-7.59	Average
4	0.490	40.23	9.30	49.53	56.17	-6.64	QP
5	1.150	25.79	9.44	35.23	46.00	-10.77	Average
6	1.150	40.36	9.44	49.80	56.00	-6.20	QP
7	1.478	22.80	9.50	32.30	46.00	-13.70	Average
8	1.478	37.58	9.50	47.08	56.00	-8.92	QP
9	3.058	21.93	9.61	31.54	46.00	-14.46	Average
10	3.058	37.23	9.61	46.84	56.00	-9.16	QP
11	5.630	23.73	9.65	33.38	50.00	-16.62	Average
12	5.630	35.87	9.65	45.52	60.00	-14.48	QP

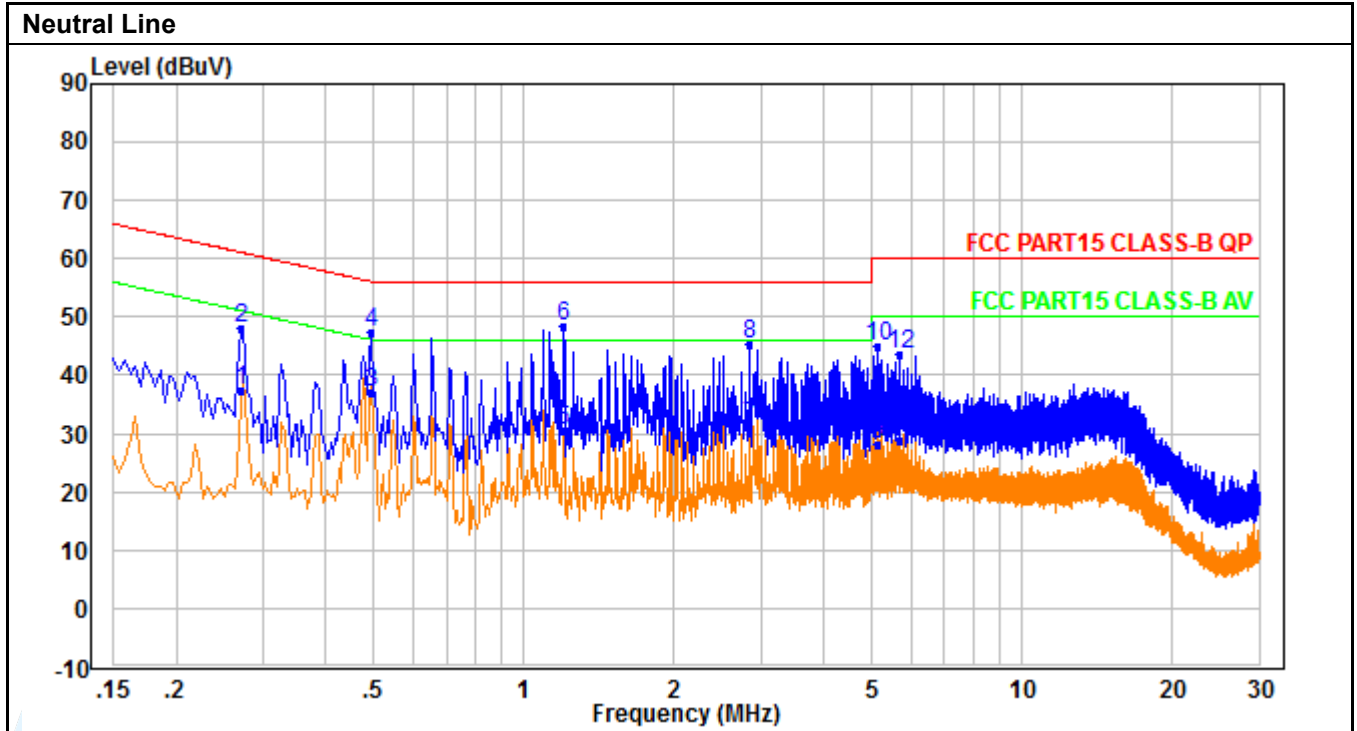

No.	Frequency (MHz)	Reading (dBμV)	Correction factor (dB)	Result (dBμV)	Limit (dBμV)	Margin (dB)	Detector
1	0.270	28.41	9.15	37.56	51.12	-13.56	Average
2	0.270	38.94	9.15	48.09	61.12	-13.03	QP
3	0.494	27.82	9.33	37.15	46.10	-8.95	Average
4	0.494	38.08	9.33	47.41	56.10	-8.69	QP
5	1.202	21.25	9.46	30.71	46.00	-15.29	Average
6	1.202	39.12	9.46	48.58	56.00	-7.42	QP
7	2.842	21.51	9.61	31.12	46.00	-14.88	Average
8	2.842	35.65	9.61	45.26	56.00	-10.74	QP
9	5.146	18.52	9.63	28.15	50.00	-21.85	Average
10	5.146	35.35	9.63	44.98	60.00	-15.02	QP
11	5.690	19.21	9.65	28.86	50.00	-21.14	Average
12	5.690	34.01	9.65	43.66	60.00	-16.34	QP

Remark:

1. Correct Factor = LISN Factor + Cable Loss + Pulse Limiter Factor, the value was added to Original Receiver Reading by the software automatically.
2. Result = Reading + Correct Factor.
3. Margin = Result - Limit
4. An initial pre-scan was performed on the Phase and neutral lines with peak detector. Quasi-Peak and Average measurement were performed at the frequencies with maximized peak emission were detected.
5. All possible modes of operation were investigated, and testing at two nominal voltages of 240V/50Hz and 120V/60Hz, only the worst case emissions reported.

**Shenzhen UnionTrust Quality and Technology Co., Ltd.**

## APPENDIX 1 PHOTOS OF TEST SETUP

See test photos attached in Appendix 1 for the actual connections between Product and support equipment.

## APPENDIX 2 PHOTOS OF EUT CONSTRUCTIONAL DETAILS

Refer to Appendix 2 for EUT external and internal photos.

\*\*\* End of Report \*\*\*

---

---

The test report is effective only with both signature and specialized stamp. The result(s) shown in this report refer only to the sample(s) tested. Without written approval of UnionTrust, this report can't be reproduced except in full.

---

---