

Grandstream Networks, Inc.

126 Brookline Ave, 3rd Floor
Boston, MA 02215. USA
Tel : +1 (617) 566 - 9300
Fax: +1 (617) 249 - 1987

www.grandstream.com



GHP620 GHP621

Compact Hotel Phone

Quick Installation Guide



For Certification, Warranty and RMA information, please visit
www.grandstream.com

The GHP620 and GHP621 are not pre-configured to support or carry emergency calls to any type of hospital, law enforcement agency, medical care unit (“Emergency Service(s)”), or any other kind of Emergency Service. You must make additional arrangements to access Emergency Services. It is your responsibility to purchase SIP-compliant Internet telephone service, properly configure the GHP620/ GHP621 to use that service, and periodically test your configuration to confirm that it works as you expect. If you do not do so, it is your responsibility to purchase traditional wireless or landline telephone services to access Emergency Services.

GRANDSTREAM DOES NOT PROVIDE CONNECTIONS TO EMERGENCY SERVICES VIA THE GHP620 AND THE GHP621. NEITHER GRANDSTREAM NOR ITS OFFICERS, EMPLOYEES OR AFFILIATES MAY BE HELD LIABLE FOR ANY CLAIM, DAMAGE, OR LOSS. YOU HEREBY WAIVE ANY AND ALL SUCH CLAIMS OR CAUSES OF ACTION ARISING FROM OR RELATING TO YOUR INABILITY TO USE THE GHP620 AND GHP621 TO CONTACT EMERGENCY SERVICES, AND YOUR FAILURE TO MAKE ADDITIONAL ARRANGEMENTS TO ACCESS EMERGENCY SERVICES IN ACCORDANCE WITH THE IMMEDIATELY PRECEDING PARAGRAPH.

The GNU GPL license terms are incorporated into the device firmware and can be accessed via the Web user interface of the device at [http\(s\)://IP#/gpl_license](http(s)://IP#/gpl_license). To obtain a CD with GPL source code information please submit a written request to info@grandstream.com

PRECAUTIONS:

WARNING: Please DO NOT power cycle the GHP620 and GHP621 during system bootup or firmware upgrade. You may corrupt firmware image files and cause the unit to malfunction.

OVERVIEW:

The GHP series of hotel phones feature the GHP620 and the GHP621, easy-to-use IP phones for any hotel room that can be programmed and customized based on the needs of the hotel and their guests. The GHP series features of the series include; one HD speaker on each handset, 2 SIP accounts/lines, 6 programmable keys, 10 speed dial keys, 3-way voice conferencing, full band Opus voice codec, and advanced jitter-resilience algorithm that tolerates up to 30% packet loss without impacting voice quality. The series is supported by Grandstream’s Device Management System (GDMS), which provides a centralized interface to configure, provision, manage and monitor the deployment of Grand-stream endpoints. GHP series IP phones can be installed on desktop or wall-mounted, and powered by PoE (GHP620/GHP621) and USB Type C charging. Its compact design makes it perfect for any hotel deployment. These IP Phones could also be used for deployments in settings such as hospitals, apartments, dormitories, and more.

PACKAGE CONTENT:

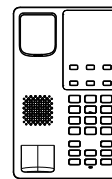

1x GHP62X
Phone



1x Handset

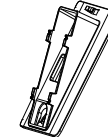

1x Base Stand



1x Faceplate



1x RJ11(4P4C)
Phone Cord



1x Quick Installation
Guide

GHP620 & GHP621 DESCRIPTION:

Front panel

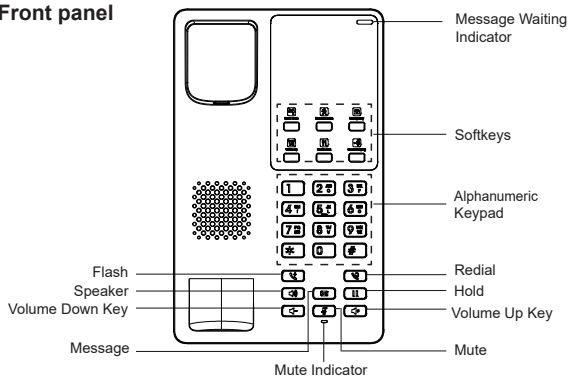

Note: The LED for the message waiting indicator will flash in green when there is a message waiting.

Back panel

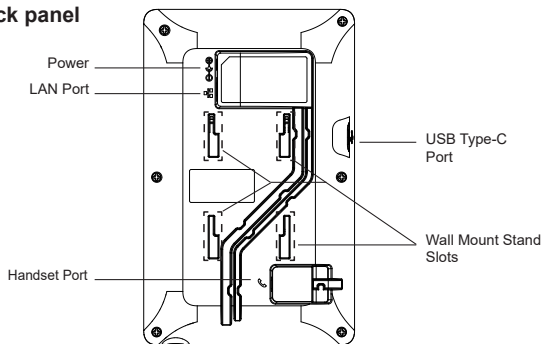

PHONE SETUP:

Wall Mount

1. On the wall where the GHP620 & GHP621 will be mounted, mark two dots with 100mm distance in between vertically.
2. Using a drill, make a hole on each marked dot. Put a plastic expansion bolt and screw (not provided) into each hole. Leave enough space on the screws to mount the GHP620 & GHP621.
3. Attach the wall mount spacers to the slot for wall mount spacers on the back of the phone.
4. Mount the GHP620 & GHP621 on the screws using its "Wall Mount Slots".

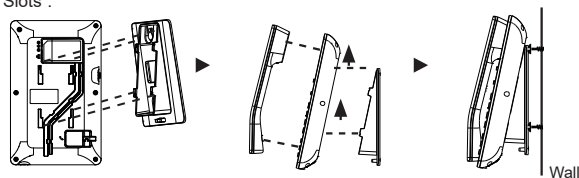

Desktop Installation

For installing the phone on the table with the phone stand, attach the phone stand to the bottom of the phone where there is a slot for the phone stand.

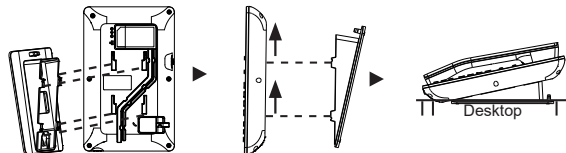

INSTALLING THE FACEPLATE:

1. Remove the release paper from the back of the faceplate.
2. Stick the faceplate on the indicated area. Please refer to the illustration.

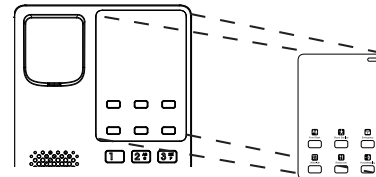

CONNECTING THE PHONE:

To set up the phone, follow the steps below:

1. Plug in the phone cord to the handset RJ11 port and then connect it to the base.
2. Connect the LAN port of the phone to the RJ45 socket of a hub/switch or a router (LAN side of the router) using the Ethernet cable.
3. Power up the phone:
 - For **GHP620 & GHP621**: A PoE switch must be used in step 2.

PHONE CONFIGURATION:

1. Ensure your phone is powered up and connected to the Internet.
2. Locate the MAC address on the bottom of the device or on the package.
3. From a computer connected to the same network as the GHP62X, type in the following address using the GHP62X's MAC address on your browser:
https://<mac>.local
Example: https://c074adffff.local
Note: The user can also dial ****47#** and the current IP address will be announced by the IVR.
4. Enter the admin username and password to access the configuration menu. (The factory default username is "admin" and the default random password can be found on the sticker at the back of the unit).

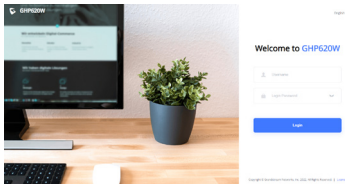

Refer to online documents and FAQ for more detailed information: <https://www.grandstream.com/our-products>

For certification information, please refer to User Manuals:

<http://www.grandstream.com>

U.S. FCC Part 68 Regulatory Information

This equipment complies with Part 68 of the FCC rules. Located on the equipment is a label that contains, among other information, the ACTA registration number and ringer equivalence number (REN.) If requested, this information must be provided to the telephone company.

The REN is used to determine the quantity of devices which may be connected to the telephone line. Excessive REN's on the telephone line may result in the devices not ringing in response to an incoming call. In most, but not all areas, the sum of the REN's should not exceed five (5.0). To be certain of the number of devices that may be connected to the line, as determined by the total REN's contact the telephone company to determine the maximum REN for the calling area.

This equipment cannot be used on the telephone company-provided coin service. Connection to Party Line Service is subject to State Tariffs.

If this equipment causes harm to the telephone network, the telephone company will notify you in advance that temporary discontinuance of service may be required. If advance notice isn't practical, the telephone company will notify the customer as soon as possible. Also, you will be advised of your right to file a complaint with the FCC if you believe it is necessary.

The telephone company may make changes in its facilities, equipment, operations, or procedures that could affect the operation of the equipment. If this happens, the telephone company will provide advance notice in order for you to make the necessary modifications in order to maintain uninterrupted service.

If the trouble is causing harm to the telephone network, the telephone company may request you to remove the equipment from the network until the problem is resolved.

This equipment uses the following USOC jacks: RJ45C.

It is recommended that the customer install an AC surge arrester in the AC outlet to which this device is connected. This is to avoid damaging the equipment caused by local lightning strikes and other electrical surges.

If trouble is experienced with this equipment, please contact (Agent in the US):

[Company Name: Grandstream Networks, Inc.](#)

[Address: 126 Brookline Ave, 3rd Floor Boston, MA 02215, USA](#)

[Tel: 1-617-5669300](#)

[Fax: 1-617-2491987](#)

U.S. FCC Part 15 Regulatory Information

This device complies with part 15 of the FCC Rules. Operation is subject to the following two conditions:(1) this device may not cause harmful interference, and(2) this device must accept any interference received, including interference that may cause undesired operation.

Any Changes or modifications not expressly approved by the party responsible for compliance could void the user's authority to operate the equipment.

Note: This equipment has been tested and found to comply with the limits for a Class B digital device, pursuant to part 15 of the FCC Rules. These limits are designed to provide reasonable protection against harmful interference in a residential installation. This equipment generates, uses and can radiate radio frequency energy and, if not installed and used in accordance with the instructions, may cause harmful interference to radio communications. However, there is no guarantee that interference will not occur in a particular installation. If this equipment does cause harmful interference to radio or television reception, which can be determined by turning the equipment off and on, the user is encouraged to try to correct the interference by one or more of the following measures:

- Reorient or relocate the receiving antenna.
- Increase the separation between the equipment and receiver.
- Connect the equipment into an outlet on a circuit different from that to which the receiver is connected.
- Consult the dealer or an experienced radio/TV technician for help.

Canada Regulatory Information

This product meets the applicable Innovation, Science and Economic Development Canada technical specifications.

The Ringer Equivalence Number (REN) indicates the maximum number of devices allowed to be connected to a telephone interface. The termination of an interface may consist of any combination of devices subject only to the

requirement that the sum of the RENs of all the devices not exceed five.

Ce produit répond à la innovation, des sciences et de Développement économique Canada spécifications techniques applicables.

Le nombre équivalent de sonneries (REN) indique le nombre maximal de terminaux qui peuvent être raccordés à une interface téléphonique. La terminaison d'une interface peut consister en une combinaison de dispositifs, à la seule condition que la somme des REN de tous les dispositifs ne dépasse pas cinq.

EU Regulatory Information

Hereby, [[Grandstream Networks, Inc.](#)] declares that the radio equipment type [[GHP621](#), [GHP620](#)] is in compliance with Directive 2014/30/EU.

The full text of the EU declaration of conformity is available at the following internet address: www.grandstream.com

UK Regulatory Information

Hereby, [[Grandstream Networks, Inc.](#)] declares that the radio equipment type [[GHP621](#), [GHP620](#)] is in compliance with UK SI 2016 No. 1091

The full text of the UK declaration of conformity is available at the following internet address: www.grandstream.com