



Certificate #4312.01

# TEST REPORT

**Product Name:** Compact Hotel Phone  
**Trade Mark:** GRANDSTREAM  
**Model No. / HVIN:** GHP611W  
**Add. Model No. / HVIN:** GHP610W  
**Report Number:** 220716463RFC-2  
**Test Standards:** FCC 47 CFR Part 15 Subpart E  
 RSS-247 Issue 2  
 RSS-Gen Issue 5  
**FCC ID:** YZZGHP61XW  
**IC:** 11964A-GHP61XW  
**Test Result:** PASS  
**Date of Issue:** September 23, 2022

Prepared for:

**Grandstream Networks, Inc.**  
**126 Brookline Ave., 3rd Floor, Boston, MA 02215, USA**

Prepared by:

**Shenzhen UnionTrust Quality and Technology Co., Ltd.**  
**Unit D/E of 9/F and 16/F, Block A, Building 6, Baoneng science and  
 technology park, Longhua district, Shenzhen, China**  
**TEL: +86-755-2823 0888**  
**FAX: +86-755-2823 0886**

Prepared by:

Kieron Luo  
 Project Engineer

Reviewed by:

Henry Lu  
 Team Leader

Approved by:

Kevin Liang  
 Assistant Manager

Date:

September 23, 2022

**Shenzhen UnionTrust Quality and Technology Co., Ltd.**

Address: Unit D/E of 9/F and 16/F, Block A, Building 6, Baoneng science and technology park, Longhua district, Shenzhen, China

Tel: +86-755-28230888

Fax: +86-755-28230886

E-mail: info@uttlab.com

<http://www.uttlab.com>

UTTR-RF-RSS247-V1.1

**Version**

Version No.	Date	Description
V1.0	September 23, 2022	Original

**Shenzhen UnionTrust Quality and Technology Co., Ltd.**

Address: Unit D/E of 9/F and 16/F, Block A, Building 6, Baoneng science and technology park, Longhua district, Shenzhen, China

Tel: +86-755-28230888

Fax: +86-755-28230886

E-mail: [info@uttlab.com](mailto:info@uttlab.com)<http://www.uttlab.com>UTTR-RF-RSS247-V1.1

## CONTENTS

<b>1. GENERAL INFORMATION</b>	<b>4</b>
1.1 CLIENT INFORMATION	4
1.2 EUT INFORMATION	4
1.2.1 GENERAL DESCRIPTION OF EUT	4
1.2.2 DESCRIPTION OF ACCESSORIES	4
1.3 PRODUCT SPECIFICATION SUBJECTIVE TO THIS STANDARD	5
1.4 OTHER INFORMATION	6
1.5 DESCRIPTION OF SUPPORT UNITS	6
1.6 TEST LOCATION	7
1.7 TEST FACILITY	7
1.8 DEVIATION FROM STANDARDS	7
1.9 ABNORMALITIES FROM STANDARD CONDITIONS	7
1.10 OTHER INFORMATION REQUESTED BY THE CUSTOMER	7
1.11 MEASUREMENT UNCERTAINTY	8
<b>2. TEST SUMMARY</b>	<b>9</b>
<b>3. EQUIPMENT LIST</b>	<b>10</b>
<b>4. TEST CONFIGURATION</b>	<b>11</b>
4.1 ENVIRONMENTAL CONDITIONS FOR TESTING	11
4.1.1 NORMAL OR EXTREME TEST CONDITIONS	11
4.1.2 RECORD OF NORMAL ENVIRONMENT AND TEST SAMPLE	11
4.2 TEST CHANNELS	12
4.3 EUT TEST STATUS	12
4.4 PRE-SCAN	13
4.5 TEST SETUP	14
4.5.1 FOR RADIATED EMISSIONS TEST SETUP	14
4.5.2 FOR CONDUCTED EMISSIONS TEST SETUP	15
4.5.3 FOR CONDUCTED RF TEST SETUP	16
4.6 SYSTEM TEST CONFIGURATION	17
4.7 DUTY CYCLE	18
<b>5. RADIO TECHNICAL REQUIREMENTS SPECIFICATION</b>	<b>22</b>
5.1 REFERENCE DOCUMENTS FOR TESTING	22
5.2 ANTENNA REQUIREMENT	22
5.3 26 DB BANDWIDTH & OCCUPIED BANDWIDTH	23
5.4 6 DB BANDWIDTH & OCCUPIED BANDWIDTH	35
5.5 MAXIMUM CONDUCTED OUTPUT POWER OR E.I.R.P	43
5.6 PEAK POWER SPECTRAL DENSITY	49
5.7 RADIATED EMISSIONS AND BAND EDGE MEASUREMENT	66
5.8 DYNAMIC FREQUENCY SELECTION	105
5.9 AC POWER LINE CONDUCTED EMISSION	115
<b>APPENDIX 1 PHOTOS OF TEST SETUP</b>	<b>118</b>
<b>APPENDIX 2 PHOTOS OF EUT CONSTRUCTIONAL DETAILS</b>	<b>118</b>

# 1. GENERAL INFORMATION

## 1.1 CLIENT INFORMATION

<b>Applicant:</b>	Grandstream Networks, Inc.
<b>Address of Applicant:</b>	126 Brookline Ave., 3rd Floor, Boston, MA 02215, USA
<b>Manufacturer:</b>	Grandstream Networks, Inc.
<b>Address of Manufacturer:</b>	126 Brookline Ave., 3rd Floor, Boston, MA 02215, USA

## 1.2 EUT INFORMATION

### 1.2.1 General Description of EUT

<b>Product Name:</b>	Compact Hotel Phone		
<b>Model No. / HVIN:</b>	GHP611W		
<b>Add. Model No. / HVIN:</b>	GHP610W		
<b>Trade Mark:</b>	GRANDSTREAM		
<b>DUT Stage:</b>	Identical Prototype		
<b>EUT Supports Function:</b> (Provided by the customer)	2.4 GHz ISM Band:	IEEE 802.11b/g/n	
	5 GHz U-NII Bands:	5 150 MHz to 5 250 MHz	IEEE 802.11a/n/ac
		5 250 MHz to 5 350 MHz	IEEE 802.11a/n/ac
		5 470 MHz to 5 725 MHz	IEEE 802.11a/n/ac
5 725 MHz to 5 850 MHz		IEEE 802.11a/n/ac	
<b>Sample Received Date:</b>	July 13, 2022		
<b>Sample Tested Date:</b>	July 13, 2022 to August 20, 2022		
<b>Note:</b> The test data is gathered from a production sample, provided by the manufacturer. The appearance color of others models listed in the report is different from main-test model GHP611W, but the circuit and the electronic construction do not change, declared by the manufacturer.			

**Remark:** The above EUT's information was provided by customer. Please refer to the specifications or user's manual for more detailed description.

### 1.2.2 Description of Accessories

Adapter(1)	
<b>Model No.:</b>	F06US1200050A
<b>Input:</b>	100-240 V~50/60 Hz 0.2 A max
<b>Output:</b>	12 V = 0.5 A
<b>DC Cable:</b>	1.8 Meter, Unshielded without ferrite

Adapter(2)	
<b>Model No.:</b>	NBS05B120050VU
<b>Input:</b>	100-240 V~50/60 Hz 0.2 A
<b>Output:</b>	12.0 V = 0.5 A
<b>DC Cable:</b>	1.8 Meter, Unshielded without ferrite

Adapter(3)	
<b>Model No.:</b>	GQ06-120050-ZU
<b>Input:</b>	100-240 V~50/60 Hz 0.3 A Max
<b>Output:</b>	12.0 V = 0.5 A
<b>DC Cable:</b>	1.8 Meter, Unshielded without ferrite

### Shenzhen UnionTrust Quality and Technology Co., Ltd.

Address: Unit D/E of 9/F and 16/F, Block A, Building 6, Baoneng science and technology park, Longhua district, Shenzhen, China

Tel: +86-755-28230888

Fax: +86-755-28230886

E-mail: info@uttlab.com

<http://www.uttlab.com>

UTTR-RF-RSS247-V1.1

Cable	
Connector:	Phone Cord
Cable Type:	Unshielded without ferrite
Length:	3.0 Meter

Others	
Charging base	

### 1.3 PRODUCT SPECIFICATION SUBJECTIVE TO THIS STANDARD

<b>Frequency Bands:</b>	5150 MHz to 5250 MHz (U-NII-1)
	5250 MHz to 5350 MHz (U-NII-2A)
	5470 MHz to 5725 MHz (U-NII-2C)
	5725 MHz to 5850 MHz (U-NII-3)
<b>Frequency Ranges:</b>	5180 MHz to 5240 MHz
	5260 MHz to 5320 MHz
	5500 MHz to 5700 MHz
	5745 MHz to 5825 MHz
<b>Support Standards:</b>	IEEE 802.11a/n/ac
<b>TPC Function:</b>	Not Support
<b>DFS Operational mode:</b>	Slave without radar Interference detection function
<b>Type of Modulation:</b>	IEEE 802.11a: OFDM(64QAM, 16QAM, QPSK, BPSK)
	IEEE 802.11n: OFDM(64QAM, 16QAM, QPSK, BPSK)
	IEEE 802.11ac: OFDM(256QAM, 64QAM, 16QAM, QPSK, BPSK)
<b>Channel Spacing:</b>	IEEE 802.11a/n-HT20/ac-VHT20: 20 MHz
	IEEE 802.11n-HT40/ac-VHT40: 40 MHz
	IEEE 802.11ac-VHT80: 80 MHz
<b>Data Rate:</b>	IEEE 802.11a: Up to 54 Mbps
	IEEE 802.11n-HT20: Up to MCS7
	IEEE 802.11n-HT40: Up to MCS7
	IEEE 802.11ac-VHT20: Up to MCS8
	IEEE 802.11ac-VHT40: Up to MCS9
	IEEE 802.11ac-VHT80: Up to MCS9
<b>Number of Channels:</b>	5150 MHz to 5250 MHz: 4 for IEEE 802.11a/n-HT20/ac-VHT20 2 for IEEE 802.11n-HT40/ac-VHT40 1 for IEEE 802.11acVHT80
	5250 MHz to 5350 MHz: 4 for IEEE 802.11a/n-HT20/ac-VHT20 2 for IEEE 802.11n-HT40/ac-VHT40 1 for IEEE 802.11acVHT80
	5470 MHz to 5725 MHz: 11 for IEEE 802.11a/n-HT20/ac-VHT20 5 for IEEE 802.11n-HT40/ac-VHT40 2 for IEEE 802.11ac-VHT80
	5725 MHz to 5850 MHz: 5 for IEEE 802.11a/n-HT20/ac-VHT20 2 for IEEE 802.11n-HT40/ac-VHT40 1 for IEEE 802.11ac-VHT80

**Shenzhen UnionTrust Quality and Technology Co., Ltd.**

Address: Unit D/E of 9/F and 16/F, Block A, Building 6, Baoneng science and technology park, Longhua district, Shenzhen, China

Tel: +86-755-28230888

Fax: +86-755-28230886

E-mail: info@uttlab.com

<http://www.uttlab.com>

UTTR-RF-RSS247-V1.1

<b>Antenna Type:</b>	Dipole Antenna				
<b>Antenna Gain:</b> (Provided by the customer)	5150 MHz to 5250 MHz: 3.5 dBi				
	5250 MHz to 5350 MHz: 3.5 dBi				
	5470 MHz to 5725 MHz: 3.5 dBi				
	5725 MHz to 5850 MHz: 3.5 dBi				
<b>Maximum conducted output power (dBm):</b>		<b>U-NII-1</b>	<b>U-NII-2A</b>	<b>U-NII-2C</b>	<b>U-NII-3</b>
	IEEE 802.11a:	13.10	17.35	17.63	17.94
	IEEE 802.11n-HT20:	12.66	18.26	17.41	17.57
	IEEE 802.11n-HT40:	16.96	18.17	17.52	17.72
	IEEE 802.11ac-VHT20	12.78	18.20	17.37	17.66
	IEEE 802.11ac-VHT40	17.04	16.88	17.26	17.64
	IEEE 802.11ac-VHT80:	19.21	19.00	19.58	17.06
<b>Maximum EIRP (dBm):</b>		<b>U-NII-1</b>	<b>U-NII-2A</b>	<b>U-NII-2C</b>	<b>U-NII-3</b>
	IEEE 802.11a:	16.60	20.85	21.13	21.44
	IEEE 802.11n-HT20:	16.16	21.76	20.91	21.07
	IEEE 802.11n-HT40:	20.46	21.67	21.02	21.22
	IEEE 802.11ac-VHT20	16.28	21.70	20.87	21.16
	IEEE 802.11ac-VHT40	20.54	20.38	20.76	21.14
	IEEE 802.11ac-VHT80:	22.71	22.50	23.08	20.56
<b>Normal Test Voltage:</b>	12Vdc				

### 1.4 OTHER INFORMATION

Operation Frequency Each of Channel				
	<b>U-NII-1</b>	<b>U-NII-2A</b>	<b>U-NII-2C</b>	<b>U-NII-3</b>
<b>IEEE 802.11a, IEEE 802.11n-HT20, IEEE 802.11ac-VHT20</b>	$f = 5000 + 5k, k = 32 + 4n$			$f = 5000 + 5k,$ $k = 145 + 4n$
	$n = 1, \dots, 4$	$n = 5, \dots, 8$	$n = 17, \dots, 27$	$n = 1, \dots, 5$
<b>IEEE 802.11n-HT40, IEEE 802.11ac-VHT40</b>	$f = 5000 + 5k, k = 30 + 8n$			$f = 5000 + 5k,$ $k = 143 + 8n$
	$n = 1, 2$	$n = 1, \dots, 5$	$n = 9, \dots, 13$	$n = 1, 2$
<b>IEEE 802.11ac-VHT80</b>	$f = 5000 + 5k, k = 26 + 16n$			$f = 5000 + 5k,$ $k = 155$
	$n = 1$	$n = 1, 2$	$n = 5, 6$	

Note:  
**f** is the operating frequency (MHz);  
**k** is the operating channel.

### 1.5 DESCRIPTION OF SUPPORT UNITS

The EUT has been tested with associated equipment below.

#### 1) Support Equipment

Description	Manufacturer	Model No.	Serial Number	FCC ID	Supplied by
Notebook	DELL	Inspiron 5409	N/A	N/A	Notebook
Mouse	DELL	MS111	CN-011D3V-738	N/A	UnionTrust
Wireless Home Router	SAGEMCOM	FAST5280	253703944	VW3FAST5280	UnionTrust
Key-Press Attenuator	Huaxin	KT2.5-90/1S-2S	N/A	N/A	UnionTrust

### Shenzhen UnionTrust Quality and Technology Co., Ltd.

Address: Unit D/E of 9/F and 16/F, Block A, Building 6, Baoneng science and technology park, Longhua district, Shenzhen, China

Tel: +86-755-28230888

Fax: +86-755-28230886

E-mail: info@uttlab.com

<http://www.uttlab.com>

UTTR-RF-RSS247-V1.1

4 Way Divider	WOKEN	0120A040560002D	N/A	N/A	UnionTrust
---------------	-------	-----------------	-----	-----	------------

2) Support Cable

Cable No.	Description	Connector	Length	Supplied by
1	Antenna Cable	SMA	0.1Meter	UnionTrust

## 1.6 TEST LOCATION

**Shenzhen UnionTrust Quality and Technology Co., Ltd.**

Address: Unit D/E of 9/F and 16/F, Block A, Building 6, Baoneng science and technology park, Longhua district, Shenzhen, China  
 Telephone: +86 (0) 755 2823 0888  
 Fax: +86 (0) 755 2823 0886

## 1.7 TEST FACILITY

The test facility is recognized, certified, or accredited by the following organizations:

**CNAS-Lab Code: L9069**

The measuring equipment utilized to perform the tests documented in this report has been calibrated once a year or in accordance with the manufacturer's recommendations, and is traceable under the ISO/IEC 17025 to international or national standards. Equipment has been calibrated by accredited calibration laboratories.

**A2LA-Lab Certificate No.: 4312.01**

Shenzhen UnionTrust Quality and Technology Co., Ltd. has been accredited by A2LA for technical competence in the field of electrical testing, and proved to be in compliance with ISO/IEC 17025 General Requirements for the Competence of Testing and Calibration Laboratories and any additional program requirements in the identified field of testing.

**ISED Wireless Device Testing Laboratories**

CAB identifier: CN0032

**FCC Accredited Lab.**

Designation Number: CN1194  
 Test Firm Registration Number: 259480

## 1.8 DEVIATION FROM STANDARDS

None.

## 1.9 ABNORMALITIES FROM STANDARD CONDITIONS

None.

## 1.10 OTHER INFORMATION REQUESTED BY THE CUSTOMER

None.

**Shenzhen UnionTrust Quality and Technology Co., Ltd.**

Address: Unit D/E of 9/F and 16/F, Block A, Building 6, Baoneng science and technology park, Longhua district, Shenzhen, China

Tel: +86-755-28230888

Fax: +86-755-28230886

E-mail: info@uttlab.com

<http://www.uttlab.com>

UTTR-RF-RSS247-V1.1

### 1.11 MEASUREMENT UNCERTAINTY

Where relevant, the following measurement uncertainty levels have been estimated for tests performed on the Product as specified in CISPR 16-4-2. This uncertainty represents an expanded uncertainty expressed at approximately the 95% confidence level using a coverage factor of k=2.

No.	Item	Measurement Uncertainty
1	Conducted emission 9kHz-150kHz	±3.2 dB
2	Conducted emission 150kHz-30MHz	±2.7 dB
3	Radiated emission 9kHz-30MHz	± 4.7 dB
4	Radiated emission 30MHz-1GHz	± 4.9 dB
5	Radiated emission 1GHz-18GHz	± 4.8 dB
6	Radiated emission 18GHz-26GHz	± 5.1 dB
7	Radiated emission 26GHz-40GHz	± 5.1 dB
8	Conducted spurious emissions	± 2.7 dB
9	RF Power, Conducted	± 0.68 dB
10	Occupied Bandwidth	± 1.86 %
11	Radio Frequency	5.6 GHz: ± 6.4 x 10 <sup>-8</sup>
12	Transmission Time	± 0.19 %



## 2. TEST SUMMARY

FCC 47 CFR Part 15 Subpart E Test Cases			
Test Item	Test Requirement	Test Method	Result
Antenna Requirement	FCC 47 CFR Part 15 Subpart C Section 15.203 FCC 47 CFR Part 15 Subpart E Section 15.407(a)(1) (2) RSS-Gen Issue 5, Section 6.8	N/A	PASS
26 dB emission bandwidth	FCC 47 CFR Part 15 Subpart E Section 15.407 (a)(2)(5) RSS-247 Issue 2 Section 6.2.1.2	KDB 789033 D02 v02r01 Section C.1	PASS
6 dB bandwidth	FCC 47 CFR Part 15 Subpart E Section 15.407 (e) RSS-247 Issue 2 Section 6.2.4.1	KDB 789033 D02 v02r01 Section C.2	PASS
Occupied Bandwidth	RSS-Gen Issue 5, Section 6.7	RSS-Gen Issue 5, section 6.7	PASS
Maximum conducted output power	FCC 47 CFR Part 15 Subpart E Section 15.407 (a)(1)(2)(3) RSS-247 Issue 2 Section 6.2.1.1/6.2.2.1/6.2.3.1/6.2.4.1	KDB 789033 D02 v02r01 Section E.3.a (Method PM)	PASS
Peak Power Spectral Density	FCC 47 CFR Part 15 Subpart E Section 15.407 (a)(1)(2)(3) RSS-247 Issue 2 Section 6.2.1.1/6.2.2.1/6.2.3.1/6.2.4.1	KDB 789033 D02 v02r01 Section F	PASS
Radiated Emissions and Band Edge Measurement	FCC 47 CFR Part 15 Subpart E Section 15.407 (b)(1)(2)(3)(4)(6) FCC 47 CFR Part 15 Subpart C Section 15.209/205 RSS-247 Issue 2 Section 6.2.1.2/6.2.2.2/6.2.3.2/6.2.4.2	KDB 789033 D02 v02r01 Section G.3, G.4, G.5, and G.6	PASS
Dynamic Frequency Selection	FCC 47 CFR Part 15 Subpart E Section 15.407 (h) RSS-247 Issue 2 Section 6.3	KDB 905462 D03 Client Without DFS New Rules v01r02	PASS
AC Power Line Conducted Emission	FCC 47 CFR Part 15 Subpart E Section 15.407 (b)(6) FCC 47 CFR Part 15 Subpart C Section 15.207 RSS-Gen Issue 5, Section 8.8	ANSI C63.10-2013, Section 6.2.	PASS
<b>Note:</b> 1) N/A: In this whole report not applicable.			
<b>Disclaimer and Explanations:</b> The declared of product specification and data (e.g. antenna gain, RF specification, etc) for EUT presented in the report are provided by the customer, and the customer takes all the responsibilities for the accuracy of product specification.			

### For Dynamic Frequency Selection

Test Case	Result
Channel Availability Check Time	N/A <sup>1</sup>
U-NII Detection Bandwidth	N/A <sup>1</sup>
Channel Closing Transmission Time	PASS
Channel Move Time	PASS
DFS Detection Threshold	N/A <sup>1</sup>
Non- Occupancy Period	N/A <sup>1</sup>
<b>Note:</b> 1) The EUT is slave, NA In this whole report not applicable.	

### Shenzhen UnionTrust Quality and Technology Co., Ltd.

Address: Unit D/E of 9/F and 16/F, Block A, Building 6, Baoneng science and technology park, Longhua district, Shenzhen, China

Tel: +86-755-28230888

Fax: +86-755-28230886

E-mail: info@uttlab.com

<http://www.uttlab.com>

UTTR-RF-RSS247-V1.1

### 3. EQUIPMENT LIST

Radiated Emission Test Equipment List						
Used	Equipment	Manufacturer	Model No.	Serial Number	Cal. date (mm dd, yyyy)	Cal. Due date (mm dd, yyyy)
<input checked="" type="checkbox"/>	3m SAC	ETS-LINDGREN	3m	Euroshiedpn-CT001270-1317	Jan. 22, 2021	Jan. 21, 2024
<input checked="" type="checkbox"/>	Receiver	R&S	ESIB26	100114	Nov. 05, 2021	Nov. 04, 2022
<input checked="" type="checkbox"/>	EXA Spectrum Analyzer	KEYSIGHT	N9010A	MY51440197	Apr. 15, 2022	Apr. 14, 2023
<input checked="" type="checkbox"/>	Loop Antenna	ETS-LINDGREN	6502	00202525	Nov. 11, 2021	Nov. 10, 2023
<input checked="" type="checkbox"/>	Broadband Antenna	ETS-LINDGREN	3142E	00201566	Nov. 11, 2021	Nov. 10, 2023
<input checked="" type="checkbox"/>	6dB Attenuator	Talent	RA6A5-N-18	18103001	Nov. 11, 2021	Nov. 10, 2023
<input checked="" type="checkbox"/>	Preamplifier	HP	8447F	2805A02960	Nov. 05, 2021	Nov. 04, 2022
<input checked="" type="checkbox"/>	Double-Ridged Waveguide Horn Antenna (Pre-amplifier)	ETS-LINDGREN	3117-PA	00201541	Apr. 17, 2022	Apr. 16, 2024
<input checked="" type="checkbox"/>	Pre-amplifier	ETS-Lindgren	00118385	00201874	Nov. 06, 2021	Nov. 05, 2022
<input checked="" type="checkbox"/>	Double-Ridged Waveguide Horn Antenna (Pre-amplifier)	ETS-LINDGREN	3116C-PA	00202652	Nov. 14, 2020	Nov. 13, 2023
<input checked="" type="checkbox"/>	Pre-amplifier	ETS-Lindgren	00118384	00202652	Nov. 17, 2020	Nov. 16, 2022
<input checked="" type="checkbox"/>	Multi device Controller	ETS-LINDGREN	7006-001	00160105	N/A	N/A
<input type="checkbox"/>	Band Rejection Filter (2400MHz~2500MHz)	Micro-Tronics	BRM50702	G248	Nov. 06, 2021	Nov. 05, 2022
<input checked="" type="checkbox"/>	Band Rejection Filter (5150MHz~5880MHz)	Micro-Tronics	BRM50716	G186	Nov. 06, 2021	Nov. 05, 2022
<input checked="" type="checkbox"/>	Test Software	Audix	e3	Software Version: 9.160323		

Conducted Emission Test Equipment List						
Used	Equipment	Manufacturer	Model No.	Serial Number	Cal. date (mm dd, yyyy)	Cal. Due date (mm dd, yyyy)
<input checked="" type="checkbox"/>	Receiver	R&S	ESR7	1316.3003K07-101181-K3	Nov. 05, 2021	Nov. 04, 2022
<input checked="" type="checkbox"/>	Pulse Limiter	R&S	ESH3-Z2	0357.8810.54	Nov. 05, 2021	Nov. 04, 2022
<input checked="" type="checkbox"/>	LISN	R&S	ESH2-Z5	860014/024	Nov. 05, 2021	Nov. 04, 2022
<input checked="" type="checkbox"/>	LISN	ETS-Lindgren	3816/2SH	00201088	Nov. 05, 2021	Nov. 04, 2022
<input checked="" type="checkbox"/>	Test Software	Audix	e3	Software Version: 9.160323		

Conducted RF test Equipment List						
Used	Equipment	Manufacturer	Model No.	Serial Number	Cal. date (mm dd, yyyy)	Cal. Due date (mm dd, yyyy)
<input checked="" type="checkbox"/>	EXA Spectrum Analyzer	KEYSIGHT	N9010A	MY51440197	Apr. 15, 2022	Apr. 14, 2023
<input checked="" type="checkbox"/>	USB Wideband Power Sensor	KEYSIGHT	U2021XA	MY55430035	Nov. 05, 2021	Nov. 04, 2022
<input checked="" type="checkbox"/>	Spectrum Analyzer	R&S	FSV40-N	101653	Apr. 15, 2022	Apr. 14, 2023
<input type="checkbox"/>	USB Wideband Power Sensor	KEYSIGHT	U2021XA	MY55430023	Nov. 05, 2021	Nov. 04, 2022
<input checked="" type="checkbox"/>	MXG X-Series RF Vector Signal Generator	KEYSIGHT	N5182B	MY51350267	Nov. 05, 2021	Nov. 04, 2022

**Shenzhen UnionTrust Quality and Technology Co., Ltd.**

Address: Unit D/E of 9/F and 16/F, Block A, Building 6, Baoneng science and technology park, Longhua district, Shenzhen, China

Tel: +86-755-28230888

Fax: +86-755-28230886

E-mail: info@uttlab.com

<http://www.uttlab.com>

UTTR-RF-RSS247-V1.1

#### 4. TEST CONFIGURATION

##### 4.1 ENVIRONMENTAL CONDITIONS FOR TESTING

###### 4.1.1 Normal or Extreme Test Conditions

Environment Parameter	Selected Values During Tests		
Test Condition	Ambient		
	Temperature (°C)	Voltage (V)	Relative Humidity (%)
NT/NV	+15 to +35	12	20 to 75
<b>Remark:</b>			
1) NV: Normal Voltage; NT: Normal Temperature			

###### 4.1.2 Record of Normal Environment and Test Sample

Test Item	Temperature (°C)	Relative Humidity (%)	Pressure (kPa)	Sample No.	Tested by
26 dB emission bandwidth	23.4	51	99.80	S20220713183-ZJA03/5	Rain Wang
6 dB bandwidth					
Occupied Bandwidth					
Maximum conducted output power					
Peak Power Spectral Density					
Dynamic Frequency Selection	25.6	52	100.12	S20220713183-ZJA04/5	Andy Lin
Radiated Emissions and Band Edge Measurement					
AC Power Line Conducted Emission	23.4	42	101.1	S20220713183-ZJA04/5	David Zhang

### 4.2 TEST CHANNELS

Mode	Tx/Rx Frequency	Test RF Channel Lists		
		Lowest(L)	Middle(M)	Highest(H)
IEEE 802.11a IEEE 802.11n-HT20 IEEE 802.11ac-VHT20	5150 MHz to 5250 MHz	Channel 36	Channel 44	Channel 48
		5180 MHz	5220 MHz	5240 MHz
	5250 MHz to 5350 MHz	Channel 52	Channel 60	Channel 64
		5260 MHz	5300 MHz	5320 MHz
	5470 MHz to 5725 MHz	Channel 100	Channel 116	Channel 140
		5500 MHz	5580 MHz	5700 MHz
	5725 MHz to 5850 MHz	Channel 149	Channel 157	Channel 165
		5745 MHz	5785 MHz	5825 MHz
IEEE 802.11n-HT40 IEEE 802.11ac-VHT40	5150 MHz to 5250 MHz	Channel 38	--	Channel 46
		5190 MHz	--	5230 MHz
	5250 MHz to 5350 MHz	Channel 54	--	Channel 62
		5270 MHz	--	5310 MHz
	5470 MHz to 5725 MHz	Channel 102	Channel 110	Channel 134
		5510 MHz	5550 MHz	5670 MHz
	5725 MHz to 5850 MHz	Channel 151	--	Channel 159
		5755 MHz	--	5795 MHz
IEEE 802.11ac-VHT80	5150 MHz to 5250 MHz	--	Channel 42	--
		--	5210 MHz	--
	5250 MHz to 5350 MHz	--	Channel 58	--
		--	5290 MHz	--
	5470 MHz to 5725 MHz	Channel 106	--	--
		5530 MHz	--	--
	5725 MHz to 5850 MHz	--	Channel 155	--
		--	5775 MHz	--

### 4.3 EUT TEST STATUS

Mode	Tx/Rx Function	Description
IEEE 802.11a/n/ac	1Tx/1Rx	1. Keep the EUT in transmitting mode with all kind of modulation and all kind of data rate.

Power Setting(Provided by the customer)				
	U-NII-1	U-NII-2A	U-NII-2C	U-NII-3
IEEE 802.11a	11	16	17	17
IEEE 802.11n-HT20	11	17	17	17
IEEE 802.11n-HT40	16	17	17	17
IEEE 802.11ac-VHT20	11	17	17	17
IEEE 802.11ac-VHT40	16	17	17	17
IEEE 802.11ac-VHT80	18	18	19	16

Test Software(Provided by the customer)
Test software name: Putty commands;

### 4.4 PRE-SCAN

Pre-Scan has been conducted to determine the worst-case mode from all possible combinations between available modulations and data rate. Following data rate was (were) selected for the final test as listed below

Mode	Worst-case data rates
IEEE 802.11a	6 Mbps
IEEE 802.11n-HT20	MCS0
IEEE 802.11n-HT40	MCS0
IEEE 802.11ac-VHT20	MCS0
IEEE 802.11ac-VHT40	MCS0
IEEE 802.11ac-VHT80	MCS0

### 4.5 TEST SETUP

#### 4.5.1 For Radiated Emissions test setup

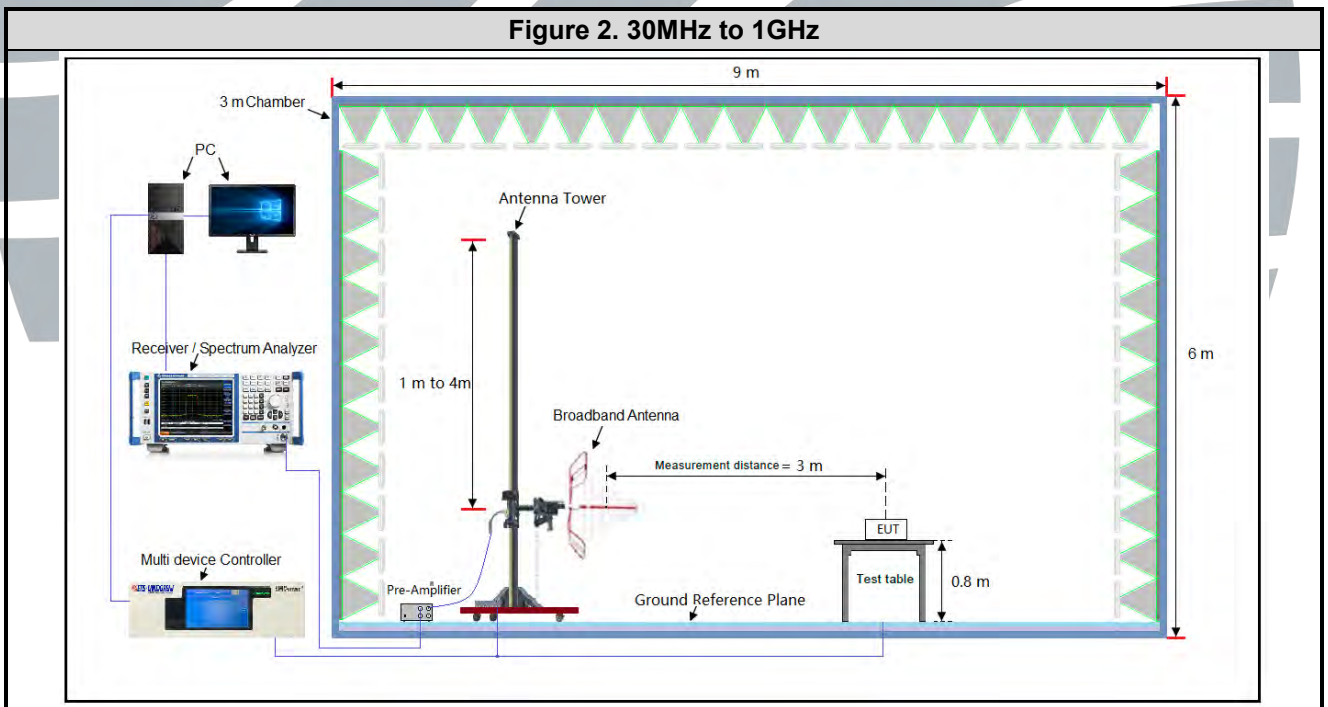
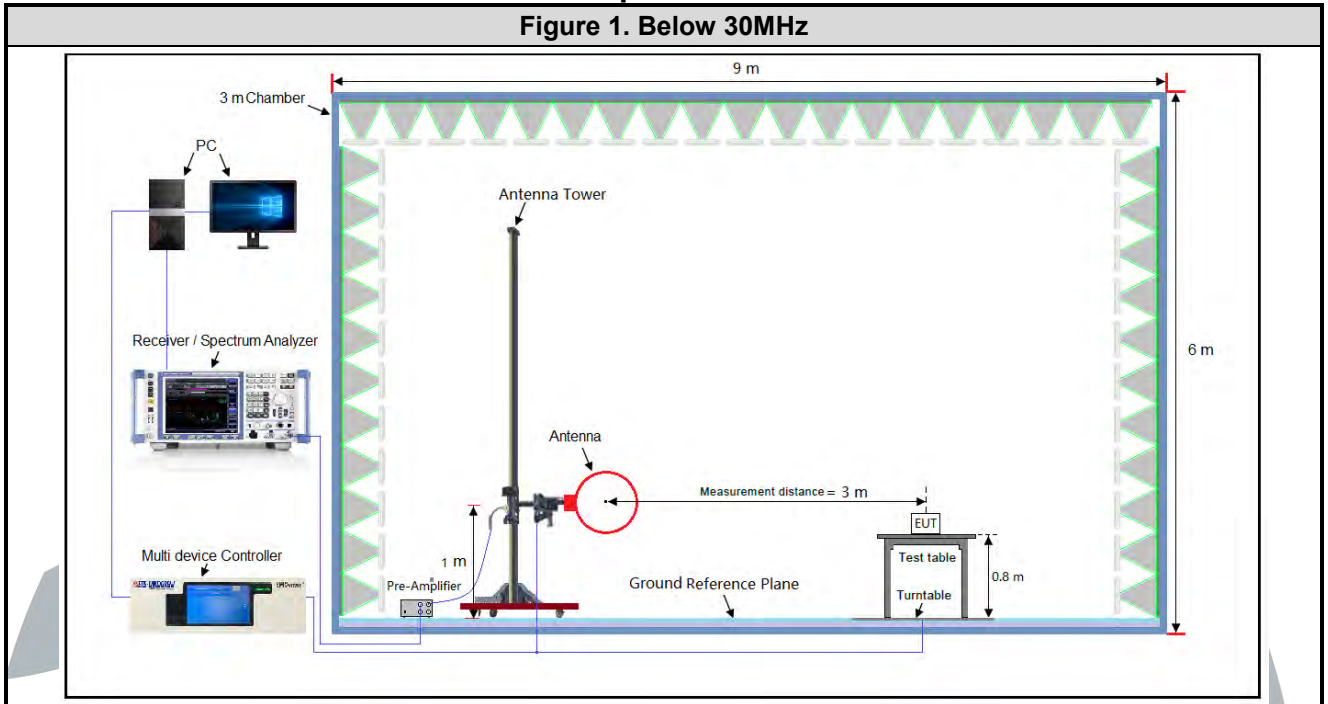

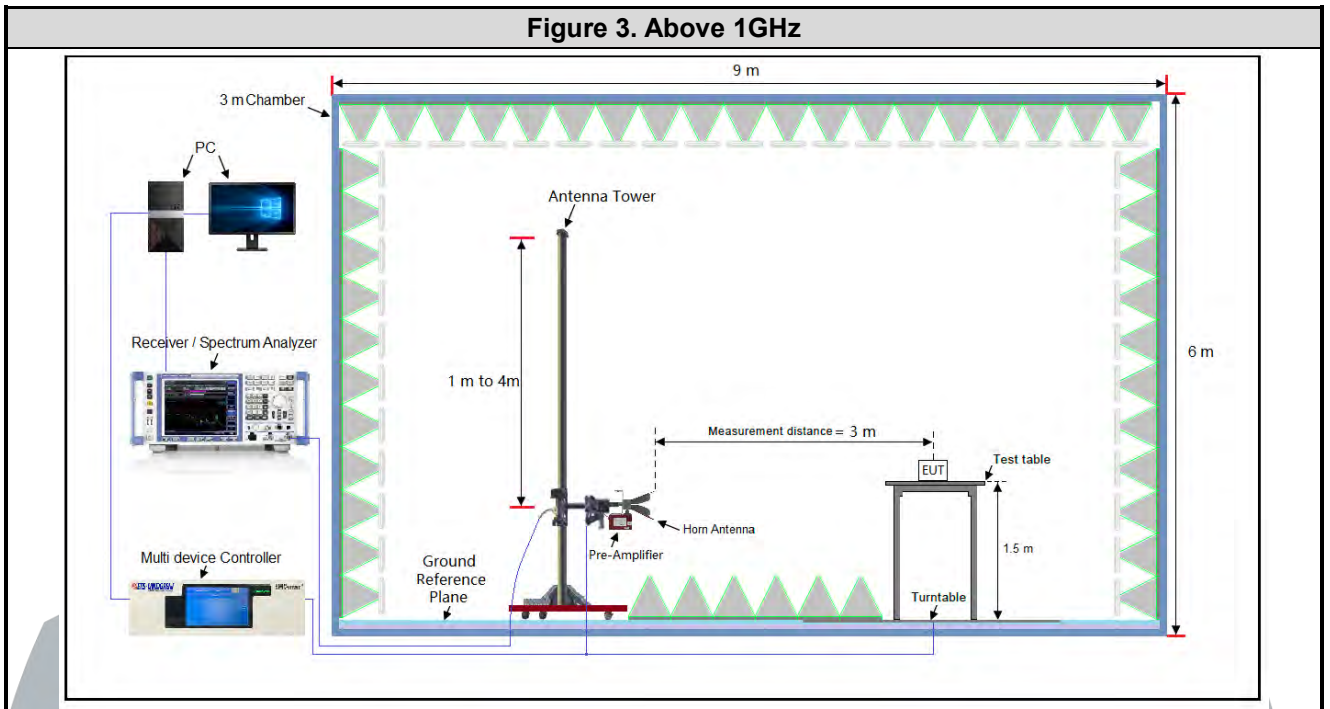

**4.5.2 For Conducted Emissions test setup**

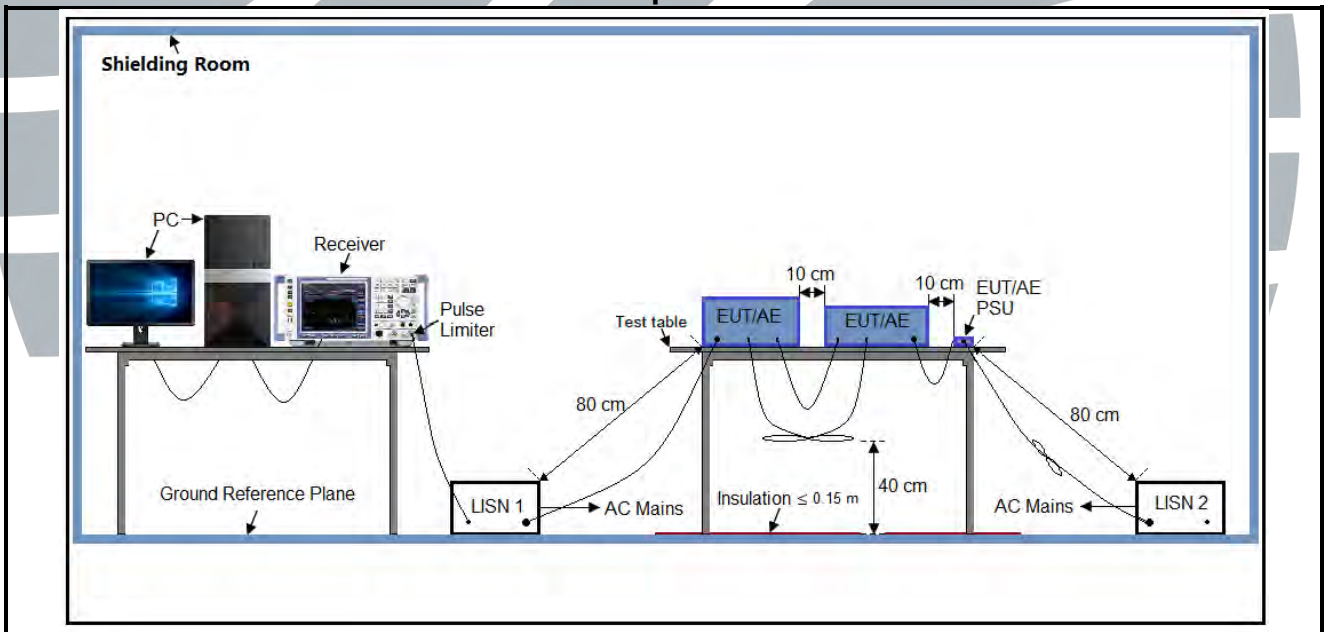

4.5.3 For Conducted RF test setup

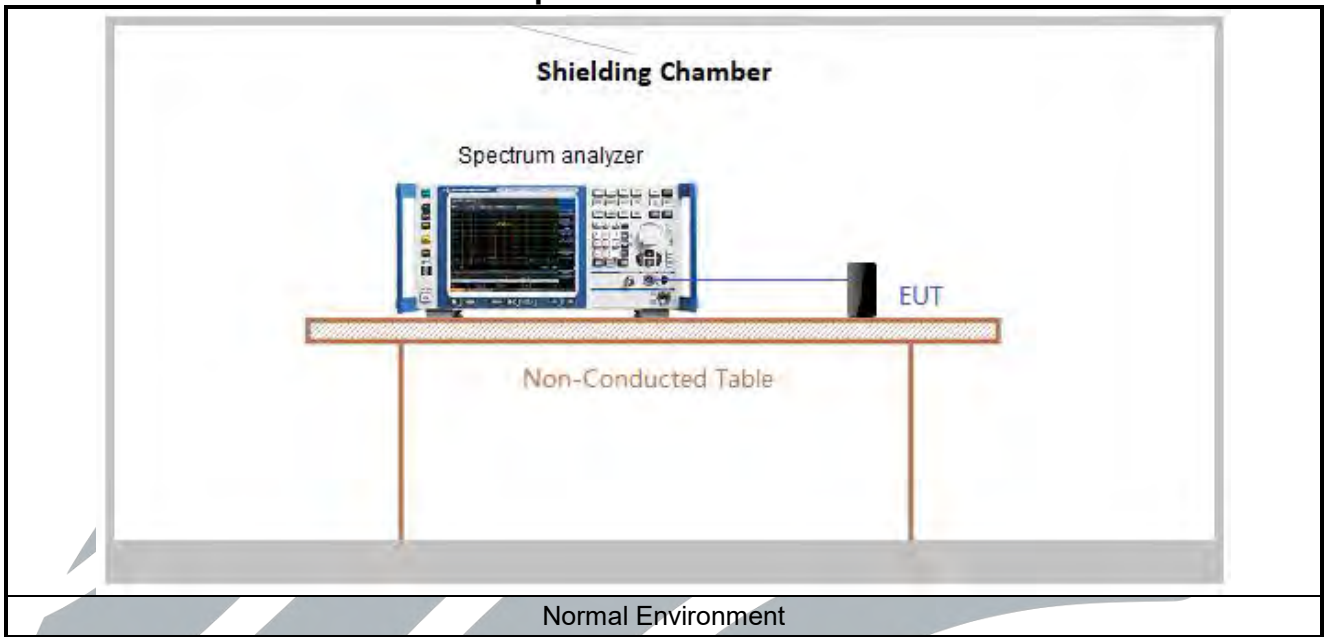



## 4.6 SYSTEM TEST CONFIGURATION

For emissions testing, the equipment under test (EUT) setup to transmit continuously to simplify the measurement methodology. Care was taken to ensure proper power supply voltages during testing. During testing, radiated emission were performed with the EUT set to transmit at the channel with highest output power as worst-case scenario. Only the worst case data were recorded in this test report.

The signal is maximized through rotation and placement in the three orthogonal axes. The antenna height and polarization are varied during the search for maximum signal level. The antenna height is varied from 1 to 4 meters. Radiated emissions are taken at three meters unless the signal level is too low for measurement at that distance. If necessary, a pre-amplifier is used and/or the test is conducted at a closer distance.

All readings are extrapolated back to the equivalent three meter reading using inverse scaling with distance. Analyzer resolution is 100 kHz or greater for frequencies below 1000 MHz. The resolution is 1 MHz or greater for frequencies above 1000 MHz. The spurious emissions more than 20 dB below the permissible value are not reported.

Radiated emission measurement were performed from the lowest radio frequency signal generated in the device which is greater than 9 kHz to the tenth harmonic of the highest fundamental frequency or to 40 GHz, whichever is lower.

### 4.7 DUTY CYCLE

Test Procedure: ANSI C63.10-2013 Clause 12.2.

**Test Results**

Mode	Data Rates	On Time (msec)	Period (msec)	Duty Cycle (linear)	Duty Cycle (%)	Duty Cycle Factor (dB)	1/T Minimum VBW (kHz)
IEEE 802.11a	6 Mbps	1.384	1.440	0.96	96.11	0.17	0.72
IEEE 802.11n-HT20	MCS 0	1.302	1.351	0.96	96.37	0.16	0.77
IEEE 802.11n-HT40	MCS 0	0.644	0.696	0.93	92.53	0.34	1.55
IEEE 802.11ac-VHT20	MCS 0	1.302	1.358	0.96	95.88	0.18	0.77
IEEE 802.11ac-VHT40	MCS 0	0.652	0.700	0.93	93.14	0.31	1.53
IEEE 802.11ac-VHT80	MCS 0	0.322	0.366	0.88	87.98	0.56	3.11

**Remark:**

- 1) Duty cycle= On Time/ Period;
- 2) Duty Cycle factor = 10 \* log(1/ Duty cycle);
- 3) Average factor = 20 log<sub>10</sub> Duty Cycle.

The test plots as follows

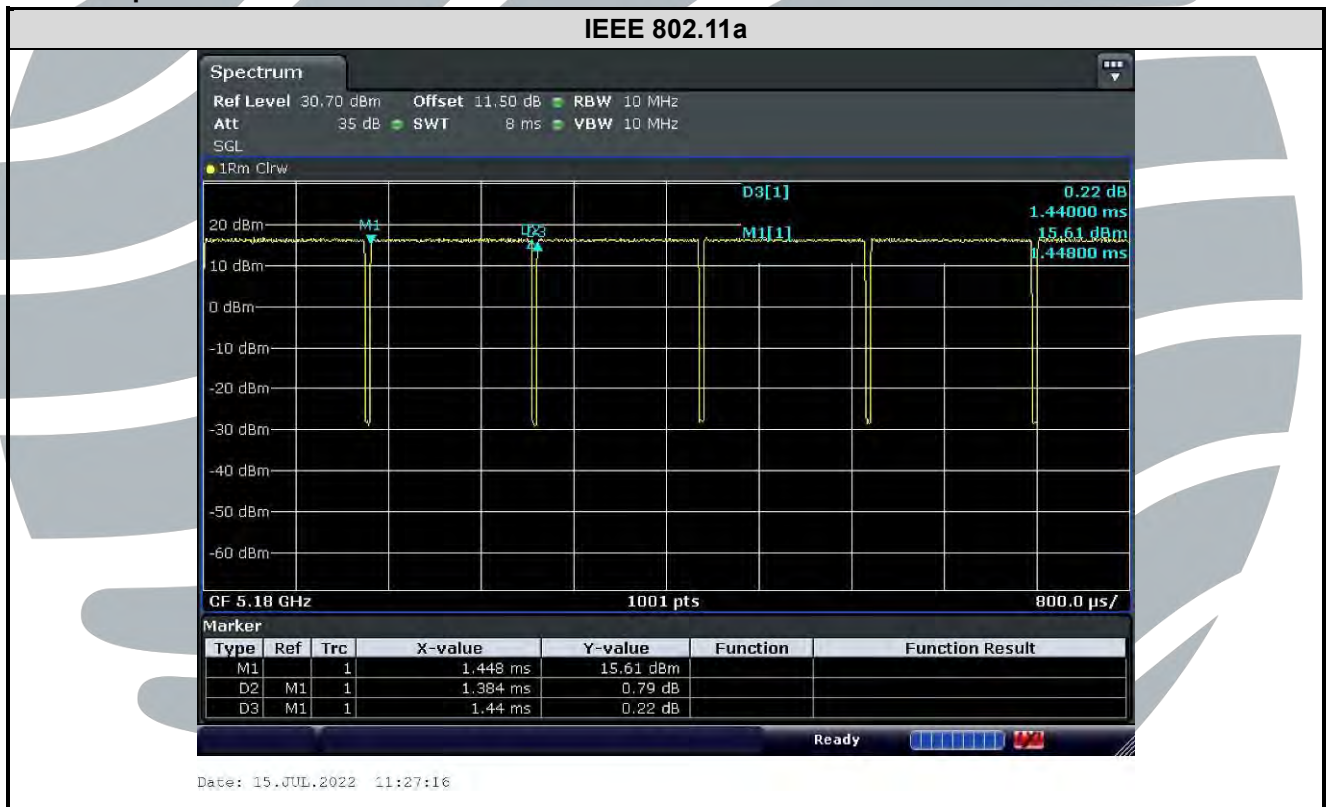

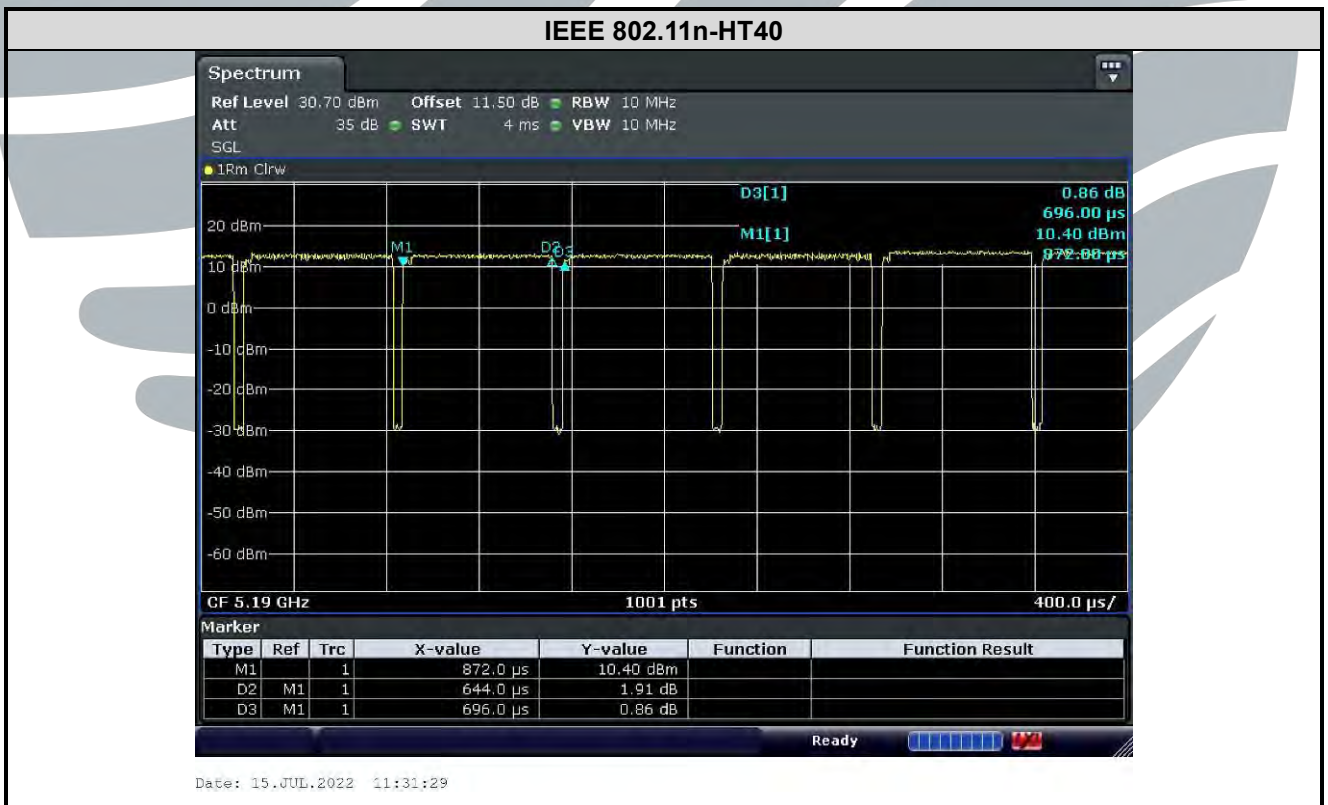
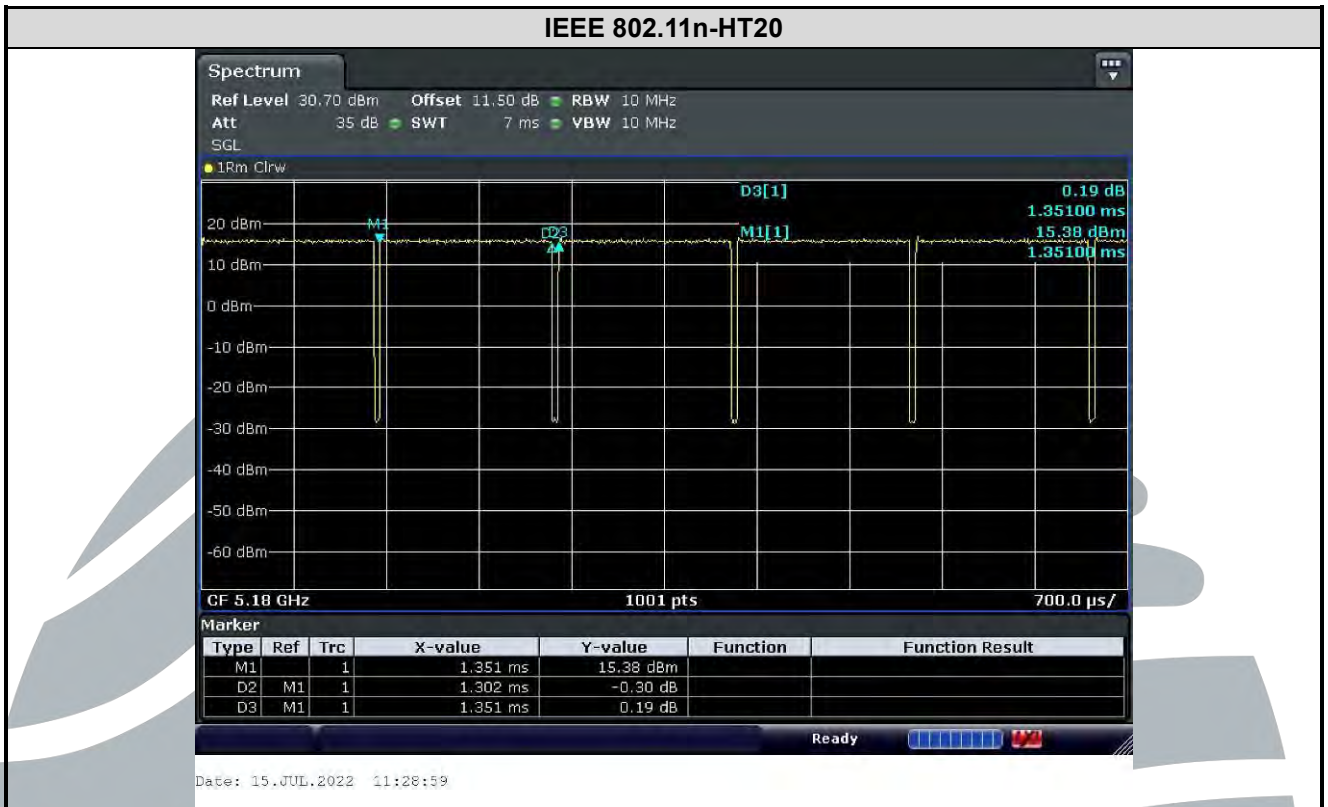

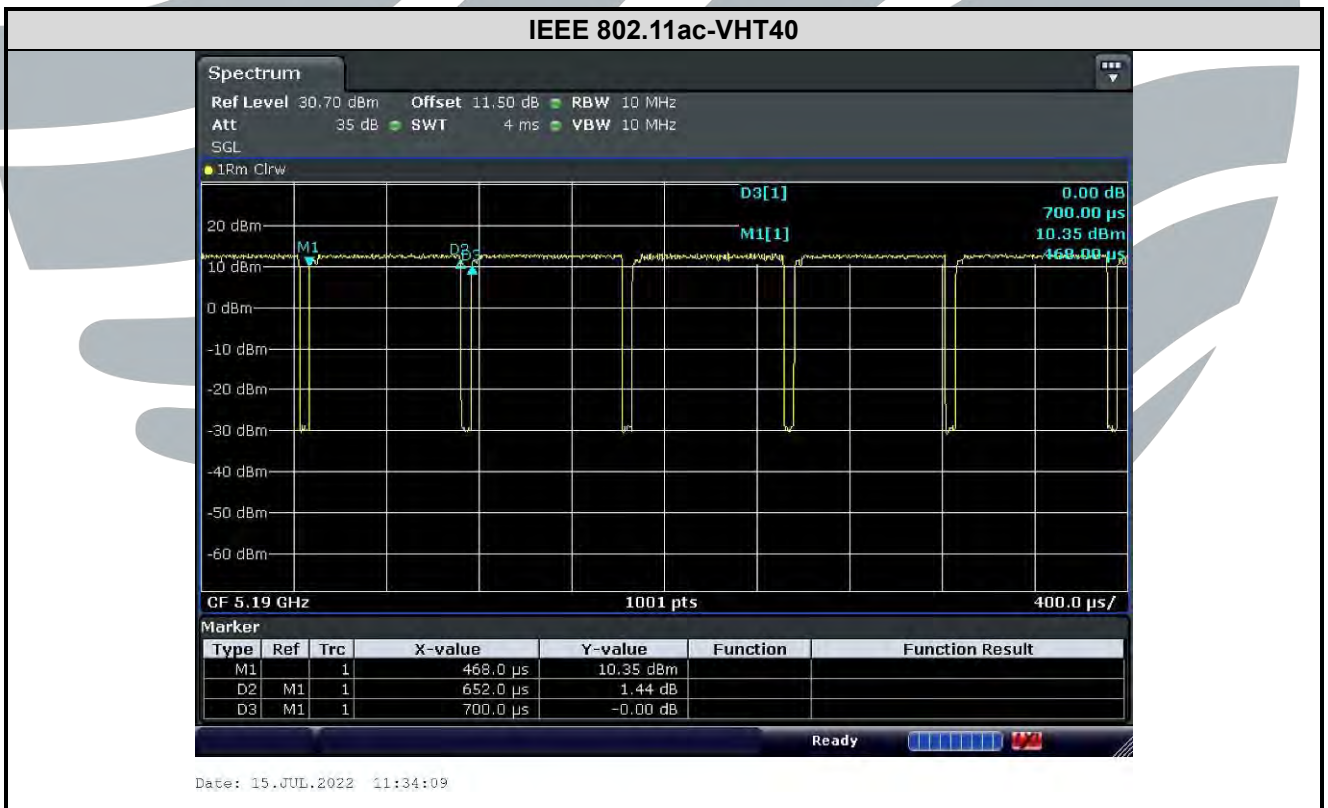
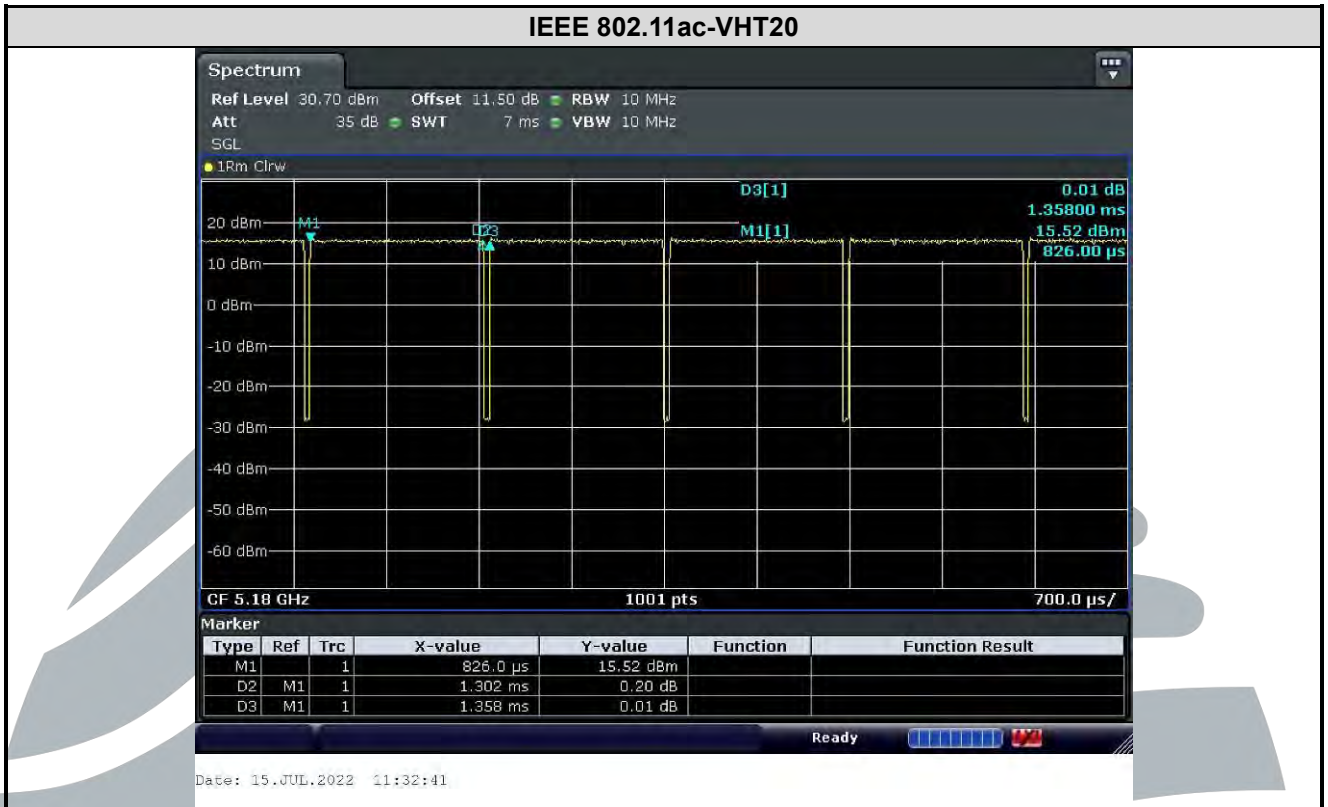

**Shenzhen UnionTrust Quality and Technology Co., Ltd.**

Address: Unit D/E of 9/F and 16/F, Block A, Building 6, Baoneng science and technology park, Longhua district, Shenzhen, China

Tel: +86-755-28230888

Fax: +86-755-28230886

E-mail: info@uttlab.com

<http://www.uttlab.com>

UTTR-RF-RSS247-V1.1

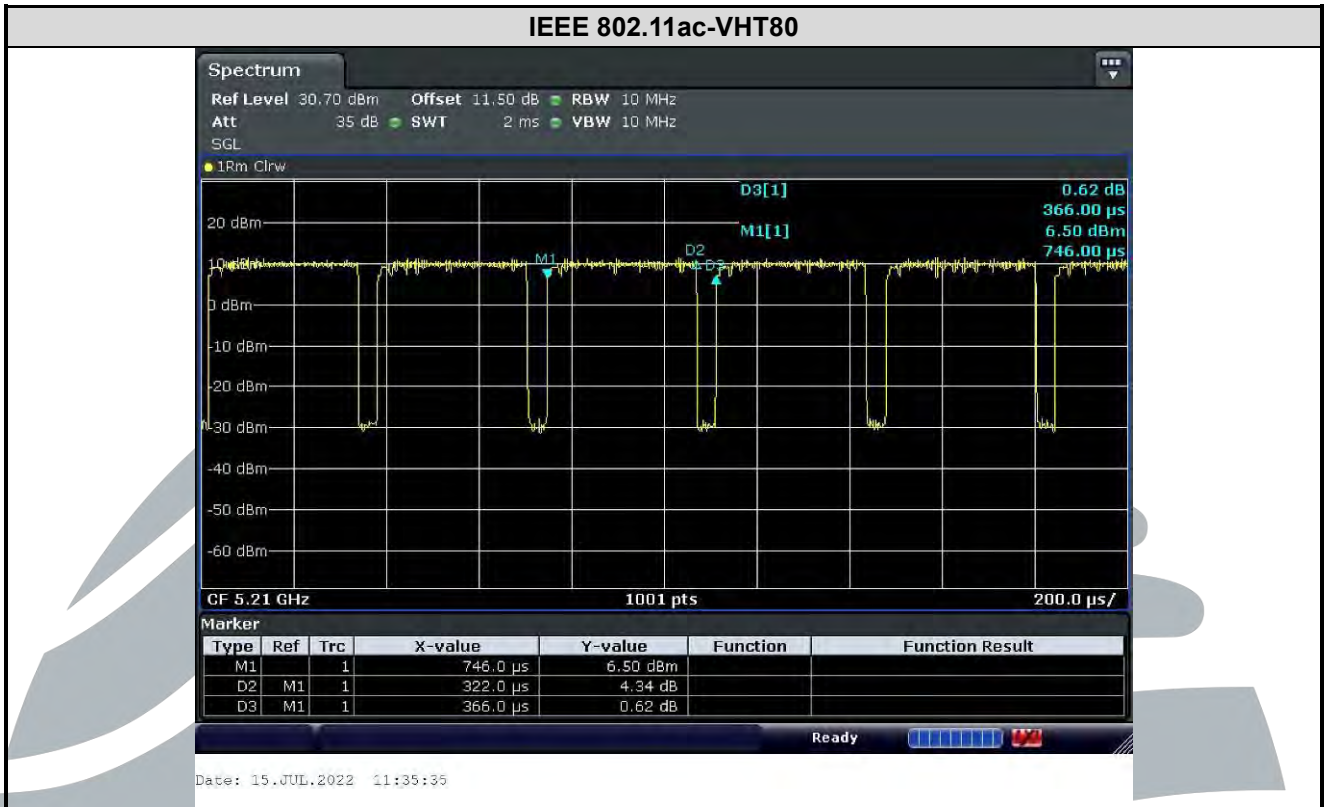

**Shenzhen UnionTrust Quality and Technology Co., Ltd.**

Address: Unit D/E of 9/F and 16/F, Block A, Building 6, Baoneng science and technology park, Longhua district, Shenzhen, China

Tel: +86-755-28230888

Fax: +86-755-28230886

E-mail: info@uttlab.com

<http://www.uttlab.com>

UTTR-RF-RSS247-V1.1

## 5. RADIO TECHNICAL REQUIREMENTS SPECIFICATION

### 5.1 REFERENCE DOCUMENTS FOR TESTING

No.	Identity	Document Title
1	FCC 47 CFR Part 2	Frequency allocations and radio treaty matters; general rules and regulations
2	FCC 47 CFR Part 15	Radio Frequency Devices
3	RSS-247 Issue 2	Digital Transmission Systems (DTSS), Frequency Hopping Systems (FHSs) and Licence-Exempt Local Area Network (LE-LAN) Devices
4	RSS-Gen Issue 5	General Requirements for Compliance of Radio Apparatus
5	ANSI C63.10-2013	American National Standard for Testing Unlicensed Wireless Devices
6	KDB 789033 D02 General UNII Test Procedures New Rules v02r01	Guidelines for compliance testing of unlicensed national information infrastructure (U-NII) device part 15, subpart E
7	KDB 905462 D06 802.11 Channel Plans New Rules v02	Operation in U-NII bands -802.11 channel PLAN(§15.407)
8	KDB 905462 D02 UNII DFS Compliance Procedures New Rules v02	Compliance measurement procedures for Unlicensed –National Information Infrastructure devices operates in the frequency bands 5250 MHz to 5350 MHz and 5470 MHz to 5725 MHz bands incorporating dynamic frequency selection
9	KDB 905462 D03 Client Without DFS New Rules v01r02	U-NII client devices without radar detection capability
10	KDB 662911 D01 Multiple Transmitter Output v02r01	Emissions Testing of Transmitters with Multiple Outputs in the Same Band

### 5.2 ANTENNA REQUIREMENT

Standard Requirement
<p><b>15.203 requirement:</b> An intentional radiator shall be designed to ensure that no antenna other than that furnished by the responsible party shall be used with the device. The use of a permanently attached antenna or of an antenna that uses a unique coupling to the intentional radiator, the manufacturer may design the unit so that a broken antenna can be replaced by the user, but the use of a standard antenna jack or electrical connector is prohibited.</p> <p><b>15.407(a)(1) (2) requirement:</b> The conducted output power limit specified in paragraph (a) of this section is based on the use of antennas with directional gains that do not exceed 6 dBi. Except as shown in paragraph (a) of this section, if transmitting antennas of directional gain greater than 6 dBi are used, the conducted output power and the peak power spectral density shall be reduced by the by the amount in dB that the directional gain of the antenna exceeds 6 dBi.</p> <p><b>RSS-Gen Issue 5, Section 6.8 requirement:</b> According to RSS-Gen Issue 5, Section 6.8, a transmitter can only be sold or operated with antennas with which it was certified. A transmitter may be certified with multiple antenna types. An antenna type comprises antennas having similar in-band and out-of-band radiation patterns.</p> <p><b>EUT Antenna:</b> Antenna in the interior of the equipment and no consideration of replacement. The gain of the antenna is 3.5 dBi.</p>

### 5.326 DB BANDWIDTH & OCCUPIED BANDWIDTH

- Test Requirement:** FCC 47 CFR Part 15 Subpart E Section 15.407 (a)(2)(5)  
RSS-247 Issue 2 Section 6.2.1.2
- Test Method:** KDB 789033 D02 v02r01 Section C.1
- Limit:** None; for reporting purposes only.
- Test Procedure:**

The output from the transmitter was connected to an attenuator and then to the input of the RF Spectrum analyzer.

Spectrum analyzer according to the following Settings:

- a) Set RBW = approximately 1 % of the emission bandwidth.
- b) Set the VBW > RBW.
- c) Detector = Peak.
- d) Trace mode = max hold.
- e) Measure the maximum width of the emission that is 26 dB down from the peak of the emission. Compare this with the RBW setting of the analyzer. Readjust RBW and repeat measurement as needed until the RBW/EBW ratio is approximately 1 %.

Note: The cable loss and attenuator loss were offset into measure device as an amplitude offset.

- Test Setup:** Refer to section 4.5.3 for details.
- Instruments Used:** Refer to section 3 for details
- Test Results:** Pass

Mode	Channel	26 dB Bandwidth (MHz)	99% Bandwidth (MHz)
IEEE 802.11a	36 (5180)	21.24	16.832
	44 (5220)	21.41	16.820
	48 (5240)	21.15	16.716
	52 (5260)	21.28	16.799
	60 (5300)	27.17	16.988
	64 (5320)	27.24	17.040
	100 (5500)	27.06	17.106
	116 (5580)	30.03	17.291
	140 (5700)	25.88	17.107
IEEE 802.11n-HT20	36 (5180)	22.05	17.913
	44 (5220)	21.63	17.827
	48 (5240)	22.43	17.853
	52 (5260)	21.47	17.890
	60 (5300)	24.89	18.005
	64 (5320)	30.05	18.063
	100 (5500)	25.38	18.060
	116 (5580)	30.09	18.109
	140 (5700)	28.05	18.102
IEEE 802.11n-HT40	38 (5190)	38.90	36.104
	46 (5230)	39.17	36.108
	54 (5270)	48.53	36.350
	62 (5310)	45.75	36.230
	102 (5510)	47.30	36.303
	110 (5550)	48.55	36.322
	134 (5670)	48.31	36.318

**Shenzhen UnionTrust Quality and Technology Co., Ltd.**

Mode	Channel	26 dB Bandwidth (MHz)	99% Bandwidth (MHz)
IEEE 802.11ac-VHT20	36 (5180)	25.45	17.870
	44 (5220)	25.92	17.912
	48 (5240)	23.99	17.901
	52 (5260)	23.89	17.922
	60 (5300)	21.90	17.883
	64 (5320)	22.90	17.914
	100 (5500)	30.46	17.984
	116 (5580)	27.62	18.255
	140 (5700)	27.52	18.060
IEEE 802.11ac-VHT40	38 (5190)	39.08	36.117
	46 (5230)	38.93	36.112
	54 (5270)	38.91	36.123
	62 (5310)	45.72	36.227
	102 (5510)	47.24	36.307
	110 (5550)	48.42	36.331
	134 (5670)	47.68	36.309
IEEE 802.11ac-VHT80	42 (5230)	97.05	75.758
	58 (5290)	100.4	75.994
	106 (5530)	112.9	76.187

**Shenzhen UnionTrust Quality and Technology Co., Ltd.**

Address: Unit D/E of 9/F and 16/F, Block A, Building 6, Baoneng science and technology park, Longhua district, Shenzhen, China

Tel: +86-755-28230888

Fax: +86-755-28230886

E-mail: info@uttlab.com

<http://www.uttlab.com>

UTTR-RF-RSS247-V1.1



The test plots as follows:



**Shenzhen UnionTrust Quality and Technology Co., Ltd.**

Address: Unit D/E of 9/F and 16/F, Block A, Building 6, Baoneng science and technology park, Longhua district, Shenzhen, China

Tel: +86-755-28230888

Fax: +86-755-28230886

E-mail: info@uttlab.com

<http://www.uttlab.com>

UTTR-RF-RSS247-V1.1

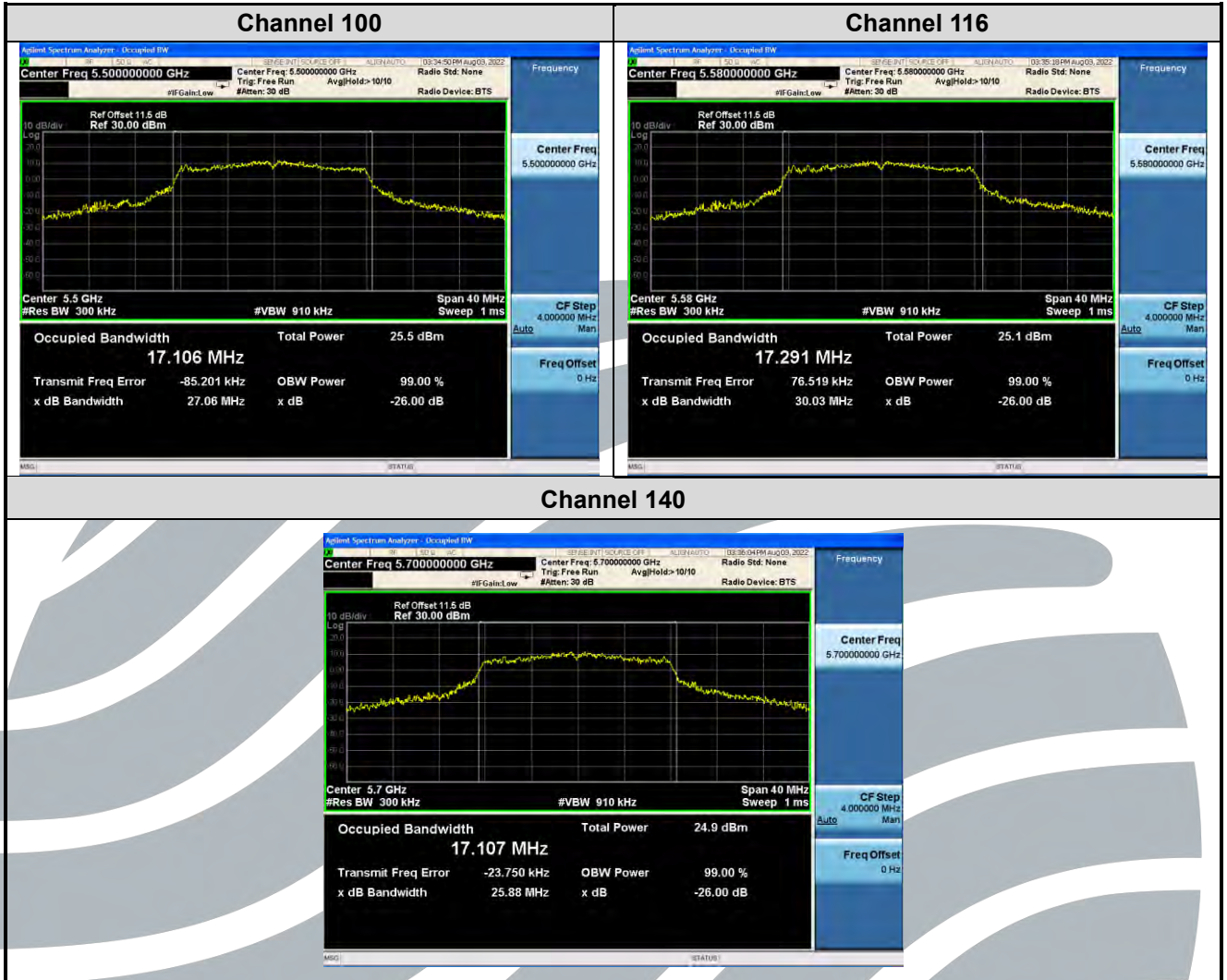

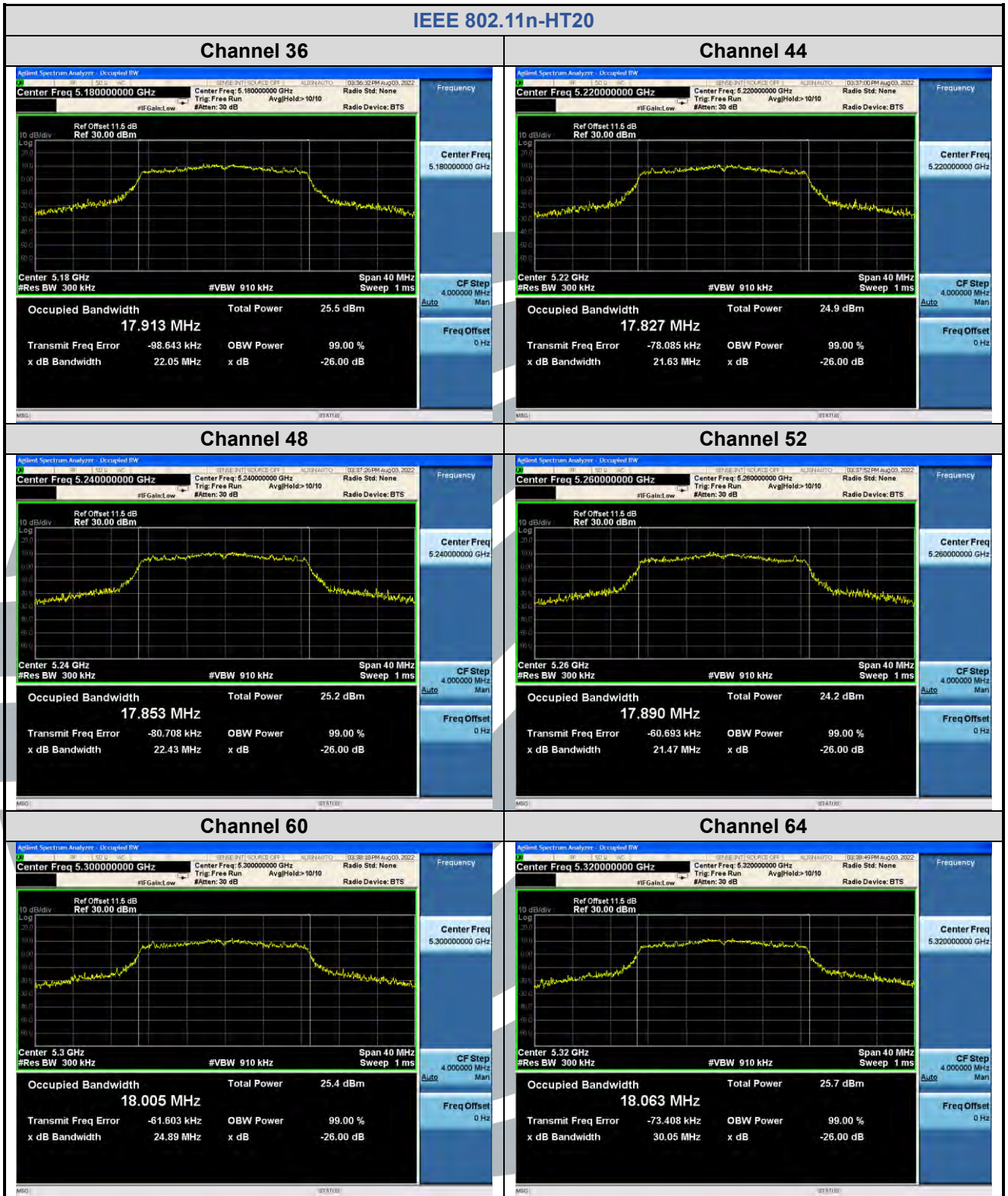

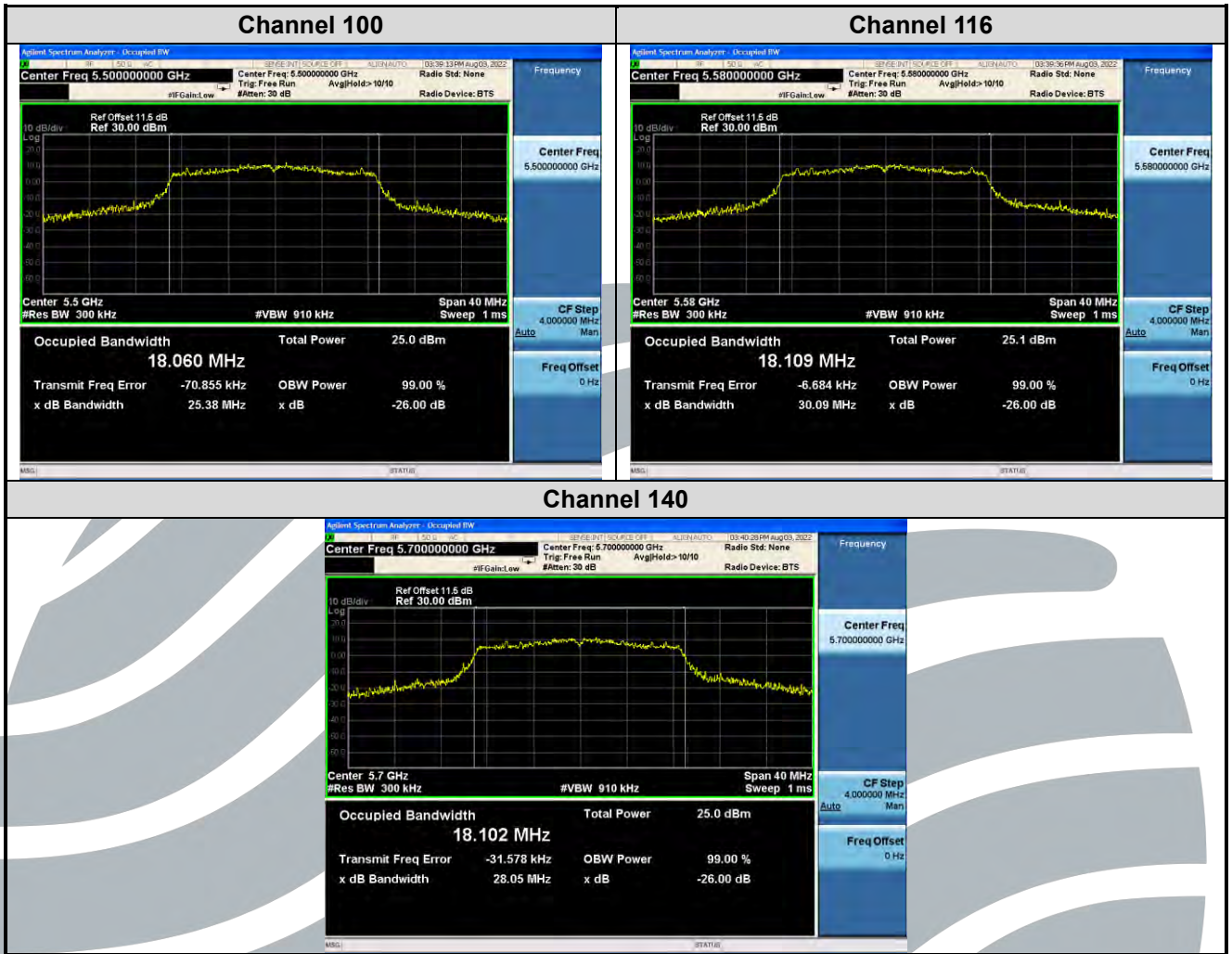

**Shenzhen UnionTrust Quality and Technology Co., Ltd.**

Address: Unit D/E of 9/F and 16/F, Block A, Building 6, Baoneng science and technology park, Longhua district, Shenzhen, China

Tel: +86-755-28230888

Fax: +86-755-28230886

E-mail: info@uttlab.com

<http://www.uttlab.com>

UTTR-RF-RSS247-V1.1



**Shenzhen UnionTrust Quality and Technology Co., Ltd.**

Address: Unit D/E of 9/F and 16/F, Block A, Building 6, Baoneng science and technology park, Longhua district, Shenzhen, China

Tel: +86-755-28230888

Fax: +86-755-28230886

E-mail: info@uttlab.com

<http://www.uttlab.com>

UTTR-RF-RSS247-V1.1

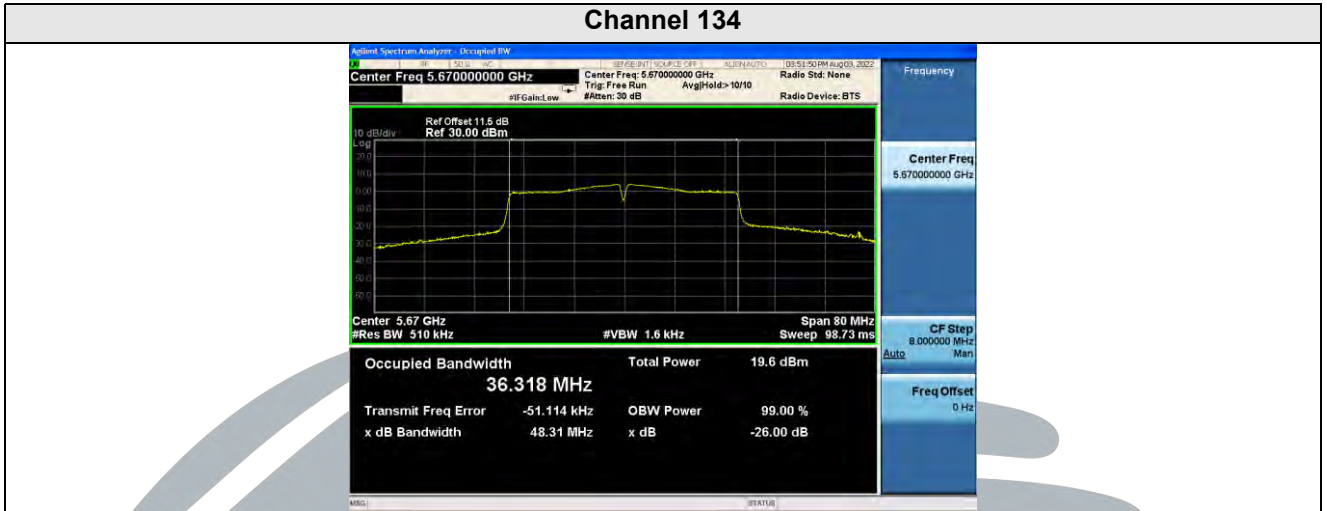

**Shenzhen UnionTrust Quality and Technology Co., Ltd.**

Address: Unit D/E of 9/F and 16/F, Block A, Building 6, Baoneng science and technology park, Longhua district, Shenzhen, China

Tel: +86-755-28230888

Fax: +86-755-28230886

E-mail: info@uttlab.com

<http://www.uttlab.com>

UTTR-RF-RSS247-V1.1

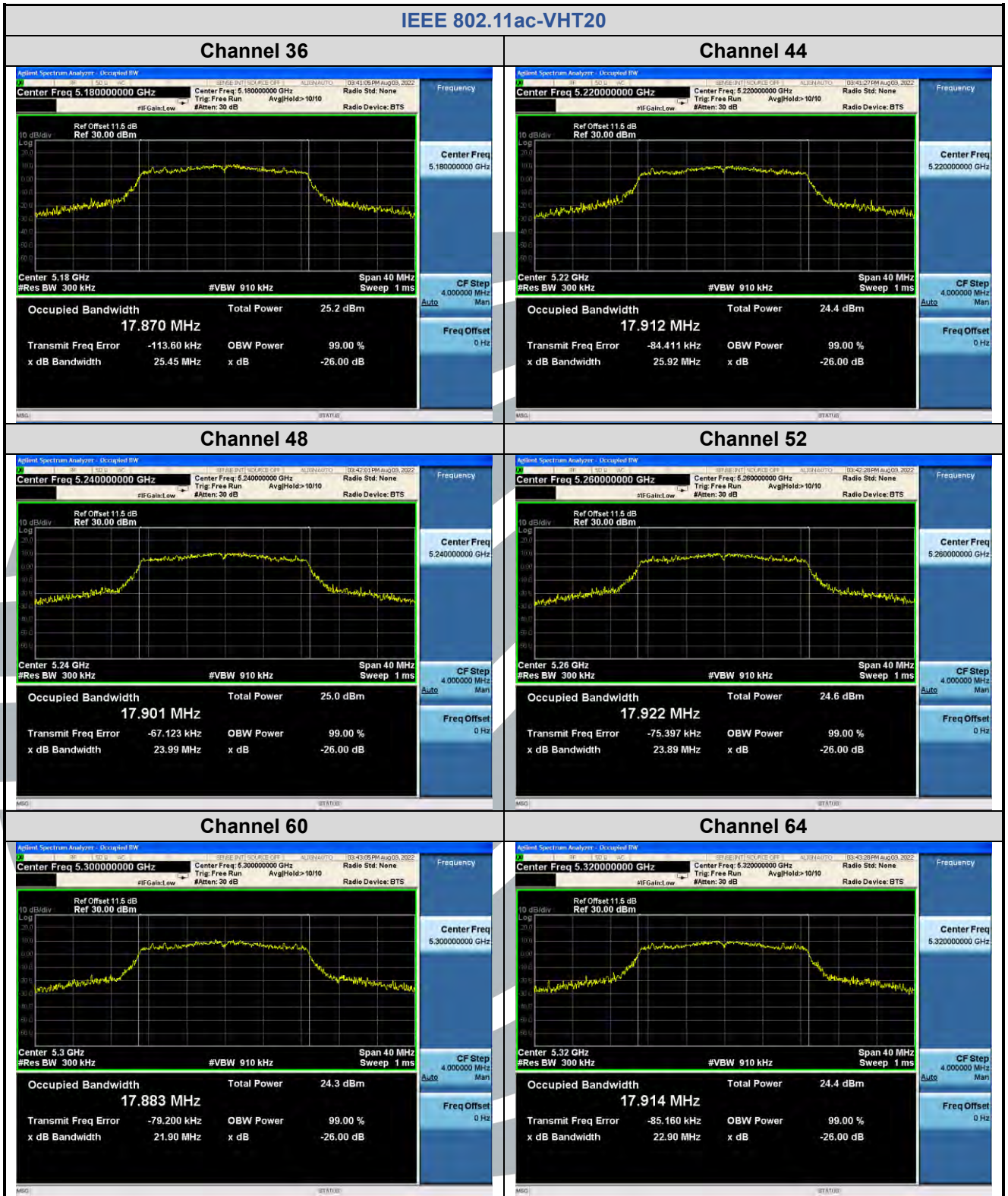

**Shenzhen UnionTrust Quality and Technology Co., Ltd.**

Address: Unit D/E of 9/F and 16/F, Block A, Building 6, Baoneng science and technology park, Longhua district, Shenzhen, China

Tel: +86-755-28230888

Fax: +86-755-28230886

E-mail: info@uttlab.com

<http://www.uttlab.com>

UTTR-RF-RSS247-V1.1

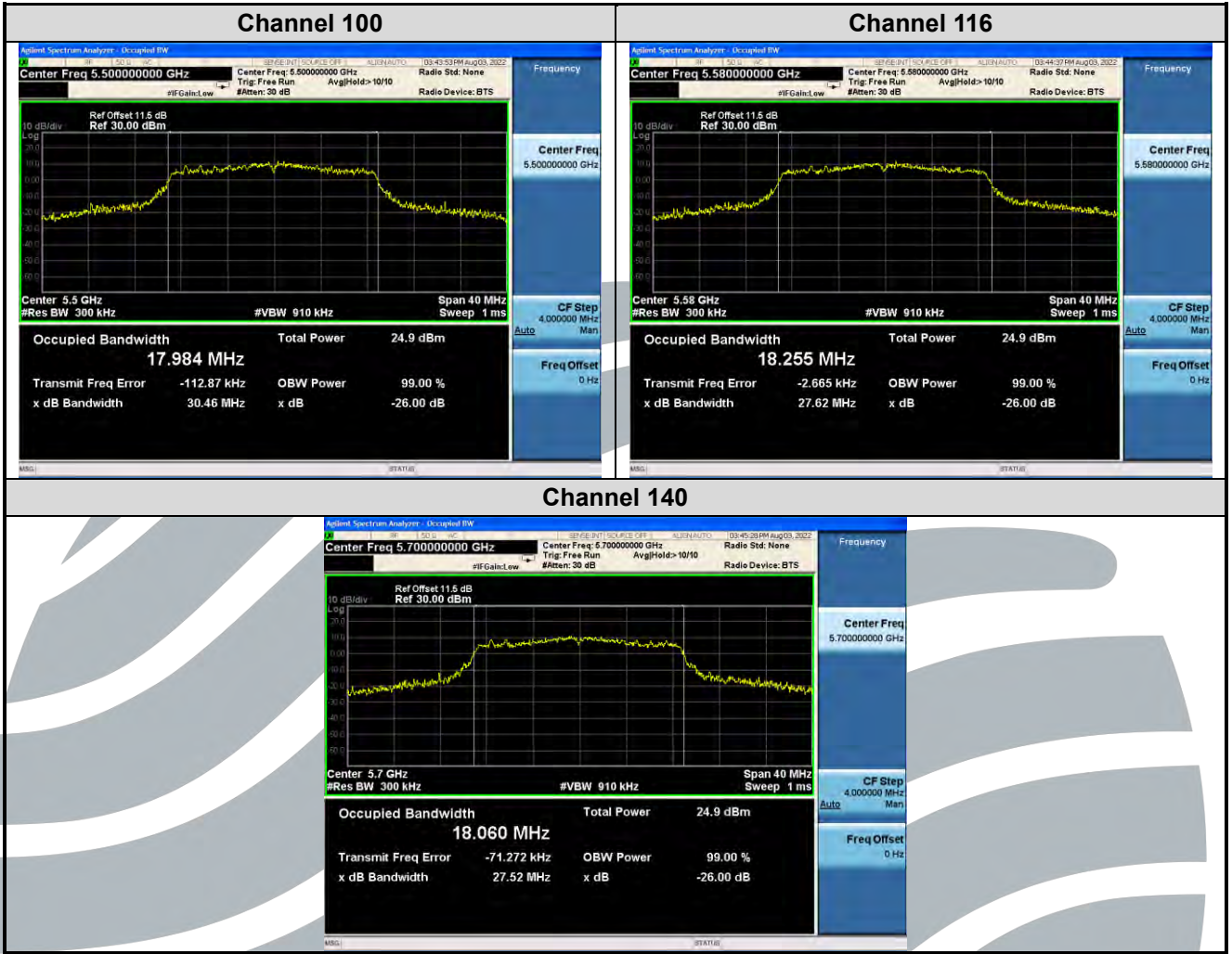

**Shenzhen UnionTrust Quality and Technology Co., Ltd.**

Address: Unit D/E of 9/F and 16/F, Block A, Building 6, Baoneng science and technology park, Longhua district, Shenzhen, China

Tel: +86-755-28230888

Fax: +86-755-28230886

E-mail: info@uttlab.com

<http://www.uttlab.com>

UTTR-RF-RSS247-V1.1





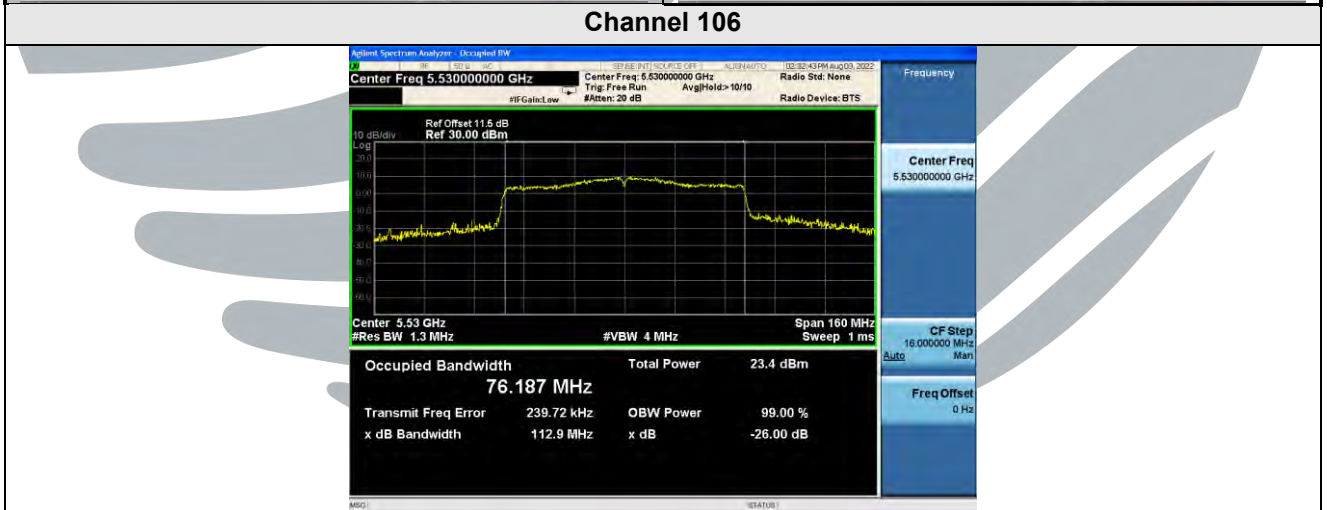
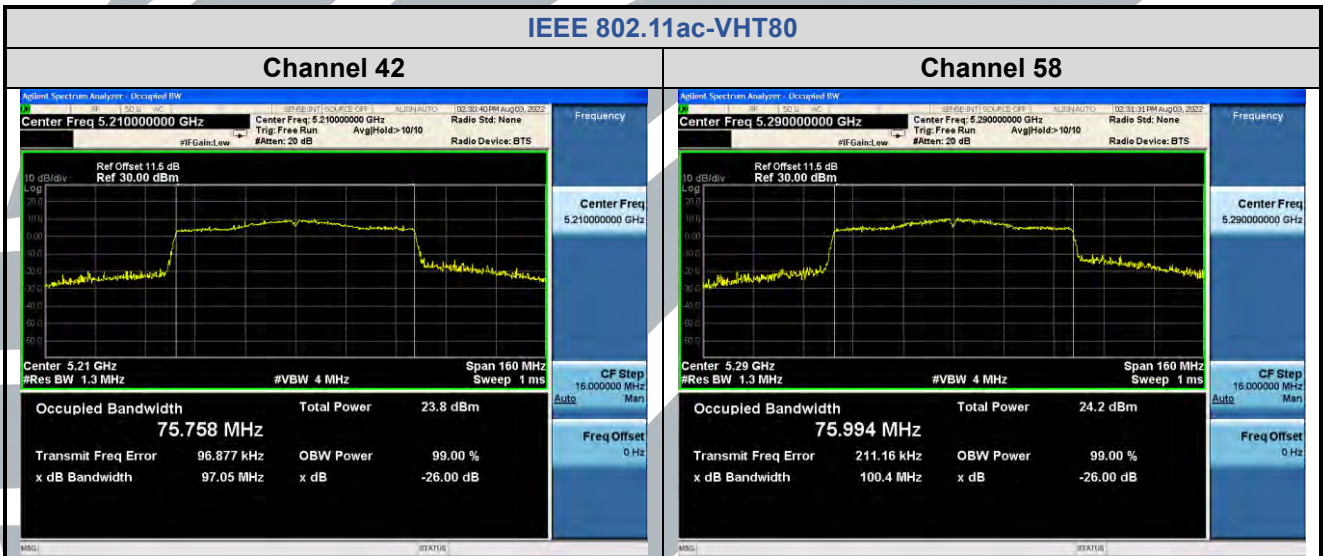
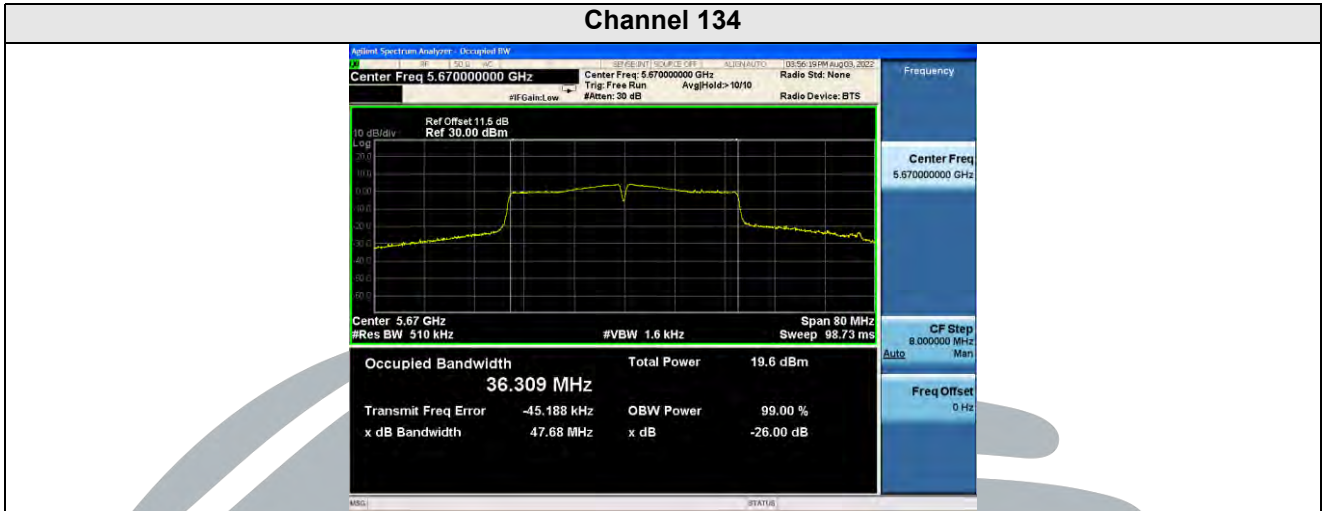

### 5.46 DB BANDWIDTH & OCCUPIED BANDWIDTH

- Test Requirement:** FCC 47 CFR Part 15 Subpart E Section 15.407 (e)  
RSS-247 Issue 2 Section 6.2.4.1
- Test Method:** KDB 789033 D02 v02r01 Section C.2
- Limit:** Within the 5.725-5.85 GHz band, the minimum 6 dB bandwidth of U-NII devices shall be at least 500 kHz.

**Test Procedure:**  
The output from the transmitter was connected to an attenuator and then to the input of the RF Spectrum Analyzer.

Spectrum analyzer according to the following Settings:

**6dB Bandwidth**

- a) Set RBW = 100 kHz.
- b) Set the video bandwidth (VBW)  $\geq 3 * RBW$ .
- c) Detector = Peak.
- d) Trace mode = max hold.
- e) Sweep = auto couple.
- f) Allow the trace to stabilize.
- g) Measure the maximum width of the emission that is constrained by the frequencies associated with the two outermost amplitude points (upper and lower frequencies) that are attenuated by 6 dB relative to the maximum level measured in the fundamental emission.

**Occupied Bandwidth**

- a) Set RBW = 1% to 5% of the occupied bandwidth
- b) Set the video bandwidth (VBW)  $\geq 3 * RBW$ .
- c) Detector = Peak.
- d) Trace mode = max hold.
- e) Sweep = auto couple.
- f) Allow the trace to stabilize.

Note: The cable loss and attenuator loss were offset into measure device as an amplitude offset.

- Test Setup:** Refer to section 4.5.3 for details.
- Instruments Used:** Refer to section 3 for details
- Test Mode:** Transmitter mode
- Test Results:** Pass
- Test Data:**

Mode	Channel/ Frequency (MHz)	6 dB Bandwidth (MHz)	99% Bandwidth (MHz)	6 dB Bandwidth Limit	Pass / Fail
IEEE 802.11a	149 (5745)	15.50	17.720	> 500 kHz	Pass
	157 (5785)	15.44	17.240	> 500 kHz	Pass
	165 (5825)	15.72	17.261	> 500 kHz	Pass
IEEE 802.11n-HT20	149 (5745)	15.72	18.188	> 500 kHz	Pass
	157 (5785)	15.20	18.223	> 500 kHz	Pass
	165 (5825)	15.64	18.200	> 500 kHz	Pass
IEEE 802.11n-HT40	151 (5755)	35.26	37.023	> 500 kHz	Pass
	159 (5795)	35.25	36.643	> 500 kHz	Pass
IEEE 802.11ac-VHT20	149 (5745)	15.80	18.096	> 500 kHz	Pass
	157 (5785)	15.20	18.160	> 500 kHz	Pass
	165 (5825)	15.26	18.172	> 500 kHz	Pass
IEEE 802.11ac-VHT40	151 (5755)	35.26	36.731	> 500 kHz	Pass
	159 (5795)	35.25	36.664	> 500 kHz	Pass
IEEE 802.11ac-VHT80	155 (5775)	75.41	75.470	> 500 kHz	Pass

**Shenzhen UnionTrust Quality and Technology Co., Ltd.**

Address: Unit D/E of 9/F and 16/F, Block A, Building 6, Baoneng science and technology park, Longhua district, Shenzhen, China

Tel: +86-755-28230888

Fax: +86-755-28230886

E-mail: info@uttlab.com

<http://www.uttlab.com>

UTTR-RF-RSS247-V1.1

The test plots as follows:  
6 dB Bandwidth

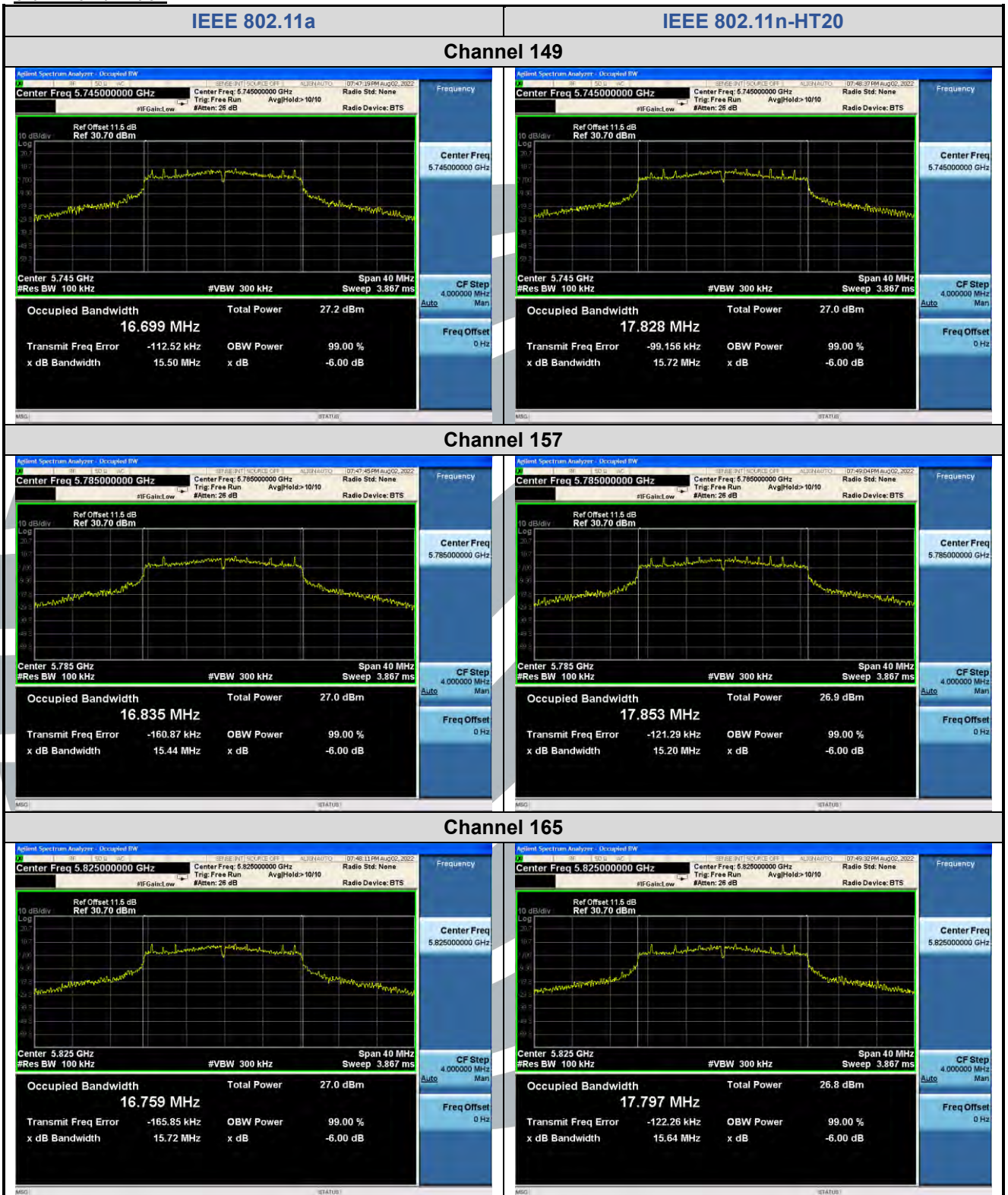

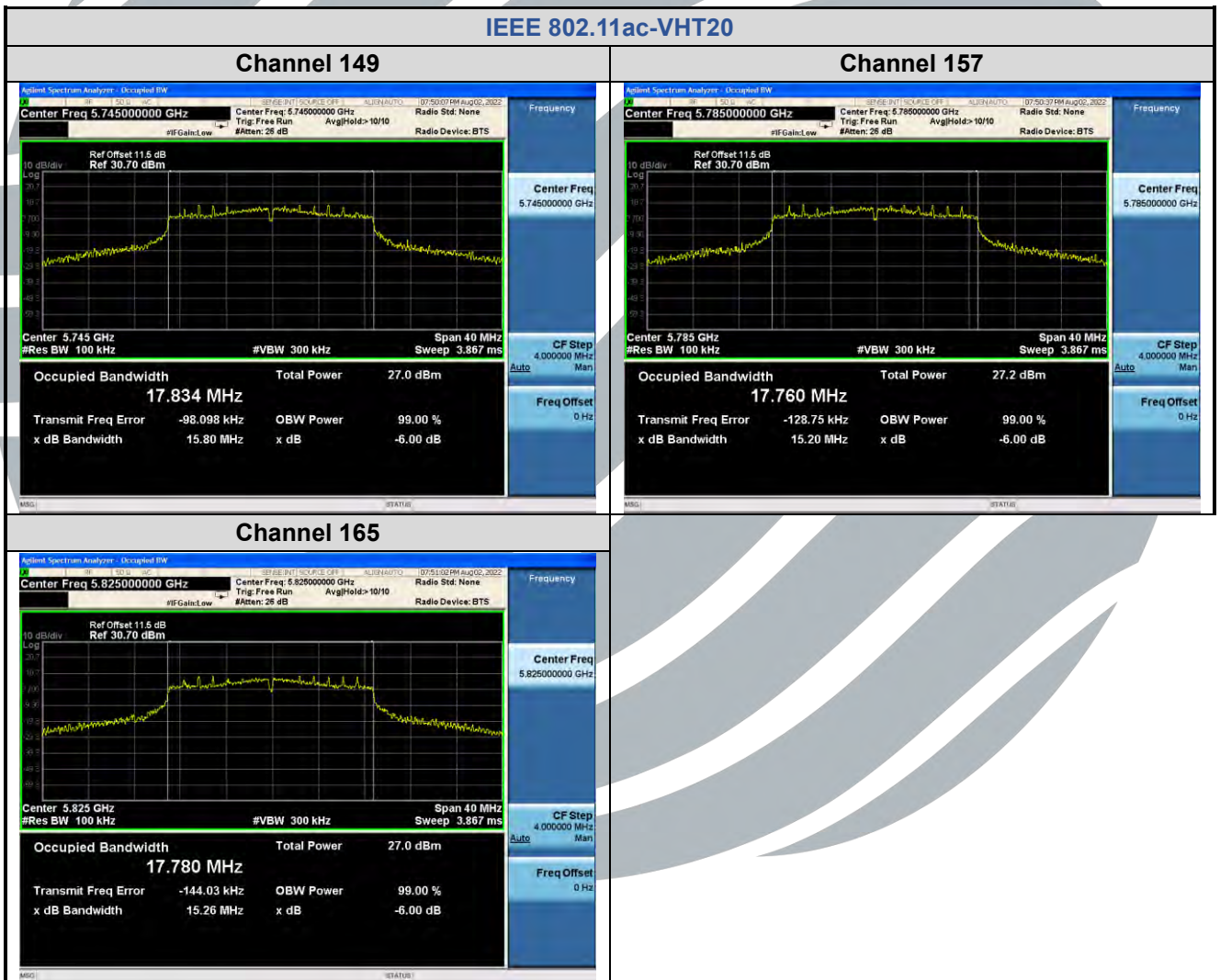
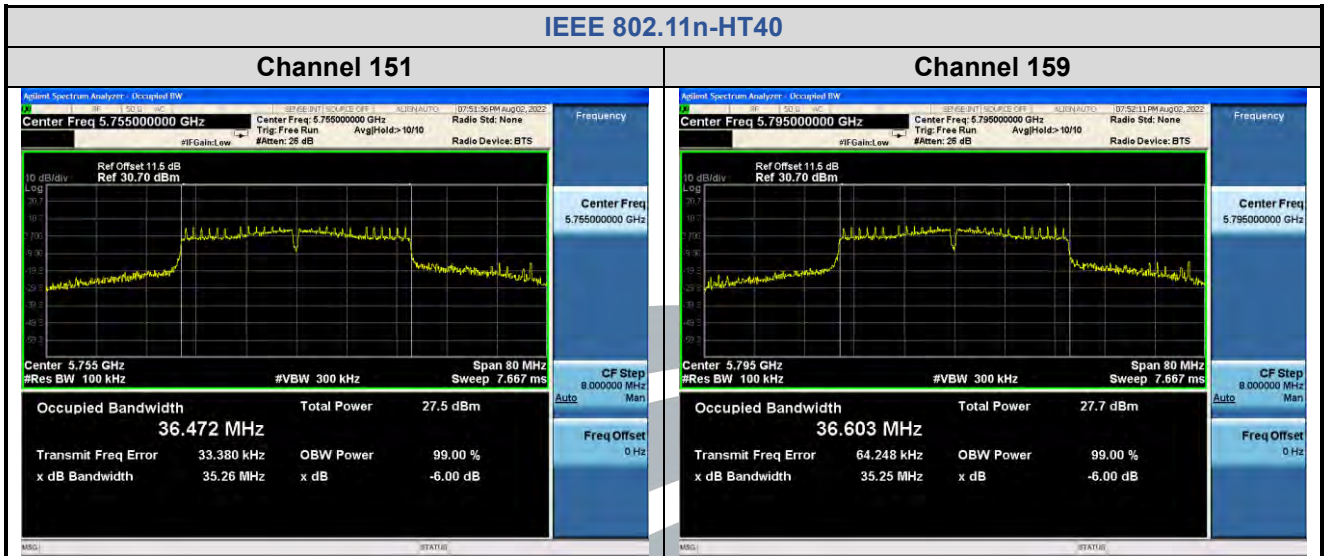

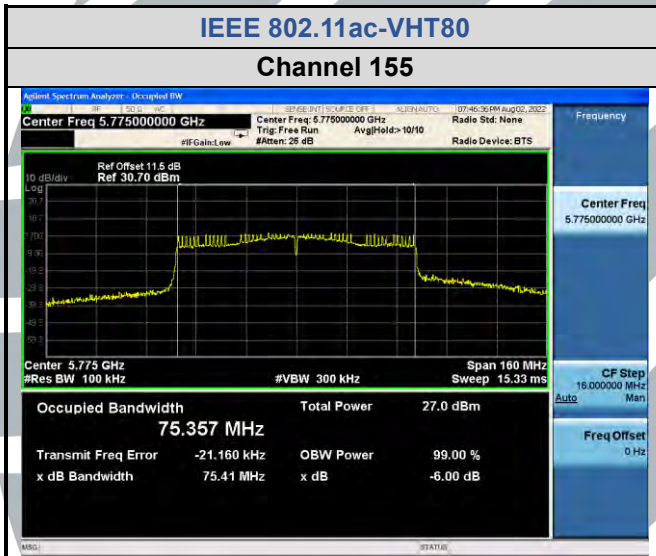
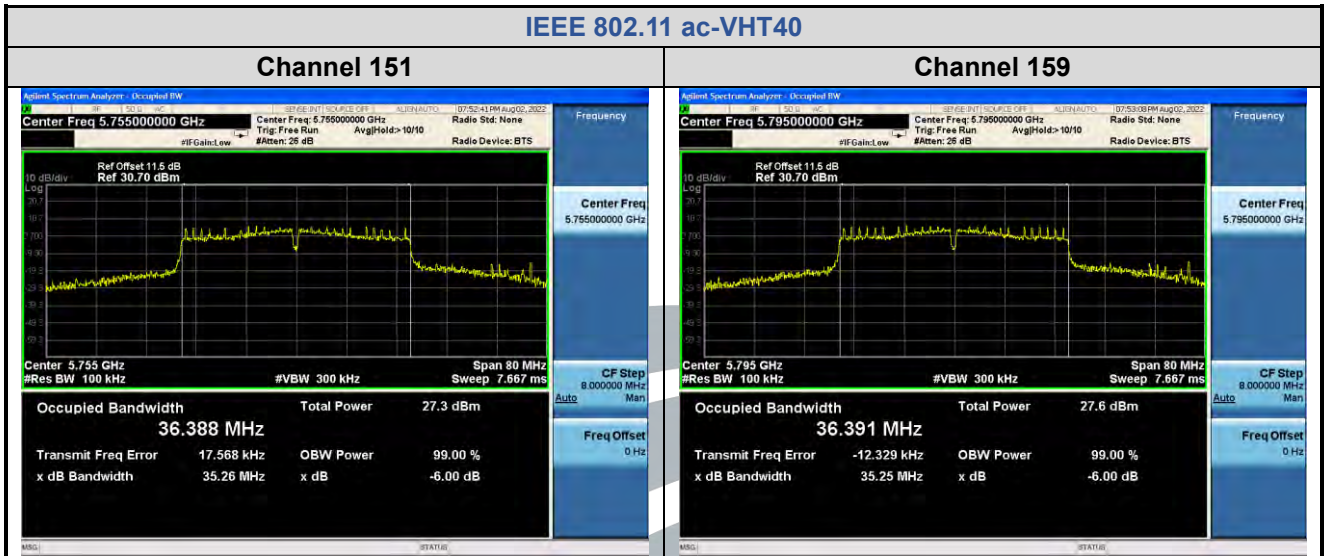

Occupied Bandwidth

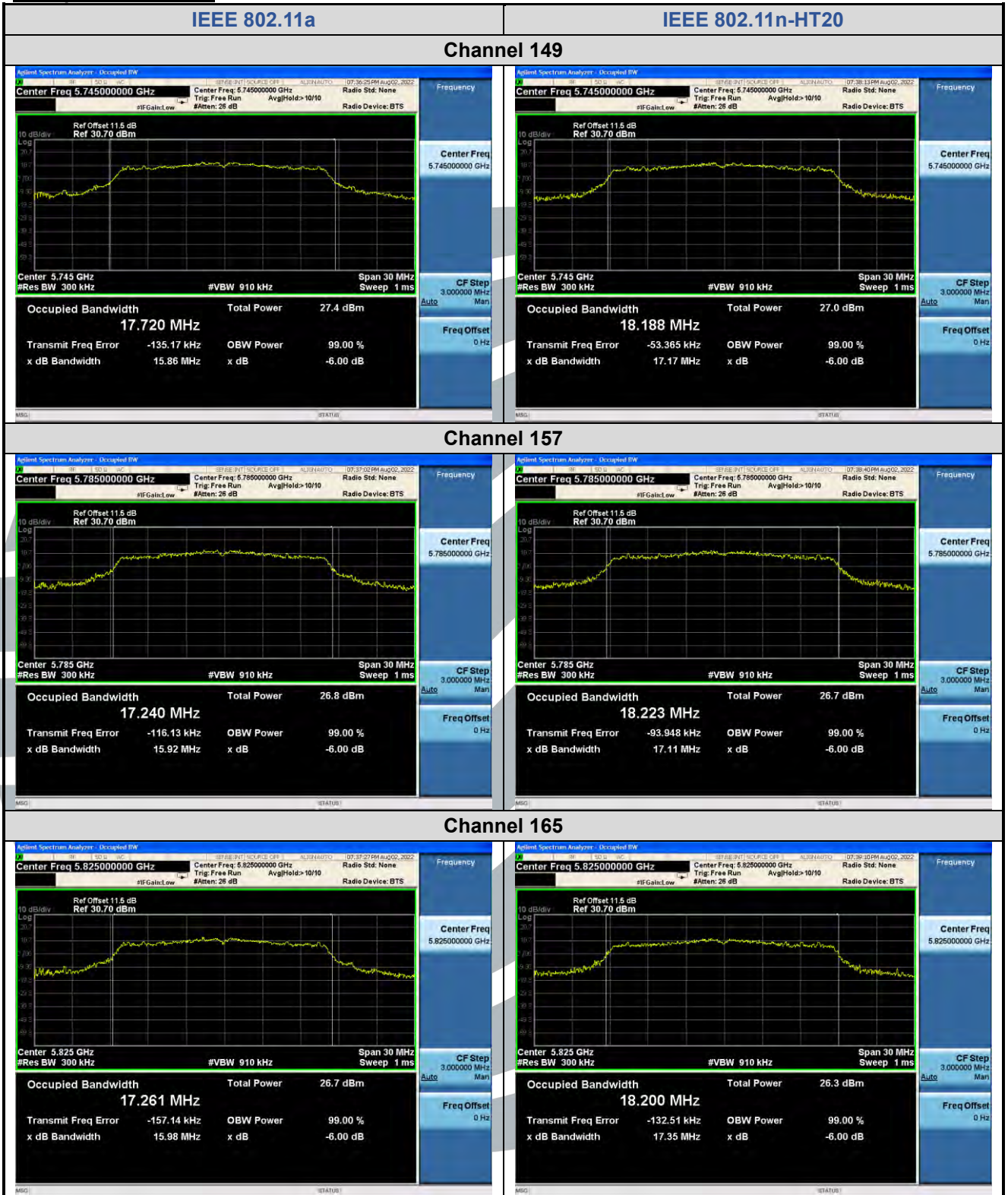



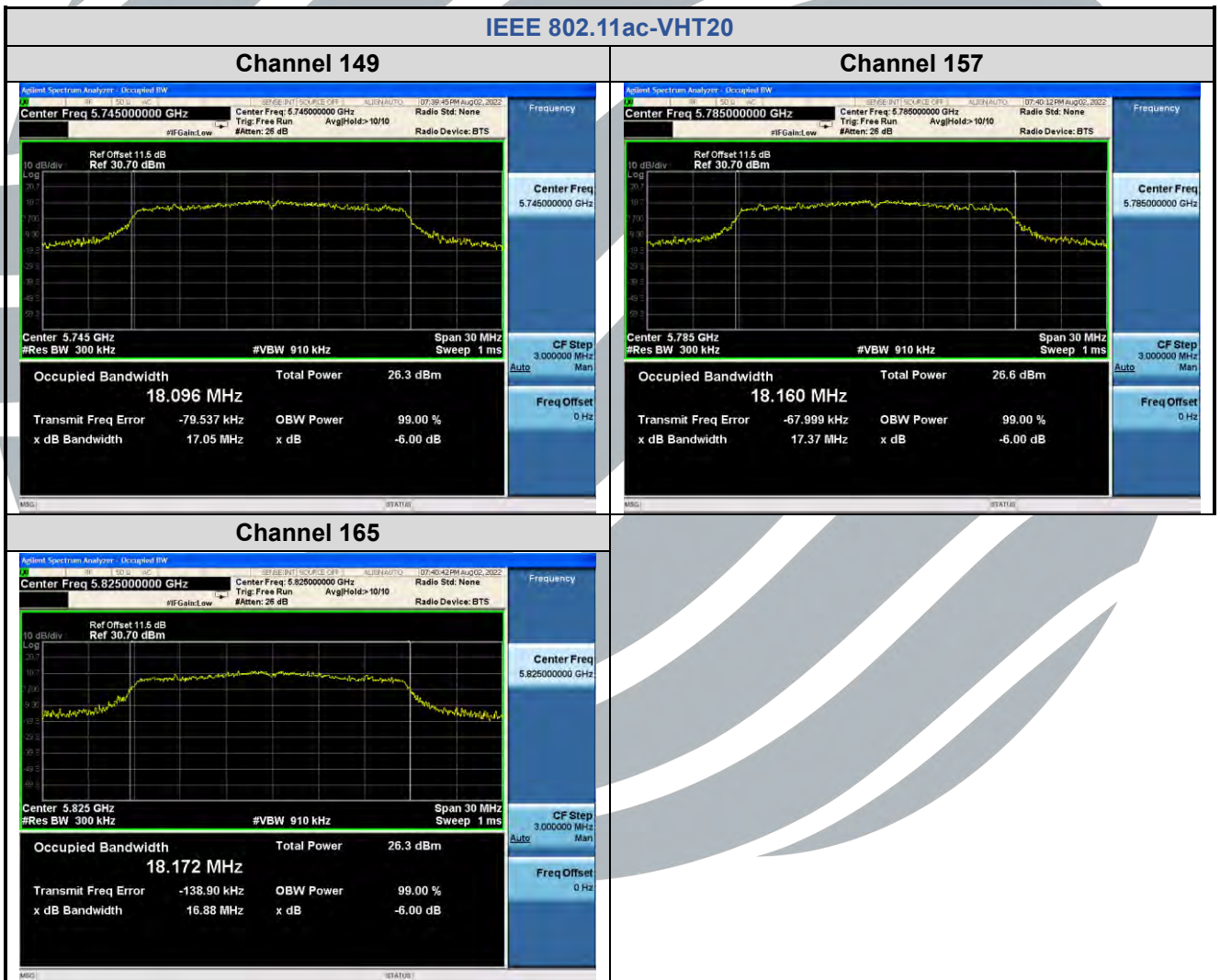
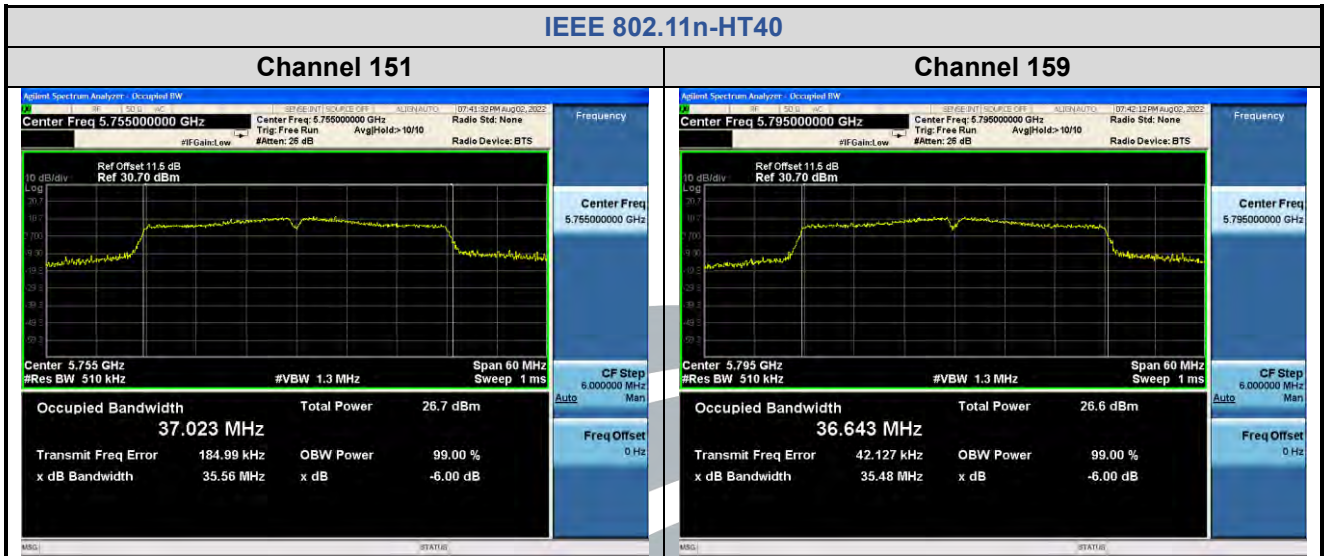

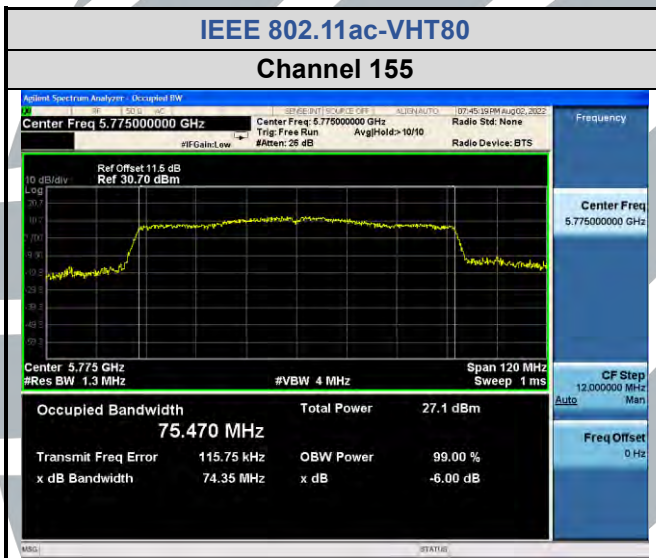
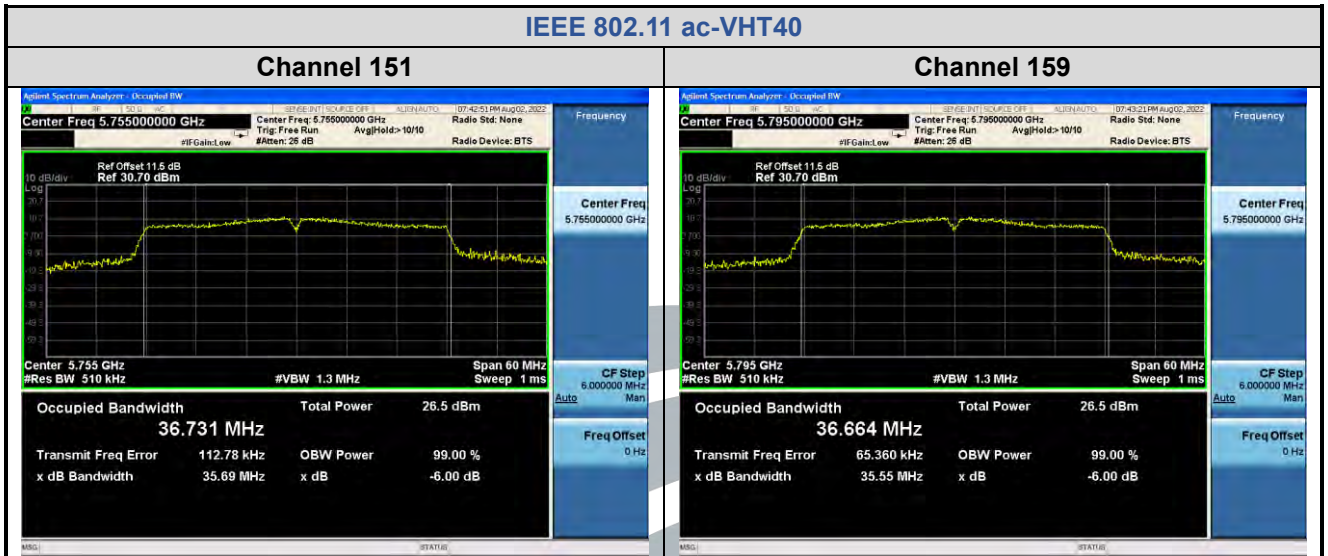

## 5.5 MAXIMUM CONDUCTED OUTPUT POWER OR E.I.R.P

**Test Requirement:** FCC 47 CFR Part 15 Subpart E Section 15.407 (a)(1)(2)(3)  
RSS-247 Issue 2 Section 6.2.1.1/6.2.2.1/6.2.3.1/6.2.4.1

**Test Method:** KDB 789033 D02 v02r01 Section E.3.a (Method PM)

**Limits:** FCC 47 CFR Part 15 Subpart E

1. For the band 5.15-5.25 GHz.
  - (i) For an outdoor access point operating in the band 5.15-5.25 GHz, the maximum conducted output power over the frequency band of operation shall not exceed 1 W provided the maximum antenna gain does not exceed 6 dBi. In addition, the maximum power spectral density shall not exceed 17 dBm in any 1 megahertz band. If transmitting antennas of directional gain greater than 6 dBi are used, both the maximum conducted output power and the maximum power spectral density shall be reduced by the amount in dB that the directional gain of the antenna exceeds 6 dBi. The maximum e.i.r.p. at any elevation angle above 30 degrees as measured from the horizon must not exceed 125 mW (21 dBm).
  - (ii) For an indoor access point operating in the band 5.15-5.25 GHz, the maximum conducted output power over the frequency band of operation shall not exceed 1 W provided the maximum antenna gain does not exceed 6 dBi. In addition, the maximum power spectral density shall not exceed 17 dBm in any 1 megahertz band. If transmitting antennas of directional gain greater than 6 dBi are used, both the maximum conducted output power and the maximum power spectral density shall be reduced by the amount in dB that the directional gain of the antenna exceeds 6 dBi.
  - (iii) For fixed point-to-point access points operating in the band 5.15-5.25 GHz, the maximum conducted output power over the frequency band of operation shall not exceed 1 W. In addition, the maximum power spectral density shall not exceed 17 dBm in any 1 megahertz band. Fixed point-to-point U-NII devices may employ antennas with directional gain up to 23 dBi without any corresponding reduction in the maximum conducted output power or maximum power spectral density. For fixed point-to-point transmitters that employ a directional antenna gain greater than 23 dBi, a 1 dB reduction in maximum conducted output power and maximum power spectral density is required for each 1 dB of antenna gain in excess of 23 dBi. Fixed, point-to-point operations exclude the use of point-to-multipoint systems, omnidirectional applications, and multiple collocated transmitters transmitting the same information. The operator of the U-NII device, or if the equipment is professionally installed, the installer, is responsible for ensuring that systems employing high gain directional antennas are used exclusively for fixed, point-to-point operations.
  - (iv) For client devices in the 5.15-5.25 GHz band, the maximum conducted output power over the frequency band of operation shall not exceed 250 mW provided the maximum antenna gain does not exceed 6 dBi. In addition, the maximum power spectral density shall not exceed 11 dBm in any 1 megahertz band. If transmitting antennas of directional gain greater than 6 dBi are used, both the maximum conducted output power and the maximum power spectral density shall be reduced by the amount in dB that the directional gain of the antenna exceeds 6 dBi.
2. For the 5.25-5.35 GHz and 5.47-5.725 GHz bands, the maximum conducted output power over the frequency bands of operation shall not exceed the lesser of 250 mW or  $11 \text{ dBm} + 10 \log B$ , where B is the 26 dB emission bandwidth in megahertz. In addition, the maximum power spectral density shall not exceed 11 dBm in any 1 megahertz band. If transmitting antennas of directional gain greater than 6 dBi are used, both the maximum conducted output power and the maximum power spectral density shall be reduced by the amount in dB that the directional gain of the antenna exceeds 6 dBi.
3. For the band 5.725-5.85 GHz, the maximum conducted output power over the frequency band of operation shall not exceed 1 W. In addition, the maximum power spectral density shall not exceed 30 dBm in any 500-kHz band. If transmitting antennas of directional gain greater than 6 dBi are used, both the maximum conducted output power and the maximum power spectral density shall be reduced by the amount in dB that the directional gain of the antenna exceeds 6 dBi. However, fixed point-to-point U-NII devices operating in this band may employ transmitting antennas with directional gain greater than 6 dBi without any corresponding reduction in transmitter conducted power. Fixed, point-to-point operations exclude the use of point-to-multipoint systems, omnidirectional applications, and multiple collocated transmitters transmitting the same information. The operator of the U-NII device, or if the equipment is professionally installed, the installer, is responsible for ensuring that systems employing high gain directional antennas are used exclusively for fixed, point-to-point operations.

### Shenzhen UnionTrust Quality and Technology Co., Ltd.

Address: Unit D/E of 9/F and 16/F, Block A, Building 6, Baoneng science and technology park, Longhua district, Shenzhen, China

Tel: +86-755-28230888

Fax: +86-755-28230886

E-mail: info@uttlab.com

<http://www.uttlab.com>

UTTR-RF-RSS247-V1.1

Limits: RSS-247 Issue 2

**1. Frequency band 5150-5250 MHz**

For OEM devices installed in vehicles, the maximum e.i.r.p. shall not exceed 30 mW or  $1.76 + 10 \log_{10}B$ , dBm, whichever is less. Devices shall implement transmitter power control (TPC) in order to have the capability to operate at least 3 dB below the maximum permitted e.i.r.p. of 30 mW.

For other devices, the maximum e.i.r.p. shall not exceed 200 mW or  $10 + 10 \log_{10}B$ , dBm, whichever power is less. B is the 99% emission bandwidth in megahertz. The e.i.r.p. spectral density shall not exceed 10 dBm in any 1.0 MHz band.

**2. Frequency band 5250-5350 MHz**

For OEM devices installed in vehicles, the maximum e.i.r.p. shall not exceed 30 mW or  $1.76 + 10 \log_{10}B$ , dBm, whichever is less. Devices shall implement TPC in order to have the capability to operate at least 3 dB below the maximum permitted e.i.r.p. of 30 mW.

Devices, other than devices installed in vehicles, shall comply with the following:

- a) The maximum conducted output power shall not exceed 250 mW or  $11 + 10 \log_{10}B$ , dBm, whichever is less. The power spectral density shall not exceed 11 dBm in any 1.0 MHz band;
- b) The maximum e.i.r.p. shall not exceed 1.0 W or  $17 + 10 \log_{10}B$ , dBm, whichever is less, B is the 99% emission bandwidth in megahertz. Note that devices with a maximum e.i.r.p. greater than 500 mW shall implement TPC in order to have the capability to operate at least 6 dB below the maximum permitted e.i.r.p. of 1 W.

**Additional requirements**

In addition to the above requirements, devices shall comply with the following, where applicable:

- a) Outdoor fixed devices with a maximum e.i.r.p. greater than 200 mW shall comply with the following e.i.r.p. at different elevations, where  $\theta$  is the angle above the local horizontal plane (of the Earth) as shown below:
 

i. -13 dBW/MHz	for $0^\circ \leq \theta < 8^\circ$
ii. $-13 - 0.716 (\theta - 8)$ dBW/MHz	for $8^\circ \leq \theta < 40^\circ$
iii. $-35.9 - 1.22 (\theta - 40)$ dBW/MHz	for $40^\circ \leq \theta \leq 45^\circ$
iv. -42 dBW/MHz	for $\theta > 45^\circ$

The measurement procedure defined in Annex A of this document shall be used to verify the compliance to the e.i.r.p. at different elevations.

- b) Devices, other than outdoor fixed devices, having an e.i.r.p. greater than 200 mW shall comply with either i. or ii. below:
  - i. devices shall comply with the e.i.r.p. elevation mask in 6.2.2.3(a); or
  - ii. devices shall implement a method to permanently reduce their e.i.r.p. via a firmware feature in the event that the Department requires it. The test report must demonstrate how the device's power table can be updated to meet this firmware requirement. The manufacturer shall provide this firmware to update all systems automatically in compliance with the directions received from the Department.

**3. Frequency bands 5470-5600 MHz and 5650-5725 MHz**

The maximum conducted output power shall not exceed 250 mW or  $11 + 10 \log_{10}B$ , dBm, whichever is less. The power spectral density shall not exceed 11 dBm in any 1.0 MHz band.

The maximum e.i.r.p. shall not exceed 1.0 W or  $17 + 10 \log_{10}B$ , dBm, whichever is less. B is the 99% emission bandwidth in megahertz. Note that devices with a maximum e.i.r.p. greater than 500 mW shall implement TPC in order to have the capability to operate at least 6 dB below the maximum permitted e.i.r.p. of 1 W.

**4. Frequency band 5725-5850 MHz**

The maximum conducted output power shall not exceed 1 W. The output power spectral density shall not exceed 30 dBm in any 500 kHz band. If transmitting antennas of directional gain greater than 6 dBi are used, both the maximum conducted output power and the output power spectral density shall be reduced by the amount in dB that the directional gain of the antenna exceeds 6 dBi. However, fixed point-to-point devices

operating in this band may employ transmitting antennas with directional gain greater than 6 dBi without any corresponding reduction in transmitter conducted power. Fixed point-to-point operations exclude the use of point-to-multipoint<sup>3</sup> systems, omnidirectional applications and multiple collocated transmitters transmitting the same information.

**Test Procedure:**

1. Connected the EUT's antenna port to measure device by 10dB attenuator.
2. Method PM is used to perform output power measurement, trigger and gating function of wide band power meter is enabled to measure max output power of Tx on burst.

Note: The cable loss and attenuator loss were offset into measure device as an amplitude offset.

**Test Setup:** Refer to section 4.5.3 for details.

**Instruments Used:** Refer to section 3 for details

**Test Mode:** Transmitter mode

**Test Results:** Pass

**Test Data:**

**Gain and the maximum output power limit.**

**RSS-247 Issue 2**

Frequency Band	Antenna Gain (dBi)	Power Limits (dBm)
U-NII-1	3.5	23.00
U-NII-2A	3.5	24.00
U-NII-2C	3.5	24.00
U-NII-3	3.5	30.00

**FCC 47 CFR Part 15 Subpart E**

Frequency Band	Antenna Gain (dBi)	Power Limits (dBm)
U-NII-1	3.5	24.00
U-NII-2A	3.5	24.00
U-NII-2C	3.5	24.00
U-NII-3	3.5	30.00

**Frequency band 5150-5250 MHz**

**RSS-247 Issue 2:**

For IEEE 802.11a, the minimum 99% emission bandwidth is 16.716MHz  
 $10 \text{ dBm} + 10\log_{10}(16.716) = 22.23 \text{ dBm} < 23 \text{ dBm}$   
 So the 22.23 dB limit applicable

For IEEE 802.11n-HT20/ ac-VHT20, the minimum 99% emission bandwidth is 17.827 MHz  
 $10 \text{ dBm} + 10\log_{10}(17.827) = 22.51 \text{ dBm} < 23 \text{ dBm}$   
 So the 22.51 dB limit applicable

For IEEE 802.11n-HT40/ ac-VHT40/ ac-VHT80, the minimum 99% emission bandwidth is 36.104 MHz  
 $10 \text{ dBm} + 10\log_{10}(36.104) = 25.58 \text{ dBm} > 23 \text{ dBm}$   
 So the 23 dB limit applicable

**Frequency band 5250-5350 MHz**

**RSS-247 Issue 2:**

For IEEE 802.11 a, the minimum 99% emission bandwidth is 16.799 MHz  
 $11 \text{ dBm} + 10\log_{10}(16.799) = 23.25 \text{ dBm} < 24\text{dBm}$   
 So the 23.25 dB limit applicable

For IEEE 802.11n-HT20/ ac-VHT20, the minimum 99% emission bandwidth is 17.883 MHz  
 $11 \text{ dBm} + 10\log_{10}(17.883) = 23.52 \text{ dBm} < 24\text{dBm}$   
 So the 23.52 dB limit applicable

For IEEE 802.11 n-HT40/ac-VHT40/ac-VHT80, the minimum 99% emission bandwidth is 36.123 MHz  
 $11 \text{ dBm} + 10\log_{10}(36.123) = 26.58 \text{ dBm} > 24 \text{ dBm}$   
 So the 24 dB limit applicable

**EIRP:**

For IEEE 802.11 a/n-HT20/ac-VHT20, the minimum 99% emission bandwidth is 16.799MHz  
 $17 \text{ dBm} + 10\log_{10}(16.799) = 29.25 \text{ dBm}$   
 $29.25 \text{ dBm} > 27 \text{ dBm}$   
 So the 27 dBm limit applicable

For IEEE 802.11 n-HT40/ac-VHT40/ac-VHT80, the minimum 99% emission bandwidth is 36.123 MHz  
 $17 \text{ dBm} + 10\log_{10}(36.123) = 32.58 \text{ dBm} > 27 \text{ dBm}$   
 So the 27 dBm limit applicable

**FCC 47 CFR Part 15 Subpart E:**

For IEEE 802.11 a/n/ac, the minimum 26 dB emission bandwidth is 21.28 MHz  
 $11 \text{ dBm} + 10\log_{10}(21.28) = 24.28 \text{ dBm} > 24 \text{ dBm}$   
 So the 24 dB limit applicable

**Frequency bands 5470-5725 MHz (RSS-247 Issue 2 Not including 5600-5650 MHz)**

**RSS-247 Issue 2:**

For IEEE 802.11 a, the minimum 99% emission bandwidth is 17.106MHz  
 $11 \text{ dBm} + 10\log_{10}(17.106) = 23.33 \text{ dBm} < 24 \text{ dBm}$   
 So the 23.33 dB limit applicable

For IEEE 802.11n-HT20/ac-VHT20, the minimum 99% emission bandwidth is 17.984 MHz  
 $11 \text{ dBm} + 10\log_{10}(17.984) = 23.55 \text{ dBm} < 24 \text{ dBm}$   
 So the 23.55 dB limit applicable

For IEEE 802.11 n-HT40/ac-VHT40/ac-VHT80, the minimum 99% emission bandwidth is 36.303 MHz  
 $11 \text{ dBm} + 10\log_{10}(36.307) = 26.60 \text{ dBm} > 24 \text{ dBm}$   
 So the 24 dB limit applicable

**EIRP:**

For IEEE 802.11 a/n-HT20/ac-VHT20, the minimum 99% emission bandwidth is 17.106 MHz  
 $17 \text{ dBm} + 10\log_{10}(17.106) = 29.33 \text{ dBm}$   
 $29.33 \text{ dBm} > 27 \text{ dBm}$   
 So the 27 dBm limit applicable

For IEEE 802.11 n-HT40/ac-VHT40 /ac-VHT80, the minimum 99% emission bandwidth is 36.303 MHz  
 $17 \text{ dBm} + 10\log_{10}(36.303) = 32.60 \text{ dBm} > 27 \text{ dBm}$   
 So the 27 dBm limit applicable

**FCC 47 CFR Part 15 Subpart E:**

For IEEE 802.11 a/n/ac, the minimum 26 dB emission bandwidth is 25.38 MHz  
 $11 \text{ dBm} + 10\log_{10}(25.38) = 25.38 \text{ dBm} > 24 \text{ dBm}$   
 So the 24 dB limit applicable

Mode	Band	Channel	CONDUCTED AVG POWER				EIRP		Result
			Meas Value (dBm)	Corr'd Value (dBm)	FCC Limit (dBm)	ISED Limit (dBm)	EIRP (dBm)	ISED Limit (dBm)	
			Ant. 0	Ant. 0			Ant. 0		
IEEE 802.11a	U-NII-1	36	12.93	13.10	24.00	--	16.60	22.23	Pass
		44	12.82	12.99	24.00	--	16.49	22.23	Pass
		48	12.70	12.87	24.00	--	16.37	22.23	Pass
	U-NII-2A	52	17.18	17.35	24.00	23.25	20.85	27.00	Pass
		60	17.16	17.33	24.00	23.25	20.83	27.00	Pass
		64	17.06	17.23	24.00	23.25	20.73	27.00	Pass
	U-NII-2C	100	17.46	17.63	24.00	23.33	21.13	27.00	Pass
		116	16.74	16.91	24.00	23.33	20.41	27.00	Pass
		140	16.53	16.70	24.00	23.33	20.20	27.00	Pass
	U-NII-3	149	17.57	17.74	30.00	30.00	21.24	36.02	Pass
		157	17.77	17.94	30.00	30.00	21.44	36.02	Pass
		165	17.65	17.82	30.00	30.00	21.32	36.02	Pass
IEEE 802.11n-HT20	U-NII-1	36	12.50	12.66	24.00	--	16.16	22.51	Pass
		44	12.48	12.64	24.00	--	16.14	22.51	Pass
		48	12.46	12.62	24.00	--	16.12	22.51	Pass
	U-NII-2A	52	18.10	18.26	24.00	23.52	21.76	27.00	Pass
		60	17.69	17.85	24.00	23.52	21.35	27.00	Pass
		64	17.90	18.06	24.00	23.52	21.56	27.00	Pass
	U-NII-2C	100	17.25	17.41	24.00	23.55	20.91	27.00	Pass
		116	16.55	16.71	24.00	23.55	20.21	27.00	Pass
		140	16.20	16.36	24.00	23.55	19.86	27.00	Pass
	U-NII-3	149	17.38	17.54	30.00	30.00	21.04	36.02	Pass
		157	17.28	17.44	30.00	30.00	20.94	36.02	Pass
		165	17.41	17.57	30.00	30.00	21.07	36.02	Pass
IEEE 802.11n-HT40	U-NII-1	38	16.62	16.96	24.00	--	20.46	23.00	Pass
		46	16.51	16.85	24.00	--	20.35	23.00	Pass
	U-NII-2A	54	17.83	18.17	24.00	24.00	21.67	27.00	Pass
		62	17.64	17.98	24.00	24.00	21.48	27.00	Pass
	U-NII-2C	102	17.18	17.52	24.00	24.00	21.02	27.00	Pass
		110	16.61	16.95	24.00	24.00	20.45	27.00	Pass
	U-NII-3	134	16.01	16.35	24.00	24.00	19.85	27.00	Pass
		151	17.14	17.48	30.00	30.00	20.98	36.02	Pass
IEEE 802.11ac-VHT20	U-NII-1	159	17.38	17.72	30.00	30.00	21.22	36.02	Pass
		36	12.60	12.78	24.00	--	16.28	22.51	Pass
		44	12.33	12.51	24.00	--	16.01	22.51	Pass
		48	12.41	12.59	24.00	--	16.09	22.51	Pass

**Shenzhen UnionTrust Quality and Technology Co., Ltd.**

	U-NII-2A	52	18.02	18.20	23.52	23.52	21.70	27.00	Pass
		60	17.88	18.06	23.52	23.52	21.56	27.00	Pass
		64	17.77	17.95	23.52	23.52	21.45	27.00	Pass
	U-NII-2C	100	17.19	17.37	24.00	23.55	20.87	27.00	Pass
		116	16.51	16.69	24.00	23.55	20.19	27.00	Pass
		140	16.17	16.35	24.00	23.55	19.85	27.00	Pass
	U-NII-3	149	17.30	17.48	30.00	30.00	20.98	36.02	Pass
		157	17.32	17.50	30.00	30.00	21.00	36.02	Pass
		165	17.48	17.66	30.00	30.00	21.16	36.02	Pass
IEEE 802.11ac-VHT40	U-NII-1	38	16.73	17.04	24.00	--	20.54	23.00	Pass
		46	16.61	16.92	24.00	--	20.42	23.00	Pass
	U-NII-2A	54	16.57	16.88	24.00	24.00	20.38	27.00	Pass
		62	16.48	16.79	24.00	24.00	20.29	27.00	Pass
	U-NII-2C	102	16.95	17.26	24.00	24.00	20.76	27.00	Pass
		110	16.57	16.88	24.00	24.00	20.38	27.00	Pass
		134	15.93	16.24	24.00	24.00	19.74	27.00	Pass
	U-NII-3	151	17.08	17.39	30.00	30.00	20.89	36.02	Pass
		159	17.33	17.64	30.00	30.00	21.14	36.02	Pass
IEEE 802.11ac-VHT80	U-NII-1	42	18.65	19.21	24.00	--	22.71	23.00	Pass
	U-NII-2A	58	18.44	19.00	24.00	24.00	22.50	27.00	Pass
	U-NII-2C	106	19.02	19.58	24.00	24.00	23.08	27.00	Pass
	U-NII-3	155	16.50	17.06	30.00	30.00	20.56	36.02	Pass



## 5.6 PEAK POWER SPECTRAL DENSITY

**Test Requirement:** FCC 47 CFR Part 15 Subpart E Section 15.407 (a)(1)(2)(3)  
RSS-247 Issue 2 Section 6.2.1.1/6.2.2.1/6.2.3.1/6.2.4.1

**Test Method:** KDB 789033 D02 v02r01 Section F

**Limits:** FCC 47 CFR Part 15 Subpart E

1. For the band 5.15-5.25 GHz.
  - (i) For an outdoor access point operating in the band 5.15-5.25 GHz, the maximum conducted output power over the frequency band of operation shall not exceed 1 W provided the maximum antenna gain does not exceed 6 dBi. In addition, the maximum power spectral density shall not exceed 17 dBm in any 1 megahertz band. If transmitting antennas of directional gain greater than 6 dBi are used, both the maximum conducted output power and the maximum power spectral density shall be reduced by the amount in dB that the directional gain of the antenna exceeds 6 dBi. The maximum e.i.r.p. at any elevation angle above 30 degrees as measured from the horizon must not exceed 125 mW (21 dBm).
  - (ii) For an indoor access point operating in the band 5.15-5.25 GHz, the maximum conducted output power over the frequency band of operation shall not exceed 1 W provided the maximum antenna gain does not exceed 6 dBi. In addition, the maximum power spectral density shall not exceed 17 dBm in any 1 megahertz band. If transmitting antennas of directional gain greater than 6 dBi are used, both the maximum conducted output power and the maximum power spectral density shall be reduced by the amount in dB that the directional gain of the antenna exceeds 6 dBi.
  - (iii) For fixed point-to-point access points operating in the band 5.15-5.25 GHz, the maximum conducted output power over the frequency band of operation shall not exceed 1 W. In addition, the maximum power spectral density shall not exceed 17 dBm in any 1 megahertz band. Fixed point-to-point U-NII devices may employ antennas with directional gain up to 23 dBi without any corresponding reduction in the maximum conducted output power or maximum power spectral density. For fixed point-to-point transmitters that employ a directional antenna gain greater than 23 dBi, a 1 dB reduction in maximum conducted output power and maximum power spectral density is required for each 1 dB of antenna gain in excess of 23 dBi. Fixed, point-to-point operations exclude the use of point-to-multipoint systems, omnidirectional applications, and multiple collocated transmitters transmitting the same information. The operator of the U-NII device, or if the equipment is professionally installed, the installer, is responsible for ensuring that systems employing high gain directional antennas are used exclusively for fixed, point-to-point operations.
  - (iv) For client devices in the 5.15-5.25 GHz band, the maximum conducted output power over the frequency band of operation shall not exceed 250 mW provided the maximum antenna gain does not exceed 6 dBi. In addition, the maximum power spectral density shall not exceed 11 dBm in any 1 megahertz band. If transmitting antennas of directional gain greater than 6 dBi are used, both the maximum conducted output power and the maximum power spectral density shall be reduced by the amount in dB that the directional gain of the antenna exceeds 6 dBi.
2. For the 5.25-5.35 GHz and 5.47-5.725 GHz bands, the maximum conducted output power over the frequency bands of operation shall not exceed the lesser of 250 mW or 11 dBm + 10 log B, where B is the 26 dB emission bandwidth in megahertz. In addition, the maximum power spectral density shall not exceed 11 dBm in any 1 megahertz band. If transmitting antennas of directional gain greater than 6 dBi are used, both the maximum conducted output power and the maximum power spectral density shall be reduced by the amount in dB that the directional gain of the antenna exceeds 6 dBi.
3. For the band 5.725-5.85 GHz, the maximum conducted output power over the frequency band of operation shall not exceed 1 W. In addition, the maximum power spectral density shall not exceed 30 dBm in any 500-kHz band. If transmitting antennas of directional gain greater than 6 dBi are used, both the maximum conducted output power and the maximum power spectral density shall be reduced by the amount in dB that the directional gain of the antenna exceeds 6 dBi. However, fixed point-to-point U-NII devices operating in this band may employ transmitting antennas with directional gain greater than 6 dBi without any corresponding reduction in transmitter conducted power. Fixed, point-to-point operations exclude the use of point-to-multipoint systems, omnidirectional applications, and multiple collocated transmitters transmitting the same information. The operator of the U-NII device, or if the equipment is professionally installed, the installer, is responsible for ensuring that systems employing high gain directional antennas are used exclusively for fixed, point-to-point operations.

### Shenzhen UnionTrust Quality and Technology Co., Ltd.

Address: Unit D/E of 9/F and 16/F, Block A, Building 6, Baoneng science and technology park, Longhua district, Shenzhen, China

Tel: +86-755-28230888

Fax: +86-755-28230886

E-mail: info@uttlab.com

<http://www.uttlab.com>

UTTR-RF-RSS247-V1.1

Limits: RSS-247 Issue 2

**1. Frequency band 5150-5250 MHz**

For OEM devices installed in vehicles, the maximum e.i.r.p. shall not exceed 30 mW or  $1.76 + 10 \log_{10}B$ , dBm, whichever is less. Devices shall implement transmitter power control (TPC) in order to have the capability to operate at least 3 dB below the maximum permitted e.i.r.p. of 30 mW.

For other devices, the maximum e.i.r.p. shall not exceed 200 mW or  $10 + 10 \log_{10}B$ , dBm, whichever power is less. B is the 99% emission bandwidth in megahertz. The e.i.r.p. spectral density shall not exceed 10 dBm in any 1.0 MHz band.

**2. Frequency band 5250-5350 MHz**

For OEM devices installed in vehicles, the maximum e.i.r.p. shall not exceed 30 mW or  $1.76 + 10 \log_{10}B$ , dBm, whichever is less. Devices shall implement TPC in order to have the capability to operate at least 3 dB below the maximum permitted e.i.r.p. of 30 mW.

Devices, other than devices installed in vehicles, shall comply with the following:

- a) The maximum conducted output power shall not exceed 250 mW or  $11 + 10 \log_{10}B$ , dBm, whichever is less. The power spectral density shall not exceed 11 dBm in any 1.0 MHz band;
- b) The maximum e.i.r.p. shall not exceed 1.0 W or  $17 + 10 \log_{10}B$ , dBm, whichever is less, B is the 99% emission bandwidth in megahertz. Note that devices with a maximum e.i.r.p. greater than 500 mW shall implement TPC in order to have the capability to operate at least 6 dB below the maximum permitted e.i.r.p. of 1 W.

**Additional requirements**

In addition to the above requirements, devices shall comply with the following, where applicable:

- a) Outdoor fixed devices with a maximum e.i.r.p. greater than 200 mW shall comply with the following e.i.r.p. at different elevations, where  $\theta$  is the angle above the local horizontal plane (of the Earth) as shown below:
 

i. -13 dBW/MHz	for $0^\circ \leq \theta < 8^\circ$
ii. $-13 - 0.716 (\theta - 8)$ dBW/MHz	for $8^\circ \leq \theta < 40^\circ$
iii. $-35.9 - 1.22 (\theta - 40)$ dBW/MHz	for $40^\circ \leq \theta \leq 45^\circ$
iv. -42 dBW/MHz	for $\theta > 45^\circ$

The measurement procedure defined in Annex A of this document shall be used to verify the compliance to the e.i.r.p. at different elevations.

- b) Devices, other than outdoor fixed devices, having an e.i.r.p. greater than 200 mW shall comply with either i. or ii. below:
  - iii. devices shall comply with the e.i.r.p. elevation mask in 6.2.2.3(a); or
  - iv. devices shall implement a method to permanently reduce their e.i.r.p. via a firmware feature in the event that the Department requires it. The test report must demonstrate how the device's power table can be updated to meet this firmware requirement. The manufacturer shall provide this firmware to update all systems automatically in compliance with the directions received from the Department.

**3. Frequency bands 5470-5600 MHz and 5650-5725 MHz**

The maximum conducted output power shall not exceed 250 mW or  $11 + 10 \log_{10}B$ , dBm, whichever is less. The power spectral density shall not exceed 11 dBm in any 1.0 MHz band.

The maximum e.i.r.p. shall not exceed 1.0 W or  $17 + 10 \log_{10}B$ , dBm, whichever is less. B is the 99% emission bandwidth in megahertz. Note that devices with a maximum e.i.r.p. greater than 500 mW shall implement TPC in order to have the capability to operate at least 6 dB below the maximum permitted e.i.r.p. of 1 W.

**4. Frequency band 5725-5850 MHz**

The maximum conducted output power shall not exceed 1 W. The output power spectral density shall not exceed 30 dBm in any 500 kHz band. If transmitting antennas of directional gain greater than 6 dBi are used, both the maximum conducted output power and the output power spectral density shall be reduced by the amount in dB that the directional gain of the antenna exceeds 6 dBi. However, fixed point-to-point devices

operating in this band may employ transmitting antennas with directional gain greater than 6 dBi without any corresponding reduction in transmitter conducted power. Fixed point-to-point operations exclude the use of point-to-multipoint<sup>3</sup> systems, omnidirectional applications and multiple collocated transmitters transmitting the same information.

**Test Procedure:**

The output from the transmitter was connected to an attenuator and then to the input of the RF Spectrum Analyzer.

Spectrum analyzer according to the following Settings:

**1. For U-NII-1, U-NII-2A, U-NII-2C band:**

Using method SA-2

- a) Set span to encompass the entire emission bandwidth (EBW) of the signal.
- b) Set RBW = 1 MHz, Set VBW ≥ 3 RBW, Detector = RMS
- c) Sweep time = auto, trigger set to “free run”.
- d) Trace average at least 100 traces in power averaging mode.
- e) Record the max value and add 10 log (1/duty cycle)

**2. For U-NII-3 band:**

- a) Set span to encompass the entire emission bandwidth (EBW) of the signal.
- b) Set RBW = 500 kHz, Set VBW ≥ 3 RBW, Detector = RMS
- c) Use the peak marker function to determine the maximum power level in any 500 kHz band segment within the fundamental EBW.
- d) Sweep time = auto, trigger set to “free run”.
- e) Trace average at least 100 traces in power averaging mode.
- f) Record the max value and add 10 log (1/duty cycle)

Note: The cable loss and attenuator loss were offset into measure device as an amplitude offset.

**Test Setup:** Refer to section 4.5.3 for details.

**Instruments Used:** Refer to section 3 for details

**Test Mode:** Transmitter mode

**Test Results:** Pass

**Test Data:**

**Gain and the maximum output power limit.**

**RSS-247 Issue 2:**

Frequency Band	Antenna Gain (dBi)	PSD Limits (dBm/MHz or dBm/500kHz)
U-NII-1	3.5	10.00
U-NII-2A	3.5	11.00
U-NII-2C	3.5	11.00
U-NII-3	3.5	30.00

**FCC 47 CFR Part 15 Subpart E:**

Frequency Band	Antenna Gain (dBi)	PSD Limits (dBm/MHz or dBm/500kHz)
U-NII-1	3.5	11.00
U-NII-2A	3.5	11.00
U-NII-2C	3.5	11.00
U-NII-3	3.5	30.00

**Frequency band 5150-5250 MHz  
RSS-247 Issue 2**

Mode	Channel/ Frequency (MHz)	e.i.r.p. spectral density (dBm/MHz)	Limit (dBm/MHz)	Pass / Fail
IEEE 802.11a	36 (5180)	9.06	10	Pass
	44 (5220)	8.67	10	Pass
	48 (5240)	8.68	10	Pass
IEEE 802.11n-HT20	36 (5180)	8.64	10	Pass
	44 (5220)	8.19	10	Pass
	48 (5240)	7.97	10	Pass
IEEE 802.11n-HT40	38 (5190)	9.97	10	Pass
	46 (5230)	9.93	10	Pass
IEEE 802.11ac-VHT20	36 (5180)	8.41	10	Pass
	44 (5220)	8.14	10	Pass
	48 (5240)	8.03	10	Pass
IEEE 802.11ac-VHT40	38 (5190)	8.91	10	Pass
	46 (5230)	8.73	10	Pass
IEEE 802.11ac-VHT80	42 (5210)	9.07	10	Pass

**Remark:**

- e.i.r.p. spectral density = Power spectral density + Duty Cycle Factor + Antenna Gain

**FCC 47 CFR Part 15 Subpart E**

Mode	Channel/ Frequency (MHz)	Power spectral density (dBm/MHz)		Limit (dBm/MHz)	Pass / Fail
		Meas PSD	Corr'd PSD		
IEEE 802.11a	36 (5180)	5.384	5.56	11	Pass
	44 (5220)	5.001	5.17	11	Pass
	48 (5240)	5.011	5.18	11	Pass
IEEE 802.11n-HT20	36 (5180)	4.980	5.14	11	Pass
	44 (5220)	4.533	4.69	11	Pass
	48 (5240)	4.306	4.47	11	Pass
IEEE 802.11n-HT40	38 (5190)	6.129	6.47	11	Pass
	46 (5230)	6.092	6.43	11	Pass
IEEE 802.11ac-VHT20	36 (5180)	4.728	4.91	11	Pass
	44 (5220)	4.456	4.64	11	Pass
	48 (5240)	4.348	4.53	11	Pass
IEEE 802.11ac-VHT40	38 (5190)	5.103	5.41	11	Pass
	46 (5230)	4.924	5.23	11	Pass
IEEE 802.11ac-VHT80	42 (5210)	5.015	5.57	11	Pass

**Remark:**

- Power spectral density = Conducted power spectral density + Duty Cycle Factor

**Frequency band 5250-5350 MHz**

Mode	Channel/ Frequency (MHz)	Power spectral density (dBm/MHz)		Limit (dBm/MHz)	Pass / Fail
		Meas PSD	Corr'd PSD		
IEEE 802.11a	52 (5260)	8.465	8.64	11	Pass
	60 (5300)	7.949	8.12	11	Pass
	64 (5320)	7.695	7.87	11	Pass
IEEE 802.11n-HT20	52 (5260)	8.762	8.92	11	Pass
	60 (5300)	9.005	9.17	11	Pass
	64 (5320)	8.293	8.45	11	Pass
IEEE 802.11n-HT40	54 (5270)	6.376	6.72	11	Pass
	62 (5310)	5.401	5.74	11	Pass
IEEE 802.11ac-VHT20	52 (5260)	8.808	8.99	11	Pass
	60 (5300)	8.669	8.85	11	Pass
	64 (5320)	8.524	8.71	11	Pass
IEEE 802.11ac-VHT40	54 (5270)	6.958	7.27	11	Pass
	62 (5310)	6.874	7.18	11	Pass
IEEE 802.11ac-VHT80	58 (5290)	5.095	5.65	11	Pass

**Remark:**

1. Power spectral density = Conducted power spectral density + Duty Cycle Factor

**Frequency bands 5470-5725 MHz (RSS-247 Issue 2 Not including 5600-5650 MHz)**

Mode	Channel/ Frequency (MHz)	Power spectral density (dBm/MHz)		Limit (dBm/MHz)	Pass / Fail
		Meas PSD	Corr'd PSD		
IEEE 802.11a	100 (5500)	8.270	8.44	11	Pass
	116 (5580)	8.429	8.60	11	Pass
	140 (5700)	8.751	8.92	11	Pass
IEEE 802.11n-HT20	100 (5500)	8.794	8.95	11	Pass
	116 (5580)	8.441	8.60	11	Pass
	140 (5700)	8.464	8.62	11	Pass
IEEE 802.11n-HT40	102 (5510)	5.426	5.76	11	Pass
	110 (5550)	5.158	5.50	11	Pass
IEEE 802.11ac-VHT20	134 (5670)	4.836	5.17	11	Pass
	100 (5500)	8.741	8.92	11	Pass
	116 (5580)	8.203	8.39	11	Pass
IEEE 802.11ac-VHT40	140 (5700)	8.555	8.74	11	Pass
	102 (5510)	5.193	5.50	11	Pass
	110 (5550)	5.065	5.37	11	Pass
IEEE 802.11ac-VHT80	134 (5670)	4.698	5.01	11	Pass
	106 (5530)	5.746	6.30	11	Pass

**Remark:**

1. Power spectral density = Conducted power spectral density + Duty Cycle Factor

**Frequency band 5725-5850 MHz**

Mode	Channel/ Frequency (MHz)	Power spectral density (dBm/500kHz)		Limit (dBm/500KHz)	Pass / Fail
		Meas PSD	Corr'd PSD		
IEEE 802.11a	149 (5745)	9.637	9.81	30	Pass
	157 (5785)	9.248	9.42	30	Pass
	165 (5825)	8.620	8.79	30	Pass
IEEE 802.11n-HT20	149 (5745)	8.186	8.35	30	Pass
	157 (5785)	8.363	8.52	30	Pass
	165 (5825)	8.529	8.69	30	Pass
IEEE 802.11n-HT40	151 (5755)	4.983	5.32	30	Pass
	159 (5795)	5.039	5.38	30	Pass
IEEE 802.11ac-VHT20	149 (5745)	8.970	9.15	30	Pass
	157 (5785)	8.460	8.64	30	Pass
	165 (5825)	8.810	8.99	30	Pass
IEEE 802.11ac-VHT40	151 (5755)	5.631	5.94	30	Pass
	159 (5795)	5.342	5.65	30	Pass
IEEE 802.11ac-VHT80	155 (5775)	1.769	2.33	30	Pass

**Remark:**

1. Power spectral density = Conducted power spectral density + Duty Cycle Factor

The test plots as follows:

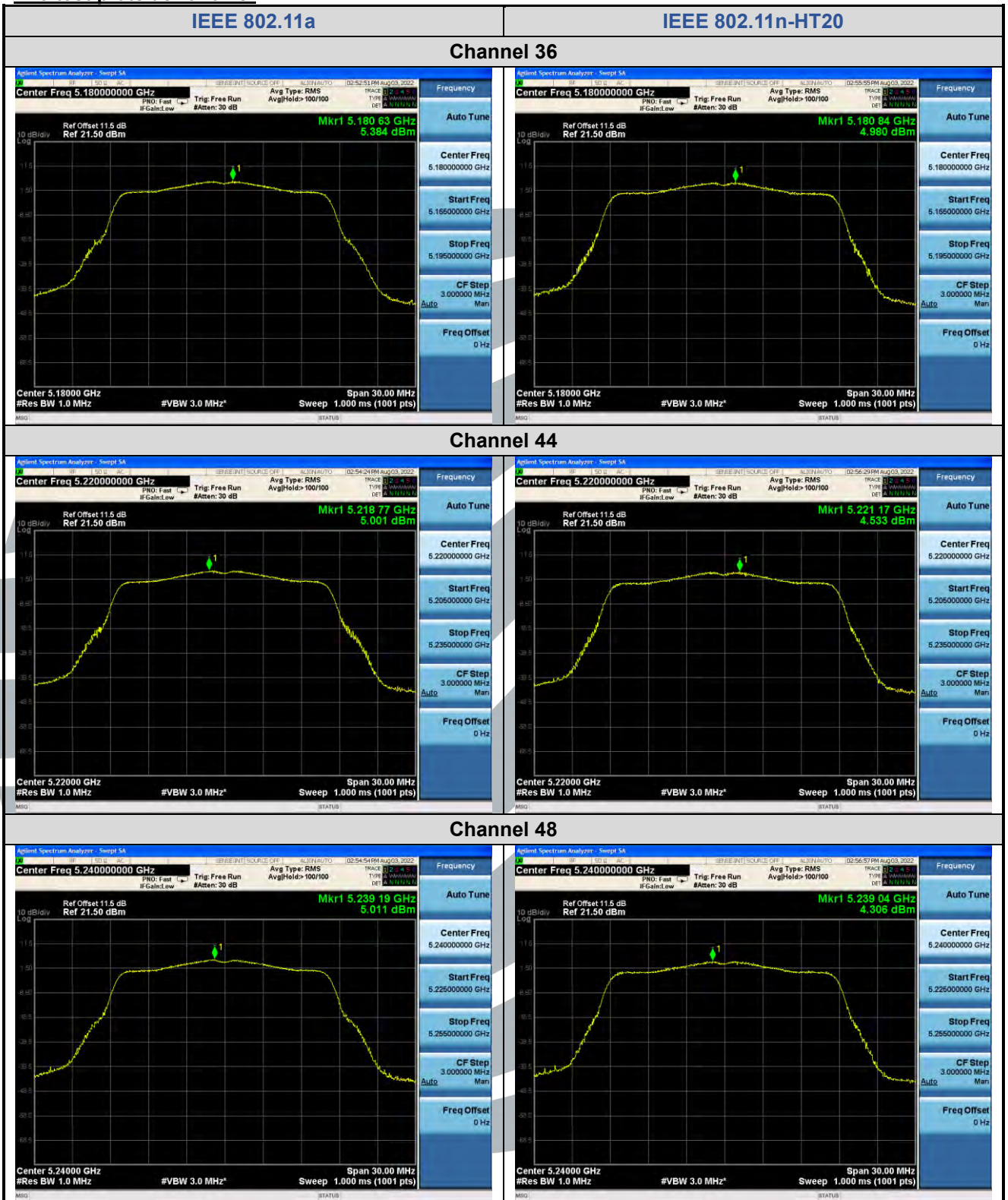

**Shenzhen UnionTrust Quality and Technology Co., Ltd.**

Address: Unit D/E of 9/F and 16/F, Block A, Building 6, Baoneng science and technology park, Longhua district, Shenzhen, China

Tel: +86-755-28230888

Fax: +86-755-28230886

E-mail: info@uttlab.com

<http://www.uttlab.com>

UTTR-RF-RSS247-V1.1

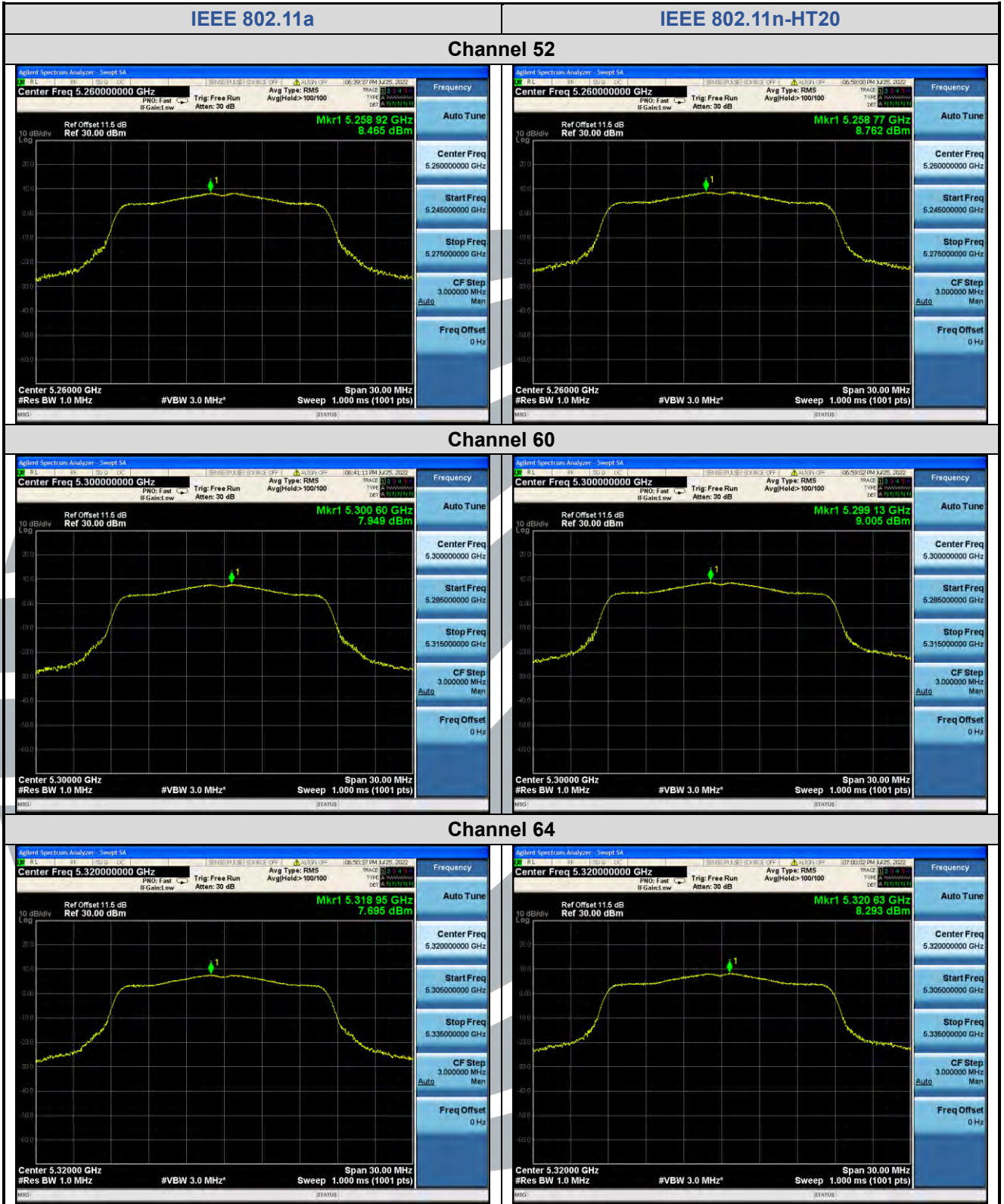

**Shenzhen UnionTrust Quality and Technology Co., Ltd.**

Address: Unit D/E of 9/F and 16/F, Block A, Building 6, Baoneng science and technology park, Longhua district, Shenzhen, China

Tel: +86-755-28230888

Fax: +86-755-28230886

E-mail: info@uttlab.com

<http://www.uttlab.com>

UTTR-RF-RSS247-V1.1



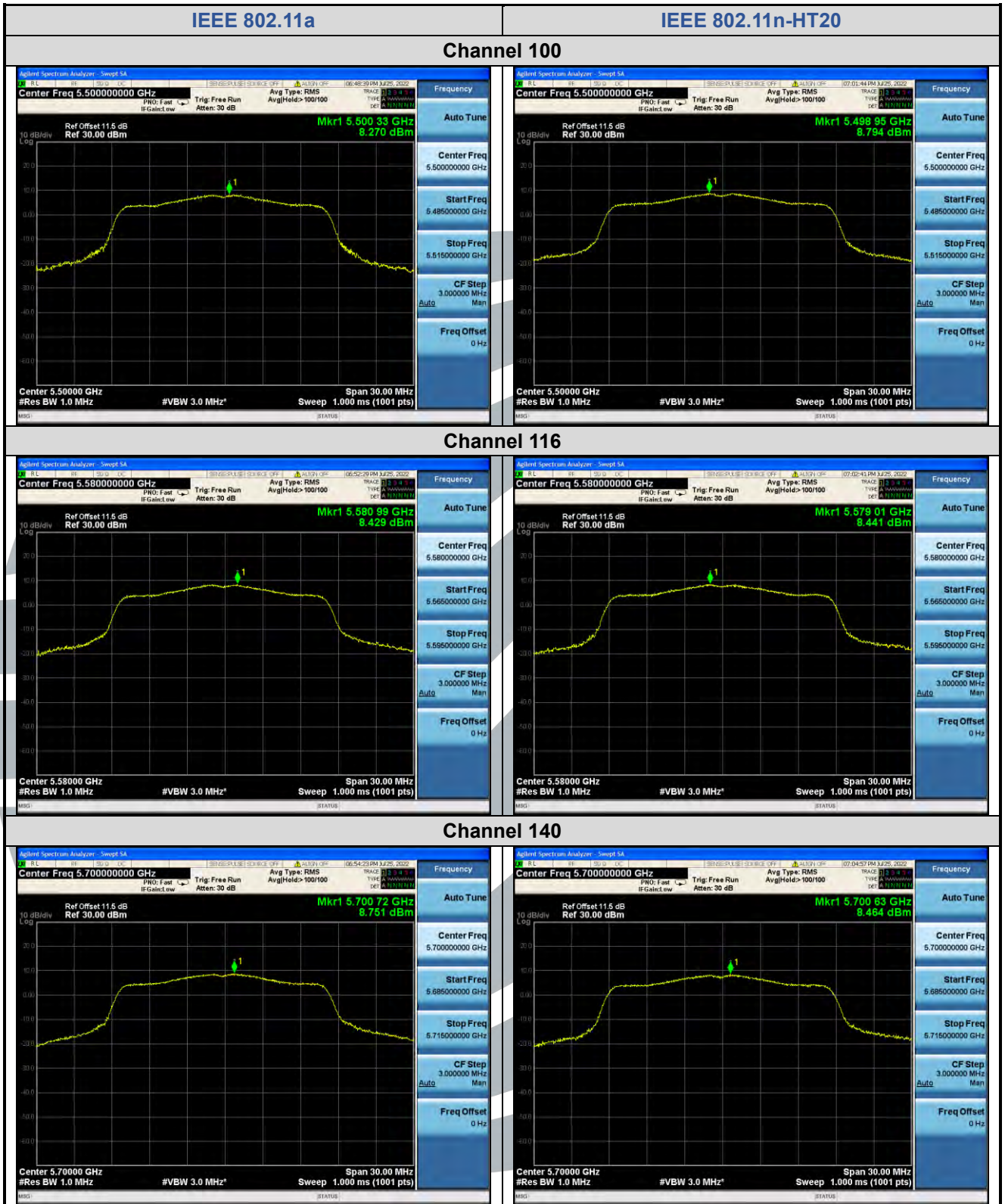

## Shenzhen UnionTrust Quality and Technology Co., Ltd.

Address: Unit D/E of 9/F and 16/F, Block A, Building 6, Baoneng science and technology park, Longhua district, Shenzhen, China

Tel: +86-755-28230888

Fax: +86-755-28230886

E-mail: info@uttlab.com

<http://www.uttlab.com>

UTTR-RF-RSS247-V1.1

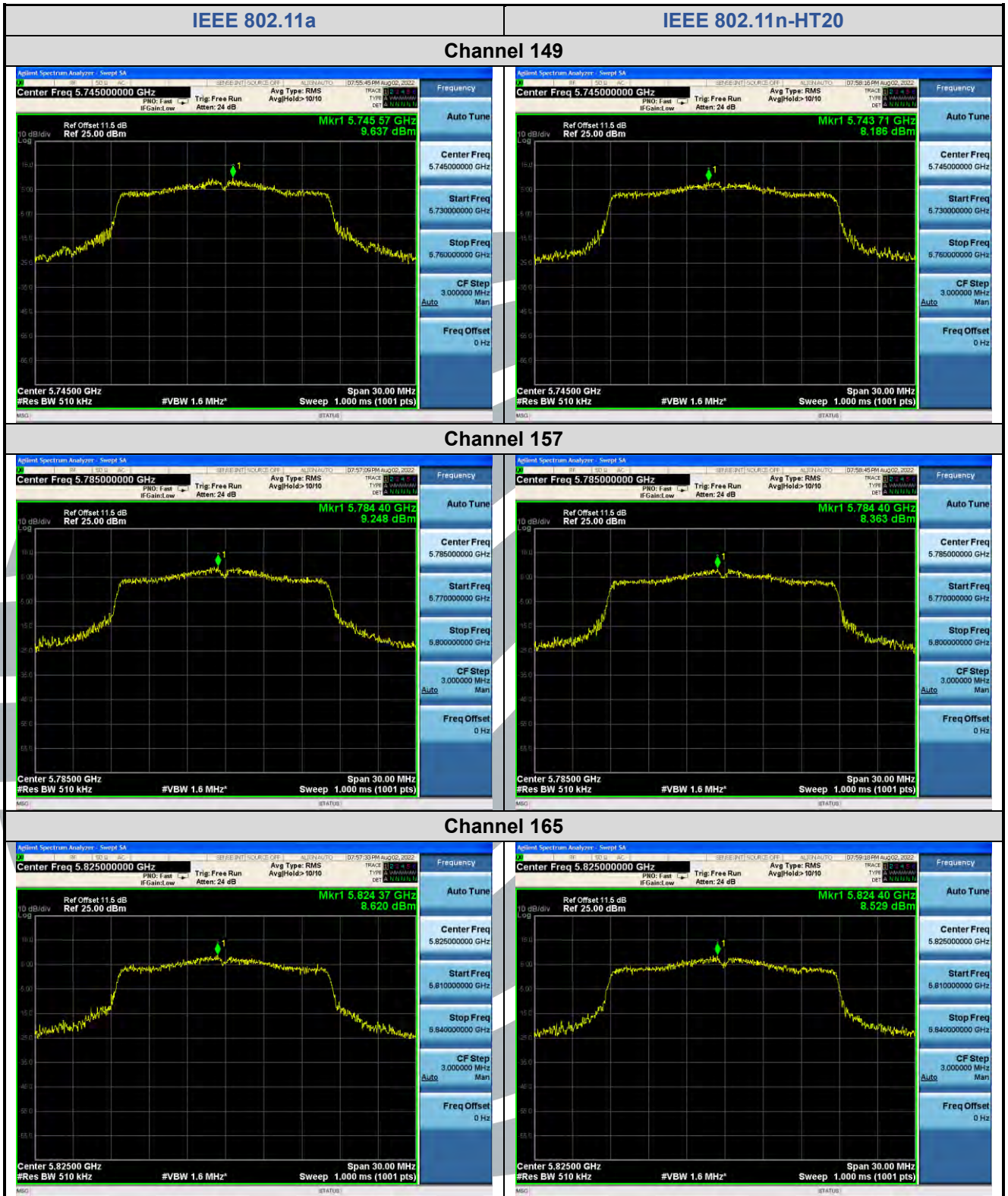

## Shenzhen UnionTrust Quality and Technology Co., Ltd.

Address: Unit D/E of 9/F and 16/F, Block A, Building 6, Baoneng science and technology park, Longhua district, Shenzhen, China

Tel: +86-755-28230888

Fax: +86-755-28230886

E-mail: info@uttlab.com

<http://www.uttlab.com>

UTTR-RF-RSS247-V1.1



**Shenzhen UnionTrust Quality and Technology Co., Ltd.**

Address: Unit D/E of 9/F and 16/F, Block A, Building 6, Baoneng science and technology park, Longhua district, Shenzhen, China

Tel: +86-755-28230888

Fax: +86-755-28230886

E-mail: info@uttlab.com

<http://www.uttlab.com>

UTTR-RF-RSS247-V1.1

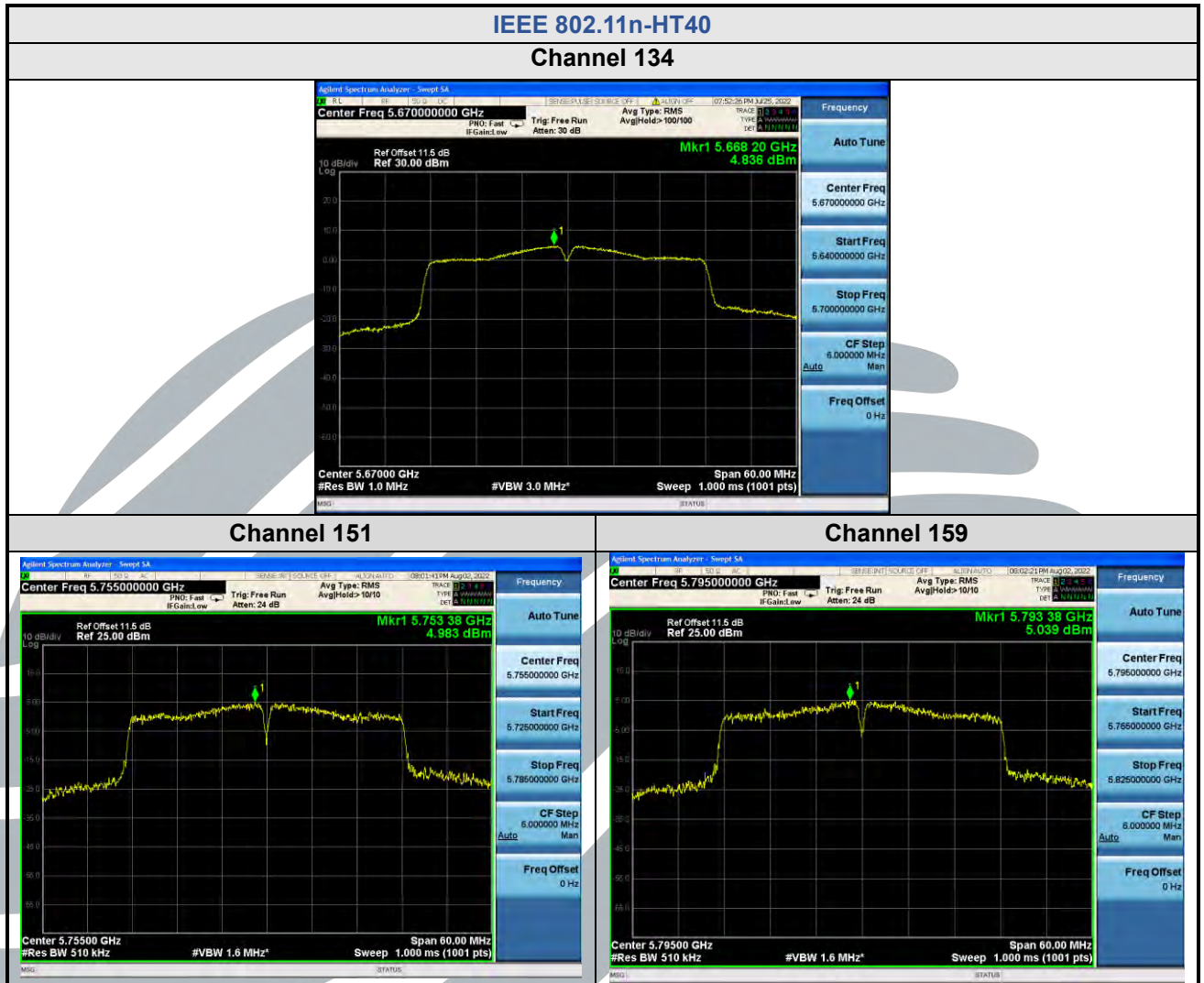

**Shenzhen UnionTrust Quality and Technology Co., Ltd.**

Address: Unit D/E of 9/F and 16/F, Block A, Building 6, Baoneng science and technology park, Longhua district, Shenzhen, China

Tel: +86-755-28230888

Fax: +86-755-28230886

E-mail: info@uttlab.com

<http://www.uttlab.com>

UTTR-RF-RSS247-V1.1

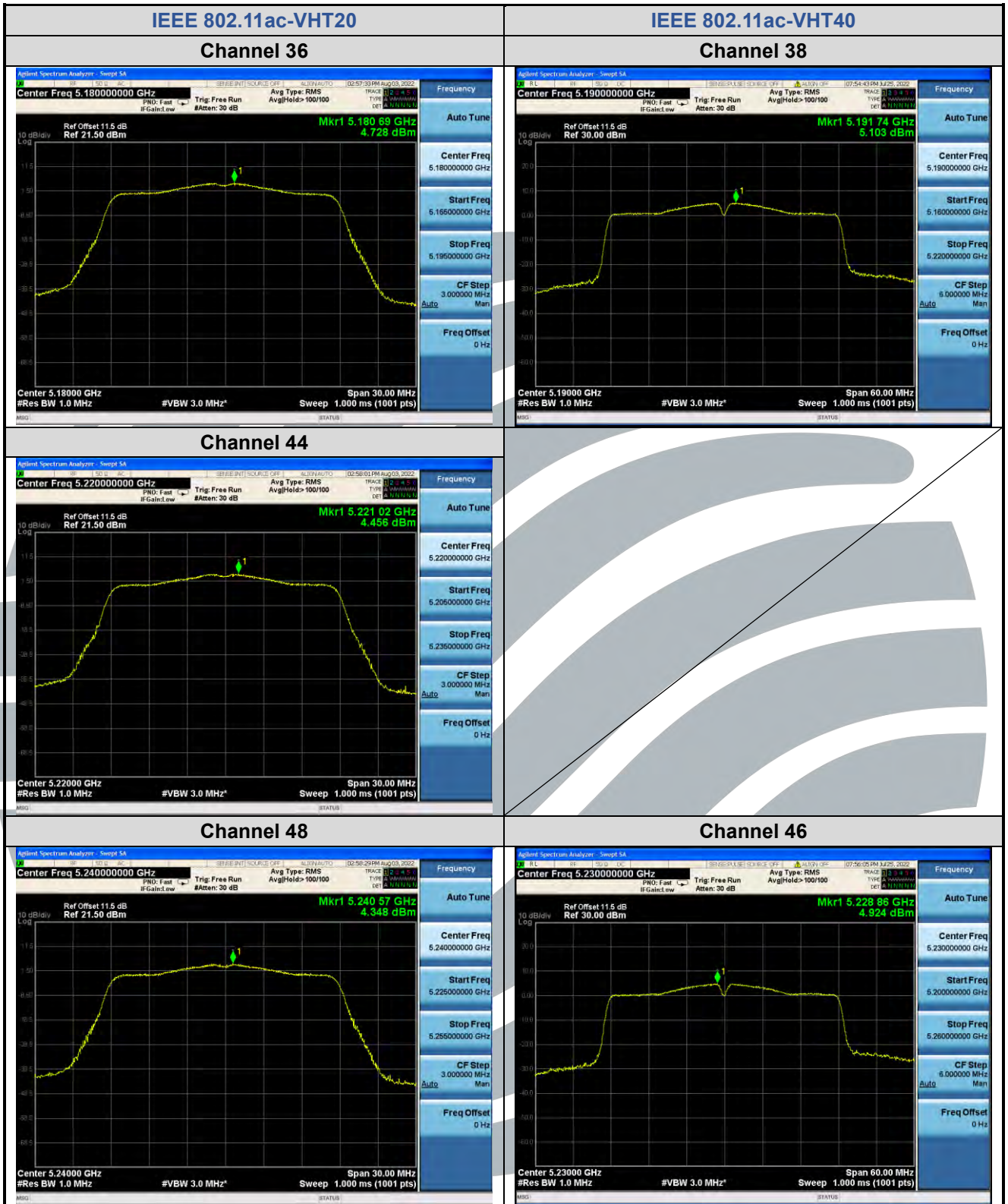

**Shenzhen UnionTrust Quality and Technology Co., Ltd.**

Address: Unit D/E of 9/F and 16/F, Block A, Building 6, Baoneng science and technology park, Longhua district, Shenzhen, China

Tel: +86-755-28230888

Fax: +86-755-28230886

E-mail: info@uttlab.com

<http://www.uttlab.com>

UTTR-RF-RSS247-V1.1

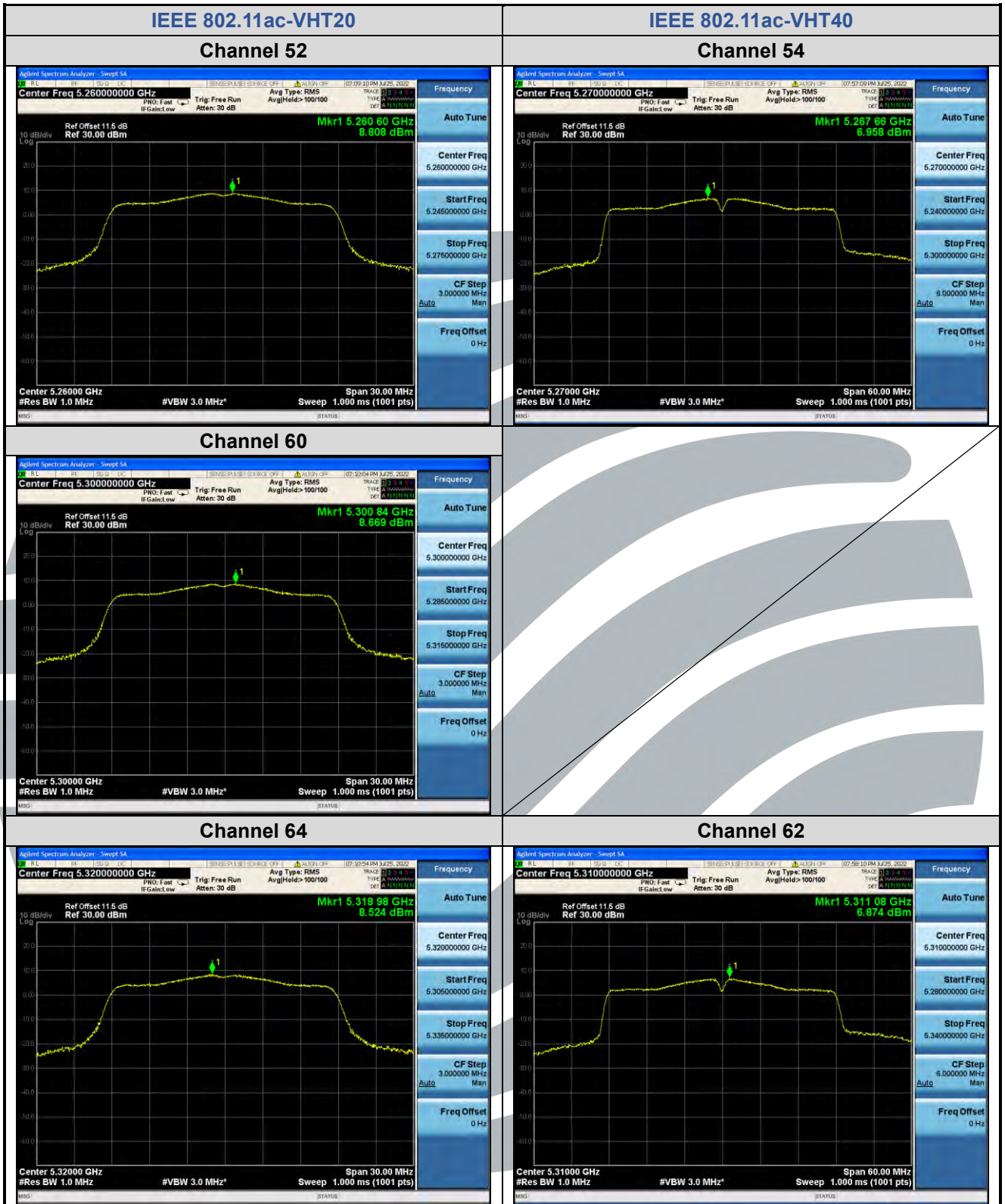

**Shenzhen UnionTrust Quality and Technology Co., Ltd.**

Address: Unit D/E of 9/F and 16/F, Block A, Building 6, Baoneng science and technology park, Longhua district, Shenzhen, China

Tel: +86-755-28230888

Fax: +86-755-28230886

E-mail: info@uttlab.com

<http://www.uttlab.com>

UTTR-RF-RSS247-V.1.1

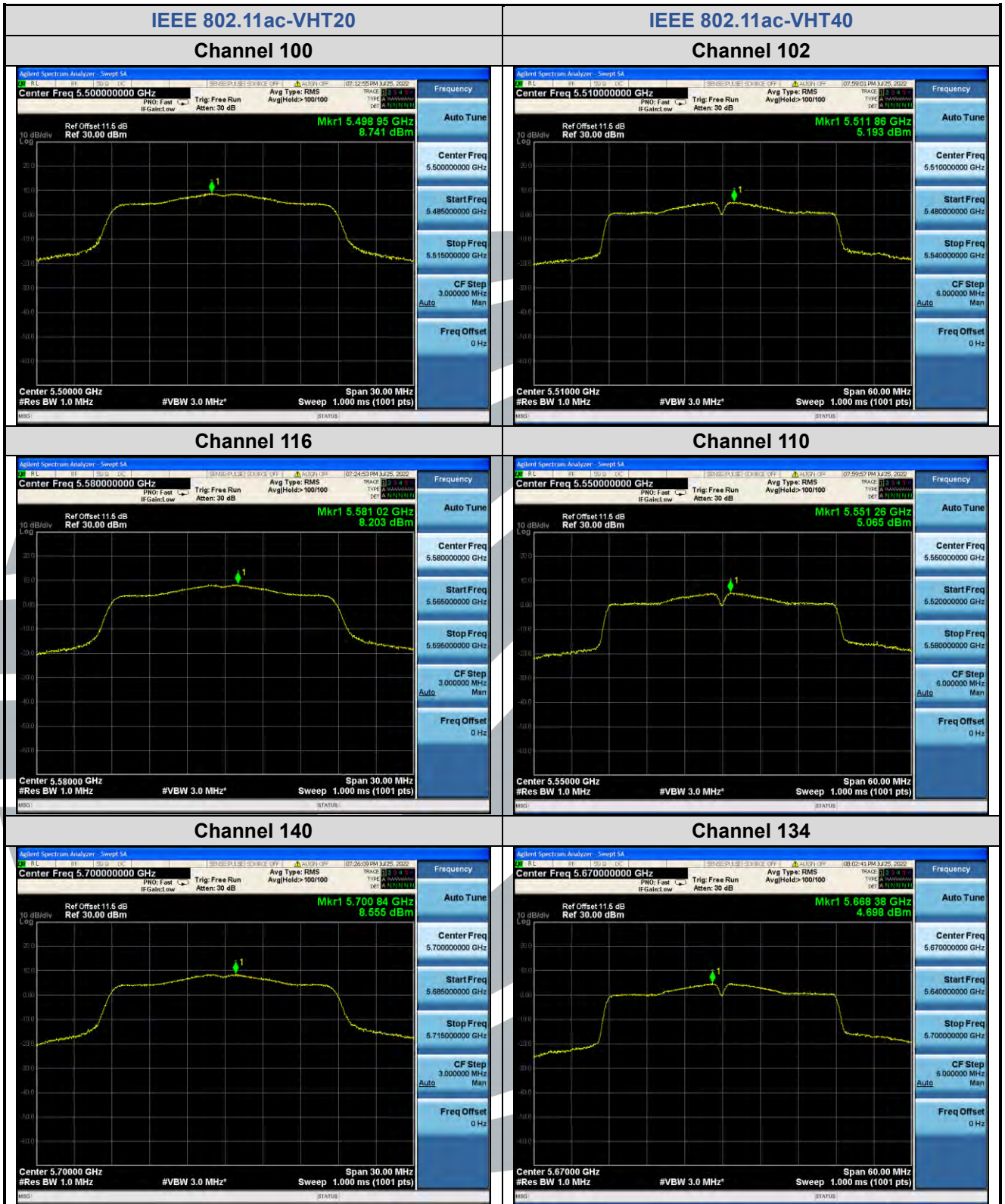

**Shenzhen UnionTrust Quality and Technology Co., Ltd.**

Address: Unit D/E of 9/F and 16/F, Block A, Building 6, Baoneng science and technology park, Longhua district, Shenzhen, China

Tel: +86-755-28230888

Fax: +86-755-28230886

E-mail: info@uttlab.com

<http://www.uttlab.com>

UTTR-RF-RSS247-V1.1

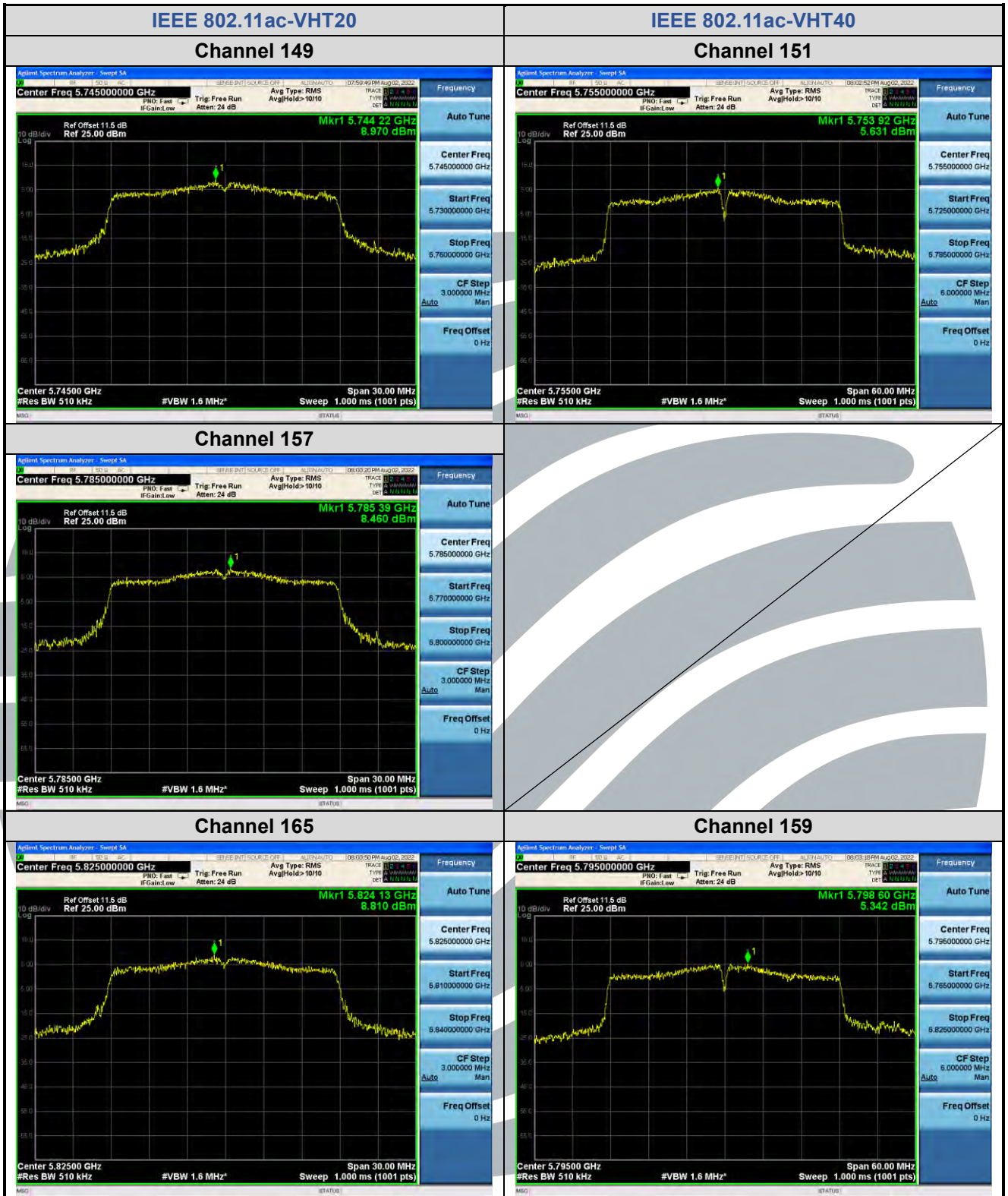

**Shenzhen UnionTrust Quality and Technology Co., Ltd.**

Address: Unit D/E of 9/F and 16/F, Block A, Building 6, Baoneng science and technology park, Longhua district, Shenzhen, China

Tel: +86-755-28230888

Fax: +86-755-28230886

E-mail: info@uttlab.com

<http://www.uttlab.com>

UTTR-RF-RSS247-V1.1





**Shenzhen UnionTrust Quality and Technology Co., Ltd.**

Address: Unit D/E of 9/F and 16/F, Block A, Building 6, Baoneng science and technology park, Longhua district, Shenzhen, China

Tel: +86-755-28230888

Fax: +86-755-28230886

E-mail: info@uttlab.com

<http://www.uttlab.com>

UTTR-RF-RSS247-V1.1

### 5.7 RADIATED EMISSIONS AND BAND EDGE MEASUREMENT

**Test Requirement:** FCC 47 CFR Part 15 Subpart E Section 15.407 (b)(1)(2)(3)(4)(6)  
 FCC 47 CFR Part 15 Subpart C Section 15.209/205  
 RSS-247 Issue 2 Section 6.2.1.2/6.2.2.2/6.2.3.2/6.2.4.2

**Test Method:** KDB 789033 D02 v02r01 Section G.3, G.4, G.5, and G.6

**Receiver Setup:**

Frequency	RBW
0.009 MHz-0.150 MHz	200/300 kHz
0.150 MHz -30 MHz	9/10 kHz
30 MHz-1 GHz	100/120 kHz
Above 1 GHz	1 MHz

**Limits:**

**1. Limits of Radiated Emission and Band edge Measurement**

Radiated emissions that fall in the restricted bands must comply with the general emissions limits in 15.209(a) as below table. Other emissions shall be at least 20 dB below the highest level of the desired power.

Frequency	Field strength (microvolt/meter)	Limit (dBμV/m )	Remark	Measurement distance (m)
0.009 MHz-0.490 MHz	2400/F(kHz)	--	--	300
0.490 MHz-1.705 MHz	24000/F(kHz)	--	--	30
1.705 MHz-30 MHz	30	--	--	30
30 MHz-88 MHz	100	40.0	Quasi-peak	3
88 MHz-216 MHz	150	43.5	Quasi-peak	3
216 MHz-960 MHz	200	46.0	Quasi-peak	3
960MHz-1GHz	500	54.0	Quasi-peak	3
Above 1 GHz	500	54.0	Average	3

**Remark:**

- a. The lower limit shall apply at the transition frequencies.
- b. Emission level (dBuV/m) = 20 log Emission level (uV/m).
- c. For frequencies above 1000 MHz, the field strength limits are based on average detector, however, the peak field strength of any emission shall not exceed the maximum permitted average limits, specified above by more than 20 dB under any condition of modulation.

**2. Limits of Unwanted Emission Out of the Restricted Bands**

Applicable To	Limit	
<b>789033 D02 General U-NII Test Procedures New Rules v01r04</b>	<b>Field Strength at 3 m</b>	
	<b>PK: 74 (dBµV/m)</b>	<b>AV: 54 (dBµV/m)</b>
Applicable To	EIRP Limit	Equivalent Field Strength at 3 m
RSS-247 Issue 2 Section 6.2.1.2	PK: -27 (dBm/MHz)	PK: 74 (dBµV/m)
RSS-247 Issue 2 Section 6.2.2.2	PK: -27 (dBm/MHz)	PK: 74 (dBµV/m)
RSS-247 Issue 2 Section 6.2.3.2	PK: -27 (dBm/MHz)	PK: 68.2 (dBµV/m)
RSS-247 Issue 2 Section 6.2.4.2	27 dBm/MHz at frequencies from the band edges decreasing linearly to 15.6 dBm/MHz at 5 MHz above or below the band edges;	PK: 68.2 (dBµV/m)
	15.6 dBm/MHz at 5 MHz above or below the band edges decreasing linearly to 10 dBm/MHz at 25 MHz above or below the band edges;	
	10 dBm/MHz at 25 MHz above or below the band edges decreasing linearly to -27 dBm/MHz at 75 MHz above or below the band edges;	
	-27 dBm/MHz at frequencies more than 75 MHz above or below the band edges.	

**Test Setup:** Refer to section 4.5.1 for details.

**Test Procedures:**

- The EUT was placed on the top of a rotating table 0.8 meters (for below 1 GHz) / 1.5 meters (for above 1 GHz) above the ground at 3 meter chamber room for test. The table was rotated 360 degrees to determine the position of the highest radiation.
- The EUT was set 3 meters away from the interference-receiving antenna, which was mounted on the top of a variable-height antenna tower.
- The height of antenna is varied from one meter to four meters above the ground to determine the maximum value of the field strength. Both horizontal and vertical polarizations of the antenna are set to make the measurement.
- For each suspected emission, the EUT was arranged to its worst case and then the antenna was tuned to heights from 1 meter to 4 meters and the rotatable table was turned from 0 degrees to 360 degrees to find the maximum reading.
- The test-receiver system was set to quasi-peak detect function and specified bandwidth with maximum hold mode when the test frequency is below 1 GHz.
- The test-receiver system was set to peak and average detected function and specified bandwidth with maximum hold mode when the test frequency is above 1 GHz. If the peak reading value also meets average limit, measurement with the average detector is unnecessary.

**Remark:**

- The resolution bandwidth and video bandwidth of test receiver/spectrum analyzer is 120 kHz for Quasi-peak detection (QP) at frequency below 1 GHz.
- The resolution bandwidth of test receiver/spectrum analyzer is 1 MHz and the video bandwidth is 3 MHz for Peak detection (PK) at frequency above 1 GHz.
- The resolution bandwidth of test receiver/spectrum analyzer is 1 MHz and the video bandwidth is 3 MHz for RMS Average (Duty cycle < 98 %) for Average detection (AV) at frequency above 1 GHz, then the measurement results was added to a correction factor (10 log(1/duty cycle)).
- The resolution bandwidth of test receiver/spectrum analyzer is 1 MHz and the video bandwidth is 10 Hz (Duty cycle ≥ 98 %) or ≥ 1/T(duty cycle is < 98%) for Average detection (AV) at frequency above 1 GHz.
- All modes of operation were investigated and the worst-case emissions are reported.

**Equipment Used:** Refer to section 3 for details.

**Test Result:** Pass

**The measurement data as follows:**

**Radiated Emission Test Data (9 KHz ~ 30 MHz):**  
 The amplitude of spurious emissions attenuated more than 20 dB below the permissible value is not required to be report.

**Radiated Emission Test Data (30 MHz ~ 1 GHz Worst Case):**  
**Worst-Case Configuration**

**Horizontal**

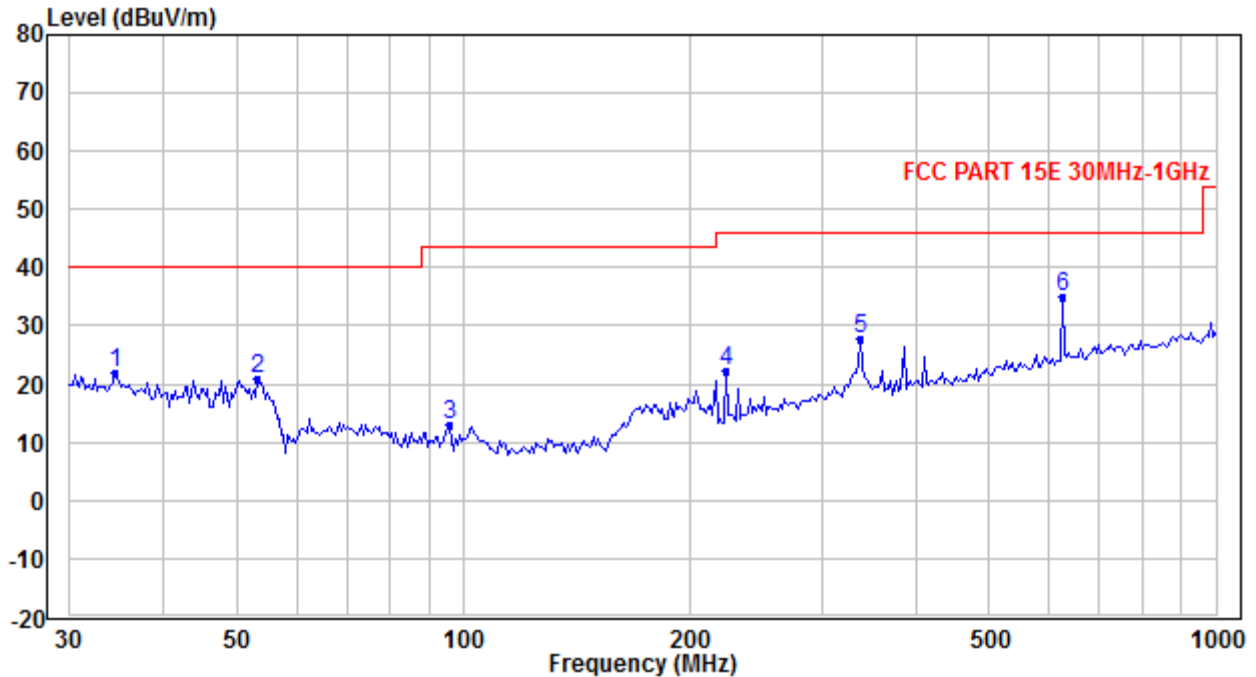

No.	Frequency (MHz)	Reading (dB $\mu$ V/m)	Correction factor (dB/m)	Result (dB $\mu$ V/m)	Limit (dB $\mu$ V/m)	Margin (dB)	Detector
1	34.527	26.75	-4.81	21.94	40.00	-18.06	QP
2	53.379	37.69	-16.67	21.02	40.00	-18.98	QP
3	95.649	28.80	-15.95	12.85	43.50	-30.65	QP
4	223.848	33.31	-11.08	22.23	46.00	-23.77	QP
5	336.482	33.59	-5.82	27.77	46.00	-18.23	QP
6	624.490	35.11	-0.29	34.82	46.00	-11.18	QP

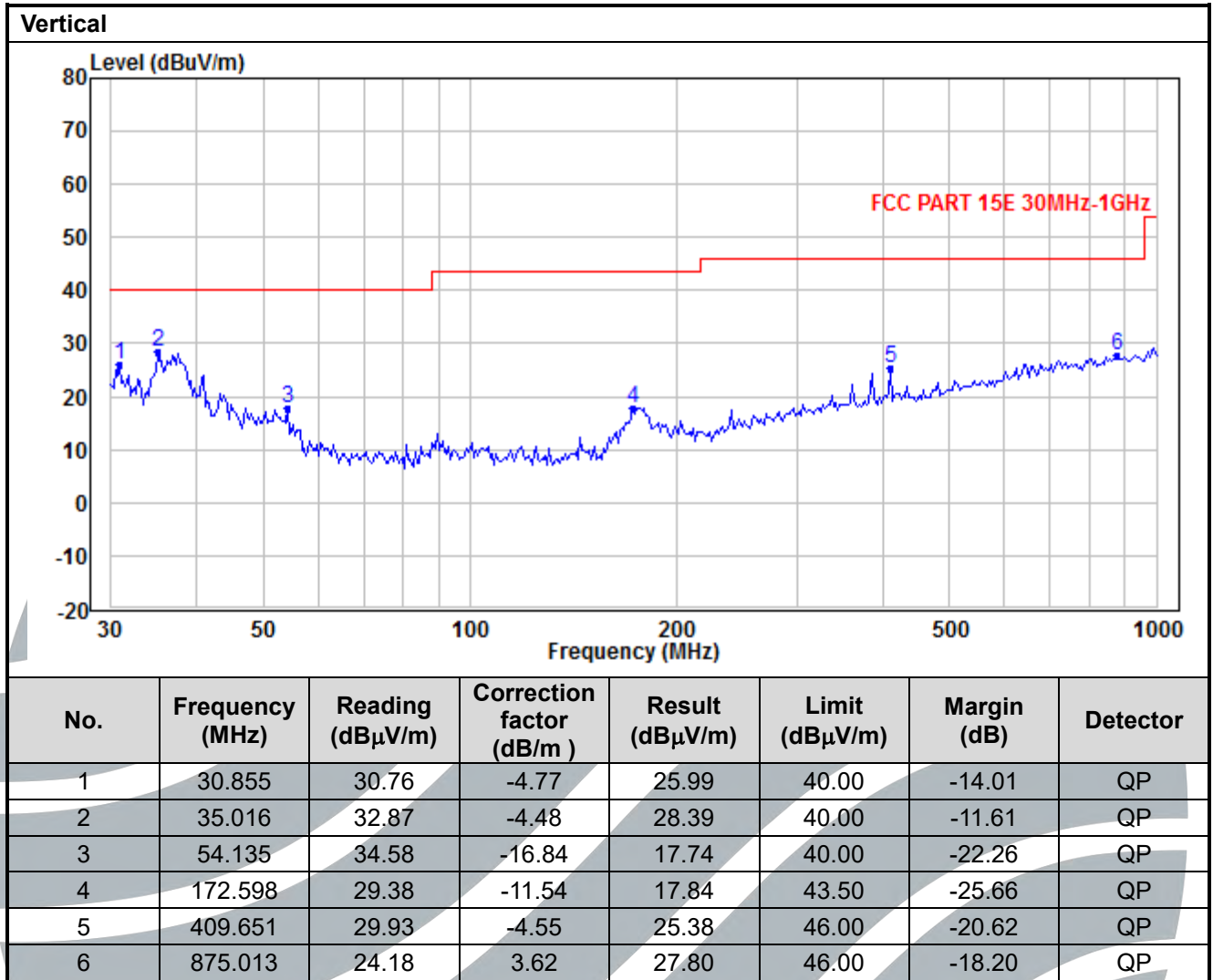

**Shenzhen UnionTrust Quality and Technology Co., Ltd.**

Address: Unit D/E of 9/F and 16/F, Block A, Building 6, Baoneng science and technology park, Longhua district, Shenzhen, China

Tel: +86-755-28230888

Fax: +86-755-28230886

E-mail: info@uttlab.com

<http://www.uttlab.com>

UTTR-RF-RSS247-V1.1

Radiated Emission Test Data (Above 1GHz):								
IEEE 802.11a_Channel 36								
No.	Frequency (MHz)	Reading (dBµV)	Correction factor (dB/m)	Result (dBµV/m)	Limit (dBµV/m)	Margin (dB)	Detector	Antenna Polaxis
1	10360	40.1	6.2	46.4	74	-27.6	Peak	Horizontal
2	10360	27.8	6.2	34.0	54	-20.0	Average	Horizontal
3	15540	37.1	11.4	48.5	74	-25.5	Peak	Horizontal
4	15540	24.5	11.4	35.9	54	-18.2	Average	Horizontal
5	10360	40.6	6.2	46.8	74	-27.2	Peak	Vertical
6	10360	27.7	6.2	33.9	54	-20.1	Average	Vertical
7	15540	37.0	11.4	48.4	74	-25.6	Peak	Vertical
8	15540	24.4	11.4	35.8	54	-18.2	Average	Vertical
IEEE 802.11a_Channel 44								
1	10440	40.1	6.3	46.4	74	-27.6	Peak	Horizontal
2	10440	27.7	6.3	34.0	54	-20.0	Average	Horizontal
3	15660	37.1	11.5	48.7	74	-25.4	Peak	Horizontal
4	15660	24.1	11.5	35.6	54	-18.4	Average	Horizontal
5	10440	40.2	6.3	46.5	74	-27.5	Peak	Vertical
6	10440	27.5	6.3	33.8	54	-20.2	Average	Vertical
7	15660	36.8	11.5	48.3	74	-25.7	Peak	Vertical
8	15660	24.0	11.5	35.5	54	-18.5	Average	Vertical
IEEE 802.11a_Channel 48								
1	10480	39.5	6.3	45.8	74	-28.2	Peak	Horizontal
2	10480	26.5	6.3	32.9	54	-21.2	Average	Horizontal
3	15720	36.0	11.6	47.6	74	-26.4	Peak	Horizontal
4	15720	23.5	11.6	35.1	54	-18.9	Average	Horizontal
5	10480	40.3	6.3	46.6	74	-27.4	Peak	Vertical
6	10480	26.5	6.3	32.8	54	-21.2	Average	Vertical
7	15720	36.3	11.6	47.9	74	-26.1	Peak	Vertical
8	15720	23.6	11.6	35.2	54	-18.8	Average	Vertical

**Shenzhen UnionTrust Quality and Technology Co., Ltd.**

Address: Unit D/E of 9/F and 16/F, Block A, Building 6, Baoneng science and technology park, Longhua district, Shenzhen, China

Tel: +86-755-28230888

Fax: +86-755-28230886

E-mail: info@uttlab.com

<http://www.uttlab.com>

UTTR-RF-RSS247-V1.1

IEEE 802.11a_Channel 52								
No.	Frequency (MHz)	Reading (dBµV)	Correction factor (dB/m)	Result (dBµV/m)	Limit (dBµV/m)	Margin (dB)	Detector	Antenna Polaxis
1	10520	39.6	6.3	46.0	74	-28.0	Peak	Horizontal
2	10520	26.5	6.3	32.8	54	-21.2	Average	Horizontal
3	15780	35.2	11.7	46.9	74	-27.1	Peak	Horizontal
4	15780	23.5	11.7	35.2	54	-18.8	Average	Horizontal
5	10520	38.8	6.3	45.2	74	-28.8	Peak	Vertical
6	10520	26.5	6.3	32.8	54	-21.2	Average	Vertical
7	15780	35.8	11.7	47.6	74	-26.5	Peak	Vertical
8	15780	23.5	11.7	35.2	54	-18.8	Average	Vertical
IEEE 802.11a_Channel 60								
1	10600	37.4	11.3	48.7	74	-25.3	Peak	Horizontal
2	10600	19.5	11.3	30.8	54	-23.2	Average	Horizontal
3	15900	36.9	11.9	48.8	74	-25.2	Peak	Horizontal
4	15900	24.9	11.9	36.8	54	-17.2	Average	Horizontal
5	10600	37.4	6.3	43.7	74	-30.3	Peak	Vertical
6	10600	24.3	6.3	30.6	54	-23.4	Average	Vertical
7	15900	36.9	11.9	48.8	74	-25.2	Peak	Vertical
8	15900	24.9	11.9	36.8	54	-17.2	Average	Vertical
IEEE 802.11a_Channel 64								
1	10640	38.1	6.3	44.4	74	-29.6	Peak	Horizontal
2	10640	24.4	6.3	30.6	54	-23.4	Average	Horizontal
3	15960	37.7	12.0	49.6	74	-24.4	Peak	Horizontal
4	15960	24.8	12.0	36.7	54	-17.3	Average	Horizontal
5	10640	38.2	6.3	44.5	74	-29.5	Peak	Vertical
6	10640	24.4	6.3	30.6	54	-23.4	Average	Vertical
7	15960	37.9	12.0	49.9	74	-24.1	Peak	Vertical
8	15960	24.9	12.0	36.9	54	-17.1	Average	Vertical

IEEE 802.11a_Channel 100								
No.	Frequency (MHz)	Reading (dBµV)	Correction factor (dB/m)	Result (dBµV/m)	Limit (dBµV/m)	Margin (dB)	Detector	Antenna Polaxis
1	11000	38.9	6.1	45.0	74	-29.0	Peak	Horizontal
2	11000	26.7	6.1	32.8	54	-21.2	Average	Horizontal
3	16500	37.6	13.0	50.6	74	-23.4	Peak	Horizontal
4	16500	24.7	13.0	37.7	54	-16.4	Average	Horizontal
5	11000	38.9	6.1	45.1	74	-28.9	Peak	Vertical
6	11000	26.8	6.1	32.9	54	-21.1	Average	Vertical
7	16500	37.3	13.0	50.2	74	-23.8	Peak	Vertical
8	16500	24.7	13.0	37.7	54	-16.4	Average	Vertical
IEEE 802.11a_Channel 116								
1	11160	37.3	6.4	43.7	74	-30.3	Peak	Horizontal
2	11160	24.0	6.4	30.4	54	-23.6	Average	Horizontal
3	16740	37.0	13.0	50.0	74	-24.0	Peak	Horizontal
4	16740	24.2	13.0	37.2	54	-16.8	Average	Horizontal
5	11160	37.8	6.4	44.1	74	-29.9	Peak	Vertical
6	11160	24.2	6.4	30.6	54	-23.4	Average	Vertical
7	16740	38.6	13.0	51.6	74	-22.4	Peak	Vertical
8	16740	24.3	13.0	37.4	54	-16.7	Average	Vertical
IEEE 802.11a_Channel 140								
1	11400	38.6	6.7	45.3	74	-28.7	Peak	Horizontal
2	11400	25.4	6.7	32.1	54	-21.9	Average	Horizontal
3	17100	35.2	13.3	48.5	74	-25.5	Peak	Horizontal
4	17100	22.4	13.3	35.7	54	-18.3	Average	Horizontal
5	11400	38.5	6.7	45.3	74	-28.7	Peak	Vertical
6	11400	25.4	6.7	32.1	54	-21.9	Average	Vertical
7	17100	35.0	13.3	48.3	74	-25.7	Peak	Vertical
8	17100	22.5	13.3	35.8	54	-18.2	Average	Vertical



IEEE 802.11a_Channel 149								
No.	Frequency (MHz)	Reading (dBµV)	Correction factor (dB/m)	Result (dBµV/m)	Limit (dBµV/m)	Margin (dB)	Detector	Antenna Polaxis
1	11490	38.7	6.9	45.6	74	-28.5	Peak	Horizontal
2	11490	24.8	6.9	31.6	54	-22.4	Average	Horizontal
3	17235	36.9	13.7	50.6	74	-23.4	Peak	Horizontal
4	17235	24.1	13.7	37.8	54	-16.2	Average	Horizontal
5	11490	38.4	6.9	45.3	74	-28.7	Peak	Vertical
6	11490	24.3	6.9	31.2	54	-22.8	Average	Vertical
7	17235	38.0	13.7	51.7	74	-22.3	Peak	Vertical
8	17235	24.0	13.7	37.7	54	-16.3	Average	Vertical
IEEE 802.11a_Channel 157								
1	11570	37.5	7.1	44.5	74	-29.5	Peak	Horizontal
2	11570	25.1	7.1	32.1	54	-21.9	Average	Horizontal
3	17355	36.5	14.0	50.5	74	-23.5	Peak	Horizontal
4	17355	24.3	14.0	38.3	54	-15.7	Average	Horizontal
5	11570	37.3	7.1	44.3	74	-29.7	Peak	Vertical
6	11570	25.1	7.1	32.1	54	-21.9	Average	Vertical
7	17355	37.0	14.0	51.0	74	-23.0	Peak	Vertical
8	17355	24.3	14.0	38.3	54	-15.7	Average	Vertical
IEEE 802.11a_Channel 165								
1	11650	39.6	7.3	46.9	74	-27.1	Peak	Horizontal
2	11650	26.3	7.3	33.5	54	-20.5	Average	Horizontal
3	17475	35.8	14.3	50.1	74	-23.9	Peak	Horizontal
4	17475	23.2	14.3	37.5	54	-16.5	Average	Horizontal
5	11650	39.1	7.3	46.4	74	-27.6	Peak	Vertical
6	11650	26.2	7.3	33.5	54	-20.6	Average	Vertical
7	17475	35.4	14.3	49.7	74	-24.3	Peak	Vertical
8	17475	23.1	14.3	37.4	54	-16.6	Average	Vertical

IEEE 802.11n-HT20_Channel 36								
No.	Frequency (MHz)	Reading (dBµV)	Correction factor (dB/m)	Result (dBµV/m)	Limit (dBµV/m)	Margin (dB)	Detector	Antenna Polaxis
1	10360	40.1	6.2	46.3	74	-27.7	Peak	Horizontal
2	10360	28.0	6.2	34.3	54	-19.7	Average	Horizontal
3	15540	36.8	11.4	48.1	74	-25.9	Peak	Horizontal
4	15540	24.7	11.4	36.1	54	-17.9	Average	Horizontal
5	10360	39.8	6.2	46.0	74	-28.0	Peak	Vertical
6	10360	27.9	6.2	34.2	54	-19.8	Average	Vertical
7	15540	36.2	11.4	47.6	74	-26.4	Peak	Vertical
8	15540	24.5	11.4	35.9	54	-18.2	Average	Vertical
IEEE 802.11n-HT20_Channel 44								
1	10440	40.2	6.3	46.5	74	-27.5	Peak	Horizontal
2	10440	27.7	6.3	34.0	54	-20.0	Average	Horizontal
3	15660	35.9	11.5	47.4	74	-26.6	Peak	Horizontal
4	15660	24.3	11.5	35.8	54	-18.2	Average	Horizontal
5	10440	39.6	6.3	45.9	74	-28.1	Peak	Vertical
6	10440	27.8	6.3	34.1	54	-19.9	Average	Vertical
7	15660	37.7	11.5	49.2	74	-24.8	Peak	Vertical
8	15660	24.1	11.5	35.6	54	-18.4	Average	Vertical
IEEE 802.11n-HT20_Channel 48								
1	10480	39.0	6.3	45.3	74	-28.7	Peak	Horizontal
2	10480	26.7	6.3	33.0	54	-21.0	Average	Horizontal
3	15720	36.3	11.6	47.9	74	-26.1	Peak	Horizontal
4	15720	23.7	11.6	35.3	54	-18.7	Average	Horizontal
5	10480	41.5	6.3	47.8	74	-26.2	Peak	Vertical
6	10480	26.6	6.3	32.9	54	-21.1	Average	Vertical
7	15720	36.5	11.6	48.2	74	-25.8	Peak	Vertical
8	15720	23.7	11.6	35.3	54	-18.7	Average	Vertical

IEEE 802.11n-HT20_Channel 52								
No.	Frequency (MHz)	Reading (dBμV)	Correction factor (dB/m)	Result (dBμV/m)	Limit (dBμV/m)	Margin (dB)	Detector	Antenna Polaxis
1	10520	39.1	6.3	45.4	74	-28.6	Peak	Horizontal
2	10520	26.7	6.3	33.0	54	-21.0	Average	Horizontal
3	15780	36.4	11.7	48.2	74	-25.9	Peak	Horizontal
4	15780	23.7	11.7	35.4	54	-18.6	Average	Horizontal
5	10520	39.0	6.3	45.4	74	-28.7	Peak	Vertical
6	10520	26.6	6.3	32.9	54	-21.1	Average	Vertical
7	15780	35.4	11.7	47.1	74	-26.9	Peak	Vertical
8	15780	23.6	11.7	35.3	54	-18.7	Average	Vertical
IEEE 802.11n-HT20_Channel 60								
1	10600	37.6	6.3	43.9	74	-30.1	Peak	Horizontal
2	10600	24.6	6.3	30.9	54	-23.1	Average	Horizontal
3	15900	38.1	11.9	50.0	74	-24.1	Peak	Horizontal
4	15900	25.2	11.9	37.1	54	-16.9	Average	Horizontal
5	10600	37.5	6.3	43.8	74	-30.3	Peak	Vertical
6	10600	24.6	6.3	30.9	54	-23.1	Average	Vertical
7	15900	37.9	11.9	49.8	74	-24.2	Peak	Vertical
8	15900	25.1	11.9	37.0	54	-17.0	Average	Vertical
IEEE 802.11n-HT20_Channel 64								
1	10640	38.3	6.3	44.5	74	-29.5	Peak	Horizontal
2	10640	24.6	6.3	30.9	54	-23.1	Average	Horizontal
3	15960	37.6	12.0	49.5	74	-24.5	Peak	Horizontal
4	15960	25.1	12.0	37.0	54	-17.0	Average	Horizontal
5	10640	37.5	6.3	43.8	74	-30.2	Peak	Vertical
6	10640	24.6	6.3	30.9	54	-23.1	Average	Vertical
7	15960	37.4	12.0	49.3	74	-24.7	Peak	Vertical
8	15960	24.9	12.0	36.9	54	-17.1	Average	Vertical

IEEE 802.11n-HT20_Channel 100								
No.	Frequency (MHz)	Reading (dBµV)	Correction factor (dB/m)	Result (dBµV/m)	Limit (dBµV/m)	Margin (dB)	Detector	Antenna Polaxis
1	11000	38.7	6.1	44.8	74	-29.2	Peak	Horizontal
2	11000	27.0	6.1	33.1	54	-20.9	Average	Horizontal
3	16500	37.6	13.0	50.6	74	-23.5	Peak	Horizontal
4	16500	24.9	13.0	37.8	54	-16.2	Average	Horizontal
5	11000	39.0	6.1	45.2	74	-28.8	Peak	Vertical
6	11000	26.9	6.1	33.0	54	-21.0	Average	Vertical
7	16500	37.0	13.0	50.0	74	-24.0	Peak	Vertical
8	16500	24.7	13.0	37.7	54	-16.4	Average	Vertical
IEEE 802.11n-HT20_Channel 116								
1	11160	37.1	6.4	43.5	74	-30.5	Peak	Horizontal
2	11160	24.6	6.4	30.9	54	-23.1	Average	Horizontal
3	16740	38.0	13.0	51.0	74	-23.0	Peak	Horizontal
4	16740	24.6	13.0	37.6	54	-16.4	Average	Horizontal
5	11160	37.4	6.4	43.8	74	-30.2	Peak	Vertical
6	11160	24.4	6.4	30.8	54	-23.3	Average	Vertical
7	16740	37.4	13.0	50.4	74	-23.6	Peak	Vertical
8	16740	24.6	13.0	37.6	54	-16.4	Average	Vertical
IEEE 802.11n-HT20_Channel 140								
1	11400	38.4	6.7	45.1	74	-28.9	Peak	Horizontal
2	11400	25.6	6.7	32.4	54	-21.6	Average	Horizontal
3	17100	34.9	13.3	48.3	74	-25.7	Peak	Horizontal
4	17100	22.8	13.3	36.1	54	-17.9	Average	Horizontal
5	11400	38.0	6.7	44.7	74	-29.3	Peak	Vertical
6	11400	25.6	6.7	32.3	54	-21.7	Average	Vertical
7	17100	35.3	13.3	48.6	74	-25.4	Peak	Vertical
8	17100	22.7	13.3	36.0	54	-18.0	Average	Vertical

IEEE 802.11n-HT20_Channel 149								
No.	Frequency (MHz)	Reading (dBµV)	Correction factor (dB/m)	Result (dBµV/m)	Limit (dBµV/m)	Margin (dB)	Detector	Antenna Polaxis
1	11490	37.5	6.9	44.4	74	-29.6	Peak	Horizontal
2	11490	24.7	6.9	31.6	54	-22.5	Average	Horizontal
3	17235	36.7	13.7	50.4	74	-23.7	Peak	Horizontal
4	17235	24.3	13.7	38.0	54	-16.0	Average	Horizontal
5	11490	38.1	6.9	45.0	74	-29.1	Peak	Vertical
6	11490	24.6	6.9	31.5	54	-22.5	Average	Vertical
7	17235	36.5	13.7	50.2	74	-23.8	Peak	Vertical
8	17235	24.2	13.7	37.9	54	-16.1	Average	Vertical
IEEE 802.11n-HT20_Channel 157								
1	11570	37.4	7.1	44.5	74	-29.5	Peak	Horizontal
2	11570	25.2	7.1	32.2	54	-21.8	Average	Horizontal
3	17355	37.0	14.0	51.0	74	-23.0	Peak	Horizontal
4	17355	24.4	14.0	38.4	54	-15.6	Average	Horizontal
5	11570	37.3	7.1	44.4	74	-29.6	Peak	Vertical
6	11570	25.0	7.1	32.1	54	-22.0	Average	Vertical
7	17355	37.2	14.0	51.2	74	-22.8	Peak	Vertical
8	17355	24.3	14.0	38.3	54	-15.7	Average	Vertical
IEEE 802.11n-HT20_Channel 165								
1	11650	39.1	7.3	46.3	74	-27.7	Peak	Horizontal
2	11650	26.2	7.3	33.5	54	-20.6	Average	Horizontal
3	17475	35.3	14.3	49.6	74	-24.4	Peak	Horizontal
4	17475	23.3	14.3	37.6	54	-16.4	Average	Horizontal
5	11650	38.2	7.3	45.5	74	-28.5	Peak	Vertical
6	11650	26.1	7.3	33.4	54	-20.6	Average	Vertical
7	17475	35.3	14.3	49.7	74	-24.3	Peak	Vertical
8	17475	23.1	14.3	37.4	54	-16.6	Average	Vertical

IEEE 802.11n-HT40_Channel 38								
No.	Frequency (MHz)	Reading (dBμV)	Correction factor (dB/m)	Result (dBμV/m)	Limit (dBμV/m)	Margin (dB)	Detector	Antenna Polaxis
1	10380	40.9	6.3	47.1	74	-26.9	Peak	Horizontal
2	10380	28.1	6.3	34.3	54	-19.7	Average	Horizontal
3	15570	37.6	11.4	49.0	74	-25.0	Peak	Horizontal
4	15570	24.7	11.4	36.1	54	-17.9	Average	Horizontal
5	10380	40.9	6.3	47.1	74	-26.9	Peak	Vertical
6	10380	28.0	6.3	34.3	54	-19.7	Average	Vertical
7	15570	37.7	11.4	49.1	74	-24.9	Peak	Vertical
8	15570	24.5	11.4	35.9	54	-18.1	Average	Vertical
IEEE 802.11n-HT40_Channel 46								
1	10460	40.3	6.3	46.6	74	-27.4	Peak	Horizontal
2	10460	27.8	6.3	34.1	54	-19.9	Average	Horizontal
3	15690	37.0	11.6	48.6	74	-25.4	Peak	Horizontal
4	15690	24.2	11.6	35.8	54	-18.2	Average	Horizontal
5	10460	40.4	6.3	46.7	74	-27.3	Peak	Vertical
6	10460	27.7	6.3	34.0	54	-20.0	Average	Vertical
7	15690	37.4	11.6	49.0	74	-25.0	Peak	Vertical
8	15690	24.2	11.6	35.8	54	-18.2	Average	Vertical
IEEE 802.11n-HT40_Channel 54								
1	10540	39.0	6.3	45.3	74	-28.7	Peak	Horizontal
2	10540	26.7	6.3	33.0	54	-21.0	Average	Horizontal
3	15810	37.2	1.8	39.0	74	-35.0	Peak	Horizontal
4	15810	34.2	1.8	36.0	54	-18.0	Average	Horizontal
5	10540	39.1	6.3	45.4	74	-28.6	Peak	Vertical
6	10540	26.5	6.3	32.8	54	-21.2	Average	Vertical
7	15810	36.8	11.8	48.5	74	-25.5	Peak	Vertical
8	15810	24.1	11.8	35.9	54	-18.1	Average	Vertical

IEEE 802.11n-HT40_Channel 62								
No.	Frequency (MHz)	Reading (dBµV)	Correction factor (dB/m)	Result (dBµV/m)	Limit (dBµV/m)	Margin (dB)	Detector	Antenna Polaxis
1	10620	37.4	6.3	43.7	74	-30.3	Peak	Horizontal
2	10620	24.7	6.3	31.0	54	-23.0	Average	Horizontal
3	15930	37.3	11.9	49.3	74	-24.7	Peak	Horizontal
4	15930	25.1	11.9	37.0	54	-17.0	Average	Horizontal
5	10620	37.6	6.3	43.9	74	-30.1	Peak	Vertical
6	10620	24.7	6.3	31.0	54	-23.0	Average	Vertical
7	15930	37.2	11.9	49.1	74	-24.9	Peak	Vertical
8	15930	25.0	11.9	37.0	54	-17.0	Average	Vertical
IEEE 802.11n-HT40_Channel 102								
1	11020	40.3	6.2	46.4	74	-27.6	Peak	Horizontal
2	11020	27.0	6.2	33.1	54	-20.9	Average	Horizontal
3	16530	37.5	13.0	50.4	74	-23.6	Peak	Horizontal
4	16530	24.8	13.0	37.8	54	-16.2	Average	Horizontal
5	11020	39.6	6.2	45.7	74	-28.3	Peak	Vertical
6	11020	26.9	6.2	33.0	54	-21.0	Average	Vertical
7	16530	37.5	13.0	50.5	74	-23.5	Peak	Vertical
8	16530	24.8	13.0	37.7	54	-16.3	Average	Vertical
IEEE 802.11n-HT40_Channel 110								
1	11100	37.9	6.3	44.1	74	-29.9	Peak	Horizontal
2	11100	24.6	6.3	30.8	54	-23.2	Average	Horizontal
3	16650	37.6	13.0	50.6	74	-23.4	Peak	Horizontal
4	16650	24.7	13.0	37.7	54	-16.3	Average	Horizontal
5	11100	37.7	6.3	44.0	74	-30.0	Peak	Vertical
6	11100	24.5	6.3	30.8	54	-23.3	Average	Vertical
7	16650	37.3	13.0	50.3	74	-23.7	Peak	Vertical
8	16650	24.5	13.0	37.5	54	-16.5	Average	Vertical

**Shenzhen UnionTrust Quality and Technology Co., Ltd.**

Address: Unit D/E of 9/F and 16/F, Block A, Building 6, Baoneng science and technology park, Longhua district, Shenzhen, China

Tel: +86-755-28230888

Fax: +86-755-28230886

E-mail: info@uttlab.com

<http://www.uttlab.com>

UTTR-RF-RSS247-V1.1

IEEE 802.11n-HT40_Channel 134								
No.	Frequency (MHz)	Reading (dBµV)	Correction factor (dB/m)	Result (dBµV/m)	Limit (dBµV/m)	Margin (dB)	Detector	Antenna Polaxis
1	11340	39.4	6.6	46.1	74	-27.9	Peak	Horizontal
2	11340	26.6	6.6	33.3	54	-20.7	Average	Horizontal
3	17010	35.9	13.1	49.0	74	-25.0	Peak	Horizontal
4	17010	23.1	13.1	36.2	54	-17.8	Average	Horizontal
5	11340	38.7	6.6	45.3	74	-28.7	Peak	Vertical
6	11340	26.4	6.6	33.0	54	-21.0	Average	Vertical
7	17010	35.6	13.1	48.7	74	-25.3	Peak	Vertical
8	17010	23.0	13.1	36.1	54	-17.9	Average	Vertical
IEEE 802.11n-HT40_Channel 151								
1	11510	38.1	6.9	45.0	74	-29.0	Peak	Horizontal
2	11510	24.7	6.9	31.6	54	-22.4	Average	Horizontal
3	17265	36.3	13.8	50.1	74	-23.9	Peak	Horizontal
4	17265	24.2	13.8	38.0	54	-16.0	Average	Horizontal
5	11510	37.5	6.9	44.4	74	-29.6	Peak	Vertical
6	11510	24.6	6.9	31.6	54	-22.5	Average	Vertical
7	17265	36.8	13.8	50.6	74	-23.4	Peak	Vertical
8	17265	24.1	13.8	37.9	54	-16.1	Average	Vertical
IEEE 802.11n-HT40_Channel 159								
1	11590	38.0	7.1	45.1	74	-28.9	Peak	Horizontal
2	11590	25.1	7.1	32.2	54	-21.8	Average	Horizontal
3	17385	36.6	14.1	50.7	74	-23.3	Peak	Horizontal
4	17385	24.3	14.1	38.4	54	-15.7	Average	Horizontal
5	11590	37.5	7.1	44.6	74	-29.4	Peak	Vertical
6	11590	25.0	7.1	32.1	54	-21.9	Average	Vertical
7	17385	36.7	14.1	50.8	74	-23.2	Peak	Vertical
8	17385	24.2	14.1	38.3	54	-15.7	Average	Vertical



IEEE 802.11ac-VHT80_Channel 42								
No.	Frequency (MHz)	Reading (dBµV)	Correction factor (dB/m)	Result (dBµV/m)	Limit (dBµV/m)	Margin (dB)	Detector	Antenna Polaxis
1	10420	41.9	6.3	48.2	74	-25.8	Peak	Horizontal
2	10420	28.0	6.3	34.3	54	-19.7	Average	Horizontal
3	15630	38.4	11.5	49.9	74	-24.1	Peak	Horizontal
4	15630	24.4	11.5	35.9	54	-18.1	Average	Horizontal
5	10420	41.3	6.3	47.6	74	-26.4	Peak	Vertical
6	10420	27.9	6.3	34.2	54	-19.8	Average	Vertical
7	15630	37.4	11.5	48.9	74	-25.2	Peak	Vertical
8	15630	24.4	11.5	35.9	54	-18.1	Average	Vertical
IEEE 802.11ac-VHT80_Channel 58								
1	10580	40.2	6.3	46.5	74	-27.5	Peak	Horizontal
2	10580	26.6	6.3	32.9	54	-21.1	Average	Horizontal
3	15870	37.5	11.9	49.4	74	-24.6	Peak	Horizontal
4	15870	24.2	11.9	36.1	54	-17.9	Average	Horizontal
5	10580	39.6	6.3	45.9	74	-28.1	Peak	Vertical
6	10580	26.7	6.3	33.0	54	-21.0	Average	Vertical
7	15870	36.4	11.9	48.3	74	-25.7	Peak	Vertical
8	15870	24.1	11.9	36.0	54	-18.0	Average	Vertical
IEEE 802.11ac-VHT80_Channel 106								
1	11060	38.0	6.2	44.2	74	-29.8	Peak	Horizontal
2	11060	25.7	6.2	31.9	54	-22.1	Average	Horizontal
3	16590	36.1	13.0	49.1	74	-24.9	Peak	Horizontal
4	16590	23.8	13.0	36.8	54	-17.2	Average	Horizontal
5	11060	38.4	6.2	44.6	74	-29.4	Peak	Vertical
6	11060	25.5	6.2	31.7	54	-22.3	Average	Vertical
7	16590	36.5	13.0	49.5	74	-24.5	Peak	Vertical
8	16590	23.7	13.0	36.7	54	-17.3	Average	Vertical

IEEE 802.11ac-VHT80_Channel 155								
No.	Frequency (MHz)	Reading (dBµV)	Correction factor (dB/m)	Result (dBµV/m)	Limit (dBµV/m)	Margin (dB)	Detector	Antenna Polaxis
1	11550	36.9	7.0	43.9	74	-30.1	Peak	Horizontal
2	11550	24.5	7.0	31.6	54	-22.5	Average	Horizontal
3	17325	36.5	13.9	50.4	74	-23.6	Peak	Horizontal
4	17325	24.2	13.9	38.1	54	-15.9	Average	Horizontal
5	11550	37.0	7.0	44.0	74	-30.0	Peak	Vertical
6	11550	24.5	7.0	31.5	54	-22.5	Average	Vertical
7	17325	36.6	13.9	50.5	74	-23.5	Peak	Vertical
8	17325	24.1	13.9	38.0	54	-16.0	Average	Vertical

Remark:

1. Correct Factor = Antenna Factor + Cable Loss - Amplifier Gain, the value was added to Original Receiver Reading by the software automatically.
2. Result = Reading + Correct Factor.
3. Margin = Result - Limit

**Shenzhen UnionTrust Quality and Technology Co., Ltd.**

Address: Unit D/E of 9/F and 16/F, Block A, Building 6, Baoneng science and technology park, Longhua district, Shenzhen, China

Tel: +86-755-28230888

Fax: +86-755-28230886

E-mail: info@uttlab.com

<http://www.uttlab.com>

UTTR-RF-RSS247-V1.1

**Band Edge Measurements (Radiated)**  
**IEEE 802.11a**

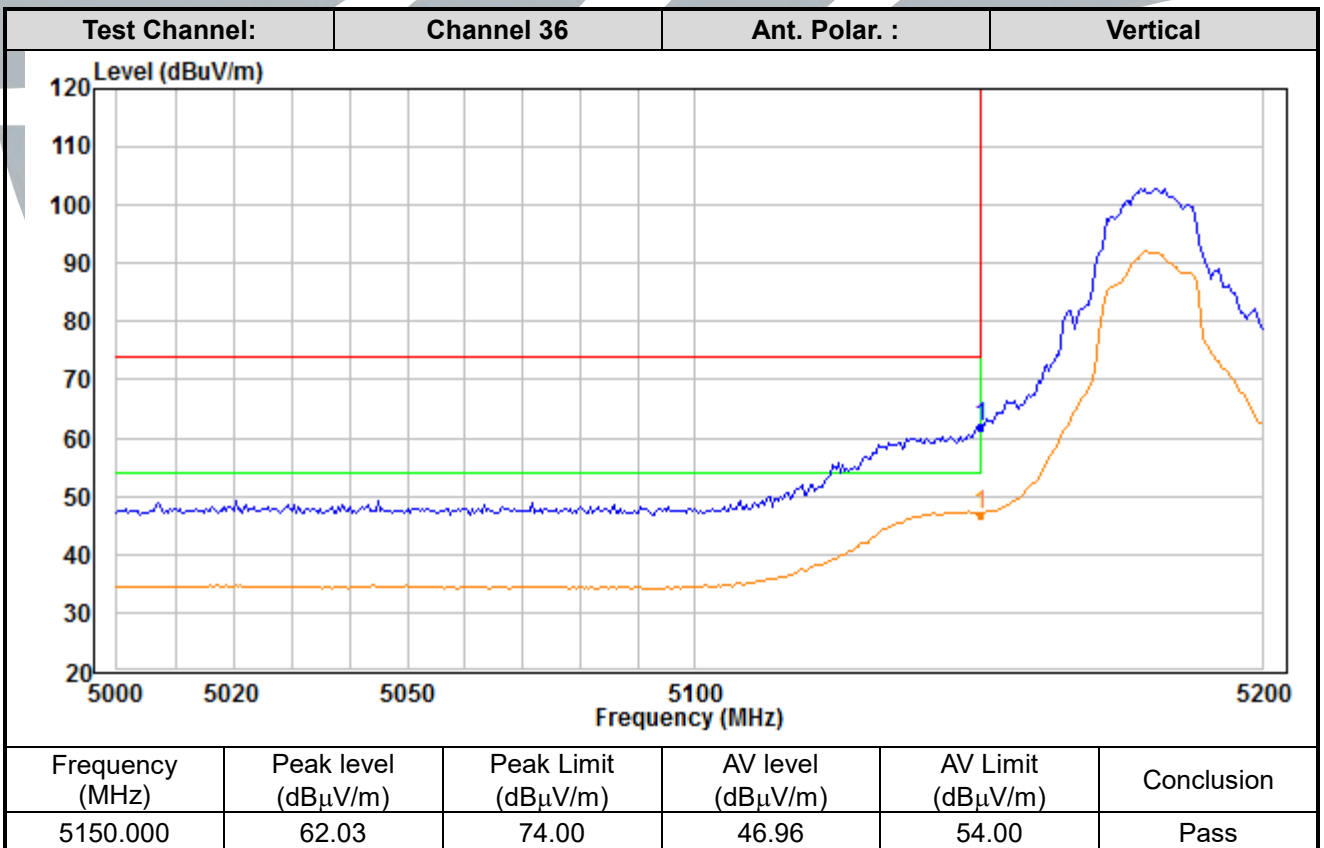
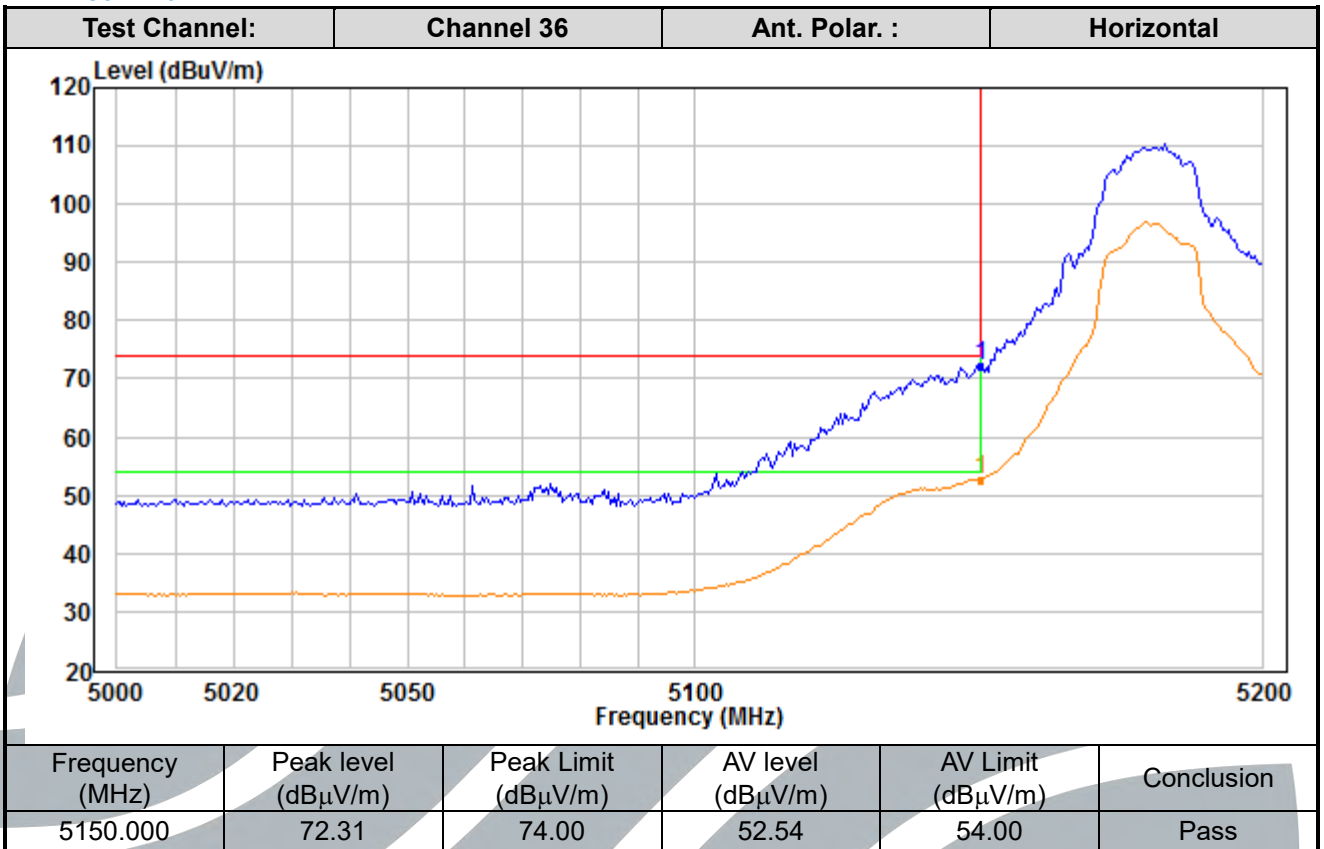

**Shenzhen UnionTrust Quality and Technology Co., Ltd.**

Address: Unit D/E of 9/F and 16/F, Block A, Building 6, Baoneng science and technology park, Longhua district, Shenzhen, China

Tel: +86-755-28230888

Fax: +86-755-28230886

E-mail: info@uttlab.com

<http://www.uttlab.com>

UTTR-RF-RSS247-V1.1

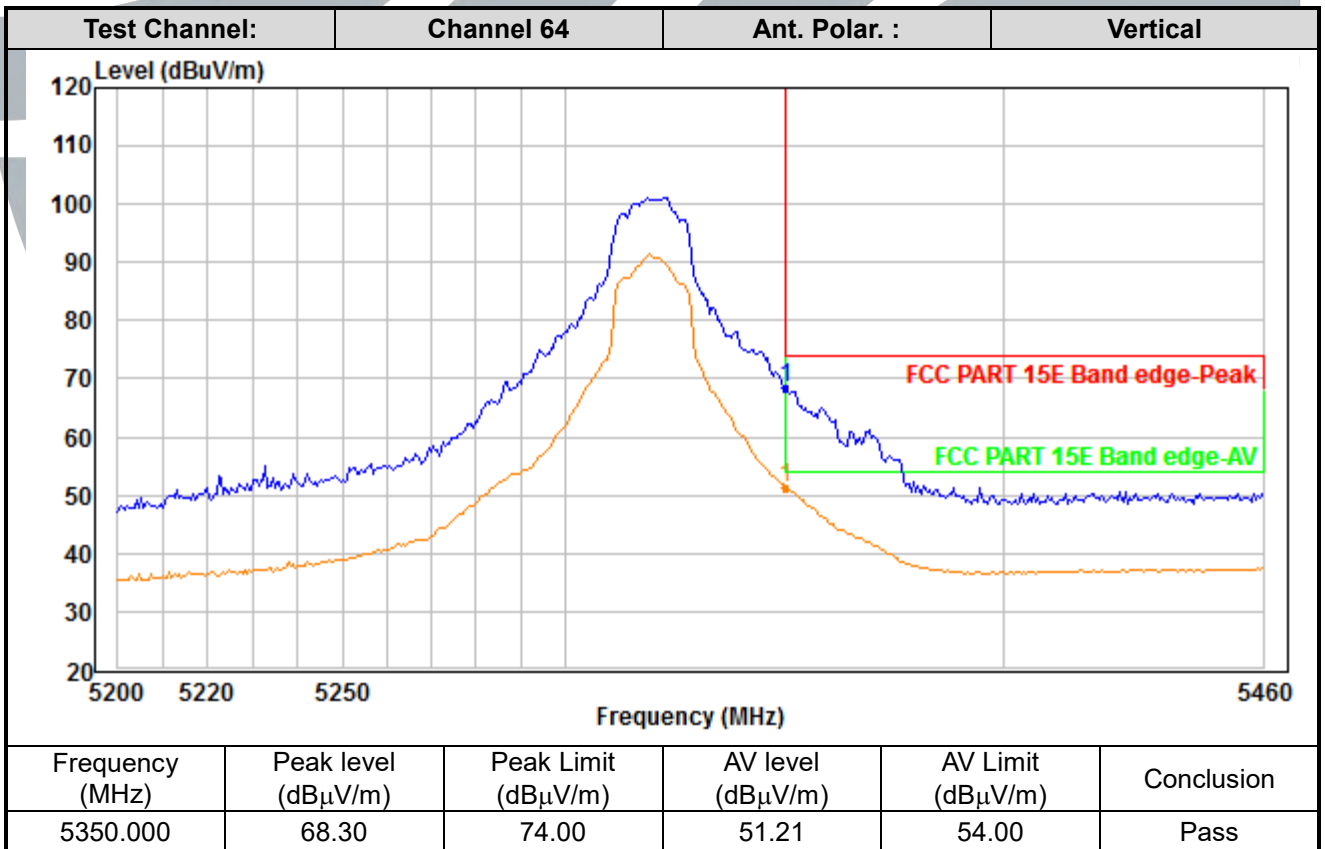
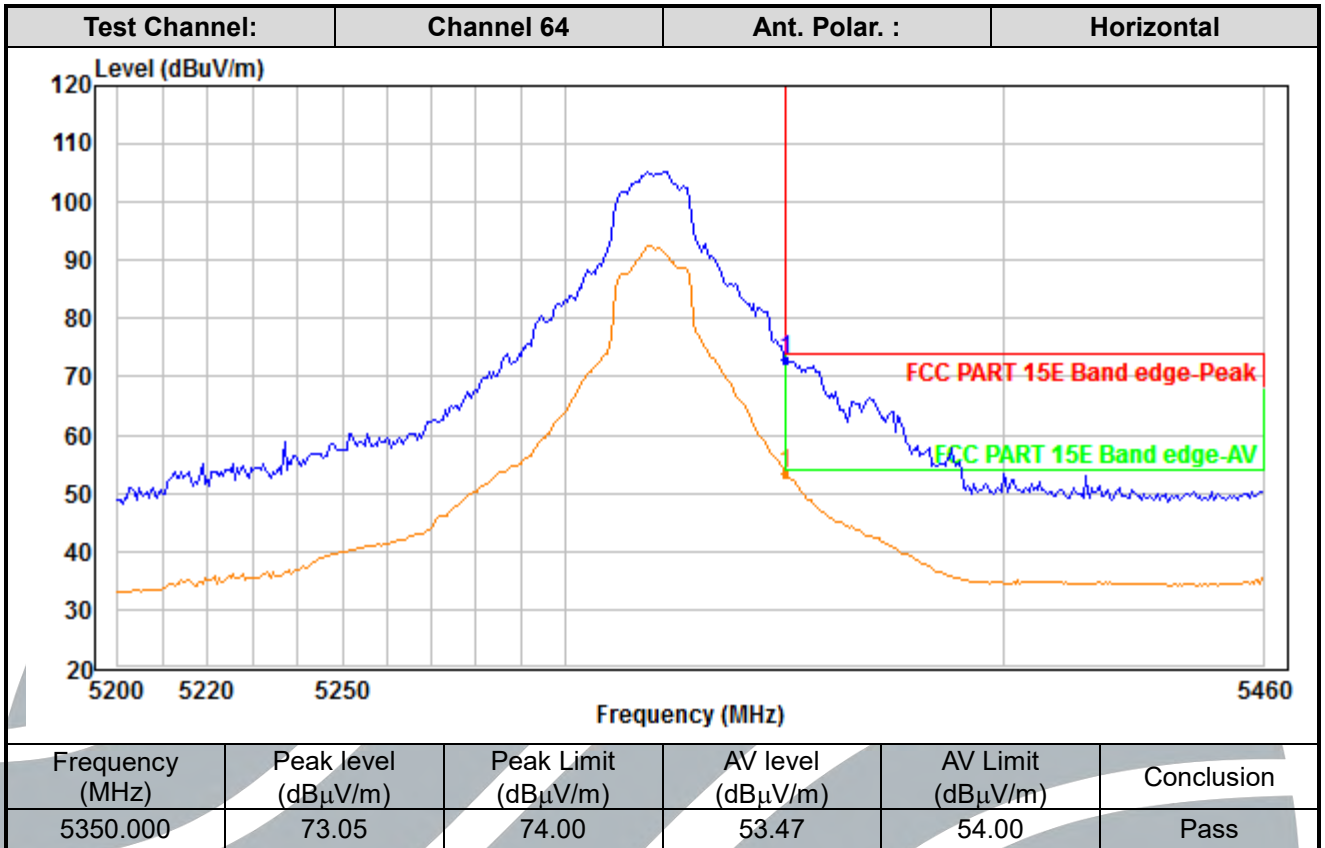

**Shenzhen UnionTrust Quality and Technology Co., Ltd.**

Address: Unit D/E of 9/F and 16/F, Block A, Building 6, Baoneng science and technology park, Longhua district, Shenzhen, China

Tel: +86-755-28230888

Fax: +86-755-28230886

E-mail: info@uttlab.com

<http://www.uttlab.com>

UTTR-RF-RSS247-V1.1

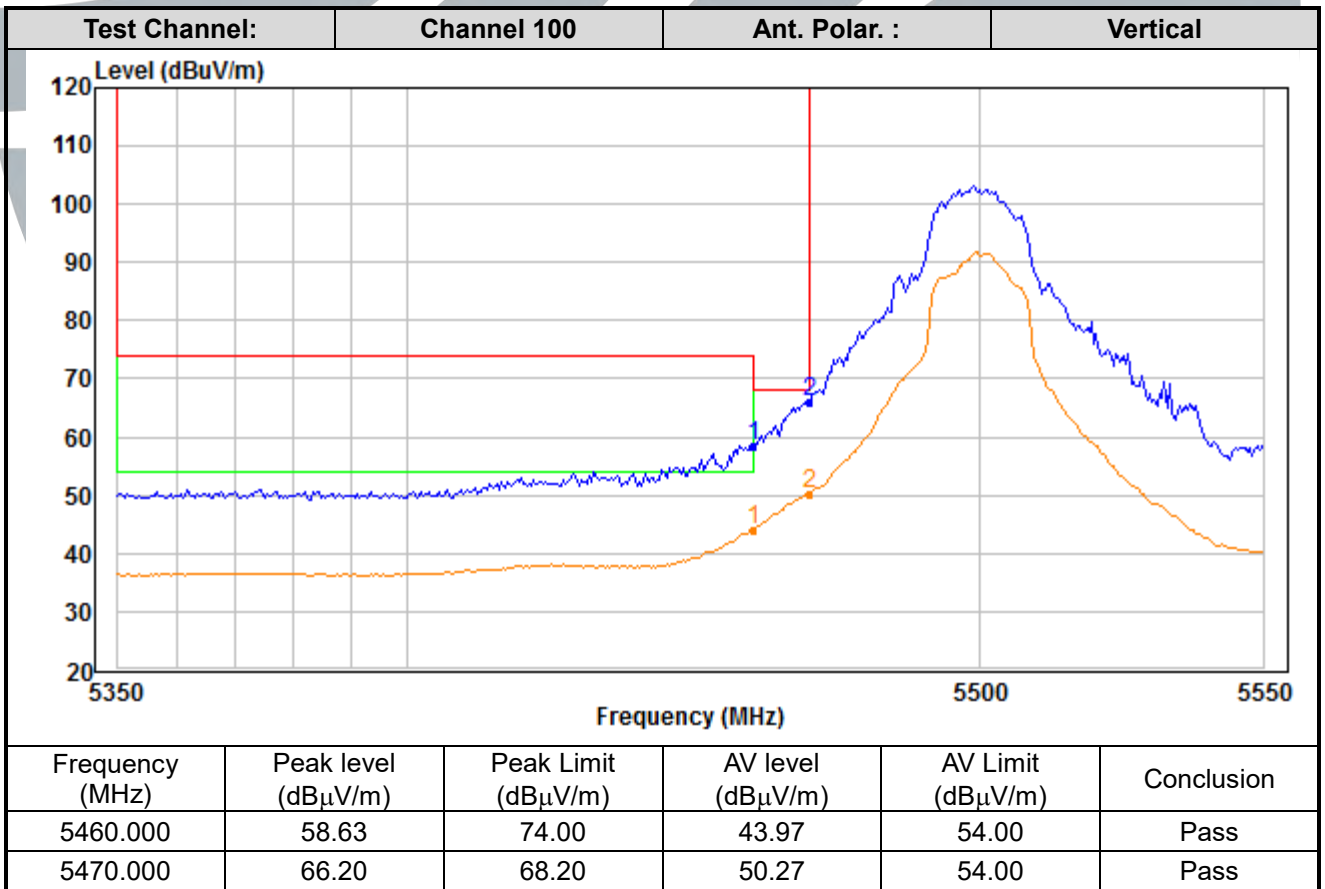
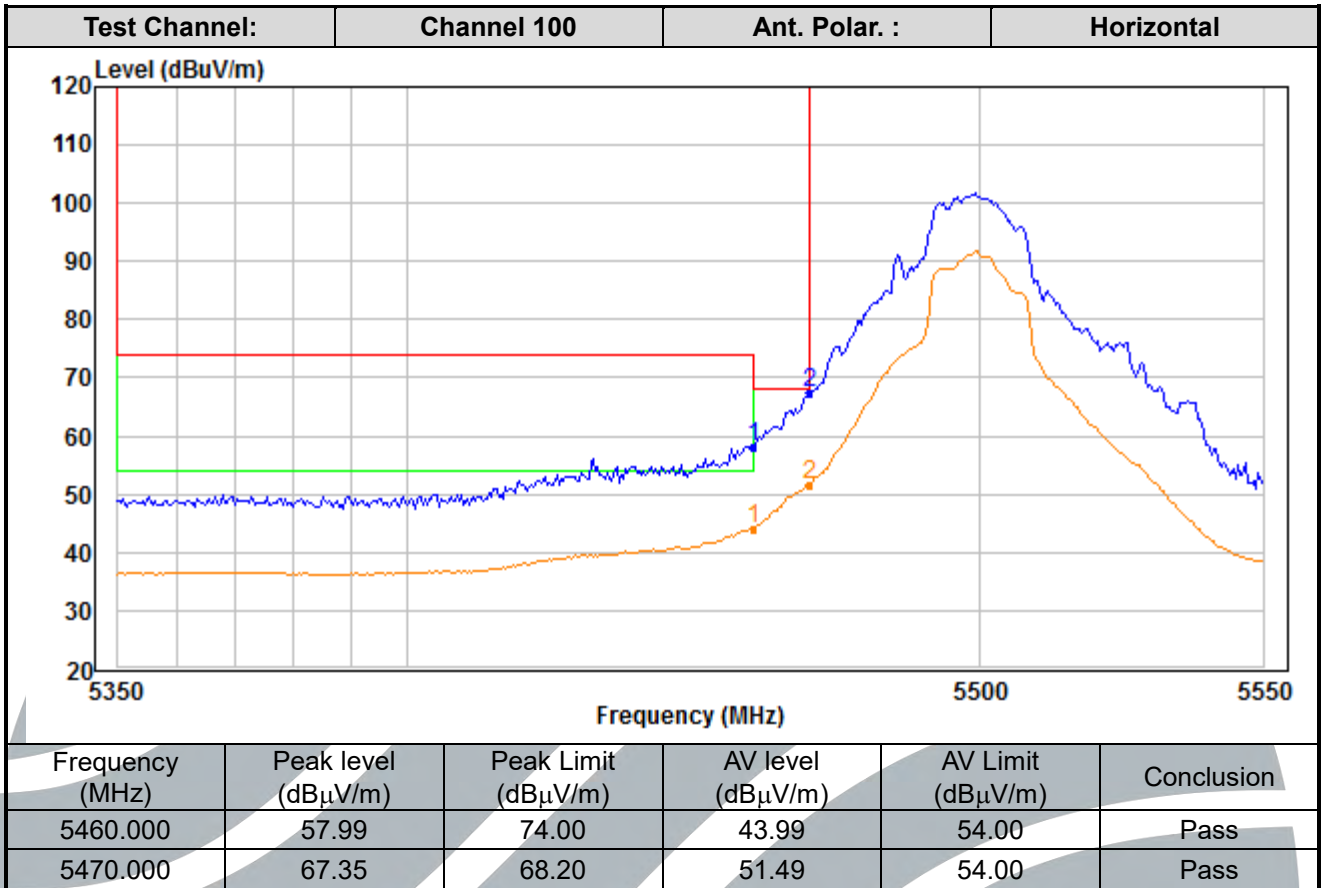

**Shenzhen UnionTrust Quality and Technology Co., Ltd.**

Address: Unit D/E of 9/F and 16/F, Block A, Building 6, Baoneng science and technology park, Longhua district, Shenzhen, China

Tel: +86-755-28230888

Fax: +86-755-28230886

E-mail: info@uttlab.com

<http://www.uttlab.com>

UTTR-RF-RSS247-V1.1

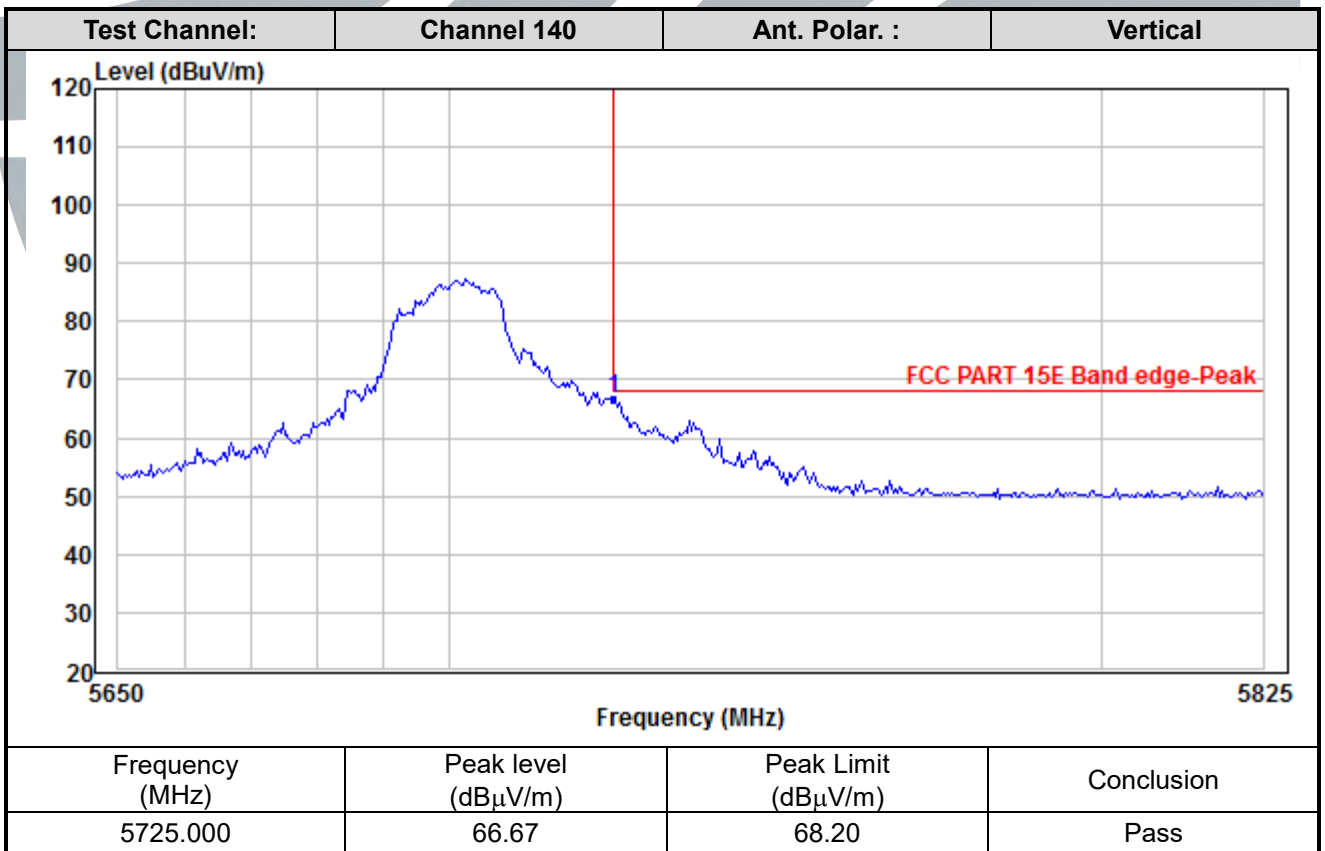
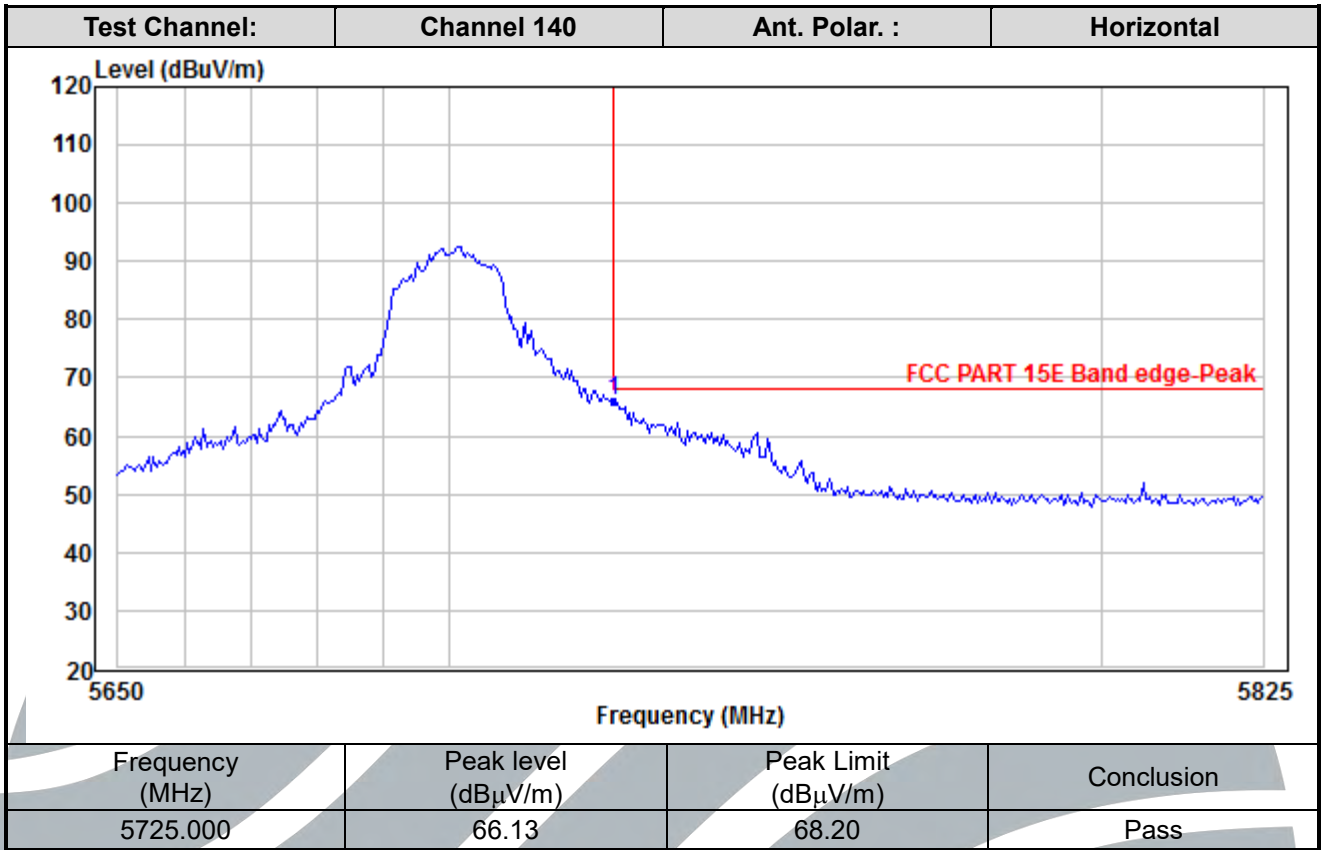

**Shenzhen UnionTrust Quality and Technology Co., Ltd.**

Address: Unit D/E of 9/F and 16/F, Block A, Building 6, Baoneng science and technology park, Longhua district, Shenzhen, China

Tel: +86-755-28230888

Fax: +86-755-28230886

E-mail: info@uttlab.com

<http://www.uttlab.com>

UTTR-RF-RSS247-V1.1

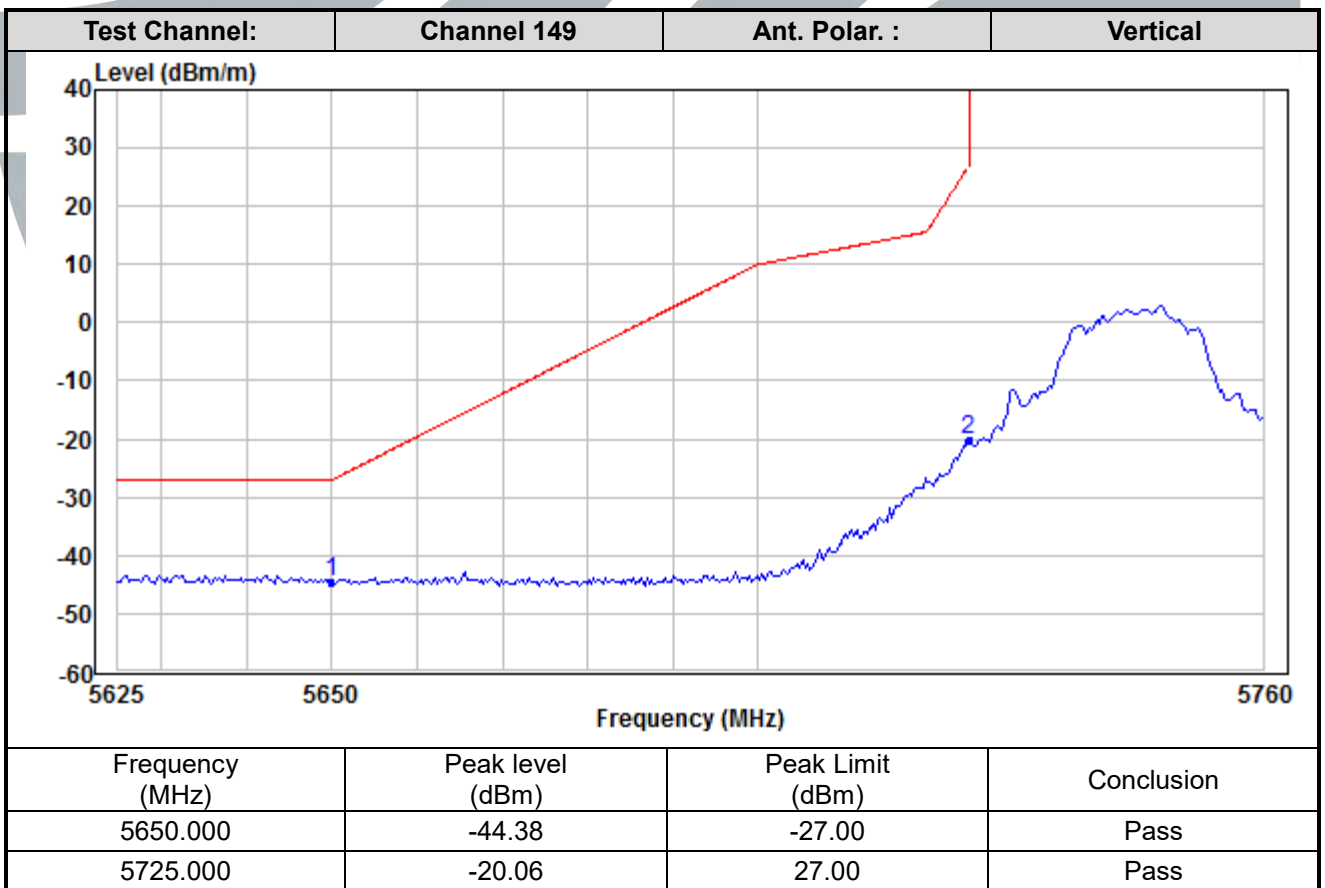
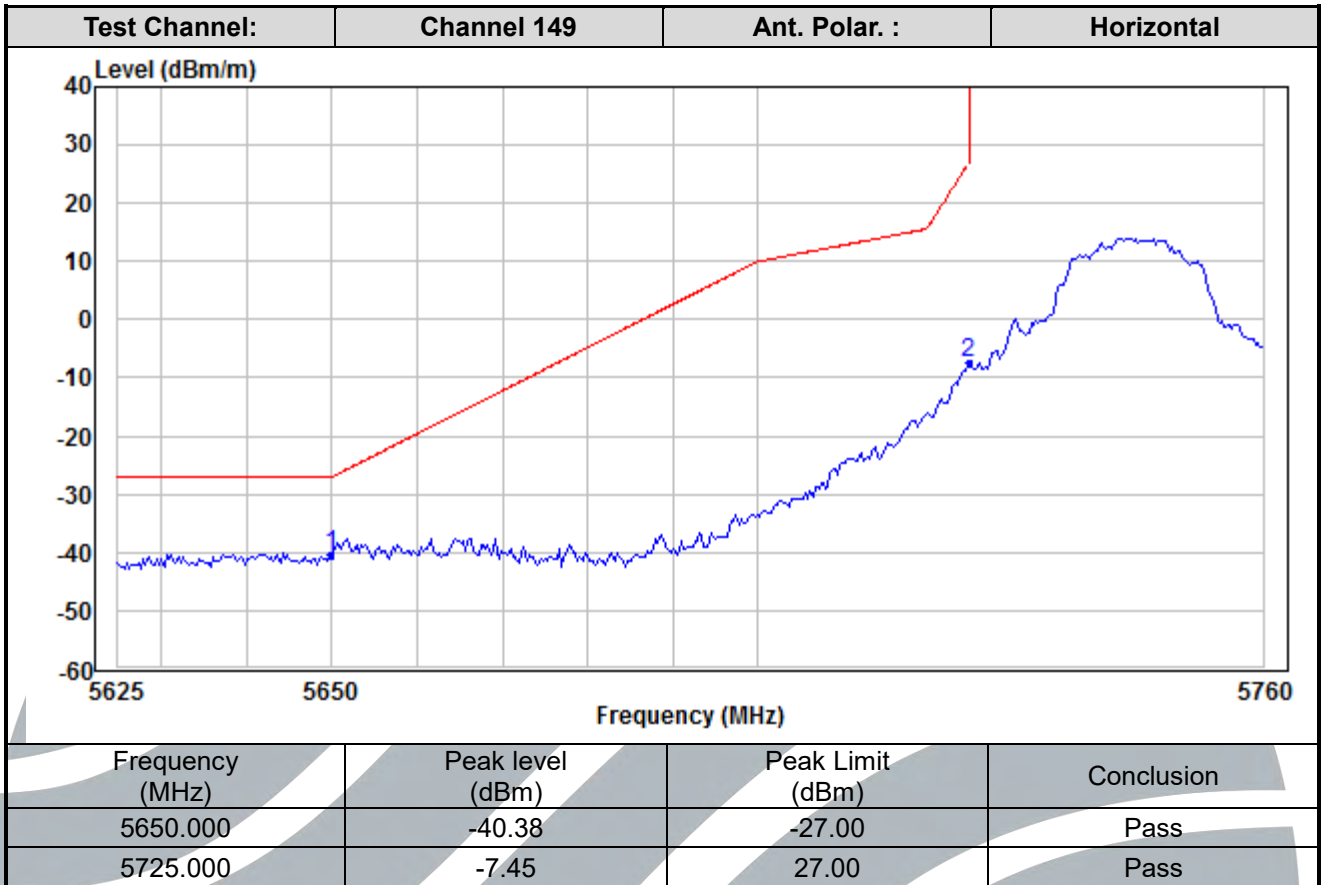

**Shenzhen UnionTrust Quality and Technology Co., Ltd.**

Address: Unit D/E of 9/F and 16/F, Block A, Building 6, Baoneng science and technology park, Longhua district, Shenzhen, China

Tel: +86-755-28230888

Fax: +86-755-28230886

E-mail: info@uttlab.com

<http://www.uttlab.com>

UTTR-RF-RSS247-V1.1

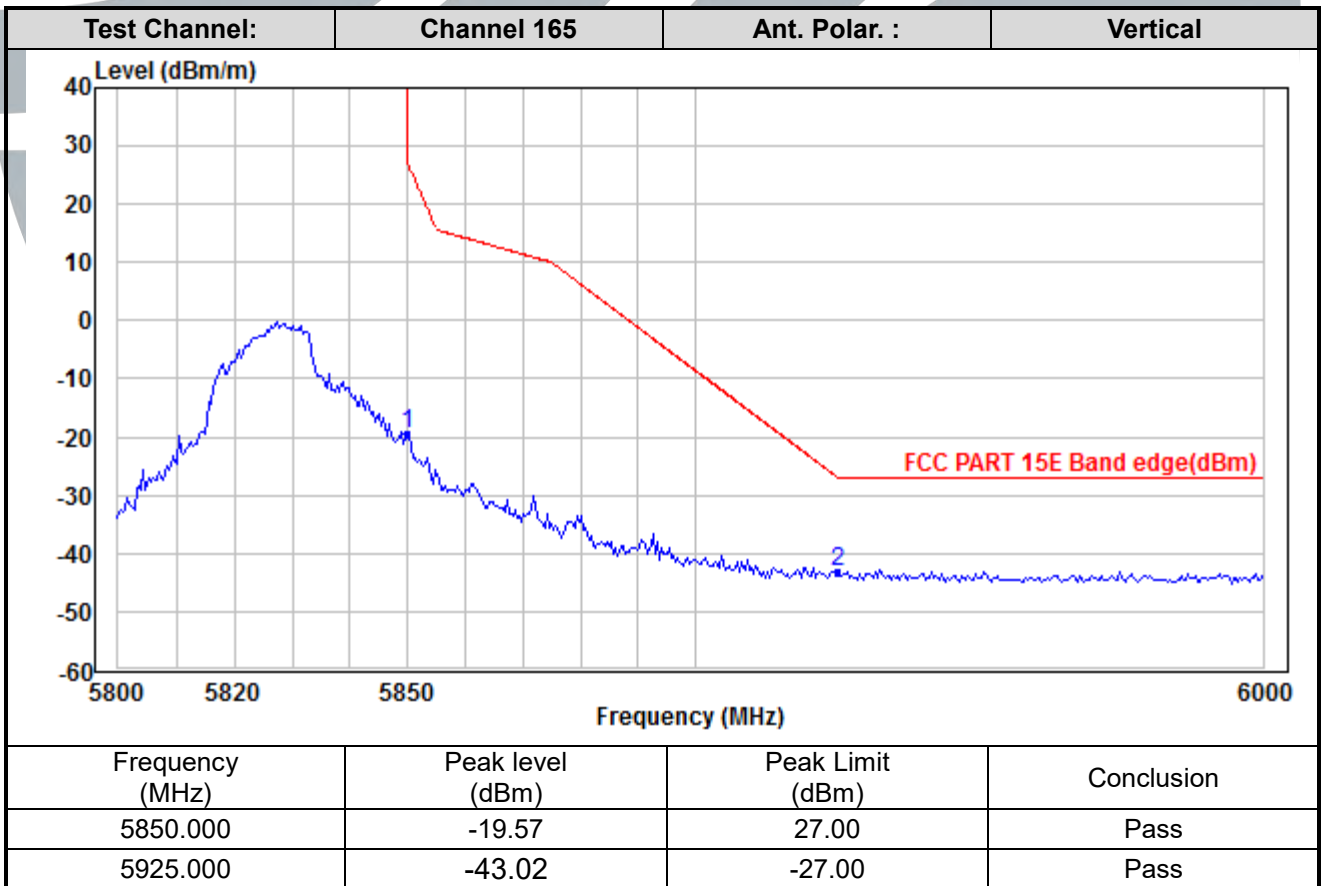
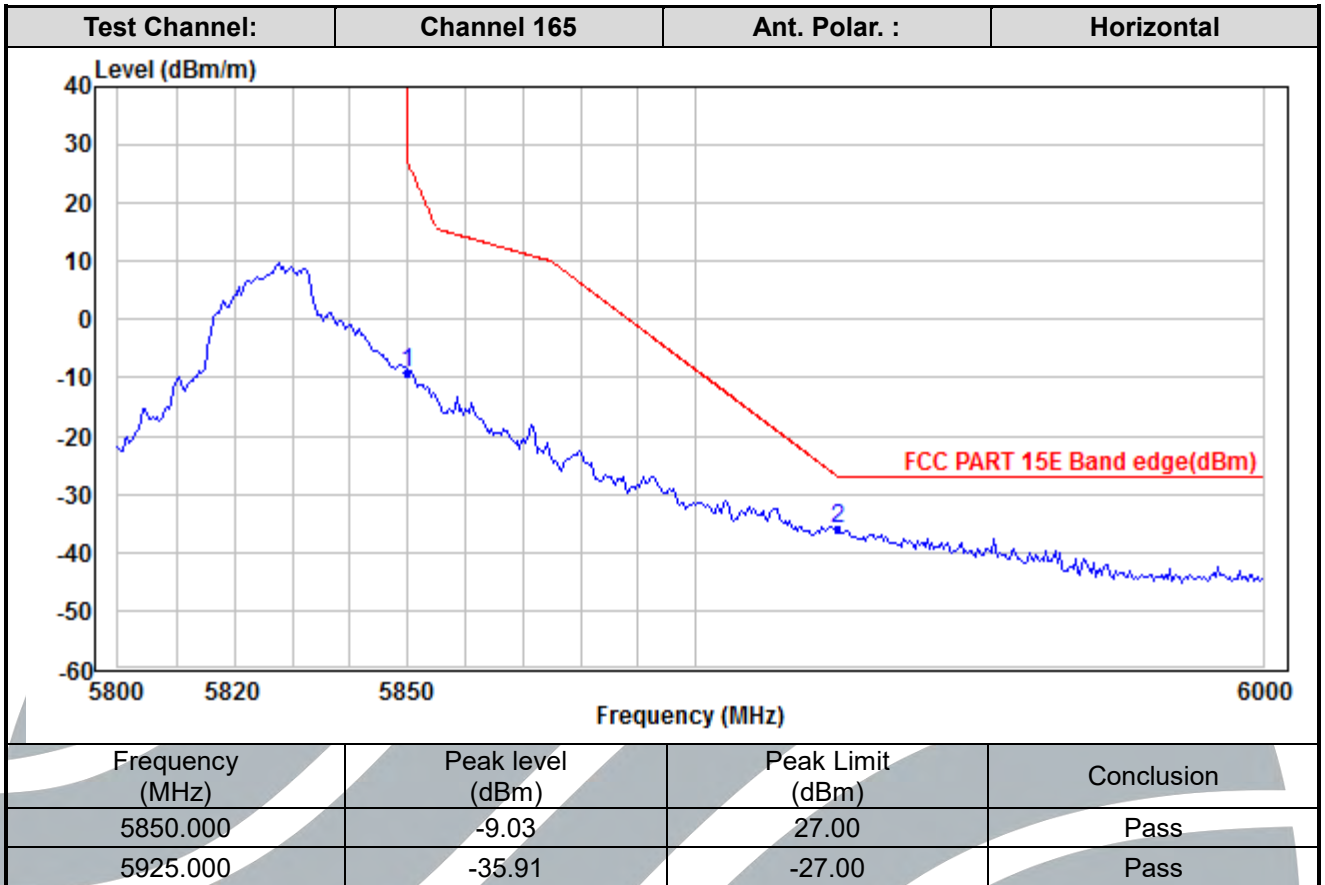

**Shenzhen UnionTrust Quality and Technology Co., Ltd.**

Address: Unit D/E of 9/F and 16/F, Block A, Building 6, Baoneng science and technology park, Longhua district, Shenzhen, China

Tel: +86-755-28230888

Fax: +86-755-28230886

E-mail: info@uttlab.com

<http://www.uttlab.com>

UTTR-RF-RSS247-V1.1

IEEE 802.11n-HT20

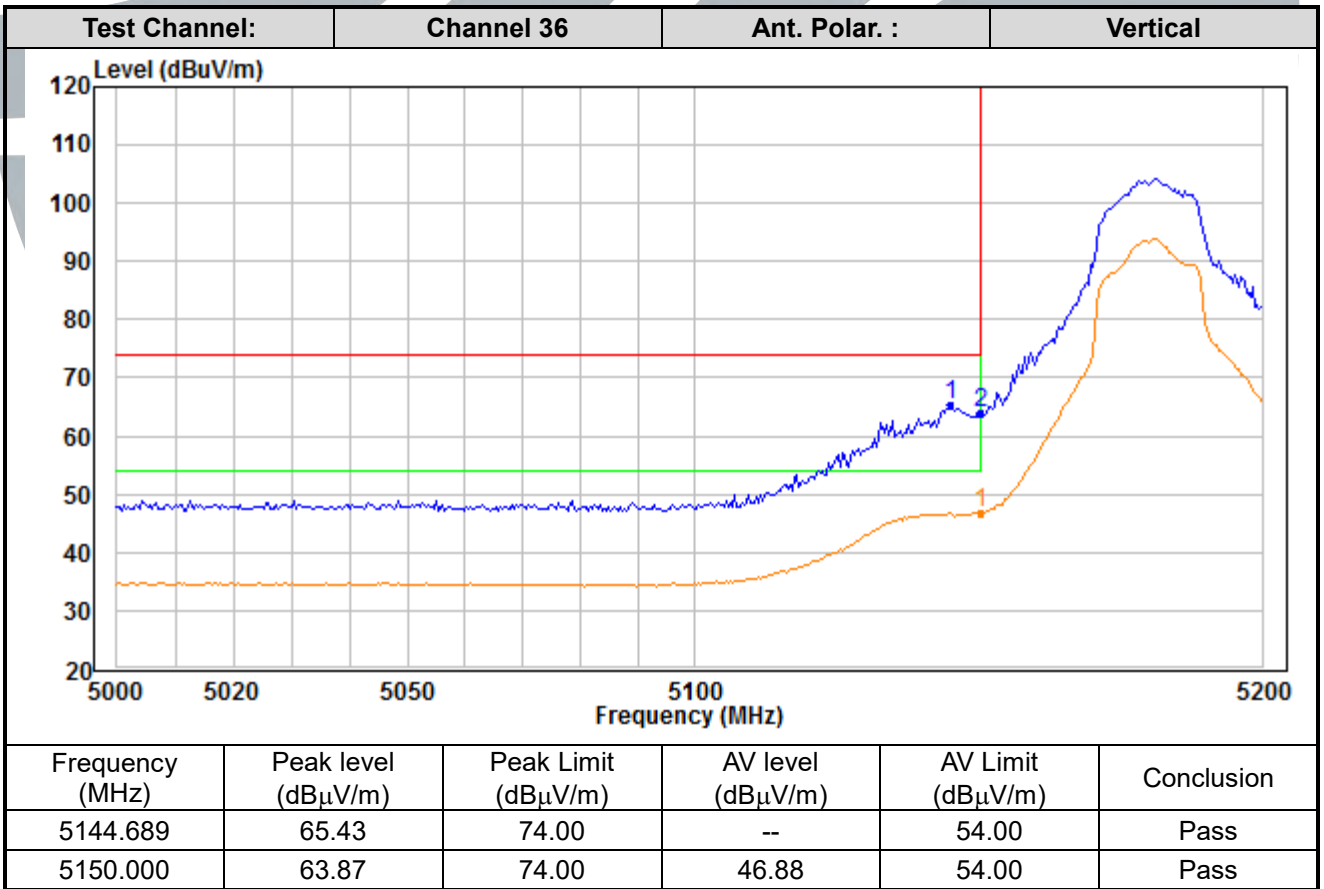
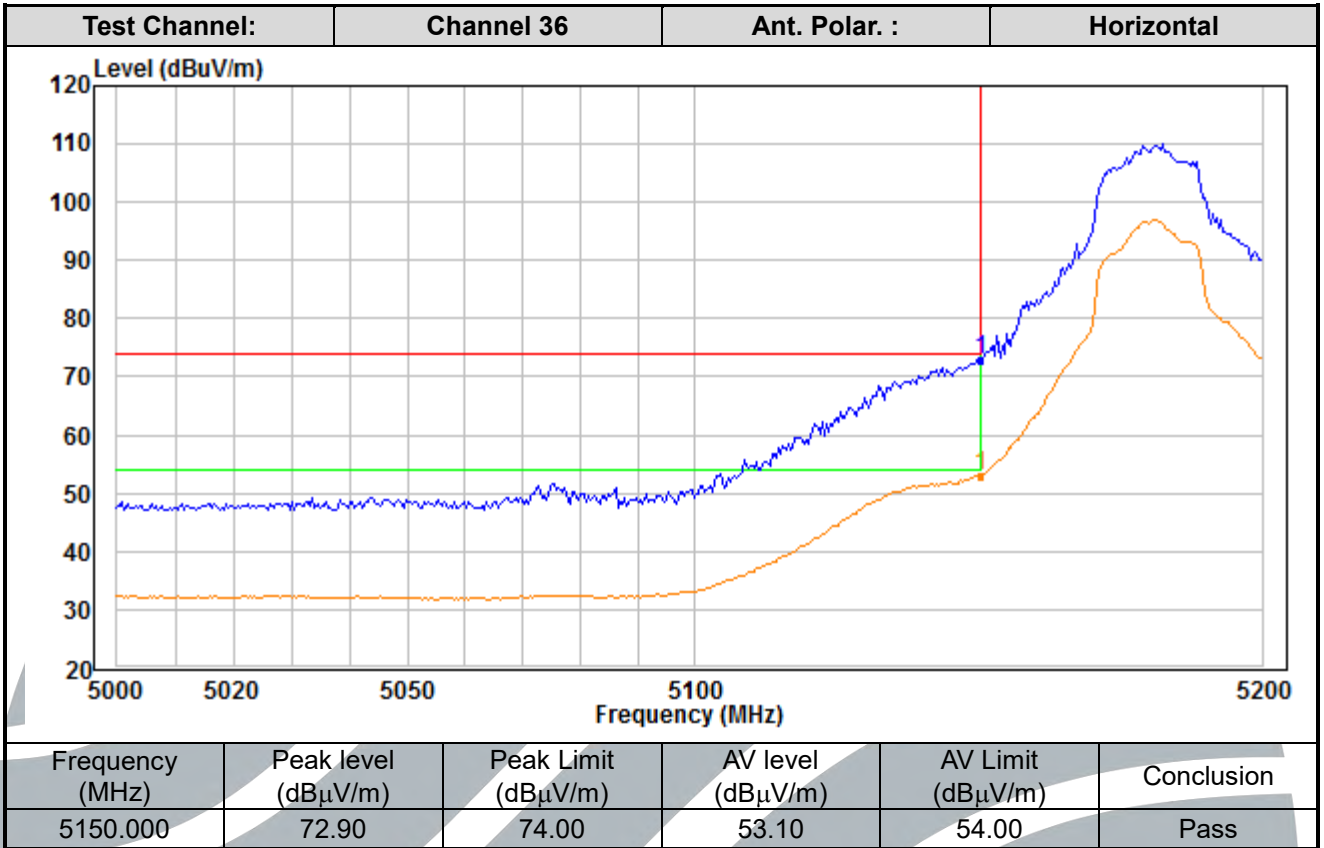

**Shenzhen UnionTrust Quality and Technology Co., Ltd.**

Address: Unit D/E of 9/F and 16/F, Block A, Building 6, Baoneng science and technology park, Longhua district, Shenzhen, China

Tel: +86-755-28230888

Fax: +86-755-28230886

E-mail: info@uttlab.com

<http://www.uttlab.com>

UTTR-RF-RSS247-V1.1



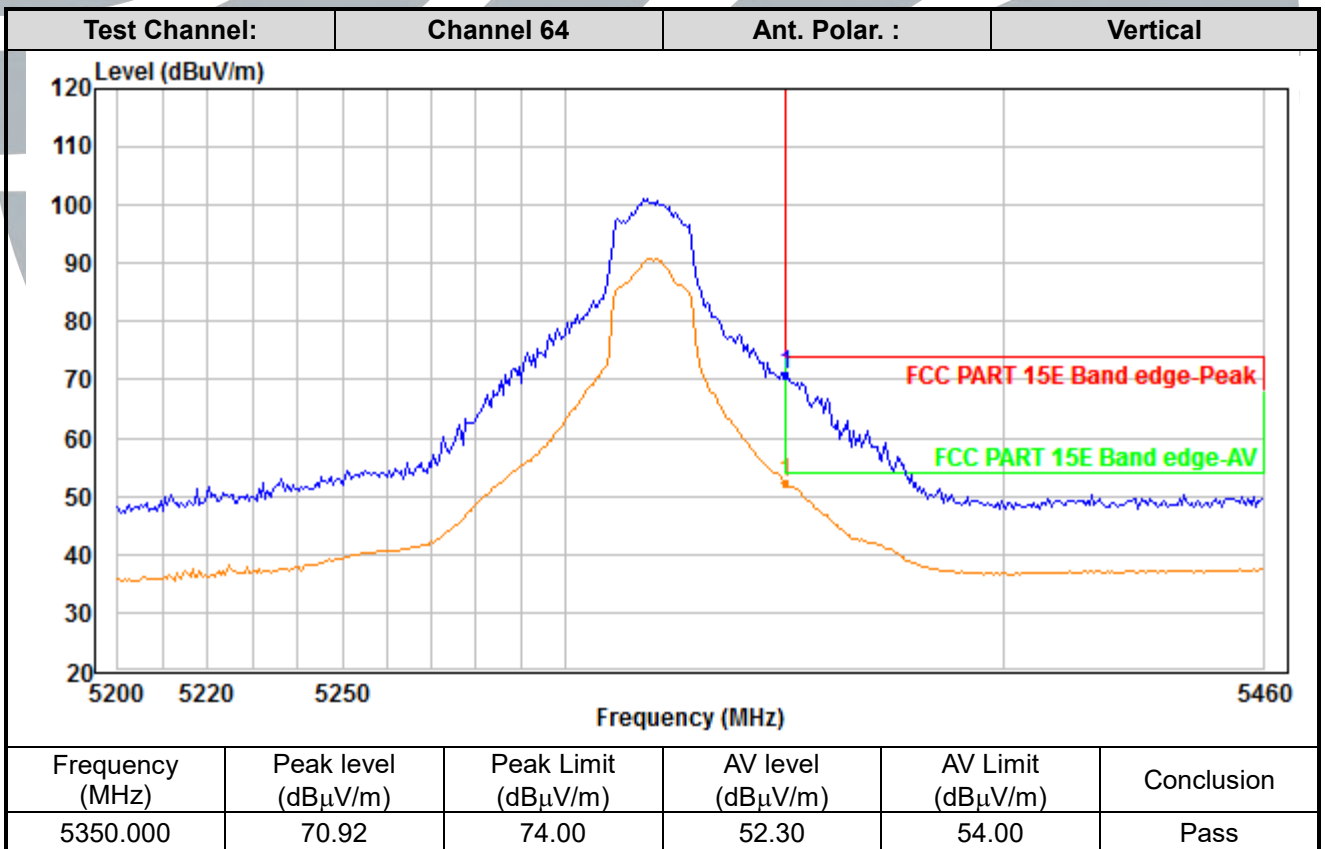
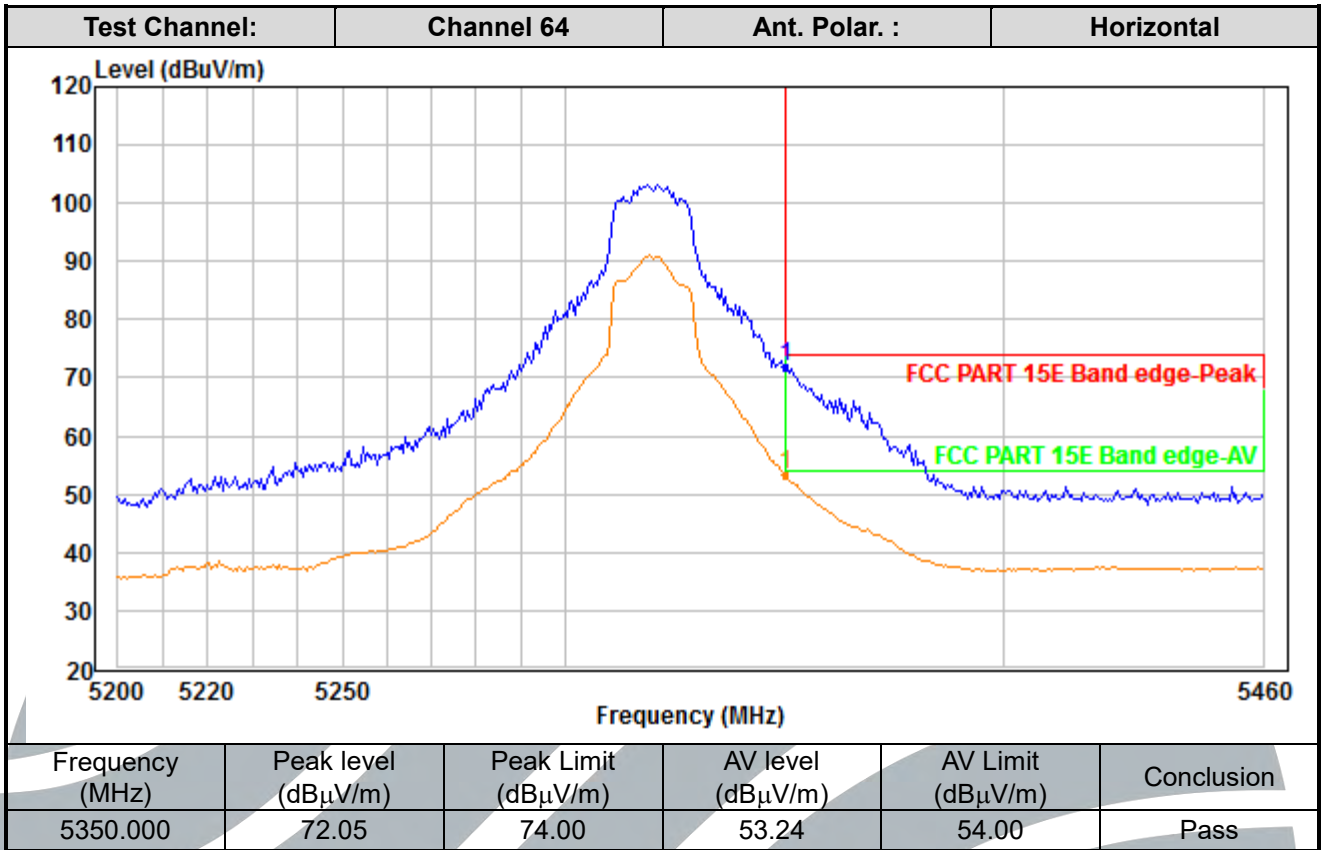

**Shenzhen UnionTrust Quality and Technology Co., Ltd.**

Address: Unit D/E of 9/F and 16/F, Block A, Building 6, Baoneng science and technology park, Longhua district, Shenzhen, China

Tel: +86-755-28230888

Fax: +86-755-28230886

E-mail: info@uttlab.com

<http://www.uttlab.com>

UTTR-RF-RSS247-V1.1

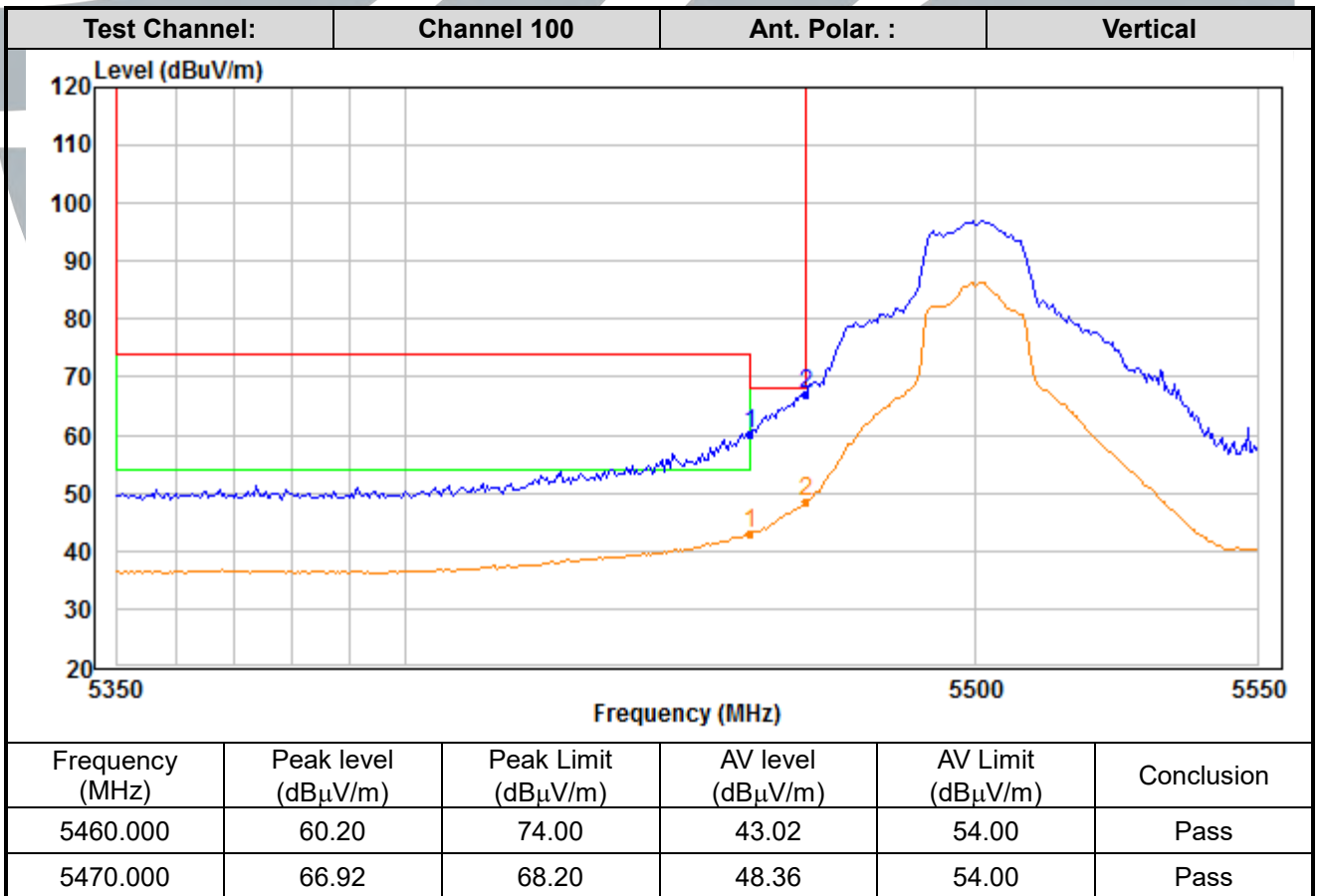
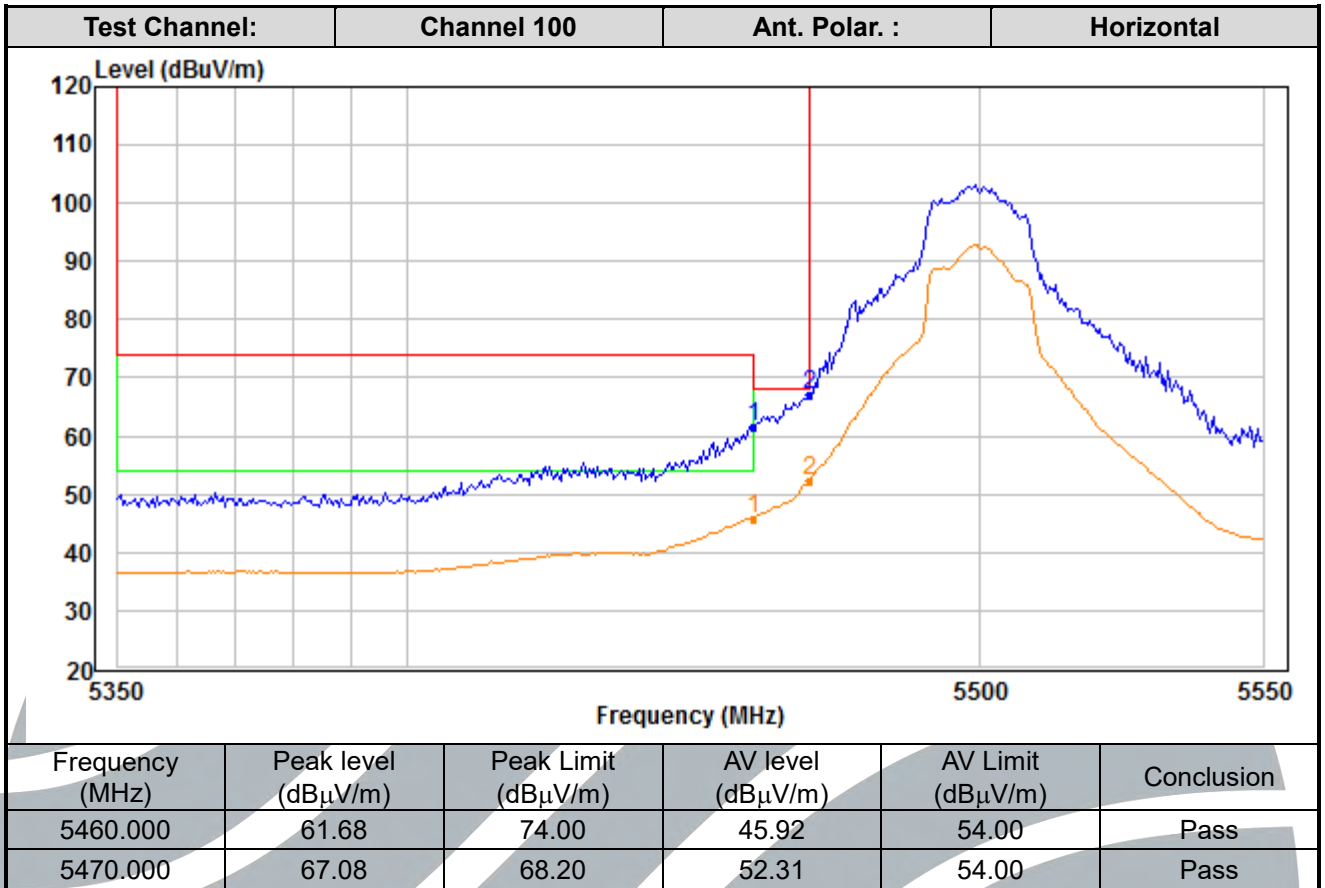

**Shenzhen UnionTrust Quality and Technology Co., Ltd.**

Address: Unit D/E of 9/F and 16/F, Block A, Building 6, Baoneng science and technology park, Longhua district, Shenzhen, China

Tel: +86-755-28230888

Fax: +86-755-28230886

E-mail: info@uttlab.com

<http://www.uttlab.com>

UTTR-RF-RSS247-V1.1

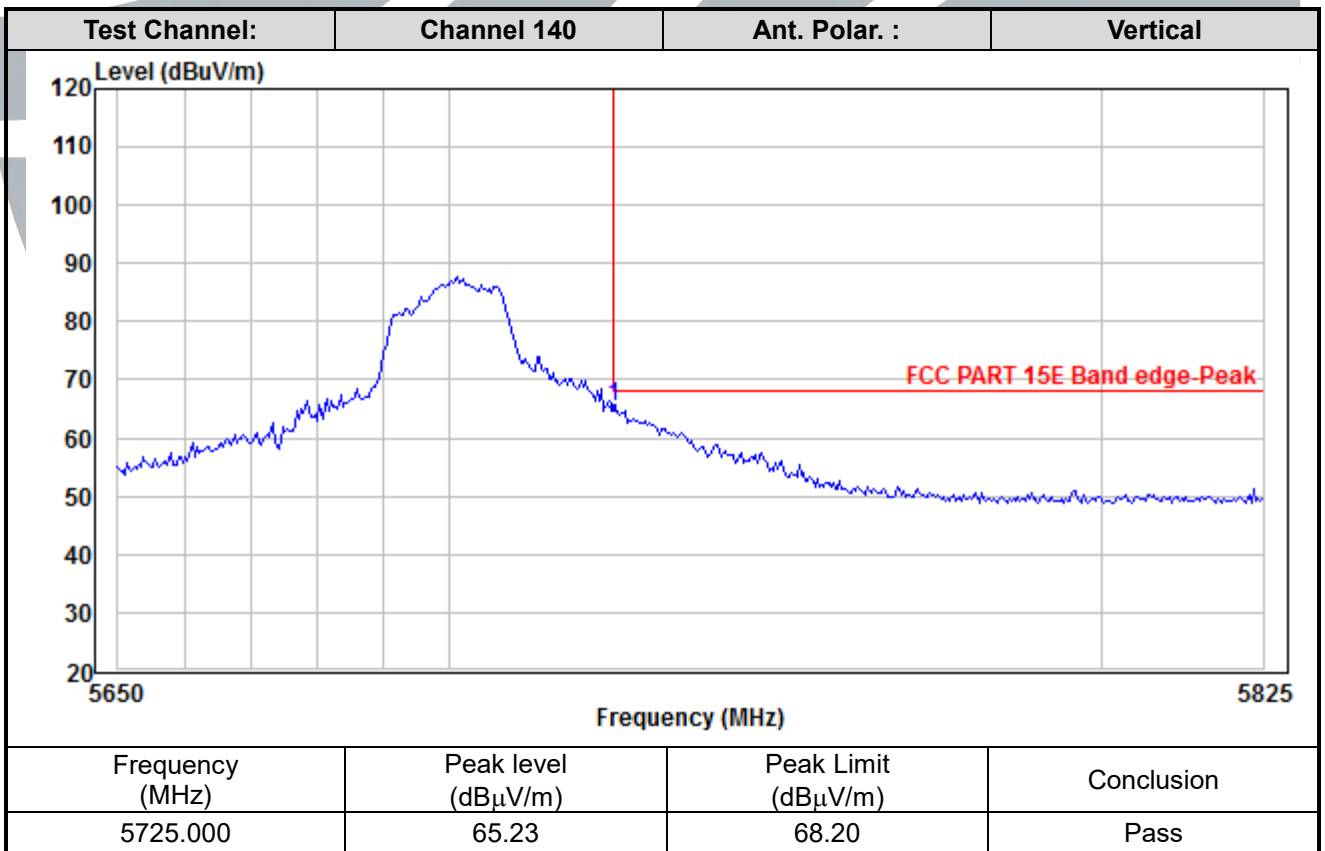
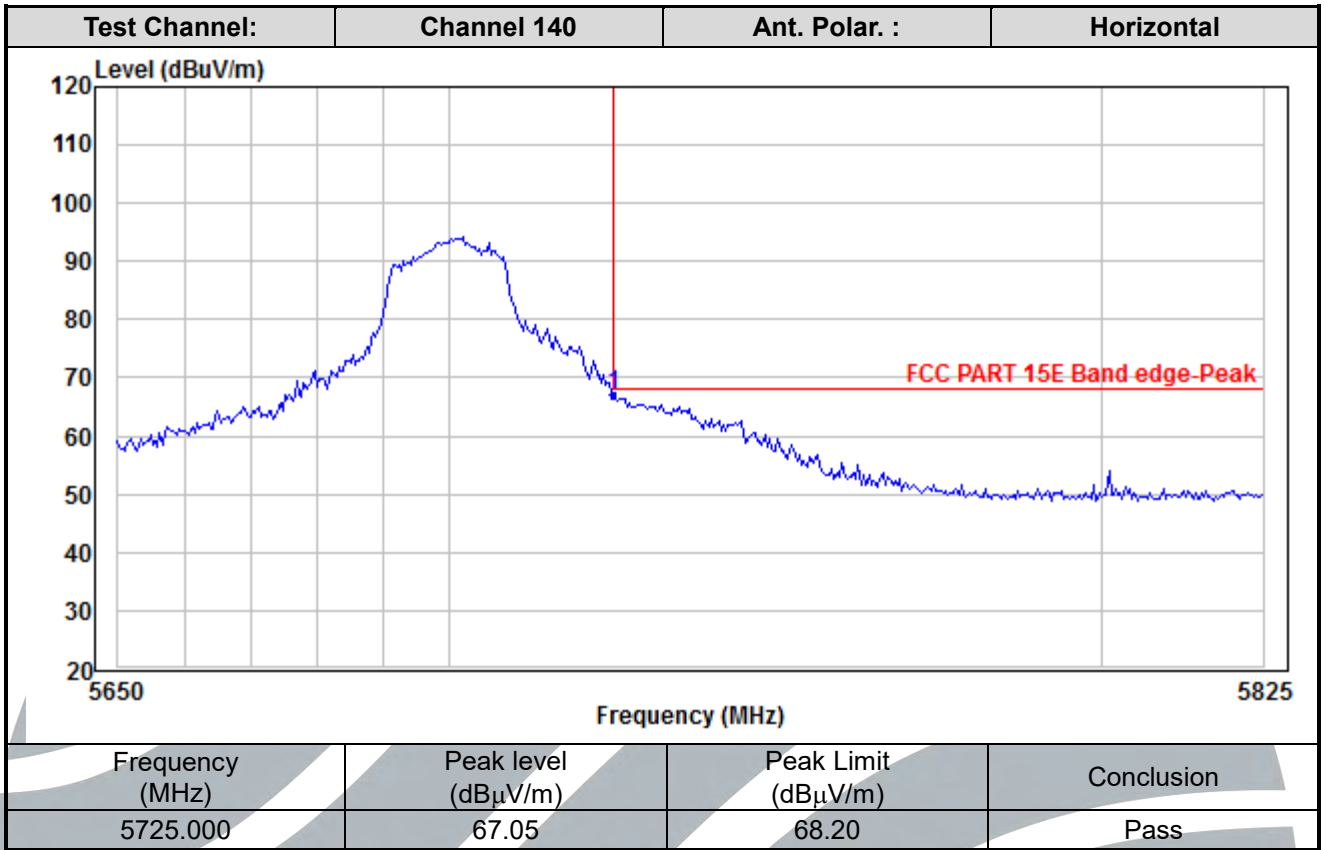

**Shenzhen UnionTrust Quality and Technology Co., Ltd.**

Address: Unit D/E of 9/F and 16/F, Block A, Building 6, Baoneng science and technology park, Longhua district, Shenzhen, China

Tel: +86-755-28230888

Fax: +86-755-28230886

E-mail: info@uttlab.com

<http://www.uttlab.com>

UTTR-RF-RSS247-V1.1

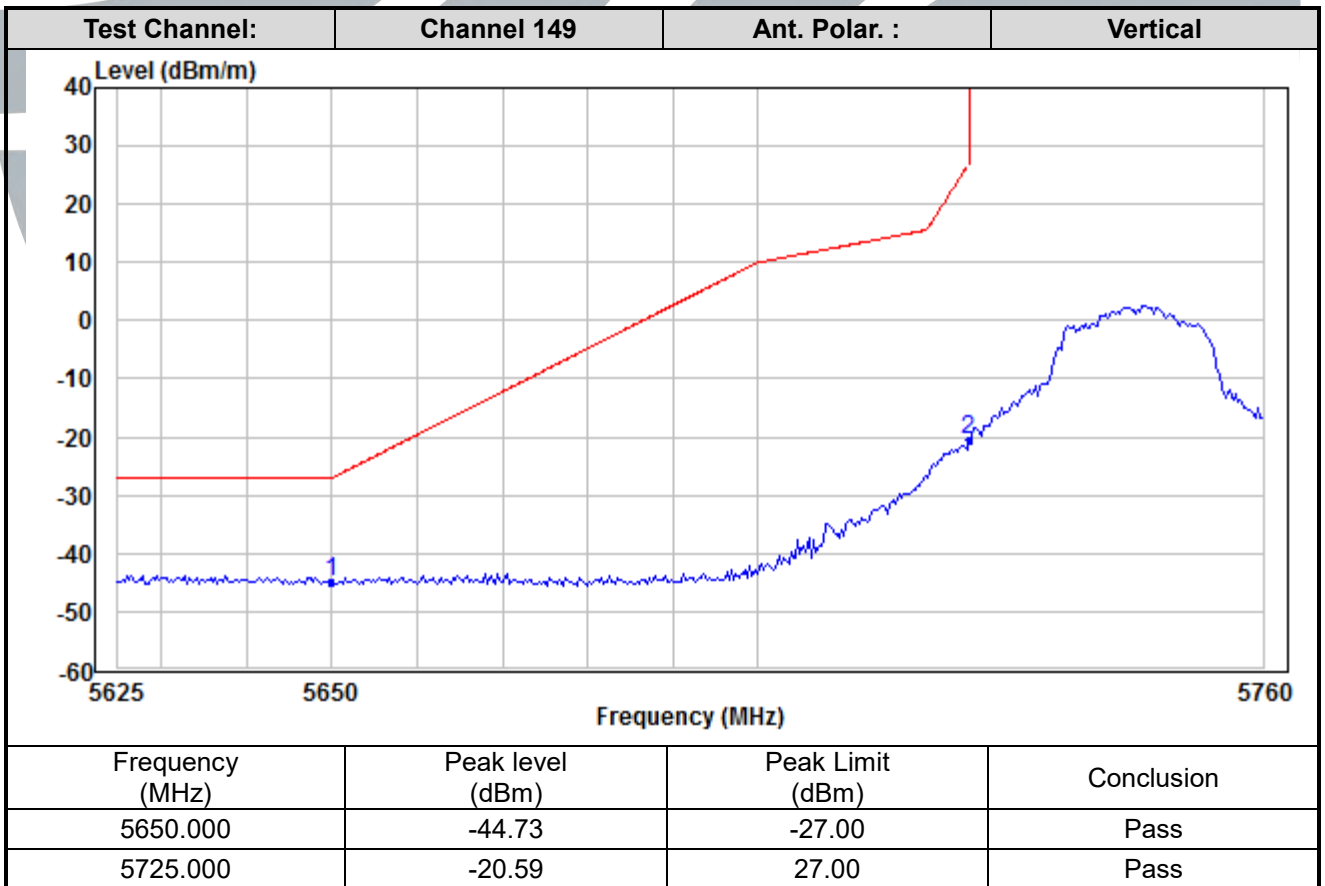
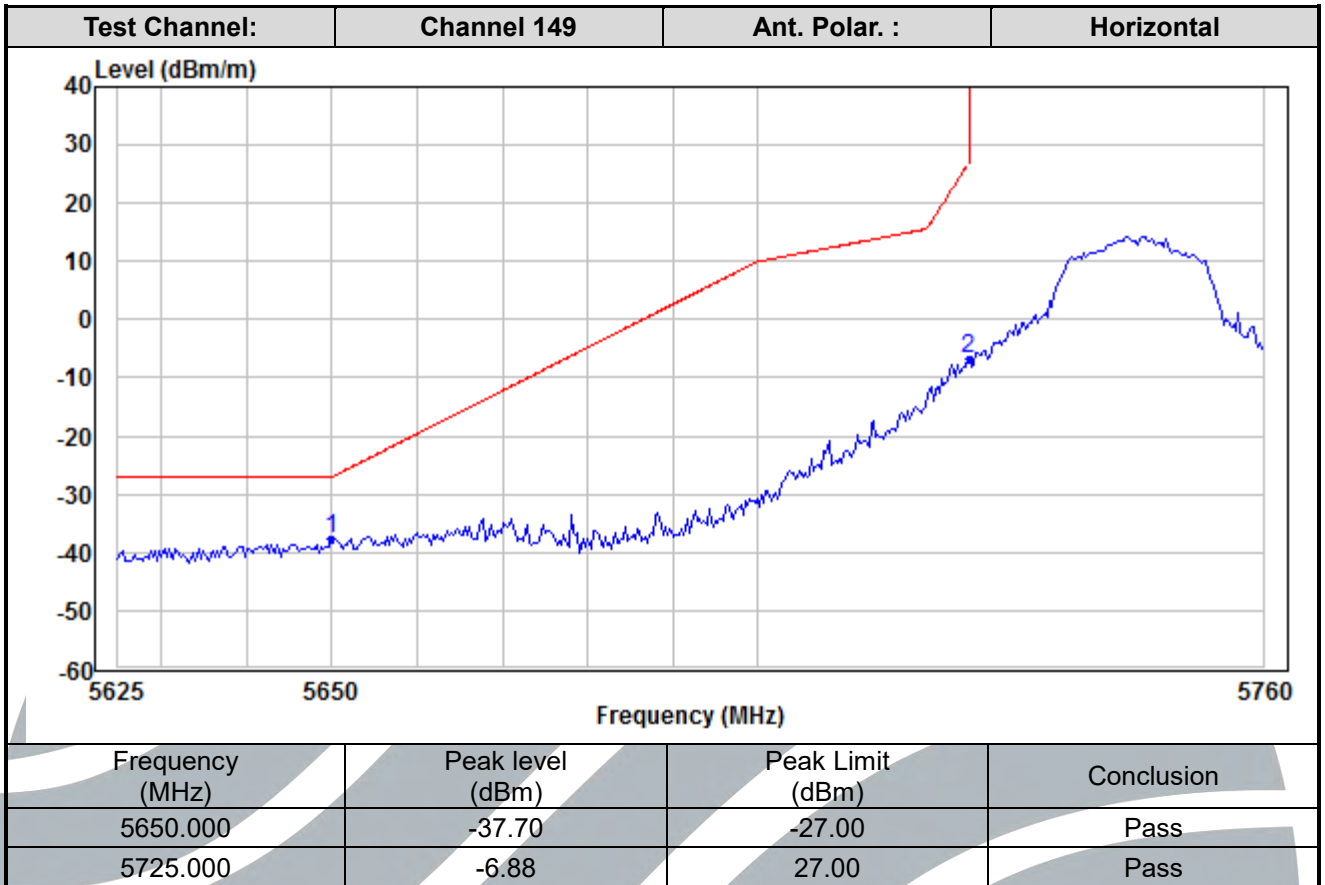

**Shenzhen UnionTrust Quality and Technology Co., Ltd.**

Address: Unit D/E of 9/F and 16/F, Block A, Building 6, Baoneng science and technology park, Longhua district, Shenzhen, China

Tel: +86-755-28230888

Fax: +86-755-28230886

E-mail: info@uttlab.com

<http://www.uttlab.com>

UTTR-RF-RSS247-V1.1

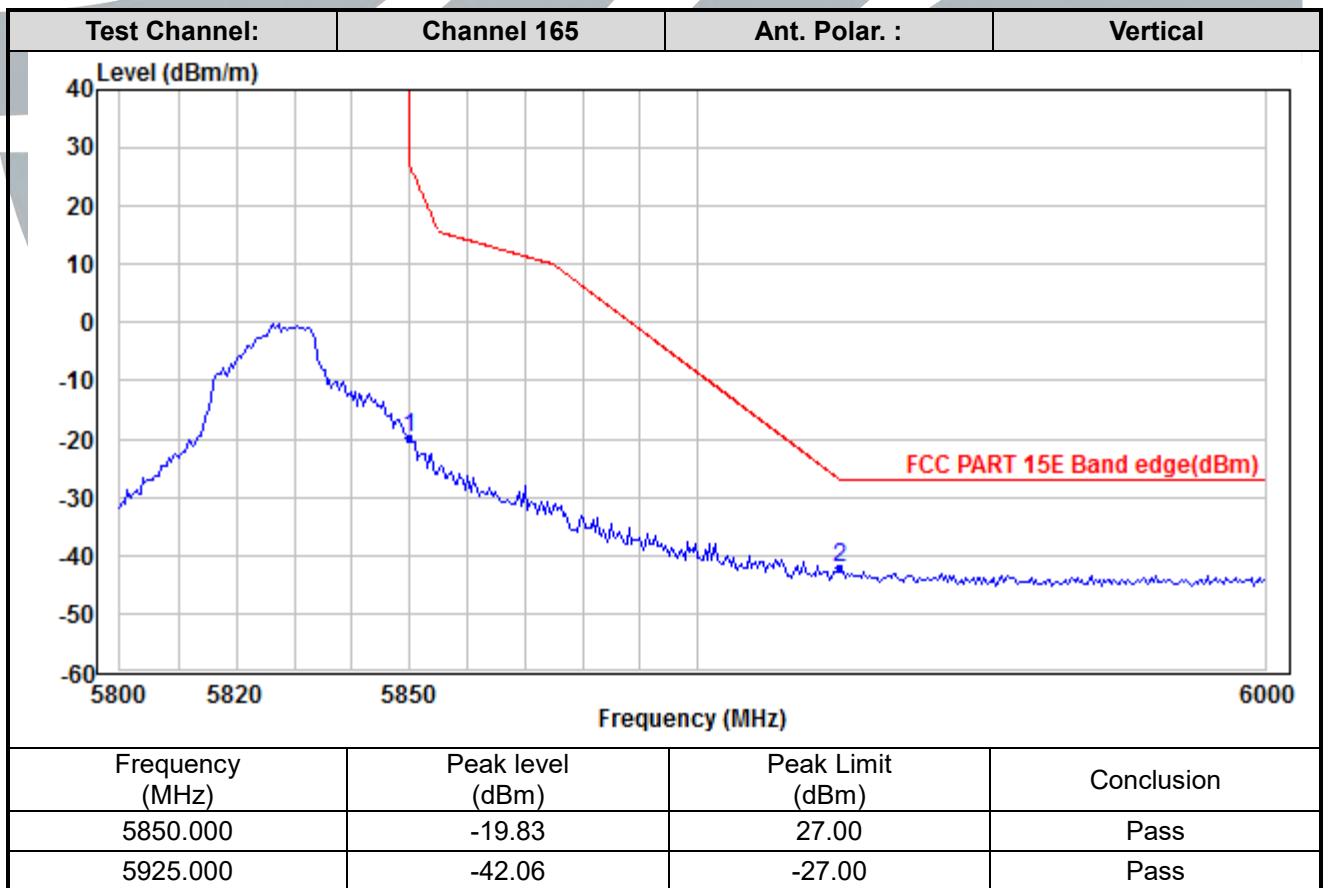
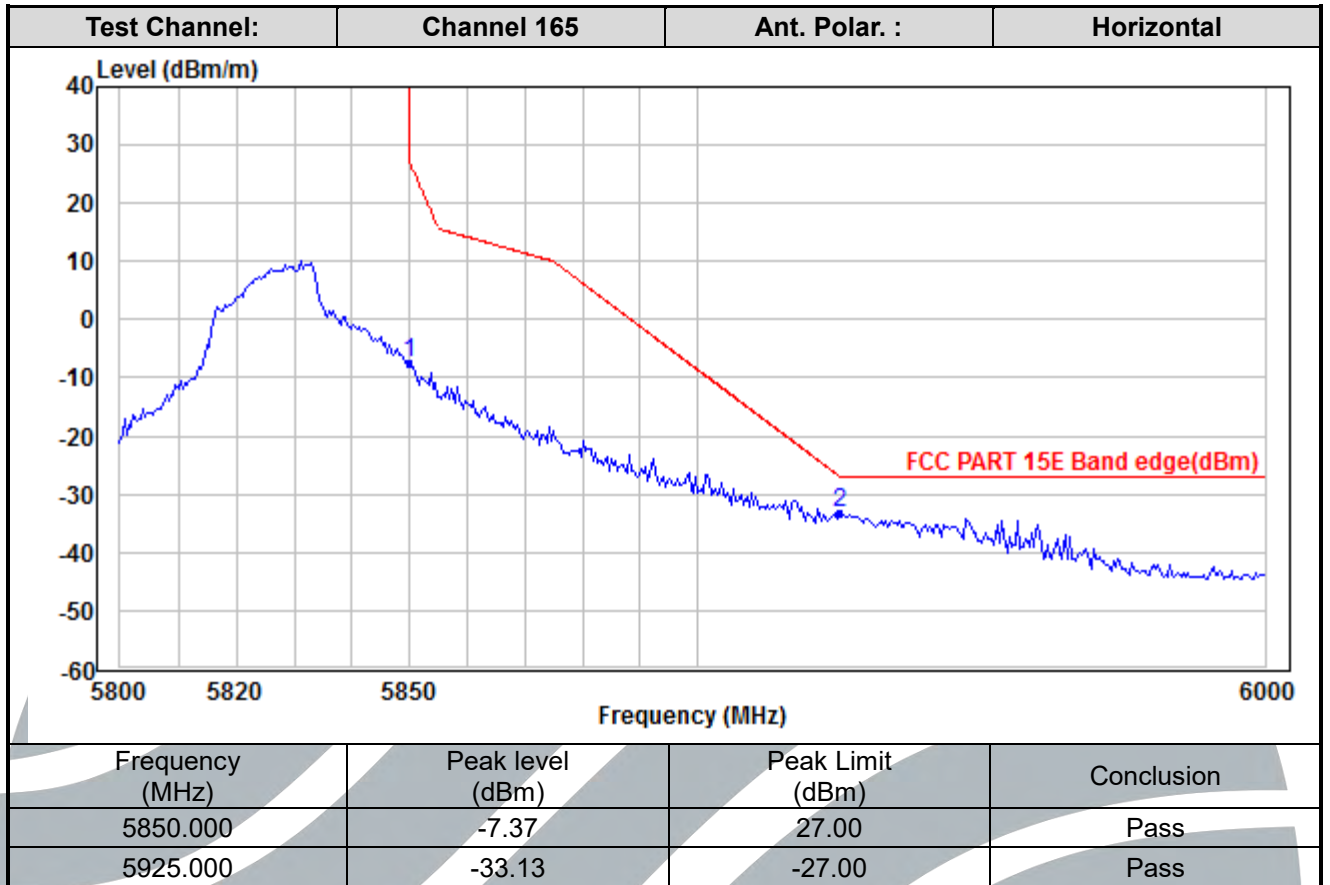

**Shenzhen UnionTrust Quality and Technology Co., Ltd.**

Address: Unit D/E of 9/F and 16/F, Block A, Building 6, Baoneng science and technology park, Longhua district, Shenzhen, China

Tel: +86-755-28230888

Fax: +86-755-28230886

E-mail: info@uttlab.com

<http://www.uttlab.com>

UTTR-RF-RSS247-V1.1

IEEE 802.11n-HT40

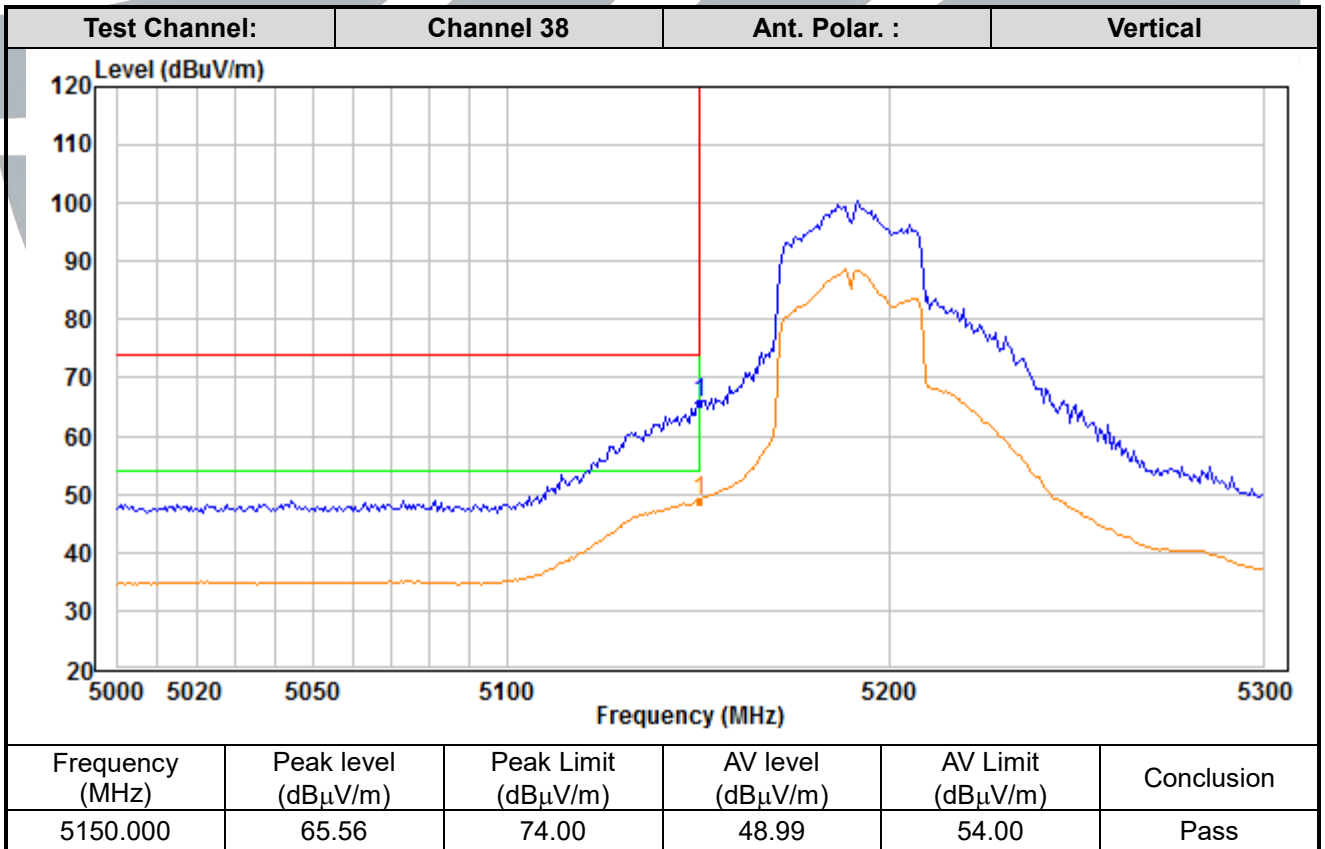
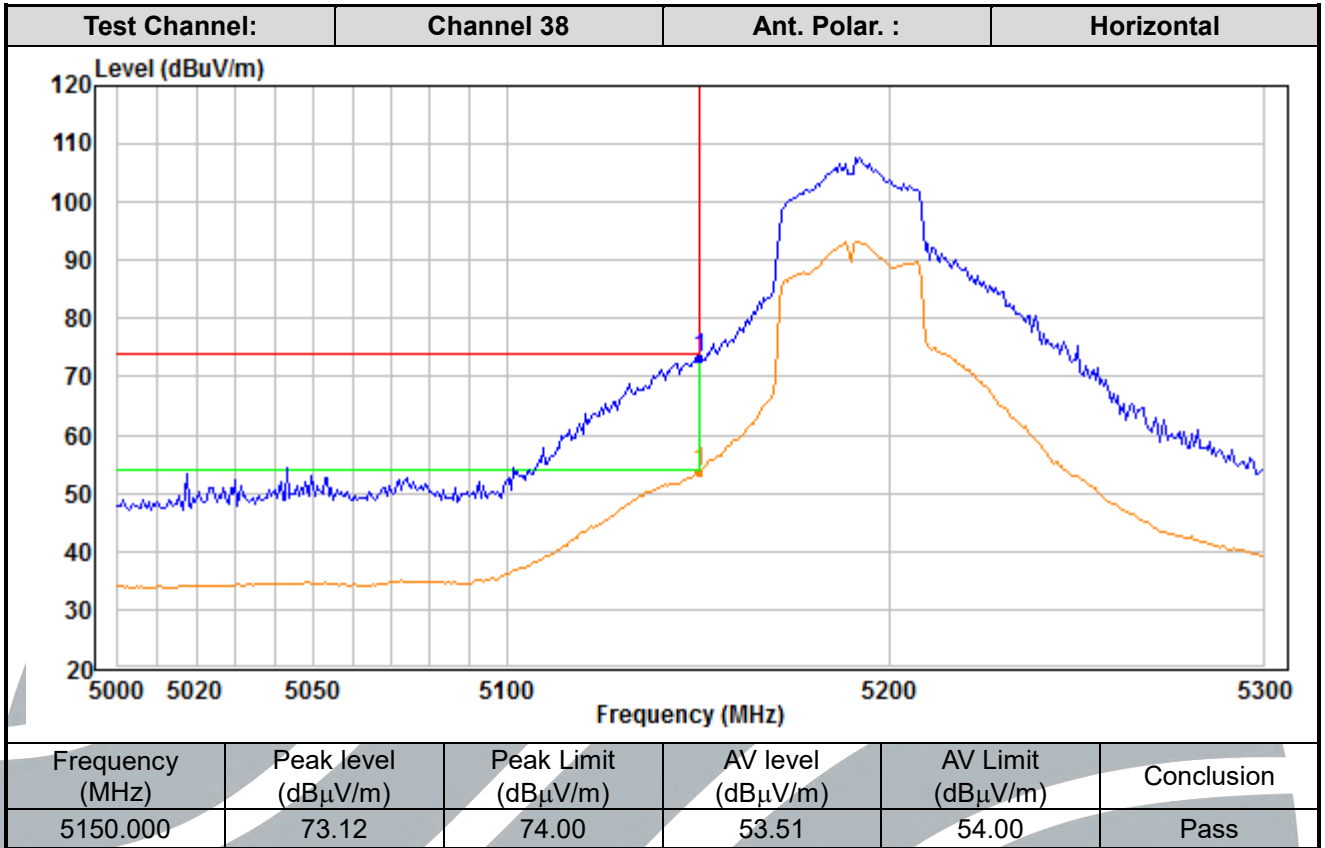

**Shenzhen UnionTrust Quality and Technology Co., Ltd.**

Address: Unit D/E of 9/F and 16/F, Block A, Building 6, Baoneng science and technology park, Longhua district, Shenzhen, China

Tel: +86-755-28230888

Fax: +86-755-28230886

E-mail: info@uttlab.com

<http://www.uttlab.com>

UTTR-RF-RSS247-V1.1

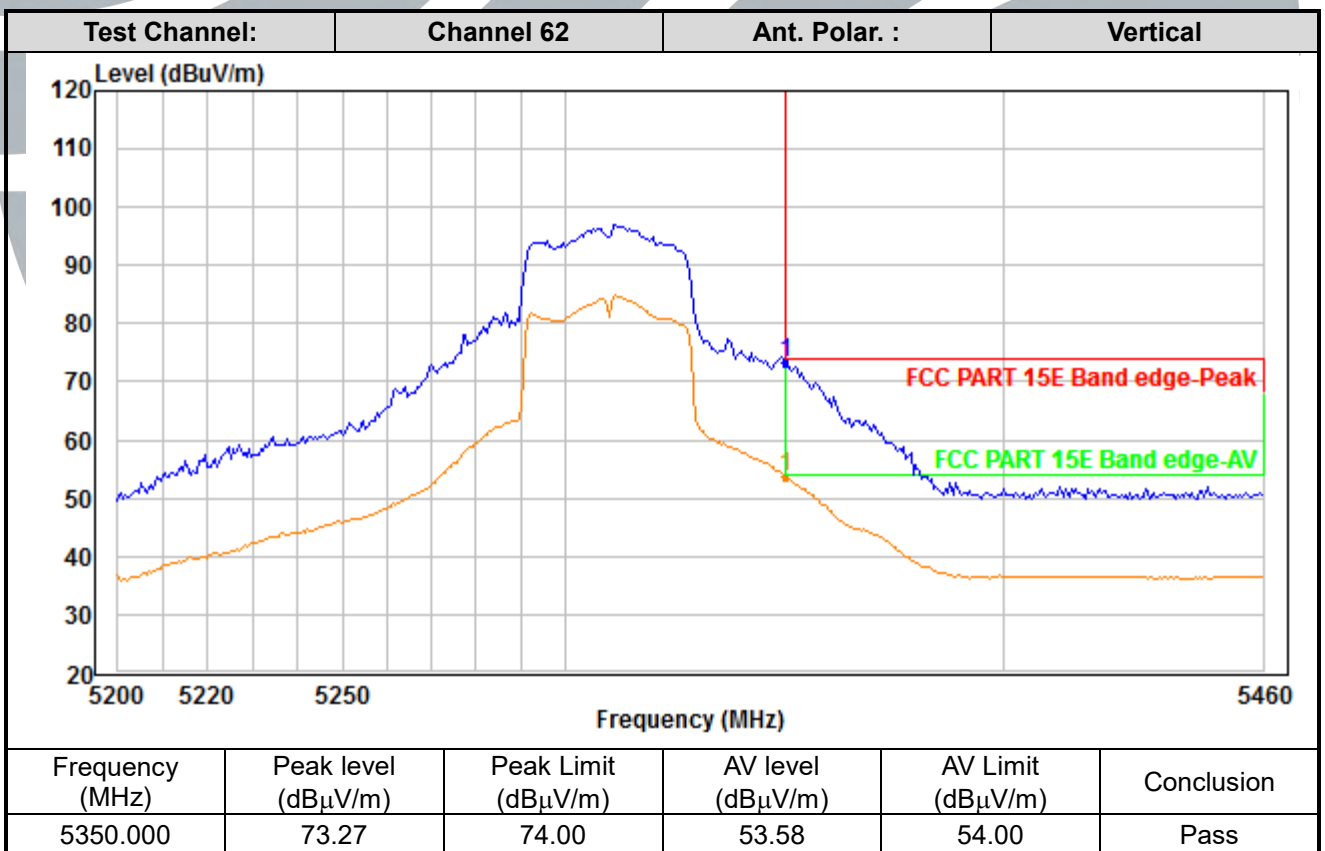
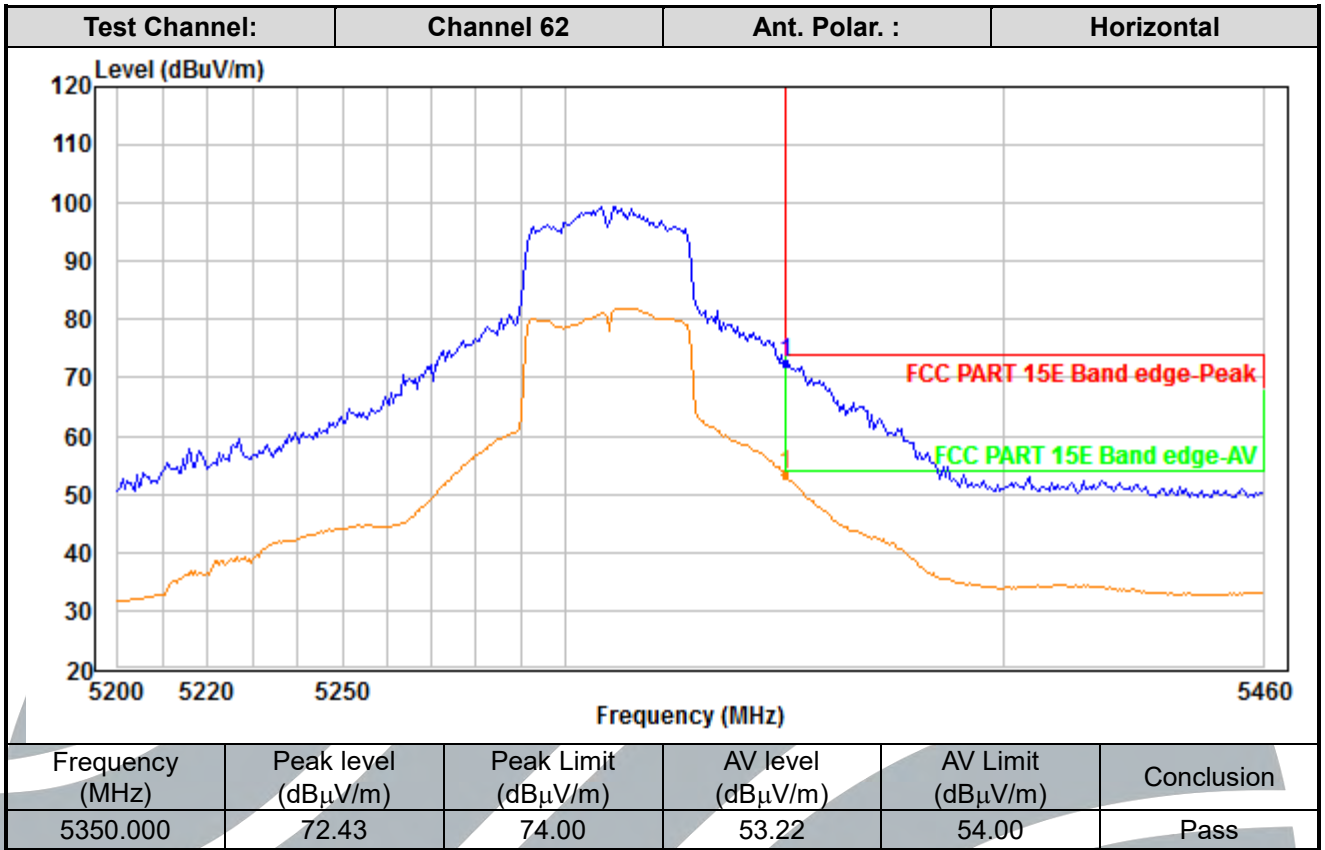

**Shenzhen UnionTrust Quality and Technology Co., Ltd.**

Address: Unit D/E of 9/F and 16/F, Block A, Building 6, Baoneng science and technology park, Longhua district, Shenzhen, China

Tel: +86-755-28230888

Fax: +86-755-28230886

E-mail: info@uttlab.com

<http://www.uttlab.com>

UTTR-RF-RSS247-V1.1

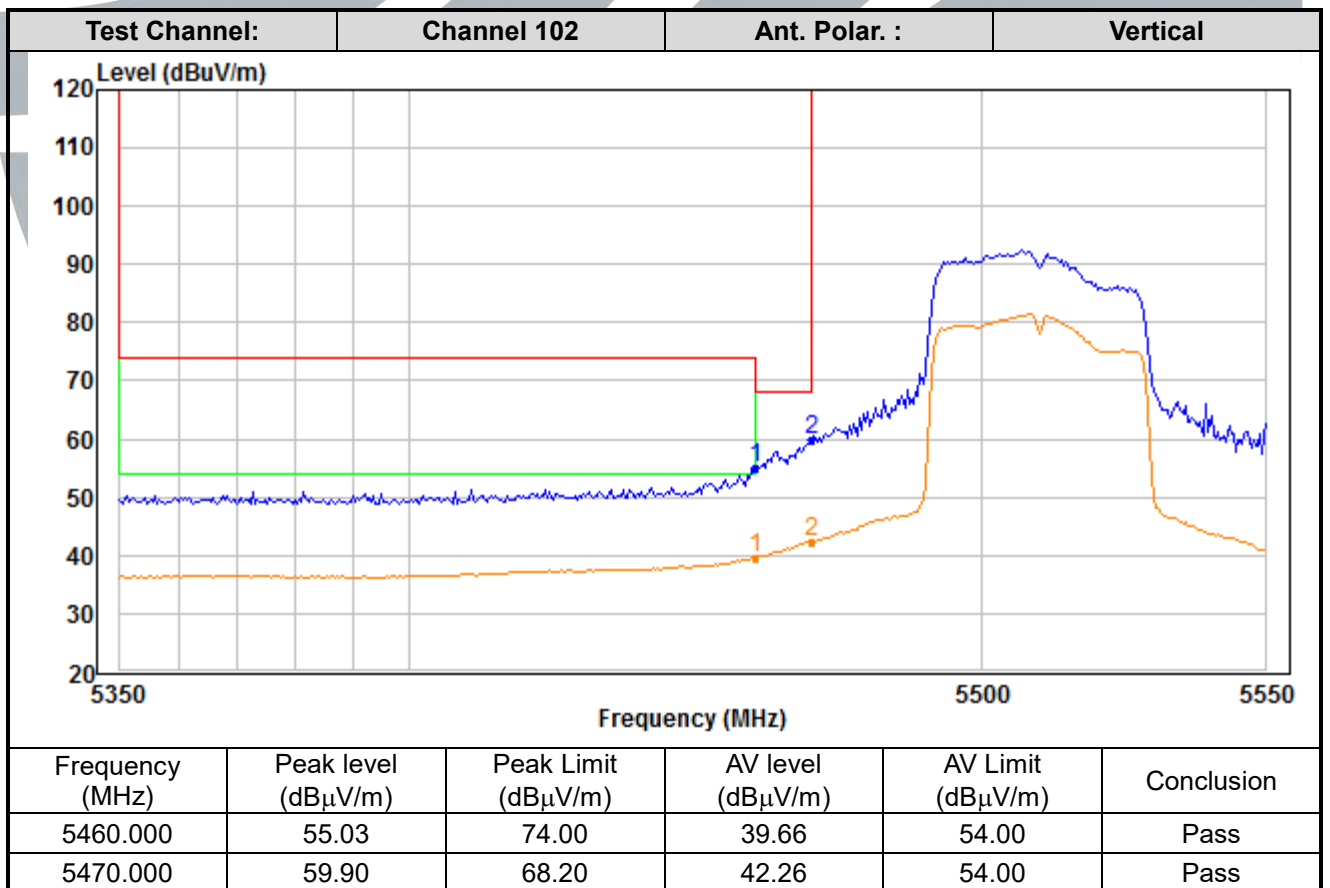
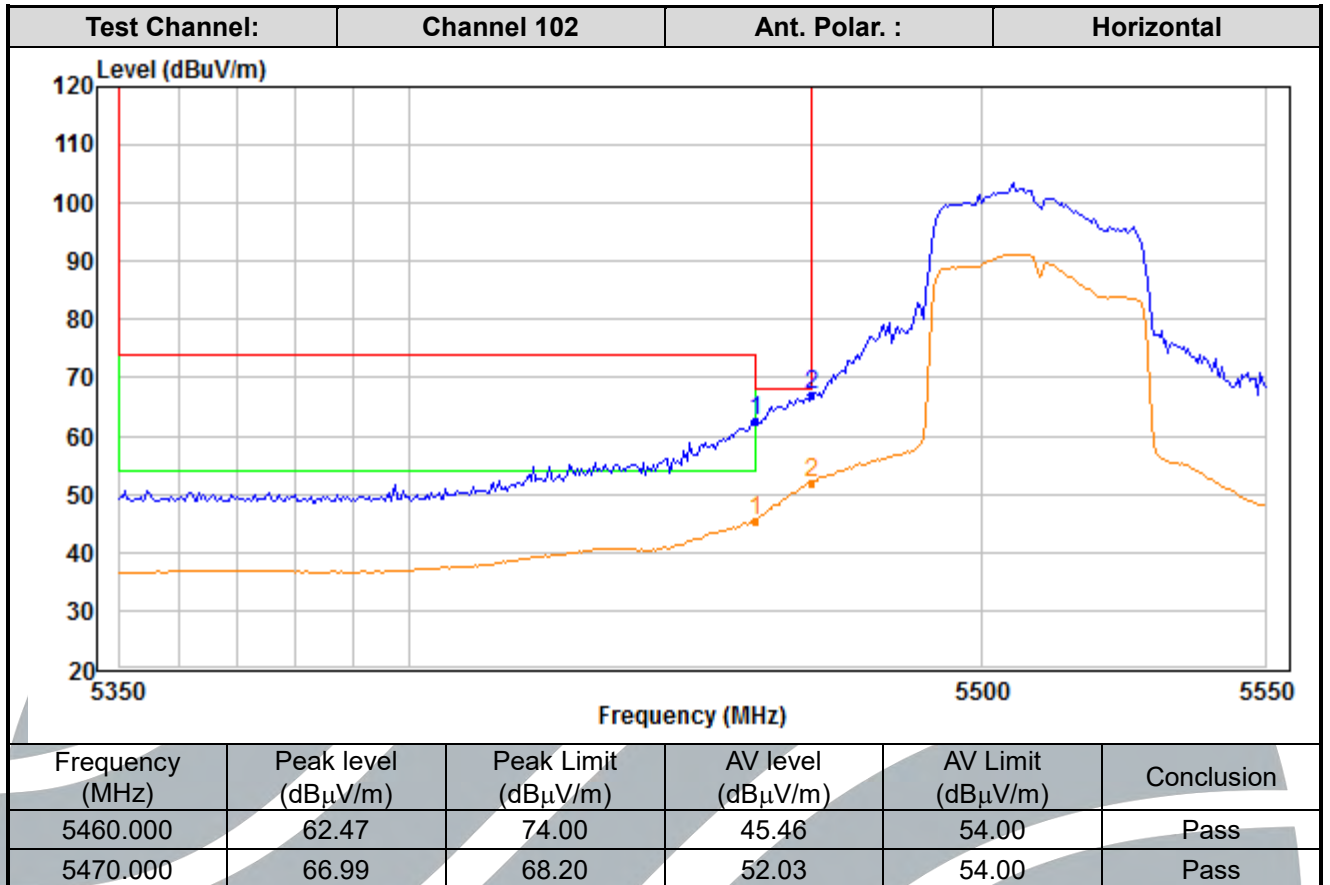

**Shenzhen UnionTrust Quality and Technology Co., Ltd.**

Address: Unit D/E of 9/F and 16/F, Block A, Building 6, Baoneng science and technology park, Longhua district, Shenzhen, China

Tel: +86-755-28230888

Fax: +86-755-28230886

E-mail: info@uttlab.com

<http://www.uttlab.com>

UTTR-RF-RSS247-V1.1



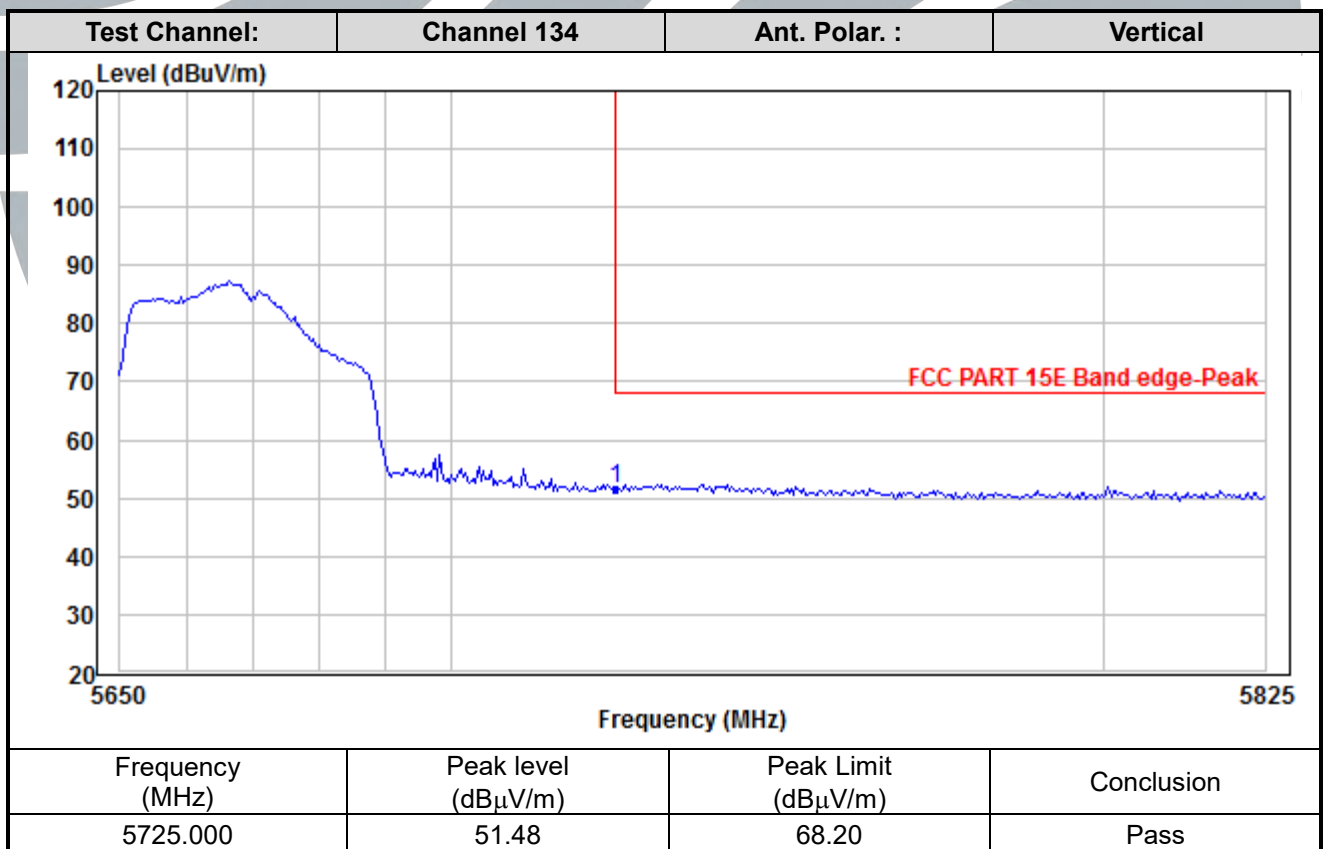
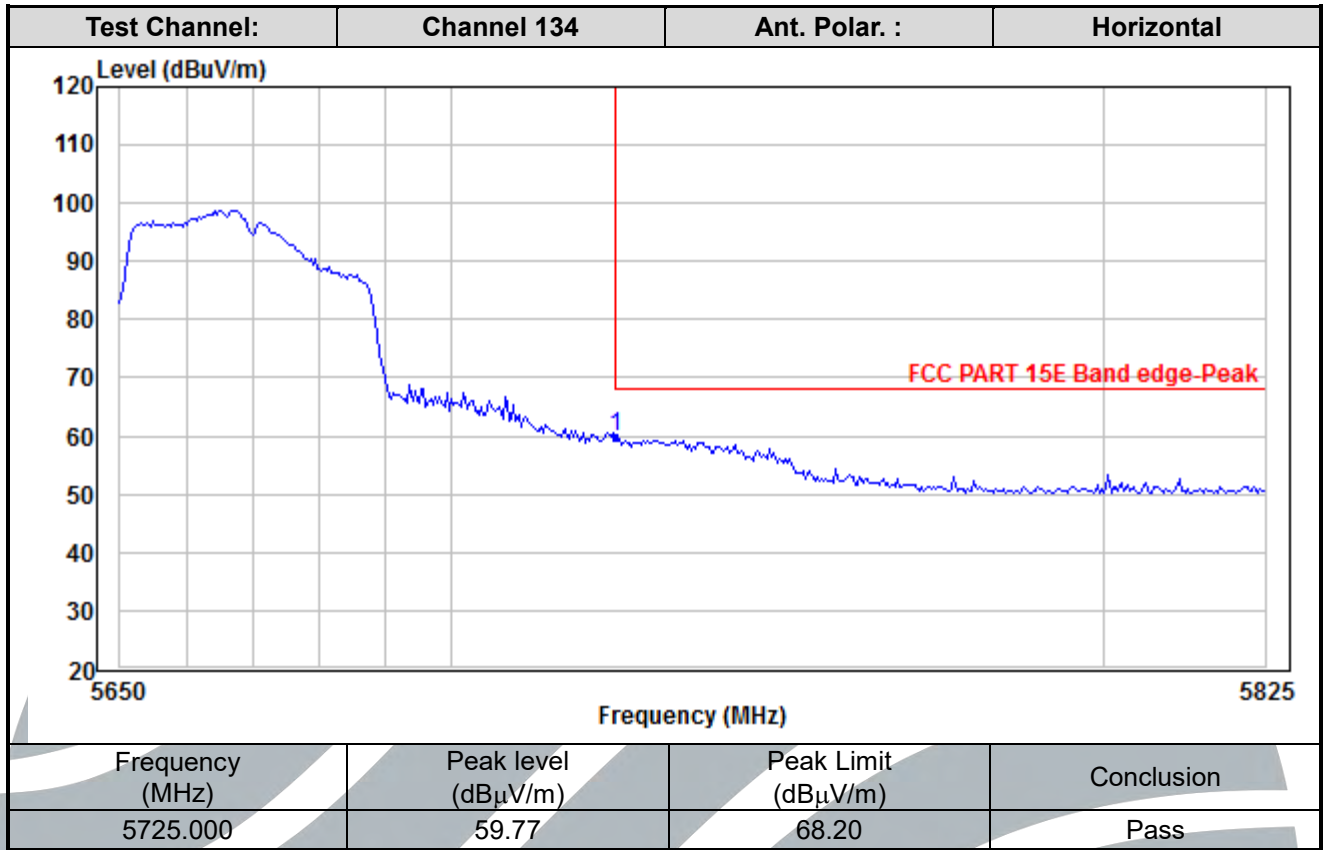

**Shenzhen UnionTrust Quality and Technology Co., Ltd.**

Address: Unit D/E of 9/F and 16/F, Block A, Building 6, Baoneng science and technology park, Longhua district, Shenzhen, China

Tel: +86-755-28230888

Fax: +86-755-28230886

E-mail: info@uttlab.com

<http://www.uttlab.com>

UTTR-RF-RSS247-V1.1

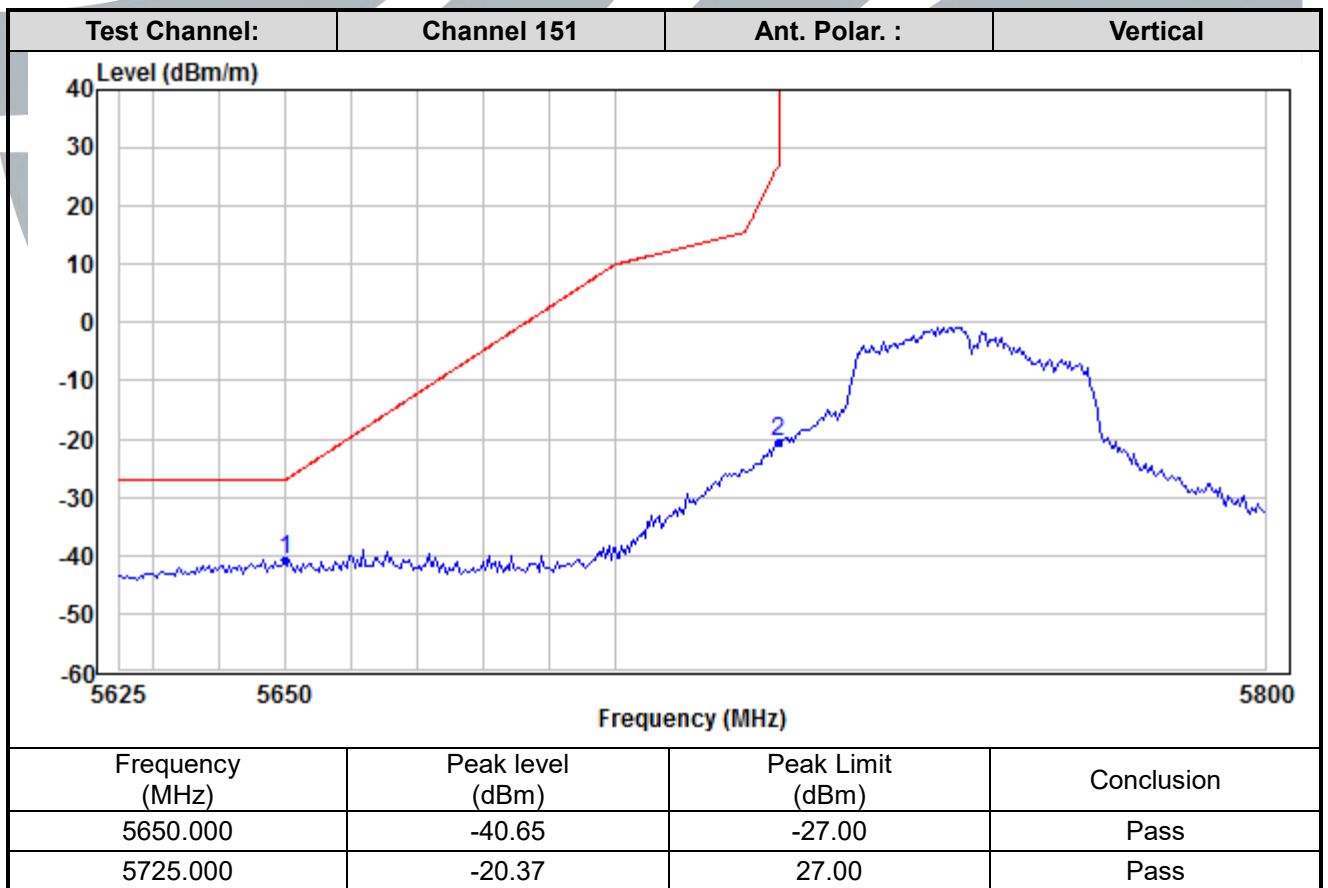
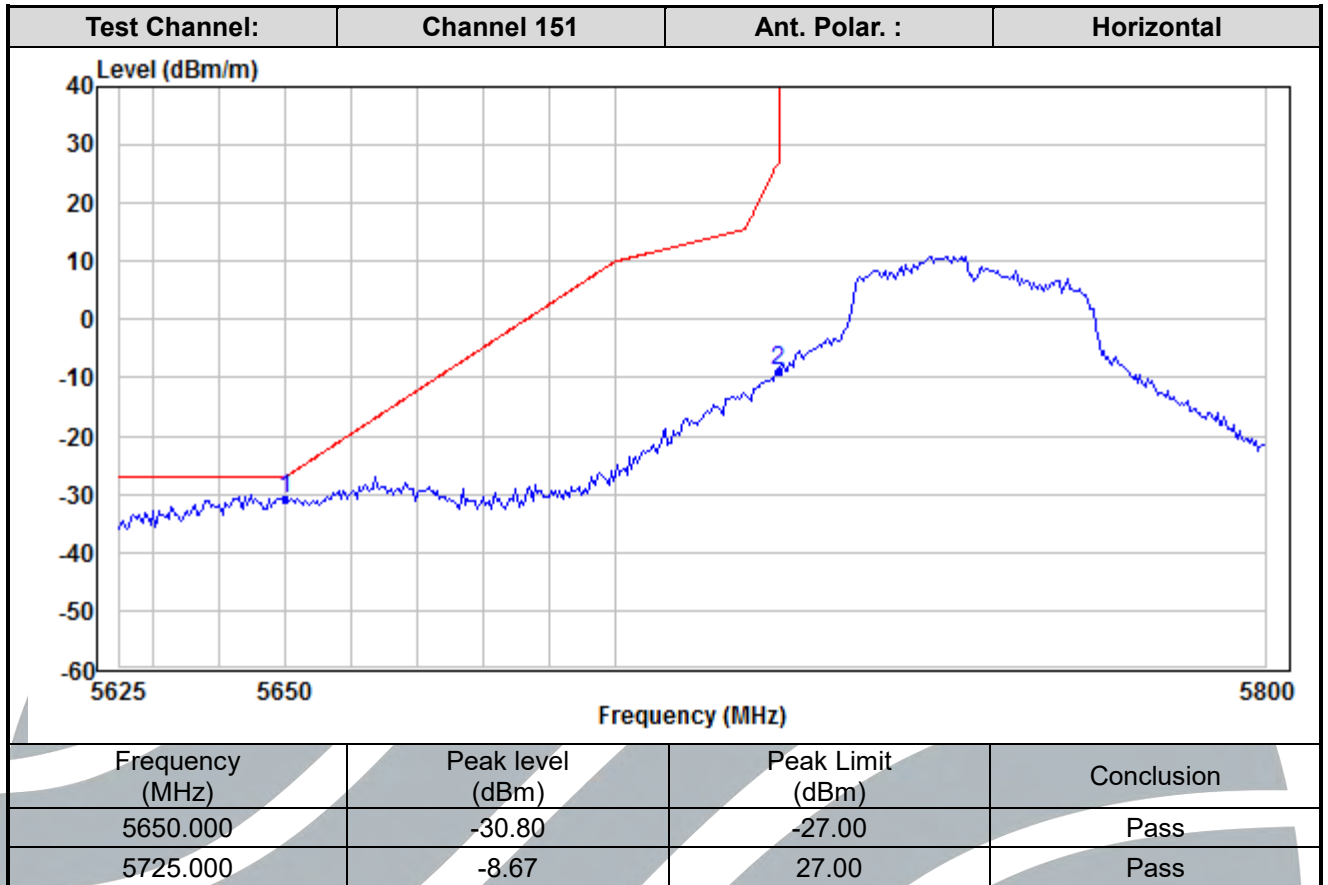

**Shenzhen UnionTrust Quality and Technology Co., Ltd.**

Address: Unit D/E of 9/F and 16/F, Block A, Building 6, Baoneng science and technology park, Longhua district, Shenzhen, China

Tel: +86-755-28230888

Fax: +86-755-28230886

E-mail: info@uttlab.com

<http://www.uttlab.com>

UTTR-RF-RSS247-V1.1

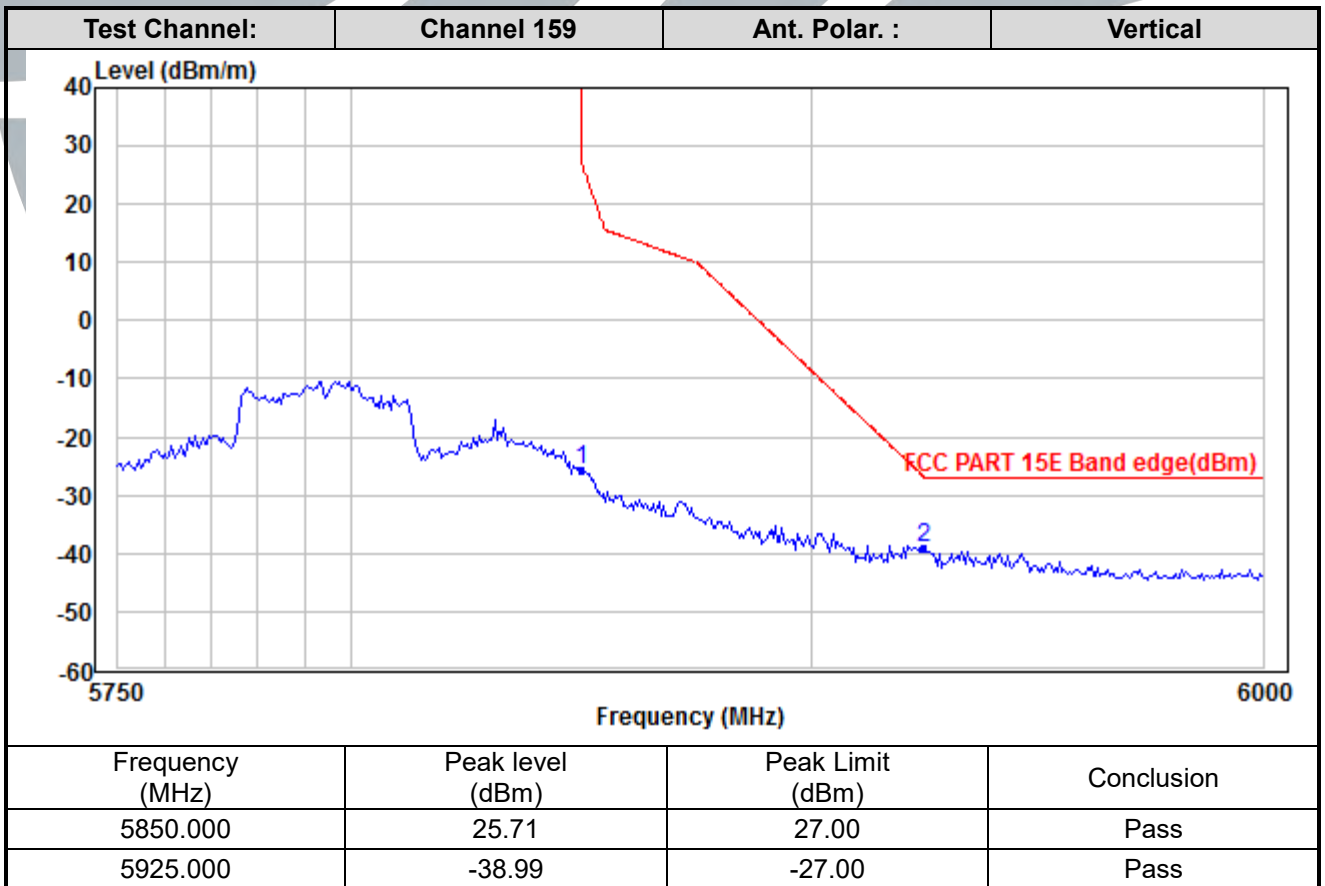
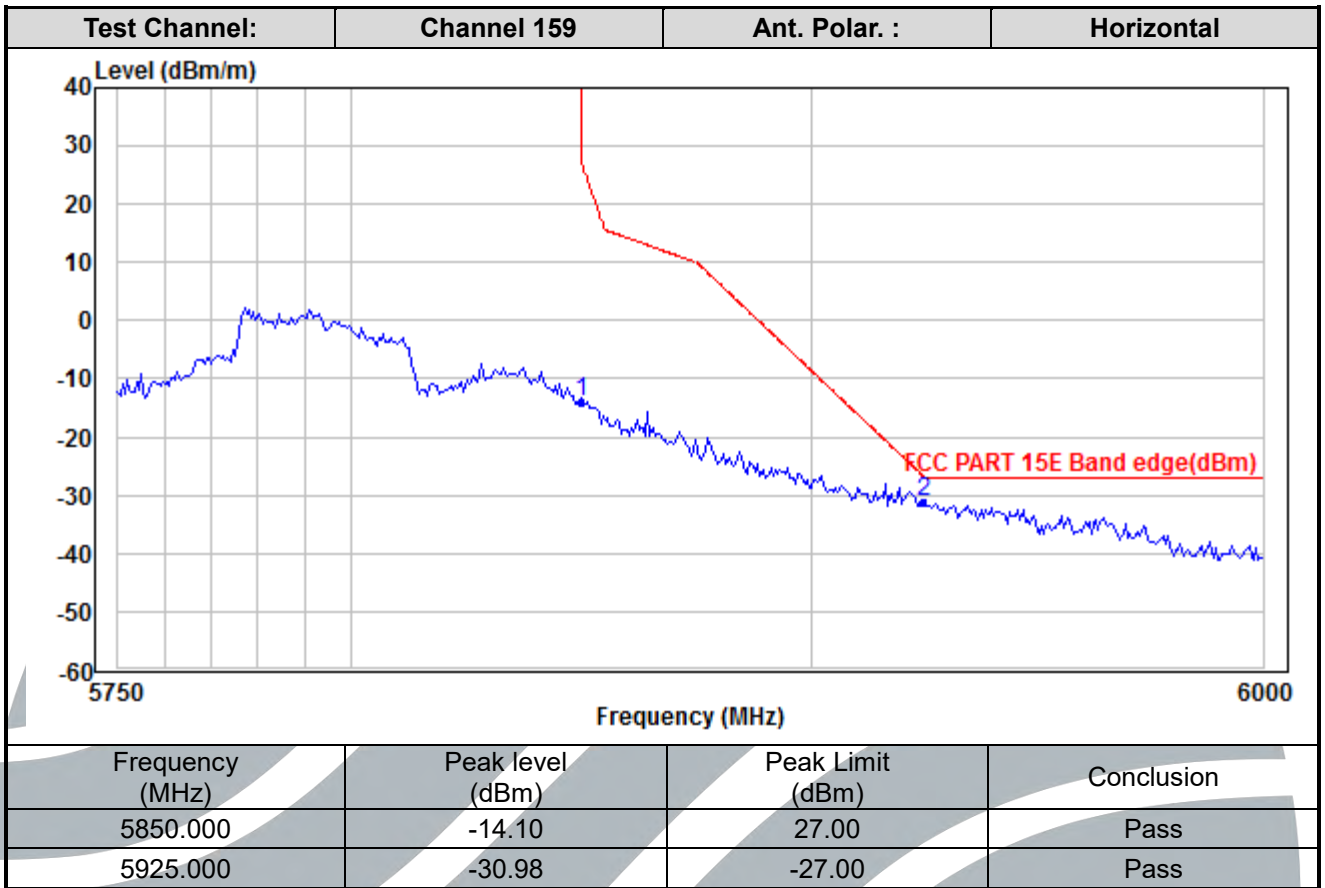

**Shenzhen UnionTrust Quality and Technology Co., Ltd.**

Address: Unit D/E of 9/F and 16/F, Block A, Building 6, Baoneng science and technology park, Longhua district, Shenzhen, China

Tel: +86-755-28230888

Fax: +86-755-28230886

E-mail: info@uttlab.com

<http://www.uttlab.com>

UTTR-RF-RSS247-V1.1

IEEE 802.11ac-VHT80

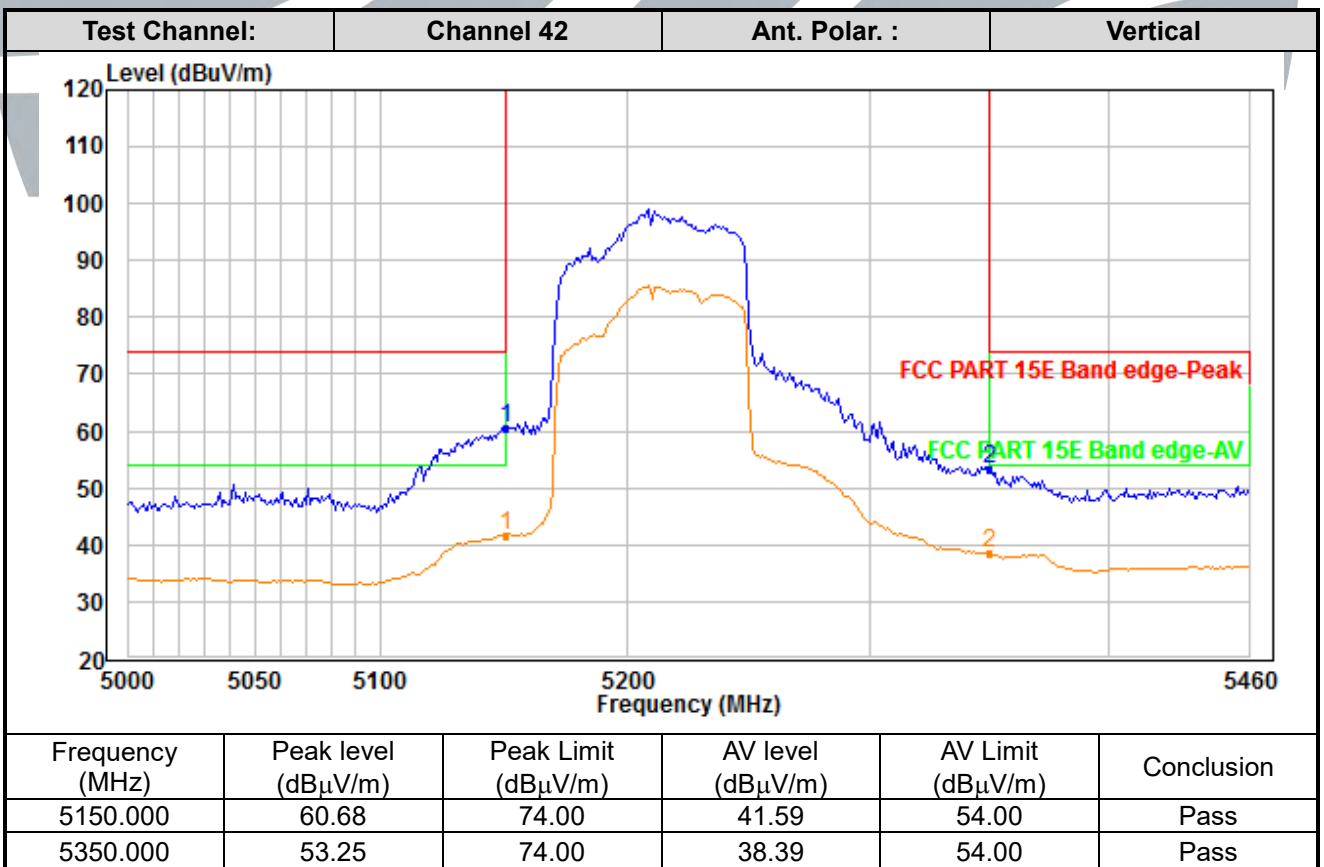
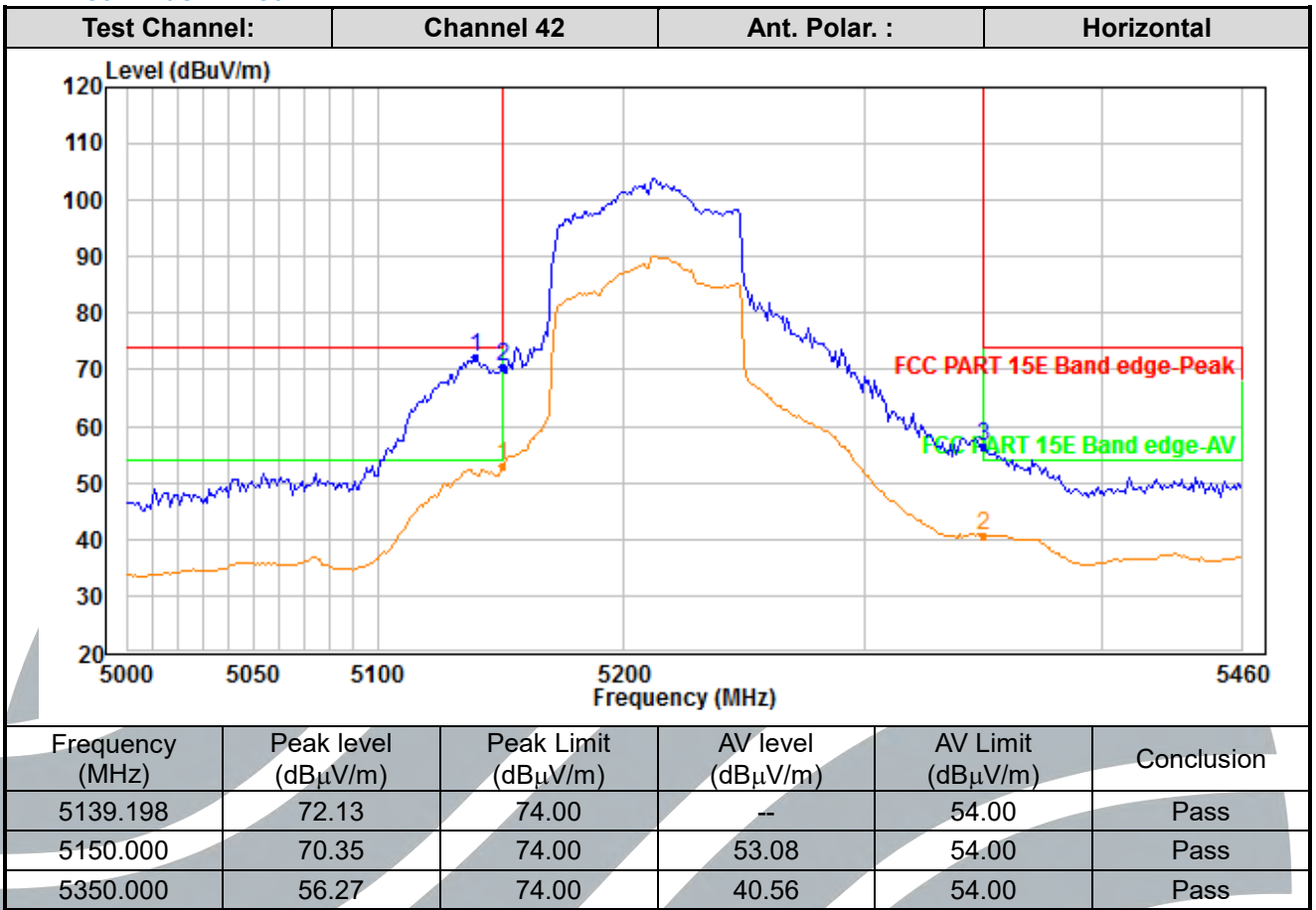

**Shenzhen UnionTrust Quality and Technology Co., Ltd.**

Address: Unit D/E of 9/F and 16/F, Block A, Building 6, Baoneng science and technology park, Longhua district, Shenzhen, China

Tel: +86-755-28230888

Fax: +86-755-28230886

E-mail: info@uttlab.com

<http://www.uttlab.com>

UTTR-RF-RSS247-V1.1

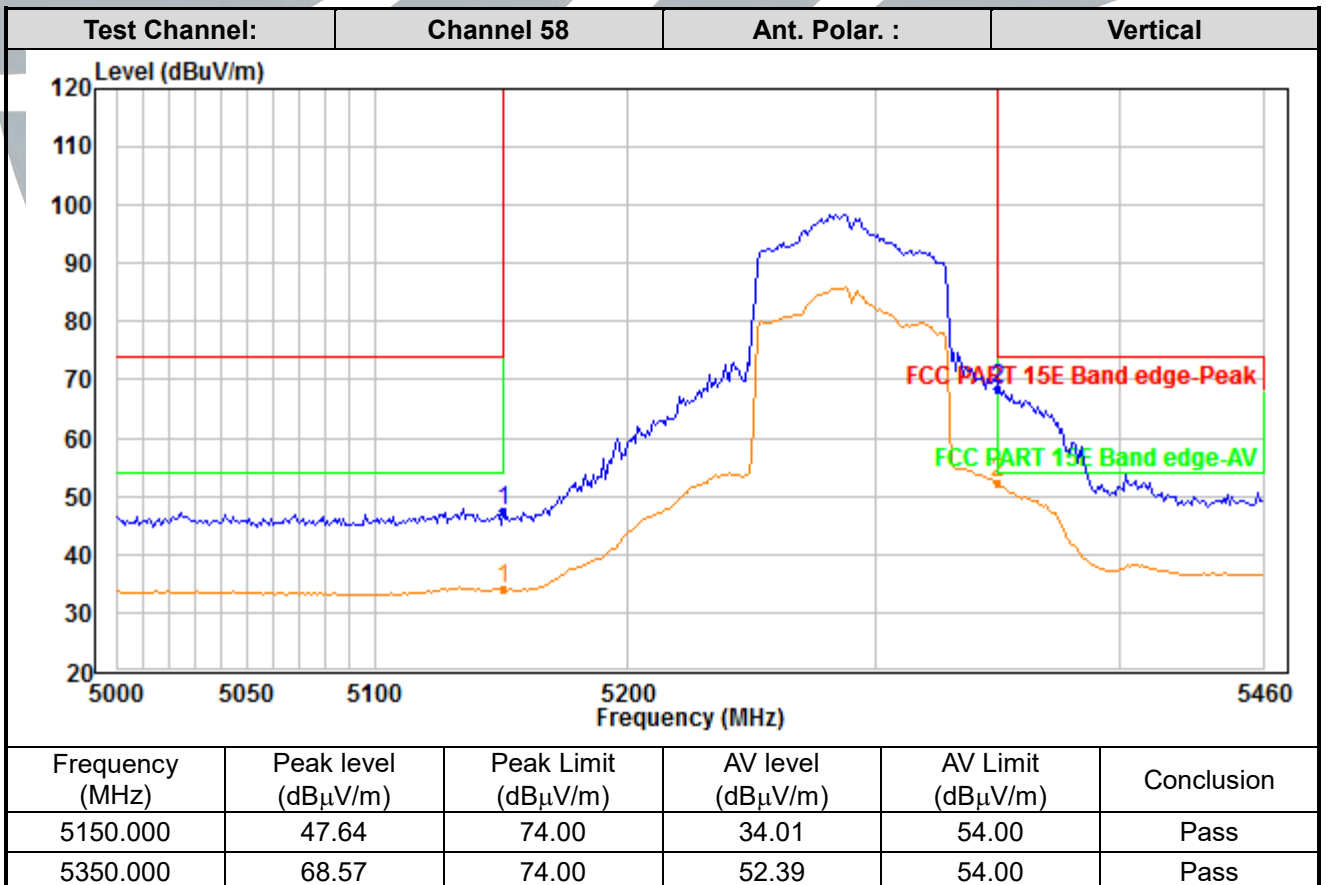
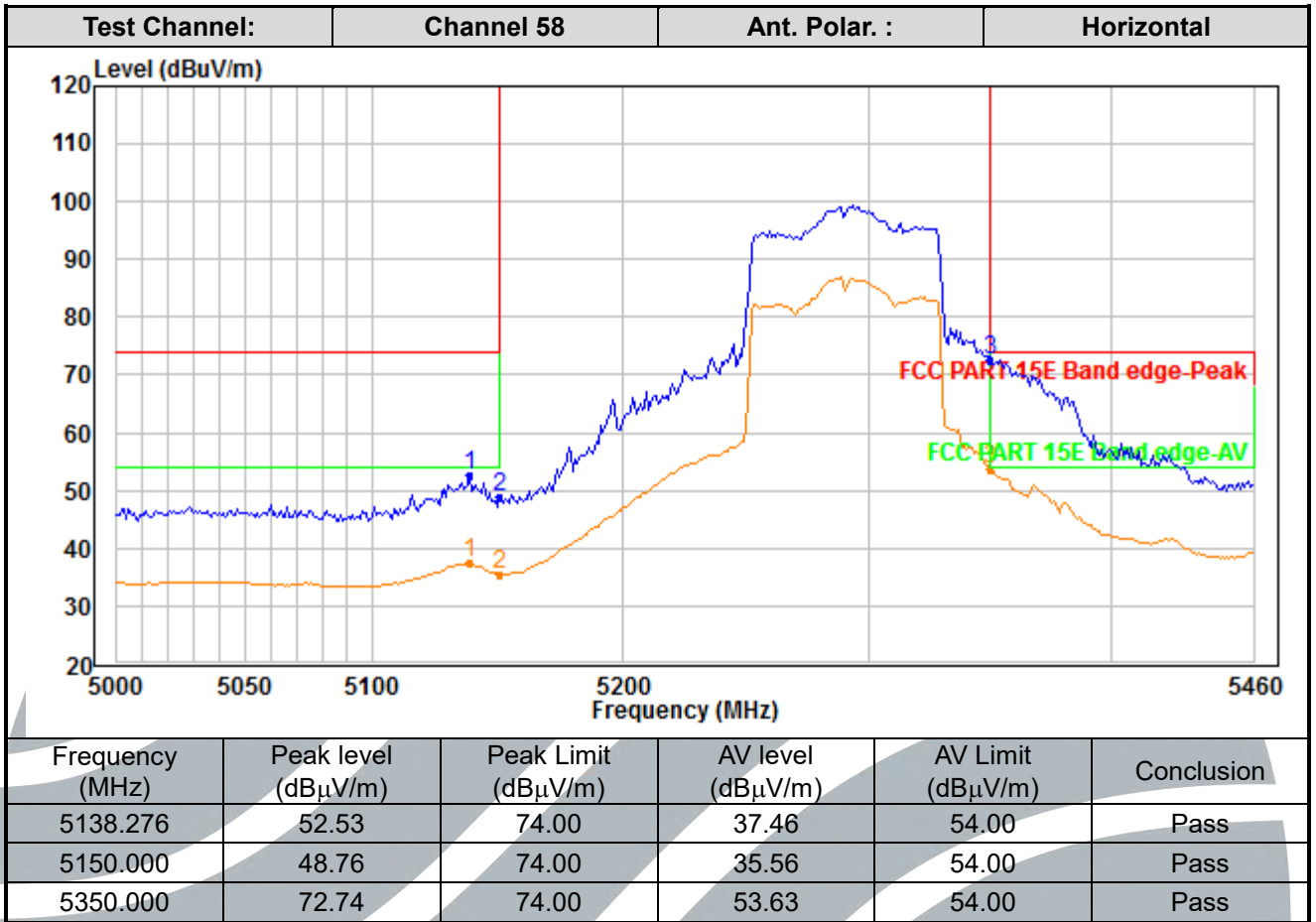

**Shenzhen UnionTrust Quality and Technology Co., Ltd.**

Address: Unit D/E of 9/F and 16/F, Block A, Building 6, Baoneng science and technology park, Longhua district, Shenzhen, China

Tel: +86-755-28230888

Fax: +86-755-28230886

E-mail: info@uttlab.com

<http://www.uttlab.com>

UTTR-RF-RSS247-V1.1

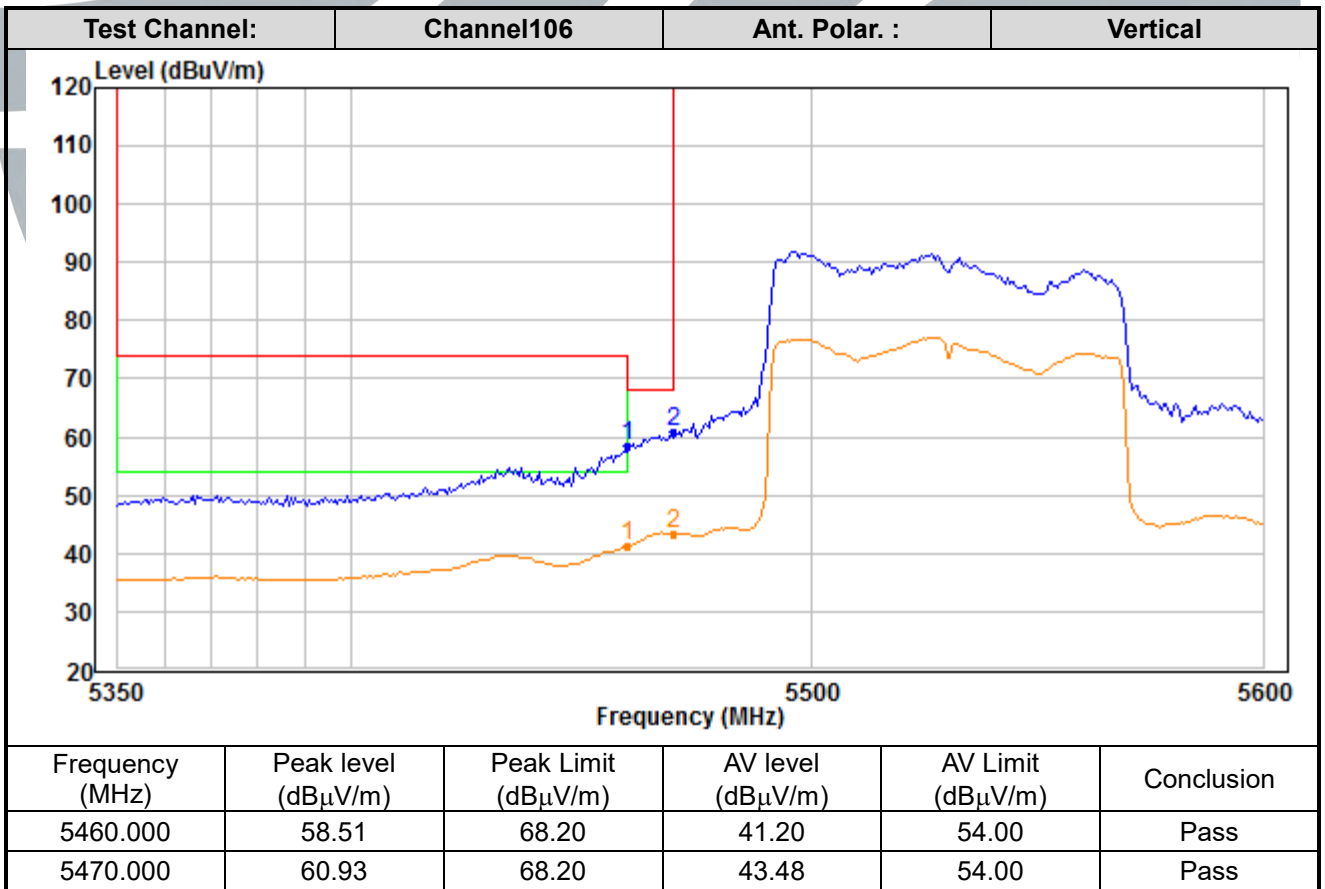
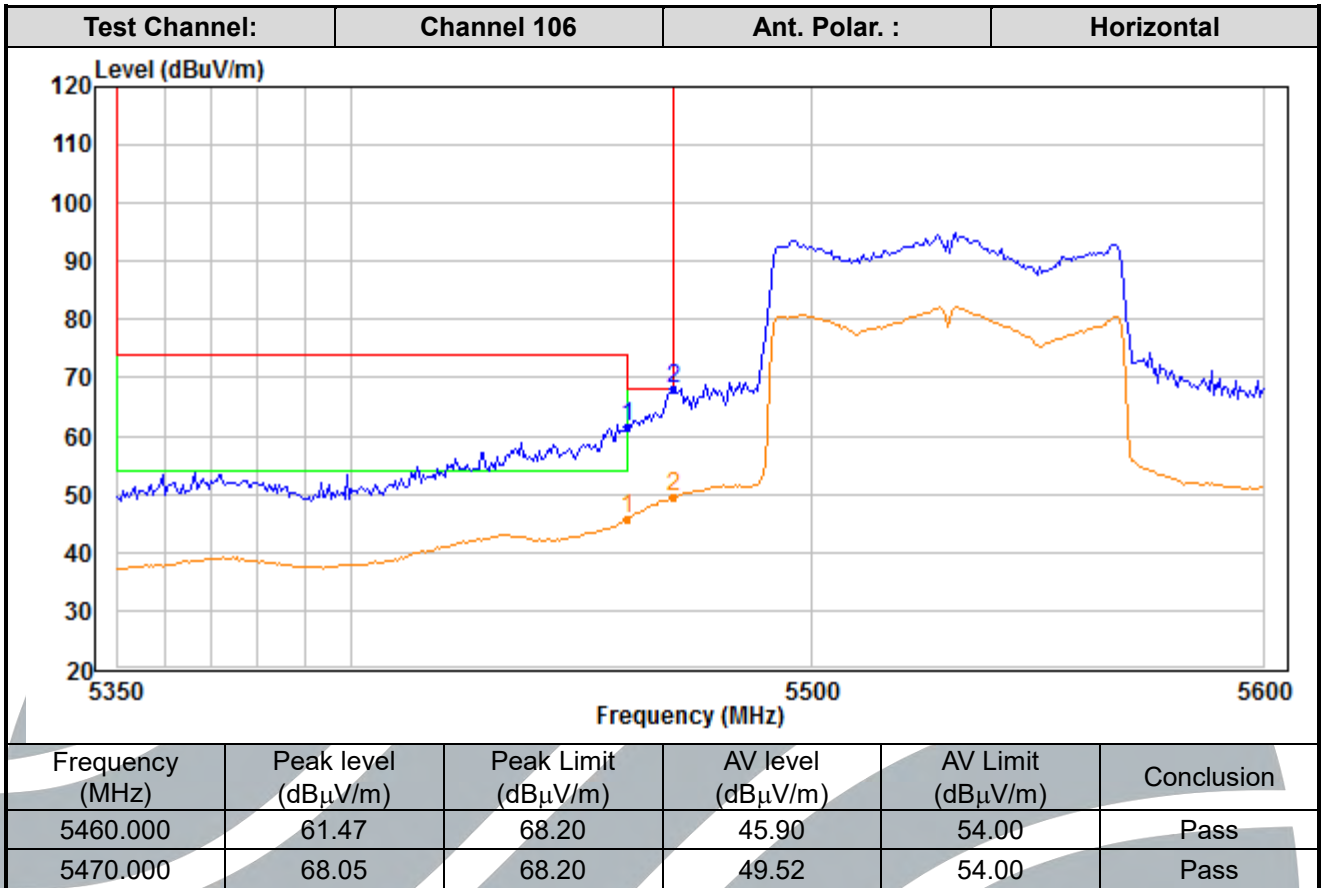

**Shenzhen UnionTrust Quality and Technology Co., Ltd.**

Address: Unit D/E of 9/F and 16/F, Block A, Building 6, Baoneng science and technology park, Longhua district, Shenzhen, China

Tel: +86-755-28230888

Fax: +86-755-28230886

E-mail: info@uttlab.com

<http://www.uttlab.com>

UTTR-RF-RSS247-V1.1

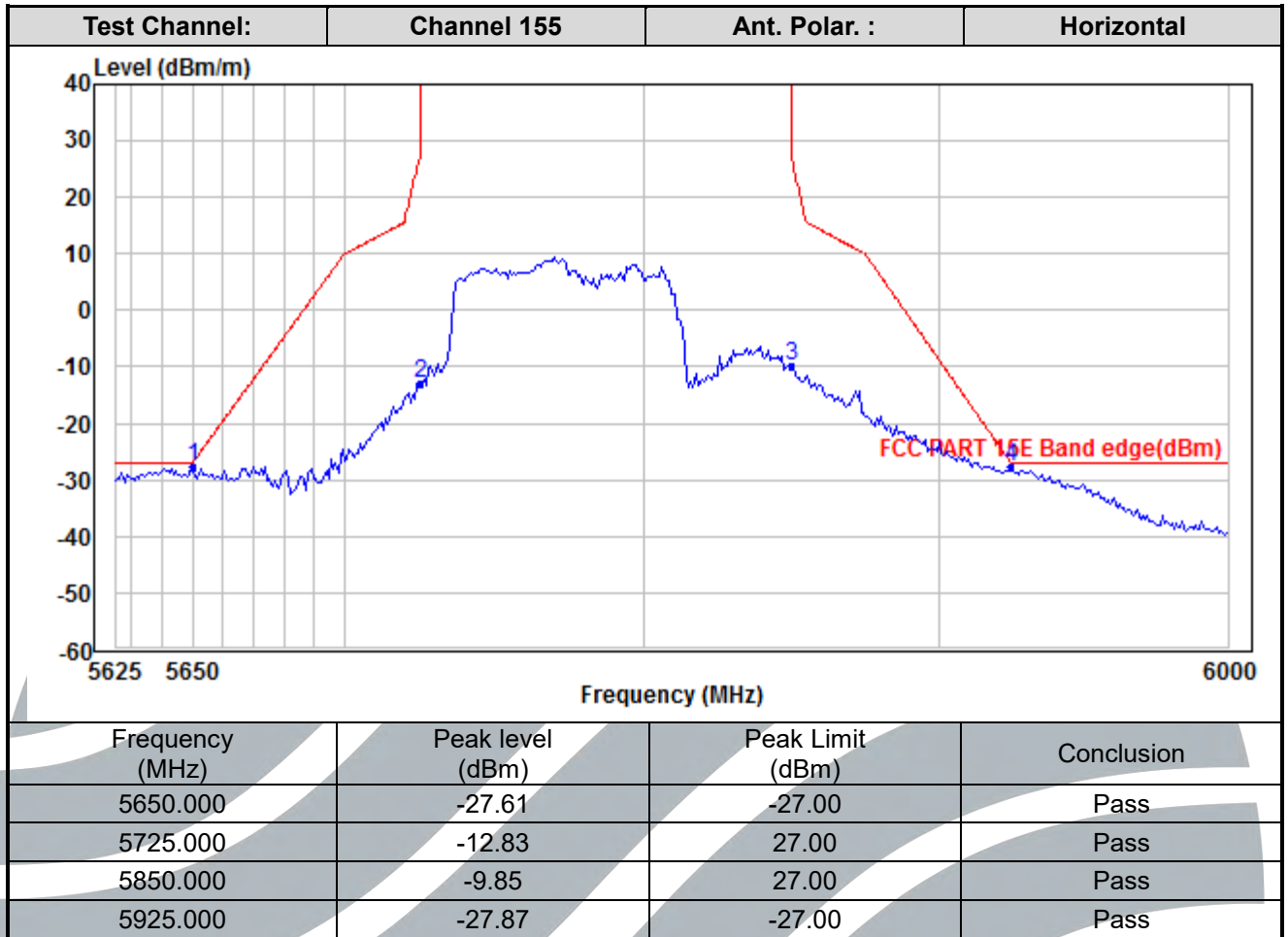

**Shenzhen UnionTrust Quality and Technology Co., Ltd.**

Address: Unit D/E of 9/F and 16/F, Block A, Building 6, Baoneng science and technology park, Longhua district, Shenzhen, China

Tel: +86-755-28230888

Fax: +86-755-28230886

E-mail: info@uttlab.com

<http://www.uttlab.com>

UTTR-RF-RSS247-V1.1

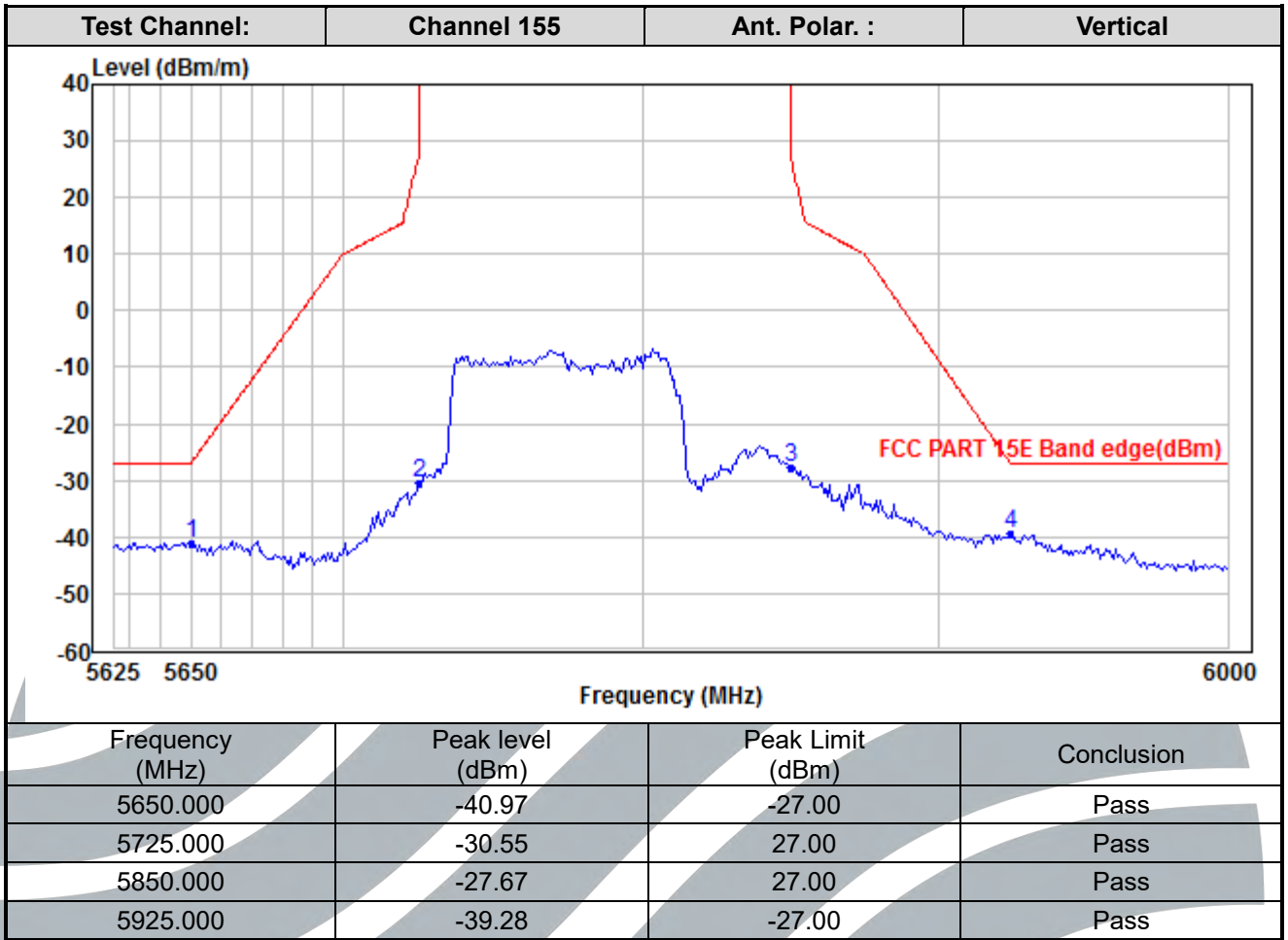

**Shenzhen UnionTrust Quality and Technology Co., Ltd.**

Address: Unit D/E of 9/F and 16/F, Block A, Building 6, Baoneng science and technology park, Longhua district, Shenzhen, China

Tel: +86-755-28230888

Fax: +86-755-28230886

E-mail: info@uttlab.com

<http://www.uttlab.com>

UTTR-RF-RSS247-V1.1



### 5.8 DYNAMIC FREQUENCY SELECTION

**Test Requirement:** FCC 47 CFR Part 15 Subpart E Section 15.407 (h)  
RSS-247 Issue 2 Section 6.3

**Test Method:** KDB 905462 D03 Client Without DFS New Rules v01r02

**EUT Operating Mode:**

DFS Operational mode	Operating Frequency Range	
	5250 MHz to 5350 MHz	5470 MHz to 5725 MHz
Slave without radar Interference detection function	✓	✓

**Applicability:**

The following table from KDB905462 and the lists of the applicable requirements for the DFS testing.

**Applicability of DFS Requirements Prior to Use of a Channel:**

Requirement	Operational Mode		
	Master	Client Without Radar Detection	Client With Radar Detection
Non-Occupancy Period	✓	Not required	Yes
DFS Detection Threshold	✓	Not required	Yes
Channel Availability Check Time	✓	Not required	Not required
U-NII Detection Bandwidth	✓	Not required	Yes

**Applicability of DFS requirements during normal operation:**

Requirement	Operational Mode	
	Master Device or Client with Radar Detection	Client Without Radar Detection
DFS Detection Threshold	Yes	Not required
Channel Closing Transmission Time	Yes	Yes
Channel Move Time	Yes	Yes
U-NII Detection Bandwidth	Yes	Not required
<b>Additional requirements for devices with multiple bandwidth modes</b>	<b>Master Device or Client with Radar Detection</b>	<b>Client Without Radar Detection</b>
U-NII Detection Bandwidth and Statistical Performance Check	All BW modes must be tested	Not required
Channel Move Time and Channel Closing Transmission Time	Test using widest BW mode available	Test using the widest BW mode available for the link
All other tests	Any single BW mode	Not required
<b>Note:</b> Frequencies selected for statistical performance check (Section 7.8.4) should include several frequencies within the radar detection bandwidth and frequencies near the edge of the radar detection bandwidth. For 802.11 devices it is suggested to select frequencies in each of the bonded 20 MHz channels and the channel center frequency.		

**DFS Detection Thresholds for Master Devices and Client Devices with Radar Detection:**

Maximum Transmit Power	Value (See Notes 1, 2, and 3)
EIRP ≥ 200 milliwatt	-64 dBm
EIRP < 200 milliwatt and power spectral density < 10 dBm/MHz	-62 dBm
EIRP < 200 milliwatt that do not meet the power spectral density requirement	-64dBm

**Note 1:** This is the level at the input of the receiver assuming a 0 dBi receive antenna.  
**Note 2:** Throughout these test procedures an additional 1 dB has been added to the amplitude of the test transmission waveforms to account for variations in measurement equipment. This will ensure that the test signal is at or above the detection threshold level to trigger a DFS response.  
**Note 3:** EIRP is based on the highest antenna gain. For MIMO devices refer to KDB Publication 662911 D01.

**DFS Radar Signal Parameter Values:**

Parameter	Value
Non-occupancy period	Minimum 30 minutes
Channel Availability Check Time	60 seconds
Channel Move Time	10 seconds (See Note 1.)
Channel Closing Transmission Time	200 milliseconds + an aggregate of 60 milliseconds over remaining 10 second period. (See Notes 1 and 2.)
U-NII Detection Bandwidth	Minimum 100% of the U-NII 99% transmission power bandwidth. (See Note 3.)

**Note 1:** Channel Move Time and the Channel Closing Transmission Time should be performed with Radar Type 0. The measurement timing begins at the end of the Radar Type 0 burst.  
**Note 2:** The Channel Closing Transmission Time is comprised of 200 milliseconds starting at the beginning of the Channel Move Time plus any additional intermittent control signals required to facilitate a Channel move (an aggregate of 60 milliseconds) during the remainder of the 10 second period. The aggregate duration of control signals will not count quiet periods in between transmissions.  
**Note 3:** During the U-NII Detection Bandwidth detection test, radar type 0 should be used. For each frequency step the minimum percentage of detection is 90 percent. Measurements are performed with no data traffic.

**DFS Radar Signal Parameter:**

Radar Type 0 was used in the evaluation of the Client device for the purpose of measuring the Channel Move Time and the Channel Closing Transmission Time

**Table 1-Short Pulse Radar Test Waveforms**

Radar Type	Pulse Width (µsec)	PRI (µsec)	Number of Pulses	Minimum Percentage of Successful Detection	Minimum Trials
0	1	1428	18	See Note 1.	See Note 1.
1	1	Test A Test B	Roundup $\left\{ \begin{matrix} \left( \frac{1}{360} \right) \\ \left( \frac{19 \cdot 10^6}{PRI_{\mu sec}} \right) \end{matrix} \right\}$	60%	30
2	1-5	150-230	23-29	60%	30
3	6-10	200-500	16-18	60%	30
4	11-20	200-500	12-16	60%	30
Aggregate (Radar Types 1-4)				80%	120

**Note 1:** Short Pulse Radar Type 0 should be used for the detection bandwidth test, channel move time, and channel closing time tests.

Test A: 15 unique PRI values randomly selected from the list of 23 PRI values in Table 5a  
 Test B: 15 unique PRI values randomly selected within the range of 518-3066 µsec, with a minimum increment of 1 µsec, excluding PRI values selected in Test A  
 A minimum of 30 unique waveforms are required for each of the Short Pulse Radar Types 2 through 4. If more than 30 waveforms are used for Short Pulse Radar Types 2 through 4, then each additional waveform must also be unique and not repeated from the previous waveforms.  
 If more than 30 waveforms are used for Short Pulse Radar Type 1, then each additional waveform is generated with Test B and must also be unique and not repeated from the previous waveforms in Tests A or B.  
 The aggregate is the average of the percentage of successful detections of short pulse radar types

**Shenzhen UnionTrust Quality and Technology Co., Ltd.**

1-4

Table 2-Long Pulse Radar Test Waveform

Radar Type	Pulse Width (μsec)	Chirp Width (MHz)	PRI (μsec)	Number of Pulses per Burst	Number of Bursts	Minimum Percentage of Successful Detection	Minimum Trials
5	50-100	5-20	1000-2000	1-3	8-20	80%	30

Table 3-Frequency Hopping Radar Test Waveform

Radar Type	Pulse Width (μsec)	PRI (μsec)	Pulses per Hop	Hopping Rate (kHz)	Hopping Sequence Length (msec)	Minimum Percentage of Successful Detection	Minimum Trials
6	1	333	9	0.333	300	70%	30

**In-Service Monitoring: Channel Move Time, Channel Closing Transmission Time and Non-Occupancy Period**

**Limit of In-Service Monitoring:**

Reference to DFS Radar Signal Parameter Values.

**Test Procedures:**

- One frequency will be chosen from the Operating Channels of the EUT within the 5250-5350 MHz or 5470-5725 MHz bands. For 802.11 devices, the test frequency must contain control signals. This can be verified by disabling channel loading and monitoring the spectrum analyzer. If no control signals are detected, another frequency must be selected within the emission bandwidth where control signals are detected.
- In case the EUT is a Master Device, a U-NII device operating as a Client Device will be used and it is assumed that the Client will associate with the EUT (Master). For radiated tests, the emissions of the Radar Waveform generator will be directed towards the Master Device. If the Master Device has antenna gain, the main beam of the antenna will be directed toward the radar emitter. Vertical polarization is used for testing.
- The TCP protocol unicast data stream was generated by the iperf software command line with at least 17% activity ratio over any 100ms period.
- Timing plots are reported with calculations demonstrating a minimum channel loading of approximately 17% or greater. For example, channel loading can be estimated by setting the spectrum analyzer for zero span and approximate the Time On/ (Time On + Off Time).
- At time T<sub>0</sub> the Radar Waveform generator sends a Burst of pulses for one of the Short Pulse Radar Types 1-4 at DFS Detection Threshold levels on the Operating Channel. An additional 1 dB is added to the radar test signal to ensure it is at or above the DFS Detection Threshold, accounting for equipment variations/errors.
- Observe the transmissions of the EUT at the end of the radar Burst on the Operating Channel for duration greater than 10 seconds. Measure and record the transmissions from the EUT during the observation time (Channel Move Time). Measure and record the Channel Move Time and Channel Closing Transmission Time if radar detection occurs.
- When operating as a Master Device, monitor the EUT for more than 30 minutes following instant T<sub>2</sub> to verify that the EUT does not resume any transmissions on this Channel. Perform this test once and record the measurement result.

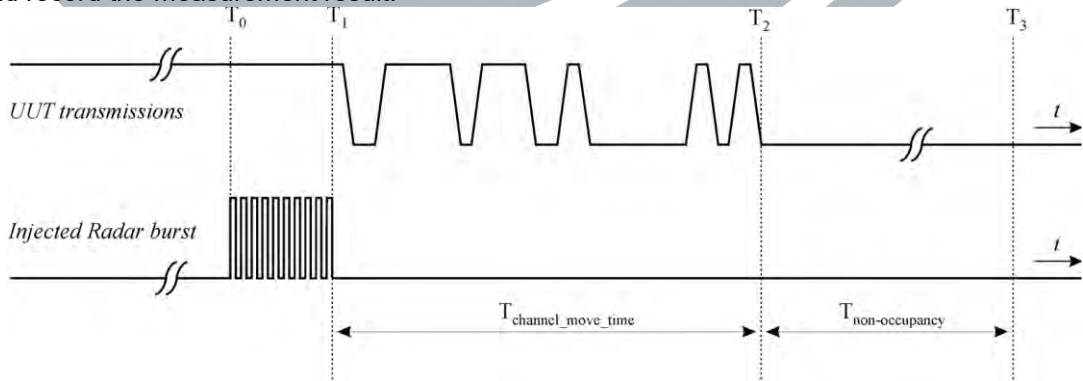
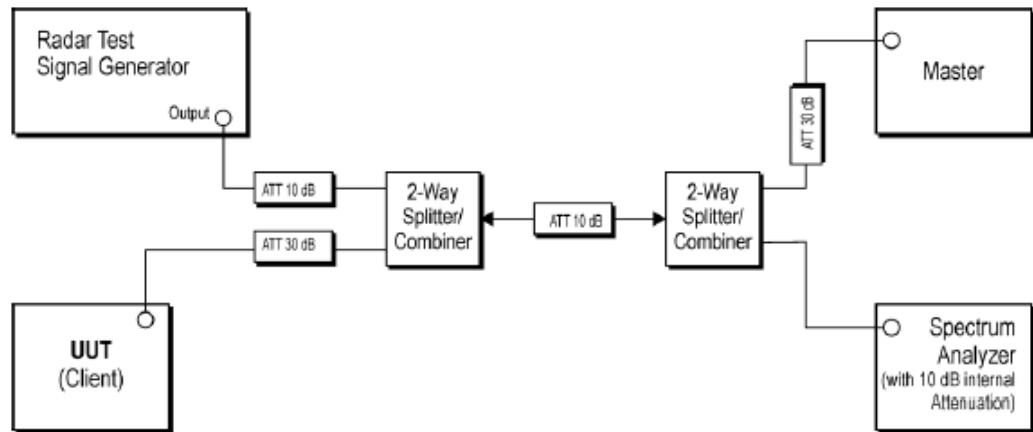

Figure 17: Channel Closing Transmission Time, Channel Move Time and Non-Occupancy Period

**Conducted test setup**



**Setup for Client with injection at the Master**

**Equipment Used:** Refer to section 3 for details.  
**Test Result:** Result of Channel Move Time, Channel Closing Transmission Time and Non-Occupancy Period for Client Beacon Test  
**The measurement data as follows:**

BW / Channel	Test Item	Test Result	Limit	Pass/Fail
20 MHz / 5300 MHz	Channel Move Time	0.7624 s	< 10s	Pass
	Channel Closing Transmission Time	4.8 ms	< 200+60ms	Pass
	Non-Occupancy Period	No transmission	30 minutes	Pass
20 MHz / 5500 MHz	Channel Move Time	0.7834 s	< 10s	Pass
	Channel Closing Transmission Time	7.6 ms	< 200+60ms	Pass
	Non-Occupancy Period	No transmission	30 minutes	Pass
80 MHz / 5290 MHz	Channel Move Time	0.7256 s	< 10s	Pass
	Channel Closing Transmission Time	19.2 ms	< 200+60ms	Pass
	Non-Occupancy Period	No transmission	30 minutes	Pass
80 MHz / 5530 MHz	Channel Move Time	0.7168 s	< 10s	Pass
	Channel Closing Transmission Time	6.0 ms	< 200+60ms	Pass
	Non-Occupancy Period	No transmission	30 minutes	Pass

Radar Waveform calibration Plot  
Reference DFS test signal

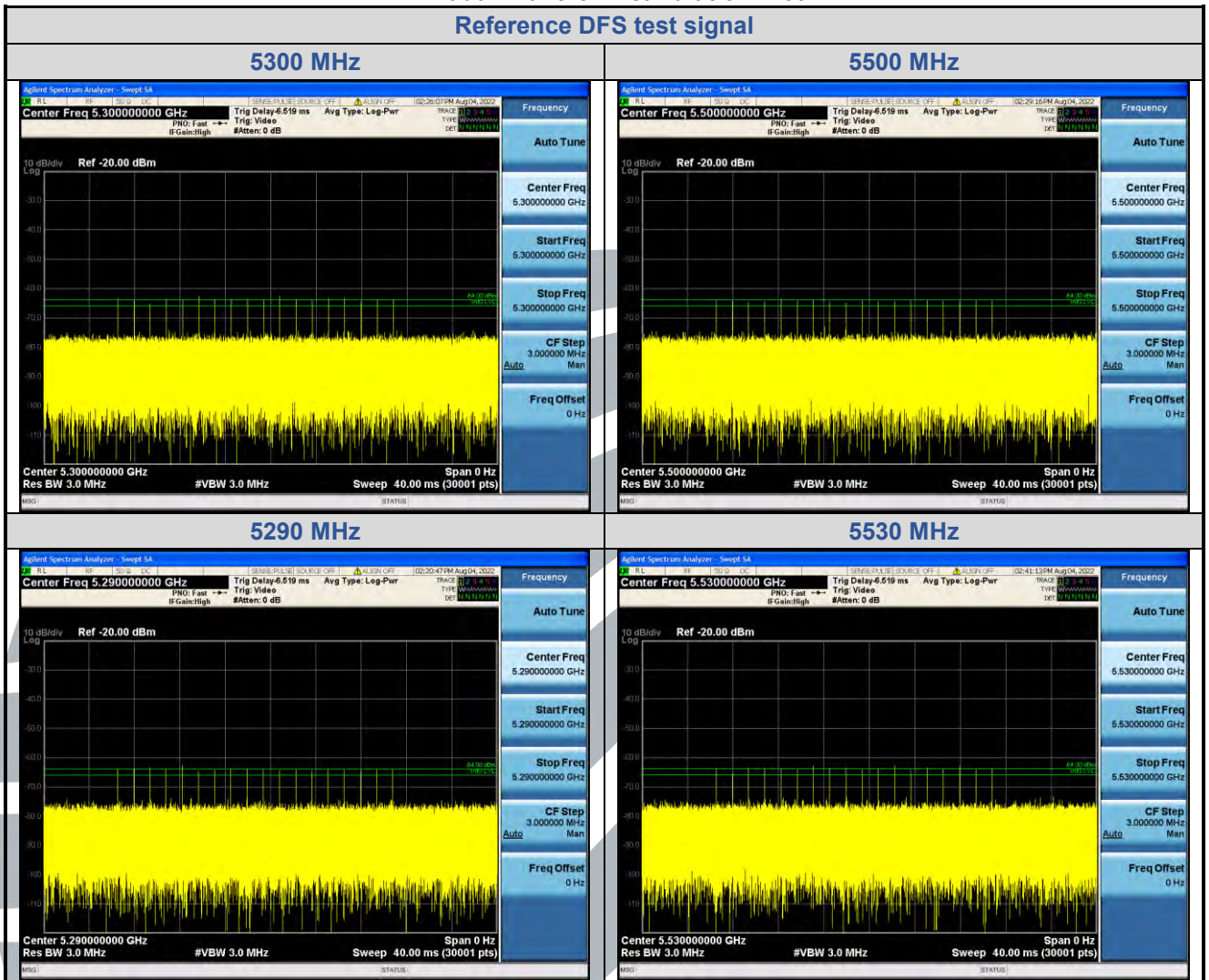

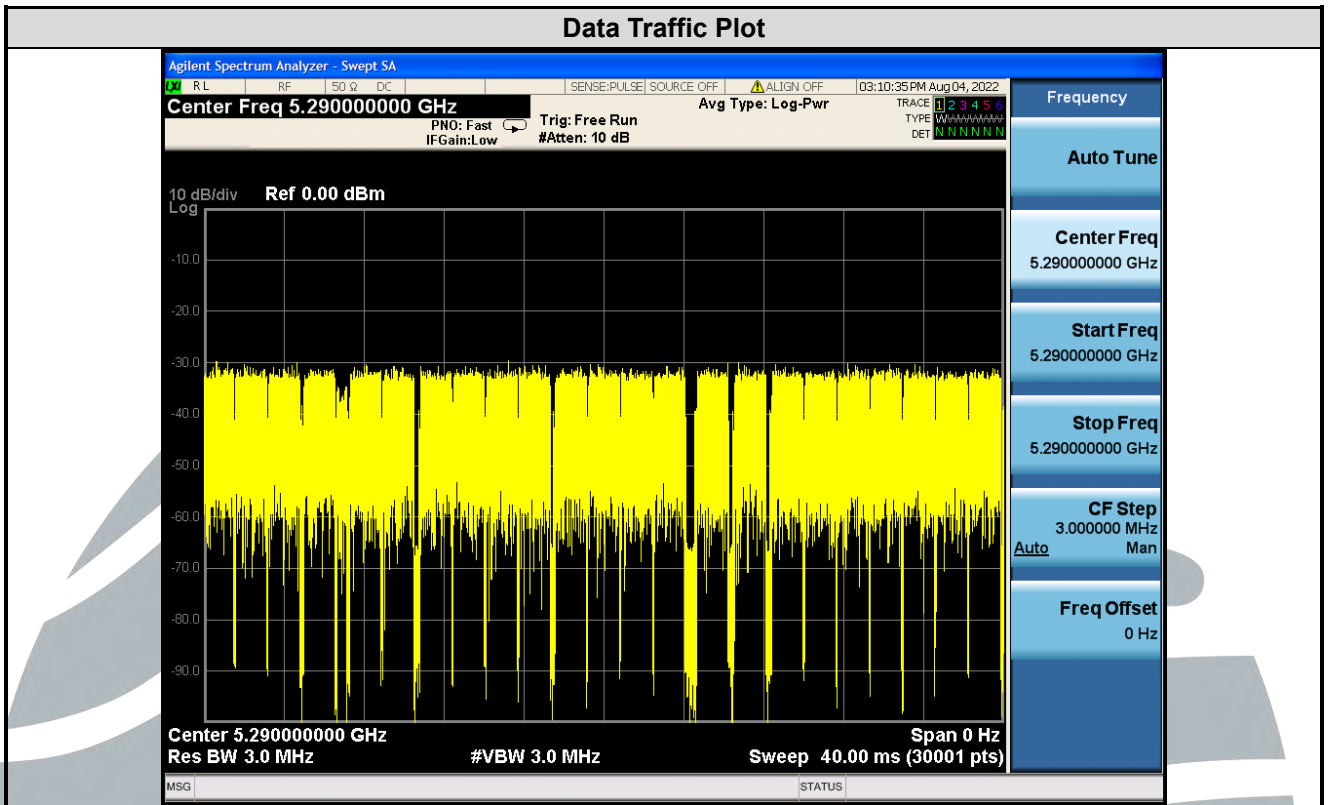

**Shenzhen UnionTrust Quality and Technology Co., Ltd.**

Address: Unit D/E of 9/F and 16/F, Block A, Building 6, Baoneng science and technology park, Longhua district, Shenzhen, China

Tel: +86-755-28230888

Fax: +86-755-28230886

E-mail: info@uttlab.com

<http://www.uttlab.com>

UTTR-RF-RSS247-V1.1

Channel Move Time & Channel Closing Transmission Time  
802.11a\_5300 MHz

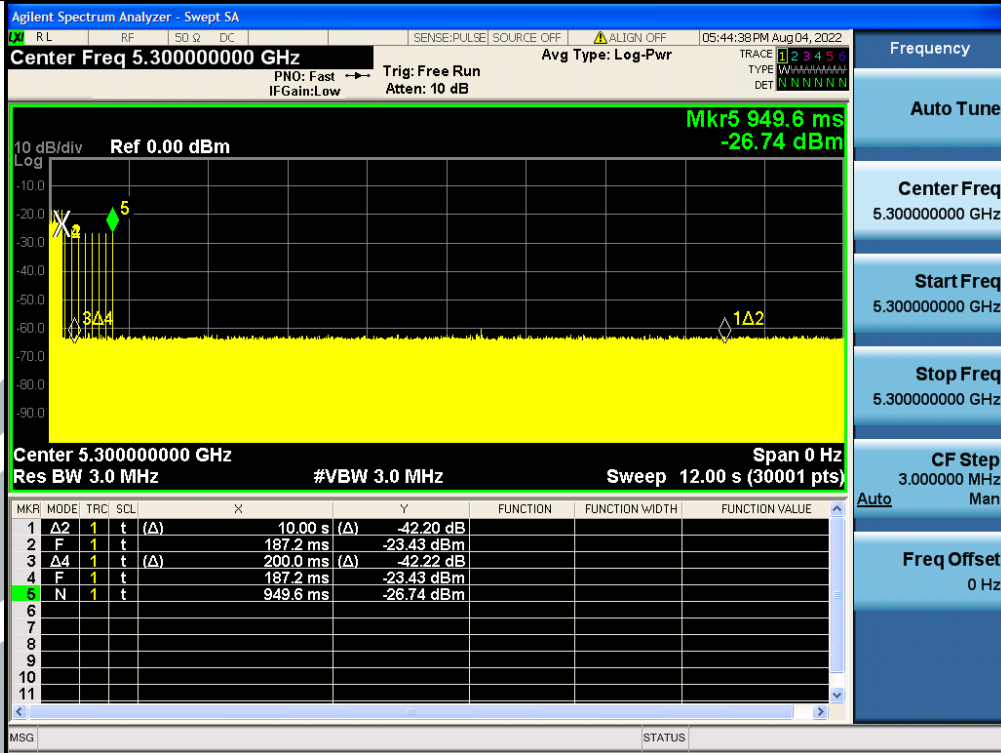

Note:

- 1) Mark1 Time: 187.2 ms, Mark2 Time: 10187.2 ms, Ontime Points: 12
- 2) Dwell = S/B = 12000 ms/30001 = 0.4 ms, C = N x Dwell = 12 x 0.4 = 4.8ms
- 3) CMT = 0.9496s - 0.1872 s = 0.7624 s

Non-Occupancy Period\_802.11a\_CH60\_5300 MHz

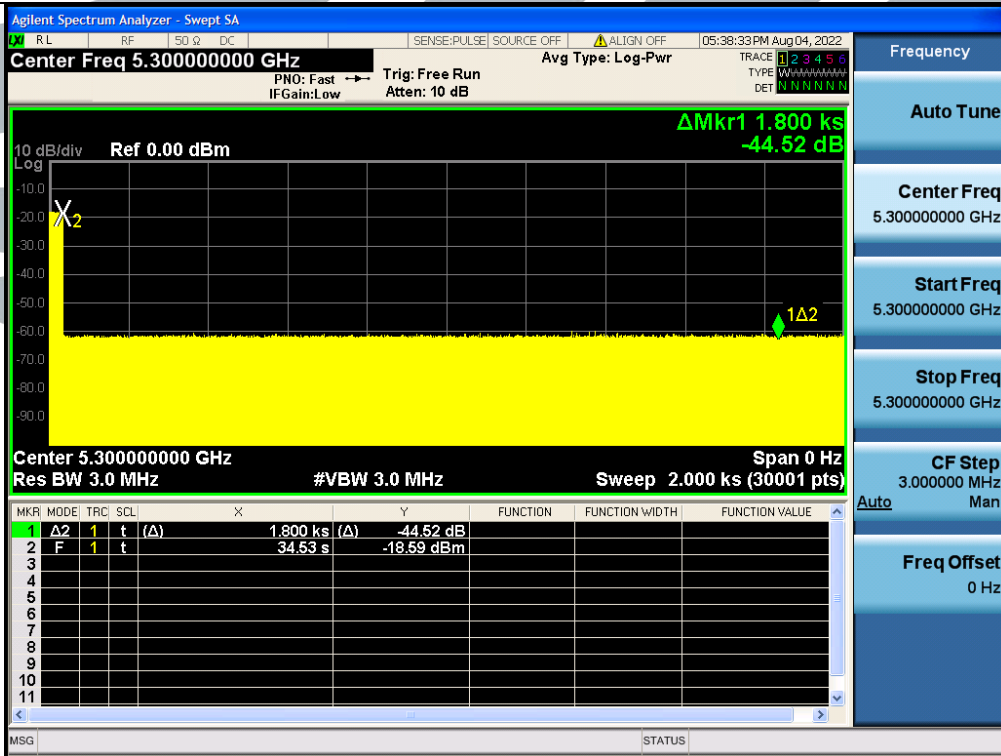

Channel Move Time & Channel Closing Transmission Time  
802.11a\_5500 MHz

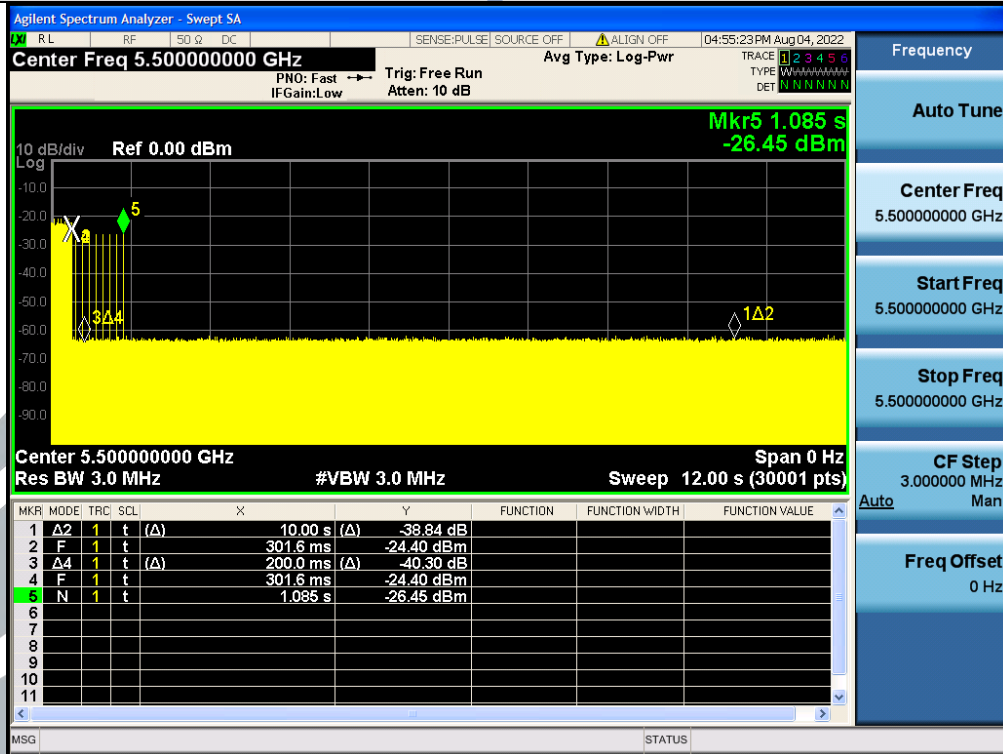

Note:

- 4) Mark1 Time: 301.6 ms, Mark2 Time: 10301.6 ms, Ontime Points: 19
- 5) Dwell = S/B = 12000 ms/30001 = 0.4 ms, C = N x Dwell = 19 x 0.4 = 7.6ms
- 6) CMT = 1.085 s - 0.3016 s = 0.7834 s

Non-Occupancy Period\_802.11a\_CH100\_5500 MHz

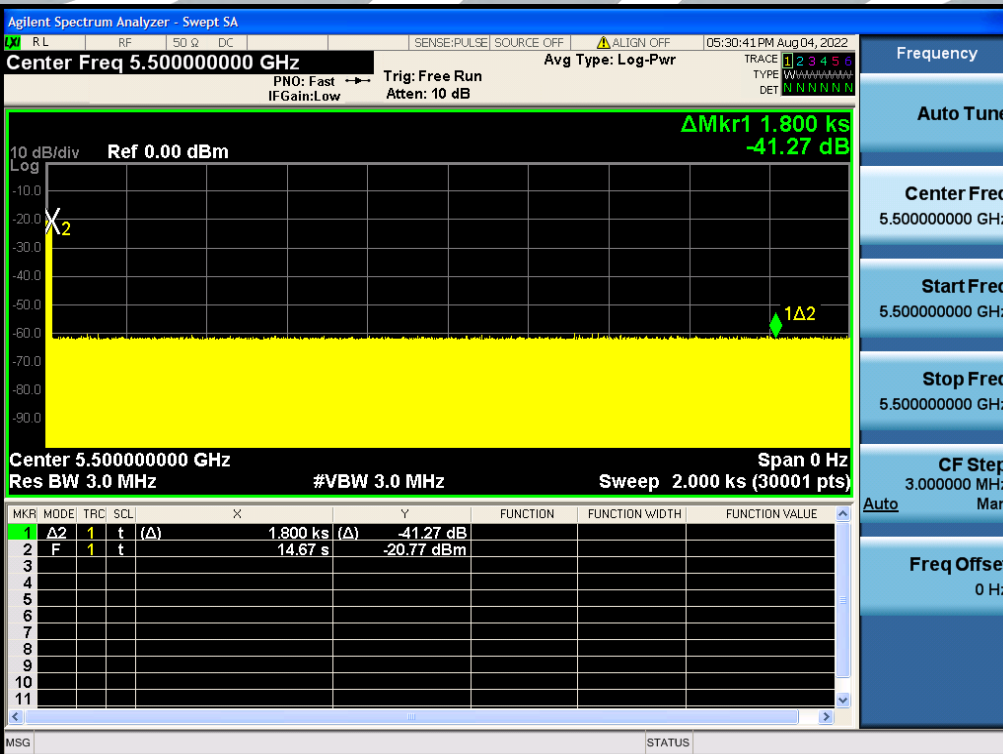



Channel Move Time & Channel Closing Transmission Time  
802.11ac\_5290 MHz

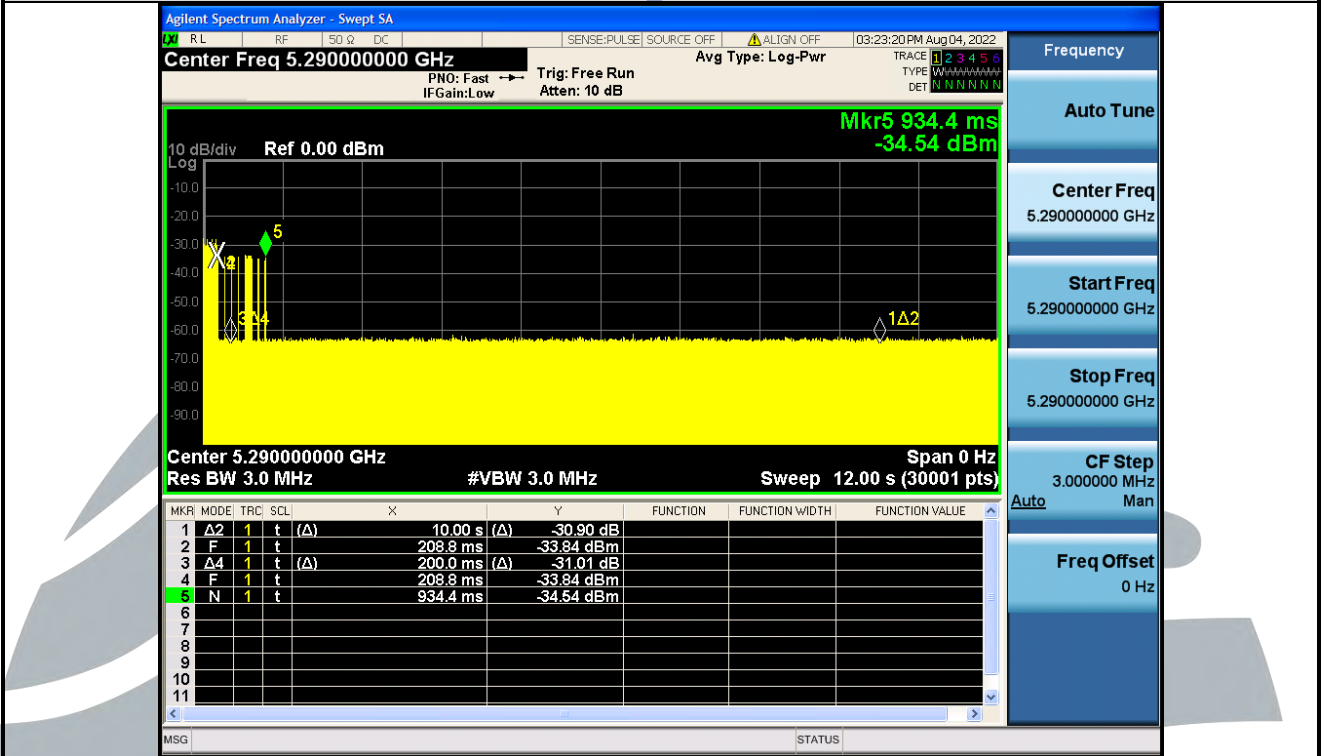

Note:

- 7) Mark1 Time: 208.8 ms, Mark2 Time: 10208.8 ms, On-time Points: 48
- 8) Dwell = S/B = 12000 ms/30001 = 0.4 ms, C = N x Dwell = 48 x 0.4 = 19.2 ms
- 9) CMT = 0.9344 s - 0.2088 s = 0.7256 s

Non-Occupancy Period\_802.11ac\_CH58\_5290 MHz

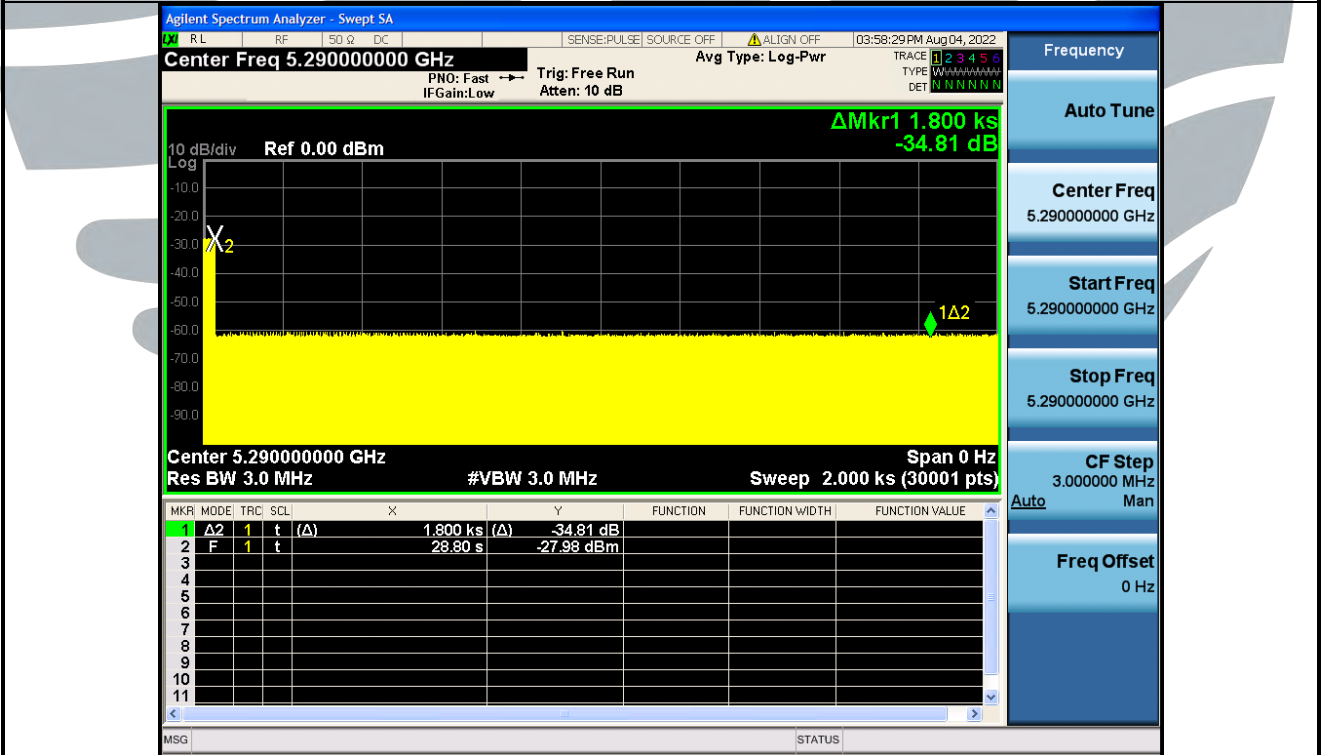

Channel Move Time & Channel Closing Transmission Time  
802.11ac\_5530 MHz

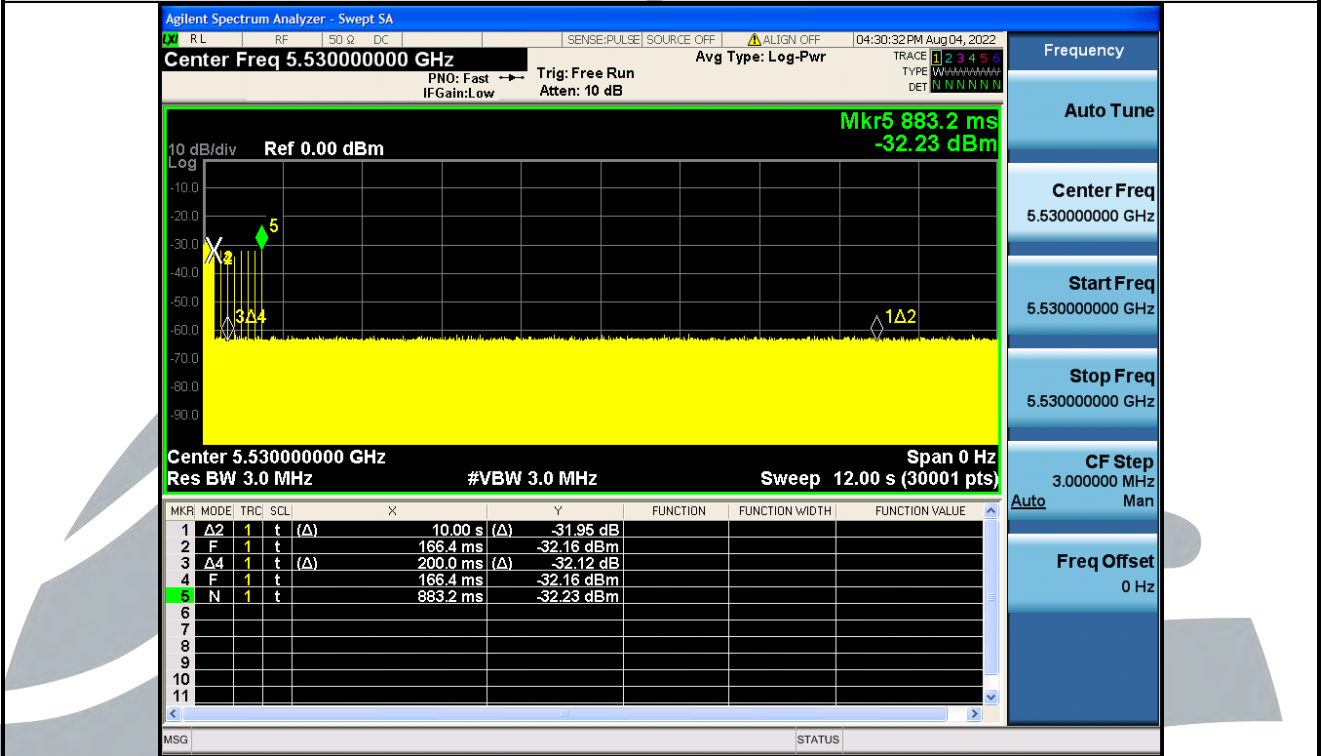

Note:

- 10) Mark1 Time: 166.4 ms, Mark2 Time: 101664 ms, Ontime Points: 15
- 11) Dwell = S/B = 12000 ms/30001 = 0.4 ms, C = N x Dwell = 15 x 0.4 = 6.0 ms
- 12) CMT = 0.8832 s – 0.1664 s = 0.7168 s

Non-Occupancy Period\_802.11ac\_CH106\_5530 MHz

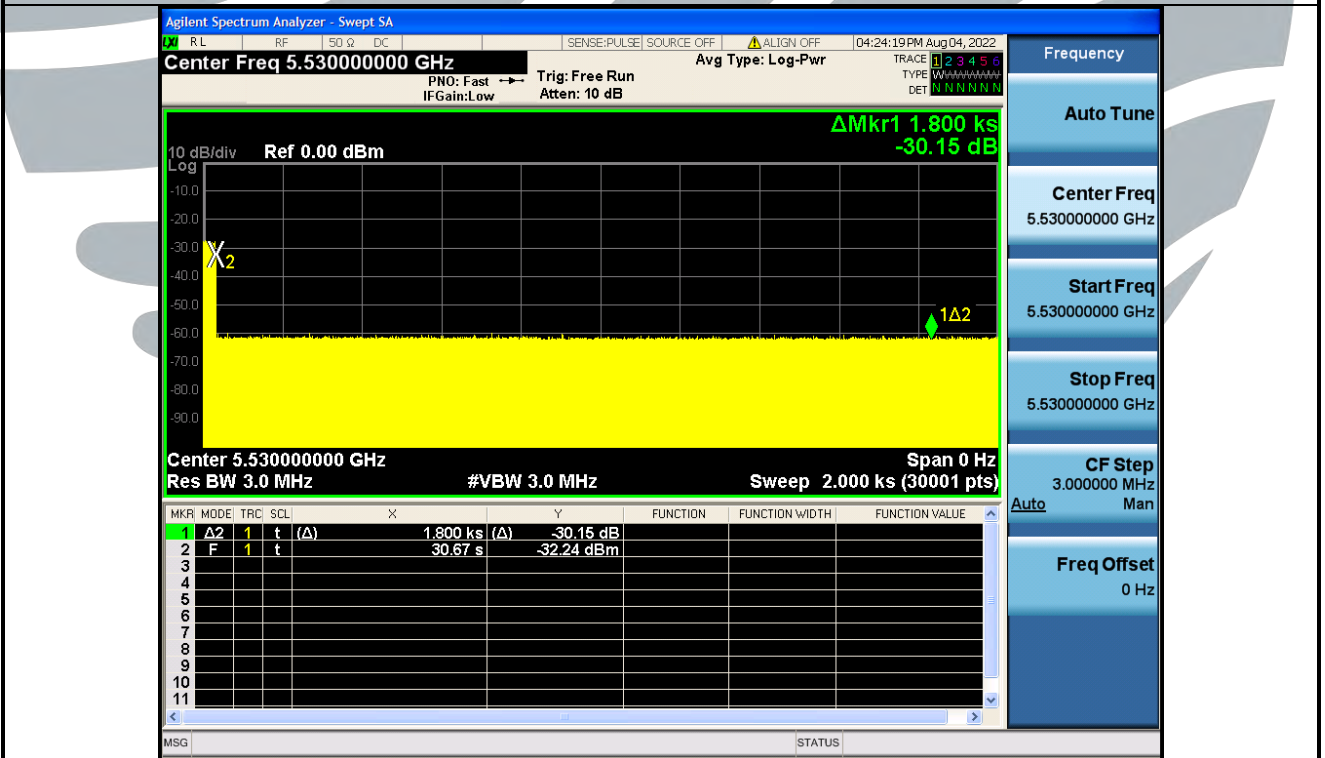

### 5.9 AC POWER LINE CONDUCTED EMISSION

**Test Requirement:** FCC 47 CFR Part 15 Subpart E Section 15.407 (b)(6)  
 FCC 47 CFR Part 15 Subpart C Section 15.207  
 RSS-Gen Issue 5, Section 8.8

**Test Method:** ANSI C63.10-2013, Section 6.2.

**Limits:**

Frequency range (MHz)	Limits (dB(μV))	
	Quasi-peak	Average
0,15 to 0,50	66 to 56	56 to 46
0,50 to 5	56	46
5 to 30	60	50

**Remark:**

1. The lower limit shall apply at the transition frequencies.
2. The limit decreases linearly with the logarithm of the frequency in the range 0.15 to 0.50 MHz.

**Test Setup:** Refer to section 4.5.2 for details.

**Test Procedures:**

Test frequency range :150KHz-30MHz

- 1) The mains terminal disturbance voltage test was conducted in a shielded room.
- 2) The EUT was connected to AC power source through a LISN 1 (Line Impedance Stabilization Network) which provides a 50Ω/50μH + 5Ω linear impedance. The power cables of all other units of the EUT were connected to a second LISN 2, which was bonded to the ground reference plane in the same way as the LISN 1 for the unit being measured. A multiple socket outlet strip was used to connect multiple power cables to a single LISN provided the rating of the LISN was not exceeded.
- 3) The tabletop EUT was placed upon a non-metallic table 0.8m above the ground reference plane. And for floor-standing arrangement, the EUT was placed on the horizontal ground reference plane,
- 4) The test was performed with a vertical ground reference plane. The rear of the EUT shall be 0.4 m from the vertical ground reference plane. The vertical ground reference plane was bonded to the horizontal ground reference plane. The LISN 1 was placed 0.8 m from the boundary of the unit under test and bonded to a ground reference plane for LISNs mounted on top of the ground reference plane. This distance was between the closest points of the LISN 1 and the EUT. All other units of the EUT and associated equipment was at least 0.8 m from the LISN 2.
- 5) In order to find the maximum emission, the relative positions of equipment and all of the interface cables must be changed according to ANSI C63.10 on conducted measurement.

**Equipment Used:** Refer to section 3 for details.

**Test Result:** Pass

The measurement data as follows:

Quasi Peak and Average:

Mode: WIFI Link

Live Line

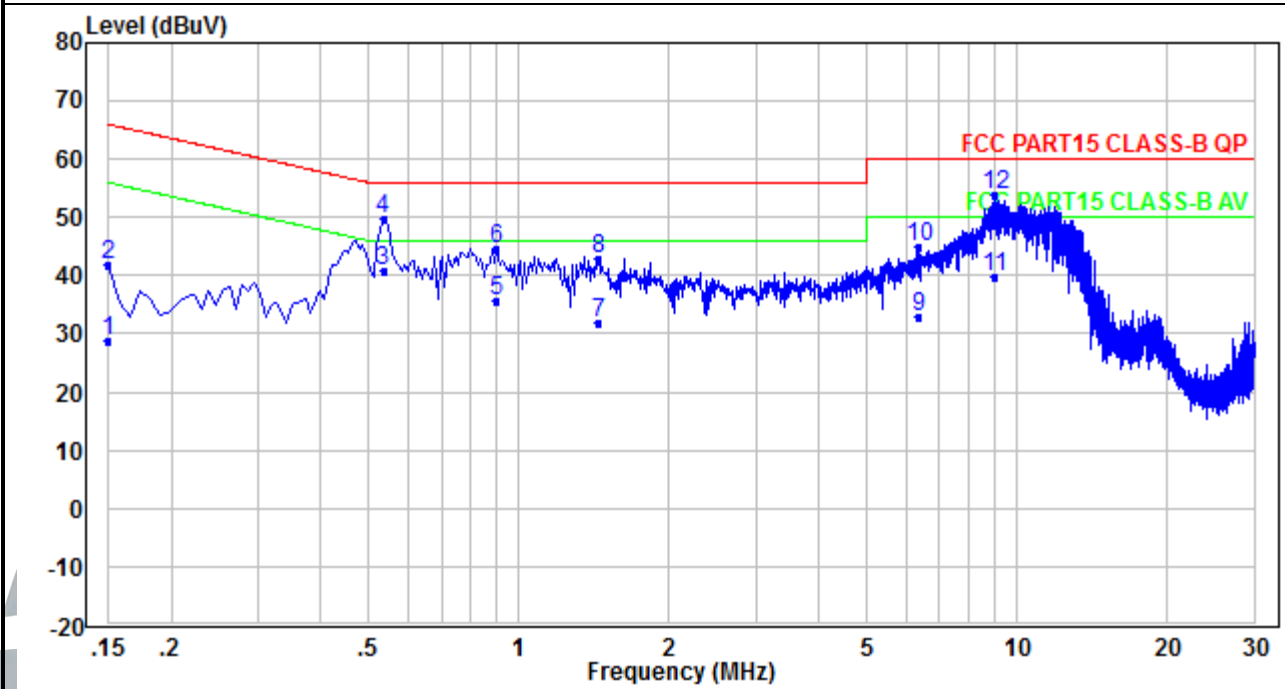

No.	Frequency (MHz)	Reading (dBμV)	Correction factor (dB)	Result (dBμV)	Limit (dBμV)	Margin (dB)	Detector
1	0.150	18.77	10.12	28.89	56.00	-27.11	Average
2	0.150	31.77	10.12	41.89	66.00	-24.11	QP
3	0.534	30.76	10.16	40.92	46.00	-5.08	Average
4	0.534	39.76	10.16	49.92	56.00	-6.08	QP
5	0.902	25.52	10.21	35.73	46.00	-10.27	Average
6	0.902	34.52	10.21	44.73	56.00	-11.27	QP
7	1.446	21.81	10.23	32.04	46.00	-13.96	Average
8	1.446	32.81	10.23	43.04	56.00	-12.96	QP
9	6.333	22.37	10.41	32.78	50.00	-17.22	Average
10	6.333	34.37	10.41	44.78	60.00	-15.22	QP
11	9.036	29.30	10.54	39.84	50.00	-10.16	Average
12	9.036	43.30	10.54	53.84	60.00	-6.16	QP

**Shenzhen UnionTrust Quality and Technology Co., Ltd.**

Address: Unit D/E of 9/F and 16/F, Block A, Building 6, Baoneng science and technology park, Longhua district, Shenzhen, China

Tel: +86-755-28230888

Fax: +86-755-28230886

E-mail: info@uttlab.com

<http://www.uttlab.com>

UTTR-RF-RSS247-V1.1

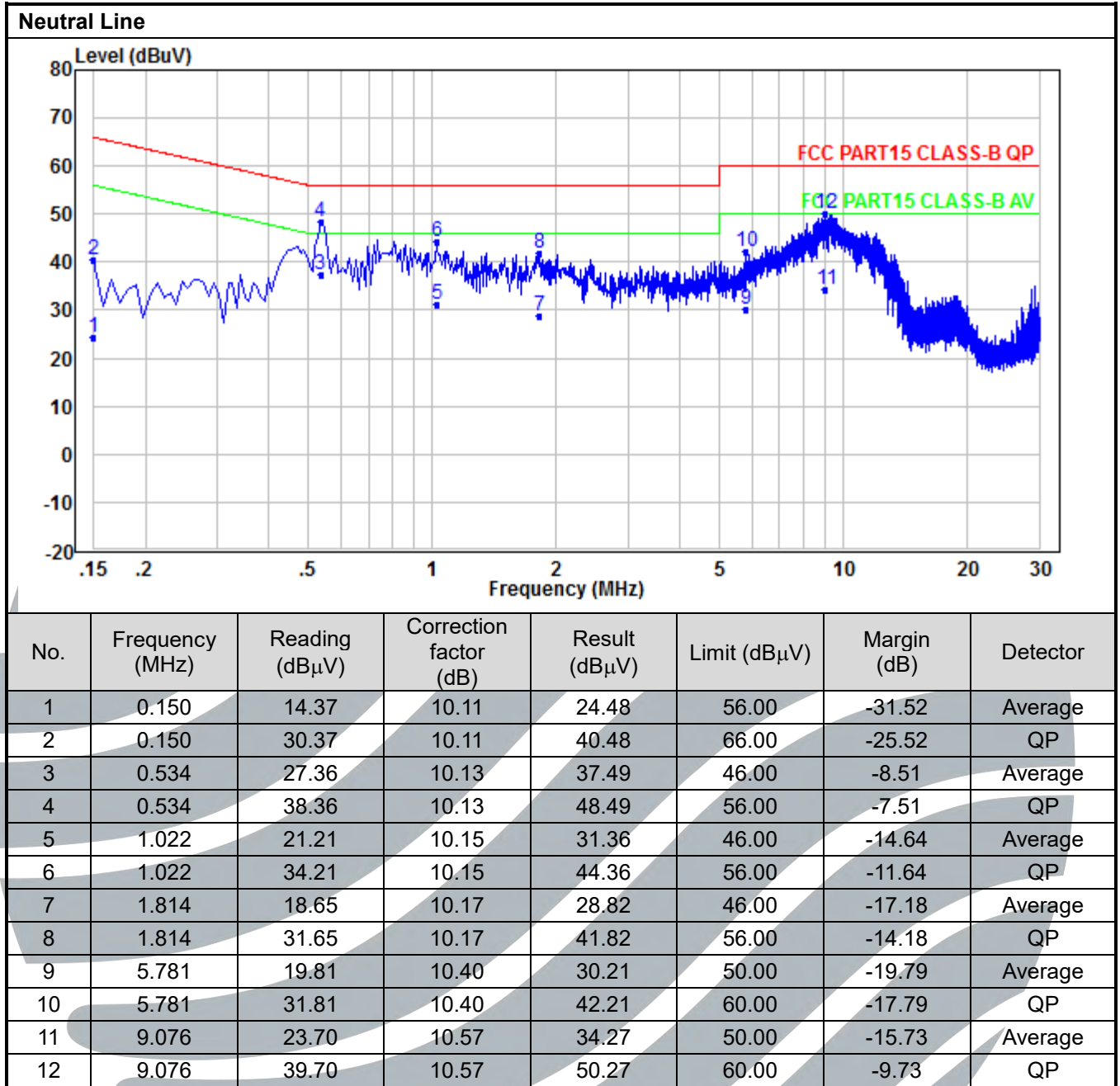

Remark:

1. Correct Factor = LISN Factor + Cable Loss + Pulse Limiter Factor, the value was added to Original Receiver Reading by the software automatically.
2. Result = Reading + Correct Factor.
3. Margin = Result - Limit
4. An initial pre-scan was performed on the Phase and neutral lines with peak detector. Quasi-Peak and Average measurement were performed at the frequencies with maximized peak emission were detected.
5. All possible modes of operation were investigated, and testing at two nominal voltages of 240V/50Hz and 120V/60Hz, only the worst case emissions reported.

## APPENDIX 1 PHOTOS OF TEST SETUP

See test photos attached in Appendix 1 for the actual connections between Product and support equipment.

## APPENDIX 2 PHOTOS OF EUT CONSTRUCTIONAL DETAILS

Refer to Appendix 2 for EUT external and internal photos.

\*\*\* End of Report \*\*\*

---

The test report is effective only with both signature and specialized stamp. The result(s) shown in this report refer only to the sample(s) tested. Without written approval of UnionTrust, this report can't be reproduced except in full.

---