



Grandstream Networks, Inc.

126 Brookline Ave, 3rd Floor  
Boston, MA 02215. USA  
Tel : +1 (617) 566 - 9300  
Fax: +1 (617) 249 - 1987

[www.grandstream.com](http://www.grandstream.com)



## GAC2570

Conference Phones

**Quick Installation Guide**

\*Android is a Registered Trademark of Google LLC.  
\*Skype and Skype for Business are Registered Trademarks of Microsoft Corporation

**HDMI™** HDMI, the HDMI Logo, and High-Definition Multimedia Interface are trademarks or registered trademarks of HDMI Licensing LLC in the United States and other countries.



BE	BG	CZ	DK	DE	EE	IE	EL
ES	FR	HR	IT	CY	LV	LT	LU
HU	MT	NL	AT	PL	PT	RO	SI
SK	FI	SE	NO	IS	LI	CH	TR

In all EU member states, operation of 5150-5350 MHz is restricted to indoor use only.

For Certification, Warranty and RMA information, please visit  
[www.grandstream.com](http://www.grandstream.com)

## Content

---

English.....	1
简体中文.....	4
Español.....	7
Français.....	10
Deutsch.....	13
Italiano.....	16
Русский.....	19
Português.....	22
Polski.....	25
Precautions.....	28

## Package Contents

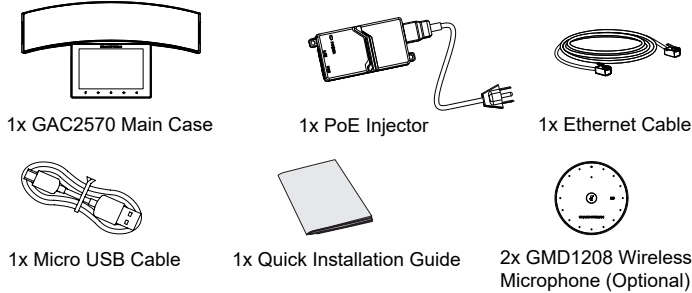

## GAC2570 Description

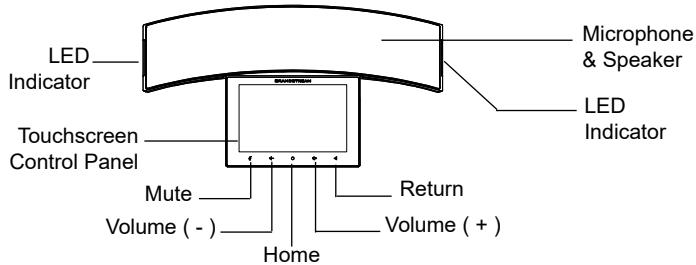

## GAC2570 Connection

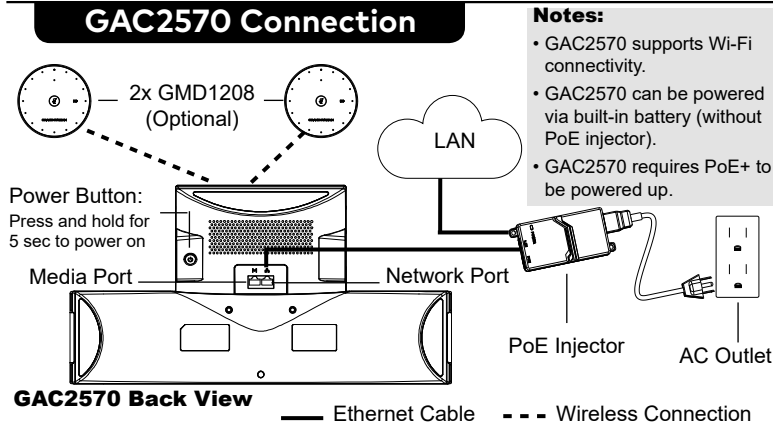

## Optional Connections

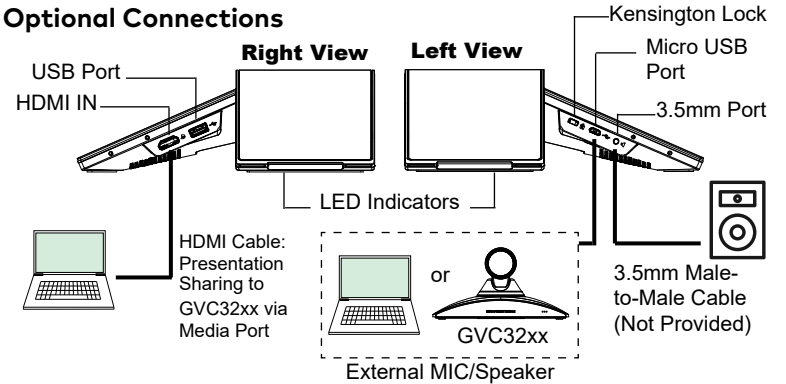

## GAC2570 Usage Modes

### Audio Conference System Mode

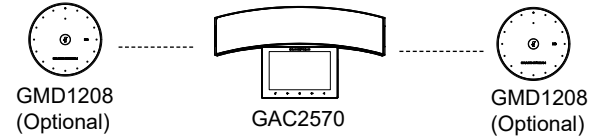

### External MIC/Speaker

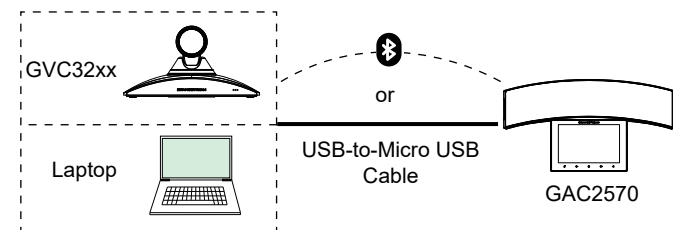

**Note:** Refer to online documentation for more details regarding the GAC2570 usage modes, GMD1208 or GVC32xx. [www.grandstream.com](http://www.grandstream.com)

## GAC2570 Configuration

### Via Web Browser

1

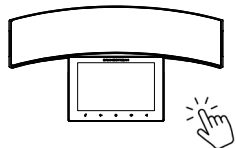

- From the main menu, slide to “Settings” screen.
- Access “Settings” app ► Status ► Network status ► IPv4 address”.

2



- Type in the IP address in your PC browser.
- Enter username and password to login. (The default administrator username is “admin” and the default random password can be found at the sticker on the GAC2570).

#### Notes:

The computer must be in the same LAN as the GAC2570.

### Via Touch Screen

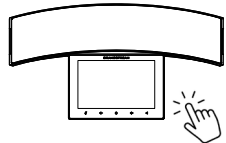

- On the main menu, click “Click to add accounts” to configure SIP account.
- Access “Settings App” for advanced configuration.

Refer to online documents and FAQ for more detailed information:

<http://www.grandstream.com/our-products>

This product is covered by one or more of the U.S. patents (and any foreign patent counterparts thereto) identified at [www.cmspatents.com](http://www.cmspatents.com)

## 包装内容

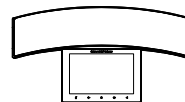

1x GAC2570设备

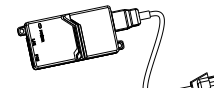

1x PoE电源适配器



1x 网线

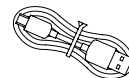

1x Micro USB 线缆

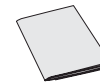

1x 快速安装手册

2x GMD1208 无线麦克风  
(选配)

## GAC2570 设备说明

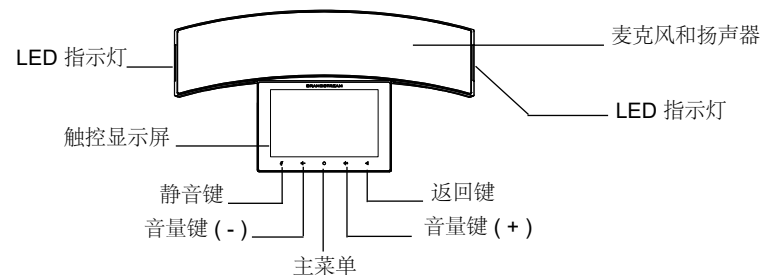

## GAC2570 连接方式

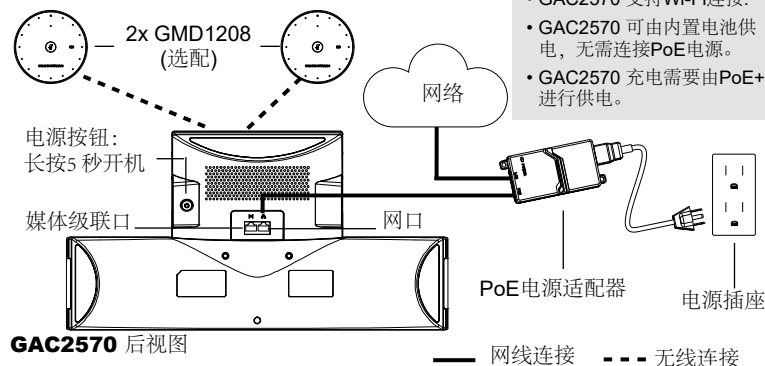

## 可选连接

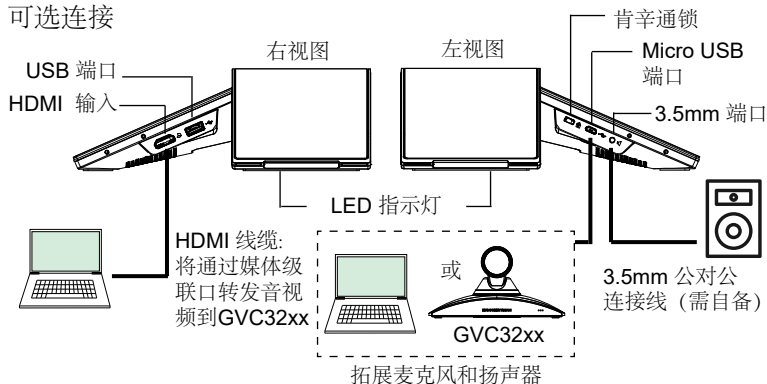

## GAC2570 使用模式

### 音频会议系统模式

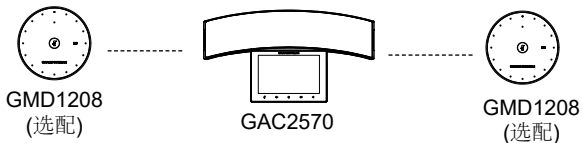

### 作为拓展麦克风和扬声器

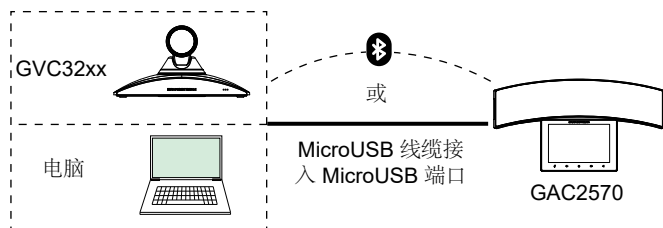

注意: 有关 GAC2570 的使用模式, 以及GMD1208和GVC32xx的更多细节, 可以参考在线文档: [www.grandstream.com](http://www.grandstream.com)

## GAC2570 配置方式

### 通过浏览器

1

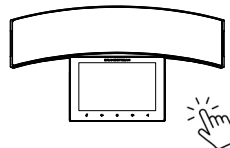

- 从主菜单, 滑到“设置”页面。
- 点击“设置”应用 ▶ 状态 ▶ 网络状态 ▶ IPv4 地址。

2



- 在浏览器输入设备的IP。
- 输入用户名和密码进入设备的配置页面(默认管理员用户名是“admin”, 随机密码可从终端设备的标签上找到)。

注意:  
计算机必须与GAC2570在相同网域。

### 通过触控屏

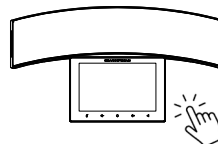

- 在主菜单中单击“点击添加账号”, 进行SIP账号配置。
- 点击“设置”应用进行高级配置。

欲获取更多详细信息, 请参考在线文档和常见问题解答:  
<http://www.grandstream.com/our-products>

## Contenido Del Paquete

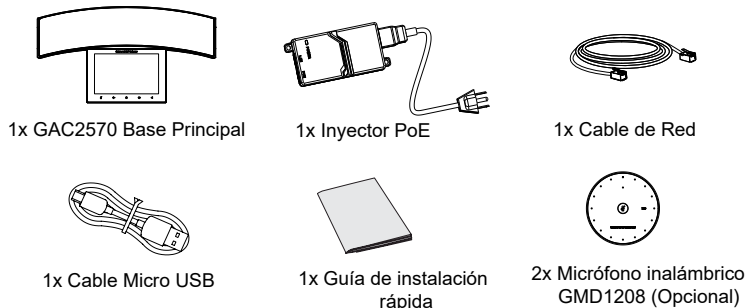

## GAC2570 Descripción

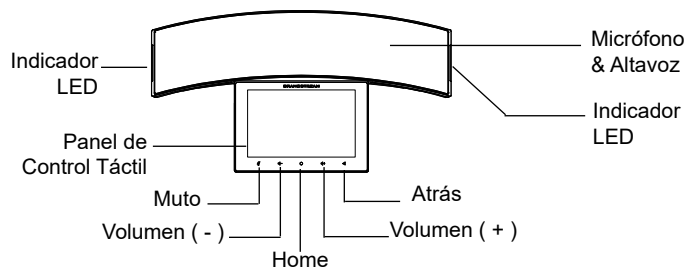

## GAC2570 Conexión

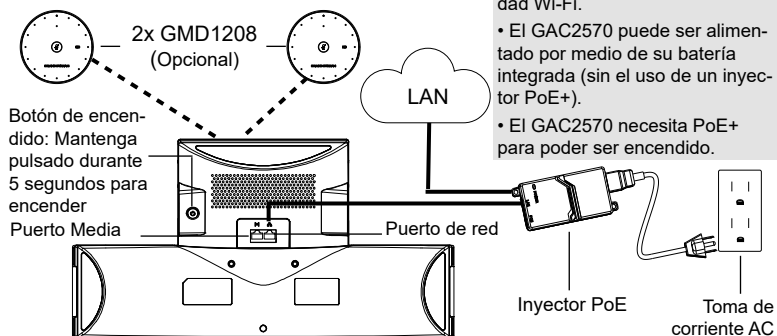

### GAC2570 VISTA INFERIOR

— Cable de Red - - - Conexión inalámbrica

## Conexiones opcionales

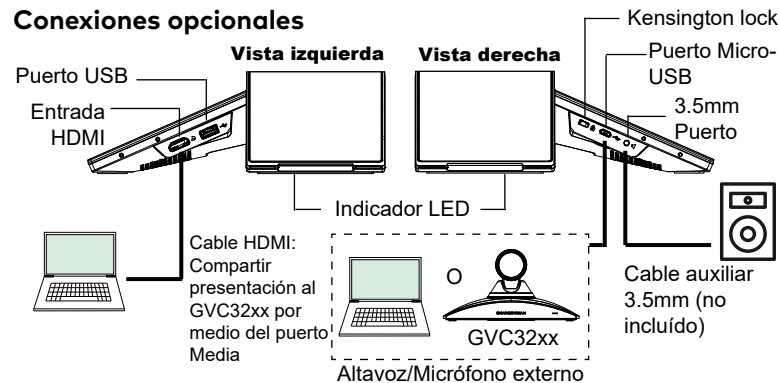

## Modos de uso del GAC2570

### Modo de sistema de audio conferencia



### Altavoz/Micrófono externo

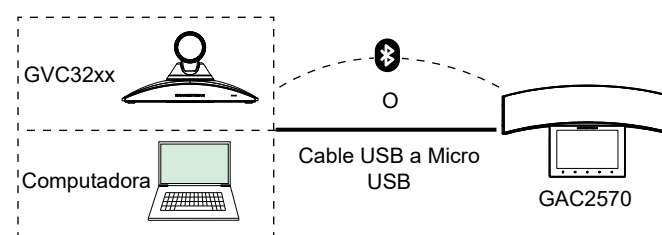

**Nota:** Refiérase a la documentación en línea para más detalles acerca de los modos de uso del GAC2570, GMD1208 o el GVC32xx. [www.grandstream.com](http://www.grandstream.com)

## GAC2570 Configuración

### Usando un navegador Web

1

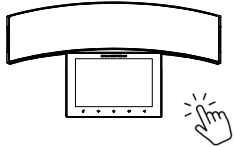

- Desde el menú principal, deslícese a la pantalla de "Ajustes".
- Acceder "Ajustes ► Estado ► Estado de la red ► Dirección IPv4".

2



- Típee la dirección IP en el navegador de su PC.
- Introduzca el nombre de usuario y la contraseña para iniciar sesión. (El nombre de usuario de administrador predeterminado es "admin" y la contraseña aleatoria predeterminada puede ser encontrada en la etiqueta del GAC2570).

#### Notas:

La computadora debe estar en la misma LAN del GAC2570.

### Usando la pantalla táctil

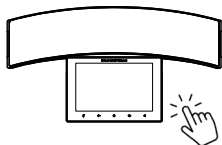

- En el menú principal, haz clic "Clic para añadir cuentas" para configurar la cuenta SIP.
- Accede a la aplicación de "Ajustes" para configuraciones avanzadas.

Por favor, descargue el Manual del usuario y revisar la AYUDA para obtener instrucciones más detalladas:

<http://www.grandstream.com/our-products>

## Contenu du pack

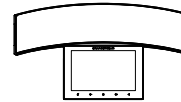

1x GAC2570 Boîtier principal

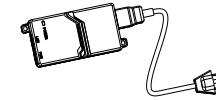

1x Injecteur PoE



1x Câble Ethernet

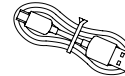

1x Câble Micro USB



1x Guide Express



2x GMD1208 Microphone sans fil (Facultatif)

## Description du GAC2570

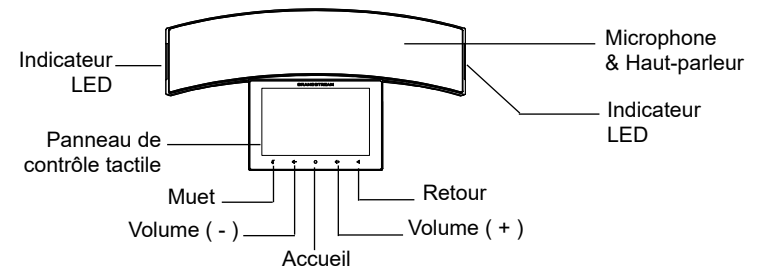

## Connexion du GAC2570

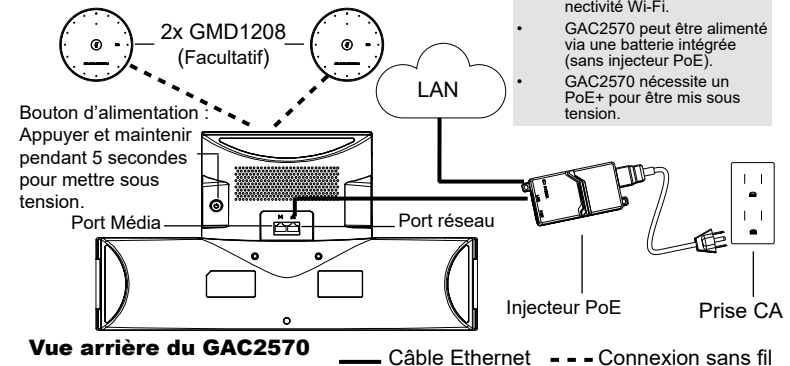

## Connexions facultatives

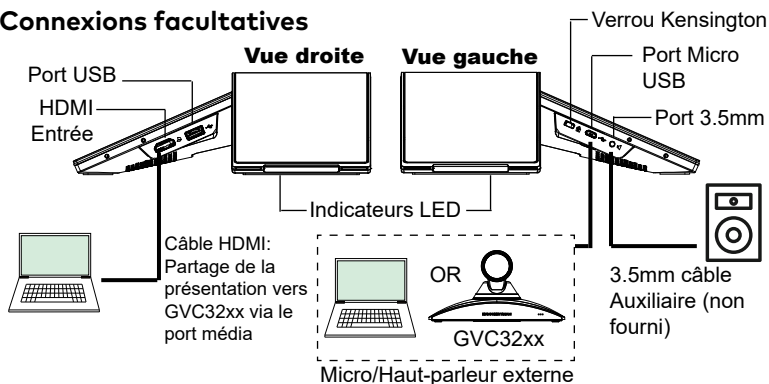

## GAC2570 Modes d'usage

### Mode Système de Conférence Audio

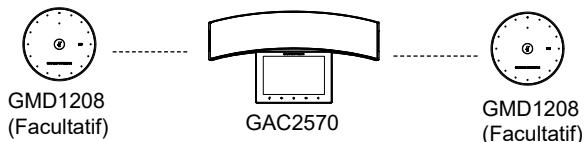

### Micro/Haut-parleur externe

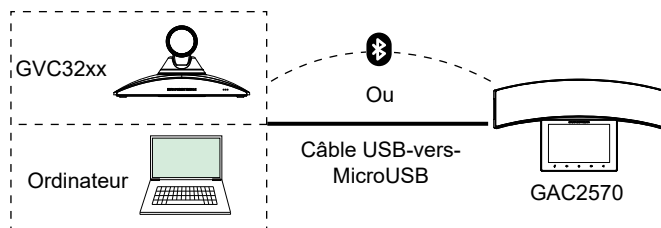

**Note:** veuillez consulter la documentation en ligne pour plus de détails sur les modes d'utilisation du GAC2570, GMD1208 ou GVC32xx. [www.grandstream.com](http://www.grandstream.com)

## Configuration du GAC2570

### via le Navigateur Web

**1**

- Depuis le menu principal, aller à "Paramètres".
- Accéder à "Paramètres ▶ Statut ▶ État du réseau ▶ Adresse IPv4".

**2**

- Entrez l'adresse IP dans le navigateur de votre PC.
- Entrez le nom d'utilisateur et mot de passe pour vous connecter. (Le nom d'utilisateur de l'administrateur par défaut est « admin » et le mot de passe aléatoire par défaut peut être trouvé sur l'autocollant du GAC2570 ).

**Notes:**  
L'ordinateur doit être dans le même LAN que le GAC2570.

### via l'Écran Tactile

- Depuis le menu principal, cliquez sur "Cliquez pour ajouter des comptes" pour configurer le compte SIP.
- Accéder à "Paramètres" pour les paramètres avancés.

Veuillez se référer aux documents en ligne et FAQ pour plus d'informations <http://www.grandstream.com/our-products>



## Packungsinhalt

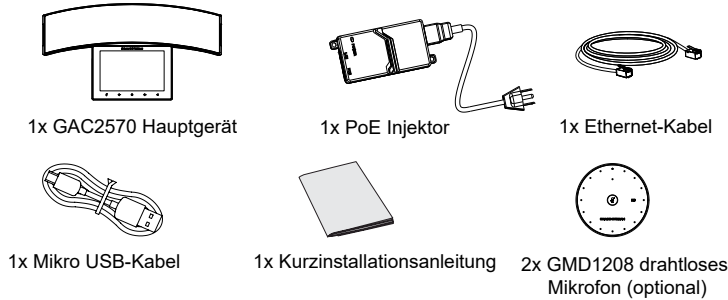

## GAC2570 Beschreibung

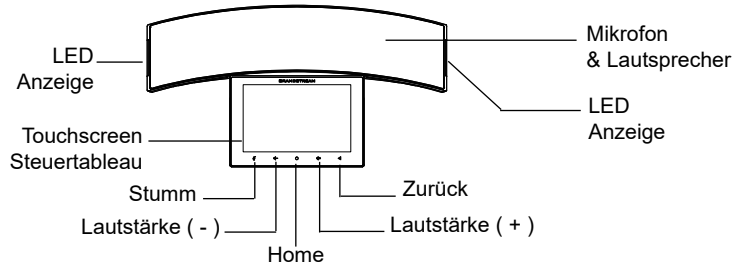

## GAC2570 Verbindung

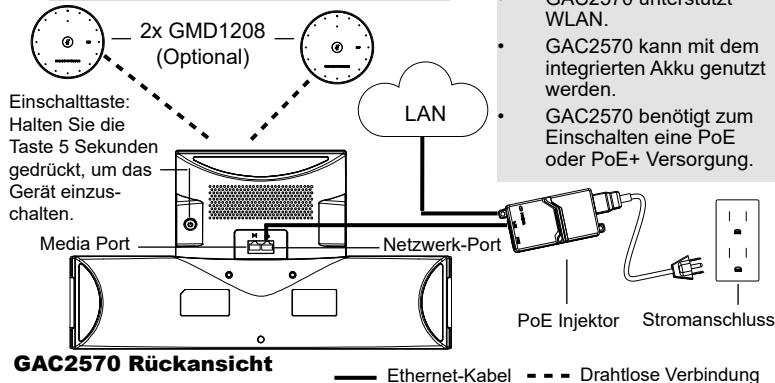

**GAC2570 Rückansicht**

## Weitere Anschlüsse

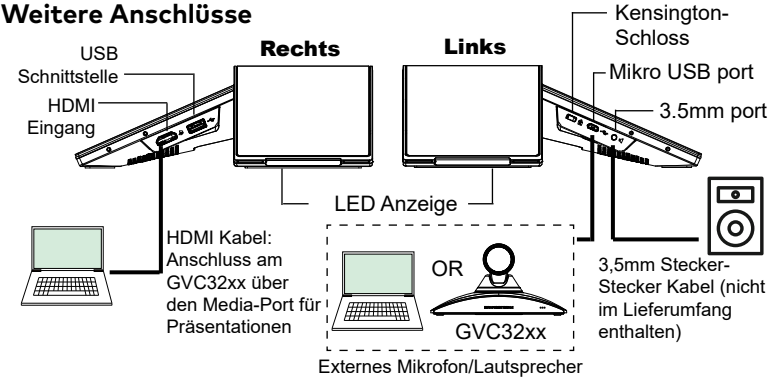

## GAC2570 Nutzungsmodi

### Audiokonferenz Modus

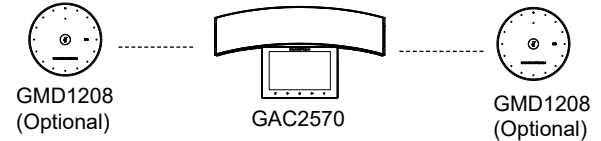

### Externes Mikrofon/Lautsprecher

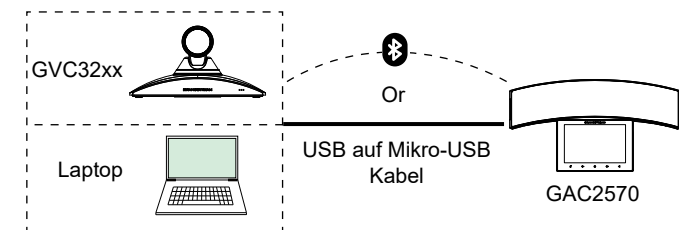

**Hinweis:** Weitere Details zur Nutzung des GAC2570 sowie für GVC32xx und GMD1208 finden erfahren Sie in der Online-Dokumentation. [www.grandstream.com](http://www.grandstream.com)

## GAC2570 Konfiguration

### über einen Webbrowser

1

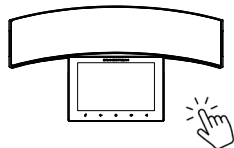

- Vom Hauptmenü wechseln sie bitte ins Menü "Einstellungen" Bildschirm.
- Wechseln zu Einstellungen ► Status ► Netzwerkstatus ► IPv4 adresse".

2



- Tippen Sie die IP Adresse in den Browser an Ihrem PC.
- Geben Sie Benutzername und Passwort ein. Der voreingestellte Administrator-Benutzername lautet "admin", das Zufallspasswort befindet sich auf dem Produktaufkleber auf der Rückseite der GAC2570.

#### Hinweis:

Der PC muss im selben LAN wie das GAC2570 registriert sein.

### mit dem Touchscreen

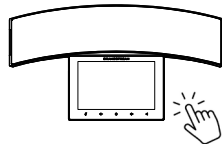

- Zur Konfiguration des SIP Konto drücken Sie im Hauptmenü "Konto hinzufügen"
- Zur weitere Konfiguration wechseln Sie zu "Einstellungen".

Weitere Informationen und Dokumentationen sind online unter:  
<http://www.grandstream.com/our-products>

## Contenuto Della Confezione

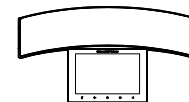

1x GAC2570 Apparecchi principale

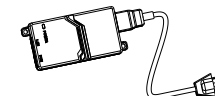

1x Iniettore PoE



1x Cavo Ethernet

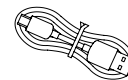

1x Cavo Micro USB

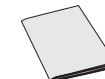

1x Guida di installazione rapida



2x Microfono Wireless GMD1208 (Opzionale)

## GAC2570 Descrizione

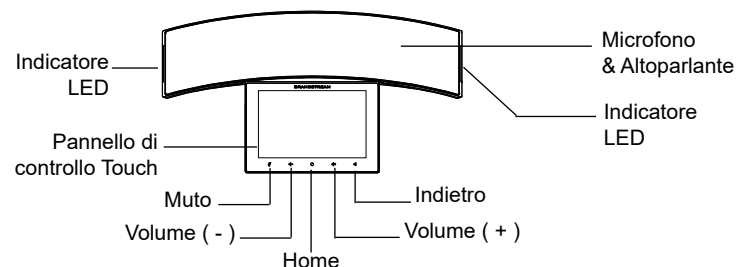

## GAC2570 Connessione

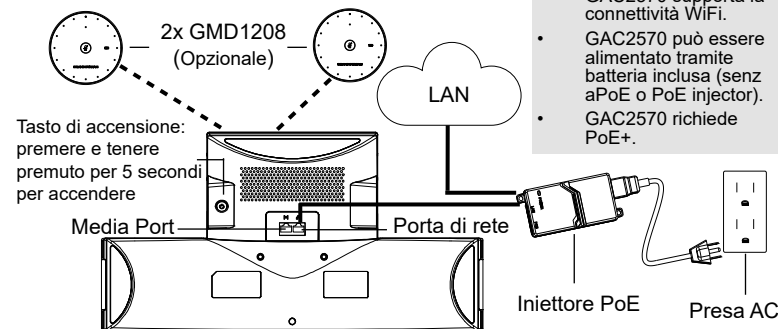

### GAC2570 VISTA POSTERIORE

— Cavo Ethernet - - - Connessione wireless

## Collegamenti ottimali

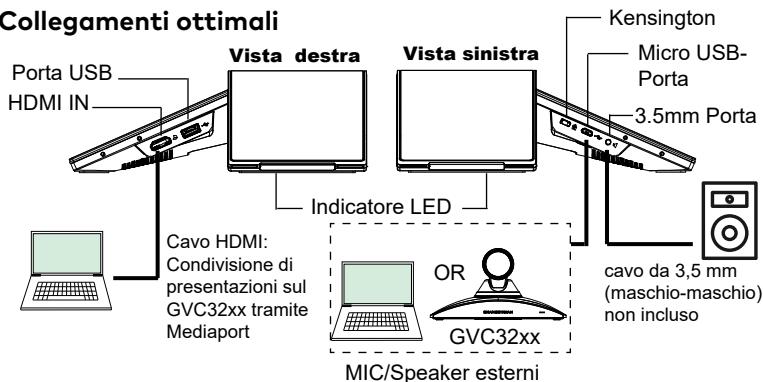

## Modalità di uso GAC2570

### Modalità di sistema di audio conferenza

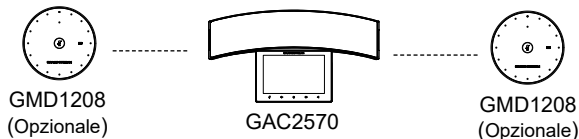

### MIC/Speaker esterni

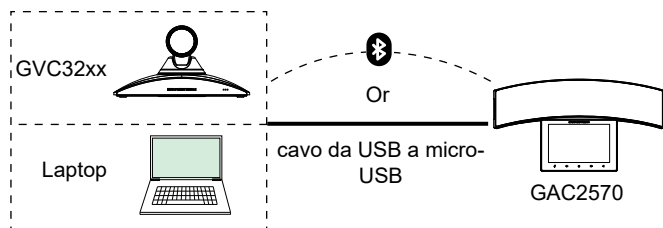

**Nota:** Fa riferimento alla documentazione online per maggiori dettagli riguardanti le modalità di utilizzo del GAC2570, GMD1208 o GVC32xx. [www.grandstream.com](http://www.grandstream.com)

## GAC2570 Configurazione

### Mediante un browser web

**1**

- Dal menu principale, scorrere sullo schermo "impostazioni".
- Accedere a "impostazioni" ► Stato ► Stato della rete ► Indirizzo IPv4".

**2**

- Digitare l'indirizzo IP nel browser del PC.
- Immettere nome utente e password per accedere. (Lo username di default dell'amministratore è "admin" e la password casuale di default può essere trovata sull'etichetta del GAC2570).

**Nota:**  
Il computer deve essere nella stessa LAN del GAC2570.

### Usando il Touch Screen

- Sul menu principale, clicca su "clicca per aggiungere account" per configurare il sip account.
- Accedere a "impostazioni" per configurazione avanzata.

Fare riferimento ai documenti online e alle Domande Frequenti per informazioni più dettagliate: <http://www.grandstream.com/our-products>

## КОМПЛЕКТ ПОСТАВКИ

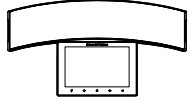

1x корпус GAC2570

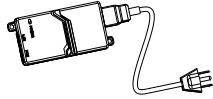

1x PoE-инжектора



1x кабель Ethernet

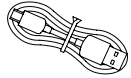

1x кабель Micro USB



1x краткое руководство пользователя



2x Беспроводной Микрофон GMD1208(Опционально)

## GAC2570 Описание

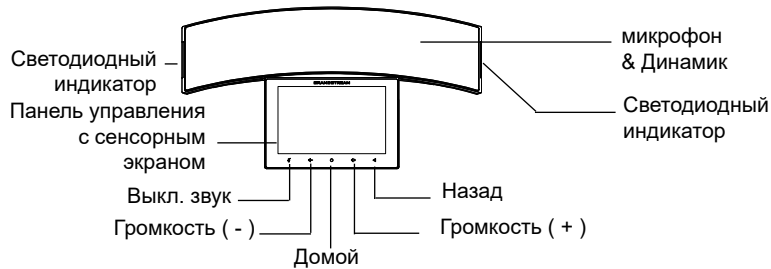

## GAC2570 подключение

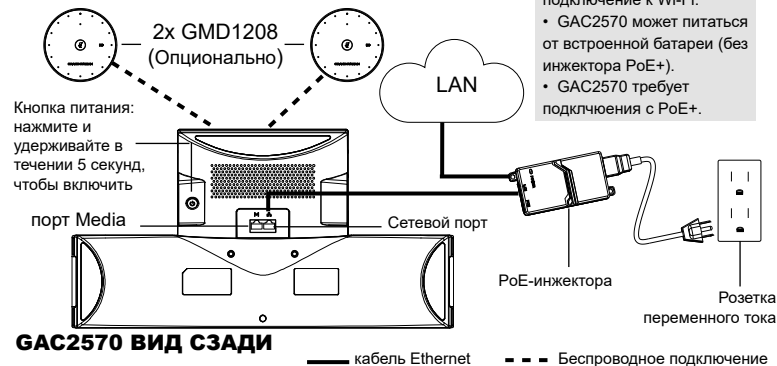

GAC2570 ВИД СЗАДИ

## Дополнительные подключения



## Режимы использования GAC2570

### Режим системы аудиоконференцсвязи

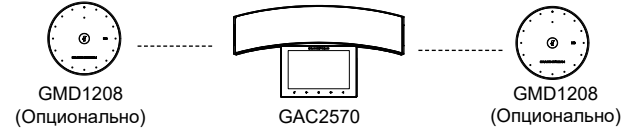

### Внешний микрофон/динамик

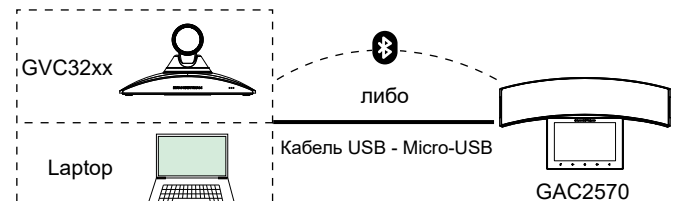

**Примечание:** Дополнительные сведения о режимах использования GAC2570, GMD1208 или GVC32xx смотрите в документации. [www.grandstream.com](http://www.grandstream.com)

## НАСТРОЙКА GAC2570

с помощью веб-обозревателя

1

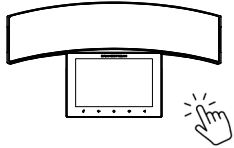

- В главном меню перейдите на экран «Настройки».
- доступа «Настройки App ► Об устройстве ► Состояние сети ► IPv4 адреса».

2



- Введите IP-адрес в браузере вашего ПК.
- Для входа введите имя пользователя и пароль. (Имя пользователя администратора по умолчанию - "admin", случайный пароль по умолчанию можно найти на наклейке на GAC2570).

**Примечание:**

Компьютер должен быть в той же локальной сети, что и GAC2570.

с помощью сенсорного экрана

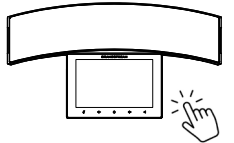

- В главном меню нажмите «Нажмите, чтобы добавить учетные записи», чтобы настроить учетную запись SIP.
- Доступ к приложению «Настройки» для расширенной конфигурации

Смотрите электронные документы и раздел FAQ для более подробной информации: <http://www.grandstream.com/our-products>

## Conteúdo Do Pacote

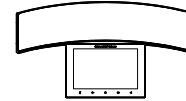

1x GAC2570 Base principal

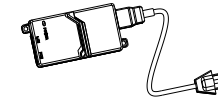

1x Injetor PoE



1x Cabo de ethernet

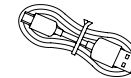

1x Cabo Micro USB

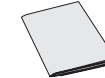

1x Guia de instalação rápida



2x Microfone sem Fio  
GMD1208 (Opcional)

## GAC2570 Descrição

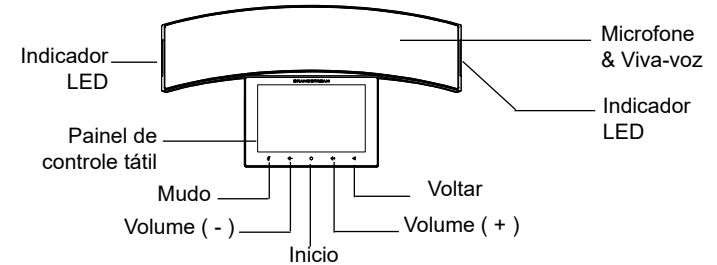

## Connectando o GAC2570

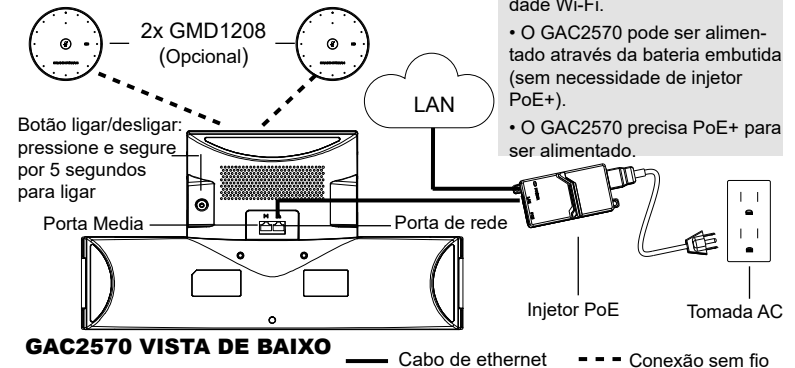

### GAC2570 VISTA DE BAIXO

## Conexões Opcionais

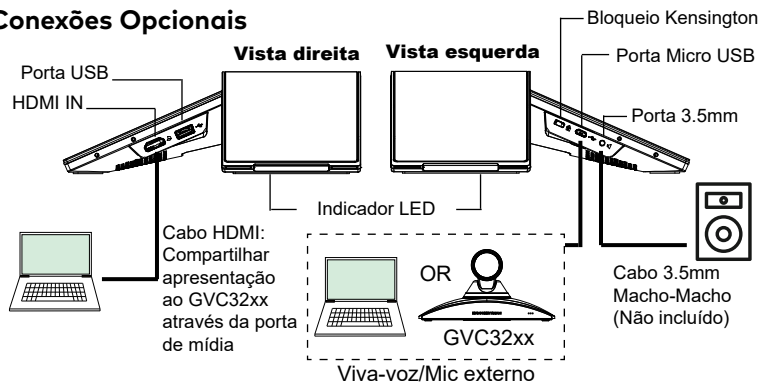

## Modos de uso do GAC2570

### Modo de Audioconferência



GMD1208  
(Opcional)

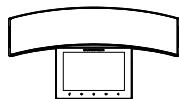

GAC2570



GMD1208  
(Opcional)

### Viva-voz/Mic externo

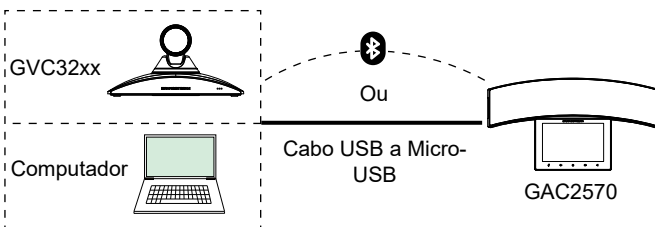

**Observação:** consulte a documentação online para obter mais detalhes sobre os modos de uso do GAC2570, GMD1208 ou GVC32xx. [www.grandstream.com](http://www.grandstream.com)

## Configuração do GAC2570

### Usando Web Browser

1

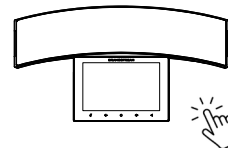

- A partir do menu principal deslize até a tela "Settings".
- acessar "Settings ► Estado ► O status da rede ► endereço IPv4".

2



- Digite o endereço IP no navegador do seu PC.
- Coloque o nome de usuário e a senha para fazer o login. (O nome de usuário padrão para o administrador é "admin" e a senha aleatória predeterminada pode ser encontrada na etiqueta do GAC2570).

#### Observação:

O computador deve estar na mesma LAN que o GAC2570.

### Usando Touch Screen

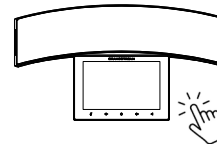

- No menu principal, clique em "Click to add accounts" para configurar a conta SIP.
- Entre no app "Settings" para configurações avançadas.

Consulte os documentos em linha e os FAQ para informação mais detalhada:

<http://www.grandstream.com/our-products>

## ZAWARTOŚĆ OPAKOWANIA

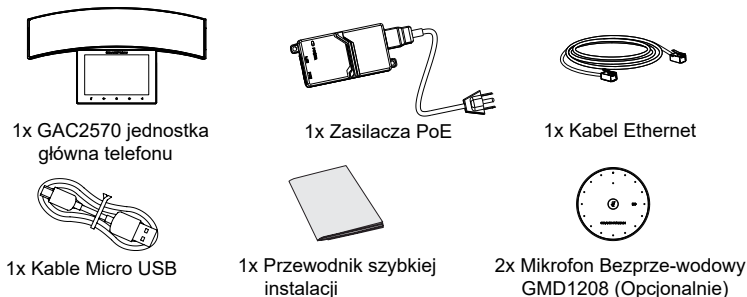

## GAC2570 Opis

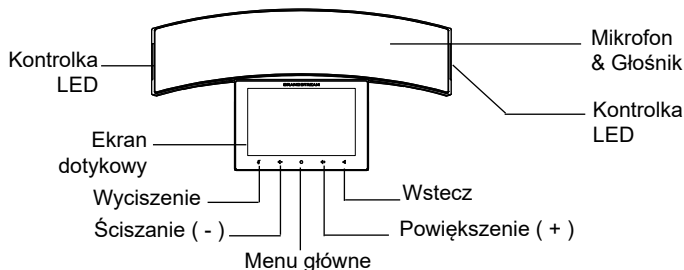

## GAC2570 Połączenie

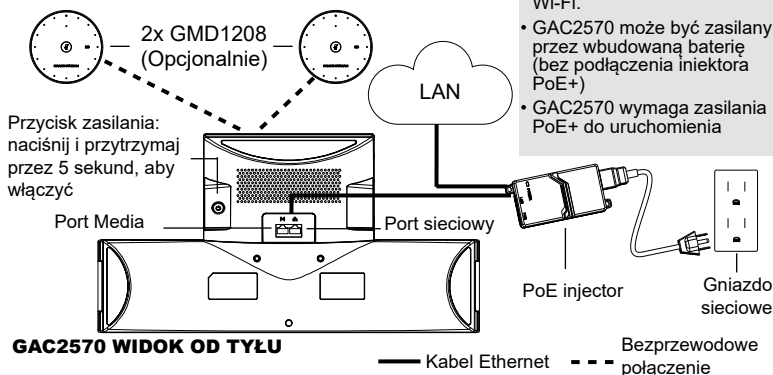

- Uwagi:**
- GAC2570 obsługuje sieć Wi-Fi.
  - GAC2570 może być zasilany przez wbudowaną baterię (bez podłączenia iniektora PoE+)
  - GAC2570 wymaga zasilania PoE+ do uruchomienia

## Połączenia opcjonalne

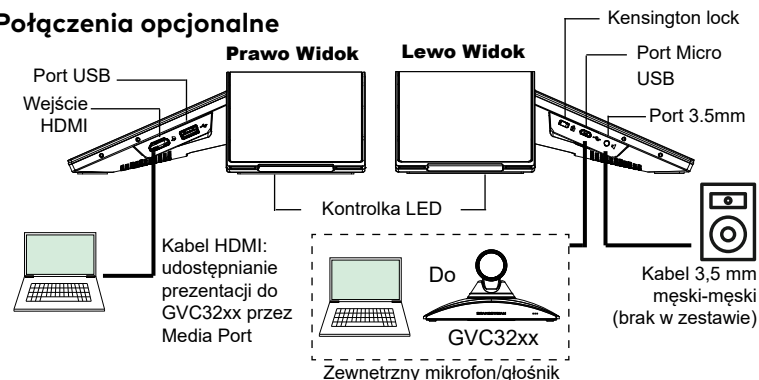

## Tryby użytkowania GAC2570

### Tryb systemu audiokonferencyjnego

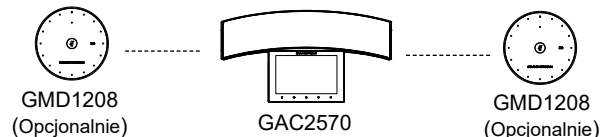

### Zewnętrzny mikrofon/głośnik

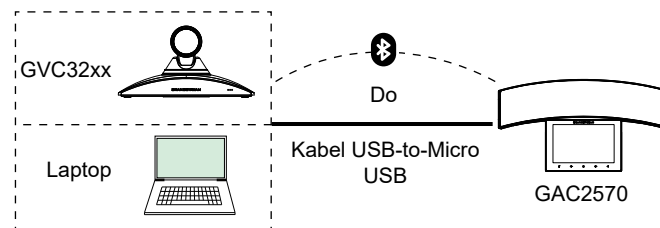

**Uwaga:** Więcej informacji na temat trybów użytkowania GAC2570, GMD1208 lub GVC32xx można znaleźć w dokumentacji online. [www.grandstream.com](http://www.grandstream.com)



## GAC2570 konfiguracji

### za pomocą przeglądarki

1

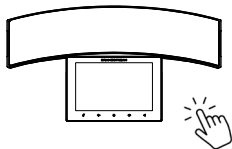

- Z menu głównego przejdź do ekranu "Ustawienia".
- Dostęp "Ustawienia ▶ Status ▶ Stan sieci ▶ Adres IPv4".

2



- Wpisz adres IP w przeglądarce na komputerze.
- Wprowadź nazwę użytkownika i hasło, aby się zalogować. (Domyślną nazwą administratora jest "admin", unikalne wygenerowane hasło znajduje się na naklejce GAC2570).

#### Uwagi:

Komputer musi znajdować się w tej samej sieci LAN co GAC2570.

### za pomocą ekranu dotykowego

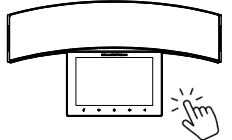

- W menu głównym kliknij „Kliknij, aby dodać konta”, aby skonfigurować konto SIP.
- Uruchom aplikację „Ustawienia” w celu zaawansowanej konfiguracji.

Więcej informacji można znaleźć w dokumentacji online i często zadawanych pytaniach: <http://www.grandstream.com/our-products>

## English

The GAC2570 is not pre-configured to support or carry emergency calls to any type of hospital, law enforcement agency, medical care unit ("Emergency Service(s)") or any other kind of Emergency Service. You must make additional arrangements to access Emergency Services. It is Your responsibility to purchase SIP-compliant Internet telephone service, properly configure the GAC2570 to use that service, and periodically test Your configuration to confirm that it works as You expect. If You don't do so, it is Your responsibility to purchase traditional wireless or landline telephone services to access Emergency Services.

GRANDSTREAM DOES NOT PROVIDE CONNECTIONS TO EMERGENCY SERVICES VIA THE GAC2570. NEITHER GRANDSTREAM NOR ITS OFFICERS, EMPLOYEES OR AFFILIATES MAY BE HELD LIABLE FOR ANY CLAIM, DAMAGE, OR LOSS, AND YOU HEREBY WAIVE ANY AND ALL SUCH CLAIMS OR CAUSES OF ACTION ARISING FROM OR RELATING TO YOUR INABILITY TO USE THE GAC2570 TO CONTACT EMERGENCY SERVICES, AND YOUR FAILURE TO MAKE ADDITIONAL ARRANGEMENTS TO ACCESS EMERGENCY SERVICES IN ACCORDANCE WITH THE IMMEDIATELY PRECEDING PARAGRAPH.

The GNU GPL license terms are incorporated into the device firmware and can be accessed via the Web user interface of the device at [http\(s\)://IP/gpl\\_license](http(s)://IP/gpl_license). To obtain a CD with GPL source code information please submit a written request to [info@grandstream.com](mailto:info@grandstream.com)

⚠ Please DO NOT power cycle the GAC2570 during system boot up or firmware upgrade. You may corrupt firmware images and cause the unit to malfunction.

⚠ Use only the PoE injector included in the GAC2570 package. Using an alternative non-qualified power adapter may possibly damage the unit.

## 简体中文

GAC2570不预投对医院、执法机构、医疗中心(急救服务)以及各种紧急服务的紧急电话服务。用户必须自行设定紧急电话功能。用户必须自行购买SIP兼容的网络电话服务，正确地设定GAC2570使用该服务，并定期测试您的配置以确保GAC2570如预期工作，否则请购买传统无线或有线电话服务来拨打紧急电话。

Grandstream Networks 公司的GAC2570不支持紧急电话服务。Grandstream Networks 公司、其管理者和员工以及其相关机构对此所造成的任何索赔、损失或者损害都不负有任何法律责任。在此，您将无权对任何以及所有由于无法通过GAC2570拨打紧急电话以及没有遵照前段文字描述而造成紧急电话失败的事件提出诉讼。

GNU GPL许可条款已包含在设备固件中，可以通过设备的Web用户界面进行访问：[http\(s\)://IP/gpl\\_license](http(s)://IP/gpl_license)。如果需要包含GPL源代码信息的CD，请发邮件到[info@grandstream.com](mailto:info@grandstream.com)提交请求。

⚠ 请不要在设备启动未完成或设备升级软件的过程中断开电源，因为如刚才所述的操作会导致话机本身的程序损坏，进而导致设备无法启动。

⚠ 请使用设备包装中的PoE电源适配器，因为使用其不合格的电源适配器可能会损坏设备。

## Español

El GAC2570 no está pre-configurado para soportar o realizar llamadas de emergencia a ningún tipo de hospital, agencia policial, unidad de cuidado médico o cualquier otro servicio de emergencia. Es su responsabilidad contratar un servicio de telefonía de Internet compatible con el protocolo SIP, configurar el GAC2570 para utilizar dicho servicio y periódicamente probar esta configuración para confirmar que este trabajando como usted espera. Si es requisito no es completado, es su responsabilidad contratar un servicio de telefonía fija o celular para tener acceso a servicios de emergencia.

GRANDSTREAM NO PROVEE CONEXIONES A SERVICIOS DE EMERGENCIA A TRAVÉS DEL GAC2570. NI GRANDSTREAM NI NINGUNO DE SUS OFICIALES, EMPLEADOS O AFILIADOS SON RESPONSABLES DE NINGUNA DEMANDA, DAÑO O PERDIDA QUE ESTO PUEDA OCASIONAR Y MEDIANTE ESTE COMUNICADO USTED RENUNCIA A CUALQUIER RECLAMO O CONSECUENCIA PROVENIENTE O RELACIONADO A LA INHABILIDAD DE CONTACTAR SERVICIOS DE EMERGENCIAS CON EL GAC2570 Y SU FALTA DE HABER HECHO LOS ARREGLOS DE LUGAR PARA ACCESAR ESTOS SERVICIOS DE EMERGENCIA DE ACUERDO CON EL PÁRRAFO ANTERIOR.

Los términos de licencia GNU GPL son incorporados en el firmware del dispositivo y puede ser accedido a través de la interfaz de usuario Web del dispositivo en [http\(s\)://IP/gpl\\_license](http(s)://IP/gpl_license). Para obtener un CD con la información del código fuente GPL, por favor, remita una solicitud escrita a [info@grandstream.com](mailto:info@grandstream.com)

⚠ No apague el GAC2570 cuando las luces indicadoras se encuentren en estado intermitente al momento de iniciar el equipo o actualizar el firmware. Esto podría ocasionar que la unidad no continúe funcionando correctamente.

⚠ Utilice únicamente el inyector PoE incluido en el paquete del GAC2570. Utilizar una fuente de poder alternativa no calificada podría deteriorar la unidad.

## Français

Le GAC2570 n'est pas préconfiguré pour prendre en charge ou acheminer les appels d'urgence adressés aux hôpitaux, organismes chargés de l'application de la loi, centres de soins médicaux (« service(s) d'urgence ») ou tout autre type de service d'urgence. Vous devez prendre des dispositions supplémentaires pour assurer l'accès aux services d'urgence. Il est de votre responsabilité de vous abonner à un service de téléphonie Internet conforme au protocole SIP, de configurer correctement le GAC2570 pour utiliser ce service, et de tester périodiquement votre configuration pour vous assurer qu'elle fonctionne comme prévu. Si vous ne le faites pas, vous devez

vous abonner à un service de téléphonie sans fil ou fixe traditionnel pour accéder aux services d'urgence.

GRANDSTREAM NE FOURNIT PAS DE CONNEXIONS AUX SERVICES D'URGENCE VIA LE GAC2570 NI GRANDSTREAM. NI SES DIRIGEANTS, EMPLOYES OU SOCIETES AFFILIEES NE PEUVENT ETRE TENUS RESPONSABLES POUR TOUTE RECLAMATION, TOUT DOMMAGE OU PERTE, ET VOUS RENONCEZ PAR LES PRESENTES A TOUTE RECLAMATION OU TOUT MOTIF D'ACTION EN CASITE DECOULANT OU LIE A VOTRE INCAPACITE D'UTILISER LE GAC2570 POUR CONTACTER LES SERVICES D'URGENCE, ET TOUTE NEGLIGENCE DE VOTRE PART QUANT A PRENDRE DES DISPOSITIONS SUPPLEMENTAIRES POUR ACCEDER AUX SERVICES D'URGENCE CONFORMEMENT A L'ALINEA PRECEDENT.

Les termes de la licence GNU GPL sont incorporés dans le micrologiciel du périphérique et sont accessibles via l'interface utilisateur Web du périphérique à l'adresse [http\(s\)://IP/gpl\\_license](http(s)://IP/gpl_license). Pour obtenir un CD contenant les informations du code source GPL, veuillez envoyer une demande écrite à [info@grandstream.com](mailto:info@grandstream.com)

⚠ Veuillez ne pas redémarrer le GAC2570 lors du démarrage du système ou la mise à jour du firmware. Ceci peut corrompre l'image du firmware et causer un dysfonctionnement de l'unité.

⚠ N'utilisez que l'adaptateur d'alimentation fourni dans le pack GAC2570. L'utilisation d'un autre adaptateur d'alimentation non qualifié peut endommager l'unité.

## Deutsch

Im GAC2570 sind keine Notfallruffnummern voreingestellt oder vorkonfiguriert. Das GAC2570 tätigt keine automatischen Anrufe zu medizinischen, sozialen oder juristischen Hilfs- oder Serviceorganisationen. Die Anbindung an derartige Einrichtungen muss separat eingestellt bzw. zur Verfügung gestellt werden. Es liegt in der Verantwortung des Nutzers, einen SIP-konformen Internet-Telefon-Service zu buchen, der die Nutzung der örtlichen und überregionalen Notfallnummern sicherstellt. Bietet der SIP-Anbieter diesen Service nicht, liegt es in der Verantwortung des Nutzers, einen analogen bzw. alternativen Telefonanschluss zusätzlich bereitzustellen, um eine telefonische Anbindung für Notfälle sicherstellen zu können.

GRANDSTREAM STELLT MIT DEM GAC2570 KEINE VERBINDUNG ZU NOTFALLRUFNUMMER ODER DIE ANBINDUNG AN NOTFALLZENTREN ZUR VERFÜGBARKEIT. WEDER GRANDSTREAM, NOCH GRANDSTREAM MITARBEITER, ANGESTELLTE ODER SONSTIGE FIRMEANGEHÖRIGE SIND FÜR DIE ANBINDUNG DES GAC2570 AN EINEN MEDIZINISCHEN SERVICE ODER ANDEREN NOTFALLDIENST ZUSTÄNDIG, BZW. VERANTWORTLICH. ES OBLIHT ALLEINIG IN DER VERANTWORTUNG DER GAC2570 NUTZER BZW. DER GAC2570 BESITZER, FÜR EINE NETZANBINDUNG ZU SORGEN, WELCHE DIE NUTZUNG VON MEDIZINISCHEN ODER ANDEREN NOTFALLRUFNUMMERN SICHERSTELLT.



Die GNU GPL Lizenz ist in der Geräte-software hinterlegt und kann über die Web-Schnittstelle unter [http://s://IP/gpl\\_license](http://s://IP/gpl_license).

Um eine CD mit der Lizenz zu erhalten, senden Sie uns bitte eine Email an [info@Grandstream.com](mailto:info@Grandstream.com).

⚠ Bitte unterbrechen Sie während des Systemstarts bzw. Während eines Software-Upgrades des GAC2570 NICHT die Stromzufuhr. Eine Unterbrechung kann ein Fehlverhalten hervorrufen und das Telefon zerstören.

⚠ Verwenden Sie nur den mitgelieferten PoE Injektor. Andere Produkte zur Stromversorgung können das Gerät beschädigen.

## Italiano

GAC2570 non è preconfigurato per supportare o effettuare chiamate di emergenza a qualsiasi tipo di ospedale, struttura giudiziaria, unità di assistenza medica ("Servizi di emergenza") o a qualsiasi altro tipo di servizio di emergenza. È necessario effettuare accordi supplementari per ac emergenza. E' a Vostra esclusiva responsabilità acquistare servizi di telefonia internet conformi con SIP, configurare GAC2570 correttamente per usare tale servizio ed effettuare test periodici della configurazione per assicurarsi che funzioni in modo idoneo. Se non si effettua ciò è Vostra responsabilità acquistare servizi telefonici fissi o wireless tradizionali per accedere ai Servizi di emergenza.

GRANDSTREAM NON FORNISCE COLLEGAMENTI AI SERVIZI DI EMERGENZA ATTRAVERSO IL GAC2570. NE GRANSITREAM NE I SUOI RESPONSABILI, DIPENDENTI O AFFILIATI POSSONO ESSERE RITENUTI RESPONSABILI DI QUALSIASI RECLAMO, DANNO O PERDITA, E DI QUALSIASI AZIONE LEGALE DERIVANTE DA TALI RECLAMI O CAUSE IN RELAZIONE ALL'IMPOSSIBILITÀ DI USARE IL GAC2570 PER CHIAMATE AI SERVIZI O DI STRINGERE ACCORDI SUPPLEMENTARI PER ACCEDERE AI SERVIZI DI EMERGENZA IN CONFORMITÀ AL PARAGRAFO PRECEDENTE.

I termini della licenza GNU GPL sono incorporati nel firmware del dispositivo e sono accessibili tramite l'interfaccia utente Web del dispositivo a: [http://s://IP/gpl\\_license](http://s://IP/gpl_license). Per ottenere un CD con informazioni sul codice sorgente GPL, si prega di inviare una richiesta scritta a [info@grandstream.com](mailto:info@grandstream.com).

⚠ NON spegnere/acendere il GAC2570 durante l'avvio del sistema o l'aggiornamento del firmware. Ciò potrebbe comportare il danneggiamento del firmware e il malfunzionamento dell'unità.

⚠ Usare solo il PoE injector incluso nella scatola del GAC2570. Usare sorgenti di alimentazione alternative non certificate potrebbe danneggiare il prodotto.

## Русский

GAC2570 предварительно не сконфигурирован для поддержки или переноса экстренных звонков в кабриоло больницы, правоохранительные органы, отделения медицинской помощи ("экстренная (-ые) Служба (-ы)"), или кабриоло другие Экстренные службы. Следует произвести дополнительные настройки для доступа к Экстренным Службам. Вы ответственны за подключение SIP-совместимый интернет-телефонной службы, правильную настройку GAC2570 для ее использования, а также периодическое

тестирование Вашей конфигурации для проверки ее работы в соответствии с Вашими требованиями. Если Вы это не делаете, Вы будете ответственны за подключение традиционных беспроводных или проводных телефонных служб для доступа к Экстренным Службам.

GRANDSTREAM НЕ ПРЕДОСТАВЛЯЕТ СОЕДИНЕНИЯ С ЭКСТРЕННЫМИ СЛУЖБАМИ ПОСРЕДСТВОМ GAC2570. GRANDSTREAM, ЕГО СЛУЖАЩИЕ, РАБОТНИКИ И ОТДЕЛЕНИЯ НЕ НЕСУТ ОТВЕТСТВЕННОСТИ ЗА ПРЕТЕНЗИИ, УЩЕРБ ИЛИ УТРАТУ, И ВЫ НАСТОЯЩИМ ОТКАЗЫВАЕТЕСЬ ОТ КАКИХ-ЛИБО ЗАЯВЛЕНИЙ ИЛИ ИСКОВЫХ ОСНОВАНИЙ, ПРОИСТЕКАЮЩИХ ИЗ ВАШЕЙ НЕСПОСОБНОСТИ ИСПОЛЬЗОВАТЬ GAC2570 ДЛЯ СВЯЗИ С ЭКСТРЕННЫМИ СЛУЖБАМИ И НЕПРИНЯТИЯ С ВАШЕЙ СТОРОНЫ МЕР ПО ОБЕСПЕЧЕНИЮ ДОСТУПА К ЭКСТРЕННЫМ СЛУЖБАМ В СООТВЕТСТВИИ С ВЫШЕСЛЕДУЮЩИМ ПАРАГРАФОМ.

Условия лицензии GNU GPL включены в прошивку устройства и доступны через веб-интерфейс пользователя устройства по адресу [http://s://IP/gpl\\_license](http://s://IP/gpl_license).

Для получения компакт-диска с информацией об исходном коде GPL, пожалуйста, отправьте письменный запрос по адресу [info@grandstream.com](mailto:info@grandstream.com).

⚠ Пожалуйста, не перезагружайте GAC2570 путем выключения питания во время начальной загрузки системы или обновления встроенной программы. Вы можете повредить образы встроенной программы и вызвать неправильную работу устройства.

⚠ Используйте только инжектор PoE, входящий в комплект GAC2570. Использование альтернативного несовместимого источника питания может привести к повреждению устройства.

## Português

O GAC2570 não é pré-configurado para suportar ou realizar chamadas de emergência a qualquer tipo de hospital, agência policial, unidade de atendimento médico ("Serviço (s) de emergência"), ou qualquer outro tipo de serviço de emergência. Você deverá tomar providências adicionais para acessar serviços de emergência. É da sua responsabilidade adquirir serviço de telefonia via Internet compatível com o protocolo SIP, configurar corretamente o GAC2570 para usar esse serviço e periodicamente testar a configuração para confirmar que ele funciona como você espera. Se você não fizer isso, é da sua responsabilidade adquirir os serviços tradicionais de telefones celulares ou fixos para acessar serviços de emergência.

GRANDSTREAM NÃO FORNECE CONEXÕES A SERVIÇOS DE EMERGENCIA ATRAVES DO GAC2570. NEM GRANDSTREAM, NEM OS SEUS DIRIGENTES, EMPREGADOS OU AFILIADOS PODEM SER RESPONSÁVEIS POR QUALQUER RECLAMAÇÃO, DANNO OU PERDA, E VOCÊ, NESTE ATO, RENUNCIA QUALQUER E TODAS REIVINDICAÇÕES OU MOTIVOS DE AÇÃO RESULTANTES DA OU RELATIVA À SUA INCAPACIDADE DE USAR O GAC2570 PARA CONTATAR SERVIÇOS DE EMERGENCIA E POR NÃO FAZER ARRANJOS ADICIONAIS PARA ACESSAR AOS SERVIÇOS DE EMERGENCIA, SE-

GUNDO O PARÁGRAFO IMEDIATAMENTE ANTERIOR.

Os termos de licença GNU GPL estão dentro do firmware do dispositivo e você pode visualizar o documento através da interface web do dispositivo, em [http://s://IP/gpl\\_license](http://s://IP/gpl_license).

Para obter um CD com a informação do código fonte GPL, por favor solicite-o através de [info@grandstream.com](mailto:info@grandstream.com).

⚠ Por favor NÃO desligue a energia do GAC2570 durante o início do sistema ou durante a atualização de firmware. Você poderá corromper a imagem do firmware e originar o mau funcionamento da unidade.

⚠ Use apenas o injetor PoE incluído no pacote GAC2570. O uso de uma fonte de alimentação alternativa não qualificada pode danificar a unidade.

## PolSKI

Urządzenie GAC2570 nie jest wstępnie skonfigurowane do obsługi lub wykonywania połączeń alarmowych do szpitali, organów ochrony publicznej, jednostek opieki medycznej (zwaných dalej „slużbami ratunkowymi”) ani jakichkolwiek innych sluzb ratunkowych. Aby uzyskać dostęp do sluzb ratunkowych, konieczne jest wyro adzenie dodatkowych ustawień. Użytkownik jest odpowiedzialny za zakup usługi telefonii internetowej zgodnej z protokołem SIP, odpowiednią konfigurację urządzenia GAC2570 umożliwiającą korzystanie z tej usługi oraz okresowe testy konfiguracji w celu sprawdzenia, czy działa ono zgodnie z oczekiwaniami. W przypadku niewykonania tych czynności użytkownik jest odpowiedzialny za zakup tradycyjnych bezprzewodowych lub przewodowych usług telefonicznych w celu uzyskania dostępu do sluzb ratunkowych.

FIRMA GRANDSTREAM NIE ZAPEWNIAMÓŻLIWOŚCI POŁĄCZENIA ZE SŁUŻBAMI RATUNKOWYMI ZA POŚREDNICTWEM URZĄDZENIA GAC2570. FIRMA GRANDSTREAM, JEJ KIEROWNICTWO, PRACOWNICY ANI PODMOCY STOWARZYSZONE NIE MOGĄ BYĆ POCIĄGNIĘTE DO ODPOWIEDZIALNOŚCI ZTYTUŁU JAKICHKOLWIEK ROSZCZEN, SZKÓD LUB STRAT, A UŻYTKOWNIK NIEMIJSZYCH ZRZEKA SIĘ WSZELKICH TEGO TYTUŁU ROSZCZEN I PODSTAW PÓWÓDZTWA WYNIKAJĄCYCH LUB POWIĄZANYCH Z NIEMOŻLIWOŚCIĄ UŻYCIA URZĄDZENIA GAC2570 W CELU NAWIĄZANIA KONTAKTU ZE SŁUŻBAMI RATUNKOWYMI I NIEWPROWADZIENIEM DODATKOWYCH USTAWIEN LMOŻLIWIĄCYCH UZYSKANIE DOSTĘPU DO SŁUŻB RATUNKOWYCH ZGODNIE Z INFORMACJAMI W POPRZEDNIM AKAPICIE.

Warunki licencji GNU GPL użyte są nieodłączną częścią oprogramowania systemowego urządzenia i można uzyskać do nich dostęp za pośrednictwem sieciowego interfejsu użytkownika urządzenia, wybierając opcję [http://s://IP/gpl\\_license](http://s://IP/gpl_license). Aby otrzymać płytę CD z informacjami dotyczącymi kodu źródłowego GPL, należy przesłać prośbę na piśmie na adres [info@grandstream.com](mailto:info@grandstream.com).

⚠ Prosimy NIE wyłączać urządzenia GAC2570 trakcie uruchamiania systemu lub aktualizacji oprogramowania układowego. Może to uszkodzić obrazy oprogramowania układowego i spowodować niewłaściwe działanie urządzenia.

⚠ Używaj tylko injektora PoE zawartego w pakiecie GAC2570. Korzystanie z alternatywnego niekompatybilnego źródła zasilania może spowodować uszkodzenie urządzenia.

For certification information, please refer to User Manuals:

<http://www.grandstream.com>

**Common part:**

This equipment complies with radiation exposure limits set forth for an uncontrolled environment. This transmitter must not be co-located or operating in conjunction with any other antenna or transmitter. This equipment should be installed and operated with minimum distance 20cm between the radiator& your body.

Après examen de ce matériel aux conformité ou aux limites d'intensité de champ RF, les utilisateurs peuvent sur l'exposition aux radiofréquences et la conformité and compliance d'acquérir les informations correspondantes. La distance minimale du corps à utiliser le dispositif est de 20cm.

**U.S. FCC Part 15 Regulatory Information**

This device complies with part 15 of the FCC Rules. Operation is subject to the following two conditions: (1) this device may not cause harmful interference, and (2) this device must accept any interference received, including interference that may cause undesired operation.

Any Changes or modifications not expressly approved by the party responsible for compliance could void the user's authority to operate the equipment.

Note: This equipment has been tested and found to comply with the limits for a Class B digital device, pursuant to part 15 of the FCC Rules. These limits are designed to provide reasonable protection against harmful interference in a residential installation. This equipment generates, uses and can radiate radio frequency energy and, if not installed and used in accordance with the instructions, may cause harmful interference to radio communications. However, there is no guarantee that interference will not occur in a particular installation. If this equipment does cause harmful interference to radio or television reception, which can be determined by turning the equipment off and on, the user is encouraged to try to correct the interference by one or more of the following measures:

- Reorient or relocate the receiving antenna.
- Increase the separation between the equipment and receiver.
- Connect the equipment into an outlet on a circuit different from that to which the receiver is connected.
- Consult the dealer or an experienced radio/TV technician for help.

**Canada Regulatory Information**

**Radio equipment**

Operation of 5150-5350 MHz is restricted to indoor use only.

This device contains licence-exempt transmitter(s)/receiver(s) that comply with Innovation, Science and Economic Development Canada's licence-exempt RSS(s). Operation is subject to the following two conditions:

- (1) This device may not cause interference.
- (2) This device must accept any interference, including interference that may cause undesired operation of the device.

Le fonctionnement de 5150-5350 MHz est limité à une utilisation en intérieur uniquement. L'émetteur/récepteur exempt de licence contenu dans le présent appareil est conforme aux CNR d'Innovation, Sciences et Développement économique Canada applicables aux appareils radio exempts de licence. L'exploitation est autorisée aux deux conditions suivantes :

- 1) L'appareil ne doit pas produire de brouillage;
- 2) L'appareil doit accepter tout brouillage radioélectrique subi, même si le brouillage est susceptible d'en compromettre le fonctionnement.

CAN ICES-3 (B)/NMB-3(B)