



Ke Mei Ou Lab Corp.

E506, 5th Floor, No.39 Keji Middle 2nd Rd, Science & Technology  
Park, Nanshan District, Shenzhen, P. R. China  
Tel: + 86 755 83642690 Fax: + 86 755 83297077  
[www.kmolab.com](http://www.kmolab.com)

# FCC TEST REPORT

Under:  
FCC Part 15, Class B

Prepared For :

**Grandstream Networks, Inc.**

126 Brookline Ave, 3rd Floor Boston, MA 02215, USA

<b>FCC ID: YZZDP750</b>
<b>EUT: DECT Repeater</b>
<b>Model: DP760 (Base Unit)</b>
December 19, 2016 <b>Issue Date:</b>
Original Report <b>Report Type:</b>
<i>Jacky Huang</i> <b>Test Engineer: Jacky Huang</b>
 <b>Review By: Apollo Liu / Manager</b>

The test report consists 25 pages in total. It may be duplicated completely for legal use with the allowance of the applicant. It shall not be reproduced except in full, without the written approval of Ke Mei Ou Laboratory Corporation. The test result in the report only applied to the tested sample.

## TABLE OF CONTENTS

<b>1. General Information .....</b>	<b>3</b>
1. 1 Notes.....	3
1. 2 Testing Laboratory.....	3
1. 3 Details of Applicant.....	3
1. 4 Application Details .....	3
1. 5 Test Item .....	3
1. 6 Test Standards.....	3
<b>2. Technical Test.....</b>	<b>4</b>
2. 1 Summary of Test Results .....	4
<b>3. EUT Modifications .....</b>	<b>4</b>
<b>4. Conducted Power Line Test.....</b>	<b>5</b>
4. 1 Test Equipment.....	5
4. 2 Test Procedure .....	5
4. 3 Test Setup .....	5
4. 4 Configuration of The EUT.....	6
4. 5 EUT Operating Condition.....	7
4. 6 Conducted Power Line Emission Limits .....	7
4. 7 Conducted Power Line Test Result.....	8
<b>5. Radiated Emission Test.....</b>	<b>10</b>
5. 1 Test Equipment.....	10
5. 2 Test Procedure .....	10
5. 3 Radiated Test Setup .....	10
5. 4 Configuration of The EUT.....	11
5. 5 EUT Operating Condition.....	11
5. 6 Radiated Emission Limit .....	11
5. 7 Radiated Emission Test Result.....	12
<b>6. Photo of Testing.....</b>	<b>16</b>
6.1 Emission test view.....	16
6.2 Photograph - EUT.....	18
<b>7. FCC ID Label.....</b>	<b>24</b>
<b>8. Test Equipment.....</b>	<b>25</b>

## 1. General Information

### 1.1 Notes

The test results of this report relate exclusively to the test item specified in 1.5. The KMO Lab does not assume responsibility for any conclusions and generalizations drawn from the test results with regard to other specimens or samples of the type of the equipment represented by the test item. The test report may only be reproduced or published in full. Reproduction or publication of extracts from the report requires the prior written approval of the KMO Lab.

### 1.2 Testing Laboratory

Accurate Technology Co., Ltd.  
(FCC Registration No.: 752051)  
F1, Bldg. A, Changyuan New Material Port  
Keyuan Rd., Science & Industry Park, Nanshan  
Shenzhen, P.R. China

### 1.3 Details of Applicant

Name : Grandstream Networks, Inc.  
Address : 126 Brookline Ave, 3rd Floor Boston, MA 02215, USA

### 1.4 Application Details

Date of Receipt of Application : November 1, 2016  
Date of Receipt of Test Item : November 1, 2016  
Date of Test : November 1 ~ December 19, 2016

### 1.5 Test Item

Manufacturer : Same as applicant  
Address : Same as applicant  
Trade Name : Grandstream  
Model No.(Base) : DP760 (Base Unit)  
Model No.(Extension) : N/A  
Description : DECT Repeater

### Additional Information

Frequency : 1921.536~1928.448MHz  
RF Power : FP- Ant0: 85.11mW, Ant1:84.13mW(Conducted Peak)  
Number of Channels : 5  
Type of Modulation : GFSK  
Power Supply : DC 5V/1A(Adapter model: F06US0500100A)  
DC 5V/1A(Adapter model: NBS05B050100VU)  
Antenna : FP-Internal Ant0&Ant1 (0dBi)

UPCS Channel	Frequency (MHz)
Upper Band Edge	1930.000
0 (Highest)	1928.448
1	1926.720
2	1924.992
3	1923.264
4 (Lowest)	1921.536
Lower Band Edge	1920.000

Requirement: FCC15.303(d),(g) Within 1920~1930 MHz band for isochronous devices.

Requirement: FCC15.303(d),(g) Within 1920~1930 MHz band for isochronous devices.

### 1.6 Test Standards

FCC Part 15, Class B

Note: All radiated measurements were made in all three orthogonal planes. The values reported are the maximum values.

## 2. Technical Test

### 2.1 Summary of Test Results

The EUT has been tested according to the following specifications:

Standard	Test Type	Result	Notes
FCC Part 15, Paragraph 15.107	Conducted Test	PASS	Complies
FCC Part 15, Paragraph 15.109	Radiated Test	PASS	Complies

### 3. EUT Modifications

No modification by test lab.

## 4. Conducted Power Line Test

### 4.1 Test Equipment

Please refer to Section 8 this report.

### 4.2 Test Procedure

The EUT and simulators are connected to the main power through a line impedance stabilization network (L.I.S.N.). This provides a 50 ohm/50uH coupling impedance for the measuring equipment. The peripheral devices are also connected to the main power through a LISN that provides a 50ohm/50uH coupling impedance with 50ohm termination.

Both sides of A.C. line are checked for maximum conducted interference. In order to find the maximum emission., the relative positions of equipment and all of the interface cables must be changed according to ANSI C63.4:2014 on conducted measurement. Conducted emissions were invested over the frequency range from 0.15MHz to 30MHz using a receiver bandwidth of 9kHz.

### 4.3 Test Setup

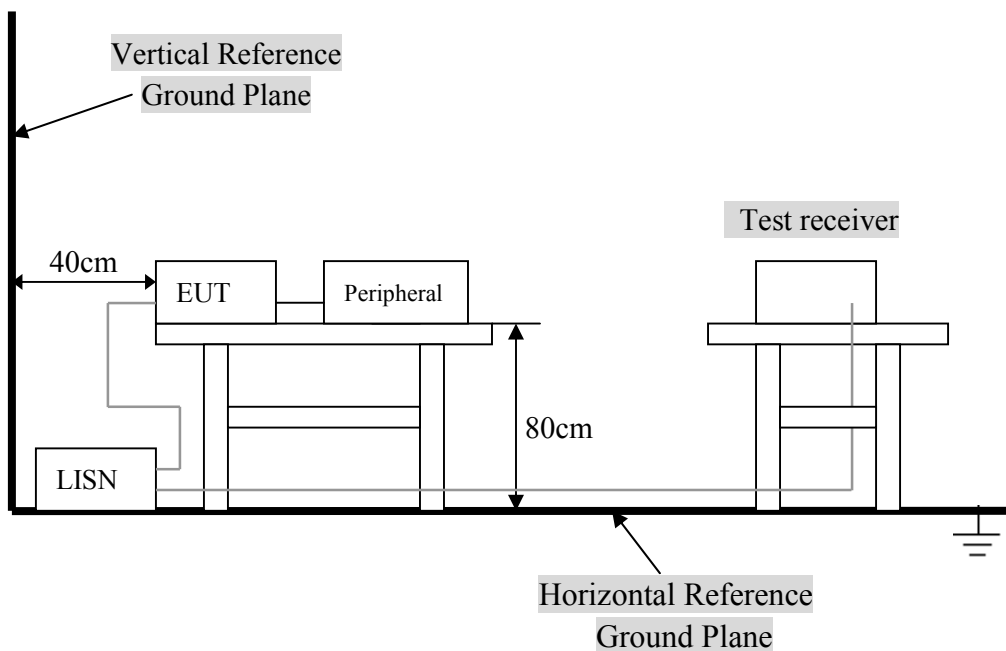

For the actual test configuration, Please refer to the related items – Photos of Testing.

#### 4.4 Configuration of The EUT

The EUT was configured according to ANSI C63.4:2014. All interface ports were connected to the appropriate peripherals. All peripherals and cables are listed below.

##### A. EUT

Device	Manufacturer	Model #	FCC ID
DECT Repeater	DP760	YZZDP760	DP760

##### B. Internal Devices

Device	Manufacturer	Model #	FCCID / DoC
N/A			

##### C. Peripherals

Device	Manufacturer	Model # Serial #	FCC ID/ DoC	Cable
Notebook	ACER	ZQE	HLZ-AR5B97	1.5m unshielded power cord

## 4.5 EUT Operating Condition

Operating condition is according to ANSI C63.4:2014.

- A. Setup the EUT and simulators as shown on follow.
- B. Enable RF signal and confirm EUT active.
- A. Modulate output capacity of EUT up to specification.

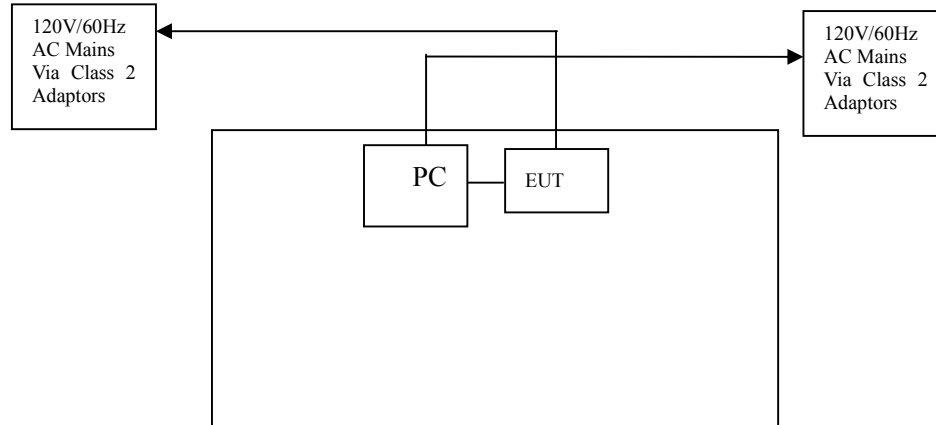

## 4.6 Conducted Power Line Emission Limits

Frequency Range (MHz)	Class A QP/AV (dBuV)	Class B QP/AV (dBuV)
0.15 – 0.5	79/66	66 –56/56 –46
0.5 – 5.0	73/60	56/46
5.0 – 30	73/60	60/50

**Note:** In the above table, the tighter limit applies at the band edges.

## 4.7 Conducted Power Line Test Result

Product	: DECT Repeater	Test Mode	: Normal Link / Auto
Test Item	: Conducted Emission Data	Temperature	: 25 °C
Test Voltage	: DC 5V	Humidity	: 56%RH
Test Result	: <b>PASS</b>	Adapter Model	:

The frequency spectrum from 0.15 MHz to 30 MHz was investigated. All readings are quasi -peak values with a resolution bandwidth of 9 KHz.

- Temperature : 26 °C
- Humidity : 53 % RH

FP:

Adapter model: F06US0500100A

FCC Part 15 Paragraph 15.107							
Frequency (MHz)	Emission (dBuV)		LINE/NEUTRAL	Limit (dBuV)		Margin (dB)	
	QP	AV		QP	AV	QP	AV
0.182	38.45	29.67	Line	64.39	54.39	-25.94	-24.72
0.410	39.77	31.20	Neutral	57.65	47.65	-17.88	-16.45
0.434	32.69	26.97	Line	57.18	47.18	-24.49	-20.21
0.458	43.65	34.12	Neutral	56.73	46.73	-13.08	-12.61
0.862	32.89	26.65	Line	56.00	46.00	-23.11	-19.35
0.470	39.15	30.91	Neutral	56.51	46.51	-17.36	-15.60

Note: NF = No Significant Peak was Found.

Adapter model: NBS05B050100VU

FCC Part 15 Paragraph 15.107							
Frequency (MHz)	Emission (dBuV)		LINE/NEUTRAL	Limit (dBuV)		Margin (dB)	
	QP	AV		QP	AV	QP	AV
0.166	41.96	32.18	Line	65.16	55.16	-23.20	-22.98
0.178	40.42	30.81	Neutral	64.58	54.58	-24.16	-23.77
0.394	46.45	33.42	Line	57.98	47.98	-11.53	-14.56
0.402	37.35	30.22	Neutral	57.81	47.81	-20.46	-17.59
5.526	35.12	25.13	Line	60.00	50.00	-24.88	-24.87
7.402	36.31	24.92	Neutral	60.00	50.00	-23.69	-25.08

Note: NF = No Significant Peak was Found.

Note:

- 1.Uncertainty in conducted emission measured is <+/- 2dB.
- 2.The emission levels of other frequencies were very low against the limit.
- 3.All Reading Levels are Quasi-Peak and Average value.
- 4.Emission = Meter Reading + Factor; Factor = Insertion Loss + Cable Loss.
- 5.Margin Value = Emission Level - Limit Value.



**Conducted Emission**

**FCC 15.107**

Test Specification: LINE&NEUTRAL

Comment:

FP:

Adapter model: F06DE0500100A

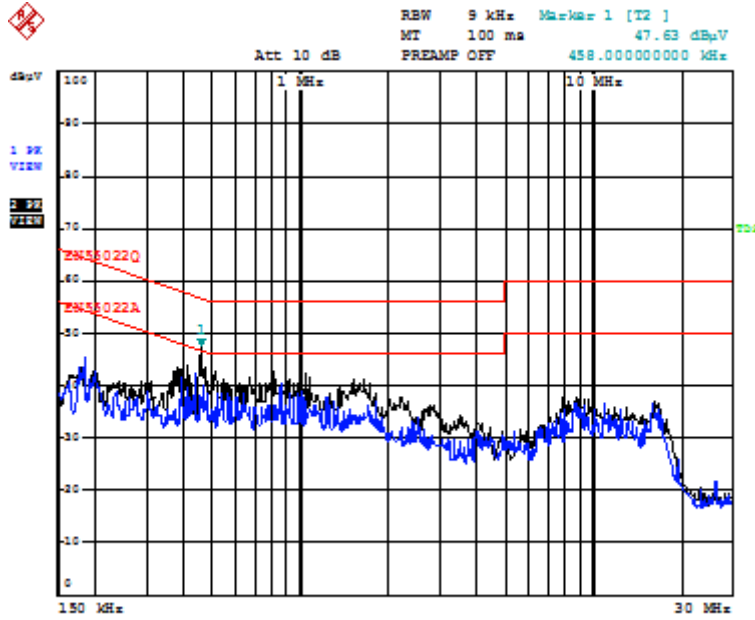

Adapter model: NBS05B050100VE

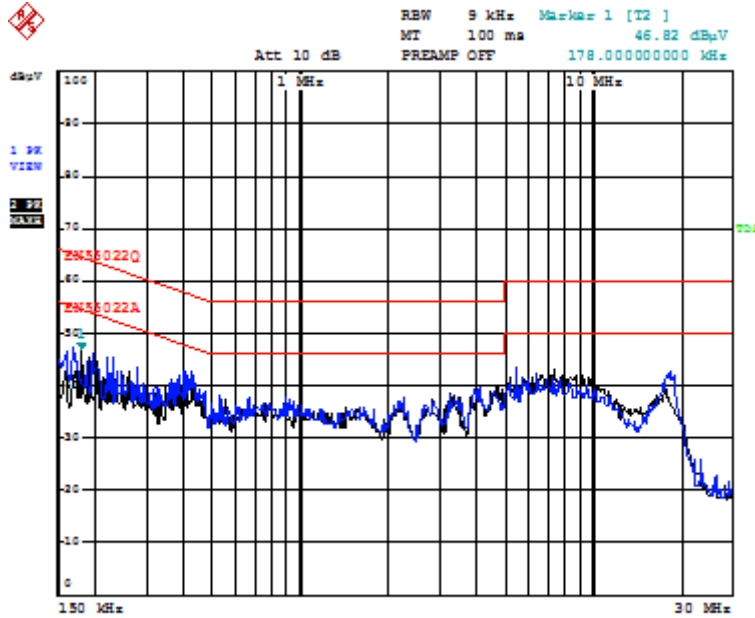

## 5. Radiated Emission Test

### 5.1 Test Equipment

Please refer to Section 8 this report.

### 5.2 Test Procedure

1. The EUT was tested according to ANSI C63.4:2014.
2. The EUT, peripherals were put on the turntable which table size is 1m x 1.5 m, table high 0.8 m, and which is 1.5 m high for above 1 GHz. All set up is according to ANSI C63.4:2014 .
3. The frequency spectrum from 9 kHz to 25 GHz was investigated. All readings from 9 kHz to 150 kHz are quasi-peak values with a resolution bandwidth of 200 Hz. All readings from 150 kHz to 30 MHz are quasi-peak values with a resolution bandwidth of 9 KHz. All readings from 30 MHz to 1 GHz are quasi-peak values with a resolution bandwidth of 120 KHz. All readings are above 1 GHz , peak values with a resolution bandwidth of 1 MHz . Measurements were made at 3 meters.
4. The emissions from the EUT were measured continuously at every azimuth by rotating the turntable. The Receiving antenna high is varied from 1 m to 4 m high to find the maximum emission for each frequency. Emissions below 30MHz were measured with a loop antenna while emission above 30MHz were measured using a broadband E-field antenna.
5. Maximizing procedure was performed on the six (6) highest emissions to ensure EUT compliance is with all installation combinations. All data was recorded in the peak detection mode. Quasi-peak readings was performed only when an emission was found to be marginal (within -4 dB of specification limit), and are distinguished with a "QP" in the data table.
6. Each emission was to be maximized by changing the polarization of receiving antenna both horizontal and vertical. In order to find out the max. emission, the relative positions of this transmitter(EUT) was rotated through three orthogonal axes according to the requirements in Section 8 and 13 of ANSI C63.4:2014

### 5.3 Radiated Test Setup

For Frequencies below 30 MHz

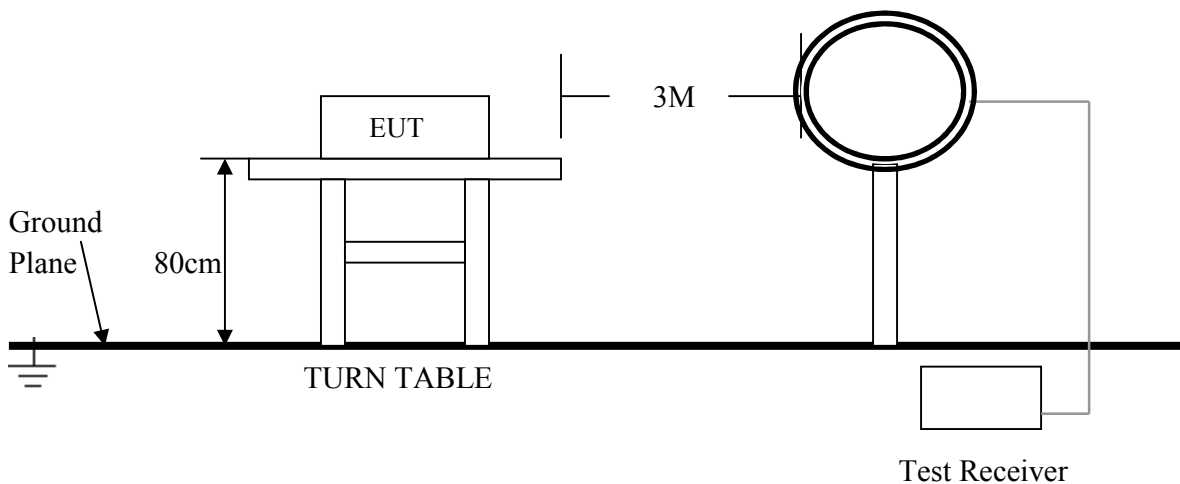

**For the actual test configuration , please refer to the related items – Photos of Testing**

### For Frequencies above 30 MHz

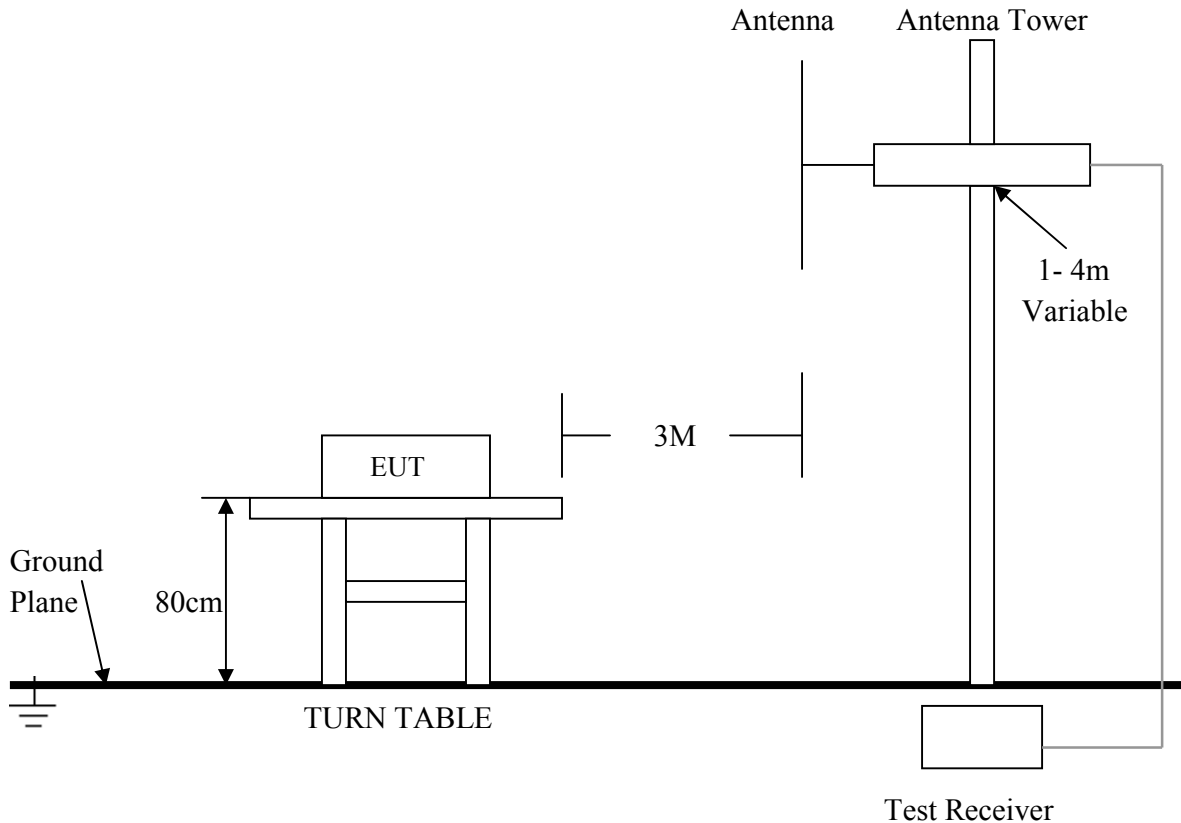

For the actual test configuration , please refer to the related items – Photos of Testing

### 5. 4 Configuration of The EUT

Same as section 4.4 of this report

### 5. 5 EUT Operating Condition

Same as section 4.5 of this report

### 5. 6 Radiated Emission Limit

All emission from a digital device, including any network of conductors and apparatus connected thereto, shall not exceed the level of field strength specified below:

Frequencies in restricted band are complied to limit on Paragraph 15.109.

Frequency (MHz)	Distance (m)	Field Strength (dBuV/m)
30 - 88	3	40.0
88 - 216	3	43.5
216 - 960	3	46.0
Above 960	3	54.0

#### Note:

1. In the emission tables above, the tighter limit applies at the band edges.
2. Distance refers to the distance between measuring instrument, antenna, and the closest point of any part of the device or system.
3. The lower limit shall apply at the transition frequencies.

## 5.7 Radiated Emission Test Result

Product	: DECT Repeater	Test Mode	: Normal Link / Auto
Test Item	: Fundamental Radiated Emission Data	Temperature	: 25 °C
Test Voltage	: DC 5V	Humidity	: 56%RH
Test Result	: <b>PASS</b>	Model	:

### For Frequency below 30MHz

Freq. (MHz)	Emission (dBuV/m) QP Detector	HORIZ / VERT	Limits (dBuV/m)	Margin (dB)
N/A				
N/A				
N/A				
N/A				
N/A				
N/A				

**Note:**

- (1) All Readings below 1GHz are Quasi-Peak, above are performed with peak and/or average measurements as necessary.
- (2) "N/A" remark, if no specific emissions from the EUT are recorded (ie: margin>20dB from the applicable limit) and considered that's already beyond the background noise floor.
- (3) Emission Level = Reading Level + Probe Factor + Cable Loss.

### For Frequency from 30MHz to 1GHz

Adapter model: F06US0500100A

Freq. (MHz)	Emission (dBuV/m) QP Detector	HORIZ / VERT	Limits (dBuV/m)	Margin (dB)
32.520	28.20	HORZ	40.0	-11.80
30.000	36.09	VERT	40.0	-3.91
375.938	38.55	HORZ	46.0	-7.45
106.758	34.79	VERT	43.5	-8.71
750.108	38.62	HORZ	46.0	-7.38
375.938	41.57	VERT	46.0	-4.43

Adapter model: NBS05B050100VU

Freq. (MHz)	Emission (dBuV/m) QP Detector	HORIZ / VERT	Limits (dBuV/m)	Margin (dB)
250.301	40.99	HORZ	46.0	-5.01
250.301	39.55	VERT	46.0	-6.45
501.179	43.52	HORZ	46.0	-2.48
501.179	39.20	VERT	46.0	-6.80
552.380	36.58	HORZ	46.0	-9.42
300.367	38.06	VERT	46.0	-7.94

**Note:**

- (1) All Readings below 1GHz are Quasi-Peak, above are performed with peak and/or average measurements as necessary.
- (2) "N/A" remark, if no specific emissions from the EUT are recorded (ie: margin>20dB from the applicable limit) and considered that's already beyond the background noise floor.
- (3) Emission Level = Reading Level + Probe Factor + Cable Loss.

*Radiated Emission*  
*FCC 15.109*  
*For Frequency from 30MHz to 1GHz*  
*Adapter model: F06US0500100A*  
*Horizontal*

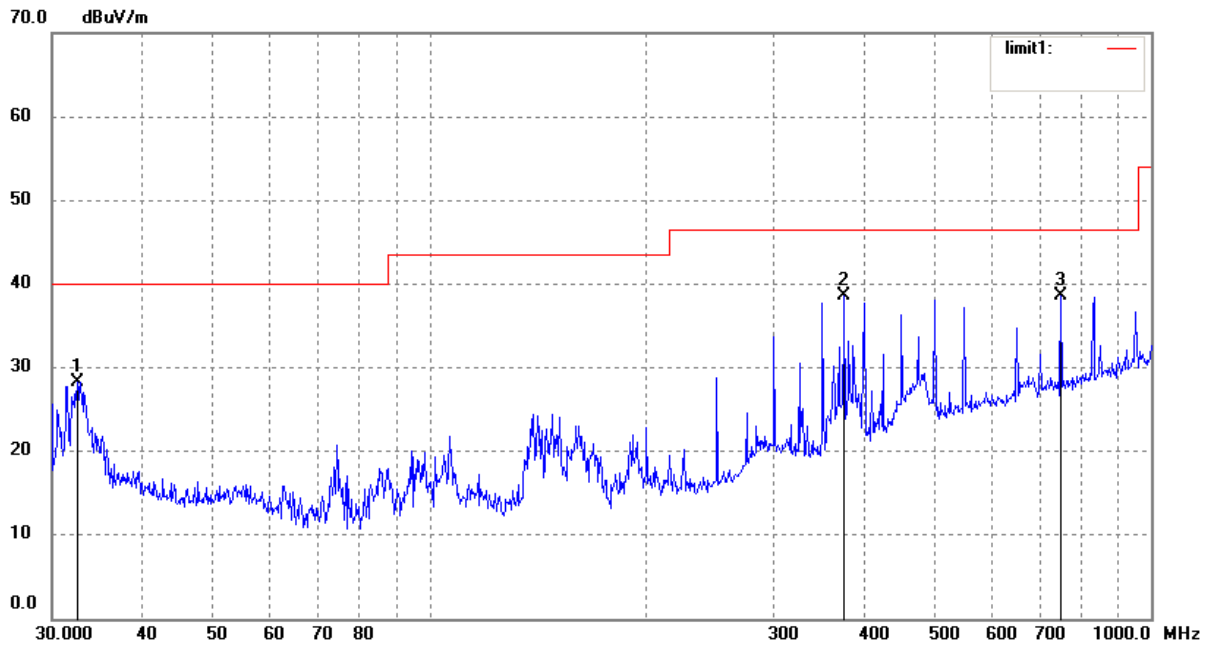

*Vertical*

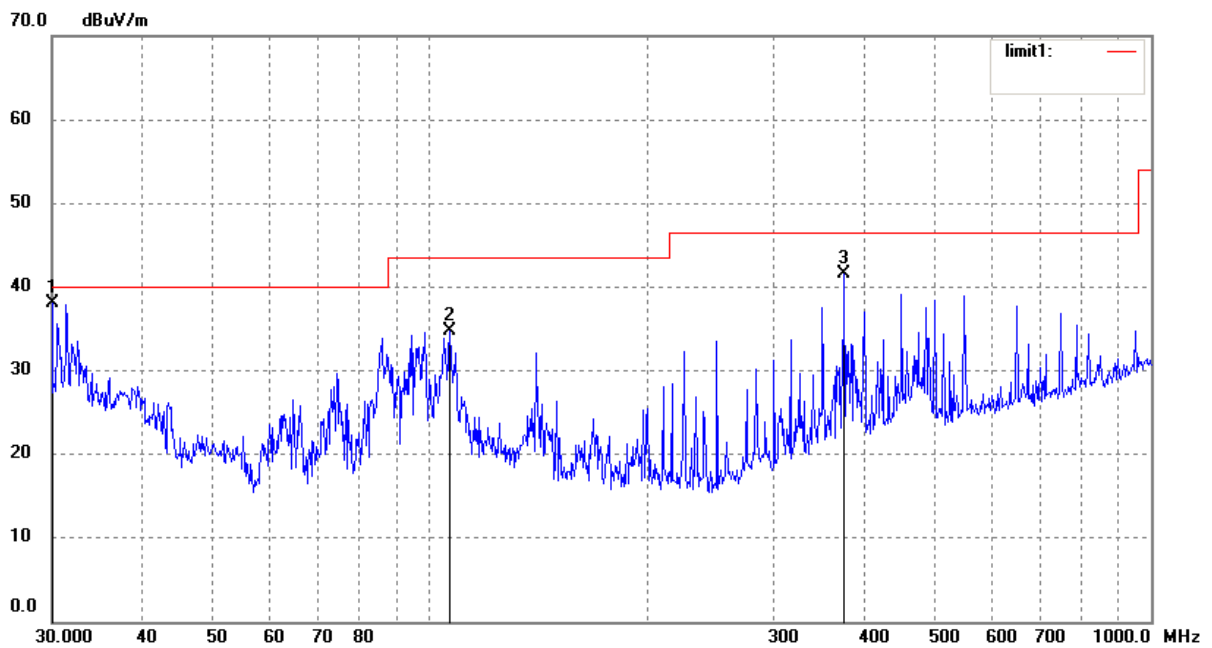

Adapter model: NBS05B050100VU

Horizontal

70.0 dBuV/m

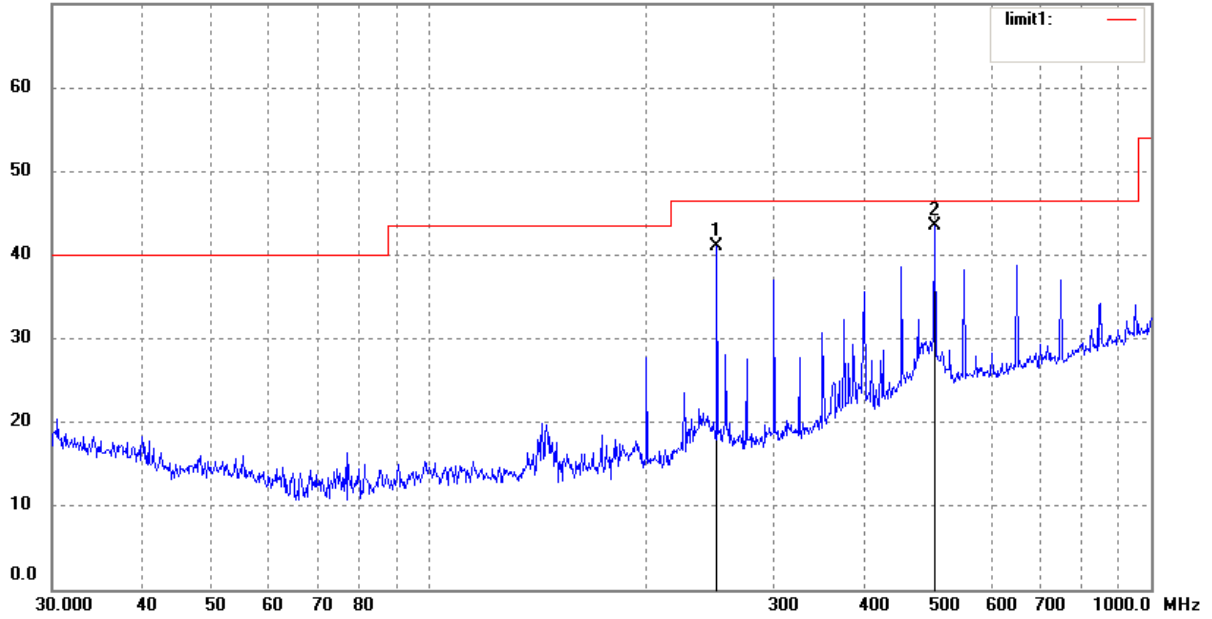

Vertical

70.0 dBuV/m

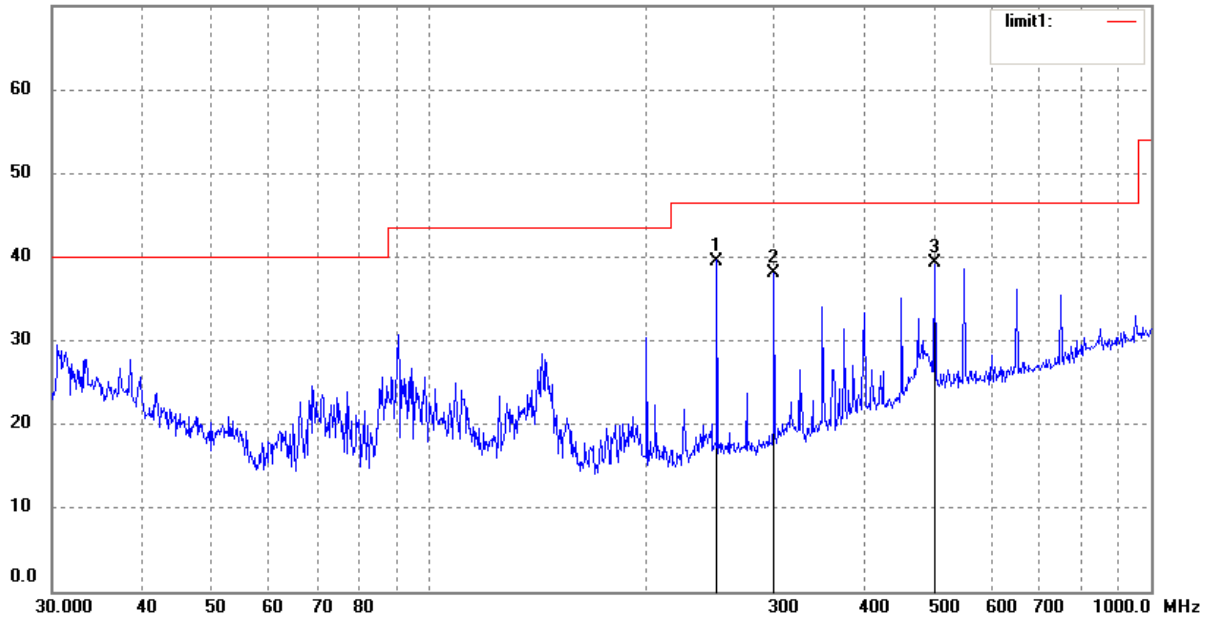

## Frequency above 1 GHz

Freq. (MHz)	Emission (dBuV/m)		HORIZ / VERT	Limits (dBuV/m)		Margin(dB)	
	PK	AV				PK	AV
2106.300	49.57	30.12	HORZ	74	54	-24.43	-23.88
1736.250	52.65	33.42	VERT	74	54	-21.35	-20.58
2332.100	48.63	30.28	HORZ	74	54	-25.37	-23.72
3052.600	53.41	36.26	VERT	74	54	-20.59	-17.74
3856.500	59.64	42.13	HORZ	74	54	-14.36	-11.87
4434.360	56.16	36.95	VERT	74	54	-17.84	-17.05
5124.765	49.82	36.18	HORZ	74	54	-24.18	-17.82
5097.292	47.82	35.69	VERT	74	54	-26.18	-18.31
14526.360	43.56	30.23	HORZ	74	54	-30.44	-23.77
14434.120	42.65	30.12	VERT	74	54	-31.35	-23.88
19362.200	41.56	30.09	HORZ	74	54	-32.44	-23.91
19236.300	40.16	30.02	VERT	74	54	-33.84	-23.98

- Note:**
- (1) All Readings below 1GHz are Quasi-Peak, above are performed with peak and/or average measurements as necessary.
  - (2) Emission Level = Reading Level + Probe Factor + Cable Loss.

## 6. Photo of Testing

### 6.1 Emission test view

FP Conducted Emission test view

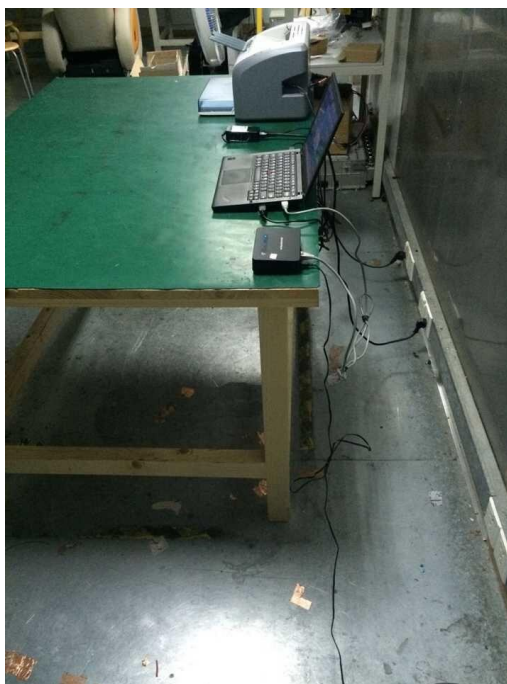



Radiated Emission test view (Frequency from 30MHz to 1GHz)

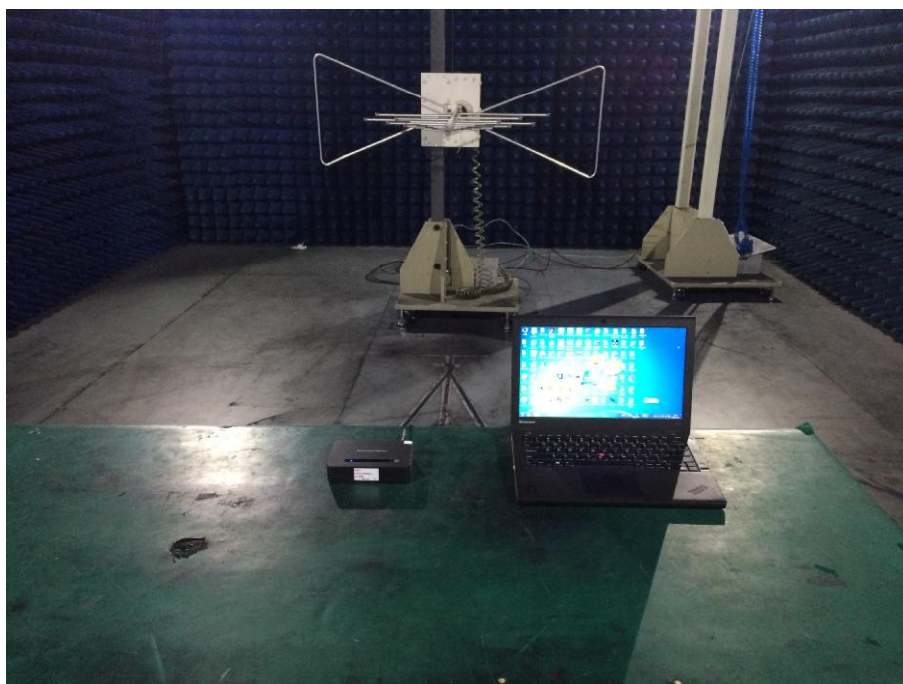

Radiated Emission test view (Frequency above 1GHz)

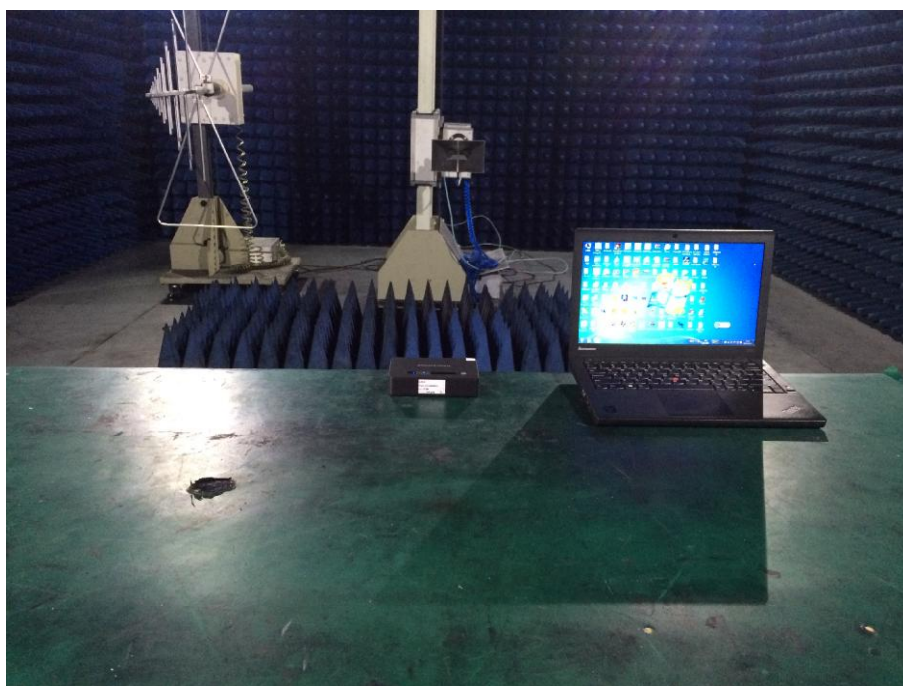

### 6.2 Photograph - EUT

FP EUT top view

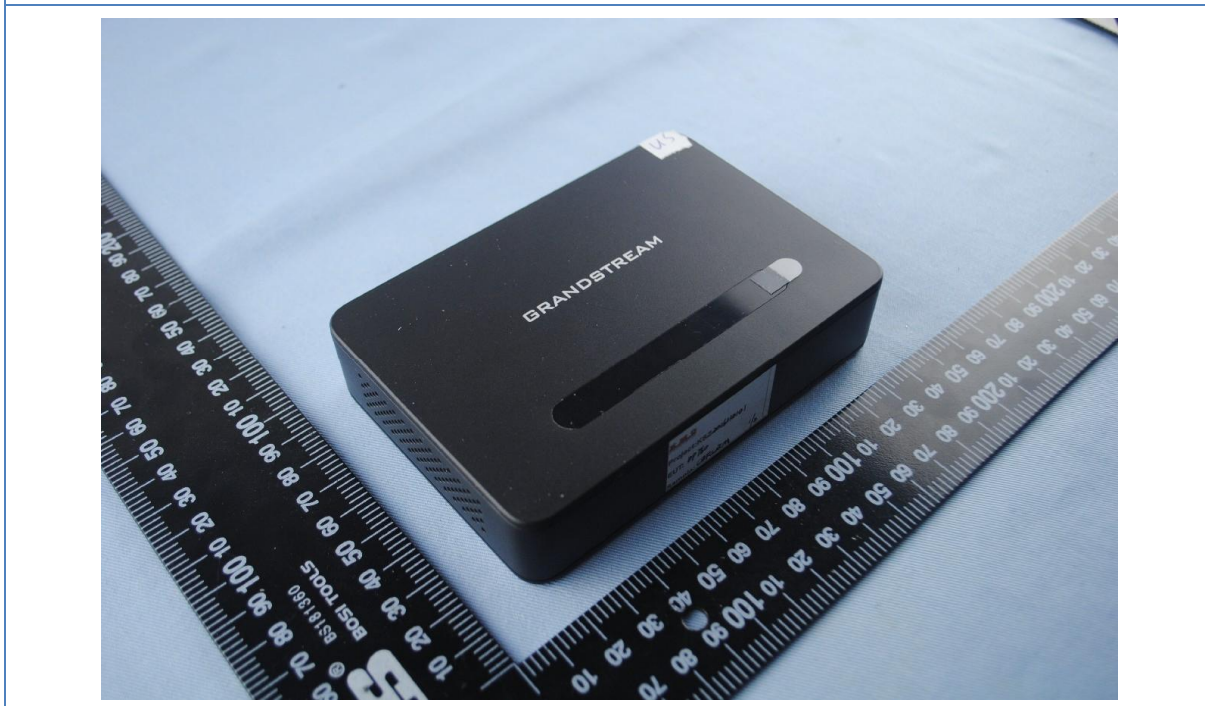

EUT bottom view



EUT inside whole view

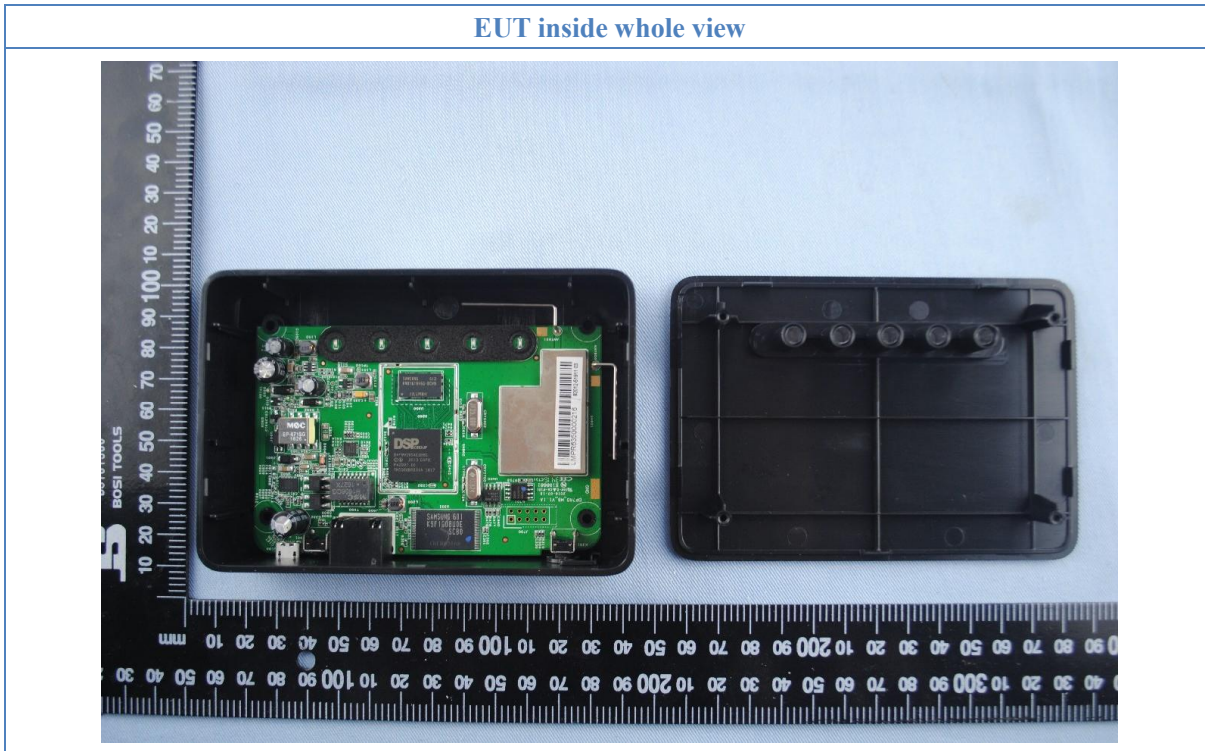

Main board component side

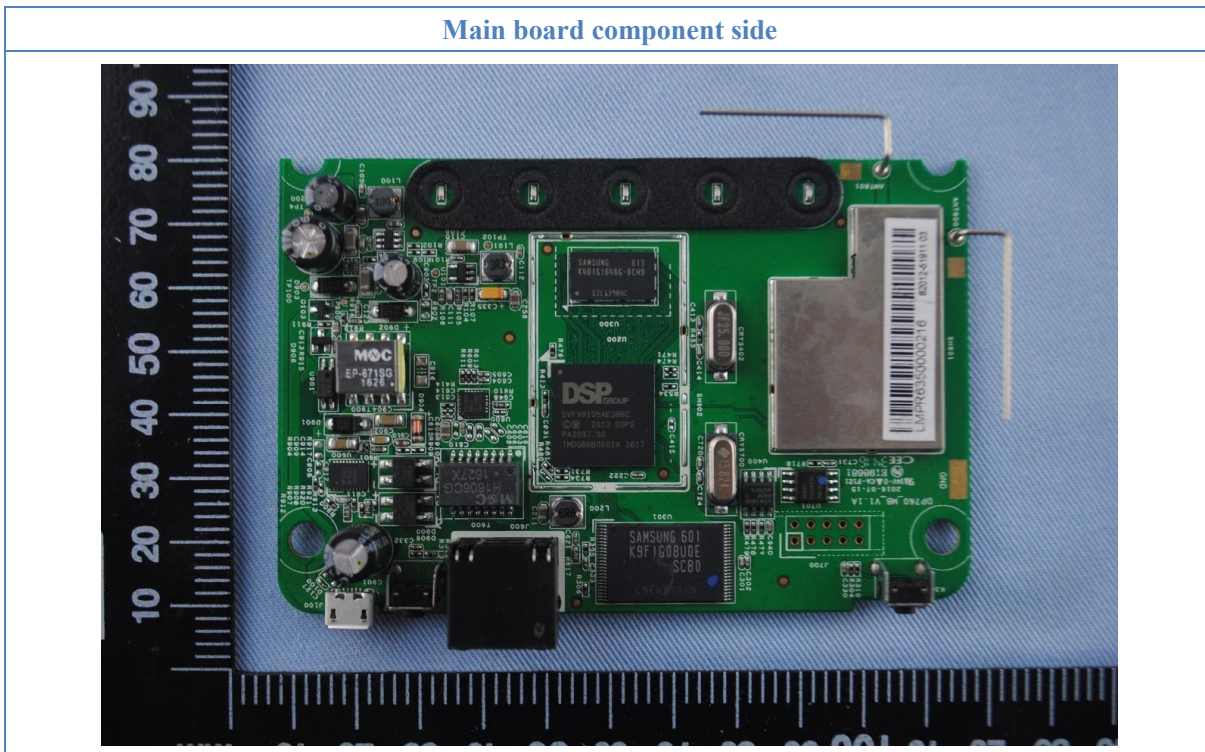

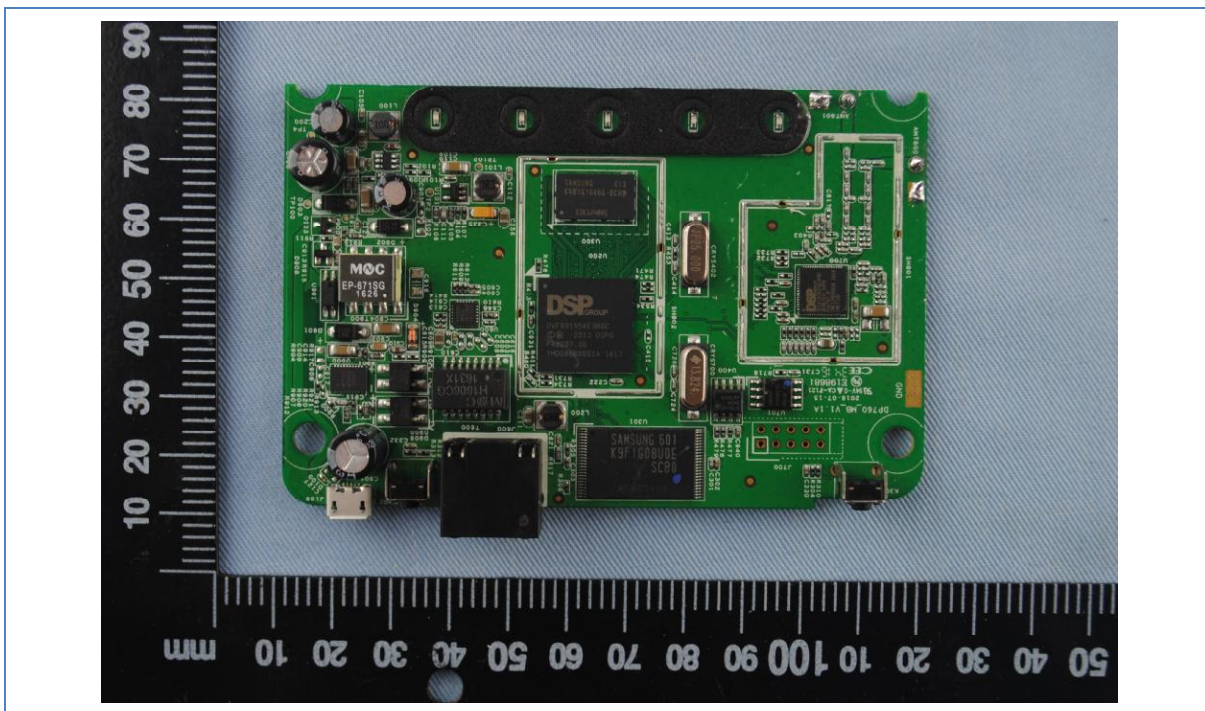

Main board solder side

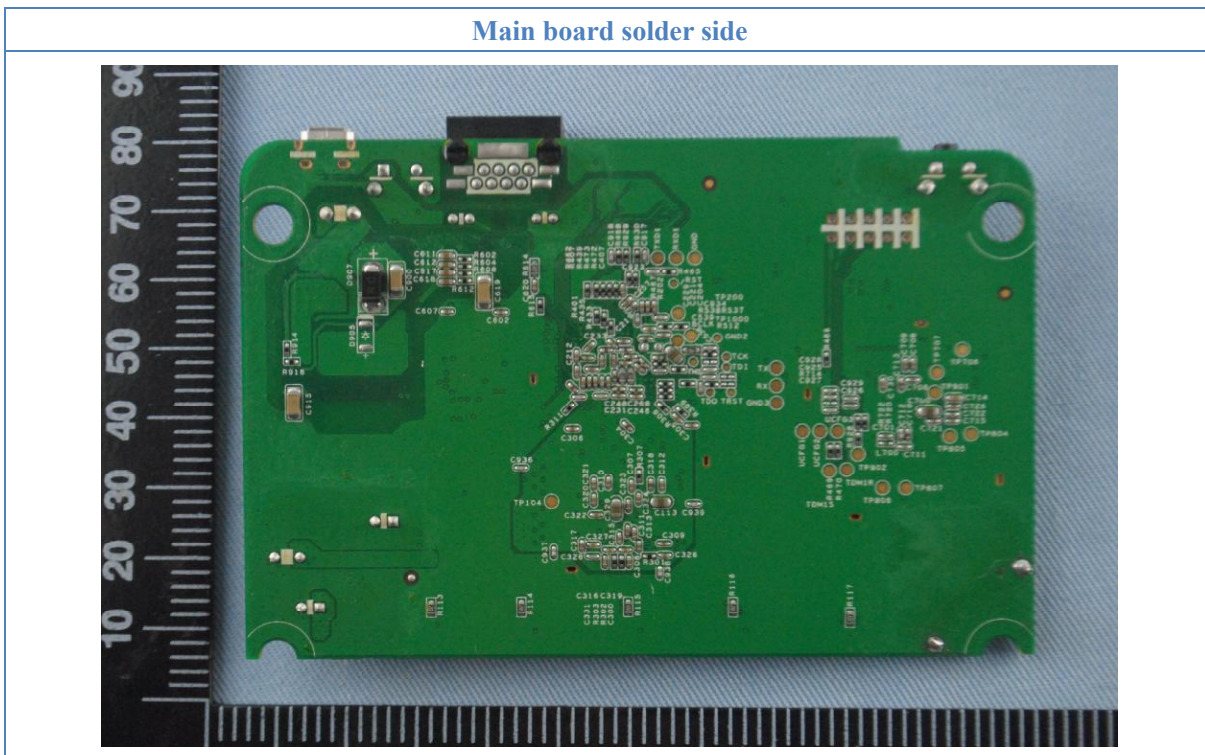

FCC Adapter top view SUNLIGHT



Adapter side view



FCC Adapter top view MASS

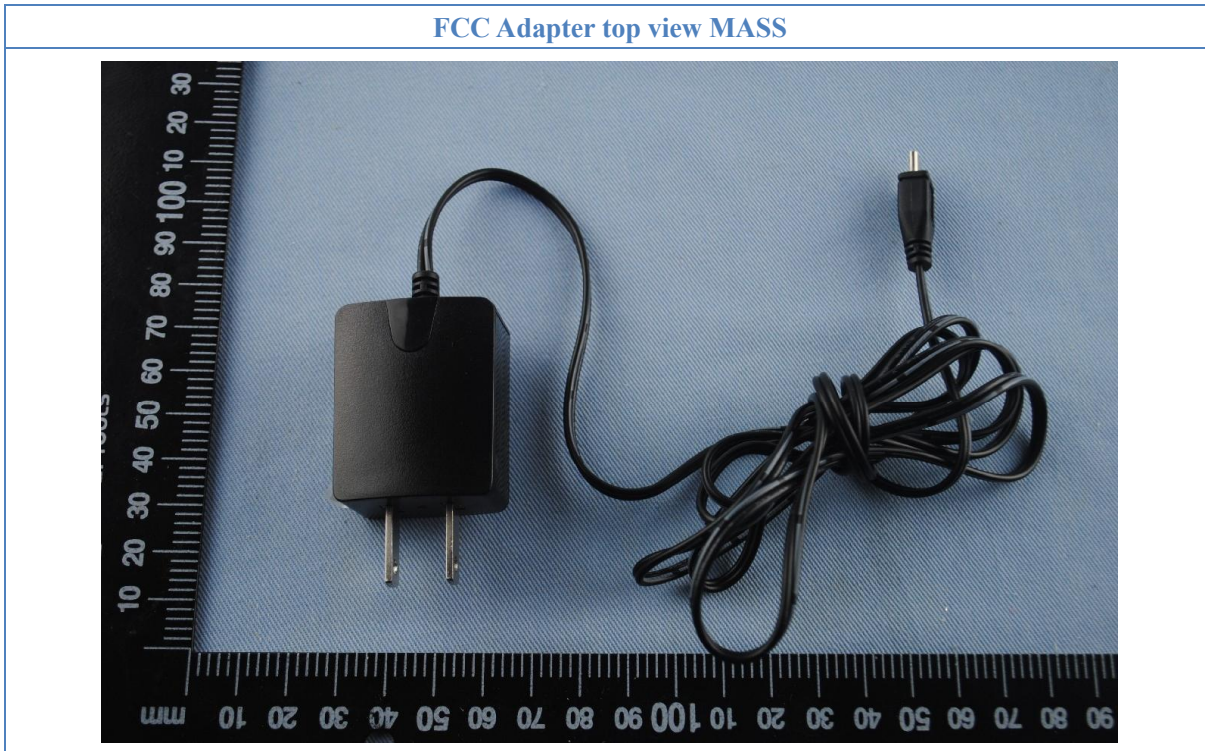

Adapter side view

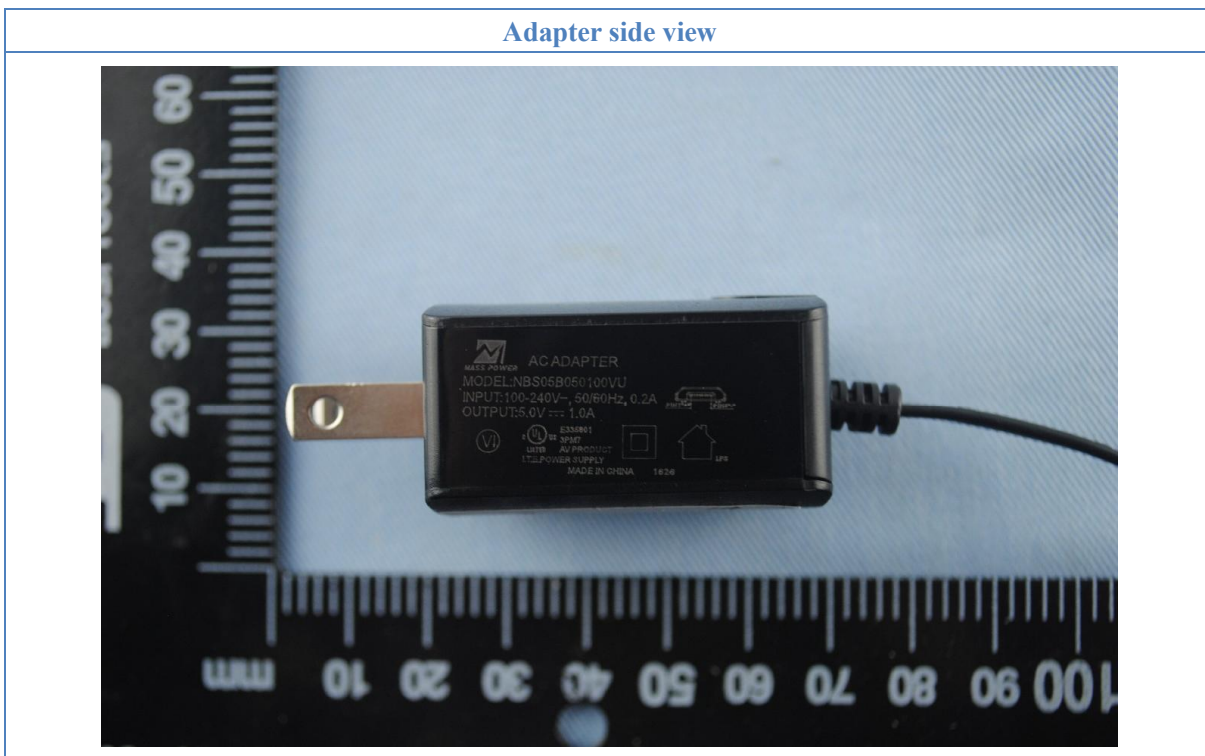

## 7. FCC ID Label

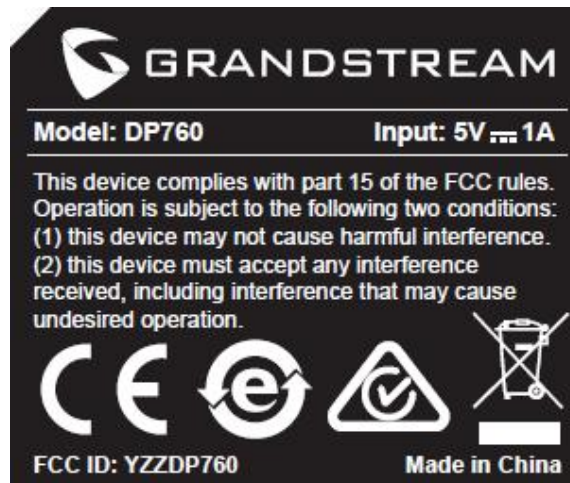

The following note shall be conspicuously placed in the users manual: **“Operation is subject to the following two conditions: (1) this device may not cause interference, and (2) this device must accept any interference, including interference that may cause undesired operation of this device.”**

The Label must not be a stick-on paper label. The Label on these products must be permanently affixed to the product and readily visible at the time of purchase and must last the expected lifetime of the equipment not be readily detachable.

Proposed Label Location on EUT





## 8. Test Equipment

The following test equipments were used during the radiated & conducted emission test:

Equipment/ Facilities	Manufacturer	Model #	Serial No.	Due Date
Spectrum Analyzer	Rohde&Schwarz	FSV40	101495	2017-01-09
Test Receiver	Rohde&Schwarz	ESCS30	100307	2017-01-09
Bilog Antenna	Schwarzbeck	VULB9163	9163-323	2017-01-09
Loop Antenna	Schwarzbeck	FMZB1516	1516131	2017-01-09
Horn Antenna	Schwarzbeck	BBHA9120D	9120D-655	2017-01-09
Horn Antenna	Schwarzbeck	BBHA9170	9170-359	2017-01-09
RF Switching Unit+PreAMP	Compliance Direction	RSU-M2	38322	2017-01-09
Pre-Amplifier	Rohde&Schwarz	CBLU1183540-01	3791	2017-01-09
Spectrum Analyzer	Rohde & Schwarz	ESPI3	100396/003	2017-01-09
Spectrum Analyzer	Agilent	E7405A	MY45115511	2017-01-09
Test Receiver	Rohde & Schwarz	ESCS30	100307	2017-01-09
L.I.S.N.	Schwarzbeck	NLSK8126	8126431	2017-01-09
Pulse Limiter	Rohde & Schwarz	ESH3-Z2	100815	2017-01-09
Digital Radio Communication Tester	Rohde & Schwarz	CMD60	KMO-SZ169	April 10, 2017
Temperature Chamber	TABAI	PSL-4GTW	N/A	Feb.10, 2017