

Grandstream Networks, Inc.

DP750/DP720

User Guide



COPYRIGHT

©2016 Grandstream Networks, Inc. <http://www.grandstream.com>

All rights reserved. Information in this document is subject to change without notice. Reproduction or transmittal of the entire or any part, in any form or by any means, electronic or print, for any purpose without the express written permission of Grandstream Networks, Inc. is not permitted.

The latest electronic version of this user manual is available for download here:

<http://www.grandstream.com/support>

Grandstream is a registered trademark and Grandstream logo is trademark of Grandstream Networks, Inc. in the United States, Europe and other countries.

CAUTION

Changes or modifications to this product not expressly approved by Grandstream, or operation of this product in any way other than as detailed by this User Manual, could void your manufacturer warranty.

WARNING

Please do not use a different power adaptor with your devices as it may cause damage to the products and void the manufacturer warranty.



GNU GPL INFORMATION

DP750 firmware contains third-party software licensed under the GNU General Public License (GPL). Grandstream uses software under the specific terms of the GPL. Please see the GNU General Public License (GPL) for the exact terms and conditions of the license.

Grandstream GNU GPL related source code can be downloaded from Grandstream web site from:

http://www.grandstream.com/sites/default/files/Resources/gpl_dp750.tar.gz



Table of Content

DOCUMENT PURPOSE	7
CHANGE LOG	8
FIRMWARE VERSION 1.0.0.14	8
GUI INTERFACE EXAMPLES.....	9
WELCOME	10
PRODUCT OVERVIEW	11
Feature Highlights.....	11
DP750 Technical Specifications.....	12
DP720 Technical Specifications.....	13
GETTING STARTED.....	15
Equipment Packaging	15
Connecting DP750.....	16
<i>Connecting via AC power</i>	<i>16</i>
<i>Connecting via PoE</i>	<i>16</i>
Setting up DP720 handset.....	17
<i>Battery Information</i>	<i>17</i>
Setting up the Charger Station	18
DP750 LED Patterns.....	18
DP720 Handset Description	19
DP720 Icons Description	20
DP720 Handset Menu.....	22
BASIC OPERATIONS.....	25
Turning the Handset ON / OFF	25
Register DP720 Handset to DP750 Base Station	25
Unregister the DP720	26
Checking DP750 Base Station IP Address	27
Setting the Key Lock.....	27
Locating a DP720 Handset from DP750 Base station.....	28
<i>Locate Via DP750 Web UI.....</i>	<i>28</i>
<i>Locate Via DP750 Base Station</i>	<i>29</i>
Understanding DP720/750 Voice Prompt.....	29
Checking System Status.....	31
Basic Network Settings	31
Register a SIP Account.....	32
<i>Register Account via Web User Interface.....</i>	<i>32</i>



Return to Idle Screen	35
PHONE SETTINGS.....	36
Editing the Handset's name	36
Changing the Base PIN	36
Selecting the Menu Language	37
Activate/Deactivate Hands-Free Mode	38
Muting the Microphone	38
Adjusting Speaker and Earpiece Volume	38
Ringtones.....	39
<i>Setting the Ringer Volume on the Handset</i>	39
<i>Setting the Ringer Melody on the Handset</i>	39
<i>Advisory Tones</i>	40
Date and Time.....	41
Factory Functions	42
Firmware Upgrade	43
Reset the Handset DP720	43
CALL OPERATIONS	45
Placing calls	45
<i>Internal calls</i>	45
<i>External Calls</i>	45
Dialing from Call history	46
Answering Calls	46
Auto Answer	47
Direct IP Call	47
Call Hold/Resume	48
Call waiting.....	48
Do Not Disturb	49
Call forward.....	49
Call transfer.....	50
<i>Blind transfer</i>	50
<i>Attended Transfer</i>	50
Speed Dial	50
3-Way Conference	51
Voice Mail.....	51
<i>Set Voice mail feature code</i>	51
<i>Play voice mail messages</i>	51
Call Features.....	52
RESTORE FACTORY DEFAULT SETTINGS	54
EXPERIENCING DP750/DP720	55



Table of Tables

Table 1: DP720 Features in a Glance	11
Table 2: DP750 Features in a Glance	11
Table 3: DP750 Technical Specifications	12
Table 4: DP750 Technical Specifications	13
Table 5: Equipment Packaging	15
Table 6: DP750 Led Patterns	18
Table 7: Handset Keys Description	19
Table 8: DP720 Icons Descriptions	20
Table 9: Voice Prompt Menu	29
Table 10: DP720 Info description	31
Table 11: Call Features	52



Table of Figures

Figure 1: DP720 Package Contents	15
Figure 2: DP750 Package Contents	15
Figure 3: DP750 Back View	16
Figure 4: Connecting the Base station	16
Figure 5: Setting up the DP720.....	17
Figure 6: Setting up the charger station	18
Figure 7: Handset Keys Description	19
Figure 8: DP720 Menu Structure	22
Figure 9: DECT Status	25
Figure 10: Registration process	26
Figure 11 : Locate Handset via Web UI	28
Figure 12 : Network Settings configuration	32
Figure 13: SIP Settings	33
Figure 14: SIP Accounts Settings.....	34
Figure 15 : SIP Accounts Status	34
Figure 16: Handset Name editing	36
Figure 17: Changing Admin Base PIN Code.....	37
Figure 18: Handset Language	38
Figure 19: Ringer Volume	39
Figure 20: Internal/External Calls Ringtones	40
Figure 21: Advisory Tone.....	41
Figure 22: Date and Time Settings	41
Figure 23: Factory Functions	42
Figure 24: Firmware Upgrade	43
Figure 25: Factory Reset.....	44



DOCUMENT PURPOSE

This document describes the basic concept and tasks necessary to use and configure your DP720 via the LCD menu and also using the DP750 base station. And it covers the topic of phone installation, making basic calls and connecting phone to devices. Please visit <http://www.grandstream.com/support> to download the latest “DP750/DP720 User Guide”.

This guide covers following topics:

- [Product Overview](#)
- [Getting Started](#)
- [Basic Operations](#)
- [Phone settings](#)
- [Call Operations](#)



CHANGE LOG

This section documents significant changes from previous versions of user guide for DP750/DP720. Only major new features or major document updates are listed here. Minor updates for corrections or editing are not documented here.

FIRMWARE VERSION 1.0.0.14

- This is the initial version for DP750/DP720.



GUI INTERFACE EXAMPLES

http://www.grandstream.com/sites/default/files/Resources/dp750_web_gui.zip

1. Screenshot of Login Page
2. Screenshots of Status Pages
3. Screenshots of Profiles Pages
4. Screenshots of DECT Pages
5. Screenshots of Phonebook Pages
6. Screenshots of Settings Pages
7. Screenshots of Maintenance Pages



WELCOME

Thank you for purchasing Grandstream DP720 DECT IP Phone, the DP720 is the next generation of versatile, affordable, high quality and easy-to-use, high quality DECT cordless IP phones for small BUSINESS and residential users. These compact and durable DECT IP phones allow users mobility throughout their home or office while maintaining the benefits of VoIP calling with a reliable and convenient wireless voice communications. Moreover, it provides many widely accepted benefits of the DECT standard, including compact size, superb HD audio quality, rich feature set, market leading price-performance and wide range radio coverage which allow users to enjoy the benefits of mobility for a minimum investment



PRODUCT OVERVIEW

Feature Highlights

The following tables contains the major features of the DP720 / DP750

<p style="text-align: center;">DP720</p> 	<ul style="list-style-type: none"> • DECT Cordless HD. • 1.8 inch (128x160) TFT color LCD. • 250 hours standby /20 hours talk time. • 27 languages embedded. • 10 accounts. • 10 lines. • 5 Type of ring modes.
---	--

Table 1:DP720 Features in a Glance

<p style="text-align: center;">DP750</p> 	<ul style="list-style-type: none"> • 5 handsets. • 10 accounts. • 10 Lines. • 4 Concurrent calls. • PoE power support. • 300m range outdoor / 50m range indoor.
---	---

Table 2: DP750 Features in a Glance



DP750 Technical Specifications

The following table resume all the technical specifications including the protocols / standards supported, voice codecs, telephony features, languages and Upgrade/ Provisioning settings for the Base station DP750.

Table 3: DP750 Technical Specifications

Air Interface	Telephony standards: DECT Frequency bands: <ul style="list-style-type: none"> ▪ 1880 – 1900 MHz (Europe), 1920 – 1930 MHz (US), ▪ 1910 – 1920 MHz (Brazil), 1786 – 1792 MHz (Korea), ▪ 1893 – 1906 MHz (Japan), 1880 – 1895 MHz (Taiwan) Number of channels: 10 (Europe), 5 (US, Brazil or Japan), 3 (Korea) or 8 (Taiwan) Range: up to 300 meters outdoor and 50 meters indoor
Peripherals	5 LED indicators: Power, Network, Register, Call, DECT Reset button, Pairing/Paging button One 10/100 Mbps auto-sensing Ethernet port with integrated PoE
Protocol/Standards	SIP RFC3261, TCP/IP/UDP, RTP/RTCP, HTTP/HTTPS, ARP/RARP, ICMP, DNS (A record, SRV, NAPTR), DHCP, PPPoE, SSH, TFTP, NTP, STUN, SIMPLE, LLDP-MED, LDAP, TR-069, 802.1x, TLS, SRTP, IPv6 (pending)
Voice Codecs	G.711 μ /a-law, G.723.1, G.729A/B, G.726-32, iLBC, G.722, OPUS, G.722.2/AMR-WB (special order), in-band and out-of-band DTMF (in audio, RFC2833, SIP INFO), VAD, CNG, PLC, AJB
Telephony Features	Hold, transfer, forward, 3-way conference, call park, call pickup, downloadable phonebook (XML, LDAP, up to 3000 entries), call waiting, call log (up to 300 records), auto answer, click-to-dial, flexible dial plan, music on hold, server redundancy and fail-over
Voice Codec	G.711 μ /a-law, G.723.1, G.729A/B, G.726-32, iLBC, G.722, Opus, G.722.2/AMR-WB (special order), in-band and out-of-band DTMF (in audio, RFC2833, SIP INFO), VAD, CNG, PLC, AJB
Sample Applications	Weather, Currency (pending)
QoS	Layer 2 QoS (802.1Q, 802.1P) and Layer 3 QoS (ToS, DiffServ, MPLS)
Security	User and administrator level access control, MD5 and MD5-sess based authentication, 256-bit AES encrypted configuration file, TLS, SRTP, HTTPS, 802.1x media access control, DECT authentication & encryption
Multi-language	Arabic, Chinese Simple, Chinese Tradition, Croatian, Czech, Danish, Dutch, English, Estonian, Finnish, French, German, Greek, Hebrew, Hungarian, Italian, Japanese, Korean, Norwegian, Polish, Portuguese, Romanian, Russian, Slovenian, Spanish, Swedish, Turkish
Upgrade/ Provisioning	Firmware upgrade via TFTP/HTTP/HTTPS, mass provisioning using TR-069 or AES encrypted XML configuration file
Multiple SIP Accounts	Up to ten (10) distinct SIP accounts per system Each handset may map to any SIP account(s) Each SIP account may map to any handset(s)



Ring Group	Flexible options when multiple handsets share the same SIP account <ul style="list-style-type: none"> ▪ Circular Mode: all phones ring sequentially from the phone next to the one that answered last ▪ Linear Mode: all phones ring sequentially in the predestinated order ▪ Parallel Mode: all phones ring concurrently and after one phone answers, the remaining available phones can make new calls ▪ Shared Mode: all phones ring concurrently and always share the same line similar to analog phones
Power and Green Energy Efficiency	Universal Power Supply Input AC 100-240V 50-60Hz; Output 5VDC, 1A; Micro-USB connection; PoE: IEEE802.3af Class 1, 0.44W–3.84W
Package Content	Base unit, Universal Power Supply, Ethernet cable, Quick Start Guide
Dimensions	28.5 mm (H) x 130 mm (W) x 90 mm (D)
Weight	Base unit: 143g, Universal Power Supply: 50g; Package: 360g
Temperature and Humidity	Operation: -10° to 50°C (14 to 122°F); Storage: -20° to 60°C (-4 to 140°F); Humidity: 10% to 90% non-condensing
Compliance	FCC: Part 15D, 47 CFR 2.1093, Part 15B CE: EN60950; EN301489-1-6; EN301406 RCM: AS/NZS60950 (Pending)

DP720 Technical Specifications

The following tables resume all the technical specifications including the protocols / standards supported, voice codecs, telephony features, languages and Upgrade/ Provisioning settings for the DP 720 handset.

Table 4: DP750 Technical Specifications

Air Interface	Telephony standards: DECT Frequency bands: <ul style="list-style-type: none"> ▪ 1880 – 1900 MHz (Europe), 1920 – 1930 MHz (US), ▪ 1910 – 1920 MHz (Brazil), 1786 – 1792 MHz (Korea), ▪ 1893 – 1906 MHz (Japan), 1880 – 1895 MHz (Taiwan) Number of channels: 10 (Europe), 5 (US, Brazil or Japan), 3 (Korea), 8 (Taiwan) Range: up to 300 meters outdoor and 50 meters indoor
Peripherals	1.8 inch (128x160) color TFT LCD 23 keys including 2 soft keys, 5 navigation/ menu keys, 4 dedicated function keys for SEND, POWER/END, SPEAKERPHONE, MUTE 3-color MWI LED 3.5mm headset jack Removable belt clip Micro-USB port for alternative charging and non-battery operation



Protocol/Standards	DECT, Hearing Aid Compatibility (HAC) compliant
Voice Codecs	G.722 codec for HD audio and G.726 codec for narrow band audio, AEC, AGC, Ambient noise reduction
Telephony Features	Hold, transfer, forward, 3-way conference, call park, call pickup, downloadable phonebook, call waiting, call log, auto answer, click-to-dial, flexible dial plan, music on hold
Sample Applications	Weather, Currency (pending)
HD Audio	Yes, both on Handset and Speakerphone
Security	DECT authentication & encryption
Multi-language	Arabic, Chinese Simple, Chinese Tradition, Croatian, Czech, Danish, Dutch, English, Estonian, Finnish, French, German, Greek, Hebrew, Hungarian, Italian, Japanese, Korean, Norwegian, Polish, Portuguese, Romanian, Russian, Slovenian, Spanish, Swedish, Turkish
Upgrade/Provisioning	Software Upgrade Over-The-Air (SUOTA), handset provisioning Over-The-Air
Multiple Line Access	Each handset may access up to 10 lines
Power and Green Energy Efficiency	Universal Power Supply Input AC 100-240V 50/60Hz; Output 5VDC, 1A; Micro-USB connection; Rechargeable 800mAh Ni-MH Low Self-Discharge (LSD) AAA batteries; 250 hours of standby time and 20 hours of talk time
Package Content	Handset unit, universal power supply, charger cradle, belt clip, 2 batteries, Quick Start Guide
Dimensions (H x W x D)	Handset: 155 x 50 x 26 mm, Charger Cradle: 35 x 63.5 x 54 mm
Weight	Handset: 130g, charger cradle: 71g, universal power supply: 50g; Package: 352g
Temperature and Humidity	Operation: -10° to 50°C (14 to 122°F); Charging: 0 to 45°C (32 to 113°F); Storage: -20° to 60°C (-4 to 140°F); Humidity: 10% to 90% non-condensing
Compliance	FCC: Part 15D, 47 CFR 2.1093, Part 15B CE: EN60950; EN301489-1-6; EN301406 RCM: AS/NZS60950 (Pending)



GETTING STARTED

This chapter provides basic installation instructions including the list of the packaging contents and also information for obtaining the best performance with the DP720 IP DECT phone and its Base station DP750.

Equipment Packaging

Table 5: Equipment Packaging

DP720	DP750
<ul style="list-style-type: none"> • 1 Handset unit • 1 Universal power supply 5V • 1 Charger cradle • 1 Belt clip • 2 chargeable batteries • 1 Quick Start Guide 	<ul style="list-style-type: none"> • 1 Base unit • 1 Universal power supply 5V • 1 Ethernet cable • 1 Quick Start Guide • 1 GPL Statement

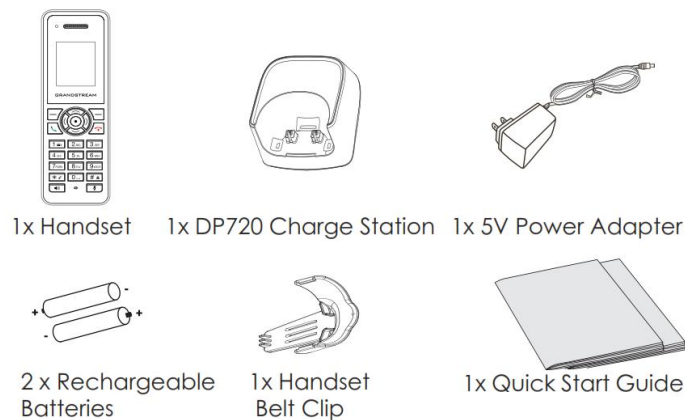

Figure 1: DP720 Package Contents

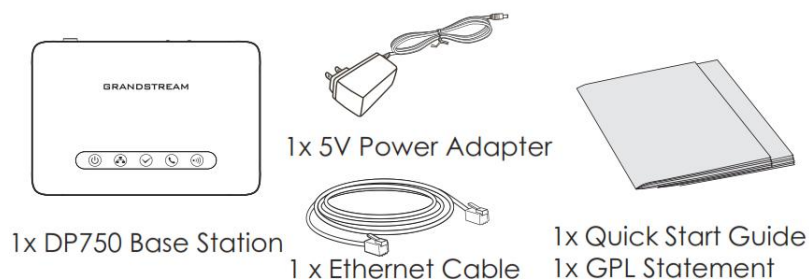

Figure 2: DP750 Package Contents

Note: Check the package before installation. If you find anything missing, contact your system administrator.



Connecting DP750

To setup the DP750 Base Station, please follow the steps below:

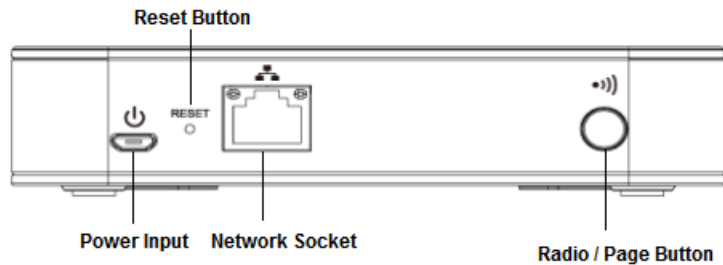

Figure 3: DP750 Back View

You have two options for power and network connection of the base station: AC power or Power over Ethernet (PoE)

Connecting via AC power

1. Connect the microUSB connector into the related port on the base station and connect the other end of the power adapter into an electrical power outlet.
2. Connect the supplied Ethernet cable between the Internet port on the base station and the Internet port in your network or the switch/hub device port.

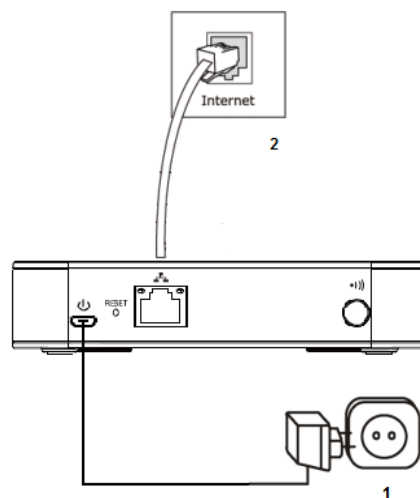

Figure 4: Connecting the Base station

Connecting via PoE

To connect the base station using the PoE, you need to connect the Ethernet cable provided (or 3rd party network cable) between the Network Socket on the base station to Ethernet port of the POE switch/hub.

Setting up DP720handset

Please follow the above steps to insert batteries into the handset:

1. Open the battery compartment cover.
2. Insert the batteries in the correct polarity.
3. Close the battery compartment cover.

Please charge the batteries fully before using the handset for the first time

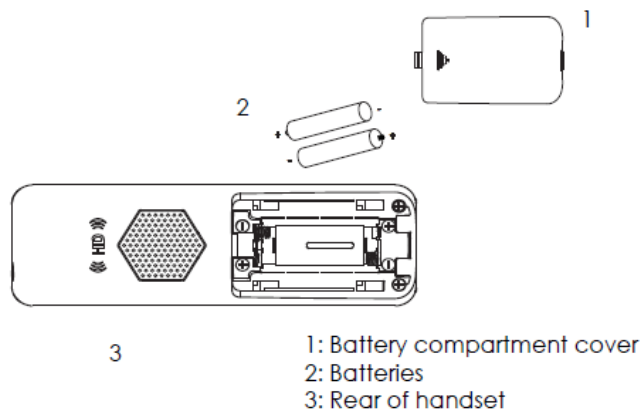

Figure 5: Setting up the DP720

BatteryInformation

- **Technology:** Nickel Metal Hydride (Ni-MH)
- **Size:** AAA
- **Voltage:** 1.2V
- **Capacity:** 800mAh
- **Charging time:** 12 hours from empty to full
- **Standby time:** up to 250 hours
- **Talk time:** up to 20 hours active talk time

In order to get the best performance of your DP720 handset, we recommend using original batteries provided in the package or batteries compliant with above specifications.

Above specifications may differ depending on the age and capacity of the batteries used.

Important Note: Be careful when setting up the batteries into your handset to avoid any risk of short-circuits that can lead to damage your batteries and/or the handset itself. Do not use damaged battery which can increase the risk of serious harm.



Setting up the Charger Station

Please refer to the following steps for setting up the Charger station and charging the handset:

1. Connect the DC plug on the power adapter to the microUSB connector on the charge station.
2. Connect the other end of the power adapter into an electrical power outlet.
3. After setting up the handset and charger station, place the handset in the charger station.

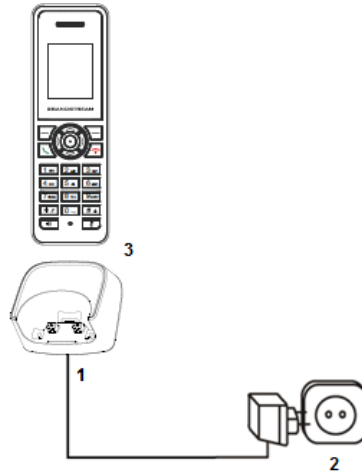

Figure 6: Setting up the charger station

DP750 LED Patterns

The DP750 has 5 LED lights on it. Please see on the following table the meaning of each light.

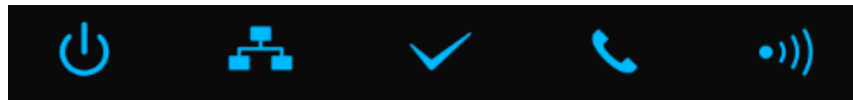







Table 6: DP750 Led Patterns

LED Light	Status
	Indicates Power ON/OFF
	Indicates Access to the Network. Remains ON while there is Access to the Network
	Indicates if a SIP account is registered
	Indicates status of the lines. Blinking: A line is in use. Solid ON: All lines are free.
	The Radio icon for pairing the DP720 and DP750, if we keep pressing the Radio button it starts blinking indicating pairing attempt.



DP720 Handset Description

The LCD screen and the Keypad are the main hardware components of the DP720.

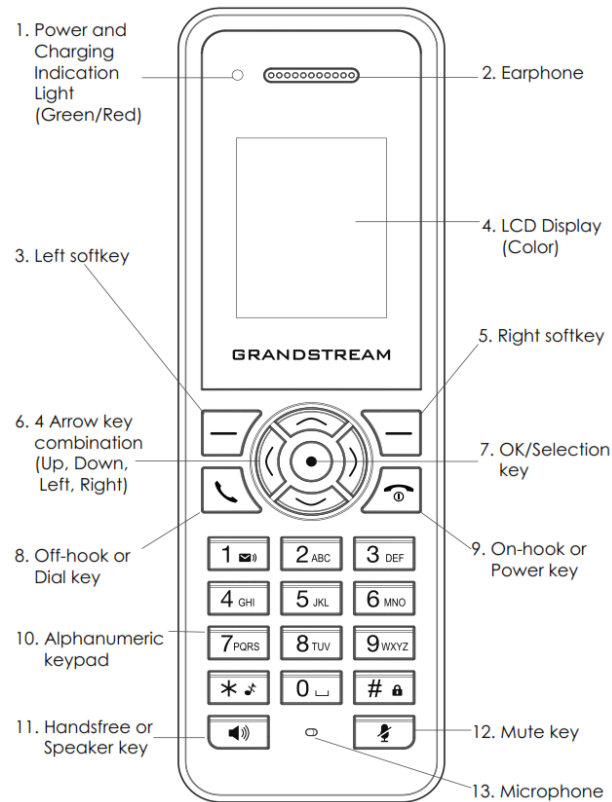

Figure 7: Handset Keys Description

Table 7: Handset Keys Description

	Key	Description
1.	Power and charging indication	Red: In charge / Green: Charge completed.
2.	Earphone	Correspond to Audio output
3,5	Left and Right softkey	Correspond to functions displayed on the LCD. These functions change depending on the current context.
4.	LCD Display	Shows call information, handset status icons, prompt messages and etc.
6.	4 Arrow key combination	Permits navigation of the cursor through the displayed menu options
7.	Ok / Selection key	Selects the option chosen by the cursor. (Enters the main menu from the home screen.
8.	Off-hook or dial key	Power Key: Turn on / Off the handset - On-hook: Terminate calls.
9.	On-hook or Power key	Off-hook key and Dial key to make outgoing calls
10.	Alphanumeric Keypad	Provides the digits, letters, and special characters in context-sensitive









		applications.
11.	Hands free/Speaker key	Switch to hands free or Speaker mode.
12.	Mute key	Activate / Deactivate the Mute feature.
13.	Microphone	Picks up audio during earpiece and hands-free calls.



















DP720 Icons Description

The following table contains the description of each icon will be displayed on the screen of your DP720.

Table 8:DP720 Icons Descriptions

	Alarm Alarm icon. The icon shows when set alarm.
	Battery status Not equipped with battery
	Battery status Battery empty
	Battery status Battery low
	Battery status Battery normal
	Battery status Battery full
	Battery status Charging
	Signal status Not subscribed
	Signal status Not in range
	Signal status Signal very low
	Signal status Signal low
	Signal status Signal normal
	Signal status



	Signal good
	Signal status Signal very good
	Microphone MUTE Status OFF - Not muted ON – Muted
	Speaker Status OFF - Speaker is inactivated ON - Speaker is activated
	Ringtone Status OFF - Ringtone off (Silent mode) ON - Ringtone on
	Keypad Lock Status OFF - Keypad unlock ON - Keypad locked
	External Incoming Call
	External Outgoing Call
	Internal Incoming Call
	Internal Outgoing Call
	Missed Call Icon
	Incoming Call Icon
	Outgoing Call Icon
	Contacts
	Call History
	Voice Mail
	Settings
	Call Settings
	Tools



DP720 Handset Menu

The handset has an easy-to-use menu structure. Every menu opens a list of options. To open the main menu, press the Left display key (**Menu**) when the handset is ON and in standby mode. Press the 4 key combinations to scroll to the menu option you require. Then press the soft key **Select** or the Selection Key **Ok** to access further options or confirm the setting displayed. To go to the previous menu item, press **Back**. You can press the **Power key** at any time to cancel and return to standby mode. If you do not press any key, the handset automatically reverts to standby mode after 20 seconds.

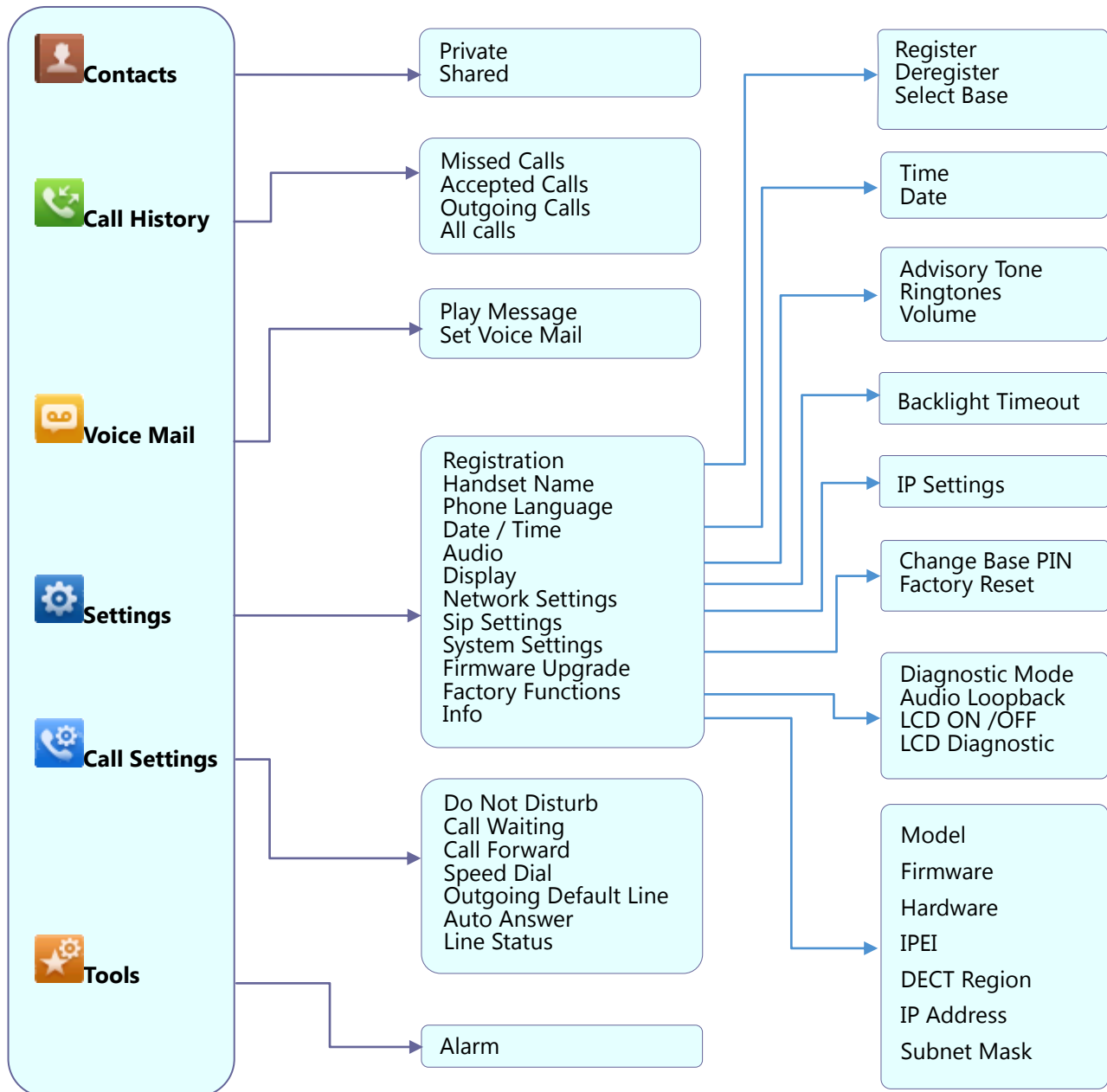

Figure 8: DP720 Menu Structure



Contacts	<p>Private: Private contacts are the contacts that only visible for the current handset. You can add, edit, delete, and call all the contacts in private contacts.</p> <p>Shared: Shared contacts are the contacts that shared for the handset subscribed on the DP750 base station. You can add, edit, delete, edit call all the contacts in shared contacts as well.</p>
Call History	<p>Display the call history; include Missed Calls, Accepted Calls, Outgoing Calls and All calls. You can add contacts to Shared Contacts directly from call logs.</p>
Voice Mail	<p>Voice Mail sub menu includes the following options:</p> <ul style="list-style-type: none"> • Play Message: Play the voice mail messages received. • Set Voice Mail: Configure the voice mail parameters.
Settings	<p>Settings sub menu includes the following options:</p> <ul style="list-style-type: none"> • Registration To register and unregister your handset and also search the base station. • Handset Name Changing the handset's name. • Sounds <ul style="list-style-type: none"> ○ Ring Tone Configures different ring tones for incoming call. ○ Ring Volume Adjusts ring volume by pressing left/right arrow key. • Language and Input Selects the language to be displayed on the phone's LCD. By default, it is English. • Date Time It is used to configure date and time on the Handset. • Audio Specifies the ringtones for the internal / external and also the volume and the advisory tones (Keypad, Confirmation, Low battery). • Display Configure the backlight timeout. • Network Settings Configure the IP addresses and selecting the IP mode DHCP/Static as well. • Sip Settings Configuring the Sip accounts • System settings Changing the code PIN Factory reset



- **Firmware Upgrade**
Upgrading the firmware version of the handset
- **Factory Functions**
 - **Diagnostic Mode**
All LEDs will light up. All keys' name will display in red on LCD screen before diagnosing. Press any key on the keypad to diagnose the key's function. When done, the key's name will display in blue on LCD with a prompt message (**PASS**). To exit press **Back** (right soft key).
 - **Audio Loopback**
Speak to the phone using speaker/handset/headset. If you can hear your voice, your audio is working fine. Press "Exit" soft key to exit audio loopback mode.
 - **LCD ON / OFF**
Selects this option to turn off LCD. Press any button to turn on LCD.
 - **LCD Diagnostic**
Enters this option and press Left/Right Navigation key to do LCD Diagnostic. Press right soft key to quite.
- **Info**
Display the handset status (Firmware, Model, Hardware, IPEI ...)

Call Settings

Call settings sub menu includes the following options:

- **Do Not Disturb**
Enables/disables Do Not Disturb on the phone.
- **Call Waiting**
Configure the call waiting function.
- **Call Forward**
Configure the call forward function.
- **Speed Dial**
Assign the numbers for speed dial.
- **Outgoing Default Line**
Select the outgoing default line.
- **Auto Answer**
Enable / Disable the Auto answer functionality.
- **Line Status**
Display the line status.



BASIC OPERATIONS

Turning the Handset ON / OFF

To turn ON the handset

- Long press on the power key  until the LCD screen lights up.

To turn OFF the handset

- Long press on the power key  again when the handset is idle until the display turns off.

Register DP720 Handset to DP750 Base Station

1. On DP750 Base station, press and hold the Radio/Page button for 7 seconds until the Radio icon starts blinking to start Subscription process. Or Access web UI, go to **Status >DECT Status** and press **Subscribe** button to **Open Subscription**.

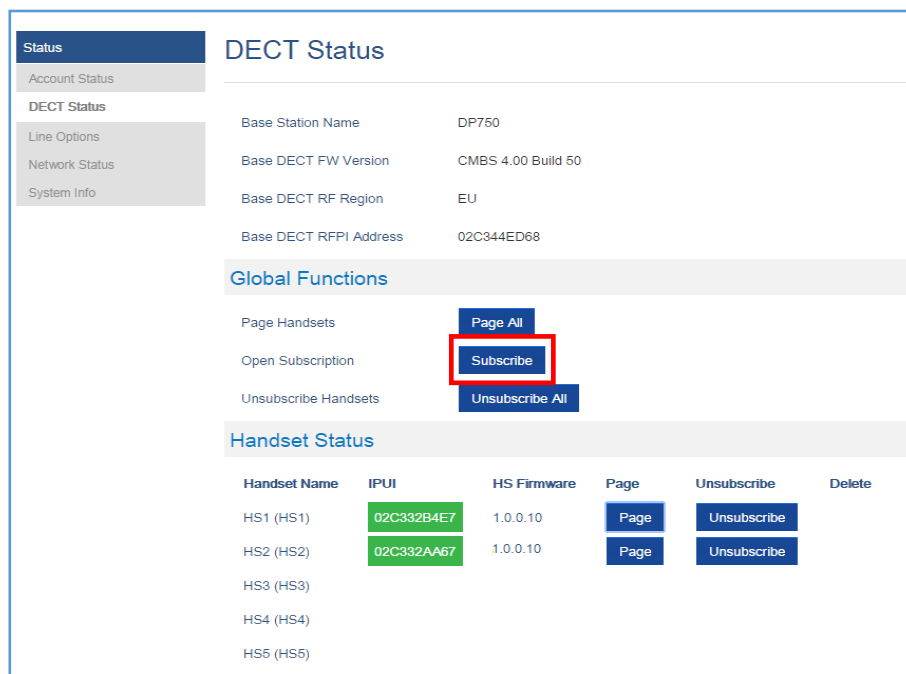



Figure 9: DECT Status

2. On DP720, Press **Menu** (left soft key  or the selection key ) to bring up operation menu.
3. Press **Arrow keys** to move the cursor to **Settings** and then press **Select**.
4. Navigate to **Registration**, then press **Select** (left soft key).



5. Navigate to **Register**, then press **Select** while the DP750 Radio icon is blinking.
6. Select **BaseX** (X=1-4) corresponding to the desired base station DP750, then press **Subscribe**.
7. DP720 will search for nearby base stations and displays the RFPI code of the discovered DP750.
8. Press **Subscribe** to pair with the displayed DP750.
9. The DP720 will display **Easy Pairing** on the LCD and play an audible buzz when successful. Then it will return to the home screen, displaying the handset name and number assigned by the registered base station.

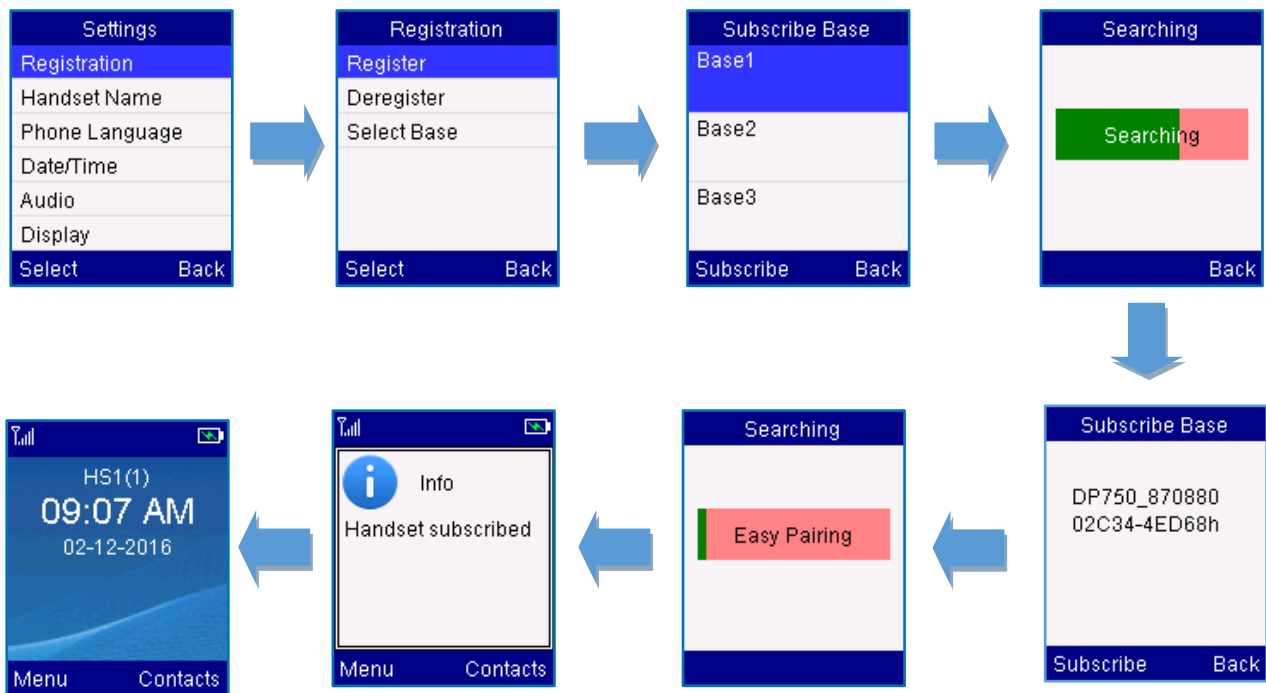

Figure 10: Registration process



Unregister the DP720

1. Press **Menu** on the DP720 to bring up operation menu.
2. Press **Arrow keys** to move the cursor to **Settings**.
3. Navigate to **Registration**, and then press **Select**.
4. Navigate to **Deregister**.
5. Select the Handset to be unregistered and press the left soft key **Deregister**.
6. Enter the system PIN (default: 0000).
7. Press the **Done** soft key to confirm or **back** to cancel.



Checking DP750 Base Station IP Address

DP750 is by default configured to obtain IP address from DHCP server where the unit is located. In order to know which IP address is assigned to your DP750, please follow below steps using a paired DP720 handset with your DP750 base station. Please see Register DP720 Handset to DP750 Base Station

1. Press **Menu** left soft key  or **OK** button  on DP720 to bring the main menu.
2. Use Navigation keys to reach  **Settings** menu
3. Browse sub-menus until reaching **Info** sub-menu.





4. Press **Select** key using left soft key 
5. **Info** page will be displayed, browse the screen to find **IP Address**, **Subnet Mask** and **Default Gateway** information for your DP750.



Setting the Key Lock

You can lock the keypad against unintentional entries. It is, however, still possible to pick up incoming calls even with the keypad locked.

• To enable the Keypad Lock

1. Press the **pound key** “#”  and hold for approximately 2 seconds.
2. The display shows Keypad Locked briefly and the key lock icon  appears in the display.



- **To disable the Keypad Lock**

1. Press and **hold pound key** # “to  k the keys.
2. Keypad Unlocked appears briefly in the display and a windows prompt will be displayed to confirm that the keypad is unlocked.

Locating a DP720 Handset from DP750 Base station

In some situations, you may have a DP720 handset incorrectly positioned and you don't know its current location. You can locate a DP720 handset from his registered DP750 base station using below steps:

Locate Via DP750 Web UI

1. Access your DP750 base station web UI by entering its IP address in your favorite browser.
2. Enter your admin password (default: admin)
3. Press **Login** to access your settings.
4. Go to **Status >DECT Status** tab
5. Choose which handset to locate and press its corresponding **Page** button.
6. A paging call will be received on the selected DP720 handset.

If you press **Page All**, all registered DP720 handsets will be receiving paging call.

7. Once located, you can press any key on the handset or press **Page** or **Page All** to end paging call.

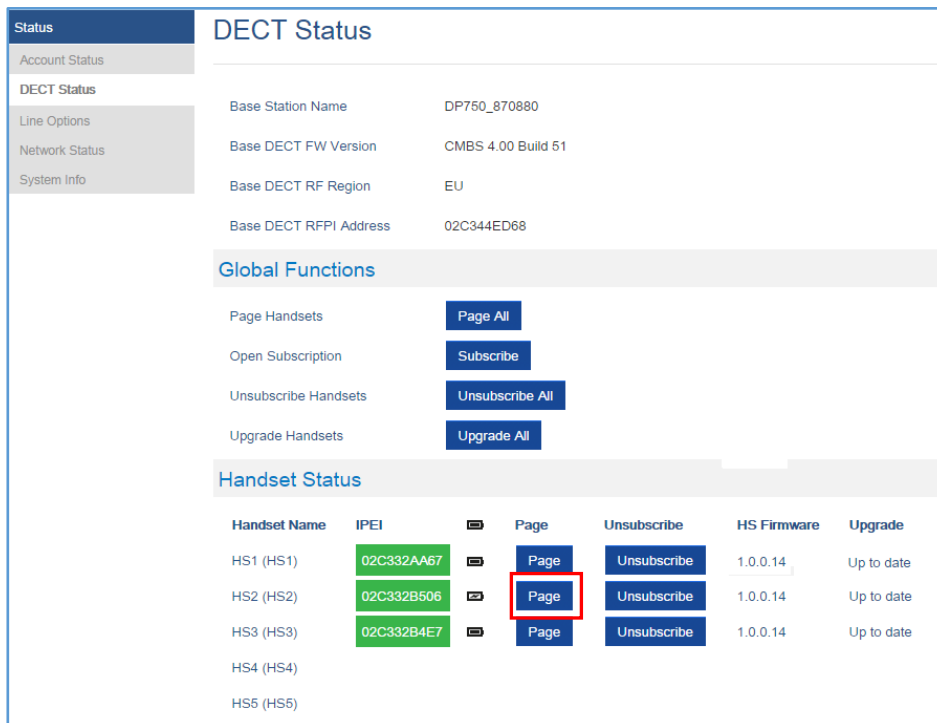

The screenshot shows the 'DECT Status' page in a web UI. On the left is a navigation menu with 'DECT Status' selected. The main content area is divided into sections: 'Global Functions' with buttons for 'Page All', 'Subscribe', 'Unsubscribe All', and 'Upgrade All'; and 'Handset Status' which is a table of handset information.

Handset Name	IPEI		Page	Unsubscribe	HS Firmware	Upgrade
HS1 (HS1)	02C332AA67		Page	Unsubscribe	1.0.0.14	Up to date
HS2 (HS2)	02C332B506		Page	Unsubscribe	1.0.0.14	Up to date
HS3 (HS3)	02C332B4E7		Page	Unsubscribe	1.0.0.14	Up to date
HS4 (HS4)						
HS5 (HS5)						

Figure 11 : Locate Handset via Web UI



Locate Via DP750 Base Station

1. On DP750 Base station back side, press Radio/Page button 
2. All registered handsets will receive Paging call.
3. Once located, you can end the paging calling by pressing any key on the handsets or by pressing again Radio/Page button

Understanding DP720/750 Voice Prompt

DP720 Base Station has a built-in voice prompt menu for simple device configuration. The IVR menu work with any Handset registered to the base. Pick up the handset and dial “****” to use the IVR menu.

Table 9: Voice Prompt Menu

Menu	Voice Prompt	Options
Main Menu	“Enter a Menu Option”	Press “*” for the next menu option Press “#” to return to the main menu Enter 01-05, 07,10, 13-17,47 or 99 menu options
01	“DHCP Mode”, “Static IP Mode”	Press “9” to toggle the selection If using “ <i>Static IP Mode</i> ”, configure the IP address information using menus 02 to 05. If using “ <i>Dynamic IP Mode</i> ”, all IP address information comes from the DHCP server automatically after reboot.
02	“IP Address “ + IP address	The current WAN IP address is announced If using “ <i>Static IP Mode</i> ”, enter 12 digit new IP address. You need to reboot the DP750 for the new IP address to take Effect.
03	“Subnet “ + IP address	Same as menu 02
04	“Gateway “ + IP address	Same as menu 02
05	“DNS Server “ + IP address	Same as menu 02



07	Preferred Vocoder	Press “9” to move to the next selection in the list: <ul style="list-style-type: none"> • PCM U / PCM A • iLBC • G-726 • G-723 • G-729
10	“MAC Address”	Announces the Mac address of the unit.
13	Firmware Server IP Address	Announces current Firmware Server IP address. Enter 12 digit new IP address.
14	Configuration Server IP Address	Announces current Config Server Path IP address. Enter 12 digit new IP address.
15	Upgrade Protocol	Upgrade protocol for firmware and configuration update. Press “9” to toggle between TFTP / HTTP / HTTPS
16	Firmware Version	Firmware version information.
17	Firmware Upgrade	Firmware upgrade mode. Press “9” to toggle among the following three options: <ul style="list-style-type: none"> - always check - check when pre/suffix changes - never upgrade
47	“Direct IP Calling”	Enter the target IP address to make a direct IP call, after dial tone. (See “ <i>Make a Direct IP Call</i> ”.)
86	Voice Mail	Number of Voice Mails
99	“RESET”	Press “9” to reboot the device Enter MAC address to restore factory default setting (See Restore Factory Default Setting section)
	“Invalid Entry”	Automatically returns to main menu
	“Device not registered”	This prompt will be played immediately after off hook If the device is not register and the option “Outgoing Call without Registration” is in NO

Five Success Tips when using the Voice Prompt

- “*” shifts down to the next menu option and “#” returns to the main menu
- “9” functions as the ENTER key in many cases to confirm or toggle an option
- All entered digit sequences have known lengths - 2 digits for menu option and 12 digits for IP address. For IP address, add 0 before the digits if the digits are less than 3 (i.e. - 192.168.0.26 should be key in like 192168000026. No decimal is needed).
- Key entry cannot be deleted but the phone may prompt error once it is detected.





Checking System Status

You can view the system status on your handset including the following information of the system:

Table 10: DP720 Info description

Item	Description
Model	Displays the handset model. DP720
Firmware	Displays the current firmware version installed on DP720. i.e.: 1.0.0.14
Hardware	Displays the hardware version of DP720. i.e.: 1.4A
IPEI	International Portable Equipment Identifier. Unique “serial number” for DECT handsets.
DECT Region	Displays region of DECT. i.e. EU or US
IP Address	Displays IP address of the base station DP750 if registered.
Subnet Mask	Displays Subnet Mask of the base station DP750 if registered.
Gateway	Displays Gateway IP of the base station DP750 if registered.
MAC address	Displays MAC address of the base station DP750 if registered.





To check the handset status:

1. Press **Menu** (left soft key  or the selection key ) to bring up operation menu.
2. Use Navigation keys to reach  **Settings** menu
3. Browse sub-menus until reaching **Info** sub-menu and press **Select**.

Basic Network Settings

Once connected to the network the base station attempts to contact a DHCP server to obtain valid network settings (e.g., IP address, subnet mask, gateway address and DNS address) by default.

The users could also configure basic network settings manually. In order to configure the network settings manually, please follow the steps below:

1. Press **Menu** (left soft key  or the selection key ) to bring up operation menu.
2. Use Navigation keys to reach  **Settings** menu
3. Navigate to select **NetworkSettings**.
4. Enter the system PIN (default: 0000) and press the soft key **Save** (Left arrow key) .
5. To change to static IP, press  to select **Static** from the **IP Settings** field.
6. Enter valid values in the **IP Address**, **Subnet Mask**, **Gateway**, **DNS Server** fields.



7. Press the **Save** soft key () to save and apply the new changes.

A message prompt message will be displayed to confirm that the new settings are saved successfully.

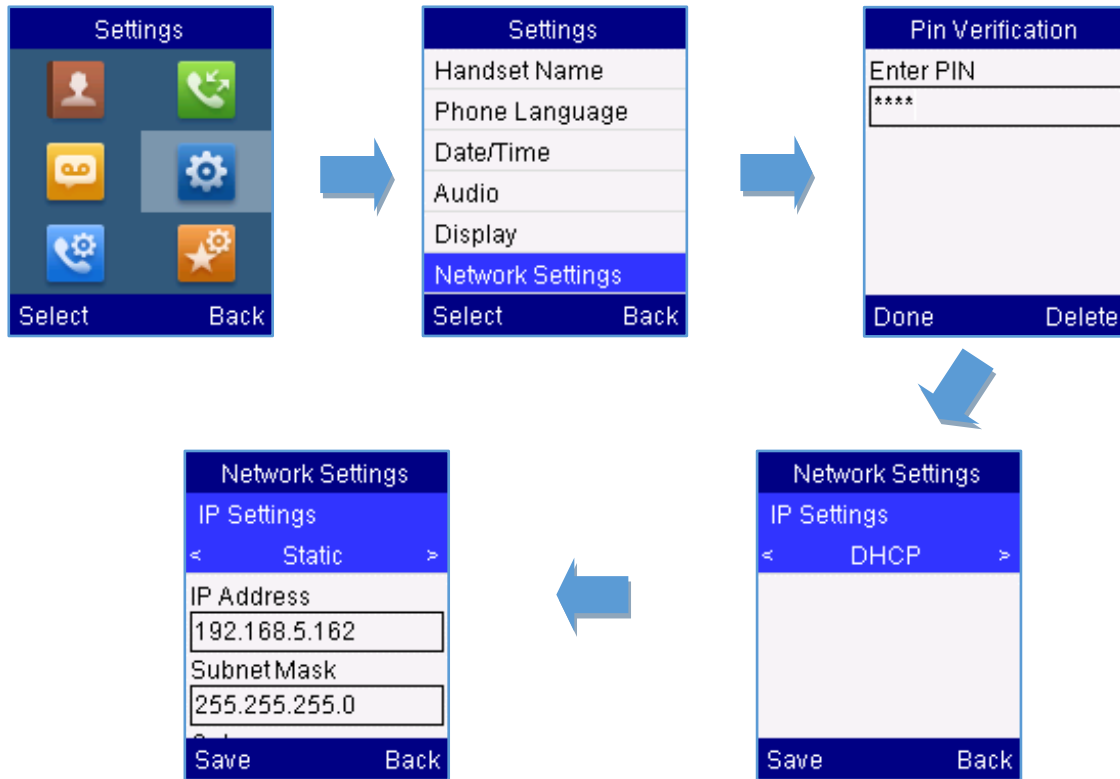

Figure 12 : Network Settings configuration

Register a SIP Account

DP750 supports up to 10 SIP accounts, 5 handsets. Each Handset can be configured up to 10 accounts. Please be aware that his line settings will be affected by DID settings (hunting group settings) in “DECT Account Settings”.

Register Account via Web User Interface

1. Access your DP750 base station web UI by entering its IP address in your favorite browser.
2. Enter your admin password (default: admin)
3. Press **Login** to access your settings.
4. Go to **Profiles** tab and select a profile to use.

DP750 supports up to 4 profiles. A profile is a set of settings including general settings, network settings, SIP setting, audio setting, call settings and ring tones, and etc.

A profile can be used with different SIP accounts.

5. In **General Settings**, set the following:



- a. **Profile Active** to **Yes**
- b. **SIP Server** field with your SIP server IP address or FQDN.
- c. **Failover SIP Server** with your Failover SIP Server IP address or FQDN. Leave empty if not available.
- d. **Prefer Primary SIP Server** to **No** or **Yes** depending on your configuration. Set to **No** if no Failover SIP Server is defined. If **Yes**, account will register to Primary SIP Server when failover registration expires.
- e. **Outbound Proxy** with your Outbound Proxy IP Address or FQDN. Leave empty if not available.

For more information, related to above options please refer to **Technical Information table**.

6. Press **Save and Apply** to save your configuration.

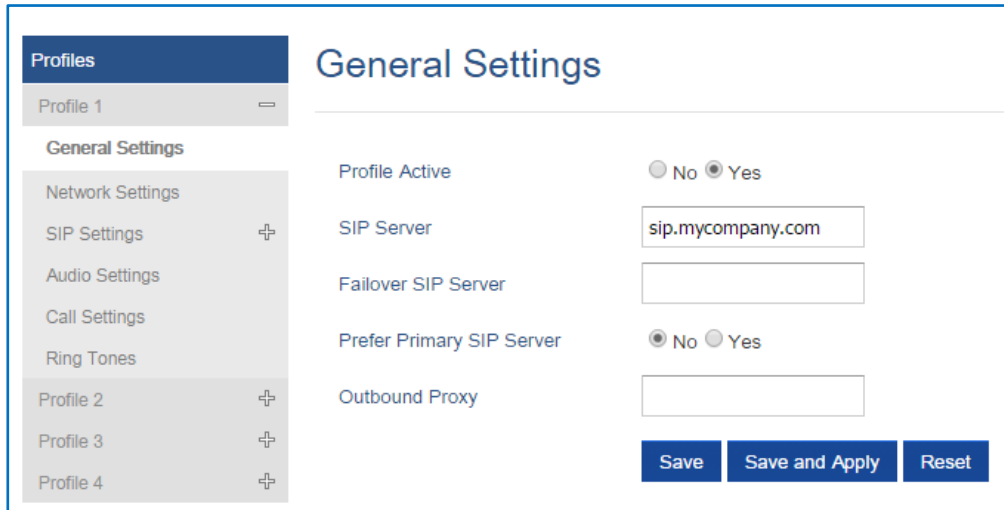
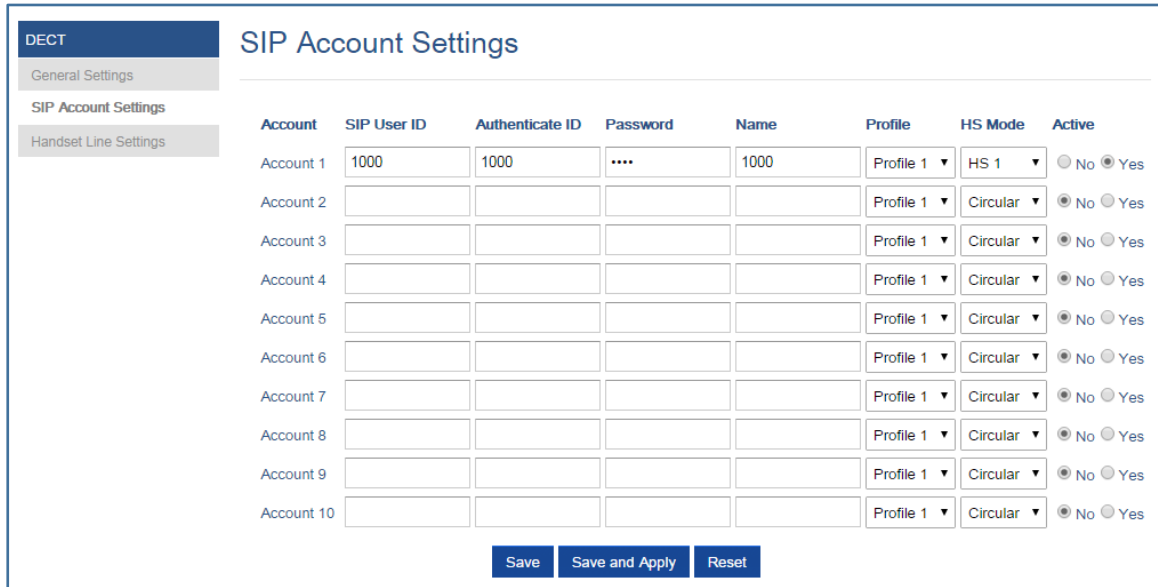

Figure 13: SIP Settings

7. Go to **DECT >SIP Account Settings**
8. Configure your SIP details in desired account:
 - a. **Account:** Select Account row to configure (Account 1 – Account 10)
 - b. **SIP User ID:** User account information, provided by VoIP service provider (ITSP). Usually in the form of digit similar to phone number or actually a phone number.
 - c. **Authenticate ID:** SIP service subscriber's Authenticate ID used for authentication. Can be identical to or different from SIP User ID.
 - d. **Password:** SIP service subscriber's account password to register to SIP server of ITSP. For security reasons, the password will field will be shown as empty.
 - e. **Name:** Any name to identify this specific user.
 - f. **Profile:** Select the corresponding Profile ID (1/2/3/4)
 - g. **HS Mode:** Assign the account to specific handset (HS1, HS2, HS3, HS4 or HS5) or hunting group mode



- h. **Active:** Set to **Yes**. If set to **No**, account is disabled and will not register.
9. Press **Save and Apply** to save your configuration.



The screenshot shows the 'SIP Account Settings' page. On the left, there is a navigation menu with 'DECT' selected, and sub-items for 'General Settings', 'SIP Account Settings', and 'Handset Line Settings'. The main area contains a table with 10 rows, each representing an account. The columns are: Account, SIP User ID, Authenticate ID, Password, Name, Profile, HS Mode, and Active. Account 1 is pre-filled with '1000' for SIP User ID and Authenticate ID, and '1000' for Name. The 'Active' column has radio buttons for 'No' and 'Yes', with 'Yes' selected for all accounts. Below the table are three buttons: 'Save', 'Save and Apply', and 'Reset'.

Account	SIP User ID	Authenticate ID	Password	Name	Profile	HS Mode	Active
Account 1	1000	1000	1000	Profile 1	HS 1	<input checked="" type="radio"/> No <input checked="" type="radio"/> Yes
Account 2					Profile 1	Circular	<input checked="" type="radio"/> No <input type="radio"/> Yes
Account 3					Profile 1	Circular	<input type="radio"/> No <input checked="" type="radio"/> Yes
Account 4					Profile 1	Circular	<input checked="" type="radio"/> No <input type="radio"/> Yes
Account 5					Profile 1	Circular	<input type="radio"/> No <input checked="" type="radio"/> Yes
Account 6					Profile 1	Circular	<input checked="" type="radio"/> No <input type="radio"/> Yes
Account 7					Profile 1	Circular	<input type="radio"/> No <input checked="" type="radio"/> Yes
Account 8					Profile 1	Circular	<input checked="" type="radio"/> No <input type="radio"/> Yes
Account 9					Profile 1	Circular	<input type="radio"/> No <input checked="" type="radio"/> Yes
Account 10					Profile 1	Circular	<input checked="" type="radio"/> No <input type="radio"/> Yes

Figure 14: SIP Accounts Settings

After applying your configuration, your phone will register to your SIP Server.

You can verify if your DECT phone has registered with your SIP server from your DP750 web interface under **Status >Account Status** (a green background with Yes under SIP Registration column for corresponding account indicates the account has been successfully registered).

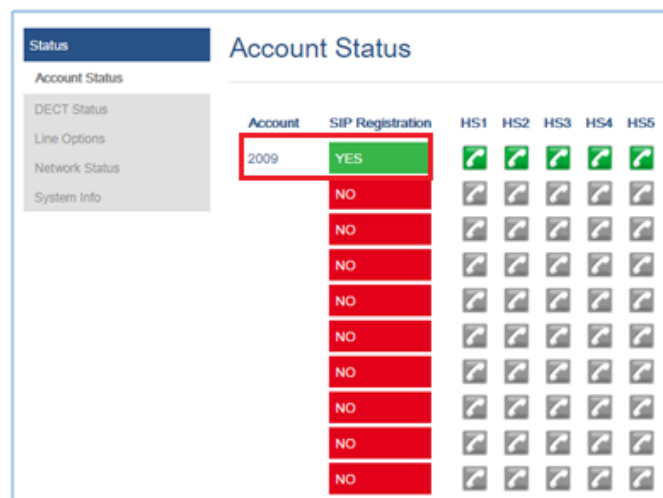

The screenshot shows the 'Account Status' page. On the left, there is a navigation menu with 'Status' selected, and sub-items for 'Account Status', 'DECT Status', 'Line Options', 'Network Status', and 'System Info'. The main area contains a table with columns: Account, SIP Registration, HS1, HS2, HS3, HS4, and HS5. The first row (Account 2009) has a green background and 'YES' in the SIP Registration column, with green checkmarks in the HS columns. The other rows have a red background and 'NO' in the SIP Registration column, with grey checkmarks in the HS columns.

Account	SIP Registration	HS1	HS2	HS3	HS4	HS5
2009	YES	<input checked="" type="checkbox"/>	<input checked="" type="checkbox"/>	<input checked="" type="checkbox"/>	<input checked="" type="checkbox"/>	<input checked="" type="checkbox"/>
	NO	<input type="checkbox"/>	<input type="checkbox"/>	<input type="checkbox"/>	<input type="checkbox"/>	<input type="checkbox"/>
	NO	<input type="checkbox"/>	<input type="checkbox"/>	<input type="checkbox"/>	<input type="checkbox"/>	<input type="checkbox"/>
	NO	<input type="checkbox"/>	<input type="checkbox"/>	<input type="checkbox"/>	<input type="checkbox"/>	<input type="checkbox"/>
	NO	<input type="checkbox"/>	<input type="checkbox"/>	<input type="checkbox"/>	<input type="checkbox"/>	<input type="checkbox"/>
	NO	<input type="checkbox"/>	<input type="checkbox"/>	<input type="checkbox"/>	<input type="checkbox"/>	<input type="checkbox"/>
	NO	<input type="checkbox"/>	<input type="checkbox"/>	<input type="checkbox"/>	<input type="checkbox"/>	<input type="checkbox"/>
	NO	<input type="checkbox"/>	<input type="checkbox"/>	<input type="checkbox"/>	<input type="checkbox"/>	<input type="checkbox"/>
	NO	<input type="checkbox"/>	<input type="checkbox"/>	<input type="checkbox"/>	<input type="checkbox"/>	<input type="checkbox"/>

Figure 15 : SIP Accounts Status



Return to Idle Screen

Press the power key  to quickly exit the menu and return back to the main idle screen.

If you do not press any key in a period of time, the LCD screen will automatically exit the menu and return to the idle screen as well.

When you are navigating on the handset's menu, and you receive an incoming call, the LCD screen will automatically exit the menu and you can either accept or reject the call, when the call is terminated, the LCD screen will return back to the idle screen.



PHONE SETTINGS

This chapter will help you with the instruction for configuring and changing the settings of your DP720,

Editing the Handset's name

The procedure for changing the name of your handset shown in the display in standby mode is as follows:











1. Press **Menu** (left soft key  or the selection key ) to bring up operation menu.
2. Use Navigation keys to reach  **Settings** menu
3. Navigate to select **Handset Name**, and then press **Select** (left soft key) 
4. Enter the desired name and press **Rename** (left soft key ) and then the DP720 will display a confirmation message that the rename operation was successful.



Figure 16: Handset Name editing

Changing the Base PIN

Users can change their code PIN by following the steps bellow:

1. Press **Menu** (left soft key  or the selection key ) to bring up operation menu.
2. Use Navigation keys to reach  **Settings** menu
3. Navigate to select **System Settings**, and then press **Select** (left soft key) 
4. Enter the current code PIN (By Default is 0000), a new window will be displayed inviting you to enter the new password, when done press **Save** (left soft key ) and a prompt message will be displayed to confirm that the new Code PIN has been saved successfully.



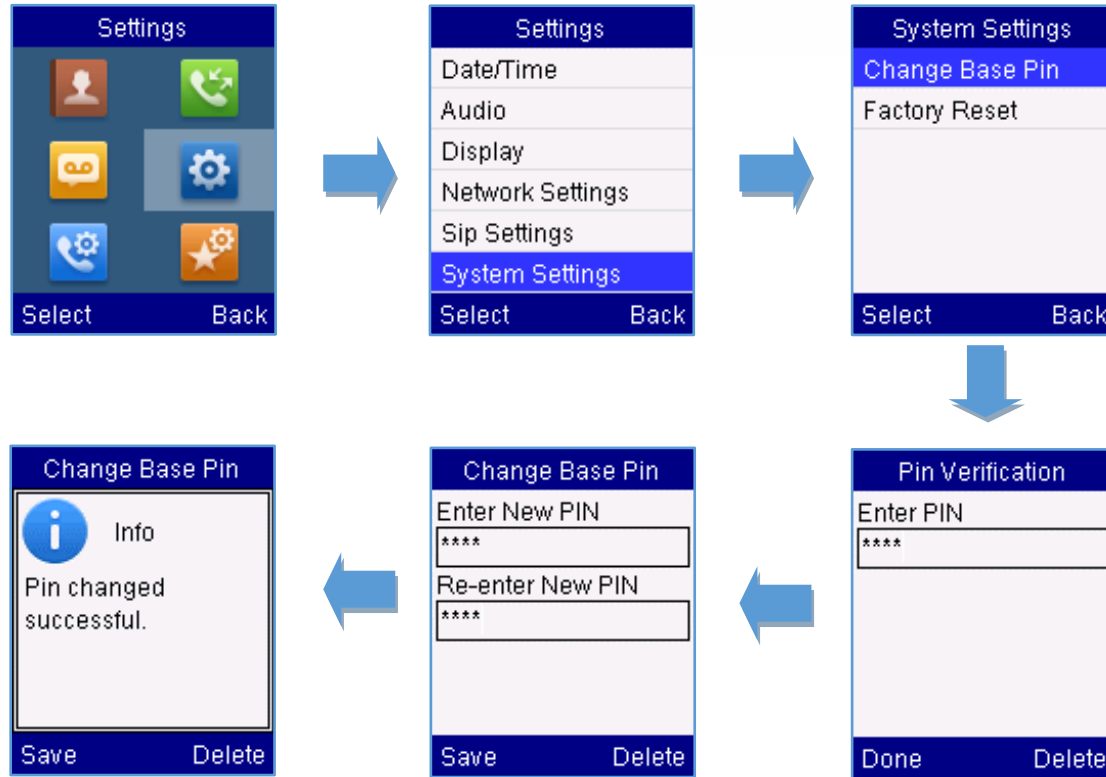

Figure 17: Changing Admin Base PIN Code

Selecting the Menu Language

The DP720 supports displaying texts in different languages. The handset supports 27 languages (see the table of the technical specifications). The default language of the handset is English. You can change the language according to your requirement. To change the language of the handset, please proceed as follows:







1. Press **Menu** (left soft key  or the selection key ) to bring up operation menu.
2. Use Navigation keys to reach  **Settings** menu
3. Navigate to select **Phone language**, then select the desired language and press the **Select**(L-soft key ). The LCD screen prompts “Change phone language to xxx (xxx is the language you selected)”
4. Press **Yes**(Left soft key ) to accept the change. Text displayed on the handset will change to the selected language.









Figure 18: Handset Language

Activate/Deactivate Hands-Free Mode



This function allows you to make a call without having to hold the handset in your hand.

1. Press the Hands free key  while you are making a call or on the idle screen to activate hands free mode.
2. Press the Hands free key  in to deactivate the hands free function.

Muting the Microphone

Press the mute key  to switch off the microphone during an established call. You can now talk freely without the other party hearing you and the icon of mute will be displayed  on the screen. Press the mute key again to switch the  microphone back on.

Adjusting Speaker and Earpiece Volume

Press left key  right key  while you are on an established call to set the volume of the Earphone / Speaker. You can choose between 5 different levels. The default level is 3:

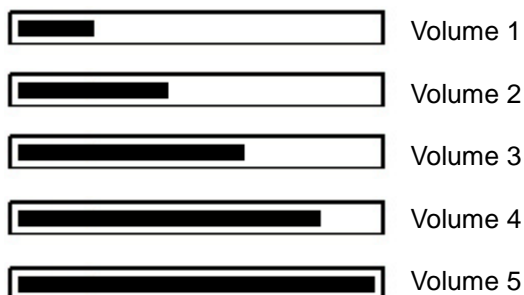





Ringtones

Setting the Ringer Volume on the Handset

You can adjust the ringer volume for an incoming call (internal or external) to one of 6 levels (level 1 to 5 and off). Level 5 is the highest level. (The DP720 Handset is set to level 3 by default).

In order to configure the desired ringer volume, proceed as follows:

1. Press **Menu** (left soft key  or the selection key ) to bring up operation menu.
2. Use Navigation keys to reach  **Settings** menu
3. Navigate to select **Audio** -> **Volume**
4. Press the left and right arrow keys to change repeatedly and set the desired volume
5. Press **Save** (Left soft key ) to confirm the volume, and a message prompt will be displayed to confirm that the new volume has been successfully saved.

If you select **OFF**, the icon  appears in the display and the handset will not ring for incoming calls.

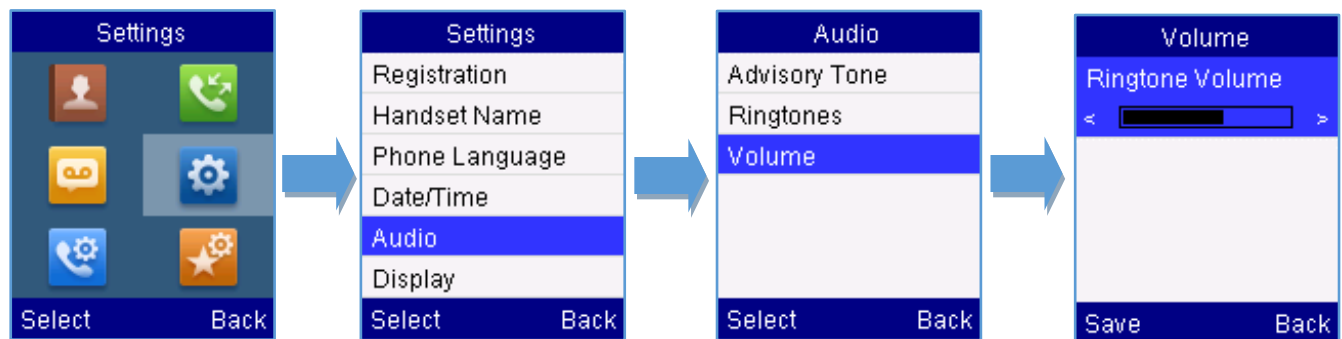

Figure 19: Ringer Volume

Setting the Ringer Melody on the Handset

You can change the ringer melody for an incoming call (internal or external). The device has 8 different ringer melodies for you to choose from (1-8).

- The default setting for the ring tone for an external call is melody 1.
- The default setting for the ring tone for an internal call is melody 1.

In order to configure the desired melody for either an internal/external call, proceed as follows:

1. Press **Menu** (left soft key  or the selection key ) to bring up operation menu.



2. Use Navigation keys to reach  **Settings** menu
3. Navigate to select **Audio** -> **Ringtones**. And then choose which type of calls (**Internal or External calls**) you need to change the ringtones.

Press **Select**(left soft key)  confirm the ringtones selected and a message prompt will be displayed to confirm that the new ringtones has been set successfully.

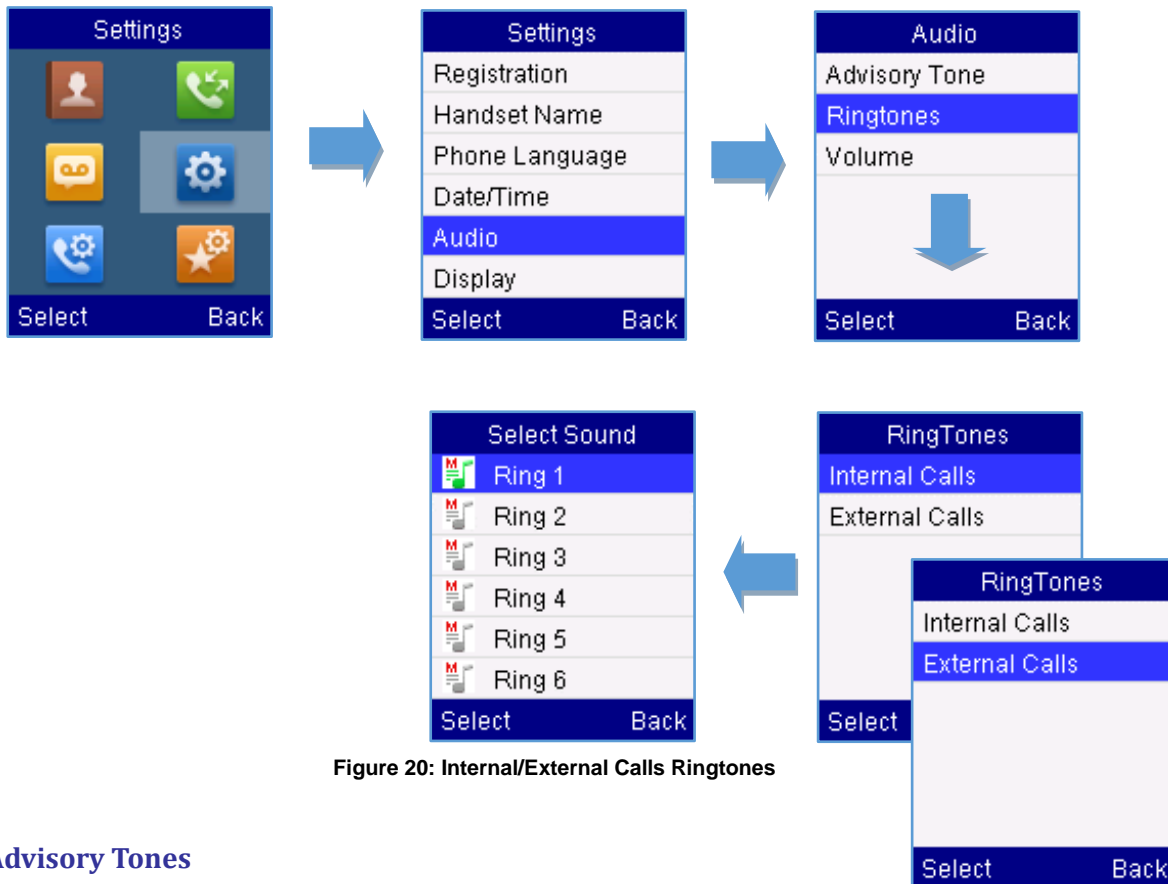





Figure 20: Internal/External Calls Ringtones

Advisory Tones

Advisory tones are acoustic signals, which inform you of different actions and states on your handset. The following advisory tones can be configured independently of each other:

- **Keypad Tone:** it's played when a user presses any key of the keypad.
- **Confirmation:** it's played when a user saves settings or places the handset in the charger cradle.
- **Low Battery:** it's played if the capacity of the batteries is low or the handset requires charging.

To configure the advisory tones

1. Press **Menu** (left soft key  or the selection key ) to bring up operation menu.
2. Use Navigation keys to reach  **Settings** menu
3. Navigate to select **Audio** -> **Advisory tones**, and choose which tone you want to change it.



4. Press the left and right arrow keys to either enable or disable the desired tones.
5. Press **Save** (Left soft key ) to confirm, and a message prompt will be displayed to confirm that the new settings has been successfully saved.

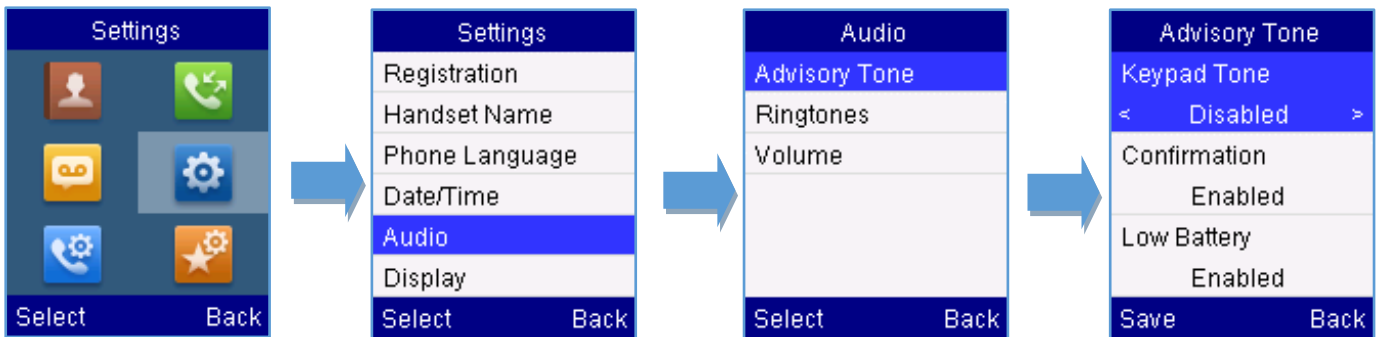

Figure 21: Advisory Tone

Date and Time

On the DP720 the Date and time are displayed on the idle screen and it obtains the date and time from the Simple Network Time Protocol (SNTP) server by default. If your handset cannot obtain the date and time from the SNTP server, you need to configure the date and time manually. You can configure the time format and date format respectively. The handset supports two time formats (12 Hour or 24 Hour) and three date formats (DD/MM/YYYY; MM/DD/YYYY; YYYY/MM/DD).

To configure date and time manually





1. Press **Menu** (left soft key  or the selection key ) bring up operation menu.
2. Use Navigation keys to reach  **Settings** menu
3. Navigate to **Date and time**. Edit the current values in the Date& Time fields (you can change the date / time format using the Left/Right arrow) keys) and then press **Set** (left soft key). 
4. Press the **Save** soft key to apply your changes.







Figure 22: Date and Time Settings



Factory Functions

The factory functions include the following diagnostic options:

- **LCD Diagnostic**
- **LCD ON / OFF**
- **Audio Loopback**
- **Diagnostic Mode**

1. Press **Menu** (left soft key  or the selection key ) to bring up operation menu.
2. Use Navigation keys to reach  **Settings** menu
3. Navigate to select **Factory Functions** and choose which diagnostic, you need to perform, and then press **Select** (left soft key ).

- **For Diagnostic Mode**

All LEDs will light up. All keys' name will display in red on LCD screen before diagnosing. Press any key on the keypad to diagnose the key's function. When done, the key's name will display in blue on LCD with a prompt message (**PASS**). To exit press **Back** (Right soft key) .

- **Audio Loopback**

Speak to the phone using speaker/handset/headset. If you can hear your voice, your audio is working fine. Press **Back** (left soft key)  exit audio loopback mode.

- **LCD ON / OFF**

Selects this option to turn off LCD. Press any button to turn on LCD.

- **LCD Diagnostic**

Enters this option and press Left/Right Navigation key to do LCD Diagnostic (you will notice that the color of the LCD will be changing). Press right soft key  to exit.

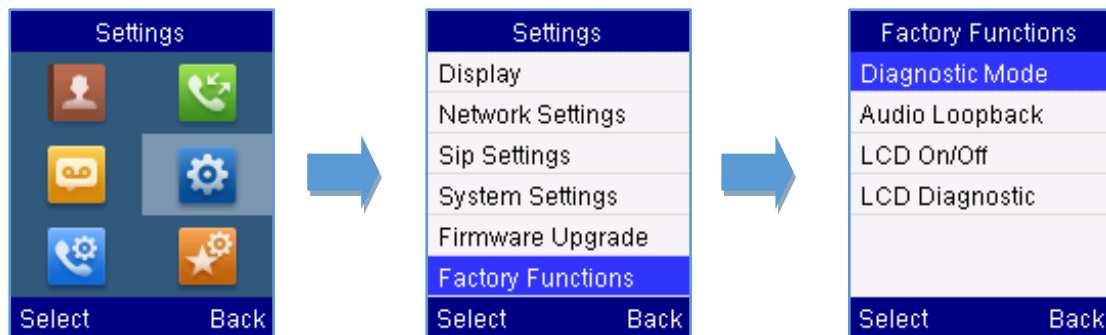





Figure 23: Factory Functions



Firmware Upgrade

To upgrade the firmware on your handset, follow the steps bellow:

1. Press **Menu** (left soft key  or the selection key ) to bring up operation menu.
2. Use Navigation keys to reach  **Settings** menu
3. Navigate to select **Firmware Upgrade** and press the soft key **Select**.
4. The LCD screen will display a prompt message to confirm the firmware downloading / upgrading press the right soft key **Back** to dismiss the upgrade process.

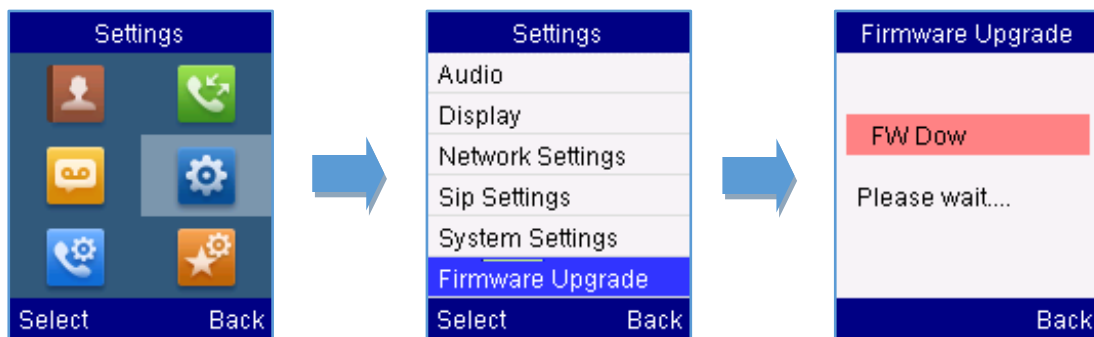







Figure 24: Firmware Upgrade

Reset the Handset DP720

The users can reset the new settings made on the handset. Resetting handset will not overwrite settings of directory, call history, voice mail and the handset registration to the base station. Other customized settings on the handset will be reset to factory settings after performing Factory reset. To reset your handset to the default settings:

1. Press **Menu** (left soft key  or the selection key ) to bring up operation menu.
2. Use Navigation keys to reach  **Settings** menu
3. Navigate to select **Audio** -> **System Settings** and choose **Factory Reset**.
4. The LCD screen will displays a prompt message to confirm restoring factory settings, press **Yes** (left soft key  confirm or **No** (right soft key  and then the handset will reboot to apply the default settings.



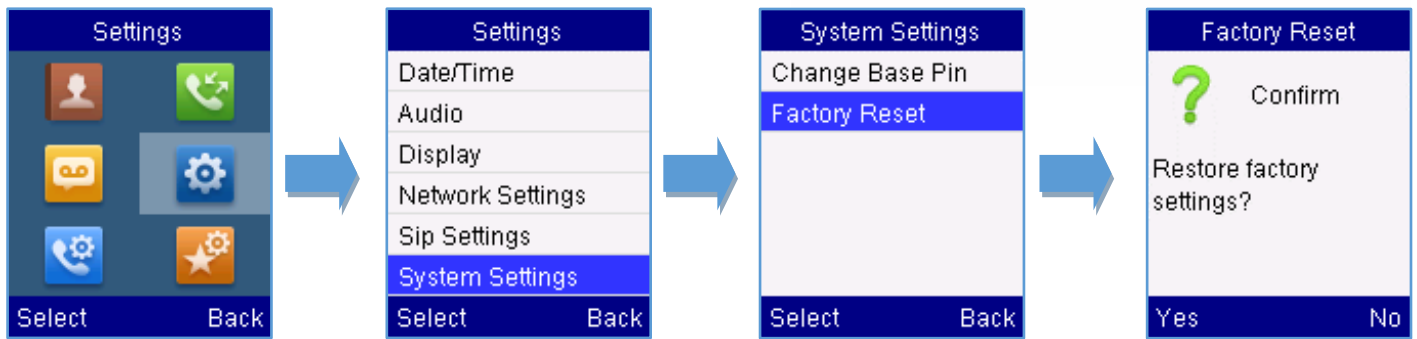

Figure 25: Factory Reset



CALL OPERATIONS

This chapter will guide you to place internal and external calls, transferring and holding the incoming calls.

Placing calls

To place an internal or external calls, you can use the following mode:

- **Earpiece mode:** pressing the off-hook key to dial out.
- **Speakerphone mode:** pressing the speakerphone key to dial out.
- **Headset mode:** connecting a headset.



During the call, you can switch the call mode by pressing the corresponding keys or connecting a headset.

Internal calls



To make phone calls between the handsets registered to the same DP750 Base Station when it is used as a standalone unit, without the use of a SIP server. This feature will also be applicable when the DP750 Base Station is used with Hunting Groups and is registered to SIP server only with one master number.

To make internal calls, follow the next steps:

Method 1:

1. Press Up arrow key  , to display the intercom list containing all the handsets registered.
2. Navigate to choose the desired handset and then press **Select**(left soft key). 
3. To terminate the call, press hang-up key  .

Method 2:

1. In idle screen, enter the 1-digit handset number, for instance 1, or 2, or 3...
2. Press **Intercoms**softkey (using left soft key). 
3. To terminate the call, press hang-up key  .

External Calls





External calls require the use of SIP lines. So you should first assign the SIP Account to the handset beforehand, and then assign the line to the handset.

To make external calls, follow the next steps:





Method1:

1. Enter the desired number using the keypad.



2. Press the dial key  or the speaker key  . If there are multiple lines assigned to your handset as outgoing lines, select the desired line. If you do not select a line, the handset uses the default outgoing line to dial out.
3. Press the dial key  or the left soft key **Call** .
4. To terminate the call, press the hang-up key .





Method2:

1. Press the dial key  or the speaker key  to enter the pre-dialing screen.
2. Enter the number to dial using the keypad.
3. Press the dial key , # (Use # as dial key” must be configured in web configuration) or wait for 4 seconds and the call will be launched automatically.
4. To finish the call, press the hang-up key .

During the call, you can switch the call mode by pressing the corresponding keys and cancel the dialing operation by pressing the on-hook key. During the call conversations, you can press the left and right navigation keys to adjust the volume. The call duration is displayed on the LCD screen while the call is in progress and call summary will be displayed once the call is terminated.

Dialing from Call history



Users may use their call history entries to initiate calls.

1. Press **Menu** (left soft key  or the selection key ) to bring up operation menu.
2. Use Navigation keys to reach **Call History** icon  then press **Select** (left soft key ).
3. Select the desired entry, then press either dial key  or **Options** key > **Edit and Dial** > **Call** to establish the call.

The call history list stores the last dialed phone numbers. When the memory of the redial number list is full, the handset will automatically erase the oldest dialed number when a new number is dialed.

Answering Calls

When receiving an incoming call, you can answer the call using following steps:

1. Press the dial key  to pick up the call or the **Accept** Soft key (left soft key) .
2. To answer an incoming call when you're already in another call, press the dial key , or



thespeaker key  or the **Answers** soft key. The incoming call is answered, and the original call is placed on hold.

3. To terminate the call, press hang-up key .





Note: You can switch off the ringer temporarily by pressing **Silent** Soft key.

Auto Answer

To simply answer the incoming calls by picking up the handset from the charger cradle without having to press the off-hook key.

The auto answer feature works only if the handset is placed in the charger cradle.

To activate / deactivate the auto answer feature

1. Press **Menu** (left soft key  or the selection key ) to bring up operation menu.
2. Use Navigation keys to reach **Call settings** , and then press **Select** (left soft key ) and navigate to **Auto Answer** using the Up / down keys arrow.
3. Press the left soft key **Save** after **Enabling** / **Disabling** the auto answer option.

Direct IP Call

Direct IP calling allows two parties, that is, a Handset and another VoIP Device, to talk to each other in an ad hoc fashion without a SIP proxy.

Elements necessary to complete a Direct IP Call:

1. Both DP720 and other VoIP Device, have public IP addresses, or
2. Both DP720 and other VoIP Device are on the same LAN using private IP addresses, or
3. Both DP720 and other VoIP Device can be connected through a router using public or private IP addresses (with necessary port forwarding or DMZ).

DP720 supports two ways to make Direct IP Calling:

Using IVR

1. Pick up the handset and press dial key , then access to the voice menu prompt by dialing***
2. Dial **47** to access the direct IP Call menu.
3. Enter the IP address after the voice prompt **Direct IP Calling**



Using Star Code

1. Pick up the handset and press the dial key 
2. Dial ***47** followed by the target IP Address.

Note: You can enter directly *47 + target IP address, and then press the dial key to initiate the call.



Examples of direct IP calls



- a) If the target IP address is 192.168.0.160, the dialing convention is ***47 or Voice Prompt with option 47, then 192*168*0*160**, followed by pressing the “#” key if it is configured as a send key or wait 4 seconds. In this case, the default destination port 5060 is used if no port is specified.
- b) If the target IP address/port is 192.168.1.20:5062, then the dialing convention would be:
***47 or Voice Prompt with option 47, then 192*168*0*160*5062** followed by pressing the “#” key if it is configured as a send key or wait for 4 seconds.

Note: To use direct IP call, **Use Random Port** setting should be set to **NO**.

Call Hold/Resume

During an established call, you can put the call on hold and resume following below steps:





1. Press the left soft key  to access the call **Options** and then navigate to **Hold**.
2. Press **Select**, left soft key  to put the call on hold.
3. To resume the call, access the options menu again and navigate to **Resume**, then press **Select**.

If you press  during the call, the first call will be on hold, and you can establish a new call; to resume the initial call, press .

Call waiting

This feature will notify you of a new incoming call during an established call, and display the incoming call information visually on the LCD screen and a call waiting tone will be heard. If this feature is disabled, the new incoming call will be automatically rejected.

To configure the call waiting feature, follow the next steps:

1. Press **Menu** (left soft key  or the selection key ) to bring up operation menu.
2. Access to **Call settings**  then to **Call waiting** sub-menu.
3. Select the account on which you want to enable the Call waiting feature, and then press the soft key **Select** (left soft key .





4. Choose between **Enabled** and **Disabled** options and press the soft key **Save**, a prompt message will be displayed to confirm that the call waiting is enabled / disabled.

Do Not Disturb

You can activate or deactivate the DND mode for your accounts registered on the handset under the call settings. If DND mode is activated for a specific line, all incoming calls will receive busy treatment depending on your configuration (forward to voice mail, busy tone...)

To enable or disable the DND mode, follow the next steps

1. Press **Menu** (left soft key  or the selection key ) to bring up operation menu.
2. Access **Call settings**  and then to **Do Not Disturb** sub-menu.
3. Select the account on which you want to enable / disable the DND mode and then press **Select**
4. Choose between **Enabled** and **Disabled** options and press the soft key **Save** to accept the changes, a prompt message will be displayed to confirm that the DND is enabled / disabled.





You can check the line status if the DND mode is enabled on the base station.

Call forward

The call forward feature will allow you to forward all the incoming calls to the desired number. Three possible call forward types are available on the DP720.

- **Forward all:** All the Incoming calls are immediately forwarded.
- **Busy Forward:** Incoming calls are immediately forwarded if the line is busy.
- **No Answer Forward:** Incoming calls are forwarded if not answered after a period of time.

To enable the call forward, please refer to the following steps:

1. Press **Menu** (left soft key  or the selection key ) to bring up operation menu.
2. Access to **Call settings**  and then to **Call Forward** sub-menu.
3. Select the account on which you want to enable/disable the call forward feature and press **Select**.
4. Select the type of call forwarding and enter the number to forward the calls, and then press **Save** (left soft key  apply the settings, a prompt message will be displayed to confirm that the new settings have been saved successfully.





Call transfer



The DP720 supports the call transfer feature, you can transfer a call to another party using one of the following ways:

- **Blind Transfer:** Transfer a call directly to another party without consulting
- **Attended Transfer:** Transfer a call with prior consulting.

Blind transfer

1. Press the **Options** soft key (Left soft key ) during a call, and then select **Transfer**.
2. The initial call will be on hold, enter the number or select the handset you want to transfer the call to.
3. Press dial key  The call is connected to the number or the handset you specified, and the LCD screen prompts **Call Transferred**.



Attended Transfer

1. Press the **Options** soft key (Left soft key ) during a call, and then select **New call**.
2. Choose the line and enter the number you want to transfer the call to, then press the dial key  .
3. Once the second call is established, press the left soft key  **Option** and select **Transfer**.

Speed Dial

Speed dial allows users to perform single-digit dialing to predefined numbers. This feature is particularly useful to speed up dialing the numbers that frequently used or hard to remember. A maximum of 8 speed dial numbers is allowed. For example, the digit key 2 is configured as a speed dial key and assigned the number 2000, the phone will dial out the number 2000 directly when you long press digit key 2.

To assign the frequently used numbers from your shared contacts as speed dial keys:

1. Press **Menu** (left soft key  or the selection key ) to bring up operation menu.
2. Access to **Call settings**  and then to **Speed Dial** sub-menu.
3. Choose the digit keys (2-9) and press **Assign** to specify the number (from the shared directory) to be as speed dial.





You can press **Change** or **Delete** soft keys to modify/delete a speed dial key



3-Way Conference

The DP720 supports creating a local conference with other parties, the handset support adding 3 parties including yourself in the same conference call.



To configure the 3 Way conference feature, see the following steps:

1. Press the dial key  to place a call to the first party.
2. Press the soft key **Options** (left soft key ) , then select **Conference**
3. Enter the number of the second party you want to add to the conference and press the dial key  .
To drop the conference call, press  or the End soft key.



Voice Mail

The voice mail feature ensures that you will never miss any important messages. It permits either to leave voice mails to someone else or receive and listen to voice mails via the handset

Set Voice mail feature code

1. Press **Menu** (left soft key  or the selection key ) to bring up operation menu.
2. Access to **Voice Mail**  and then select **Set Voice Mail** sub menu.
3. Select the account and enter the voice mail code feature, then press **Save** softkey.

Play voice mail messages

1. Press **Menu** (left soft key  or the selection key ) to bring up operation menu.
2. Access to **Voice Mail**  and then select **Play Messages** sub menu.
3. Select the account to retrieve your voice messages saved on your voice mail.



Call Features

The DP750/DP720 supports traditional and advanced telephony features including caller ID, caller ID with caller Name, call forward and etc.

Table 11: Call Features

*30	Block Caller ID (for all subsequent calls) <ul style="list-style-type: none"> • Off hook the phone; • Dial *30.
*31	Send Caller ID (for all subsequent calls) <ul style="list-style-type: none"> • Off hook the phone; • Dial *31.
*50	Disable Call Waiting <ul style="list-style-type: none"> • Off hook the phone; • Dial *50.
*51	Enable Call Waiting <ul style="list-style-type: none"> • Off hook the phone; • Dial *51.
*67	Call with Caller ID Blocked (per call) <ul style="list-style-type: none"> • Off hook the phone; • Dial *67 and then enter the number to dial out.
*82	Call with Caller ID Enabled (per call) <ul style="list-style-type: none"> • Off hook the phone; • Dial *82 and then enter the number to dial out.
*70	Call with Call Waiting Disable (per Call) <ul style="list-style-type: none"> • Off hook the phone; • Dial *70 and then enter the number to dial out.
*71	Call with Call Waiting Enabled (per Call) <ul style="list-style-type: none"> • Off hook the phone; • Dial *71 and then enter the number to dial out.
*72	Unconditional Call Forward. To set up unconditional call forward: <ul style="list-style-type: none"> • Off hook the phone; • Dial *72 and then enter the number to forward the call;



	<ul style="list-style-type: none">• Press OK soft key or SEND key.
*73	Cancel Unconditional Call Forward. To cancel the unconditional call forward: <ul style="list-style-type: none">• Off hook the phone;• Dial *73;• Hang up the call.
*90	Busy Call Forward. To set up busy call forward: <ul style="list-style-type: none">• Off hook the phone;• Dial *90 and then enter the number to forward the call;• Press OK soft key or SEND key.
*91	Cancel Busy Call Forward. To cancel the busy call forward: <ul style="list-style-type: none">• Off hook the phone;• Dial *91;• Hang up the call.
*92	Delayed Call Forward. To set up delayed call forward: <ul style="list-style-type: none">• Off hook the phone;• Dial *92 and then enter the number to forward the call;• Press OK soft key or SEND key.
*93	Cancel Delayed Call Forward. To cancel the delayed call forward: <ul style="list-style-type: none">• Off hook the phone;• Dial *93;• Hang up the call.



RESTORE FACTORY DEFAULT SETTINGS

 **Warning:**

Restoring the Factory Default Settings will delete all configuration information on the phone. Please backup or print all the settings before you restore to the factory default settings. Grandstream is not responsible for restoring lost parameters and cannot connect your device to your VoIP service provider.

Please follow the instructions below to reset the phone:

- Press **MENU** button to bring up the keypad configuration menu;
- Select **Settings** and enter;
- Select **System Settings >Factory Reset**;
- A warning window will pop out to make sure a reset is requested and confirmed;
- Press **Yes** soft key to confirm and the phone will reboot.
To cancel the Reset, press **No** soft key instead.



EXPERIENCING DP750/DP720

Please visit our website: <http://www.grandstream.com> to receive the most up- to-date updates on firmware releases, additional features, FAQs, documentation and news on new products.

We encourage you to browse our [product related documentation](#), [FAQs](#) and [User and Developer Forum](#) for answers to your general questions. If you have purchased our products through a Grandstream Certified Partner or Reseller, please contact them directly for immediate support.

Our technical support staff is trained and ready to answer all of your questions. Contact a technical support member or [submit a trouble ticket online](#) to receive in-depth support.

Thank you again for purchasing the Grandstream DP720 / DP750, it will be sure to bring convenience and color to both your business and personal life.



Compliance

FCC Notice

This device complies with part 15 of the FCC Rules. Operation is subject to the following two conditions: (1) This device may not cause harmful interference, and (2) this device must accept any interference received, including interference that may cause undesired operation.

This equipment has been tested and found to comply with the limits for a Class B digital device, pursuant to part 15 of the FCC Rules. These limits are designed to provide reasonable protection against harmful interference in a residential installation. This equipment generates, uses and can radiate radio frequency energy and, if not installed and used in accordance with the instructions, may cause harmful interference to radio communications. However, there is no guarantee that interference will not occur in a particular installation. If this equipment does cause harmful interference to radio or television reception, which can be determined by turning the equipment off and on, the user is encouraged to try to correct the interference by one or more of the following measures:

- Reorient or relocate the receiving antenna.
- Increase the separation between the equipment and receiver.
- Connect the equipment into an outlet on a circuit different from that to which the receiver is connected.
- Consult the dealer or an experienced radio/TV technician for help.

Any changes or modifications not expressly approved by the party responsible for compliance could void the user's authority to operate the equipment.

To ensure safety of users, the FCC has established criteria for the amount of radio frequency energy that can be safely absorbed by a user or bystander according to the intended usage of the product. This product has been tested and found to comply with the FCC criteria. Both the Handset may be safely held against the ear of the user. The telephone base shall be installed and used such that parts of the user's body other than the hands are maintained at a distance of approximately 20 cm (8 inches) or more.

Hearing Aid Compatibility (HAC)

This telephone system meets FCC standards for Hearing Aid Compatibility.

FCC RF Radiation Exposure Statement

This equipment complies with FCC RF radiation exposure limits set forth for an uncontrolled environment. For base unit it should be installed and operated with a minimum distance of 20 centimeters between the radiator and your body..

