

AV Center

Operating Instructions

EN

2 DIN 6.5" TFT Monitor
MP3/MP4 Player
AM/FM Radio
Support Bluetooth
Support iPod/iPhone
Support CarPlay

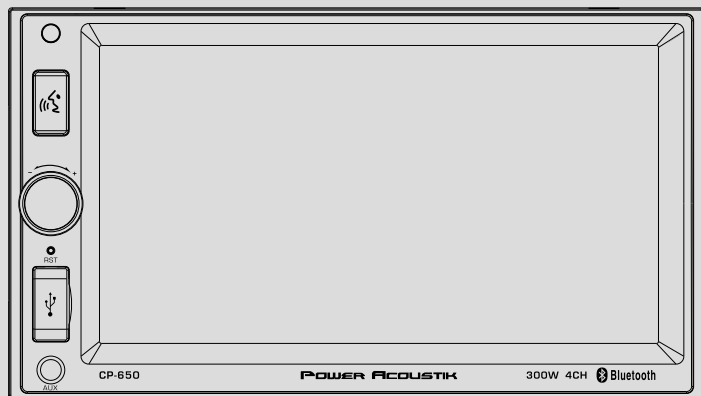

300W 4CH



Made for

iPod iPhone



Works with
Apple CarPlay

WARNING!

Any Changes or modifications not expressly approved by the party responsible for compliance could void the user's authority to operate the equipment.

Note: This equipment has been tested and found to comply with the limits for a Class B digital device, pursuant to part 15 of the FCC Rules. These limits are designed to provide reasonable protection against harmful interference in a residential installation. This equipment generates uses and can radiate radio frequency energy and, if not installed and used in accordance with the instructions, may cause harmful interference to radio communications. However, there is no guarantee that interference will not occur in a particular installation. If this equipment does cause harmful interference to radio or television reception, which can be determined by turning the equipment off and on, the user is encouraged to try to correct the interference by one or more of the following measures:

- Reorient or relocate the receiving antenna.
- Increase the separation between the equipment and receiver.
- Connect the equipment into an outlet on a circuit different from that to which the receiver is connected.
- Consult the dealer or an experienced radio/TV technician for help.

This equipment complies with FCC radiation exposure limits set forth for an uncontrolled environment. This equipment should be installed and operated with minimum distance 20cm between the radiator & your body.

WARNING!

To promote safety, certain functions are disabled unless the parking brake is on. The Unit is designed to detect parked status and must be connected to the power supply side of the parking brake switch. Improper connection or use of this connection may violate applicable law and may result in serious injury or damage. To avoid the risk of damage and injury and the potential violation of applicable laws, this unit is not for use with a video screen that is visible to the driver.

- To avoid the risk of accident and the potential violation of applicable laws, the front Video image feature should never be used while the vehicle is being driven. Also, other video displays should not be in a location where it is a visible distraction to the driver. In some countries or states the viewing of images on a display inside a vehicle even by persons other than the driver may be illegal. Where such regulations apply, they must be obeyed and this unit's DVD features should not be used.
- Please remember to wear your seat belt at all times while operating your vehicle. If you are ever in an accident, your injuries can be considerably more severe if your seat belt is not properly buckled.
- The supplier waves any and all liability when these warnings are not followed.

OPERATION PRECAUTIONS

- Only connect to a 12V DC battery and negative grounding.
- Avoid placing the product in direct sunlight, in areas with high levels of dust, high temperatures (over 40°C) or high humidity (over 90%). In case of high temperatures, cool down the car interior by means of ventilation or air-conditioning.
- Operate in well ventilated areas.
- Do not turn on or off the product in short intervals. When turning the unit off, wait for at least 10 seconds prior to turning the unit on again. Do not operate the player with scratched, bended or broken discs and when a disc is not loaded properly, do not force it into the player.
- Do not watch video playback while driving which will cause serious danger and risks of traffic accident. It may violate the laws and regulations.

(There may be exceptional case, i.e., using rear view camera and navigation system)







- Do not install the unit where the operation for safety driving is restrained.
- Do not disassemble the unit by yourself, if need repairing, please take the unit to the after service center.
- Do not open and close the monitor manually, it may damage the monitor tilt system.
- Do not touch the LCD screen by hard objects, it may damage or give scratch to the LCD screen.
- If the back of monitor touches dashboard or air-conditioner inlet etc after open the monitor , then setup TILT level in monitor TILT menu to prevent damage from repeat touching.
- Car parking under direct sunlight may increase the temperature inside the car and the unit may not be in proper operation, please try it again after the temperature returns to normal.
- Do not replace the fuse on the power cable without professional guidance, using improper fuse may cause damage to the unit or even cause burn the unit.
- Do not use irregular shaped Disk.
- IR remote control operation may be hindered by monitor when the monitor is opened, thus please use the remote control at the similar level of remote control receiver.
- Do not install the unit where the cooling fan is blocked.

Content

WARNING!	3
OPERATION PRECAUTIONS	3
CONTENTS	4
ACCESSORIES	5
INSTALLATION / UN-INSTALLATION	6
WIRING CONNECTIONS	6
PANEL	8
REMOTE CONTROL	8
REMOVE BATTERY	9
ICON operation	10
•RADIO PLAYER	10
•BT Phone	10
•BT Music	11
•Music/Video	12
•USB	13
•Music/Video	13
•iPod	13
•Setting	13
Display Setting	13
Sound Setting	13
System Information	14
Wallpaper	14
•Time	14
•DIMMER	14
•AUX	14
CarPlay Description	15
Connection	17
Other function	18
TROUBLESHOOTING	19
TROUBLESHOOTING	20
TECHNICAL SPECIFICATIONS	21
Video File Conversion 101	22

ACCESSORIES

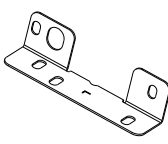
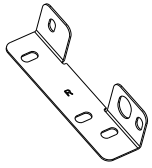
Package contains the following accessories for installation and operation of the unit.

(1) Washer, Spring Washer, M5 Nut	1 each	
(2) Mounting Strap	1	
(3) Bolt	1	
(4) Screw M5x6	8	
(5) Bracket (Left/Right)	2	<div style="display: flex; justify-content: space-around;"> <div style="text-align: center;">  Left </div> <div style="text-align: center;">  Right </div> </div>
(7) Screw	1	
(8) Rubber Cushion	1	



Remote Control

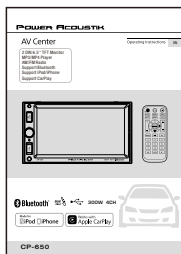

User Manual

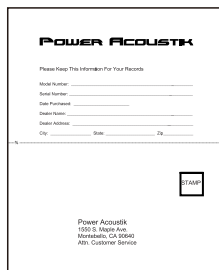

Warranty card

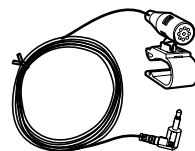

Microphone



Power Cable



Speaker Cable

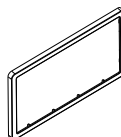

Trim ring

Note:Product image may vary from the actual delivery.

INSTALLATION / UN-INSTALLATION

Note

Before starting installation of the unit, make sure the wiring is connected properly.

Use only the parts provided with the unit to ensure proper installation.

The use of unauthorized parts may cause malfunction.

Install the unit where it does not get in the driver's way and will not injure the passenger in case there is a sudden stop, like an emergency stop.

INSTALLATION

- Put the 2 brackets to the left and right side of the unit.
- Use screws to fix the brackets to the unit.

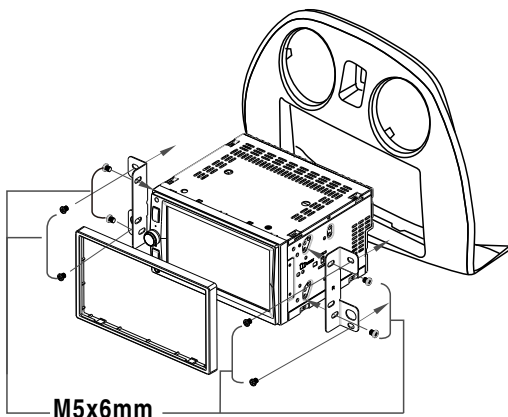

Mounting Strap

A mounting strap is often included with new stereos. For most installations, it is not necessary part of the installation process. However, it can be useful to help support the stereo in yr dash; it also helps reduce vibration. One end of mounting strap attaches (with a screw) to the rear of the stereo. The other end attaches to an existing bolt or screw behind the dash. Just bend the shape as necessary to enable mounting.

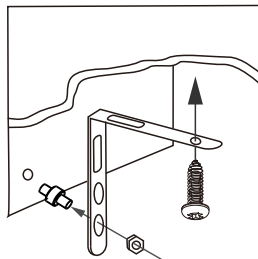

WIRING CONNECTIONS

Make sure you have good chassis ground. A good ground connection will eliminate most electrical noise problems. A good chassis ground requires a tight connection to the vehicle's metal chassis. The area around the ground connection should be clean, bare metal without rust, paint, plastic, dust, or dirt for a good electrical connection.

Caution: Do not interchange the connection of the wiring!!!

For some car models you may need to modify wiring of the supplied power cord. Contact your authorized car dealer before installing this unit.

Using the power connector

Cut the connector; connect the colored leads of the power cord to the car battery as shown in the color code table below for speaker and power cable connections.

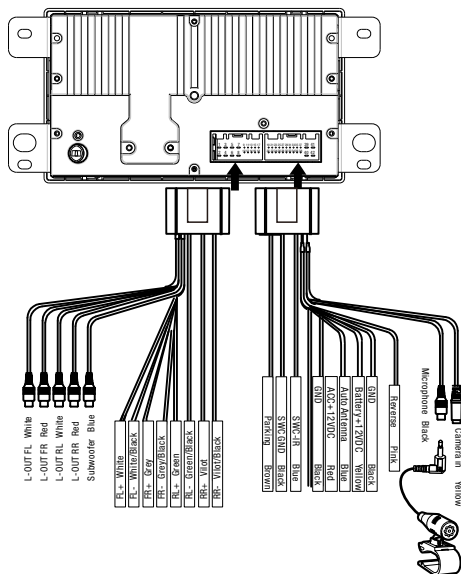

WIRING CONNECTIONS

NOTE: Never connect cable to the system while it is connected to the battery power. Whenever the unit is disconnected from the battery, the preset memory will be erased and the unit will go back to its factory defaults.

When the brown cable for steering wheel control connected to the steering wheel, we can use the steering wheel to control some unit.

ASWC Connections

To use an external universal SWC module, connect only IR (Green) to the output of the module.

Note: To watch video the parking wire should be connected to break signal. 2 cables are connected to a Hands-Free device (not included).

Parking wire

Note: The parking wire is connected with brake signal; for safety, the programs can be seen on the monitor after braking the car..

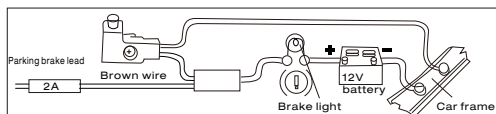

Connecting the reversing line to taillight on the car

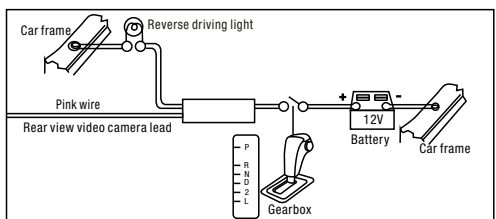

After connecting, when you start up the reverse gear, the unit will receive the picture from car rear view camera.

Note:

- Only use groundless loudspeakers.
- Use only loudspeakers of minimum 40Watt, using fewer watts may result in damaging your loudspeakers at higher volumes.
- Use 4~8 Ω (Ohm impedance) loudspeakers only; using higher or lesser impedance may damage the unit.
- Do not use 3-cable loudspeakers and do not connect the loudspeakers minus to the car body

(GND). The unit is using a BTL circuit and each loudspeaker must be connected with insulated cables according the diagram.

- Loudspeaker cables and/or optional external power amplifiers must always be about 30cm away from the antenna and/or antenna extension parts.

Connect the speakers according the following diagram, incorrect connections will damage the unit or your loudspeakers

Speaker Connection

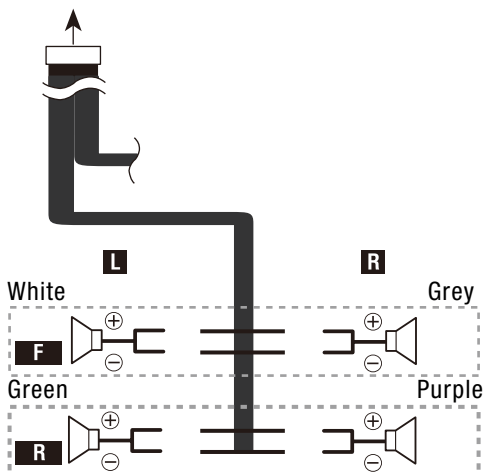

FRONT PANEL

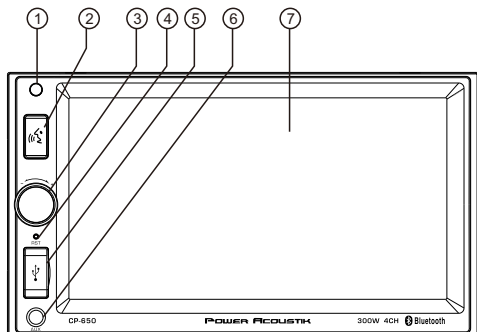

- ① **IR Sensor**
IR Remote control signal receiving window. Max distance is 6-8 meters, 45 angels.

- ② **Siri Button**
In CarPlay mode, touch the SIRI button to start the Apple SIRI function

- ③ **Volume button**
Press it to turn on the unit. Press and hold for 2 seconds to turn the unit off .Press the button briefly to Mute .Please note that the volume will be muted on all audio output connector.

- ④ **Reset Button**
To reset the Head unit for any reason, use a ball pen or pin to press the RESET button..

- ⑤ **USB Cover**
USB slot, for Multimedia playback files only. Insert a USB into this slot and the unit will automatically start reading and playback the card. * Supported Music File Format: MP3, WMA Files.

- ⑥ **AUX IN**
Put the AUX plug into the AUX-IN jack which was marked on front panel.

- ⑦ **Front panel**
6.5 inch TFT

REMOTE CONTROL

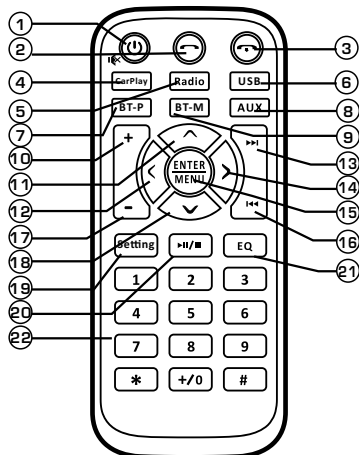

- ① **POWER / MUTE**
Press and hold to power it on or off. Short press this button to mute the volume output, press it again to resume volume.

- ② **DIAL/ ANSWER button (Only for Bluetooth)**
Press to make a call after inputted a phone number or answer an incoming call.

- ③ **REJECT / HANG UP button (Only for Bluetooth)**
Press to reject a coming call or hang up while calling.

- ④ **CarPlay button**
Press it to CarPlay mode.

REMOTE CONTROL

- ⑤ **RADIO button**
Press it to Radio mode.
-
- ⑥ **USB**
Press it to USB mode.
-
- ⑦ **BLUETOOTH Phone button**
Press it to Bluetooth Phone mode.
-
- ⑧ **AUX/AV IN button**
Press it to AUX IN or AV IN mode.
-
- ⑨ **BLUETOOTH Muisic button**
Press it to Bluetooth Music mode.
-
- ⑩ **VOL+ button**
Press to increase volume level.
-
- Cursor ^ buttons**
⑪ Use the ^ buttons to select the menu item, the title track or to show next frame.
-
- Cursor < buttons**
⑫ Use the < buttons to select the menu item, The title tracks it or to show next frame.
-
- ▶▶ / button**
⑬ In DVD mode, Press ▶▶ button to skip to the next track
- In RADIO mode, press ▶▶ to start manual searching button Frequency up.
-
- Cursor > buttons**
⑭ Use the > buttons to select the menu item, the title tracks it or to show next frame.
-
- MENU/ENTER button**
⑮ Press it to confirm selection, Press and hold show main menu..
-
- ◀◀ / button**
⑯ In DVD mode, Press button to skip to the previous track.
- In RADIO mode, press and hold ◀◀ to start manual searching button Frequency down.
-
- VOL- button**
⑰ Press to decrease volume level.

-
- Cursor v buttons**
⑱ Use the v buttons to select the menu item. The title tracks it or to show next frame.
-
- EJECT button**
⑲ Press it to eject the disc.
-
- PLAY/PAUSE/STOP button**
⑳ In DVD mode, press it to stop playback, press again to resume
-
- EQ Button**
㉑ Press it can choose User =>Flat =>Classic =>Pop =>Rock.
-
- Digit 0-9 * # buttons**
㉒ In radio mode, select 1-6 the desired band; In DVD mode, select track.In Bluetooth mode, 0-9 * # enter the phone number or input password.
-

REMOVE BATTERY

Note:

- The distance may vary according to the brightness of ambient light.
- If the remote is not used for an extended period of time, remove the battery to prevent possible damage from battery leakage and corrosion.
- Do not place any objects between the remote control unit and the sensor on the unit.
- Do not drop the remote control onto the floor; it will damage it beyond repair.
- Do not use the remote control unit, while simultaneously operating the remote control unit of any other equipment; they may interfere resulting in improper operation.
- Dispose empty batteries in accordance with your local governmental regulations.
- Do not short-circuit, disassemble, heat or dispose of fire or flames the battery.
- Keep the battery out of reach of children, should the battery be swallowed, immediately consult a doctor.

ICON Operation

CP-650 is a Two Din Car Audio with the following functions:

Apple CarPlay, Radio, Bluetooth Audio, Bluetooth Phone, USB, iPod, Aux, AV IN

The MODE icon in grey mean the corresponding function is not ready or proper device have not been connected.

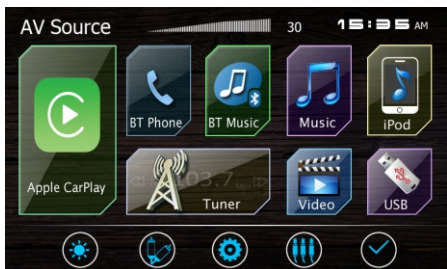

▶▶ Touch this button to select station forward manually

◀◀ Touch this button to search backward stations

▶▶ Touch this button to search forward stations

☐☐☐☐ Touch this button to frequency number.

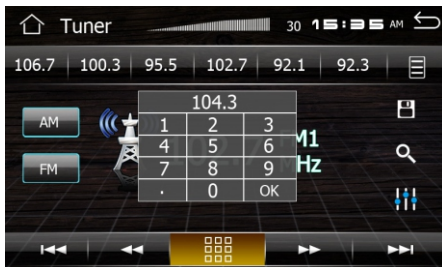

RADIO PLAYER

To start Radio, tap RADIO button on main menu screen.

☰ Touch this button to access to Radio List page as below:





 Return button

 Touch this button can choose FM1=>FM2=>FM3.

 Touch this button can choose AM1=>AM2.

 Touch this button can scan the stations from 1-6, touch and hold it to save the stations with good reception automatically and scan each station for about 5 seconds.

 Touch this button to select program type

 Touch this button to select station backward manually

BT Phone

To start BT Phone, tap BT Phone icon from main menu screen.









ICON Operation

Warning: Driving and having a Telephone conversation at the same time is dangerous, please park your car before having a telephone conversation. The supplier waves any and all liability when this warning is not followed.

To enter Bluetooth mode, you can tap Bluetooth icon on Main menu or long press the BT Phone button on the Remote Control or press BT Phone button on remote .

A user can make own choice by tap the buttons.

-  Tap Dial button to enter call mode.
-  Tap History button to enter calls history list.
-  Tap option button to enter BT option page.
-  Tap this button Hand up and reject calling.
-  Tap this button Making and accept calling.

In Call mode, the unit can be used as your phone. Making and receiving calls are possible with BLUETOOTH. Simply tap phone number and tap  button to make a call, and tap  button to hang up.

-  Tap this button shortly to delete a wrong digit or delete all the numbers at once.

Redial: Tap this button to redial lasted number.

Transfer: Tap this icon translate Bluetooth to mobile mode.

-  Tap this button to dis-connect the mobile phone.

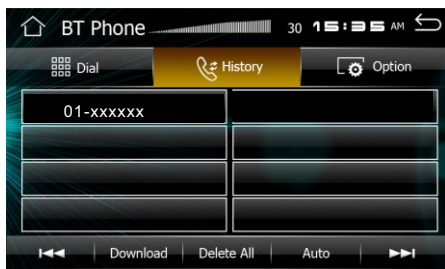

-  Touch it to skip to the previous page.

Download: Touch it to download call history list.

Delete All: Touch it to delete all calls history list.

Auto: Touch it to change Auto or Manual download the calls history list.

-  Touch it to skip to the next page.



You can **Disconnected** mobile or **Choose Pairing** code manually.

BT Music

To start BT Music, tap BT Musci icon from main menu screen.

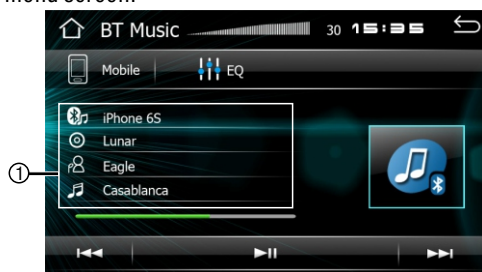

- ① Id3 information display.

Touch this button to adjust the EQ, it can choose USER → JAZZ → CLASSIC → POP → ROCK → BEAT → FLAT

You can select the function with the key for previous, play or pause, stop and next.

A2DP (Advanced Audio Distribution Profile) Music Player

A2DP is a function which can receive the audio frequency signal from the mobile phone, amplified by the car audio and played out by the car speakers.

ICON Operation

Music

To start Music, tap Music icon from main menu screen.

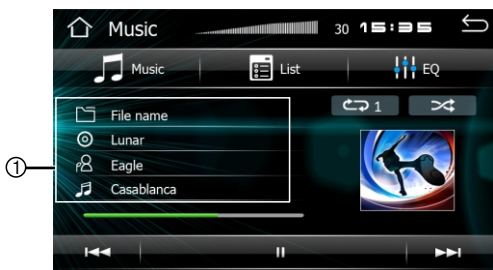

Touch it to return to TITLE MENU (you can choose music to play)

Touch it to select Repeat Off → Repeat 1 → Repeat Folder.

Touch it switch Random on or off

Id3 information display.

Touch it to select previous or next track

Touch it to select Play or Pause

Music File List

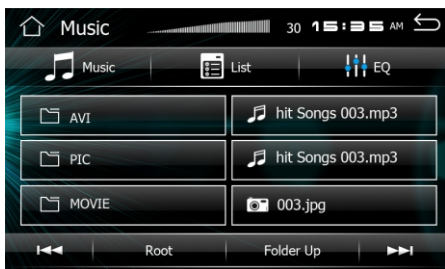

Touch it to select previous or next list page

Root: Touch it to back to Root file name display

Folder Up: Touch it to back to Previous Directory one by one.

Video

To start Video, tap Video icon from main menu screen.

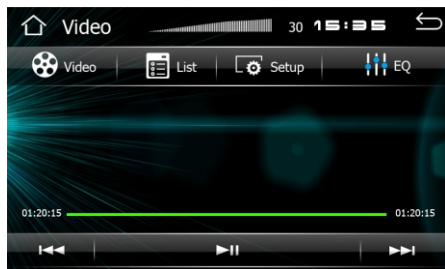

Touch it to return to TITLE MENU (you can choose video to play)

Touch it to access to Video setting menu.

Touch it to select previous or next track

Touch it to select Play or Pause

Video File List



Touch it to select previous or next list page

Root: Touch it to back to Root file name display

Folder Up: Touch it to back to Previous Directory one by one.

Video Setting Menu



Voice: Touch it to choose voice language.

Caption: Touch it to choose caption on/off.

Caption size: Touch it to choose caption size: Small > Middle > Big.

ICON Operation



USB

To start Music, tap USB icon from main menu screen.

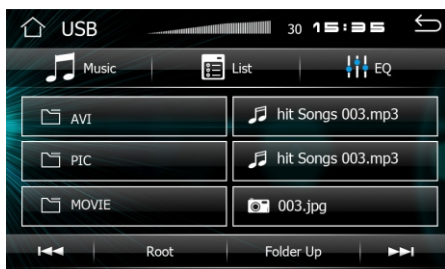

Touch it to select previous or next list page

Root: Touch it to back to Root file name display

Folder Up: Touch it to back to Previous Directory one by one.



iPod

To start iPod, tap iPod icon from main menu screen.

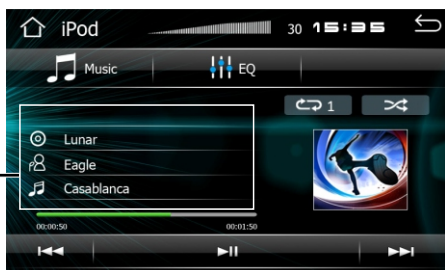

Touch it to select Repeat Off → Repeat 1 → Repeat Folder.

Touch it switch Random on or off

Id3 information display.

Touch it to select previous or next track

Touch it to select Play or Pause



Setting

To start Setting, tap Setting icon from main menu screen.



Display Setting

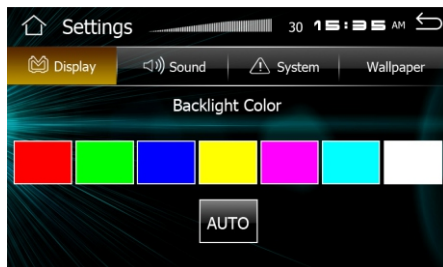

You can change LED Backlight Color manually: Red > Green > Blue > Yellow > Purple > Ice Blue > White.

AUTO: LED Backlight Color auto change about terminal 2 seconds.



Sound Setting

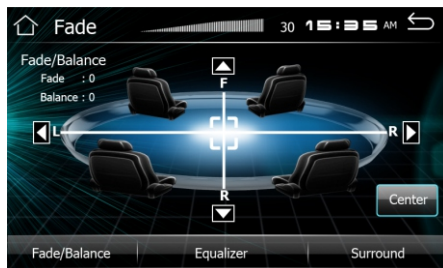

■ Fader / Balance

Adjust the volume balance around the touched area.

◀ and ▶ adjust the right and left volume balance.

▼ and ▲ adjust the front and rear volume balance.

■ Center

Clear the adjustment.

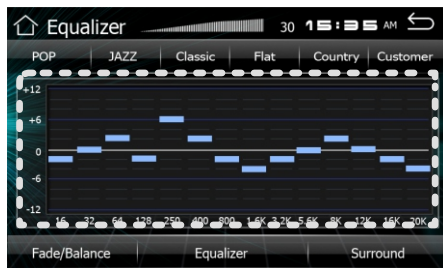

You can adjust equalizer by selecting the optimized setting for each category.

ICON Operation

Touch the screen and set the Graphic Equalizer as desired.

■ Gain level (Dot frame area)/Customer

Adjust the gain level by touching the each frequency bar.

You can select frequency bar and adjust its Level by touch blue rectangle.

Touch the screen to choose preset EQ curve: POP > JAZZ > Classic > Flat > Country

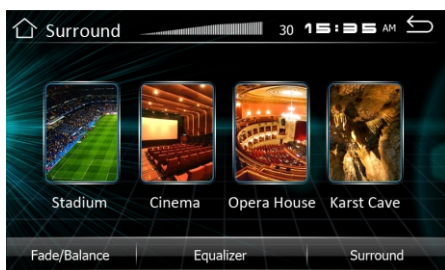

Touch the screen and set the Graphic Surround : Stadium > Cinema > Opera House > Karst Cave.

! System Information

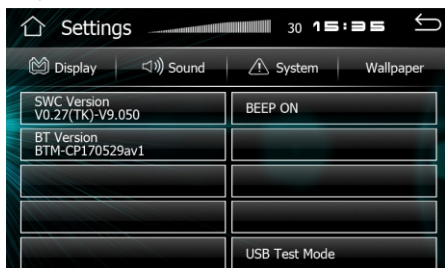

Display SWC Version and BT Version

BEEP: Touch it to set BEEP ON or OFF.

USB Test Mode: Touch it to set USB Test Mode.

Wallpaper

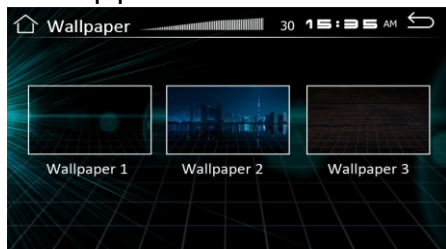

✓ Time

To start Time setting, tap Time icon from main menu screen.

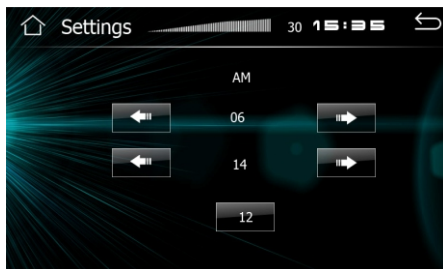

Touch the screen to adjust hour and Minute.

Touch the screen to choose 12 or 24 format.

▶ Apple CarPlay

To start Apple CarPlay, tap CarPlay icon from main menu screen.

☀ Dimmer

Touch it to set TFT backlight: Normal > Dark > Close.

🔋 Aux

Touch it to access in Aux mode:

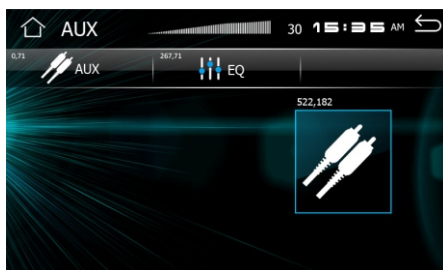

CarPlay Description

Apple CarPlay Operation

CarPlay is a smarter, safer way to use your iPhone in the car. CarPlay takes the things you want to do with iPhone while driving and displays them on the screen of the product.

You can get directions, make calls, send and receive messages, and listen to the music from iPhone while driving. You can also use Siri voice control to make it easier to operate iPhone.

For details about CarPlay, visit

<https://ssl.apple.com/ios/carplay/>.

Compatible iPhone devices

You can use CarPlay with the following iPhone models:

- iPhone 7 Plus
- iPhone 7
- iPhone 6s Plus
- iPhone 6s
- iPhone 6 Plus
- iPhone 6
- iPhone 5s
- iPhone 5c
- iPhone 5

NOTE:

- By connecting your iPod /iPhone to this unit with an optional accessory connection cable, you can supply power to your iPod/iPhone as well as charge it while playing music. However, the power of this unit must be on.
- If you start playback after connecting the iPod, the music that has been played by the iPod is played first.

iPhone connection

Connect iPhone using USB cable via USB terminal:

When iPhone compatible with CarPlay is connected to the USB (Black) terminal, the Bluetooth smartphone currently connected is disconnected.

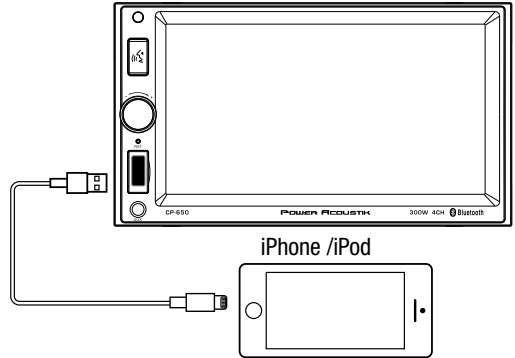

Operation buttons and available Apps on the home screen for CarPlay

You can use the Apps of the connected iPhone.

The items displayed and the language used on the screen differ among the connected devices.

To enter CarPlay mode, touch Apple CarPlay icon in the main menu screen.

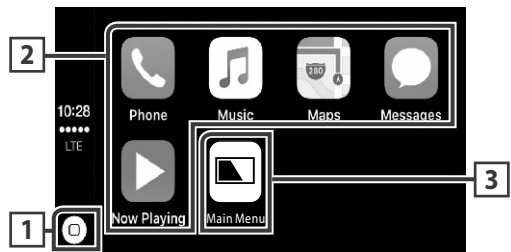

1 [Main Menu]

- Displays the home screen of CarPlay.
- Touch and hold to activates Siri.

2 Application buttons

Starts the application.

3 [Main Menu]

Exits the CarPlay screen and displays the Home

CarPlay Description iPod/iPhone

USE SIRI

You can active Siri.

1 Press Siri button or touch  button for 2 second or the HOME button of iPhone .

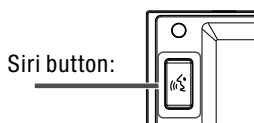

2 Talk to siri.

Press siri button again to deactivate.

Note: For the Siri function in the headunit, the Microphone has been to connected.

iPod/iPhone

Connectable iPod/iPhone

The following models can be connected to this unit.

Made for

- iPhone 7 Plus
- iPhone 7
- iPhone 6s Plus
- iPhone 6s
- iPhone 6 Plus
- iPhone 6
- iPhone 5s
- iPhone 5c
- iPhone 5
- iPod touch (6th generation)
- iPod touch (5th generation)

Preparation

Wired connection

- Connect an iPod/iPhone with the USB Cable while CarPlay is not connected.
- With a CarPlay-capable iPhone, turn off CarPlay by operating the iPhone at functional setup before connecting iPhone.
- Only one iPod/iPhone can be connected.

Microphone installation

- 1 Check the installation position of the microphone .
- 2 Clean the installation surface.
- 3 Remove the separator of the microphone, and stick the microphone to the place shown below.
- 4 Wire the microphone cable up to the unit with it secured at several positions using tape or other desired method.
- 5 Adjust the direction of the microphone to the driver.

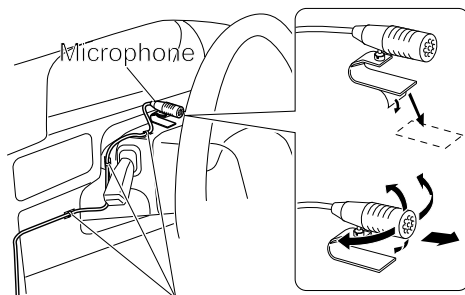

Fix a cable with a commercial item of tape.

Connection

Speaker impedance: 4-8 Ω

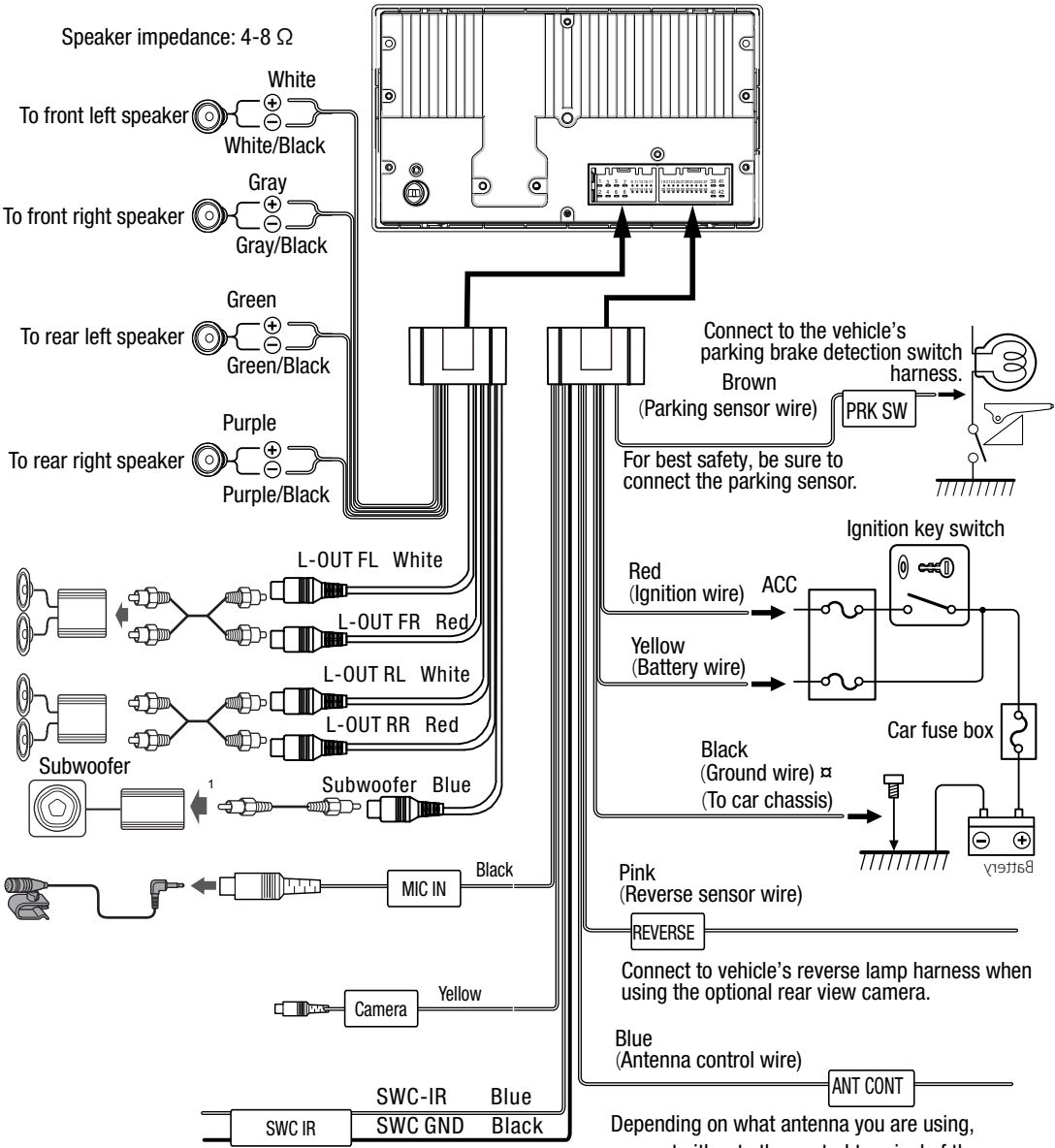

To steering remote
 To use the steering wheel remote control feature, you need an exclusive remote adapter (not supplied) matched to your car.

Connect to the vehicle's parking brake detection switch harness.
 Brown (Parking sensor wire) PRK SW
 For best safety, be sure to connect the parking sensor.

Ignition key switch
 Red (Ignition wire) ACC
 Yellow (Battery wire)
 Black (Ground wire) (To car chassis)
 Car fuse box
 Battery

Pink (Reverse sensor wire) REVERSE
 Connect to vehicle's reverse lamp harness when using the optional rear view camera.

Blue (Antenna control wire) ANT CONT

Depending on what antenna you are using, connect either to the control terminal of the motor antenna, or to the power terminal for the booster amplifier of the film-type antenna. (Max. 300mA, 12V)

OTHER FUNCTIONS

Subwoofer

Connect the subwoofer to the unit using sub output (see electrical diagram). Tap MENU on screen enter into main menu setting choose setting menu. Choose SOUND and set subwoofer ON to enable subwoofer.

Parking

When the car is stopped and the parking brake is working, the screen can display the video image, otherwise the screen can't display the video image

Rear View Camera

This unit is equipped with rear view camera output. The camera is used to observe the situation behind the vehicle when you are backing the car.

Please connect your rear view camera with the rear view camera input. And connect the reverse wire for back a car with the rear gear light. Rear view camera picture will be enabled when you are backing the car.

TROUBLESHOOTING

	Symptom	Cause	Remedy
General	General Power does not turn on. (No sound is produced.)	Fuse is blown	Replace with fuse of the same amperage. If the fuse blows again, consult your store of purchase
		In correct wiring	Consult your local retailer.
	No sound output when operating the unit with amplifiers or power antenna attached.	Power antennal lead is shorted to ground excessive current is required or remote on the amplifiers or power antenna.	<ol style="list-style-type: none"> 1. Turn off the unit. 2. Remove all wires attached to the power antenna lead. Check each wire for a possible short to ground using an ohm meter. 3. Turn on the unit. 4. Reconnect each amplifier remote wire to the power antenna lead one by one. If the amplifiers turn off before all wires are attached, use an external replay to provide remote-on voltage (excessive current required).
	Nothing happens when buttons are pressed. Display is not Accurate.	The microprocessor has malfunctioned due to noise, etc.	Turn off the power, Then press the [no open] button and remove the DCP. Press the reset button for about 2 seconds with a thin rod.
		Panel or main unit Connectors are dirty	Wipe the dirt off with a soft cloth moistened with cleaning alcohol.

TROUBLE SHOOTING

Symptom	Cause	Remedy
NO POWER	THE CAR IGNITION IS NOT ON.	IF THE POWER SUPPLY IS PROPERLY CONNECTED TO THE CAR ACCESSORY SWITCH THE IGNITION KEY TO "ACC".
	THE FUSE IS BLOWN.	REPLACE THE FUSE.
DISC CANNOT BE LOADED.	PRESENCE OF DISC INSIDE THE PLAYER	REMOVE THE DISC IN THE PLAYER THEN PUT A NEW UPWARD.
DISC CANNOT BE READ.	INSERTING THE DISC IN UPSIDE DOWN.	INSERT THE COMPACT DISC WITH THE LABEL FACING UPWARD.
	COMPACT DISC IS EXTREMELY DIRTY OR DEFECTIVE.	CLEAN THE DISC OR TRY TO PLAY A NEW ONE.
	TEMPERATURE INSIDE THE CAR IS TOO HIGH.	COOL OFF UNTIL THE AMBIENT TEMPERATURE RETURNS TO NORMAL.
NO SOUND	VOLUME IS IN MINIMUM	ADJUST VOLUME TO A DESIRED LEVEL.
	WIRING IS NOT PROPERLY CONNECTED.	CHECK WIRING CONNECTION.
THE OPERATION KEYS DO NOT WORK.	THE BUILT-IN MICROCOMPUTER IS NOT FRONT PANEL IS NOT PROPERLY FIX INTO ITS PLACE.	PRESS THE POWER BUTTON FOR ABOUT 10 SECONDS TO RESET THE UNIT.
SOUND SKIPS.	THE INSTALLATION ANGLE IS MORE THAN 30 DEGREES. NOT OPERATING PROPERLY DUE TO NOISE.	ADJUST THE INSTALLATION ANGLE TO LESS THAN 30 DEGREES.
	THE DISC IS EXTREMELY DIRTY OR DEFECTIVE.	CLEAN THE COMPACT DISC/TRY TO PLAY A NEW ONE.
THE RADIO DOES NOT WORK, THE RADIO STATION AUTOMATIC SELECTION DOES NOT WORK.	THE ANTENNA CABLE IS NOT CONNECTED THE SIGNALS ARE TOO WEAK.	INSERT THE ANTENNA CABLE FIRMLY SELECT A STATION MANUALLY.

TECHNICAL SPECIFICATIONS

General

Power supply:	11~16V DC
Current consumption:	max. 10 A
Maximum power output:	4 x 50W channels (max)
Compatible formats:	DVD/VCD//MP3/MP4/VIDEO/CDDA/PICTURE CDCD-R/-RW/DVD±R/±RW PLAYBACK
Dimensions (W x D x H) / weight:	178*170*100 mm/1.5 kg
Working temperature range:	Working temperature range:
ESP function:	10 sec. for Audio CD, 120 sec. for MP3

TFT display

Screen size:	6.5 inch
Resolution:	800*480 pixel
Aspect ratio:	4:3/16:9
Brightness:	460 cd/m ²
Contrast ratio:	500:1

FM Stereo Radio

Frequency range(Europe Area):	87.5 – 108MHz(Step 50KHz)
Frequency range(U.S.A Area):	87.5 – 107.9MHz(Step 200KHz)
Frequency range(South America Area):	87.5 – 107.9MHz(Step 100KHz)
Frequency range(Russian Area):	87.5 – 108MHz(Step 50KHz) 65-74MHz(Step 30KHz)
Frequency range(Asia Area):	87.5 – 108MHz(Step 100KHz)
Preset memory stations:	18

AM/MW Radio

Frequency range(Europe Area):	522kHz - 1620 KHz(Step 9KHz)
Frequency range(U.S.A Area):	530kHz - 1710 KHz(Step 10KHz)
Frequency range(South America Area):	530kHz - 1710 KHz(Step 10KHz)
Frequency range(Russian Area):	522kHz - 1620 KHz(Step 9KHz)
Frequency range(Asia Area):	531kHz - 1602 KHz(Step 10KHz)
Preset memory stations:	12

Audio specification

Frequency response:	20 Hz-20 KHz
USB interface	
USB type	USB 2.0 full speed
Support format	mp3 , wma, mpeg1 , mpeg2, avi

Specifications are subject to change without notice. Mass and dimension are approximate.

Video File Conversion 101

File compression seems to be name of the game to see who can fit the most music and video onto today media deices. Unfortunately with so many compression formats and codecs, it becomes virtually impossibly for your head unit to support the multitude of song and video file types. To overcome the confusion of what video formats are compatible with this head unit, we suggest using a file converter to align the stars and change the many video file types you have to one standard.

Surely there are many file conversion apps available on the line, but CNet seems to be a reliable source and has a good file conversion app available. Check out:

<http://download.cnet.com/Free-AVI-Video-Converter/3000-2194-4-75685273.html>

Drop by our website for the link instead of typing a million letters and symbols into your web browser?



After the app downloads and installs, it's pretty simple to convert your files. Select the Add File button and browse your computer to find the alien file type you need to convert. The file info should appear at the top:

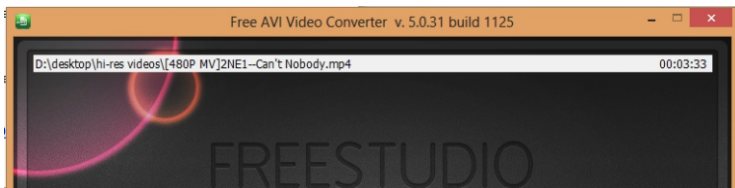

There are some optional choices after the file is selected, like changing the name to protect the innocent, or change the location the converted file is saved. If you feeling frisky go for it:

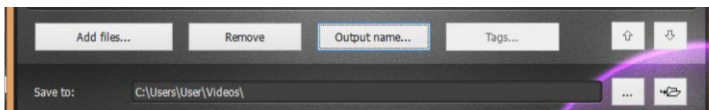

Video File Conversion 101

Otherwise, choose the file format you want to convert your movie to. May we recommend the AVI:

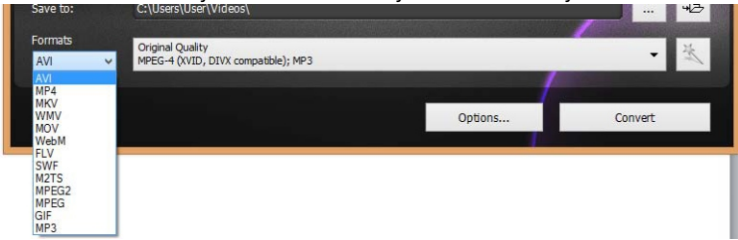

You can also choose the resolution for the screen size and type. If you are converting an original file that is super high quality resolution, you might consider the HD options, but most commonly you should choose Normal Quality or Original Quality.

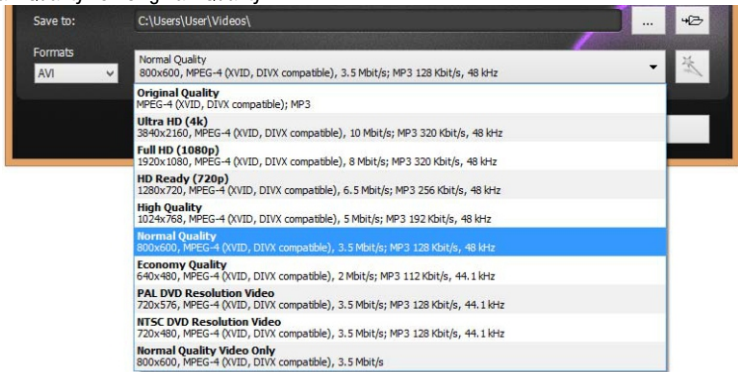

There are some fantastic options to change the standard codec, bit & frame rates, blood types, and so on, but we suggest keeping everything preset as the app recommends. Its these crazy variables that brought you here in the first place.

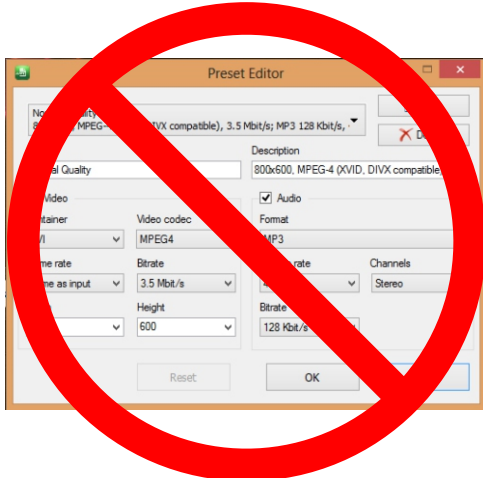

Finally, click convert and wait for the bell:

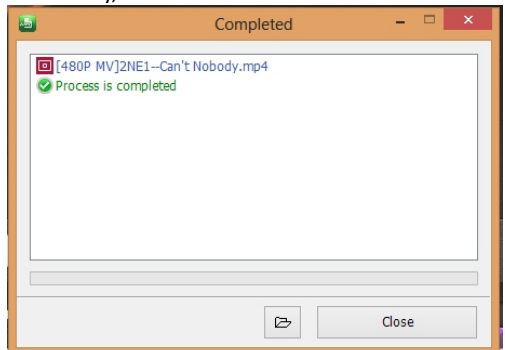

Support site

If you have any questions or for the latest support information on this product, please visit the web site below:

<http://www.poweracoustik.com>

If you have any questions/problems regarding this product, try the following:

- 1 Read Troubleshooting in these Operating Instructions.
- 2 Please contact (U.S.A. only);
URL <http://www.poweracoustik.com>