

TEST REPORT

of

FCC Part 22 Subpart H and Part 24 Subpart E

FCC ID: YZP-VL3010

Equipment Under Test : Telematics Modem
Model Name : LTD-VL3010
Applicant : LG Innotek Co., Ltd.
Manufacturer : LG Innotek Co., Ltd.
Date of Receipt : 2018.12.18
Date of Test(s) : 2018.12.20 ~ 2019.01.31
Date of Issue : 2019.02.12

In the configuration tested, the EUT complied with the standards specified above.

Tested By:

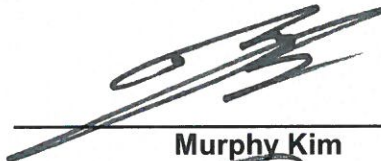

Murphy Kim

Date:

2019.02.12

Technical
Manager:

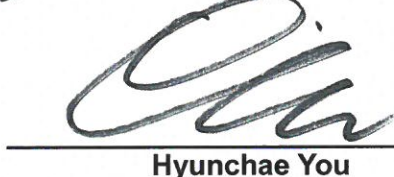

Hyunchoe You

Date:

2019.02.12

The results shown in this test report refer only to the sample(s) tested unless otherwise stated. This test report cannot be reproduced, except in full, without prior written permission of the Company. This test report does not assure KOLAS accreditation.

TABLE OF CONTENTS

	Page
1. General Information -----	3
2. RF Radiated Output Power & Spurious Radiated Emission -----	7
3. Conducted Output Power -----	17
4. Occupied Bandwidth -----	20
5. Peak-Average Ratio -----	30
6. Spurious Emissions at Antenna Terminal -----	40
7. Band Edge -----	51
8. Frequency Stability -----	56

The results shown in this test report refer only to the sample(s) tested unless otherwise stated. This test report cannot be reproduced, except in full, without prior written permission of the Company. This test report does not assure KOLAS accreditation.

1. General information

1.1. Testing laboratory

SGS Korea Co., Ltd. (Gunpo Laboratory)

- Wireless Div. 4, LS-ro 182beon-gil, Gunpo-si, Gyeonggi-do, Korea, 15807

All SGS services are rendered in accordance with the applicable SGS conditions of service available on request and accessible at <http://www.sgs.com/en/Terms-and-Conditions.aspx>.

Telephone : +82 31 688 0901

FAX : +82 31 688 0921

1.2. Details of applicant

Applicant : LG Innotek Co., Ltd.

Address : 26, Hanamsandan 5beon-ro, Gwangsan-gu, Gwangju, 62229, Korea

Contact Person : Jeong, In-Chang

Phone No. : +82 62 950 0332

1.3. Details of manufacturer

Company : Same as applicant

Address : Same as applicant

1.4. Description of EUT

Kind of Product	Telematics Modem
Model Name	LTD-VL3010
Power Supply	DC 4.0 V
Rated Power	CDMA BC0, BC1: 24 dB m LTE Band 2, 4, 5, 13: 23 dB m
Frequency Range	CDMA BC0: 824 MHz ~ 849 MHz CDMA BC1: 1 850 MHz ~ 1 910 MHz LTE Band 2: 1 850 MHz ~ 1 910 MHz LTE Band 4: 1 710 MHz ~ 1 755 MHz LTE Band 5: 824 MHz ~ 849 MHz LTE Band 13: 777 MHz ~ 787 MHz
Emission Designator	CDMA BC0: 1M29F9W CDMA BC1: 1M28F9W LTE Band 2 (1.4 MHz): 1M10G7D (QPSK) / 1M10W7D (16QAM) LTE Band 2 (3 MHz): 2M71G7D (QPSK) / 2M72W7D (16QAM) LTE Band 2 (5 MHz): 4M52G7D (QPSK) / 4M54W7D (16QAM) LTE Band 2 (10 MHz): 8M94G7D (QPSK) / 8M94W7D (16QAM) LTE Band 2 (15 MHz): 13M5G7D (QPSK) / 13M5W7D (16QAM) LTE Band 2 (20 MHz): 17M9G7D (QPSK) / 17M9W7D (16QAM)

The results shown in this test report refer only to the sample(s) tested unless otherwise stated. This test report cannot be reproduced, except in full, without prior written permission of the Company. This test report does not assure KOLAS accreditation.

Emission Designator	<p> LTE Band 4 (1.4 MHz): 1M10G7D (QPSK) / 1M10W7D (16QAM) LTE Band 4 (3 MHz): 2M71G7D (QPSK) / 2M71W7D (16QAM) LTE Band 4 (5 MHz): 4M53G7D (QPSK) / 4M53W7D (16QAM) LTE Band 4 (10 MHz): 8M97G7D (QPSK) / 8M94W7D (16QAM) LTE Band 4 (15 MHz): 13M5G7D (QPSK) / 13M5W7D (16QAM) LTE Band 4 (20 MHz): 17M9G7D (QPSK) / 17M9W7D (16QAM) LTE Band 5 (1.4 MHz): 1M10G7D (QPSK) / 1M10W7D (16QAM) LTE Band 5 (3 MHz): 2M71G7D (QPSK) / 2M71W7D (16QAM) LTE Band 5 (5 MHz): 4M53G7D (QPSK) / 4M53W7D (16QAM) LTE Band 5 (10 MHz): 8M94G7D (QPSK) / 8M94W7D (16QAM) LTE Band 13 (5 MHz): 4M53G7D (QPSK) / 4M53W7D (16QAM) LTE Band 13 (10 MHz): 8M92G7D (QPSK) / 8M94W7D (16QAM) </p>
----------------------------	--

The results shown in this test report refer only to the sample(s) tested unless otherwise stated. This test report cannot be reproduced, except in full, without prior written permission of the Company. This test report does not assure KOLAS accreditation.

1.5. Test equipment list

Equipment	Manufacturer	Model	S/N	Cal. Date	Cal. Interval	Cal. Due
Signal Generator	Agilent	E8257D	MY51501169	Jul. 03, 2018	Annual	Jul. 03, 2019
Spectrum Analyzer	R&S	FSV30	103100	Jun. 21, 2018	Annual	Jun. 21, 2019
Mobile Test Unit	Agilent	E5515C	GB43345198	Mar. 15, 2018	Annual	Mar. 15, 2019
Power Meter	Anritsu	ML2495A	1223004	Jun. 12, 2018	Annual	Jun. 12, 2019
Power Sensor	Anritsu	MA2411B	1207272	Jun. 12, 2018	Annual	Jun. 12, 2019
Directional Coupler	KRYTAR	152613	127445	Jun. 14, 2018	Annual	Jun. 14, 2019
Temperature Chamber	ESPEC CORP.	PL-1J	15000796	Sep. 18, 2018	Annual	Sep. 18, 2019
High Pass Filter	Wainwright Instrument GmbH	WHKX10-900-1000-18000-40SS	7	Mar. 21, 2018	Annual	Mar. 21, 2019
High Pass Filter	Wainwright Instrument GmbH	WHK3.0/18G-10SS	344	May 27, 2018	Annual	May 27, 2019
High Pass Filter	Wainwright Instrument GmbH	WHKX2.2/12.75G-10SS	8	Mar. 21, 2018	Annual	Mar. 21, 2019
High Pass Filter	Wainwright Instrument GmbH	WHKX1.5/15G-6SS	4	Jun. 14, 2018	Annual	Jun. 14, 2019
DC Power Supply	Agilent	U8002A	MY50060028	Mar. 15, 2018	Annual	Mar. 15, 2019
Preamplifier	H.P.	8447F	2944A03909	Aug. 07, 2018	Annual	Aug. 07, 2019
Preamplifier	R&S	SCU 18	10117	Aug. 07, 2018	Annual	Aug. 07, 2019
Preamplifier	MITEQ Inc.	JS44-18004000-35-8P	1546891	May 13, 2018	Annual	May 13, 2019
Test Receiver	R&S	ESU26	100109	Feb. 07, 2018	Annual	Feb. 07, 2019
Loop Antenna	Schwarzbeck Mess-Elektronik	FMZB 1519	1519-039	Aug. 23, 2017	Biennial	Aug. 23, 2019
Bilog Antenna	SCHWARZBECK MESSELEKTRONIK	VULB9163	01126	Mar. 26, 2018	Biennial	Mar. 26, 2020
Horn Antenna	R&S	HF906	100326	Feb. 14, 2018	Biennial	Feb. 14, 2020
Horn Antenna	SCHWARZBECK MESSELEKTRONIK	BBHA9170	BBHA9170223	Sep. 10, 2018	Biennial	Sep. 10, 2020
Antenna Master	Innco systems GmbH	MM4000	N/A	N.C.R.	N/A	N.C.R.
Turn Table	Innco systems GmbH	DS 1200S	N/A	N.C.R.	N/A	N.C.R.
Controller	Innco systems GmbH	CONTROLLER CO3000-4P	CO3000/963/38330516/L	N.C.R.	N/A	N.C.R.
Anechoic Chamber	SY Corporation	L x W x H (9.6 m x 6.4 m x 6.4 m)	N/A	N.C.R.	N/A	N.C.R.
Coaxial Cable	SUCOFLEX	104 (3 m)	MY3258414	Jan. 04, 2019	Semi-annual	Jul. 04, 2019
Coaxial Cable	SUCOFLEX	104 (10 m)	MY3145814	Jan. 04, 2019	Semi-annual	Jul. 04, 2019
Coaxial Cable	Rosenberger	LA1-C006-1500	131014 01/20	Sep. 04, 2018	Semi-annual	Mar. 04, 2019
Coaxial Cable	Rosenberger	LA1-C006-1500	131014 05/20	Sep. 04, 2018	Semi-annual	Mar. 04, 2019
Coaxial Cable	Rosenberger	LA1-C006-1500	131014 10/20	Sep. 04, 2018	Semi-annual	Mar. 04, 2019

The results shown in this test report refer only to the sample(s) tested unless otherwise stated. This test report cannot be reproduced, except in full, without prior written permission of the Company. This test report does not assure KOLAS accreditation.

1.6. Summary of test results

The EUT has been tested according to the following specifications:

APPLIED STANDARD: FCC Part 2, 22 and 24		
Section in FCC part	Test Item	Result
§2.1046 §22.913(a)(5) §24.232(c)	RF Radiated Output Power	Complied
§2.1053 §22.917(a) §24.238(a)	Spurious Radiated Emission	Complied
§2.1046	Conducted Output Power	Complied
§2.1049	Occupied Bandwidth	Complied
§22.913(d) §24.232(d)	Peak-Average Ratio	Complied
§2.1051 §22.917(a) §24.238(a)	Spurious Emission at Antenna Terminal	Complied
§22.917(a) §24.238(a)	Band Edge	Complied
§2.1055 §22.355 §24.235	Frequency Stability	Complied

1.7. Test report revision

Revision	Report number	Date of Issue	Description
0	F690501/RF-RTL013502	2019.02.12	Initial

1.8. Sample calculation for offset

Where relevant, the following sample calculation is provided:

1.8.1. Conducted test

Offset value (dB) = Directional Coupler (dB) + Cable loss (dB)

1.8.2. Radiation test

E.R.P. & E.I.R.P. = [S.G level + Amp.] (dB m) - Cable loss (dB) + Ant. gain (dB d/dB i)

The results shown in this test report refer only to the sample(s) tested unless otherwise stated. This test report cannot be reproduced, except in full, without prior written permission of the Company. This test report does not assure KOLAS accreditation.

2. RF Radiated Output Power & Spurious Radiated Emission

2.1. Test setup

The diagram below shows the test setup that is utilized to make the measurements for emission from 9 kHz to 30 MHz Emissions.

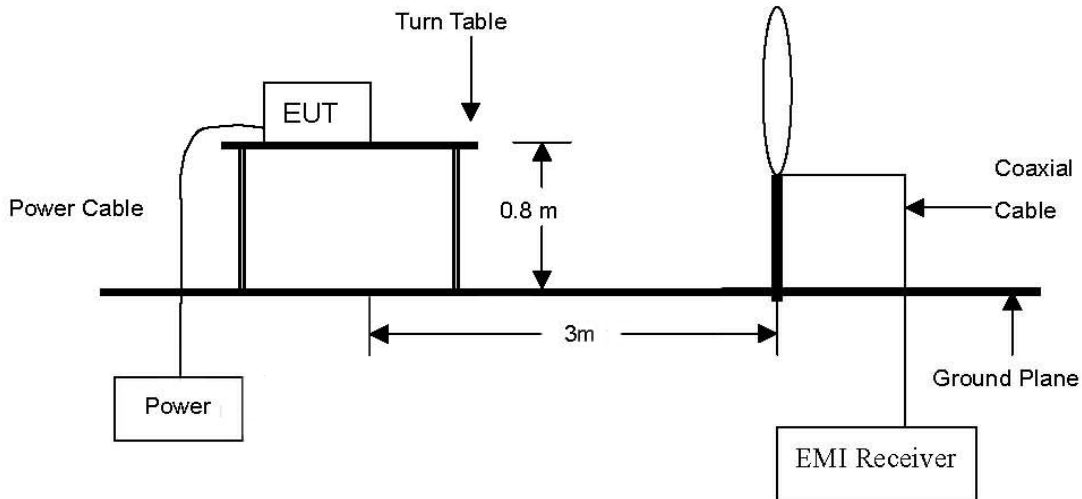

The diagram below shows the test setup that is utilized to make the measurements for emission from 30 MHz to 1 GHz.

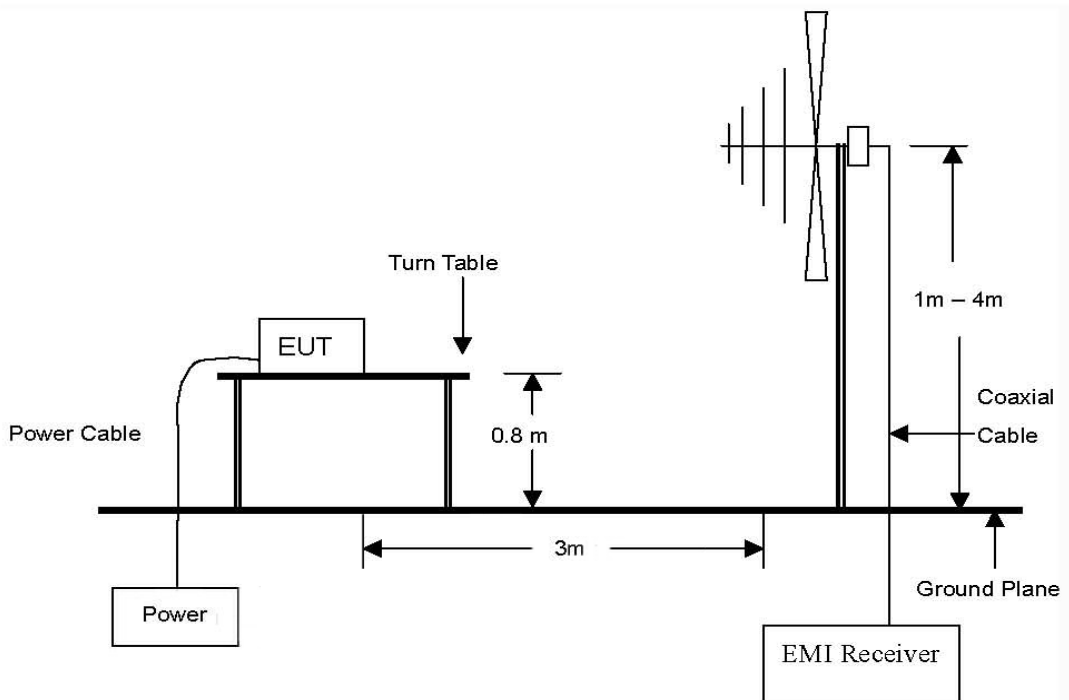

The results shown in this test report refer only to the sample(s) tested unless otherwise stated. This test report cannot be reproduced, except in full, without prior written permission of the Company. This test report does not assure KOLAS accreditation.

The diagram below shows the test setup that is utilized to make the measurements for emission from 1 GHz to 20 GHz.

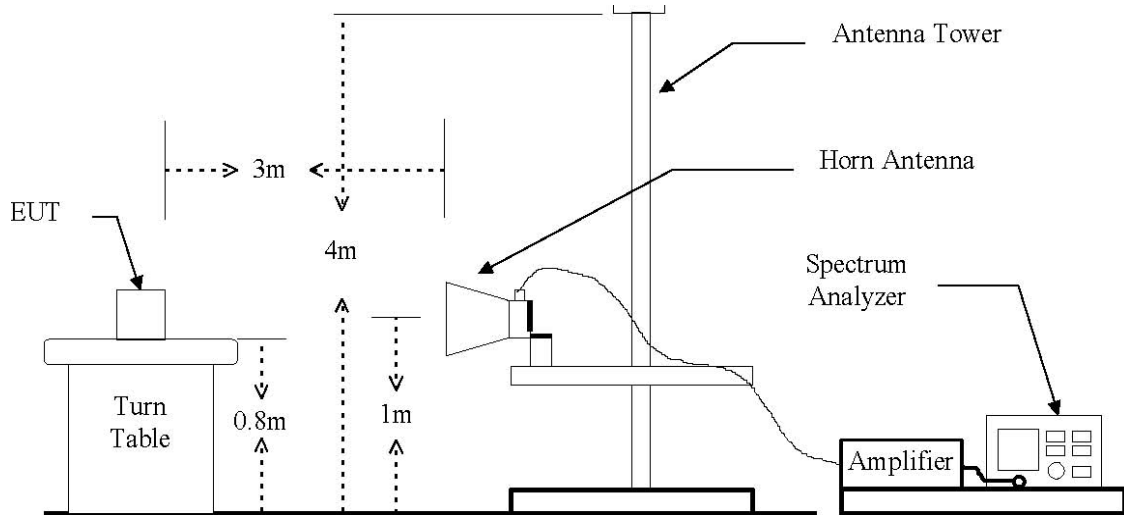

The diagram below shows the test setup for substituted method.

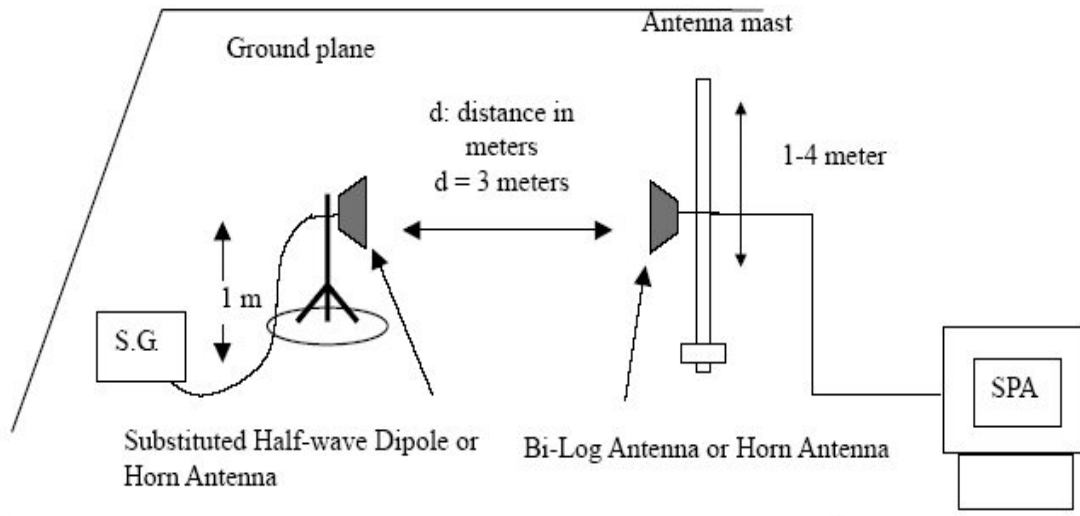

The results shown in this test report refer only to the sample(s) tested unless otherwise stated. This test report cannot be reproduced, except in full, without prior written permission of the Company. This test report does not assure KOLAS accreditation.

2.2. Limit

2.2.1. Limit of radiated output power

- §22.913(a)(5), the ERP of mobile transmitters and auxiliary test transmitters must not exceed 7 watts.

- §24.232(c), mobile and portable stations are limited to 2 watts EIRP and the equipment must employ a means to limiting power to the minimum necessary for successful communications.

2.2.2. Limit of spurious radiated emission

- §22.917(a), the power of any emission outside of the authorized operating frequency ranges must be attenuated below the transmitting power (P) by a factor of at least $43 + 10\log(P)$ dB.

- §24.238(a), the power of any emission outside of the authorized operating frequency ranges must be attenuated below the transmitting power (P) by a factor of at least $43 + 10 \log(P)$ dB.

The results shown in this test report refer only to the sample(s) tested unless otherwise stated. This test report cannot be reproduced, except in full, without prior written permission of the Company. This test report does not assure KOLAS accreditation.

2.3. Test procedure: Based on ANSI/TIA 603E: 2016

1. On a test site, the EUT shall be placed at 80 cm height on a turn table, and in the position close to normal use as declared by the applicant.
2. The test antenna shall be oriented initially for vertical polarization located 3 m from EUT to correspond to the fundamental frequency of the transmitter.
3. The output of the test antenna shall be connected to the measuring receiver and the peak detector is used for the measurement.
4. The maximized power level is recorded using the spectrum analyzer "Channel Power" function with the integration band set to the emissions occupied bandwidth, RBW = 1-5 % of the OBW (not to exceed 1 MHz), VBW $\geq 3 \times$ RBW, Detector = power averaging (rms), sweep time = auto, trace average at least 100 traces in power averaging (rms) mode, per the guidelines of KDB Publication 971168 D01 v03r01.
5. Radiated spurious emissions measurement method was set as follows:
RBW = 100 kHz for emissions below 1 GHz and 1 MHz for emissions above 1 GHz, VBW $\geq 3 \times$ RBW, Detector = Peak, trace mode = max hold, per the guidelines of KDB Publication 971168 D01 v03r01.
6. The transmitter shall be switched on, the measuring receiver shall be tuned to the frequency of the transmitter under test.
7. The test antenna shall be raised and lowered through the specified range of height until the maximum signal level is detected by the measuring receiver.
8. The transmitter shall be rotated through 360° in the horizontal plane, until the maximum signal level is detected by the measuring receiver.
9. The test antenna shall be raised and lowered again through the specified range of height until the maximum signal level is detected by the measuring receiver.
10. The maximum signal level detected by the measuring receiver shall be noted.
11. The EUT was replaced by half-wave dipole (1 GHz below) or horn antenna (1 GHz above) connected to a signal generator.
12. In necessary, the input attenuator setting on the measuring receiver shall be adjusted in order to increase the sensitivity of the measuring receiver.
13. The test antenna shall be raised and lowered through the specified range of height to ensure that the maximum signal is received.
14. The input signal to the substitution antenna shall be adjusted to the level that produces a level detected by the measuring receiver, which is equal to the level noted while the transmitter radiated power was measured, corrected for the change of input attenuator setting of the measuring receiver.
15. The input level to the substitution antenna shall be recorded as power level in dBm, corrected for any change of input attenuator setting of the measuring receiver.
16. The measurement shall be repeated with the test antenna and the substitution antenna orientated for horizontal polarization.

The results shown in this test report refer only to the sample(s) tested unless otherwise stated. This test report cannot be reproduced, except in full, without prior written permission of the Company. This test report does not assure KOLAS accreditation.

2.4. Test result for RF radiated output power

Ambient temperature : (23 ± 1) °C
 Relative humidity : 47 % R.H.

CDMA BC0

1xRTT

Frequency (MHz)	Ant. Pol. (H/V)	S.G level + Amp. (dB m)	Cable loss (dB)	Ant. gain (dB d)	E.R.P.	
					(dB m)	(mW)
824.70	H	31.60	3.26	-4.93	23.41	219.28
824.70	V	32.07	3.26	-4.93	23.88	244.34
836.52	H	31.32	3.45	-5.15	22.72	187.07
836.52	V	31.08	3.45	-5.15	22.48	177.01
848.31	H	30.55	3.52	-4.09	22.94	196.79
848.31	V	31.03	3.52	-4.09	23.42	219.79

EV-DO

Frequency (MHz)	Ant. Pol. (H/V)	S.G level + Amp. (dB m)	Cable loss (dB)	Ant. gain (dB d)	E.R.P.	
					(dB m)	(mW)
824.70	H	29.72	3.26	-4.93	21.53	142.23
824.70	V	31.71	3.26	-4.93	23.52	224.91
836.52	H	29.76	3.45	-5.15	21.16	130.62
836.52	V	30.63	3.45	-5.15	22.03	159.59
848.31	H	29.64	3.52	-4.09	22.03	159.59
848.31	V	29.92	3.52	-4.09	22.31	170.22

The results shown in this test report refer only to the sample(s) tested unless otherwise stated. This test report cannot be reproduced, except in full, without prior written permission of the Company. This test report does not assure KOLAS accreditation.

CDMA BC1
1xRTT

Frequency (MHz)	Ant. Pol. (H/V)	S.G level + Amp. (dB m)	Cable loss (dB)	Ant. gain (dB i)	E.I.R.P.	
					(dB m)	(mW)
1 851.25	H	19.83	4.33	8.53	24.03	252.93
1 851.25	V	20.82	4.33	8.53	25.02	317.69
1 880.00	H	21.13	4.34	8.63	25.42	348.34
1 880.00	V	19.99	4.34	8.63	24.28	267.92
1 908.75	H	21.58	4.36	8.60	25.82	381.94
1 908.75	V	18.38	4.36	8.60	22.62	182.81

EV-DO

Frequency (MHz)	Ant. Pol. (H/V)	S.G level + Amp. (dB m)	Cable loss (dB)	Ant. gain (dB i)	E.I.R.P.	
					(dB m)	(mW)
1 851.25	H	19.37	4.33	8.53	23.57	227.51
1 851.25	V	20.04	4.33	8.53	24.24	265.46
1 880.00	H	19.87	4.34	8.63	24.16	260.62
1 880.00	V	19.12	4.34	8.63	23.41	219.28
1 908.75	H	20.61	4.36	8.60	24.85	305.49
1 908.75	V	17.62	4.36	8.60	21.86	153.46

Remark:

1. E.R.P. & E.I.R.P. = [S.G level + Amp.] (dB m) - Cable loss (dB) + Ant. gain (dB d/dB i)
2. This device was tested under all data rates, and modulations.
3. The data reported in the table above was measured in worst case.

The results shown in this test report refer only to the sample(s) tested unless otherwise stated. This test report cannot be reproduced, except in full, without prior written permission of the Company. This test report does not assure KOLAS accreditation.

2.5. Spurious radiated emission

- Modulation Signal: CDMA BC0

1xRTT

Frequency (MHz)	Ant. Pol. (H/V)	S.G level + Amp. (dB m)	Cable loss (dB)	Ant. gain (dB d)	E.R.P. (dB m)	Limit (dB m)	Margin (dB)
Low Channel (824.70 MHz)							
1 649.70	H	-54.17	4.01	6.00	-52.18	-13.00	39.18
1 649.09	V	-57.05	4.01	5.99	-55.07	-13.00	42.07
Middle Channel (836.52 MHz)							
1 672.71	H	-56.06	4.06	6.17	-53.95	-13.00	40.95
1 673.44	V	-56.76	4.06	6.18	-54.64	-13.00	41.64
High Channel (848.31 MHz)							
1 697.20	H	-54.56	4.11	6.36	-52.31	-13.00	39.31
1 697.20	V	-52.52	4.11	6.36	-50.27	-13.00	37.27

The results shown in this test report refer only to the sample(s) tested unless otherwise stated. This test report cannot be reproduced, except in full, without prior written permission of the Company. This test report does not assure KOLAS accreditation.

- Modulation Signal: CDMA BC0

EV-DO

Frequency (MHz)	Ant. Pol. (H/V)	S.G level + Amp. (dB m)	Cable loss (dB)	Ant. gain (dB d)	E.R.P. (dB m)	Limit (dB m)	Margin (dB)
Low Channel (824.70 MHz)							
1 650.22	H	-56.22	4.01	6.00	-54.23	-13.00	41.23
1 648.80	V	-56.76	4.01	5.99	-54.78	-13.00	41.78
Middle Channel (836.52 MHz)							
1 673.91	H	-54.97	4.06	6.18	-52.85	-13.00	39.85
1 672.67	V	-52.48	4.06	6.17	-50.37	-13.00	37.37
High Channel (848.31 MHz)							
1 697.43	H	-53.56	4.11	6.36	-51.31	-13.00	38.31
1 696.05	V	-50.09	4.11	6.35	-47.85	-13.00	34.85

The results shown in this test report refer only to the sample(s) tested unless otherwise stated. This test report cannot be reproduced, except in full, without prior written permission of the Company. This test report does not assure KOLAS accreditation.

- Modulation Signal: CDMA BC1

1xRTT

Frequency (MHz)	Ant. Pol. (H/V)	S.G level + Amp. (dB m)	Cable loss (dB)	Ant. gain (dB i)	E.I.R.P. (dB m)	Limit (dB m)	Margin (dB)
Low Channel (1 851.25 MHz)							
3 702.93	H	-44.11	5.97	9.07	-41.01	-13.00	28.01
3 701.94	V	-52.62	5.97	9.07	-49.52	-13.00	36.52
5 554.33	H	-30.69	7.53	10.63	-27.59	-13.00	14.59
5 554.65	V	-48.74	7.53	10.63	-45.64	-13.00	32.64
Middle Channel (1 880.00 MHz)							
3 759.43	H	-49.86	6.26	9.12	-47.00	-13.00	34.00
3 760.29	V	-51.07	6.26	9.13	-48.20	-13.00	35.20
5 640.52	H	-28.66	7.65	10.91	-25.40	-13.00	12.40
5 640.64	V	-47.85	7.65	10.91	-44.59	-13.00	31.59
High Channel (1 908.75 MHz)							
3 817.23	H	-50.16	6.51	9.15	-47.52	-13.00	34.52
3 817.89	V	-50.33	6.51	9.15	-47.69	-13.00	34.69
5 726.96	H	-24.79	7.86	11.27	-21.38	-13.00	8.38
5 726.30	V	-42.36	7.86	11.27	-38.95	-13.00	25.95

The results shown in this test report refer only to the sample(s) tested unless otherwise stated. This test report cannot be reproduced, except in full, without prior written permission of the Company. This test report does not assure KOLAS accreditation.

- Modulation Signal: CDMA BC1

EV-DO

Frequency (MHz)	Ant. Pol. (H/V)	S.G level + Amp. (dB m)	Cable loss (dB)	Ant. gain (dB i)	E.I.R.P. (dB m)	Limit (dB m)	Margin (dB)
Low Channel (1 851.25 MHz)							
3 703.16	H	-44.05	5.98	9.07	-40.96	-13.00	27.96
3 701.86	V	-51.00	5.97	9.07	-47.90	-13.00	34.90
5 553.51	H	-28.04	7.53	10.63	-24.94	-13.00	11.94
5 554.05	V	-46.17	7.53	10.63	-43.07	-13.00	30.07
Middle Channel (1 880.00 MHz)							
3 760.68	H	-48.51	6.26	9.13	-45.64	-13.00	32.64
3 759.46	V	-50.39	6.26	9.12	-47.53	-13.00	34.53
5 640.13	H	-26.69	7.64	10.91	-23.42	-13.00	10.42
5 640.35	V	-44.04	7.65	10.91	-40.78	-13.00	27.78
High Channel (1 908.75 MHz)							
3 816.91	H	-49.96	6.51	9.15	-47.32	-13.00	34.32
3 816.94	V	-51.30	6.51	9.15	-48.66	-13.00	35.66
5 726.46	H	-24.24	7.86	11.27	-20.83	-13.00	7.83
5 726.09	V	-40.39	7.86	11.27	-36.98	-13.00	23.98

Remark:

1. E.R.P. & E.I.R.P. = [S.G level + Amp.] (dB m) - Cable loss (dB) + Ant. gain (dB d/dB i)
2. This device was tested under all data rates, and modulations.
3. The data reported in the table above was measured in worst case.

The results shown in this test report refer only to the sample(s) tested unless otherwise stated. This test report cannot be reproduced, except in full, without prior written permission of the Company. This test report does not assure KOLAS accreditation.

3. Conducted Output Power

3.1. Limit

CFR 47, Section FCC §2.1046.

3.2. Test Procedure

Output power shall be measured at the RF output terminals for all configurations.

1. The RF output of the transmitter was connected to the input of the mobile test unit in order to establish communication with the EUT.
2. The EUT was set up for the max. output power with pseudo random data modulation by using mobile test unit parameters.
3. The measurement performed using a wideband RF power meter.
4. This EUT was tested under all configurations and the highest power was investigated and reported.

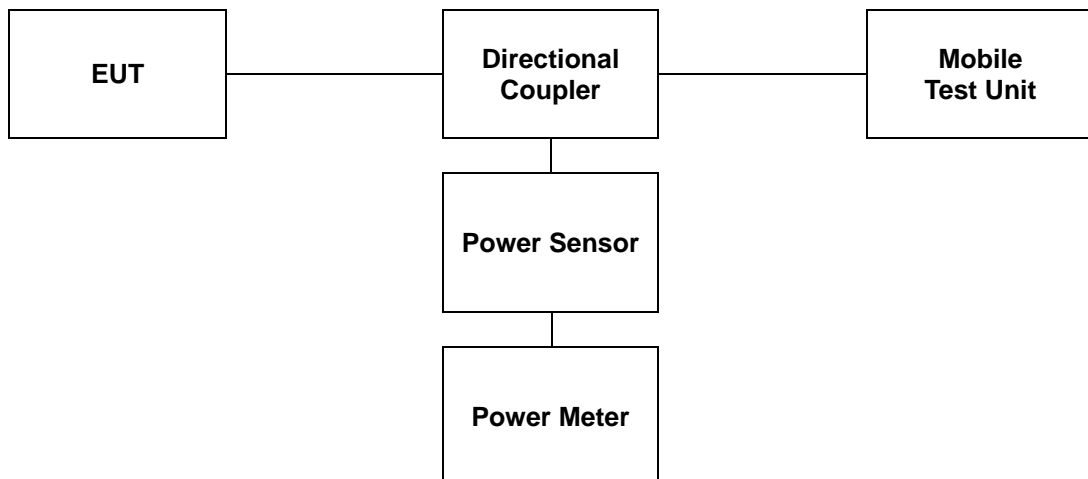

The results shown in this test report refer only to the sample(s) tested unless otherwise stated. This test report cannot be reproduced, except in full, without prior written permission of the Company. This test report does not assure KOLAS accreditation.

3.3. Test Result

Ambient temperature : (23 ± 1) °C

Relative humidity : 47 % R.H.

1xRTT

Radio Configuration	Service Option	Band BC0 (dB m)			Band BC1 (dB m)		
		824.70 MHz	836.52 MHz	848.31 MHz	1 851.25 MHz	1 880.00 MHz	1 908.75 MHz
RC1 (Fwd1, Rvs1)	2 (Loopback)	24.25	24.18	25.16	23.85	23.59	23.72
	3 (Voice)	24.05	24.00	24.10	23.90	23.61	23.60
	55 (Loopback)	24.32	24.28	25.08	23.82	23.63	23.56
	68 (Voice)	23.98	24.02	24.08	23.90	23.60	23.62
RC2 (Fwd2, Rvs2)	9 (Loopback)	24.30	24.19	23.85	23.89	23.66	23.94
	17 (Voice)	24.01	24.13	24.03	23.92	23.64	23.62
	55 (Loopback)	24.01	24.27	23.81	23.92	23.62	23.88
	32768 (Voice)	23.98	24.08	24.15	23.92	23.67	23.66
RC3 (Fwd3, Rvs3)	2 (Loopback)	23.94	24.12	23.83	23.89	23.58	23.94
	3 (Voice)	23.91	24.01	24.24	23.81	23.44	23.74
	55 (Loopback)	24.26	24.26	23.92	23.81	23.65	23.93
	32 (+F-SCH)	24.29	24.14	23.91	23.88	23.66	23.94
	32 (+SCH)	24.20	24.34	24.75	23.79	23.64	23.55
	68 (Voice)	24.00	23.95	24.13	23.82	23.45	23.69

The results shown in this test report refer only to the sample(s) tested unless otherwise stated. This test report cannot be reproduced, except in full, without prior written permission of the Company. This test report does not assure KOLAS accreditation.

RC4 (Fwd4, Rvs3)	2 (Loopback)	24.23	24.11	23.82	23.85	23.25	23.85
	3 (Voice)	24.04	23.84	24.15	23.78	23.45	23.59
	55 (Loopback)	24.28	24.24	23.90	23.83	23.70	23.81
	32 (+F-SCH)	24.00	24.17	23.88	23.85	23.54	23.86
	32 (+SCH)	24.26	24.22	23.86	23.86	23.80	23.92
	68 (Voice)	23.85	23.98	23.82	23.74	23.34	23.60
RC5 (Fwd5, Rvs4)	9 (Loopback)	24.24	24.19	23.88	23.73	23.65	23.89
	17 (Voice)	23.85	23.89	24.15	23.85	23.37	23.61
	55 (Loopback)	24.26	24.19	23.84	23.80	23.78	23.88
	32768 (Voice)	23.84	23.97	24.94	23.71	23.41	23.57

EV-DO

Protocol Release	3GPP Release Version	Band BC0 (dB m)			Band BC1 (dB m)		
		824.70 MHz	836.52 MHz	848.31 MHz	1 851.25 MHz	1 880.00 MHz	1 908.75 MHz
Rel. 0	FTAP (307.2 kbps, QPSK)	24.01	24.03	24.15	23.43	23.49	23.53
	RTAP (153.6 kbps)	23.94	24.03	23.94	23.46	23.41	23.36
Rev. A	FETAP (307.2 kbps, QPSK)	24.00	24.02	23.89	23.40	23.52	23.33
	RETAP (4096 bits)	23.95	24.00	23.86	23.38	23.50	23.35

The results shown in this test report refer only to the sample(s) tested unless otherwise stated. This test report cannot be reproduced, except in full, without prior written permission of the Company. This test report does not assure KOLAS accreditation.

4. Occupied Bandwidth

4.1. Limit

CFR 47, Section FCC §2.1049.

4.2. Test Procedure

The test follows section 4.3 of KDB Publication 971168 D01 v03r01.

- a. The spectrum analyzer center frequency is set to the nominal EUT channel center frequency. The frequency span for the spectrum analyzer shall be set wide enough to capture all modulation. products including the emission skirts (typically a span of $1.5 \times \text{OBW}$ is sufficient).
- b. The nominal IF filter 3 dB bandwidth (RBW) shall be in the range of 1 % to 5 % of the anticipated OBW, and the VBW shall be set $\geq 3 \times \text{RBW}$.
- c. Set the reference level of the instrument as required to prevent the signal amplitude from exceeding the maximum spectrum analyzer input mixer level for linear operation. See guidance provided in 4.2.3.
- d. Set the detection mode to peak, and the trace mode to max-hold.
- e. If the instrument does not have a 99 % OBW function, recover the trace data points and sum directly in linear power terms. Place the recovered amplitude data points, beginning at the lowest frequency, in a running sum until 0.5 % of the total is reached. Record that frequency as the lower OBW frequency. Repeat the process until 99.5 % of the total is reached and record that frequency as the upper OBW frequency. The 99 % power OBW can be determined by computing the difference these two frequencies.
- f. The OBW shall be reported and plot(s) of the measuring instrument display shall be provided with the test report. The frequency and amplitude axis and scale shall be clearly labeled. Tabular data can be reported in addition to the plot(s).

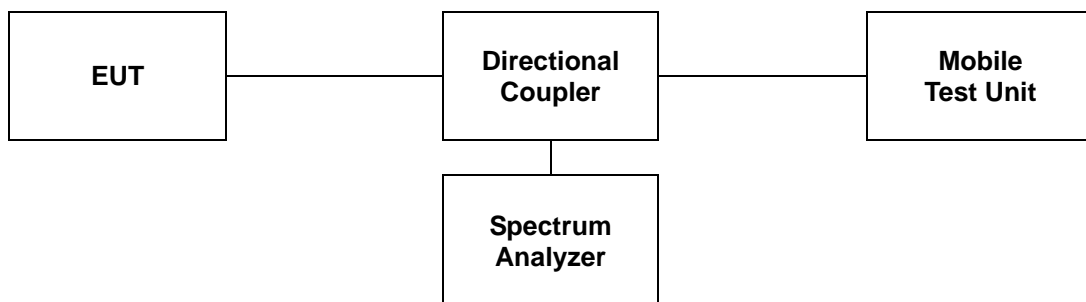

The results shown in this test report refer only to the sample(s) tested unless otherwise stated. This test report cannot be reproduced, except in full, without prior written permission of the Company. This test report does not assure KOLAS accreditation.

4.3 Test Results

Ambient temperature : (23 ± 1) °C

Relative humidity : 47 % R.H.

Band	Mode	Frequency (MHz)	Occupied Bandwidth (MHz)
BC0	1xRTT	824.70	1.285
		836.52	1.276
		848.31	1.276
	EV-DO	824.70	1.281
		836.52	1.272
		848.31	1.268
BC1	1xRTT	1 851.25	1.276
		1 880.00	1.276
		1 908.75	1.281
	EV-DO	1 851.25	1.272
		1 880.00	1.272
		1 908.75	1.276

The results shown in this test report refer only to the sample(s) tested unless otherwise stated. This test report cannot be reproduced, except in full, without prior written permission of the Company. This test report does not assure KOLAS accreditation.

CDMA BC0 (1xRTT)

Low Channel

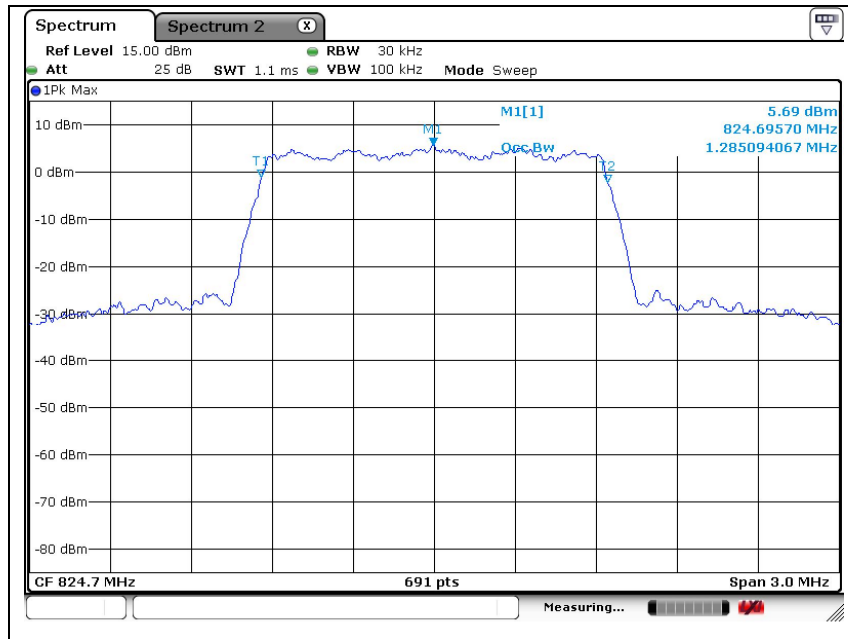

Middle Channel

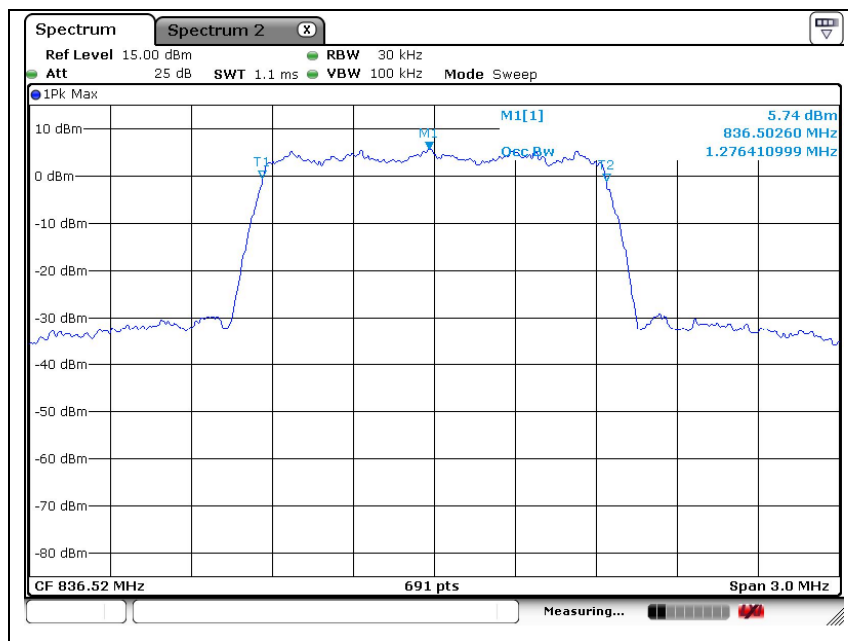

The results shown in this test report refer only to the sample(s) tested unless otherwise stated. This test report cannot be reproduced, except in full, without prior written permission of the Company. This test report does not assure KOLAS accreditation.

High Channel

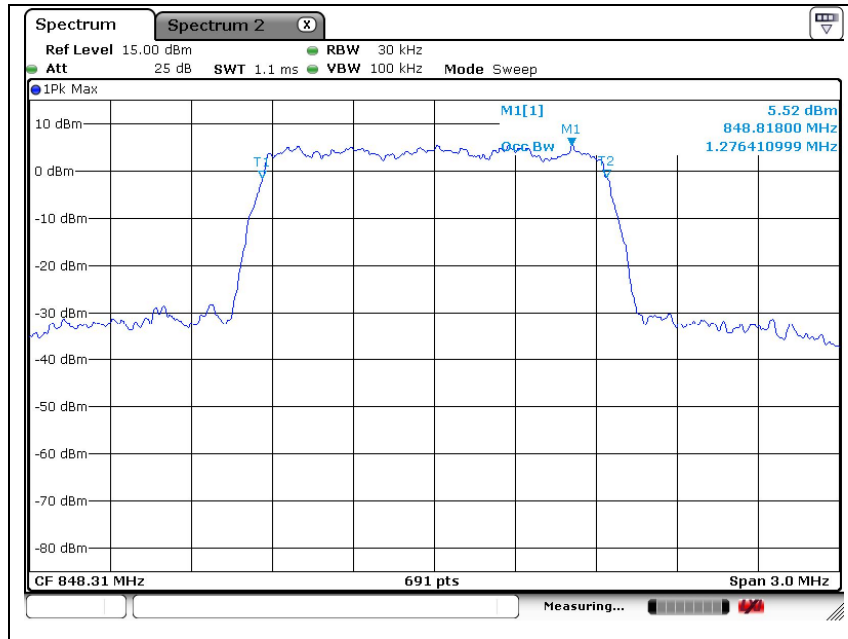

The results shown in this test report refer only to the sample(s) tested unless otherwise stated. This test report cannot be reproduced, except in full, without prior written permission of the Company. This test report does not assure KOLAS accreditation.

CDMA BC0 (EV-DO)

Low Channel

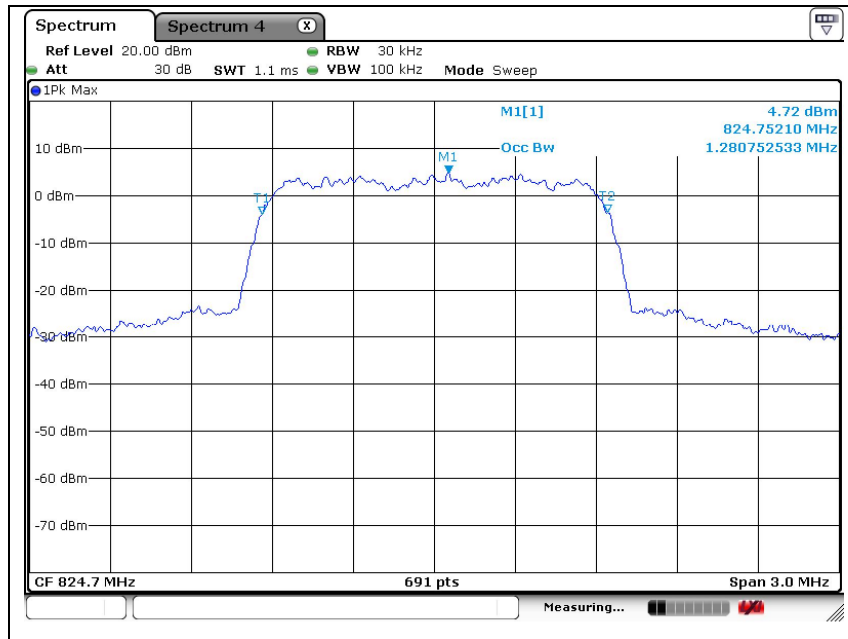

Middle Channel

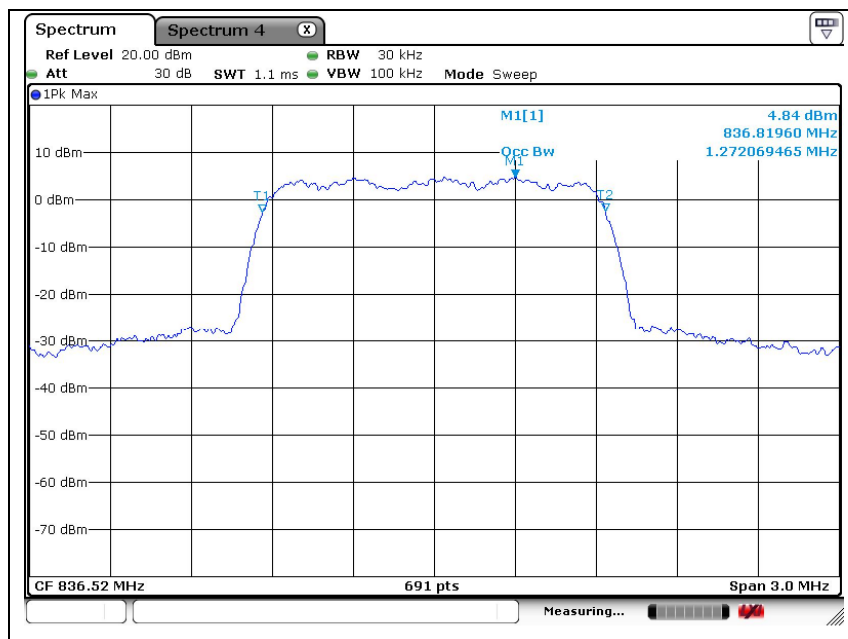

The results shown in this test report refer only to the sample(s) tested unless otherwise stated. This test report cannot be reproduced, except in full, without prior written permission of the Company. This test report does not assure KOLAS accreditation.

High Channel

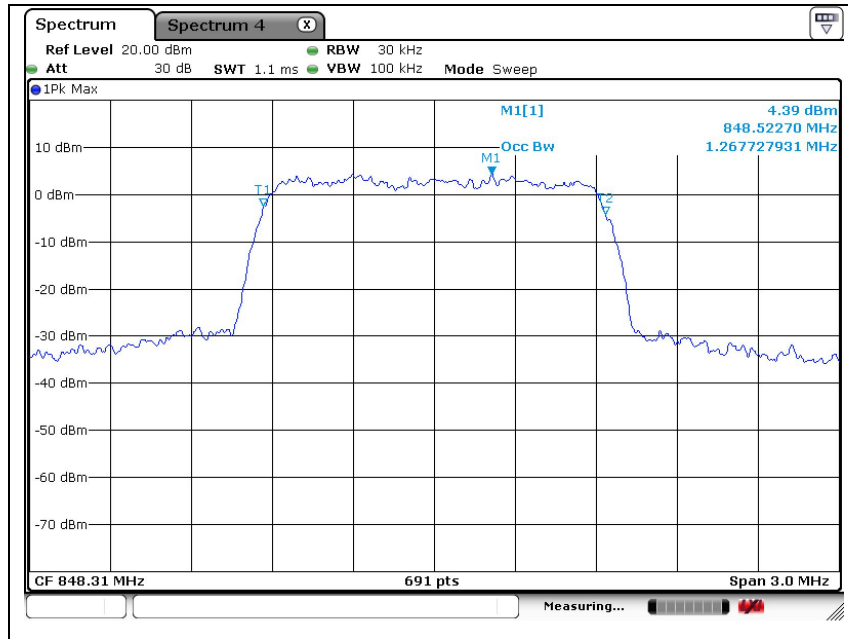

The results shown in this test report refer only to the sample(s) tested unless otherwise stated. This test report cannot be reproduced, except in full, without prior written permission of the Company. This test report does not assure KOLAS accreditation.

CDMA BC1 (1xRTT)

Low Channel

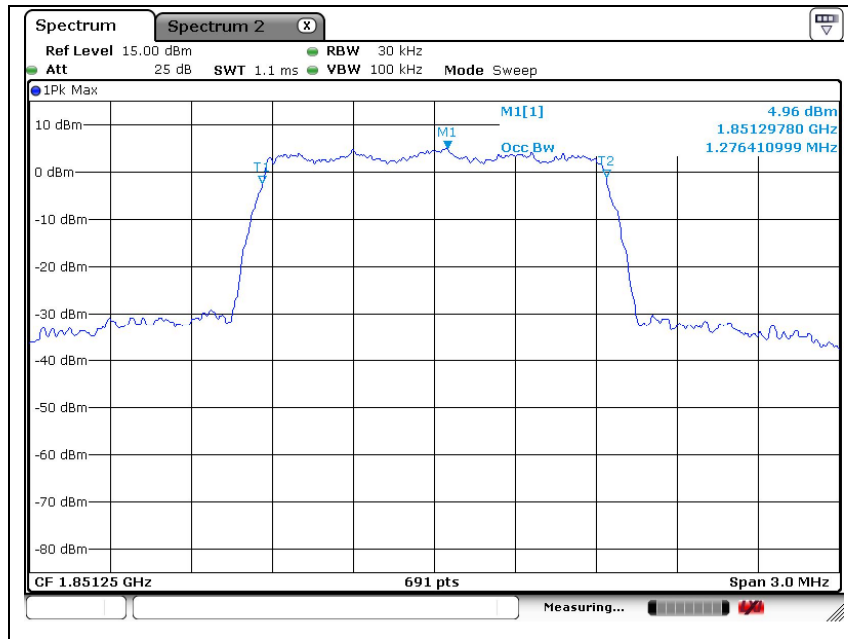

Middle Channel

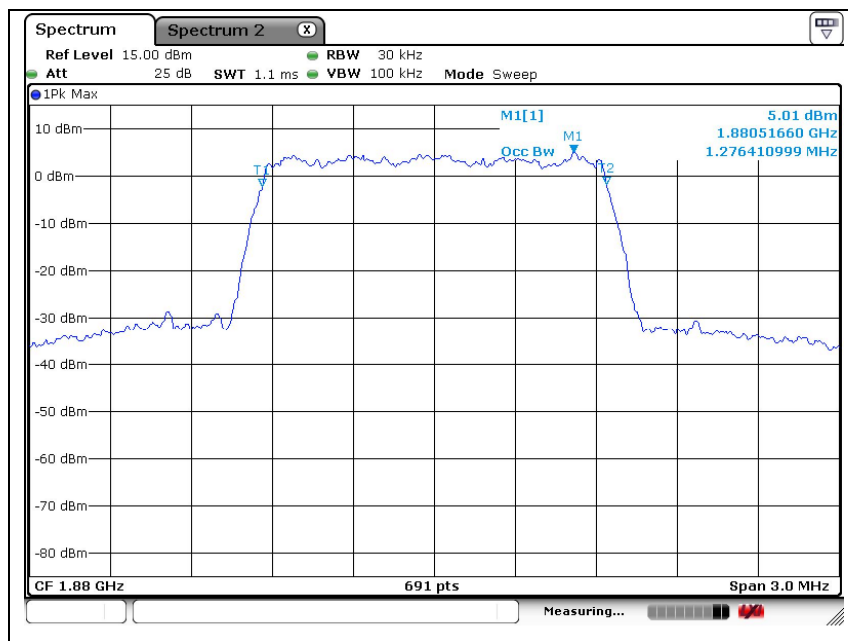

The results shown in this test report refer only to the sample(s) tested unless otherwise stated. This test report cannot be reproduced, except in full, without prior written permission of the Company. This test report does not assure KOLAS accreditation.

High Channel

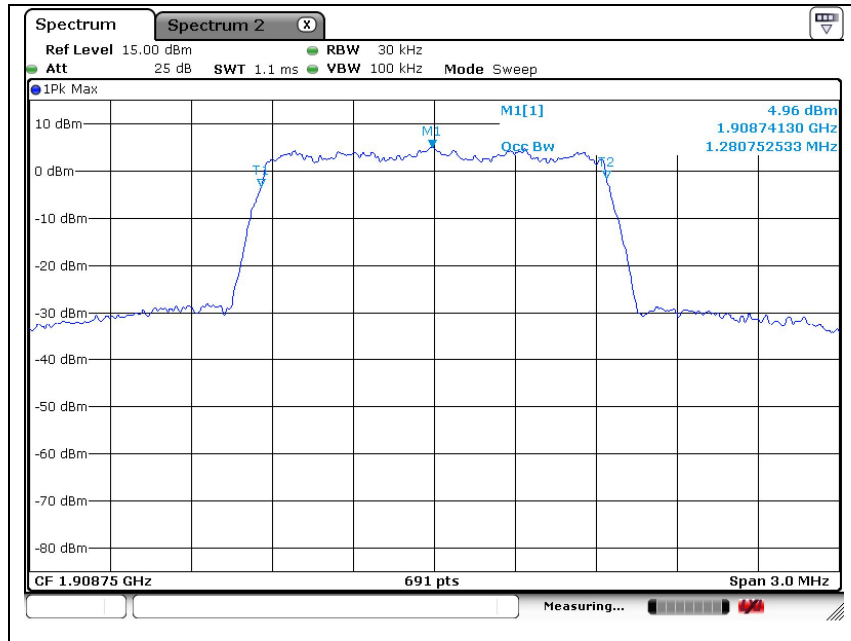

The results shown in this test report refer only to the sample(s) tested unless otherwise stated. This test report cannot be reproduced, except in full, without prior written permission of the Company. This test report does not assure KOLAS accreditation.

CDMA BC1 (EV-DO)

Low Channel

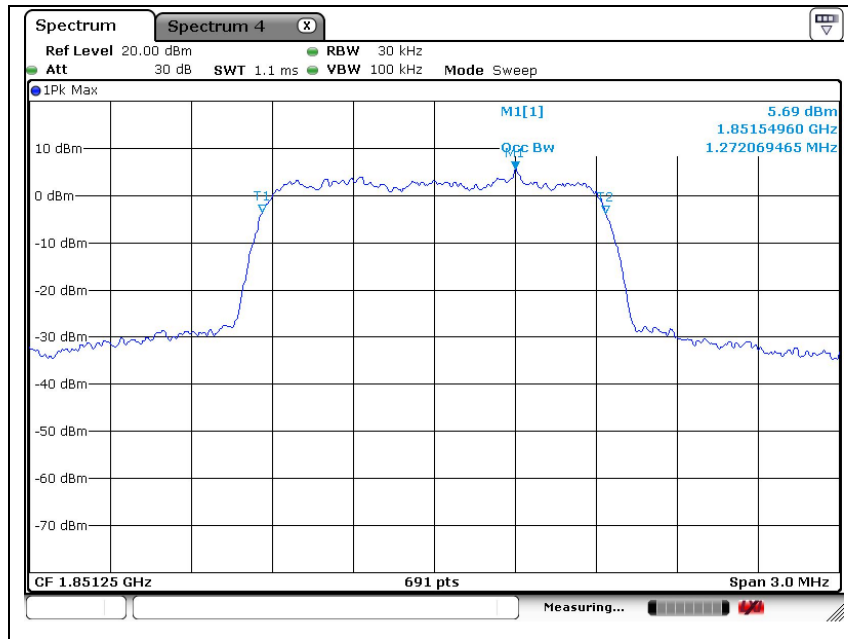

Middle Channel

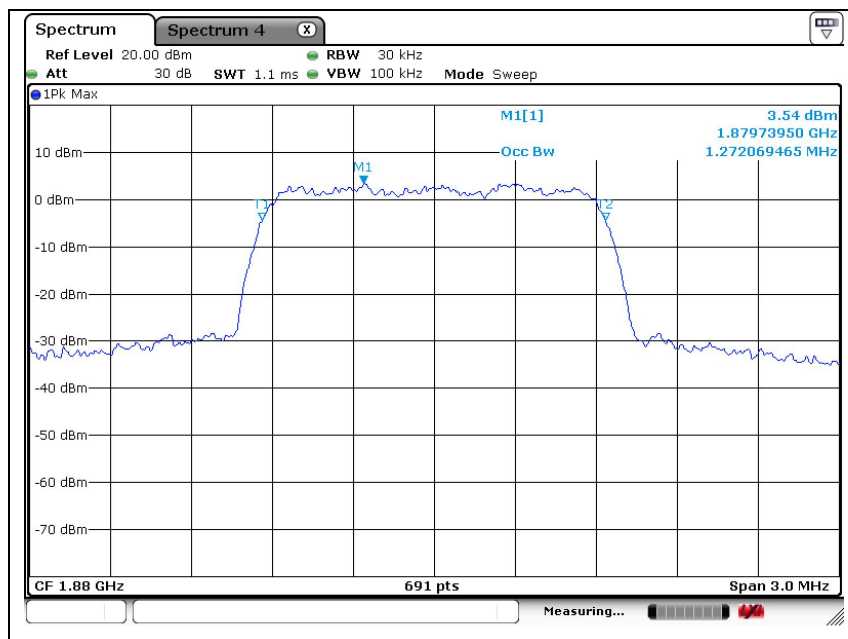

The results shown in this test report refer only to the sample(s) tested unless otherwise stated. This test report cannot be reproduced, except in full, without prior written permission of the Company. This test report does not assure KOLAS accreditation.

High Channel

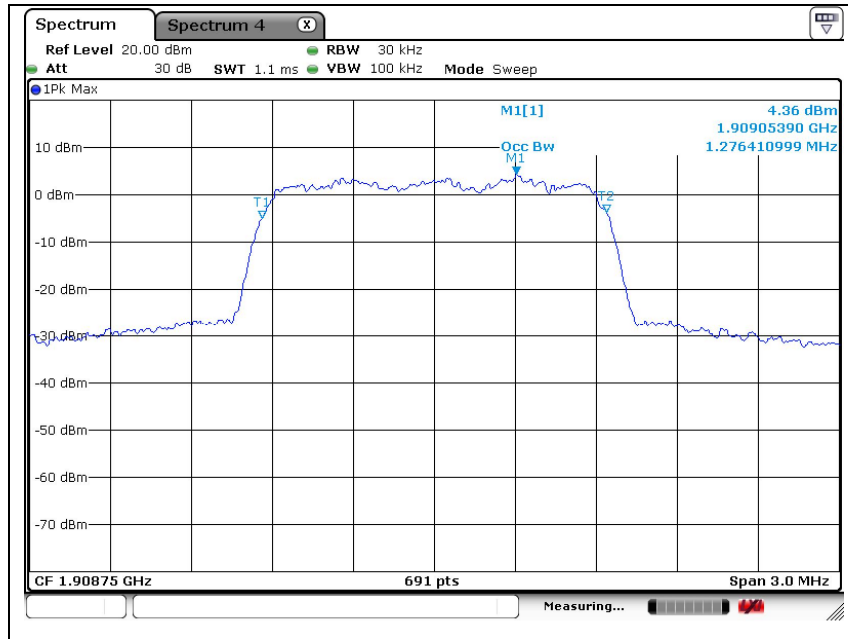

The results shown in this test report refer only to the sample(s) tested unless otherwise stated. This test report cannot be reproduced, except in full, without prior written permission of the Company. This test report does not assure KOLAS accreditation.

5. Peak-Average Ratio

5.1. Limit

- §22.913(d) Measurement of the ERP of Cellular base transmitters and repeaters must be made using an average power measurement technique. The peak-to-average ratio (PAR) of the transmission must not exceed 13 dB.

- §24.232(d), power measurements for transmissions by stations authorized under this section may be made either in accordance with a Commission-approved average power technique or in compliance with paragraph (e) of this section. In both instances, equipment employed must be authorized in accordance with the provisions of §24.51. In measuring transmissions in this band using an average power technique, the peak-to-average ratio (PAR) of the transmission may not exceed 13 dB.

5.2. Test Procedure

The test follows section 5.7.2 of FCC KDB Publication 971168 D01 v03r01.

See instrumentation-specific application literature for further guidance regarding use of the CCDF capability. The following guidelines are offered for performing a CCDF measurement.

- a. Set resolution/measurement bandwidth \geq OBW or specified reference bandwidth.
- b. Set the number of counts to a value that stabilizes the measured CCDF curve.
- c. Set the measurement interval as follows:
 - 1) For continuous transmissions, set to greater of $[10 \times (\text{number of points in sweep}) \times (\text{transmission symbol period})]$ or 1 ms.
 - 2) For burst transmissions, employ an external trigger that is synchronized with the EUT burst timing sequence, or use the internal burst trigger with a trigger level that allows the burst to stabilize. Set the measurement interval to a time that is less than or equal to the burst duration.
 - 3) If there are several carriers in a single antenna port, the peak power shall be determined for each individual carrier (by disabling the other carriers while measuring the required carrier) and the total peak power calculated from the sum of the individual carrier peak powers.
- d. Record the maximum PAPR level associated with a probability of 0.1 %.
- e. The peak power level is calculated from the sum of the PAPR value from step d) to the measured average power.

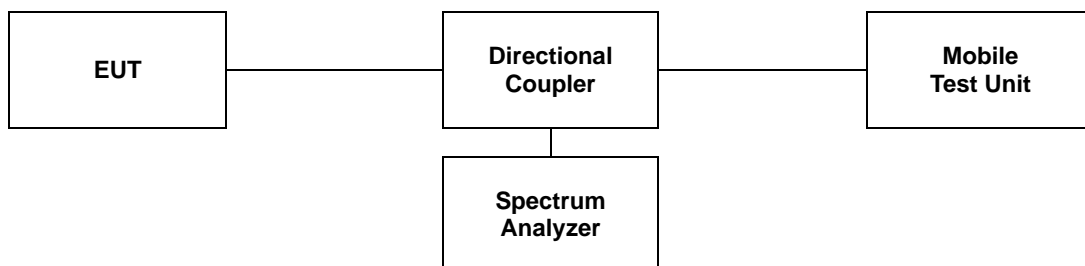

The results shown in this test report refer only to the sample(s) tested unless otherwise stated. This test report cannot be reproduced, except in full, without prior written permission of the Company. This test report does not assure KOLAS accreditation.

5.3 Test Results

Ambient temperature : (23 ± 1) °C

Relative humidity : 47 % R.H.

Band	Mode	Frequency (MHz)	PAR (dB)
BC0	1xRTT	824.70	3.33
		836.52	3.77
		848.31	4.06
	EV-DO	824.70	3.91
		836.52	4.00
		848.31	4.58
BC1	1xRTT	1 851.25	3.80
		1 880.00	3.83
		1 908.75	3.48
	EV-DO	1 851.25	4.12
		1 880.00	4.17
		1 908.75	3.45

The results shown in this test report refer only to the sample(s) tested unless otherwise stated. This test report cannot be reproduced, except in full, without prior written permission of the Company. This test report does not assure KOLAS accreditation.

CDMA BC0 (1xRTT)

Low Channel

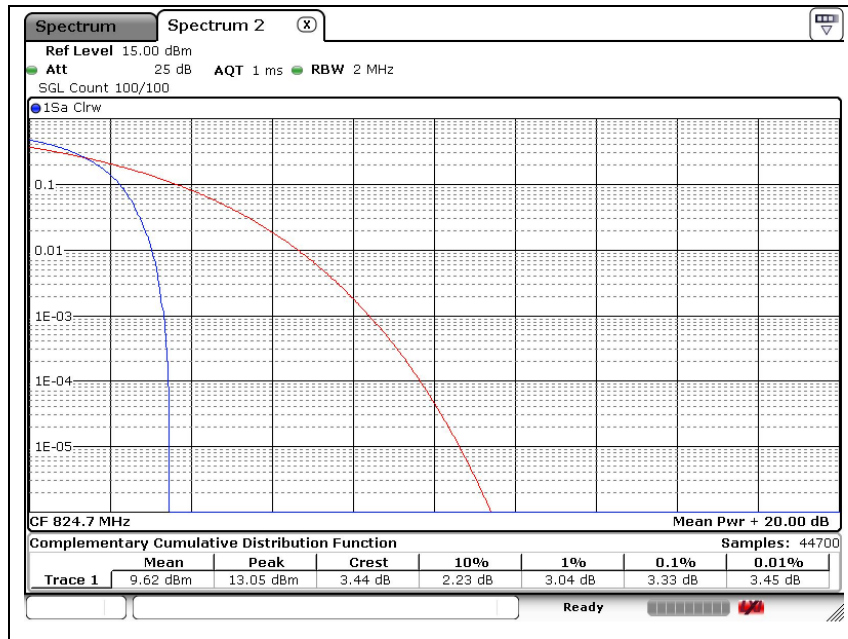

Middle Channel

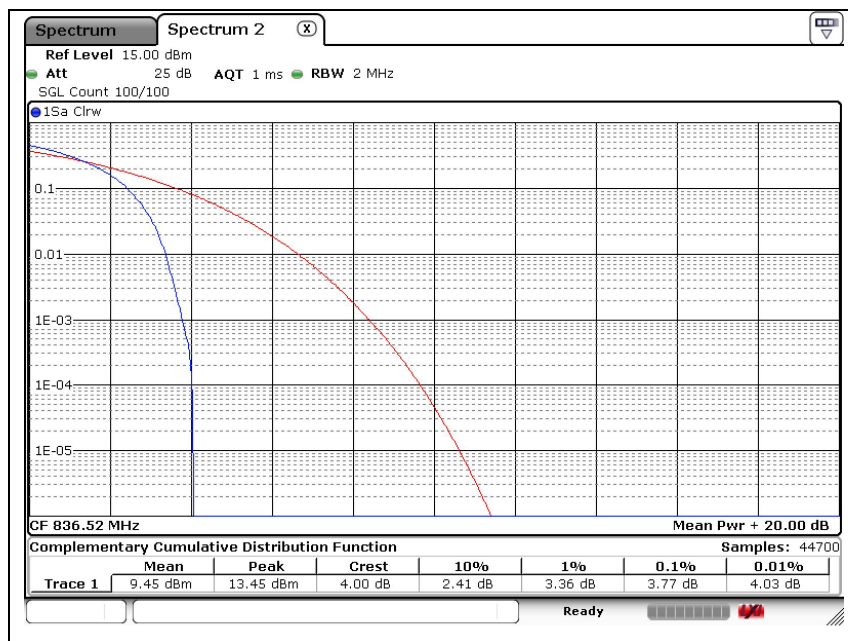

The results shown in this test report refer only to the sample(s) tested unless otherwise stated. This test report cannot be reproduced, except in full, without prior written permission of the Company. This test report does not assure KOLAS accreditation.

High Channel

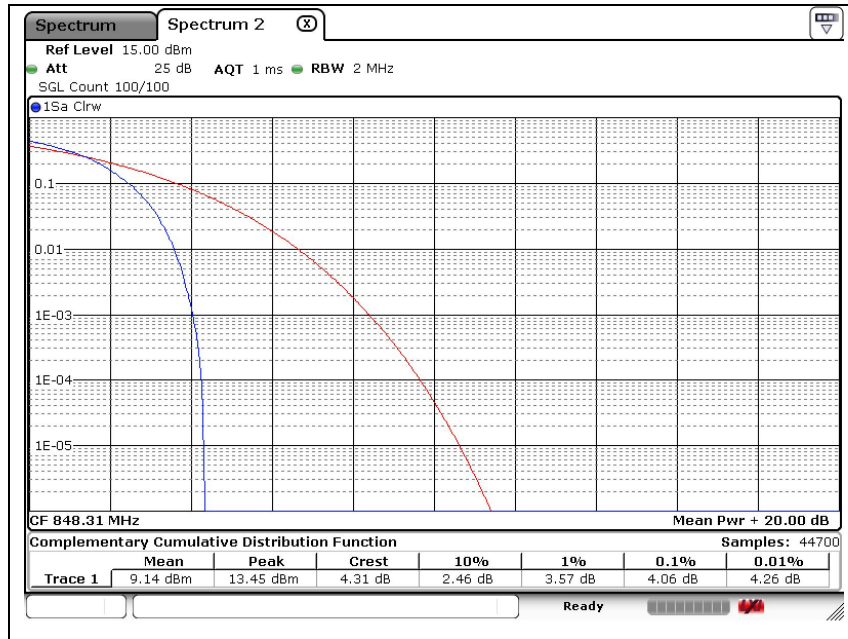

The results shown in this test report refer only to the sample(s) tested unless otherwise stated. This test report cannot be reproduced, except in full, without prior written permission of the Company. This test report does not assure KOLAS accreditation.

CDMA BC0 (EV-DO)

Low Channel

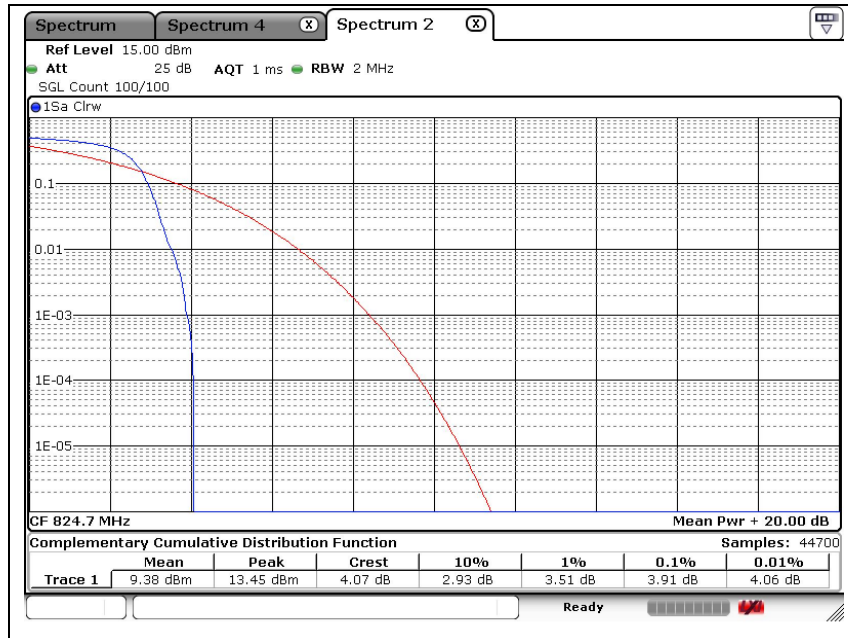

Middle Channel

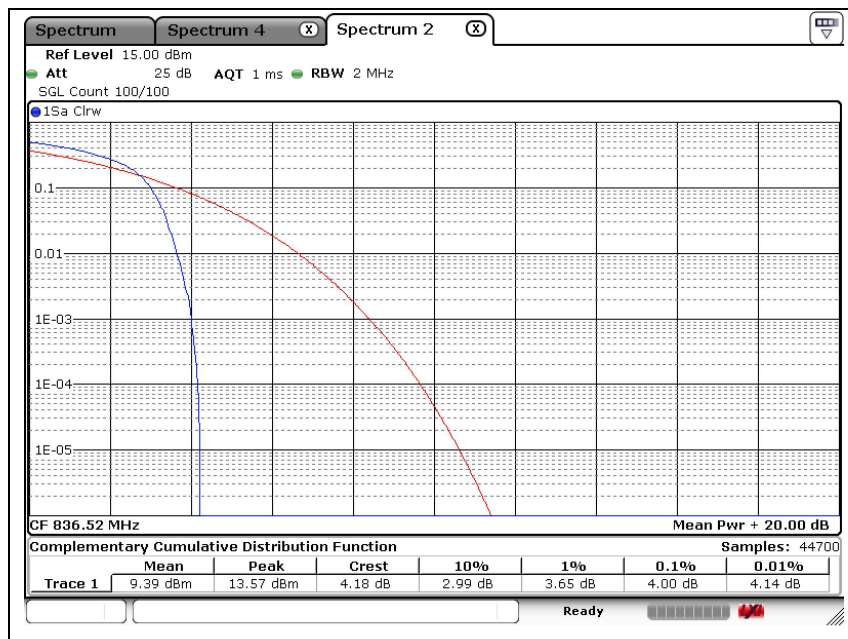

The results shown in this test report refer only to the sample(s) tested unless otherwise stated. This test report cannot be reproduced, except in full, without prior written permission of the Company. This test report does not assure KOLAS accreditation.

High Channel

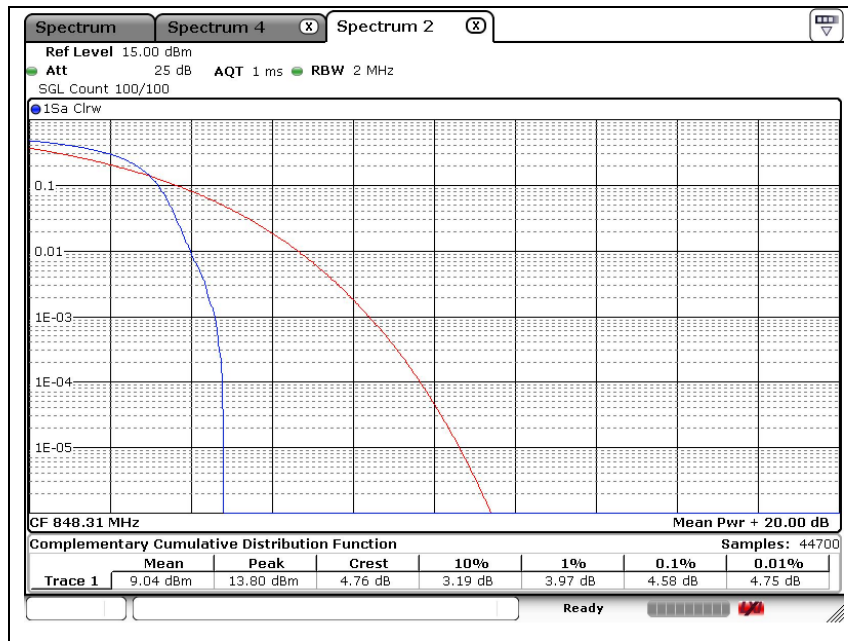

The results shown in this test report refer only to the sample(s) tested unless otherwise stated. This test report cannot be reproduced, except in full, without prior written permission of the Company. This test report does not assure KOLAS accreditation.

CDMA BC1 (1xRTT)

Low Channel

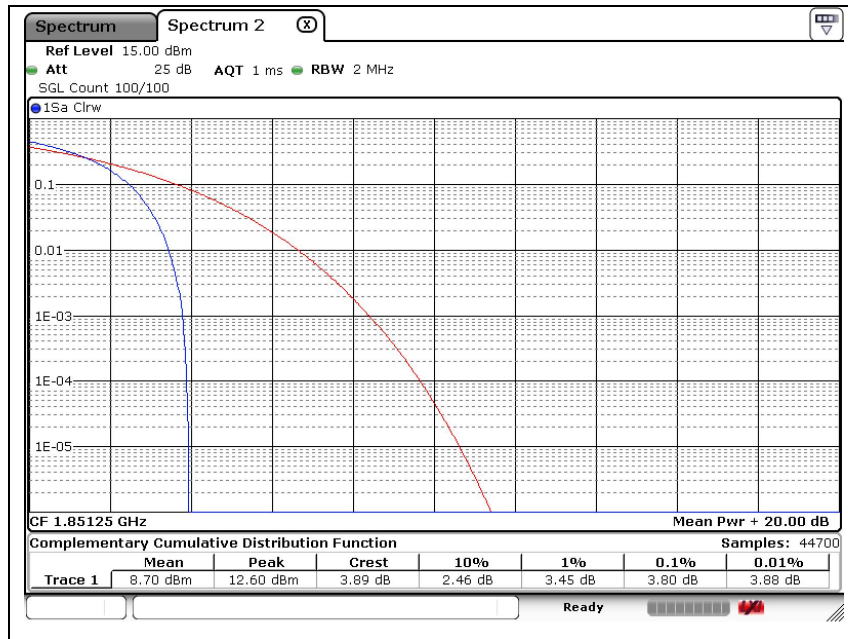

Middle Channel

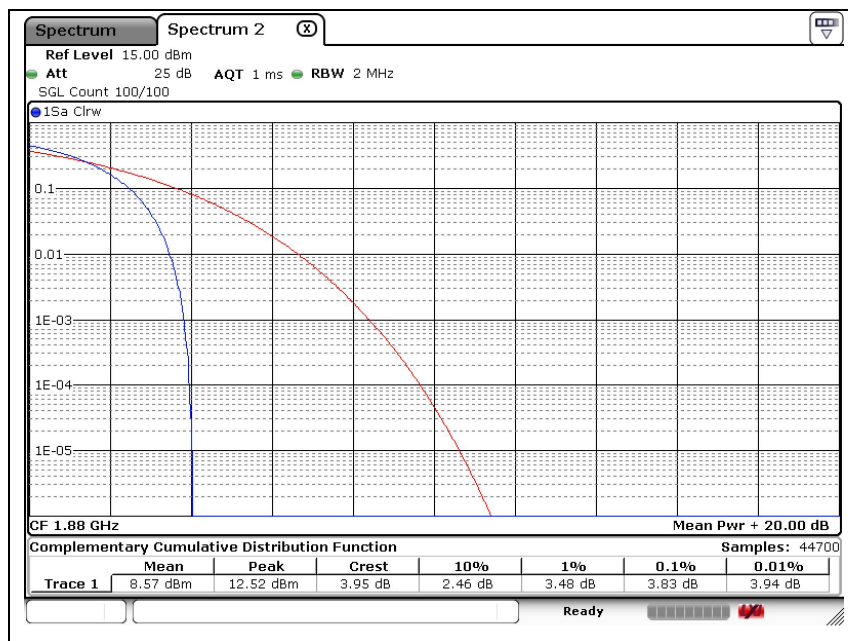

The results shown in this test report refer only to the sample(s) tested unless otherwise stated. This test report cannot be reproduced, except in full, without prior written permission of the Company. This test report does not assure KOLAS accreditation.

High Channel

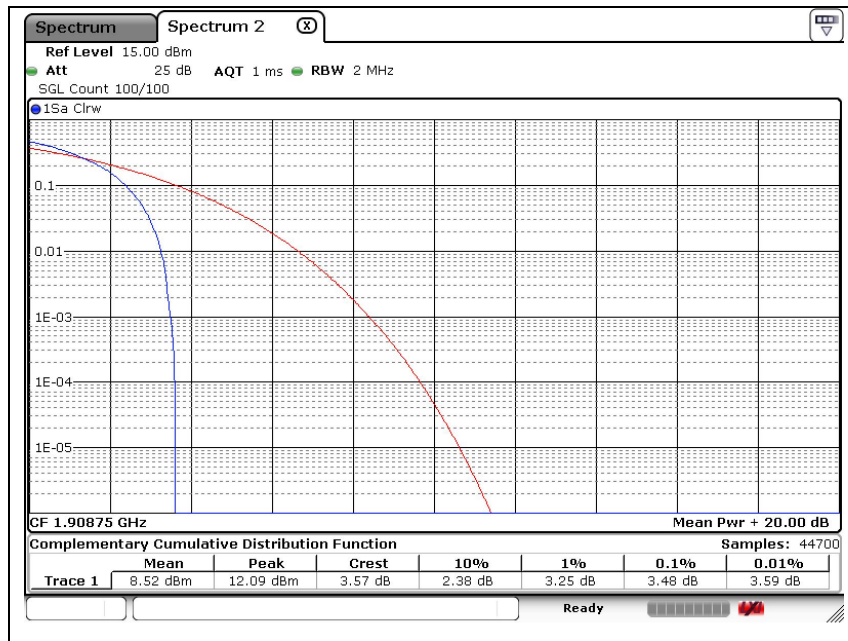

The results shown in this test report refer only to the sample(s) tested unless otherwise stated. This test report cannot be reproduced, except in full, without prior written permission of the Company. This test report does not assure KOLAS accreditation.

CDMA BC1 (EV-DO)

Low Channel

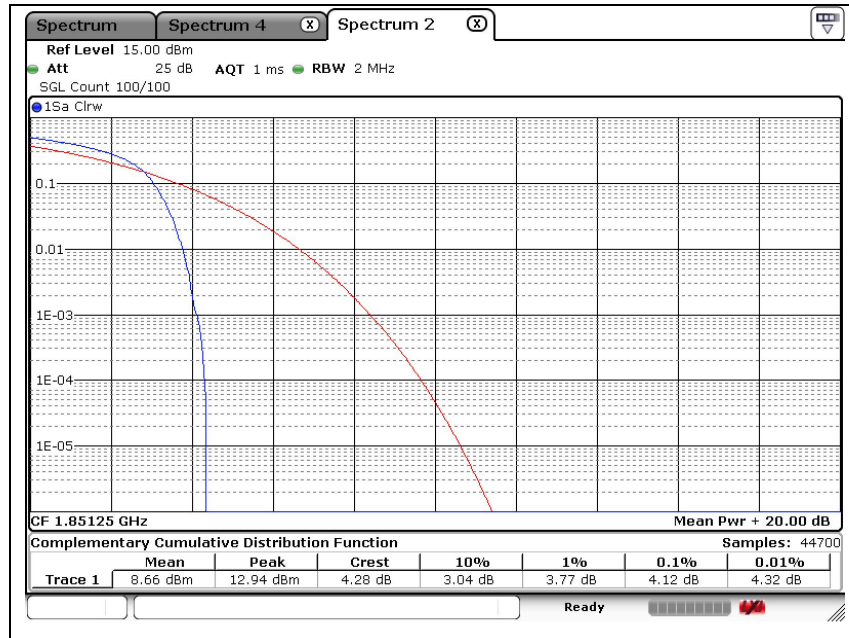

Middle Channel

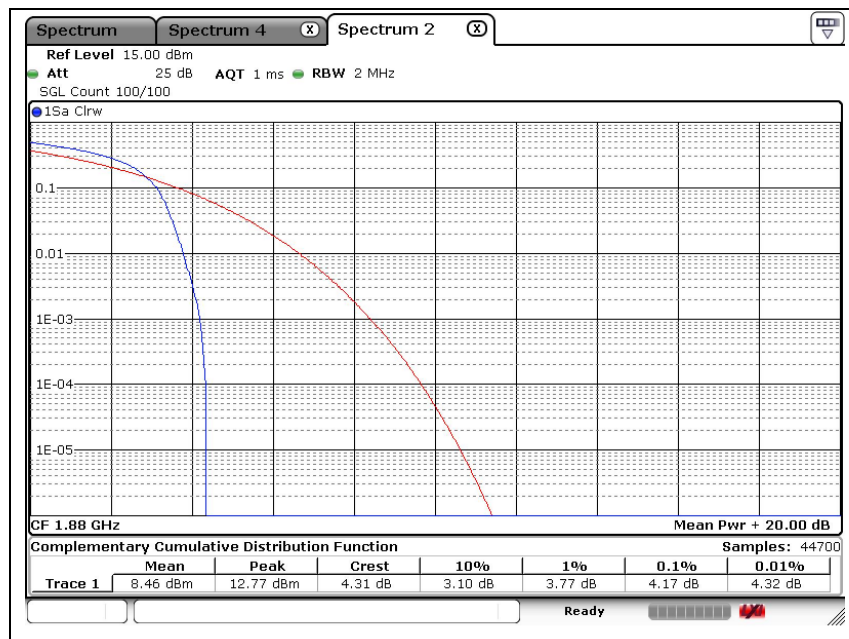

The results shown in this test report refer only to the sample(s) tested unless otherwise stated. This test report cannot be reproduced, except in full, without prior written permission of the Company. This test report does not assure KOLAS accreditation.

High Channel

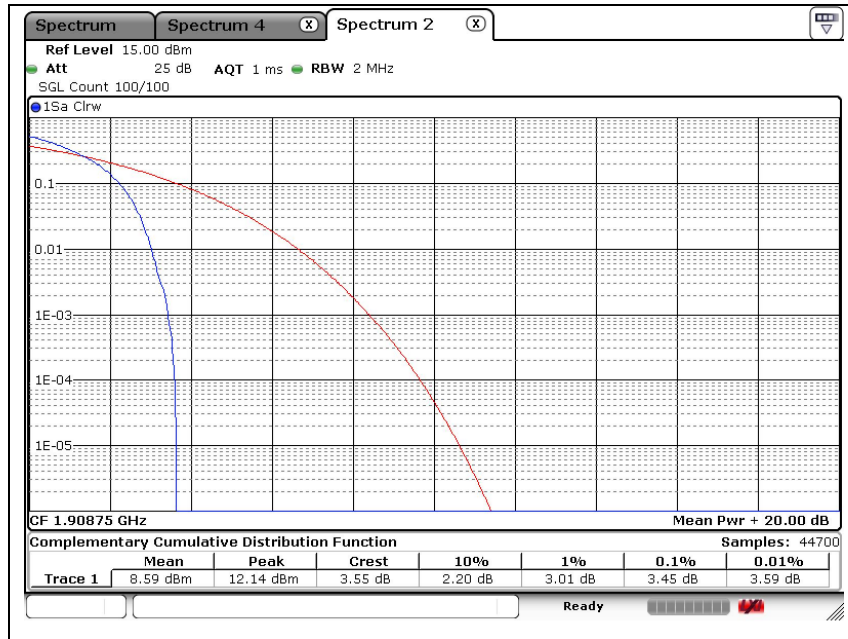

The results shown in this test report refer only to the sample(s) tested unless otherwise stated. This test report cannot be reproduced, except in full, without prior written permission of the Company. This test report does not assure KOLAS accreditation.

6. Spurious Emissions at Antenna Terminal

6.1. Limit

- §22.917(a), the power of any emission outside of the authorized operating frequency ranges must be attenuated below the transmitting power (P) by a factor of at least $43 + 10\log(P)$ dB.

- §24.238(a), the power of any emission outside of the authorized operating frequency ranges must be attenuated below the transmitting power (P) by a factor of at least $43 + 10 \log(P)$ dB.

6.2. Test Procedure

The test follows section 6 of FCC KDB Publication 971168 D01 v03r01.

1. Start frequency was set to 30 MHz and stop frequency was set to at least 10* the fundamental frequency.
2. Detector = Peak.
3. Trace mode = Max hold.
4. Sweep time = Auto couple.
5. The trace was allowed to stabilize.
6. Please see notes below for RBW and VBW settings.
7. For plots showing conducted spurious emissions from 30 MHz to 20 GHz, all path loss of wide frequency range was investigated and compensated to spectrum analyzer as correction factor.

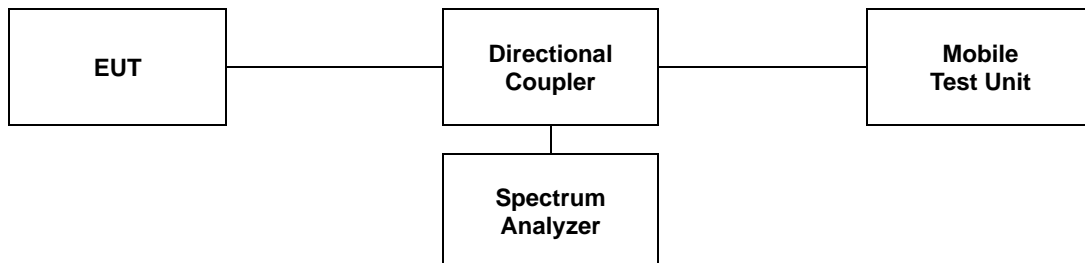

Notes;

Compliance with the applicable limits is based on the use of measurement instrumentation employing a resolution bandwidth of 100 kHz or greater for frequencies less than 1 GHz and frequencies greater than 1 GHz. However, in the 1 MHz bands immediately outside and adjacent to the frequency block a resolution bandwidth of at least one percent of the emission bandwidth of the fundamental emission of the transmitter may be employed. The emission bandwidth is defined as the width of the signal between two point, one below the carrier center frequency and one above the carrier center frequency, outside of which all emission are attenuated at least 26 dB below the transmitter power.

The results shown in this test report refer only to the sample(s) tested unless otherwise stated. This test report cannot be reproduced, except in full, without prior written permission of the Company. This test report does not assure KOLAS accreditation.

6.3. Test Results

Ambient temperature : (23 ± 1) °C
 Relative humidity : 47 % R.H.

CDMA BC0 (1xRTT)

Low Channel

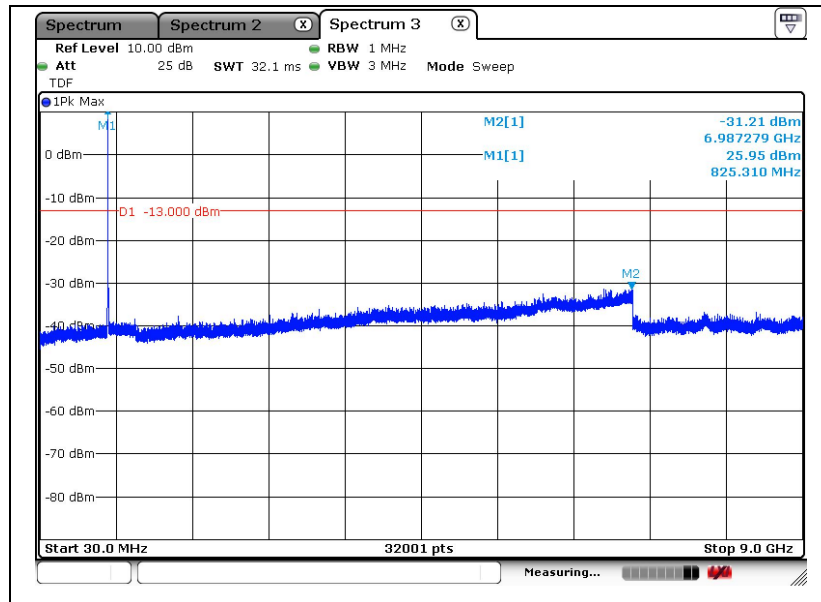

Middle Channel

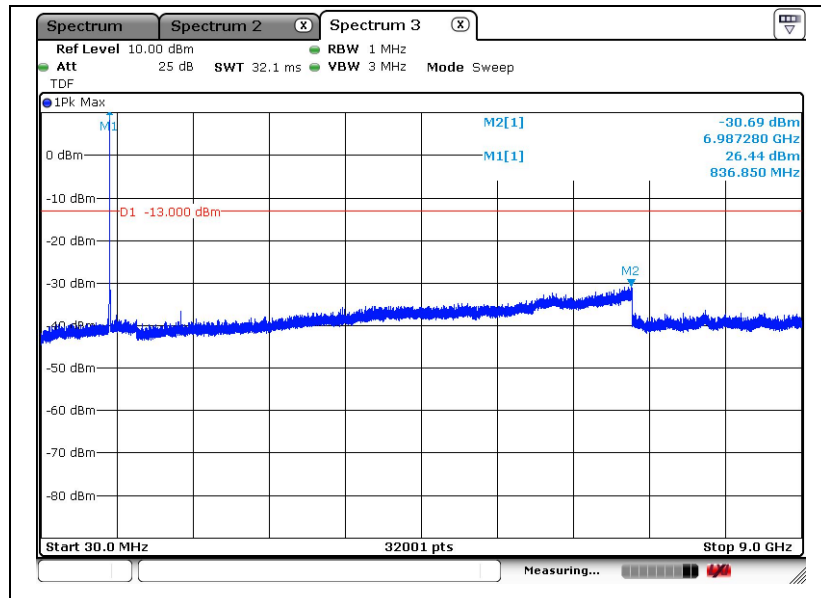

The results shown in this test report refer only to the sample(s) tested unless otherwise stated. This test report cannot be reproduced, except in full, without prior written permission of the Company. This test report does not assure KOLAS accreditation.

High Channel

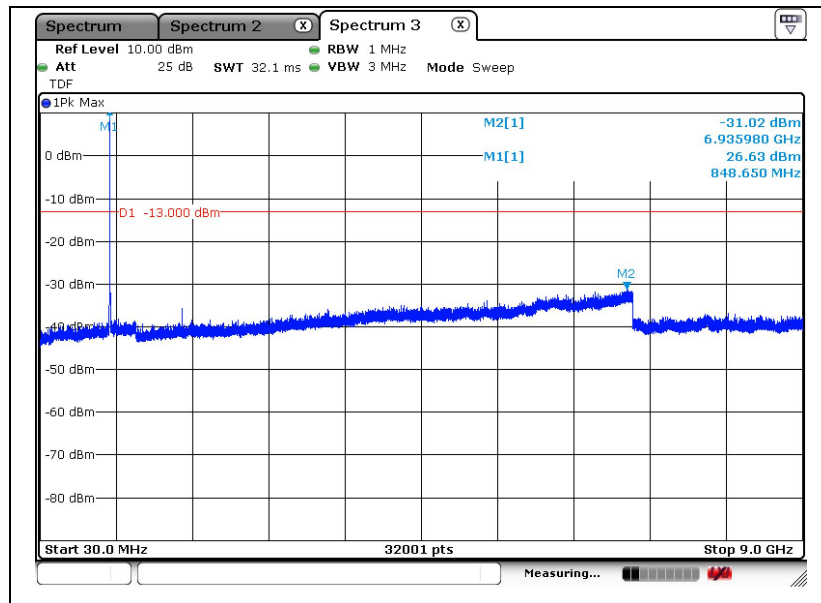

The results shown in this test report refer only to the sample(s) tested unless otherwise stated. This test report cannot be reproduced, except in full, without prior written permission of the Company. This test report does not assure KOLAS accreditation.

CDMA BC0 (EV-DO)

Low Channel

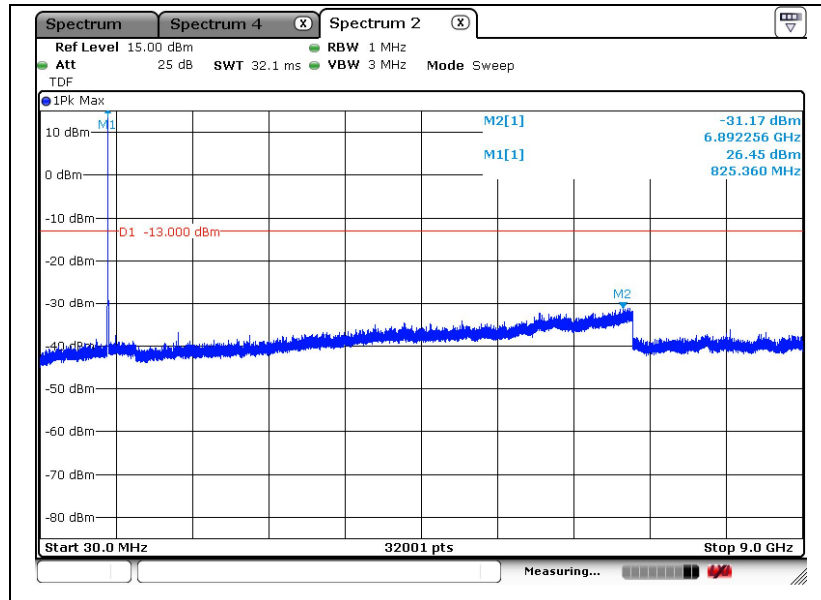

Middle Channel

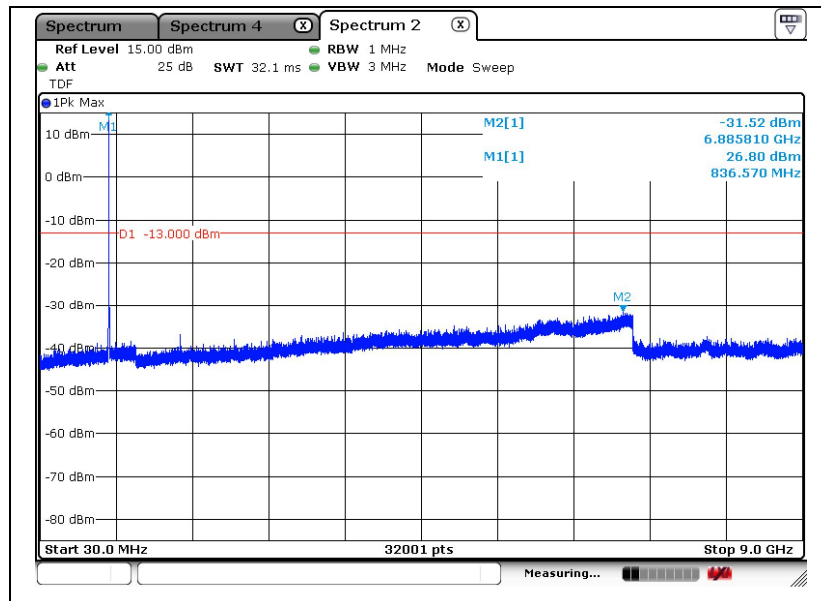

The results shown in this test report refer only to the sample(s) tested unless otherwise stated. This test report cannot be reproduced, except in full, without prior written permission of the Company. This test report does not assure KOLAS accreditation.

High Channel

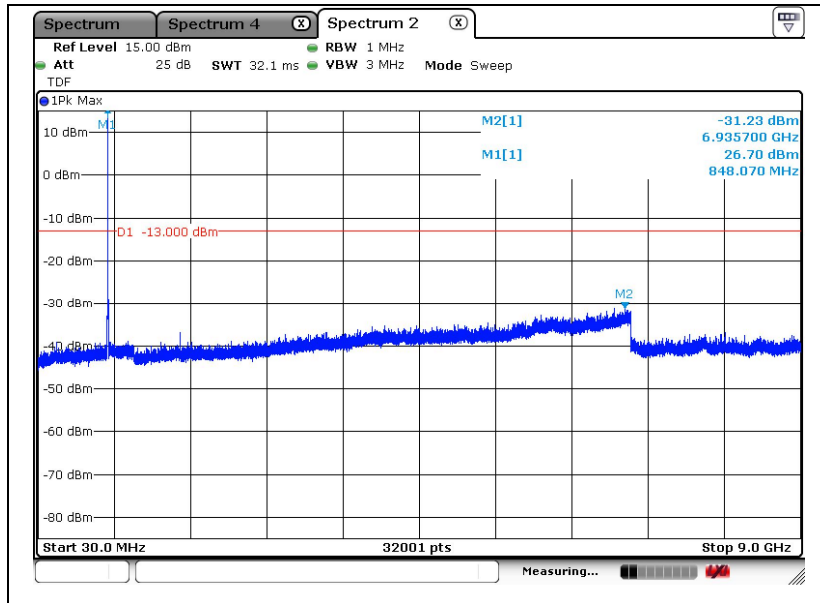

The results shown in this test report refer only to the sample(s) tested unless otherwise stated. This test report cannot be reproduced, except in full, without prior written permission of the Company. This test report does not assure KOLAS accreditation.

CDMA BC1 (1xRTT)

Low Channel

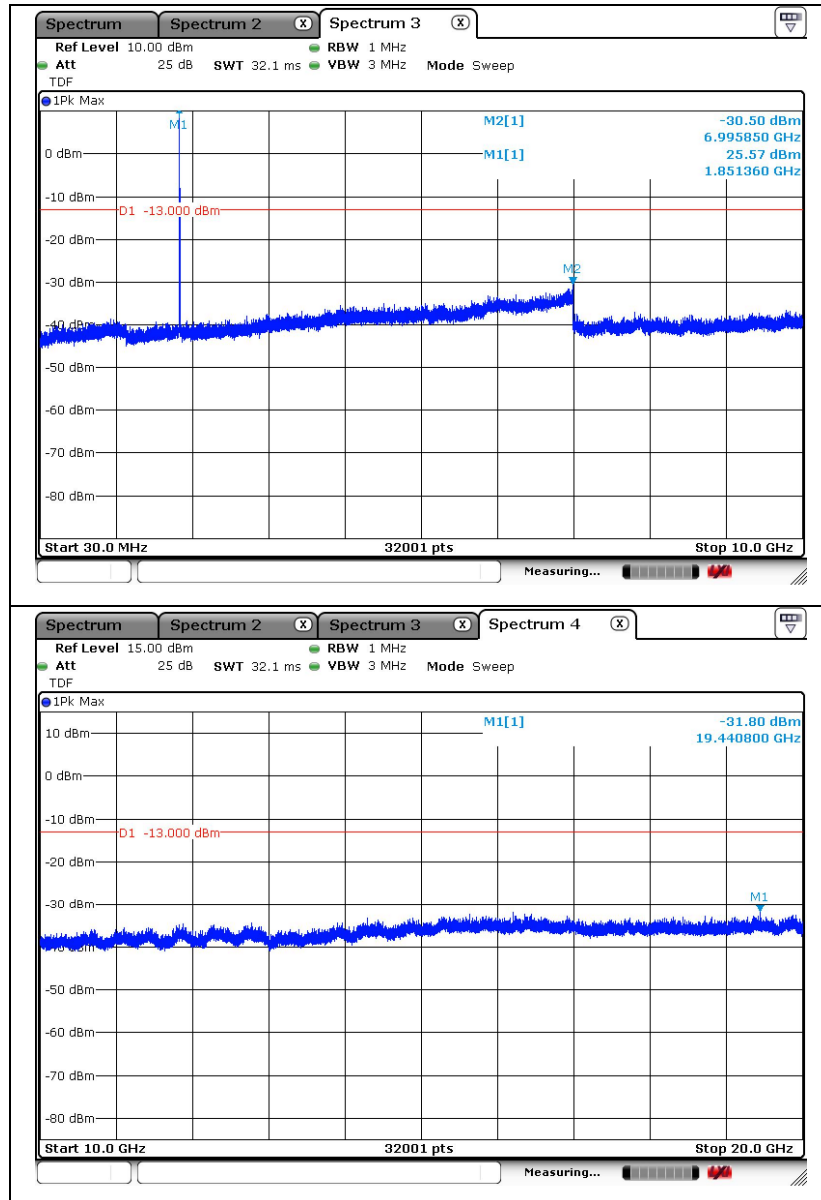

The results shown in this test report refer only to the sample(s) tested unless otherwise stated. This test report cannot be reproduced, except in full, without prior written permission of the Company. This test report does not assure KOLAS accreditation.

Middle Channel

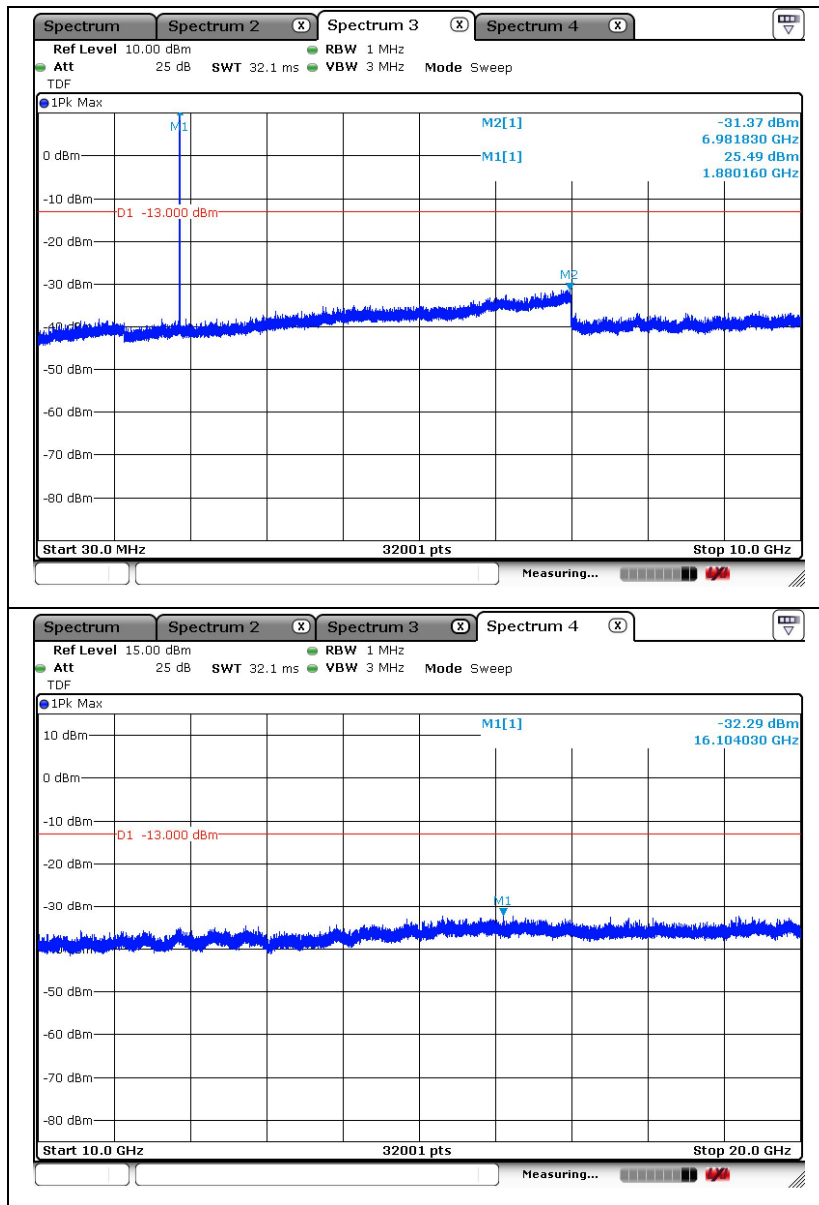

The results shown in this test report refer only to the sample(s) tested unless otherwise stated. This test report cannot be reproduced, except in full, without prior written permission of the Company. This test report does not assure KOLAS accreditation.

High Channel

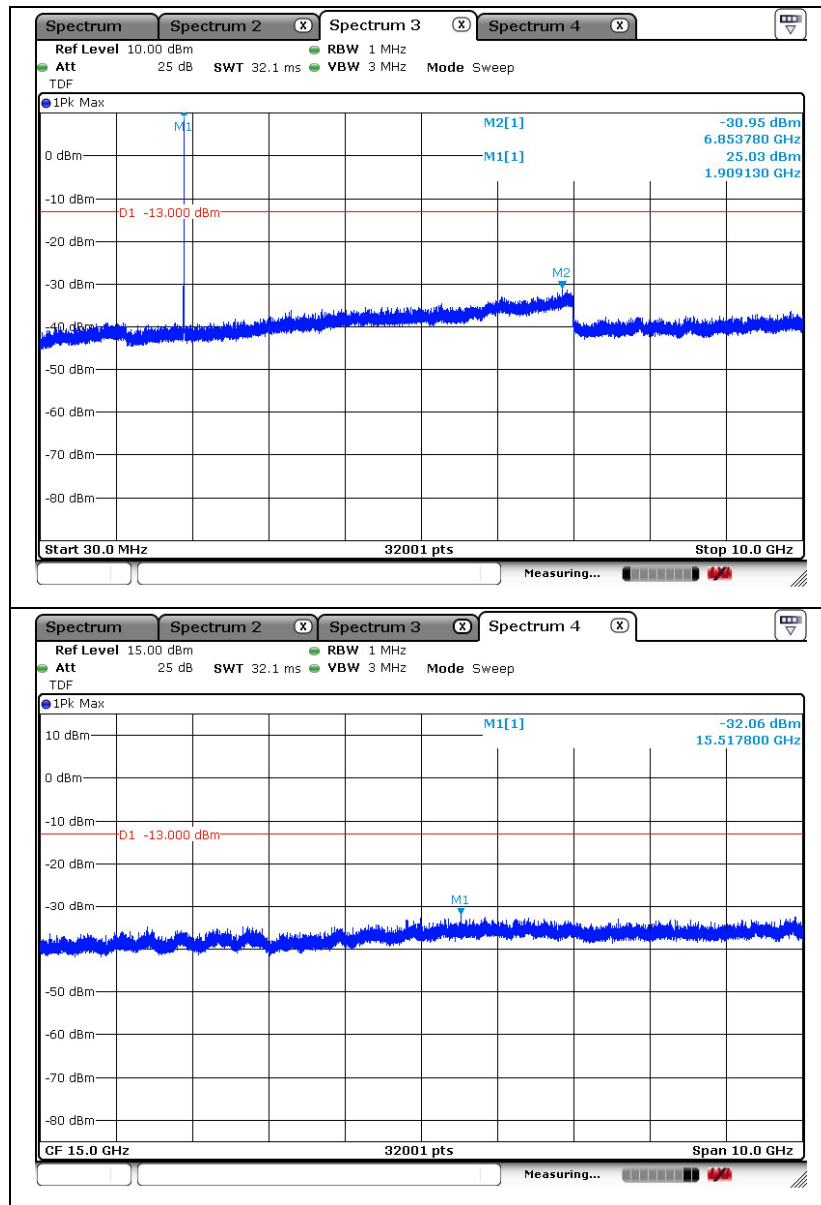

The results shown in this test report refer only to the sample(s) tested unless otherwise stated. This test report cannot be reproduced, except in full, without prior written permission of the Company. This test report does not assure KOLAS accreditation.

CDMA BC1 (EV-DO)

Low Channel

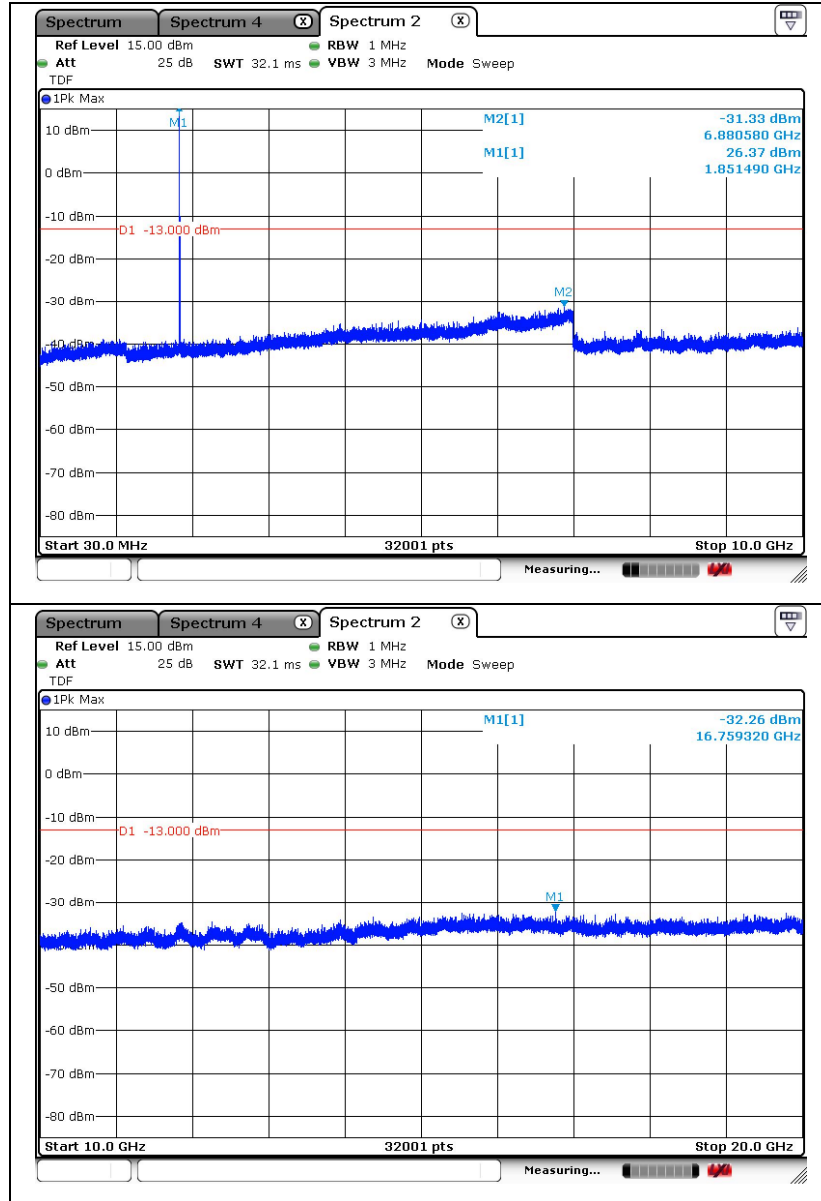

The results shown in this test report refer only to the sample(s) tested unless otherwise stated. This test report cannot be reproduced, except in full, without prior written permission of the Company. This test report does not assure KOLAS accreditation.

Middle Channel

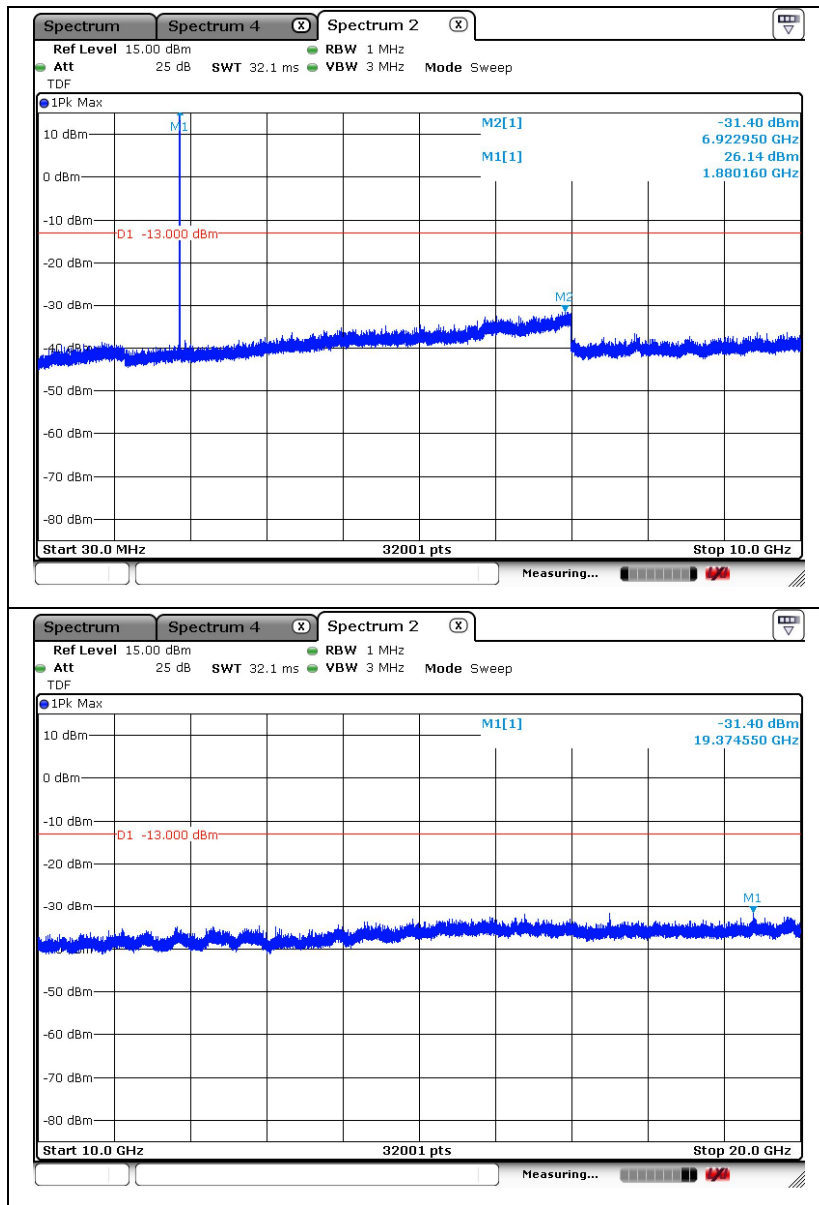

The results shown in this test report refer only to the sample(s) tested unless otherwise stated. This test report cannot be reproduced, except in full, without prior written permission of the Company. This test report does not assure KOLAS accreditation.

High Channel

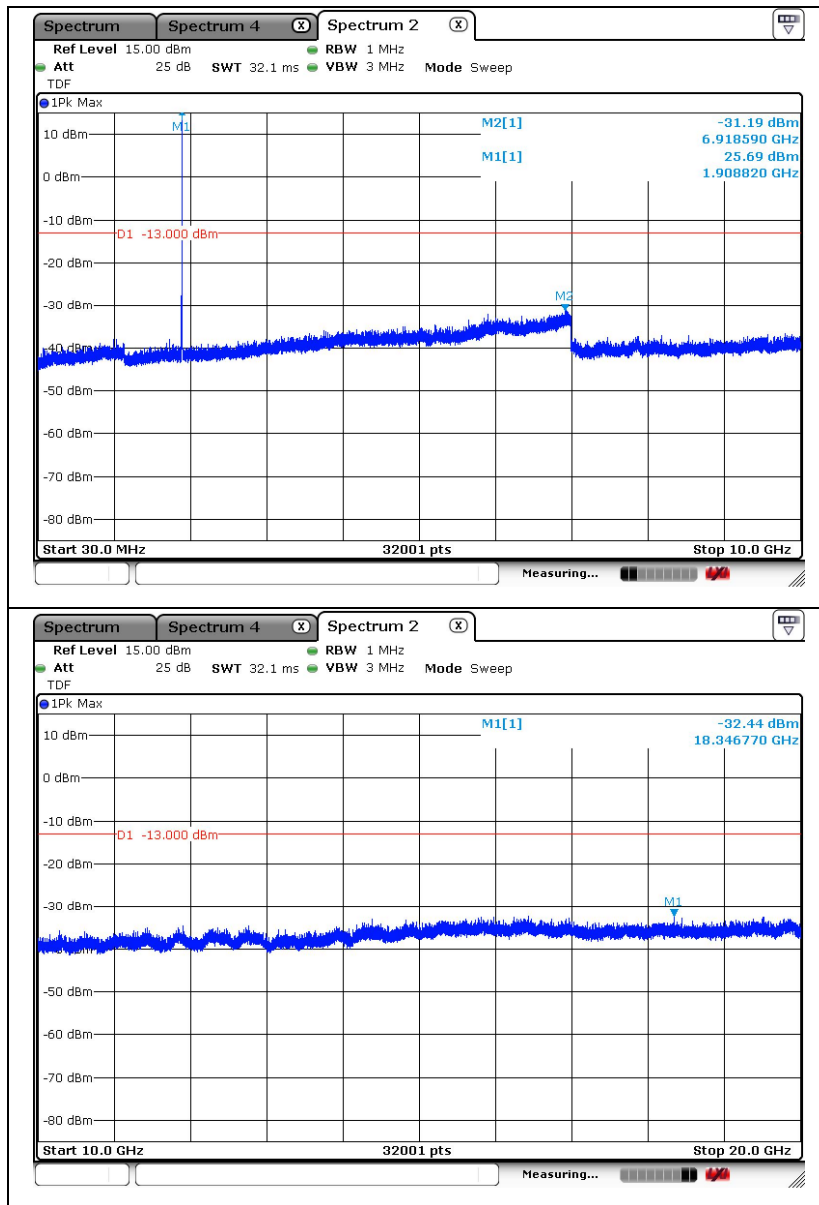

The results shown in this test report refer only to the sample(s) tested unless otherwise stated. This test report cannot be reproduced, except in full, without prior written permission of the Company. This test report does not assure KOLAS accreditation.

7. Band Edge

7.1. Limit

- §22.917(a), the power of any emission outside of the authorized operating frequency ranges must be attenuated below the transmitting power (P) by a factor of at least $43 + 10\log(P)$ dB.

- §24.238(a), the power of any emission outside of the authorized operating frequency ranges must be attenuated below the transmitting power (P) by a factor of at least $43 + 10 \log(P)$ dB.

7.2. Test Procedure

The test follows section 6.0 of FCC KDB Publication 971168 D01 v03r01.

- a. Span was set large enough so as to capture all out of band emissions near the band edge.
- b. RBW ≥ 1 % of OBW
- c. VBW $\geq 3 \times$ RBW.
- d. Detector = RMS.
- e. Trace mode = Average.
- f. Sweep time = Auto.
- g. The trace was allowed to stabilize.
- h. All path loss of frequency range was investigated and compensated to spectrum analyzer as TDF function.

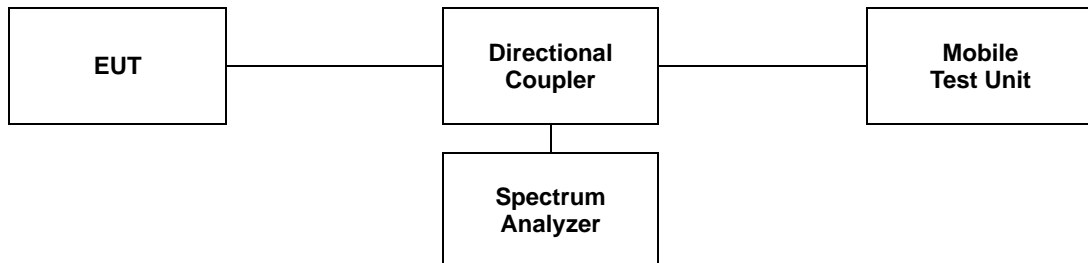

The results shown in this test report refer only to the sample(s) tested unless otherwise stated. This test report cannot be reproduced, except in full, without prior written permission of the Company. This test report does not assure KOLAS accreditation.

7.3. Test Results

Ambient temperature : (23 ± 1) °C
 Relative humidity : 47 % R.H.

CDMA BC0 (1xRTT)

Low Channel

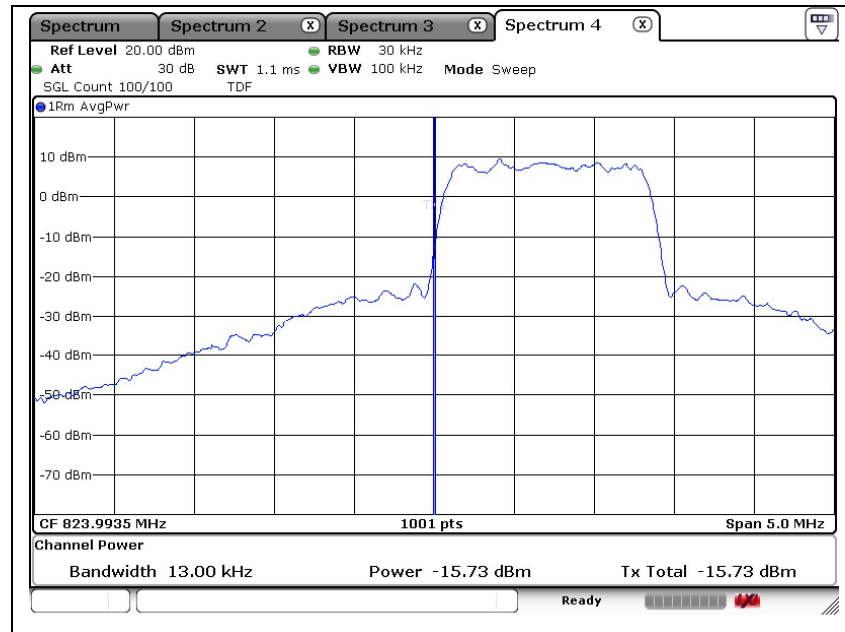

High Channel

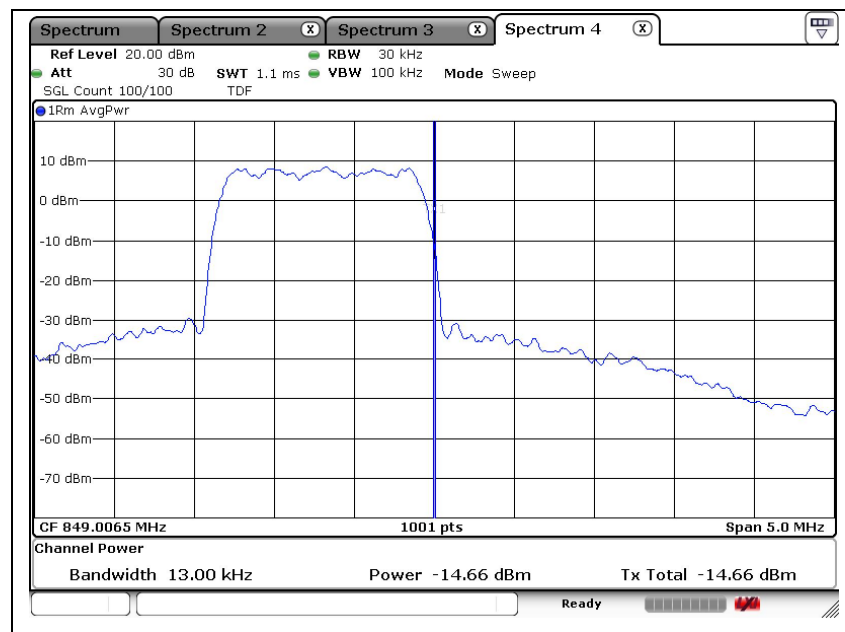

The results shown in this test report refer only to the sample(s) tested unless otherwise stated. This test report cannot be reproduced, except in full, without prior written permission of the Company. This test report does not assure KOLAS accreditation.

CDMA BC0 (EV-DO)

Low Channel

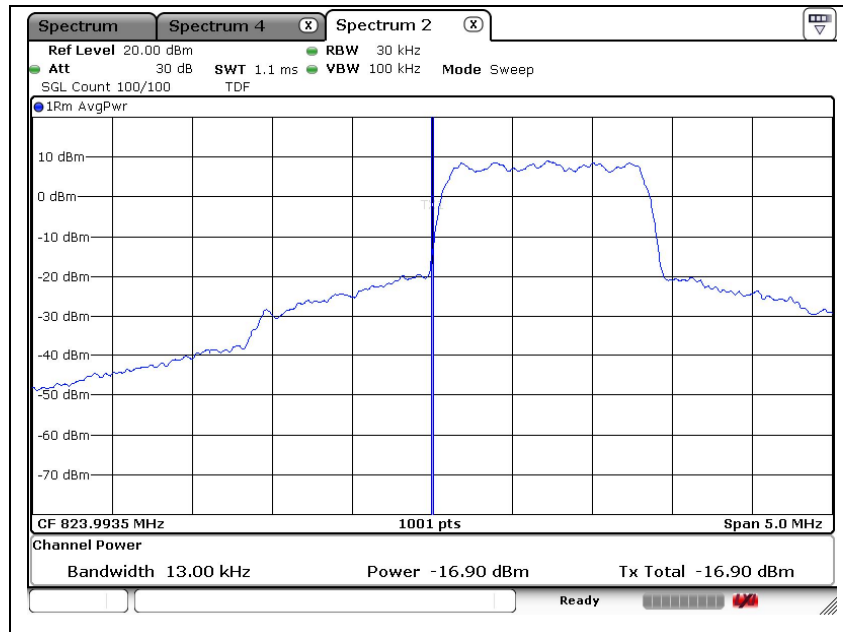

High Channel

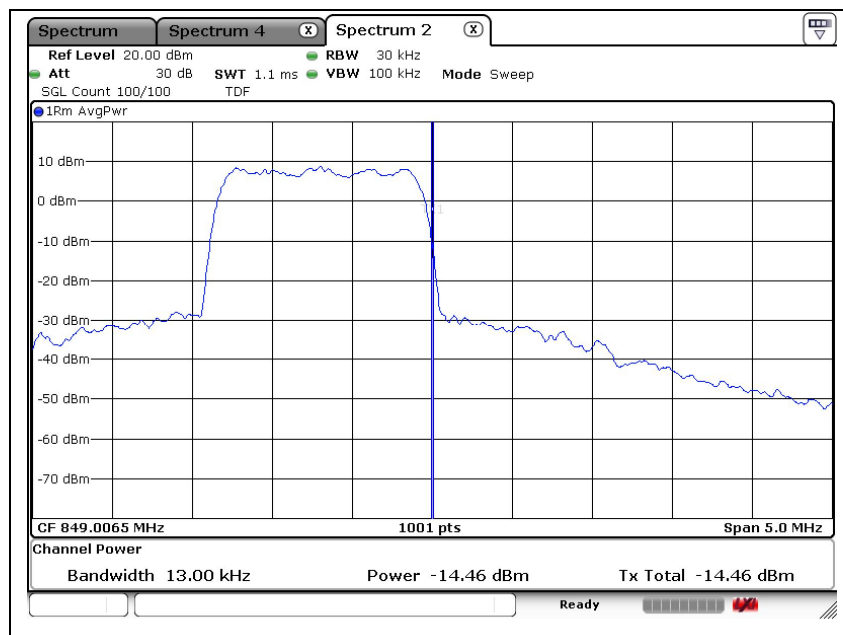

The results shown in this test report refer only to the sample(s) tested unless otherwise stated. This test report cannot be reproduced, except in full, without prior written permission of the Company. This test report does not assure KOLAS accreditation.

CDMA BC1 (1xRTT)

Low Channel

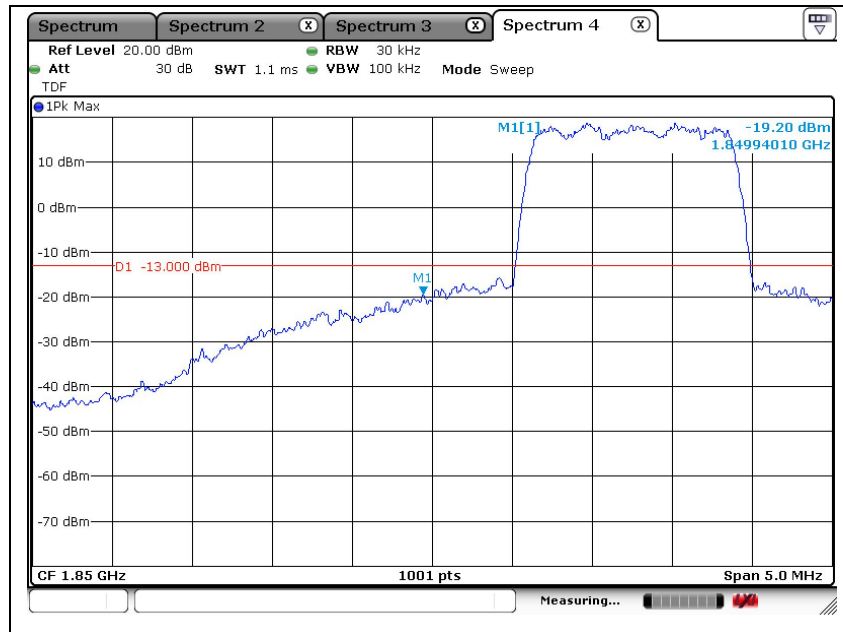

High Channel

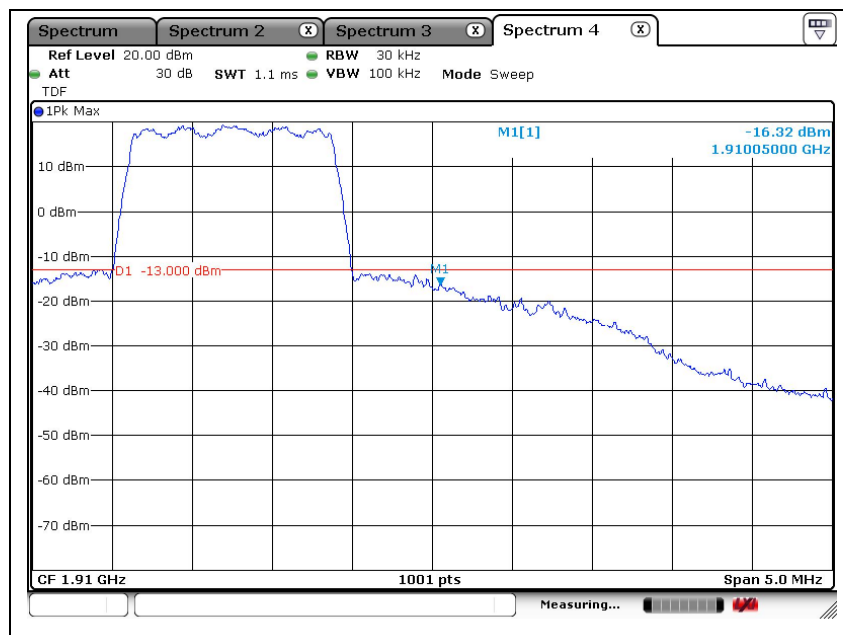

The results shown in this test report refer only to the sample(s) tested unless otherwise stated. This test report cannot be reproduced, except in full, without prior written permission of the Company. This test report does not assure KOLAS accreditation.

CDMA BC1 (EV-DO)

Low Channel

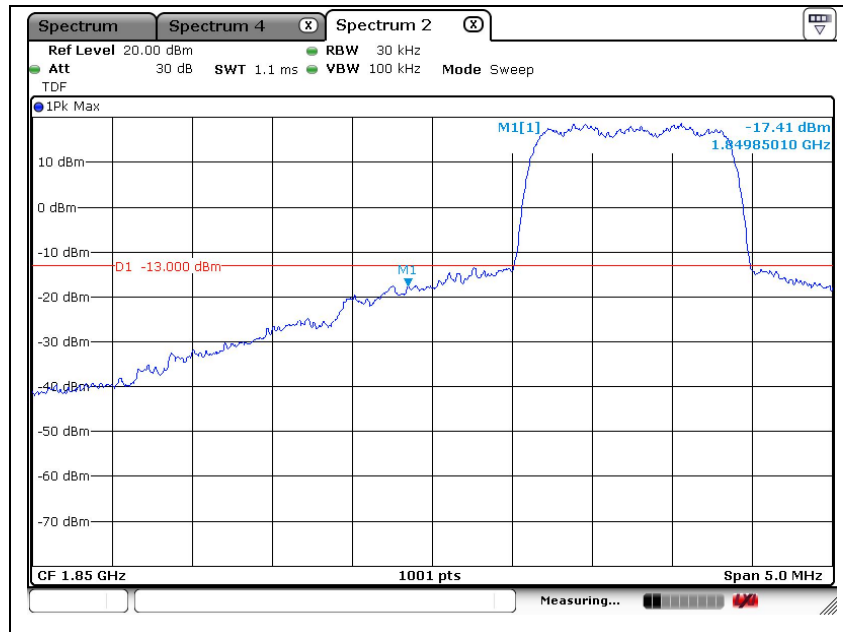

High Channel

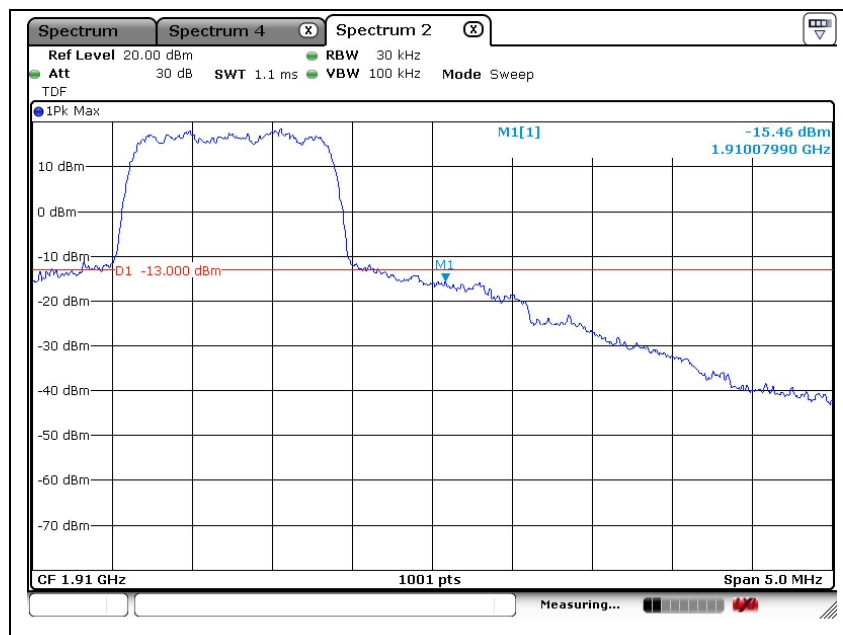

The results shown in this test report refer only to the sample(s) tested unless otherwise stated. This test report cannot be reproduced, except in full, without prior written permission of the Company. This test report does not assure KOLAS accreditation.

8. Frequency Stability

8.1. Limit

- §2.1055 (a), The frequency stability shall be measured with variation of ambient temperature as follows:

(1) From -30° to $+50^{\circ}$ centigrade for all equipment except that specified in paragraphs (a)(2) and (3) of this section.

(2) From -20° to $+50^{\circ}$ centigrade for equipment to be licensed for use in the Maritime Services under part 80 of this chapter, except for Class A, B, and S Emergency Position Indicating Radiobeacons (EPIRBS), and equipment to be licensed for use above 952 MHz at operational fixed stations in all services, stations in the Local Television Transmission Service and Point-to-Point Microwave Radio Service under part 21 of this chapter, equipment licensed for use aboard aircraft in the Aviation Services under part 87 of this chapter, and equipment authorized for use in the Family Radio Service under part 95 of this chapter.

(3) From 0° to $+50^{\circ}$ centigrade for equipment to be licensed for use in the Radio Broadcast Services under part 73 of this chapter.

- §2.1055 (d), The frequency stability shall be measured with variation of primary supply voltage as follows:

(1) Vary primary supply voltage from 85 to 115 percent of the nominal value for other than hand carried battery equipment.

(2) For hand carried, battery powered equipment, reduce primary supply voltage to the battery operating end point which shall be specified by the manufacturer.

(3) The supply voltage shall be measured at the input to the cable normally provided with the equipment, or at the power supply terminals if cables are not normally provided. Effects on frequency of transmitter keying (except for broadcast transmitters) and any heating element cycling at the nominal supply voltage and at each extreme also shall be shown.

- §22.355, the carrier frequency of each transmitter in the Public Mobile Services must be maintained within the tolerances given in Table of this section.

For Mobile devices operating in the 824 to 849 MHz band at a power level less than or equal to 3 Watts, the limit specified in Table C-1 is ± 2.5 ppm.

- §24.235, the frequency stability shall be sufficient to ensure that the fundamental emission stays within the authorized frequency block.

The results shown in this test report refer only to the sample(s) tested unless otherwise stated. This test report cannot be reproduced, except in full, without prior written permission of the Company. This test report does not assure KOLAS accreditation.

8.2. Test Procedure

1. Frequency Stability vs. Temperature: The equipment under test was connected to an external DC power supply and the RF output was connected to a Mobile Test Unit via feed-through attenuators.
2. The EUT was placed inside the temperature chamber.
3. After the temperature stabilized for approximately 20 minutes, the frequency output was recorded from Mobile Test Unit.

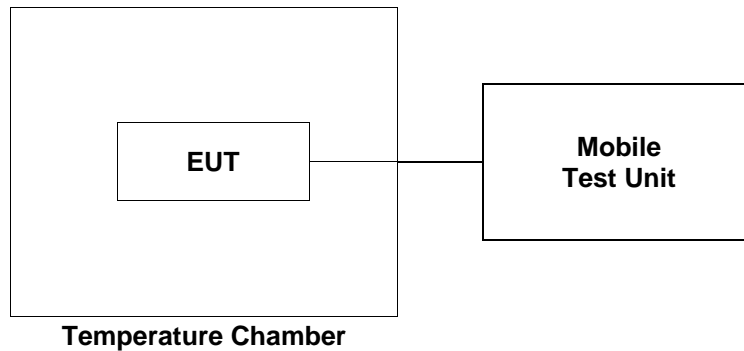

The results shown in this test report refer only to the sample(s) tested unless otherwise stated. This test report cannot be reproduced, except in full, without prior written permission of the Company. This test report does not assure KOLAS accreditation.

8.3. Test Results

Ambient temperature : (23 ± 1) °C
 Relative humidity : 47 % R.H.

CDMA BC0 1xRTT mode at middle channel

Reference Frequency: 836.52 MHz			
Frequency Stability versus Temperature			
Environment Temperature (°C)	Power Supplied (V _{dc})	Frequency Measure with Time Elapse	
		Frequency Error (Hz)	ppm
50	4.0	1	0.001 2
40		5	0.006 0
30		-2	-0.002 4
23		1	0.001 2
10		3	0.003 6
0		-5	-0.006 0
-10		4	0.004 8
-20		5	0.006 0
-30		3	0.003 6
Frequency Stability versus Power Supply			
Environment Temperature (°C)	Power Supplied (V _{dc})	Frequency Measure with Time Elapse	
		Frequency Error (Hz)	ppm
23	4.6	1	0.001 2
	3.4	-3	-0.003 6

The results shown in this test report refer only to the sample(s) tested unless otherwise stated. This test report cannot be reproduced, except in full, without prior written permission of the Company. This test report does not assure KOLAS accreditation.

CDMA BC0 EV-DO mode at middle channel

Reference Frequency: 836.52 MHz			
Frequency Stability versus Temperature			
Environment Temperature (°C)	Power Supplied (V _{dc})	Frequency Measure with Time Elapse	
		Frequency Error (Hz)	ppm
50	4.0	2	0.002 4
40		7	0.008 4
30		-1	-0.001 2
23		-4	-0.004 8
10		1	0.001 2
0		3	0.003 6
-10		3	0.003 6
-20		-1	-0.001 2
-30		-2	-0.002 4
Frequency Stability versus Power Supply			
Environment Temperature (°C)	Power Supplied (V _{dc})	Frequency Measure with Time Elapse	
		Frequency Error (Hz)	ppm
23	4.6	-2	-0.002 4
	3.4	-1	-0.001 2

The results shown in this test report refer only to the sample(s) tested unless otherwise stated. This test report cannot be reproduced, except in full, without prior written permission of the Company. This test report does not assure KOLAS accreditation.

CDMA BC1 1xRTT mode at middle channel

Reference Frequency: 1 880.00 MHz			
Frequency Stability versus Temperature			
Environment Temperature (°C)	Power Supplied (V _{dc})	Frequency Measure with Time Elapse	
		Frequency Error (Hz)	ppm
50	4.0	-5	-0.002 7
40		4	0.002 1
30		2	0.001 1
23		2	0.001 1
10		-1	-0.000 5
0		4	0.002 1
-10		3	0.001 6
-20		2	0.001 1
-30		-2	-0.001 1
Frequency Stability versus Power Supply			
Environment Temperature (°C)	Power Supplied (V _{dc})	Frequency Measure with Time Elapse	
		Frequency Error (Hz)	ppm
23	4.6	-1	-0.000 5
	3.4	4	0.002 1

The results shown in this test report refer only to the sample(s) tested unless otherwise stated. This test report cannot be reproduced, except in full, without prior written permission of the Company. This test report does not assure KOLAS accreditation.

CDMA BC1 EV-DO mode at middle channel

Reference Frequency: 1 880.00 MHz			
Frequency Stability versus Temperature			
Environment Temperature (°C)	Power Supplied (V _{dc})	Frequency Measure with Time Elapse	
		Frequency Error (Hz)	ppm
50	4.0	4	0.002 1
40		-4	-0.002 1
30		-3	-0.001 6
23		-1	-0.000 5
10		3	0.001 6
0		2	0.001 1
-10		-1	-0.000 5
-20		-3	-0.001 6
-30		-2	-0.001 1
Frequency Stability versus Power Supply			
Environment Temperature (°C)	Power Supplied (V _{dc})	Frequency Measure with Time Elapse	
		Frequency Error (Hz)	ppm
23	4.6	2	0.001 1
	3.4	4	0.002 1

- End of the Test Report -

The results shown in this test report refer only to the sample(s) tested unless otherwise stated. This test report cannot be reproduced, except in full, without prior written permission of the Company. This test report does not assure KOLAS accreditation.