

TEST REPORT

of

FCC Part 22 Subpart H and Part 24 Subpart E

FCC ID: YZP-VL3000

Equipment Under Test : Telematics Modem
Model Name : LTD-VL3000
Applicant : LG Innotek Co., Ltd.
Manufacturer : LG Innotek Co., Ltd.
Date of Receipt : 2017.09.18
Date of Test(s) : 2017.10.12 ~ 2017.10.26
Date of Issue : 2017.11.09

In the configuration tested, the EUT complied with the standards specified above.

Tested By:



Jinhyoung Cho

Date:

2017.11.09

Technical
Manager:



Jungmin Yang

Date:

2017.11.09

The results shown in this test report refer only to the sample(s) tested unless otherwise stated. This test report cannot be reproduced, except in full, without prior written permission of the Company. This test report does not assure KOLAS accreditation.

TABLE OF CONTENTS

	Page
1. General Information -----	3
2. RF Radiated Output Power & Spurious Radiated Emission -----	7
3. Conducted Output Power -----	17
4. Occupied Bandwidth 99 % -----	19
5. Peak-Average Ratio -----	29
6. Spurious Emissions at Antenna Terminal -----	39
7. Band Edge -----	48
8. Frequency Stability -----	53

The results shown in this test report refer only to the sample(s) tested unless otherwise stated. This test report cannot be reproduced, except in full, without prior written permission of the Company. This test report does not assure KOLAS accreditation.

1. General information

1.1. Testing laboratory

SGS Korea Co., Ltd. (Gunpo Laboratory)

- Wireless Div. 2FL, 10-2, LS-ro 182beon-gil, Gunpo-si, Gyeonggi-do, Korea, 15807

All SGS services are rendered in accordance with the applicable SGS conditions of service available on request and accessible at <http://www.sgs.com/en/Terms-and-Conditions.aspx>.

Telephone : +82 31 688 0901

FAX : +82 31 688 0921

1.2. Details of applicant

Applicant : LG Innotek Co., Ltd.

Address : 55, Hanyangdaehak-ro, Sangnok-gu, Ansan-si, Gyeonggido, 15588, Rep. of Korea

Contact Person : Eum, Ki-Hun

Phone No. : +82 10 2701 4217

1.3. Details of manufacturer

Company : LG Innotek Co., Ltd.

Address : 26, Hanamsandan 5beon-ro, Gwangsan-gu, Gwangju, 62229, Rep. of Korea

1.4. Description of EUT

Kind of Product	Telematics Modem
Model Name	LTD-VL3000
Power Supply	DC 4.0 V
Rated Power	CDMA BC0, BC1: 24 dB m LTE Band 2, 4, 5, 13: 23 dB m
Frequency Range	CDMA BC0: 824 MHz ~ 849 MHz CDMA BC1: 1 850 MHz ~ 1 910 MHz LTE Band 2: 1 850 MHz ~ 1 910 MHz LTE Band 4: 1 710 MHz ~ 1 755 MHz LTE Band 5: 824 MHz ~ 849 MHz LTE Band 13: 777 MHz ~ 787 MHz
Emission Designator	CDMA BC0: 1M28F9W CDMA BC1: 1M27F9W LTE Band 2 (1.4 MHz): 1M10G7D (QPSK) / 1M10W7D (16QAM) LTE Band 2 (3 MHz): 2M71G7D (QPSK) / 2M72W7D (16QAM) LTE Band 2 (5 MHz): 4M52G7D (QPSK) / 4M54W7D (16QAM) LTE Band 2 (10 MHz): 8M94G7D (QPSK) / 8M94W7D (16QAM) LTE Band 2 (15 MHz): 13M5G7D (QPSK) / 13M5W7D (16QAM) LTE Band 2 (20 MHz): 17M9G7D (QPSK) / 17M9W7D (16QAM)

The results shown in this test report refer only to the sample(s) tested unless otherwise stated. This test report cannot be reproduced, except in full, without prior written permission of the Company. This test report does not assure KOLAS accreditation.

Emission Designator	LTE Band 4 (1.4 MHz): 1M10G7D (QPSK) / 1M10W7D (16QAM) LTE Band 4 (3 MHz): 2M71G7D (QPSK) / 2M71W7D (16QAM) LTE Band 4 (5 MHz): 4M53G7D (QPSK) / 4M53W7D (16QAM) LTE Band 4 (10 MHz): 8M97G7D (QPSK) / 8M94W7D (16QAM) LTE Band 4 (15 MHz): 13M5G7D (QPSK) / 13M5W7D (16QAM) LTE Band 4 (20 MHz): 17M9G7D (QPSK) / 17M9W7D (16QAM) LTE Band 5 (1.4 MHz): 1M10G7D (QPSK) / 1M10W7D (16QAM) LTE Band 5 (3 MHz): 2M71G7D (QPSK) / 2M71W7D (16QAM) LTE Band 5 (5 MHz): 4M53G7D (QPSK) / 4M53W7D (16QAM) LTE Band 5 (10 MHz): 8M94G7D (QPSK) / 8M94W7D (16QAM) LTE Band 13 (5 MHz): 4M53G7D (QPSK) / 4M53W7D (16QAM) LTE Band 13 (10 MHz): 8M92G7D (QPSK) / 8M94W7D (16QAM)
H/W Version	R0.3
S/W Version	01D_WVZW

The results shown in this test report refer only to the sample(s) tested unless otherwise stated. This test report cannot be reproduced, except in full, without prior written permission of the Company. This test report does not assure KOLAS accreditation.

1.5. Test equipment list

Equipment	Manufacturer	Model	S/N	Cal. Date	Cal. Interval	Cal. Due
Signal Generator	Agilent	E8257D	MY51501169	Jul. 07, 2017	Annual	Jul. 07, 2018
Spectrum Analyzer	R&S	FSV30	100955	Mar. 20, 2017	Annual	Mar. 20, 2018
Mobile Test Unit	Agilent	E5515C	GB43345198	Mar. 16, 2017	Annual	Mar. 16, 2018
Power Meter	Anritsu	ML2495A	1223004	Jun. 09, 2017	Annual	Jun. 09, 2018
Power Sensor	Anritsu	MA2411B	1207272	Jun. 09, 2017	Annual	Jun. 09, 2018
Directional Coupler	KRYTAR	152613	140972	Jun. 12, 2017	Annual	Jun. 12, 2018
Temperature Chamber	ESPEC CORP.	PL-1J	15000793	Jun. 14, 2017	Annual	Jun. 14, 2018
High Pass Filter	Wainwright Instrument GmbH	WHKX10-900-1000-18000-40SS	7	Mar. 30, 2017	Annual	Mar. 30, 2018
High Pass Filter	Wainwright Instrument GmbH	WHK3.0/18G-10SS	344	May 28, 2017	Annual	May 28, 2018
High Pass Filter	Wainwright Instrument GmbH	WHKX2.2/12.75G-10SS	8	Mar. 30, 2017	Annual	Mar. 30, 2018
High Pass Filter	Wainwright Instrument GmbH	WHKX1.5/15G-6SS	4	Jun. 14, 2017	Annual	Jun. 14, 2018
DC Power Supply	Agilent	U8002A	MY50060028	Mar. 16, 2017	Annual	Mar. 16, 2018
Preamplifier	H.P.	8447F	2944A03909	Aug. 11, 2017	Annual	Aug. 11, 2018
Preamplifier	R&S	SCU 18	10117	Apr. 08, 2017	Annual	Apr. 08, 2018
Preamplifier	MITEQ Inc.	JS44-18004000-35-8P	1546891	May 15, 2017	Annual	May 15, 2018
Test Receiver	R&S	ESU26	100109	Feb. 17, 2017	Annual	Feb. 17, 2018
Bilog Antenna	SCHWARZBECK MESSELEKTRONIK	VULB9163	437	Oct. 21, 2016	Biennial	Oct. 21, 2018
Horn Antenna	R&S	HF906	100326	Feb. 01, 2016	Biennial	Feb. 01, 2018
Horn Antenna	SCHWARZBECK MESSELEKTRONIK	BBHA9170	BBHA9170223	Aug. 25, 2016	Biennial	Aug. 25, 2018
Antenna Master	Innco systems GmbH	MM4000	N/A	N.C.R.	N/A	N.C.R.
Turn Table	Innco systems GmbH	DS 1200S	N/A	N.C.R.	N/A	N.C.R.
Controller	Innco systems GmbH	CONTROLLER CO3000-4P	CO3000/963/38330516/L	N.C.R.	N/A	N.C.R.
Anechoic Chamber	SY Corporation	L x W x H (9.6 m x 6.4 m x 6.4 m)	N/A	N.C.R.	N/A	N.C.R.
Coaxial Cable	SUCOFLEX	104 (3 m)	MY3258414	N.C.R.	N/A	N.C.R.
Coaxial Cable	SUCOFLEX	104 (10 m)	MY3145814	N.C.R.	N/A	N.C.R.

► Support equipment

Description	Manufacturer	Model	Serial Number
N/A	-	-	-

The results shown in this test report refer only to the sample(s) tested unless otherwise stated. This test report cannot be reproduced, except in full, without prior written permission of the Company. This test report does not assure KOLAS accreditation.

1.6. Summary of test results

The EUT has been tested according to the following specifications:

APPLIED STANDARD: FCC Part 2, 22 and 24		
Section in FCC part	Test Item	Result
§2.1046 §22.913(a)(5) §24.232(c)	RF Radiated Output Power	Complied
§2.1053 §22.917(a) §24.238(a)	Spurious Radiated Emission	Complied
§2.1046	Conducted Output Power	Complied
§2.1049	Occupied Bandwidth	Complied
§22.913(d) §24.232(d)	Peak-Average Ratio	Complied
§2.1051 §22.917(a) §24.238(a)	Spurious Emission at Antenna Terminal	Complied
§22.917(a) §24.238(a)	Band Edge	Complied
§2.1055 §22.355 §24.235	Frequency Stability	Complied

1.7. Test report revision

Revision	Report number	Date of Issue	Description
0	F690501/RF-RTL011908	2017.10.26	Initial
1	F690501/RF-RTL011908-1	2017.11.09	Listed coaxial cable in the equipment list

1.8. Sample calculation for offset

Where relevant, the following sample calculation is provided:

1.8.1. Conducted test

Offset value (dB) = Directional Coupler (dB) + Cable loss (dB)

1.8.2. Radiation test

E.R.P. & E.I.R.P. = [S.G level + Amp.] (dB m) - Cable loss (dB) + Ant. gain (dB d/dB i)

The results shown in this test report refer only to the sample(s) tested unless otherwise stated. This test report cannot be reproduced, except in full, without prior written permission of the Company. This test report does not assure KOLAS accreditation.

2. RF Radiated Output Power & Spurious Radiated Emission

2.1. Test setup

The diagram below shows the test setup that is utilized to make the measurements for emission from 30 MHz to 1 GHz.

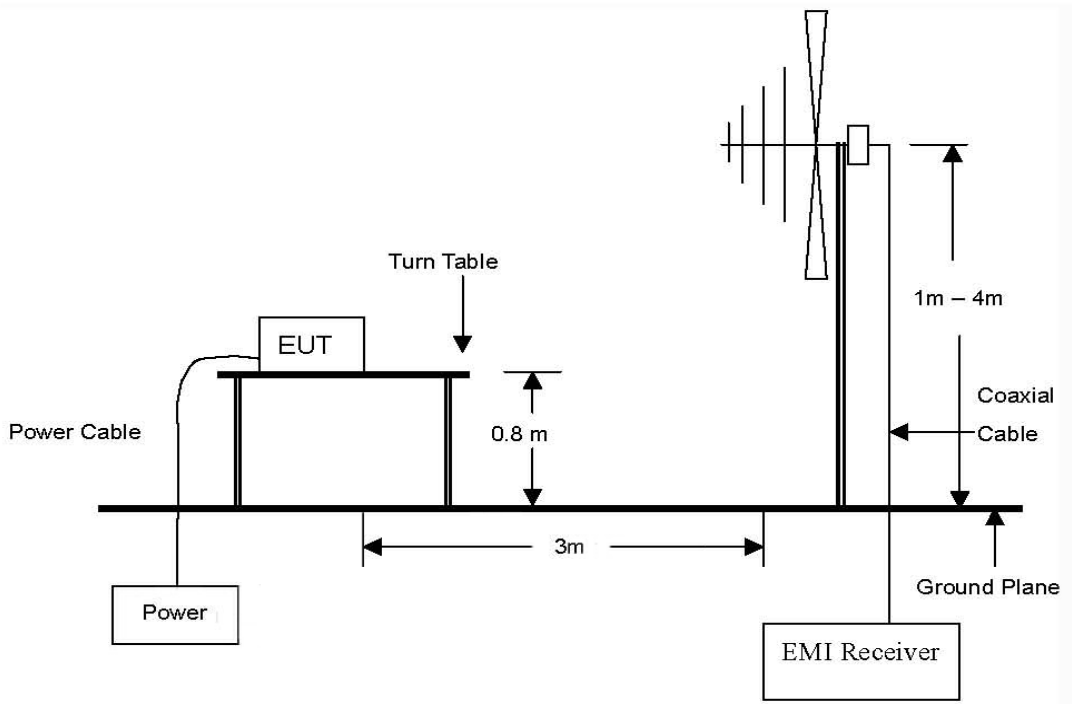

The diagram below shows the test setup that is utilized to make the measurements for emission from 1 GHz to 20 GHz.

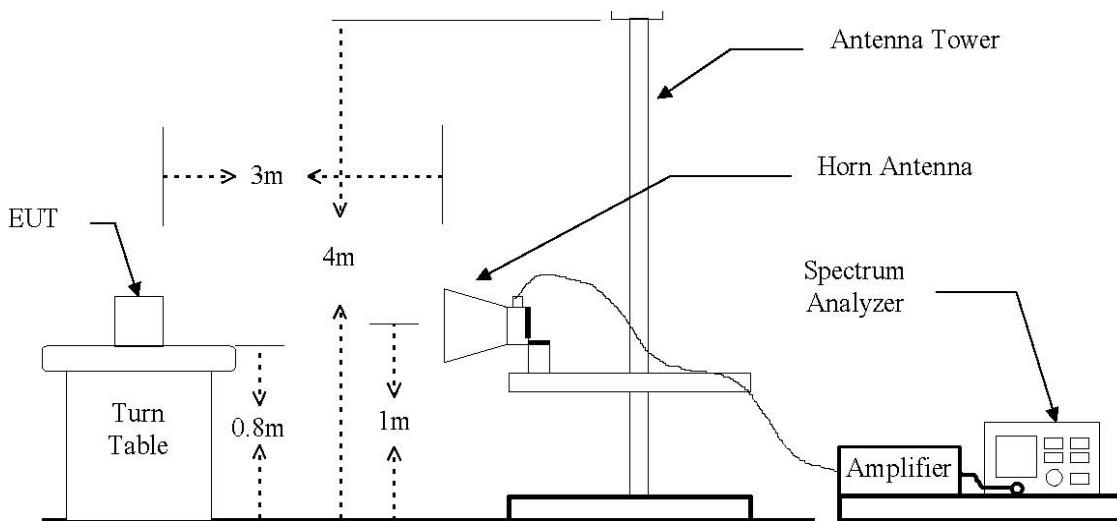

The results shown in this test report refer only to the sample(s) tested unless otherwise stated. This test report cannot be reproduced, except in full, without prior written permission of the Company. This test report does not assure KOLAS accreditation.

The diagram below shows the test setup for substituted method.

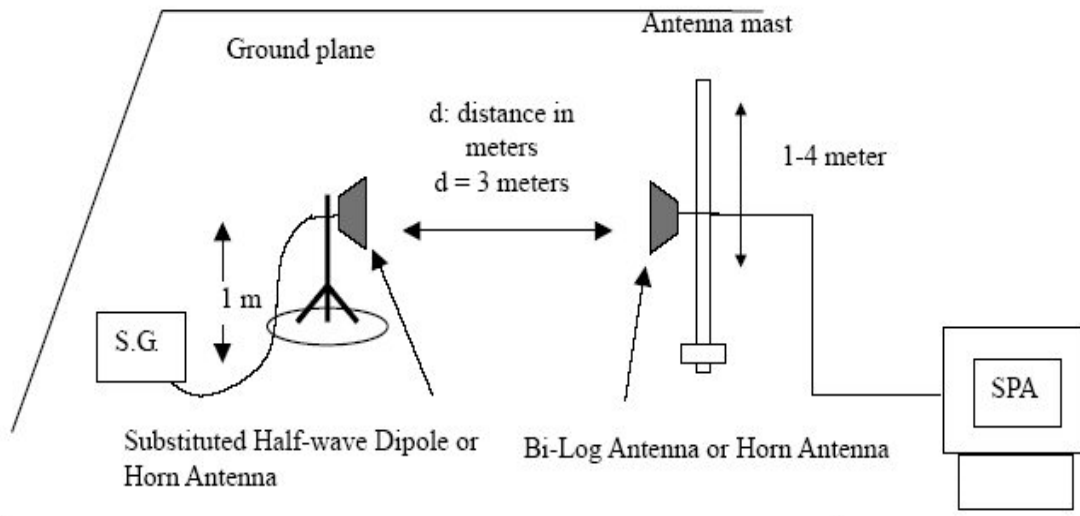

The results shown in this test report refer only to the sample(s) tested unless otherwise stated. This test report cannot be reproduced, except in full, without prior written permission of the Company. This test report does not assure KOLAS accreditation.

2.2. Limit

2.2.1. Limit of radiated output power

- §22.913(a)(5), the ERP of mobile transmitters and auxiliary test transmitters must not exceed 7 watts.

- §24.232(c), mobile and portable stations are limited to 2 watts EIRP and the equipment must employ a means to limiting power to the minimum necessary for successful communications.

2.2.2. Limit of spurious radiated emission

- §22.917(a), the power of any emission outside of the authorized operating frequency ranges must be attenuated below the transmitting power (P) by a factor of at least $43 + 10\log(P)$ dB.

- §24.238(a), the power of any emission outside of the authorized operating frequency ranges must be attenuated below the transmitting power (P) by a factor of at least $43 + 10 \log(P)$ dB.

The results shown in this test report refer only to the sample(s) tested unless otherwise stated. This test report cannot be reproduced, except in full, without prior written permission of the Company. This test report does not assure KOLAS accreditation.

2.3. Test procedure: Based on ANSI/TIA 603D: 2010

1. On a test site, the EUT shall be placed at 80 cm height on a turn table, and in the position close to normal use as declared by the applicant.
2. The test antenna shall be oriented initially for vertical polarization located 3 m from EUT to correspond to the fundamental frequency of the transmitter.
3. The output of the test antenna shall be connected to the measuring receiver and the peak detector is used for the measurement.
4. The maximized power level is recorded using the spectrum analyzer "Channel Power" function with the integration band set to the emissions occupied bandwidth, RBW = 1-5 % of the OBW (not to exceed 1 MHz), VBW $\geq 3 \times$ RBW, Detector = power averaging (rms), sweep time = auto, trace average at least 100 traces in power averaging (rms) mode, per the guidelines of KDB Publication 971168 D01 v02r02.
5. Radiated spurious emissions measurement method was set as follows:
RBW = 100 kHz for emissions below 1 GHz and 1 MHz for emissions above 1 GHz, VBW $\geq 3 \times$ RBW, Detector = Peak, trace mode = max hold, per the guidelines of KDB Publication 971168 D01 v02r02.
6. The transmitter shall be switched on, the measuring receiver shall be tuned to the frequency of the transmitter under test.
7. The test antenna shall be raised and lowered through the specified range of height until the maximum signal level is detected by the measuring receiver.
8. The transmitter shall be rotated through 360° in the horizontal plane, until the maximum signal level is detected by the measuring receiver.
9. The test antenna shall be raised and lowered again through the specified range of height until the maximum signal level is detected by the measuring receiver.
10. The maximum signal level detected by the measuring receiver shall be noted.
11. The EUT was replaced by half-wave dipole (1 GHz below) or horn antenna (1 GHz above) connected to a signal generator.
12. In necessary, the input attenuator setting on the measuring receiver shall be adjusted in order to increase the sensitivity of the measuring receiver.
13. The test antenna shall be raised and lowered through the specified range of height to ensure that the maximum signal is received.
14. The input signal to the substitution antenna shall be adjusted to the level that produces a level detected by the measuring receiver, which is equal to the level noted while the transmitter radiated power was measured, corrected for the change of input attenuator setting of the measuring receiver.
15. The input level to the substitution antenna shall be recorded as power level in dBm, corrected for any change of input attenuator setting of the measuring receiver.
16. The measurement shall be repeated with the test antenna and the substitution antenna orientated for horizontal polarization.

The results shown in this test report refer only to the sample(s) tested unless otherwise stated. This test report cannot be reproduced, except in full, without prior written permission of the Company. This test report does not assure KOLAS accreditation.

2.4. Test result for RF radiated output power

Ambient temperature : (23 ± 1) °C
 Relative humidity : 47 % R.H.

CDMA BC0

1xRTT

Frequency (MHz)	Ant. Pol. (H/V)	S.G level + Amp. (dB m)	Cable loss (dB)	Ant. gain (dB d)	E.R.P.	
					(dB m)	(mW)
824.70	H	29.42	3.26	-4.93	21.23	132.74
824.70	V	19.93	3.26	-4.93	11.74	14.93
836.52	H	29.19	3.45	-5.15	20.59	114.55
836.52	V	19.90	3.45	-5.15	11.30	13.49
848.31	H	27.60	3.52	-4.09	19.99	99.77
848.31	V	20.63	3.52	-4.09	13.02	20.04

EV-DO

Frequency (MHz)	Ant. Pol. (H/V)	S.G level + Amp. (dB m)	Cable loss (dB)	Ant. gain (dB d)	E.R.P.	
					(dB m)	(mW)
824.70	H	27.19	3.26	-4.93	19.00	79.43
824.70	V	20.87	3.26	-4.93	12.68	18.54
836.52	H	28.01	3.45	-5.15	19.41	87.30
836.52	V	20.82	3.45	-5.15	12.22	16.67
848.31	H	28.82	3.52	-4.09	21.21	132.13
848.31	V	19.92	3.52	-4.09	12.31	17.02

The results shown in this test report refer only to the sample(s) tested unless otherwise stated. This test report cannot be reproduced, except in full, without prior written permission of the Company. This test report does not assure KOLAS accreditation.

CDMA BC1
1xRTT

Frequency (MHz)	Ant. Pol. (H/V)	S.G level + Amp. (dB m)	Cable loss (dB)	Ant. gain (dB i)	E.I.R.P.	
					(dB m)	(mW)
1 851.25	H	20.45	4.33	8.53	24.65	291.74
1 851.25	V	21.19	4.33	8.53	25.39	345.94
1 880.00	H	19.56	4.34	8.63	23.85	242.66
1 880.00	V	18.22	4.34	8.63	22.51	178.24
1 908.75	H	19.37	4.36	8.60	23.61	229.61
1 908.75	V	17.22	4.36	8.60	21.46	139.96

EV-DO

Frequency (MHz)	Ant. Pol. (H/V)	S.G level + Amp. (dB m)	Cable loss (dB)	Ant. gain (dB i)	E.I.R.P.	
					(dB m)	(mW)
1 851.25	H	20.40	4.33	8.53	24.60	288.40
1 851.25	V	21.07	4.33	8.53	25.27	336.51
1 880.00	H	19.51	4.34	8.63	23.80	239.88
1 880.00	V	18.64	4.34	8.63	22.93	196.34
1 908.75	H	19.12	4.36	8.60	23.36	216.77
1 908.75	V	17.47	4.36	8.60	21.71	148.25

Remark:

1. E.R.P. & E.I.R.P. = [S.G level + Amp.] (dB m) - Cable loss (dB) + Ant. gain (dB d/dB i)
2. This device was tested under all data rates, and modulations.
3. The data reported in the table above was measured in worst case.

The results shown in this test report refer only to the sample(s) tested unless otherwise stated. This test report cannot be reproduced, except in full, without prior written permission of the Company. This test report does not assure KOLAS accreditation.

2.5. Spurious radiated emission

- Measured output Power: 21.23 dB m = 0.132 7 W
- Modulation Signal: CDMA BC0
- Distance: 3 meters
- Limit: $43 + 10\log_{10}(W) = 34.23$ dB c

1xRTT

Frequency (MHz)	Ant. Pol. (H/V)	S.G level + Amp. (dB m)	Cable loss (dB)	Ant. gain (dB d)	E.R.P. (dB m)	dB c	Margin (dB)
Low Channel (824.70 MHz)							
1 650.21	H	-55.30	4.01	6.00	-53.31	74.54	-40.31
1 649.19	V	-58.75	4.01	5.99	-56.77	78.00	-43.77
Middle Channel (836.52 MHz)							
1 673.46	H	-56.06	4.06	6.18	-53.94	75.17	-40.94
1 673.70	V	-57.97	4.06	6.18	-55.85	77.08	-42.85
High Channel (848.31 MHz)							
1 697.04	H	-57.12	4.11	6.36	-54.87	76.10	-41.87
1 697.12	V	-58.21	4.11	6.36	-55.96	77.19	-42.96

The results shown in this test report refer only to the sample(s) tested unless otherwise stated. This test report cannot be reproduced, except in full, without prior written permission of the Company. This test report does not assure KOLAS accreditation.

- Measured output Power: 21.21 dB m = 0.132 1 W
- Modulation Signal: CDMA BC0
- Distance: 3 meters
- Limit: $43 + 10\log_{10}(W) = 34.21$ dB c

EV-DO

Frequency (MHz)	Ant. Pol. (H/V)	S.G level + Amp. (dB m)	Cable loss (dB)	Ant. gain (dB d)	E.R.P. (dB m)	dB c	Margin (dB)
Low Channel (824.70 MHz)							
1 649.60	H	-56.44	4.01	6.00	-54.45	75.66	-41.45
1 649.31	V	-60.18	4.01	6.00	-58.19	79.40	-45.19
Middle Channel (836.52 MHz)							
1 672.51	H	-54.08	4.06	6.17	-51.97	73.18	-38.97
1 673.36	V	-55.55	4.06	6.18	-53.43	74.64	-40.43
High Channel (848.31 MHz)							
1 697.04	H	-54.44	4.11	8.51	-50.04	71.25	37.04
1 696.61	V	-50.95	4.11	8.50	-46.56	67.77	33.56

The results shown in this test report refer only to the sample(s) tested unless otherwise stated. This test report cannot be reproduced, except in full, without prior written permission of the Company. This test report does not assure KOLAS accreditation.

- Measured output Power: 25.39 dB m = 0.345 9 W
- Modulation Signal: CDMA BC1
- Distance: 3 meters
- Limit: $43 + 10\log_{10}(W) = 38.39$ dB c

1xRTT

Frequency (MHz)	Ant. Pol. (H/V)	S.G level + Amp. (dB m)	Cable loss (dB)	Ant. gain (dB i)	E.I.R.P. (dB m)	dB c	Margin (dB)
Low Channel (1 851.25 MHz)							
3 702.34	H	-42.95	5.97	9.07	-39.85	65.24	-26.85
3 701.94	V	-52.42	5.97	9.07	-49.32	74.71	-36.32
5 553.12	H	-51.26	7.53	10.63	-48.16	73.55	-35.16
5 552.74	V	-49.20	7.53	10.63	-46.10	71.49	-33.10
Middle Channel (1 880.00 MHz)							
3 759.46	H	-51.10	6.26	9.12	-48.24	73.63	-35.24
3 759.57	V	-53.72	6.26	9.12	-50.86	76.25	-37.86
5 640.14	H	-50.79	7.64	10.91	-47.52	72.91	-34.52
5 641.01	V	-48.52	7.65	10.91	-45.26	70.65	-32.26
High Channel (1 908.75 MHz)							
3 816.63	H	-52.12	6.51	9.15	-49.48	74.87	-36.48
3 817.50	V	-52.26	6.51	9.15	-49.62	75.01	-36.62
5 727.24	H	-51.90	7.86	11.27	-48.49	73.88	-35.49
5 726.30	V	-47.85	7.86	11.27	-44.44	69.83	-31.44

The results shown in this test report refer only to the sample(s) tested unless otherwise stated. This test report cannot be reproduced, except in full, without prior written permission of the Company. This test report does not assure KOLAS accreditation.

- Measured output Power: 25.27 dB m = 0.336 5 W
- Modulation Signal: CDMA BC1
- Distance: 3 meters
- Limit: $43 + 10\log_{10}(W) = 38.27$ dB c

EV-DO

Frequency (MHz)	Ant. Pol. (H/V)	S.G level + Amp. (dB m)	Cable loss (dB)	Ant. gain (dB i)	E.I.R.P. (dB m)	dB c	Margin (dB)
Low Channel (1 851.25 MHz)							
3 702.68	H	-41.60	5.97	9.07	-38.50	63.77	-25.50
3 702.53	V	-51.92	5.97	9.07	-48.82	74.09	-35.82
5 552.63	H	-49.52	7.53	10.63	-46.42	71.69	-33.42
5 554.78	V	-50.29	7.53	10.63	-47.19	72.46	-34.19
Middle Channel (1 880.00 MHz)							
3 759.91	H	-50.74	6.26	9.12	-47.88	73.15	-34.88
3 759.64	V	-51.20	6.26	9.12	-48.34	73.61	-35.34
5 641.07	H	-50.45	7.65	10.91	-47.19	72.46	-34.19
5 639.19	V	-48.67	7.64	10.90	-45.41	70.68	-32.41
High Channel (1 908.75 MHz)							
3 817.51	H	-49.78	6.51	9.15	-47.14	72.41	-34.14
3 817.09	V	-48.96	6.51	9.15	-46.32	71.59	-33.32
5 726.10	H	-53.23	7.86	11.27	-49.82	75.09	-36.82
5 726.17	V	-46.51	7.86	11.27	-43.10	68.37	-30.10

Remark:

1. E.R.P. & E.I.R.P. = [S.G level + Amp.] (dB m) - Cable loss (dB) + Ant. gain (dB d/dB i)
2. This device was tested under all data rates, and modulations.
3. The data reported in the table above was measured in worst case.

The results shown in this test report refer only to the sample(s) tested unless otherwise stated. This test report cannot be reproduced, except in full, without prior written permission of the Company. This test report does not assure KOLAS accreditation.

3. Conducted Output Power

3.1. Limit

CFR 47, Section FCC §2.1046.

3.2. Test Procedure

Output power shall be measured at the RF output terminals for all configurations.

1. The RF output of the transmitter was connected to the input of the mobile test unit in order to establish communication with the EUT.
2. The EUT was set up for the max. output power with pseudo random data modulation by using mobile test unit parameters.
3. The measurement performed using a wideband RF power meter.
4. This EUT was tested under all configurations and the highest power was investigated and reported.

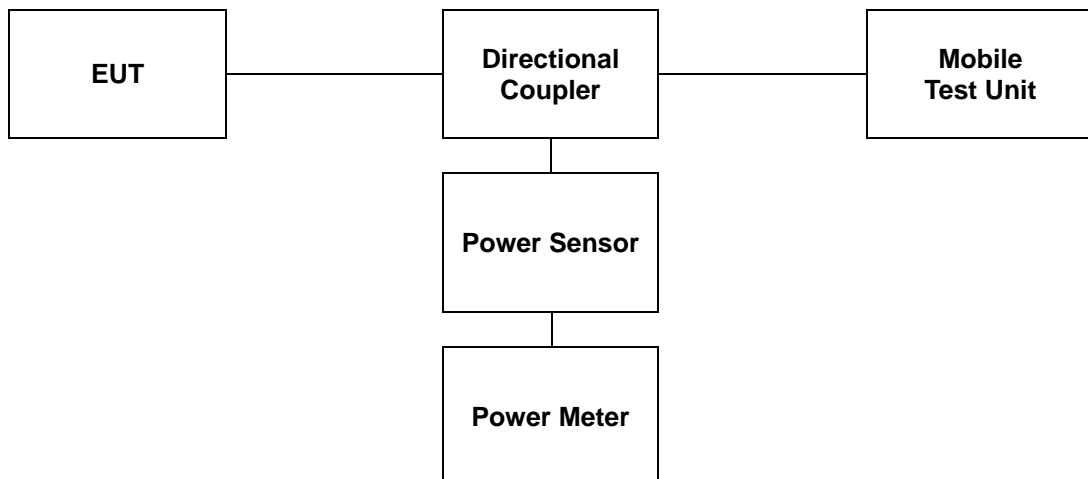

The results shown in this test report refer only to the sample(s) tested unless otherwise stated. This test report cannot be reproduced, except in full, without prior written permission of the Company. This test report does not assure KOLAS accreditation.

3.3. Test Result

Ambient temperature : (23 ± 1) °C
 Relative humidity : 47 % R.H.

1xRTT

Radio Configuration	Service Option	Band BC0 (dB m)			Band BC1 (dB m)		
		824.70	836.52	848.31	1 851.25	1 880.00	1 908.75
RC1 (Fwd1, Rvs1)	2 (Loopback)	22.76	22.82	22.62	23.98	24.12	24.02
	55 (Loopback)	22.79	22.82	22.67	23.97	24.14	24.01
RC2 (Fwd2, Rvs2)	9 (Loopback)	22.66	22.86	22.63	24.05	24.01	23.94
	55 (Loopback)	22.76	22.85	22.65	24.03	24.14	23.99
RC3 (Fwd3, Rvs3)	2 (Loopback)	22.84	22.87	22.66	24.08	24.16	23.95
	55 (Loopback)	22.80	22.85	22.64	24.04	24.18	24.02
	32 (+F-SCH)	22.82	22.92	22.72	23.98	24.16	23.97
	32 (+SCH)	22.83	22.90	22.66	24.00	24.11	24.05
RC4 (Fwd4, Rvs3)	2 (Loopback)	22.88	22.91	22.65	24.04	24.14	24.07
	55 (Loopback)	22.81	22.94	22.73	24.02	24.20	24.04
	32 (+F-SCH)	22.83	22.89	22.66	24.07	24.14	24.08
	32 (+SCH)	22.78	22.87	22.68	24.02	24.20	24.01
RC5 (Fwd5, Rvs4)	9 (Loopback)	22.82	22.92	22.70	24.01	24.18	24.03
	55 (Loopback)	22.81	22.90	22.63	24.03	24.22	24.06

EV-DO

Protocol Release	3GPP Release Version	Band BC0 (dB m)			Band BC1 (dB m)		
		824.70	836.52	848.31	1 851.25	1 880.00	1 908.75
Rel. 0	FTAP (307.2 kbps, QPSK)	22.82	22.80	22.66	24.05	24.13	24.13
	RTAP (153.6 kbps)	22.82	22.83	22.63	23.99	24.13	24.09
Rev. A	FETAP (307.2 kbps, QPSK)	22.83	22.91	22.69	24.08	24.18	24.02
	RETAP (4096 bits)	22.87	22.95	22.78	24.03	24.17	24.04

The results shown in this test report refer only to the sample(s) tested unless otherwise stated. This test report cannot be reproduced, except in full, without prior written permission of the Company. This test report does not assure KOLAS accreditation.

4. Occupied Bandwidth 99 %

4.1. Limit

CFR 47, Section FCC §2.1049.

4.2. Test Procedure

The test follows section 4.2 of FCC KDB Publication 971168 D01 v02r02.

1. Set span = 2 - 5 x OBW.
2. Set resolution bandwidth (RBW) = 1 - 5 % of OBW.
3. Set video bandwidth (VBW) $\geq 3 \times$ RBW.
4. Detector = Peak.
5. Trace mode = Max hold.
6. Use the 99 % power bandwidth function of the spectrum analyzer (if available) and report the measured bandwidth.

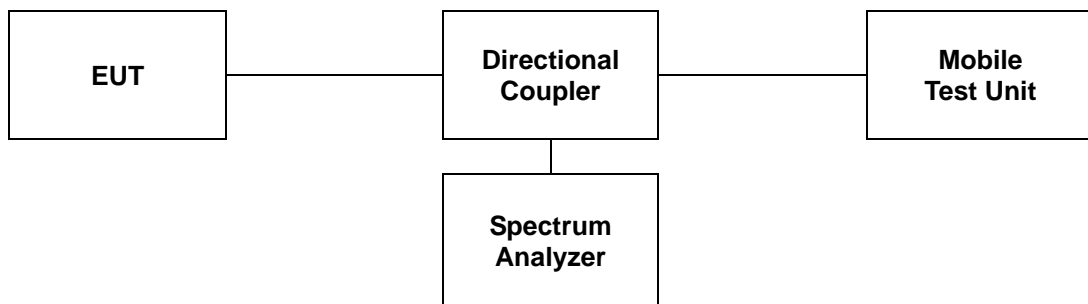

The results shown in this test report refer only to the sample(s) tested unless otherwise stated. This test report cannot be reproduced, except in full, without prior written permission of the Company. This test report does not assure KOLAS accreditation.

4.3 Test Results

Ambient temperature : (23 ± 1) °C

Relative humidity : 47 % R.H.

Band	Mode	Frequency (MHz)	Occupied Bandwidth (MHz)
BC0	1xRTT	824.70	1.276
		836.52	1.276
		848.31	1.268
	EV-DO	824.70	1.276
		836.52	1.276
		848.31	1.272
BC1	1xRTT	1 851.25	1.272
		1 880.00	1.268
		1 908.75	1.268
	EV-DO	1 851.25	1.272
		1 880.00	1.268
		1 908.75	1.272

The results shown in this test report refer only to the sample(s) tested unless otherwise stated. This test report cannot be reproduced, except in full, without prior written permission of the Company. This test report does not assure KOLAS accreditation.

CDMA BC0 (1xRTT)
Low Channel

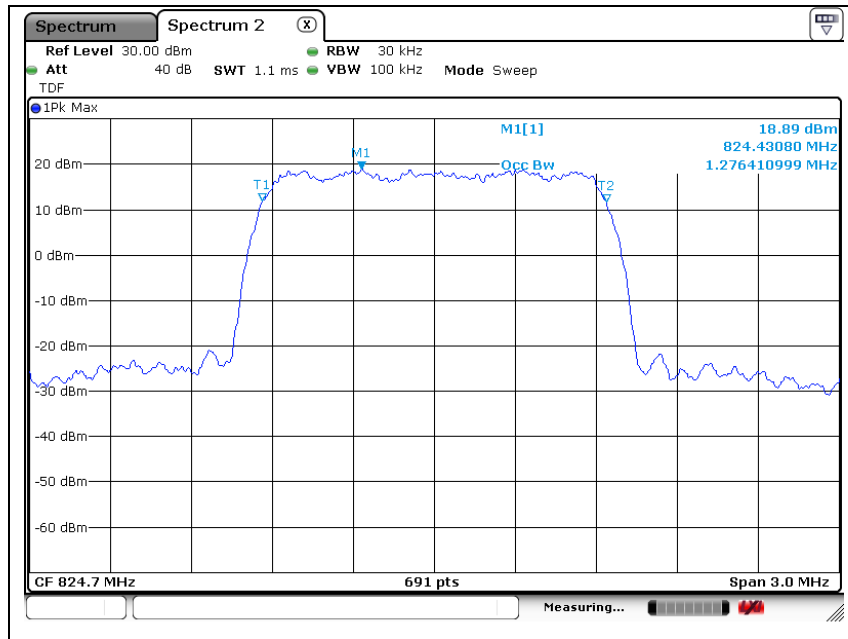

Middle Channel

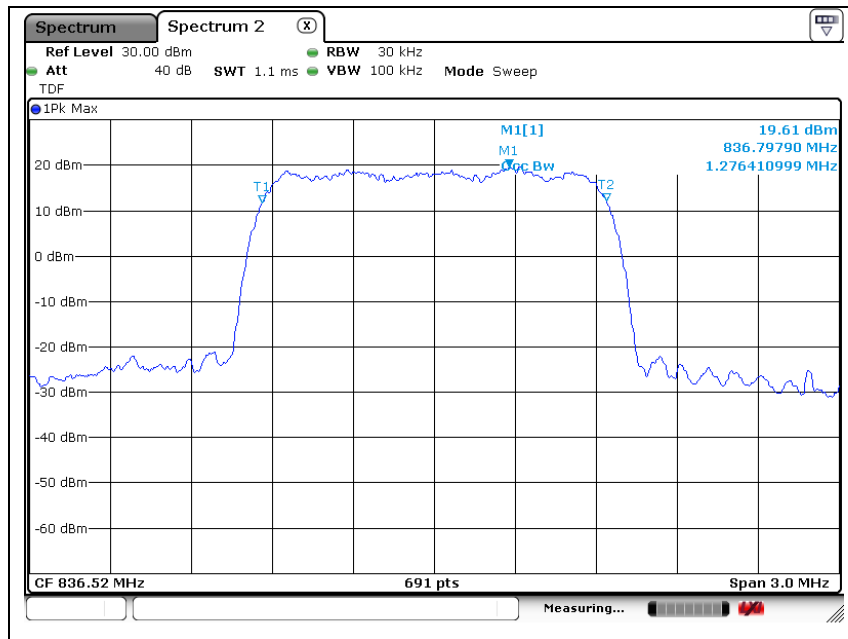

The results shown in this test report refer only to the sample(s) tested unless otherwise stated. This test report cannot be reproduced, except in full, without prior written permission of the Company. This test report does not assure KOLAS accreditation.

High Channel

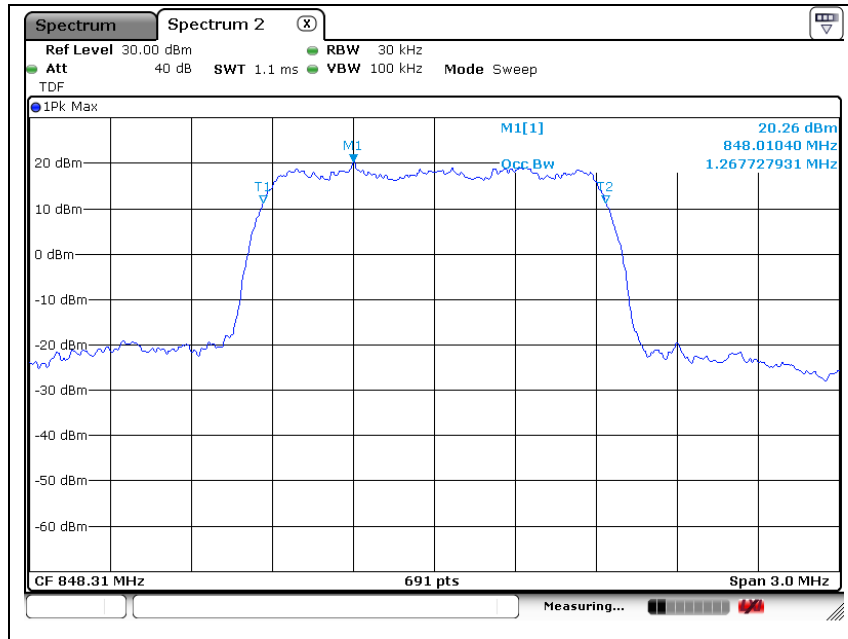

The results shown in this test report refer only to the sample(s) tested unless otherwise stated. This test report cannot be reproduced, except in full, without prior written permission of the Company. This test report does not assure KOLAS accreditation.

CDMA BC0 (EV-DO)

Low Channel

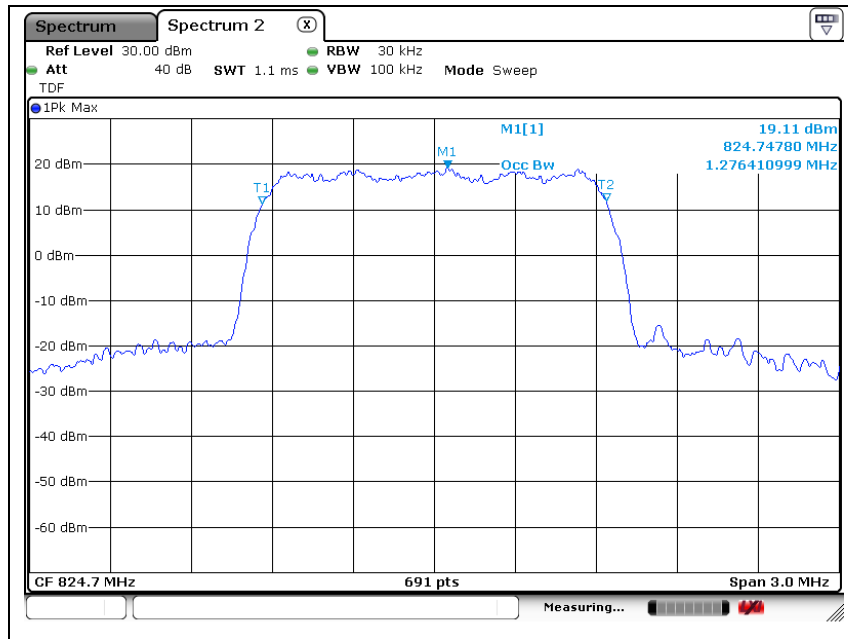

Middle Channel

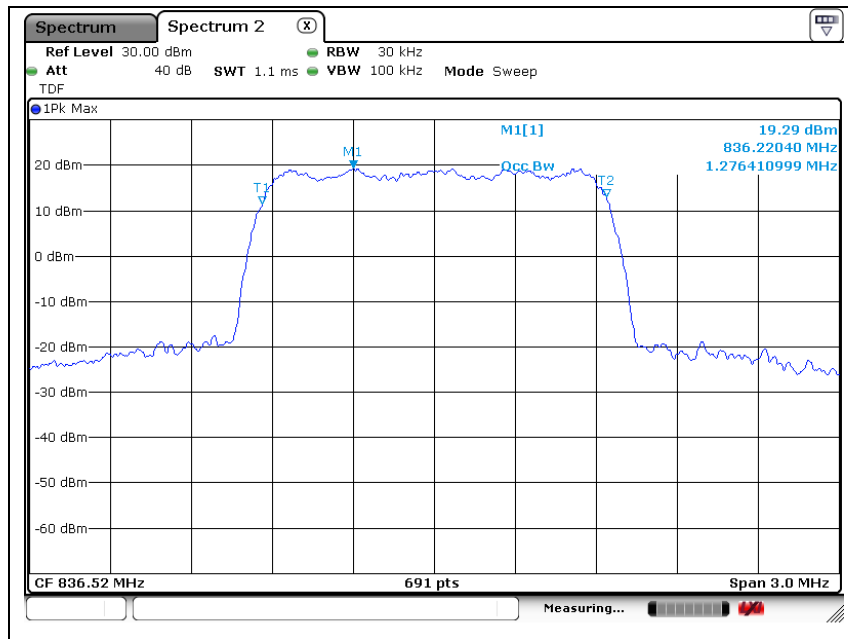

The results shown in this test report refer only to the sample(s) tested unless otherwise stated. This test report cannot be reproduced, except in full, without prior written permission of the Company. This test report does not assure KOLAS accreditation.

High Channel

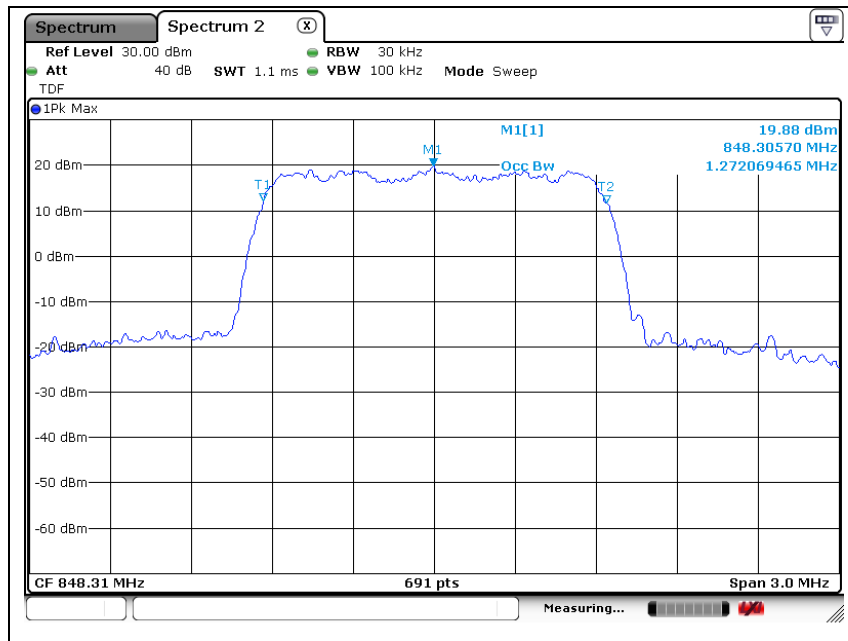

The results shown in this test report refer only to the sample(s) tested unless otherwise stated. This test report cannot be reproduced, except in full, without prior written permission of the Company. This test report does not assure KOLAS accreditation.

High Channel

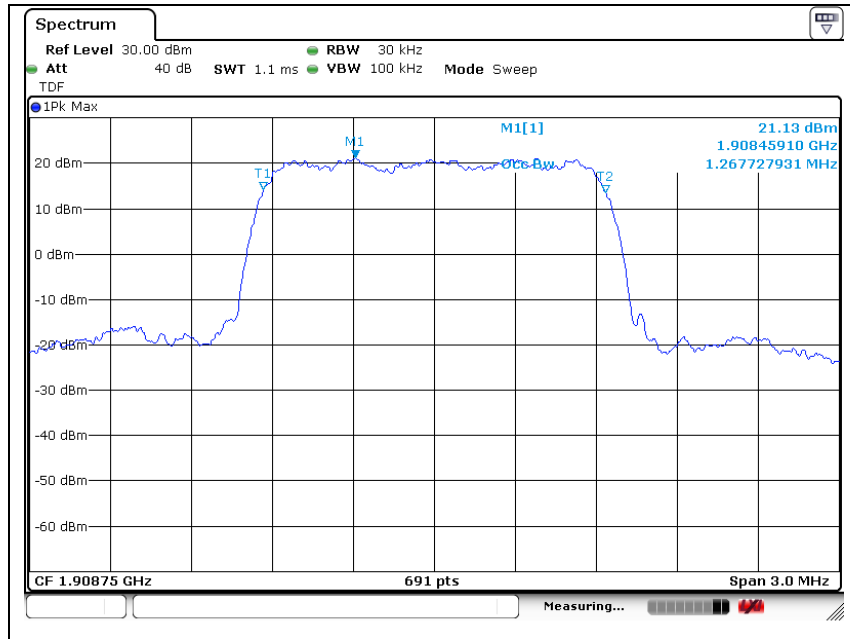

The results shown in this test report refer only to the sample(s) tested unless otherwise stated. This test report cannot be reproduced, except in full, without prior written permission of the Company. This test report does not assure KOLAS accreditation.

CDMA BC1 (EV-DO)
Low Channel

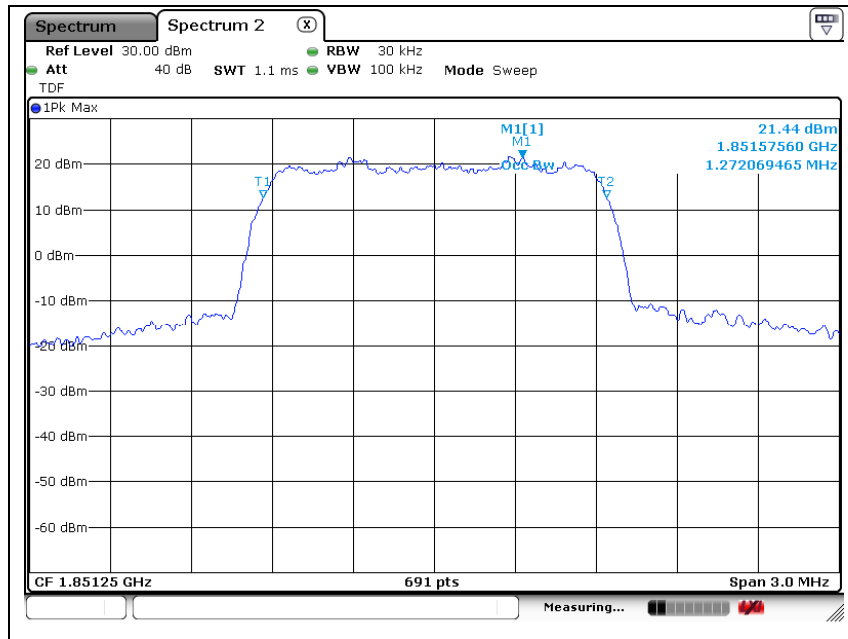

Middle Channel

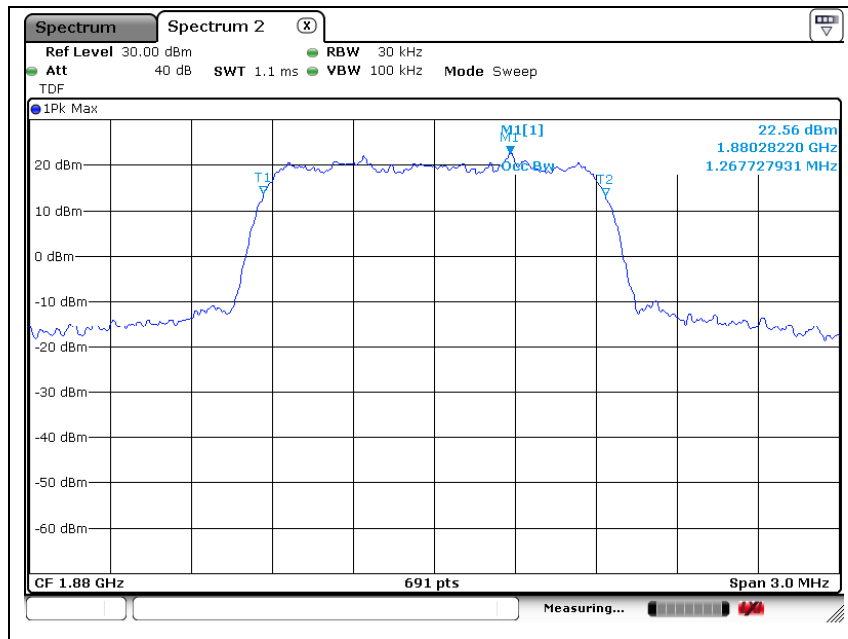

The results shown in this test report refer only to the sample(s) tested unless otherwise stated. This test report cannot be reproduced, except in full, without prior written permission of the Company. This test report does not assure KOLAS accreditation.

High Channel

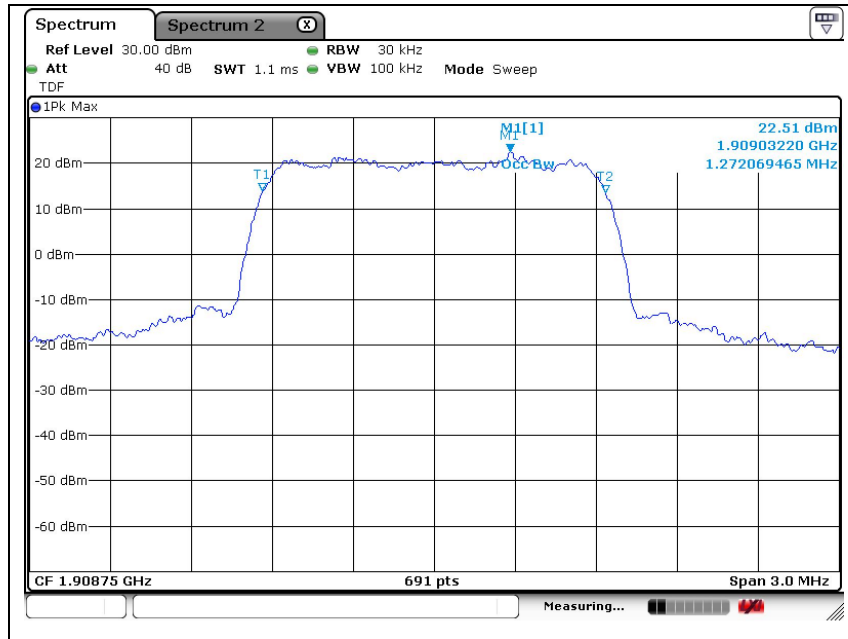

The results shown in this test report refer only to the sample(s) tested unless otherwise stated. This test report cannot be reproduced, except in full, without prior written permission of the Company. This test report does not assure KOLAS accreditation.

5. Peak-Average Ratio

5.1. Limit

- §22.913(d) Measurement of the ERP of Cellular base transmitters and repeaters must be made using an average power measurement technique. The peak-to-average ratio (PAR) of the transmission must not exceed 13 dB.

- §24.232(d), power measurements for transmissions by stations authorized under this section may be made either in accordance with a Commission-approved average power technique or in compliance with paragraph (e) of this section. In both instances, equipment employed must be authorized in accordance with the provisions of §24.51. In measuring transmissions in this band using an average power technique, the peak-to-average ratio (PAR) of the transmission may not exceed 13 dB.

5.2. Test Procedure

The test follows section 5.7.1 of FCC KDB Publication 971168 D01 v02r02.

1. Refer to the instrument's analyzer instruction manual for details on how to use the power statistics/CCDF function.
2. Set resolution/measurement bandwidth \geq signal's occupied bandwidth.
3. Set the number of counts to a value that stabilizes the measured CCDF curve.
4. Set the measurement interval as follows:
 - a) For continuous transmissions, set to 1 ms.
 - b) For burst transmissions, employ an external trigger that is synchronized with the EUT burst timing sequence, or use the internal burst trigger with a trigger level that allows the burst to stabilize and set the measurement interval to a time that is less than or equal to the burst duration.
5. Record the maximum PAPR level associated with a probability of 0.1 %.

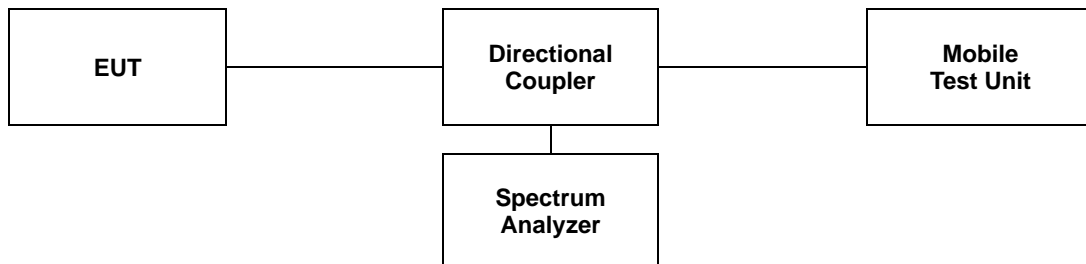

The results shown in this test report refer only to the sample(s) tested unless otherwise stated. This test report cannot be reproduced, except in full, without prior written permission of the Company. This test report does not assure KOLAS accreditation.

5.3 Test Results

Ambient temperature : (23 ± 1) °C

Relative humidity : 47 % R.H.

Band	Mode	Frequency (MHz)	Occupied Bandwidth (MHz)
BC0	1xRTT	824.70	3.88
		836.52	3.94
		848.31	4.12
	EV-DO	824.70	5.01
		836.52	5.04
		848.31	5.74
BC1	1xRTT	1 851.25	3.59
		1 880.00	3.65
		1 908.75	4.00
	EV-DO	1 851.25	5.01
		1 880.00	5.13
		1 908.75	5.68

The results shown in this test report refer only to the sample(s) tested unless otherwise stated. This test report cannot be reproduced, except in full, without prior written permission of the Company. This test report does not assure KOLAS accreditation.

CDMA BC0 (1xRTT)
Low Channel

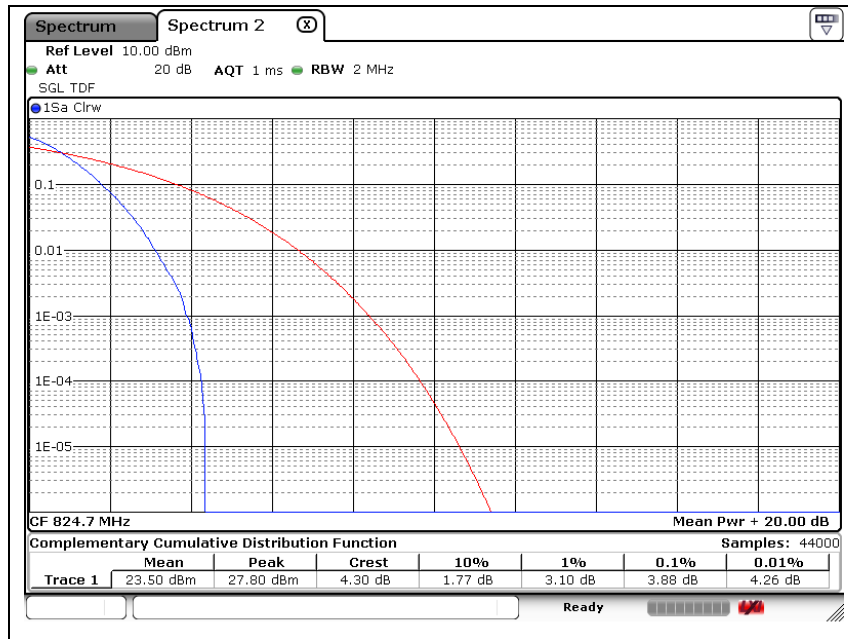

Middle Channel

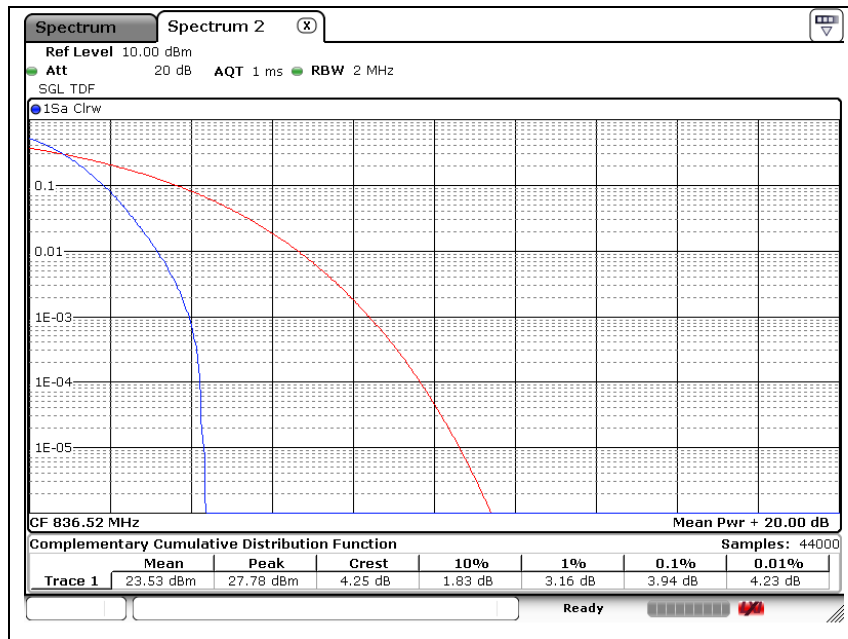

The results shown in this test report refer only to the sample(s) tested unless otherwise stated. This test report cannot be reproduced, except in full, without prior written permission of the Company. This test report does not assure KOLAS accreditation.

High Channel

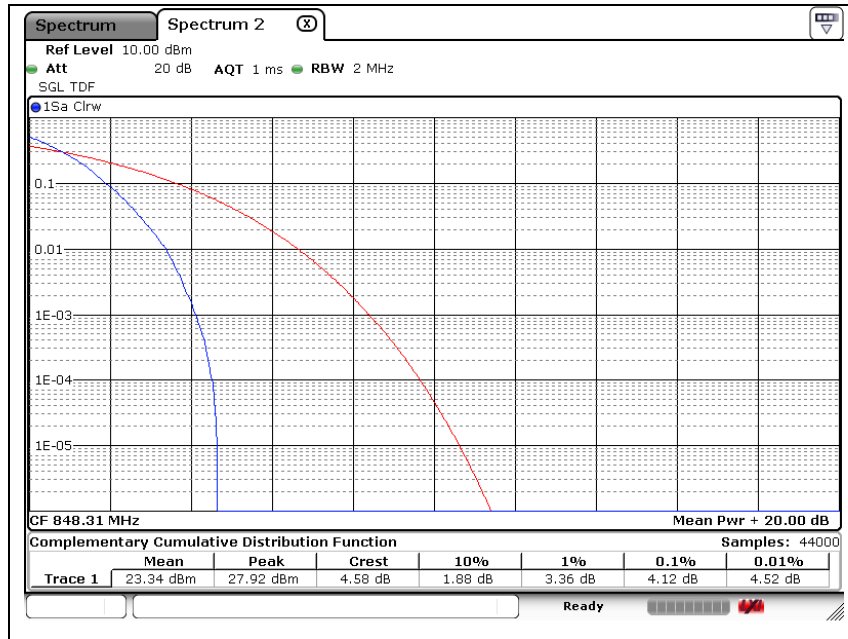

The results shown in this test report refer only to the sample(s) tested unless otherwise stated. This test report cannot be reproduced, except in full, without prior written permission of the Company. This test report does not assure KOLAS accreditation.

CDMA BC0 (EV-DO)
Low Channel

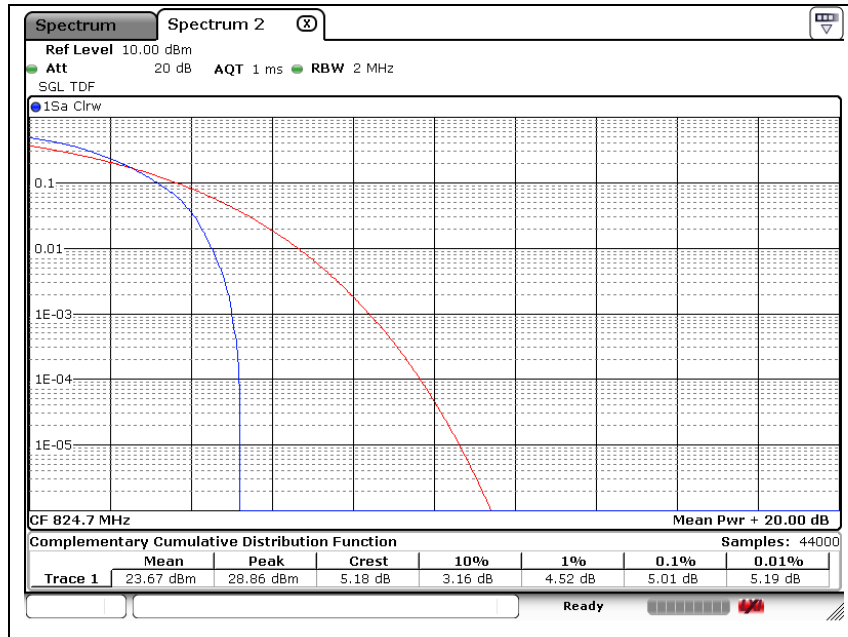

Middle Channel

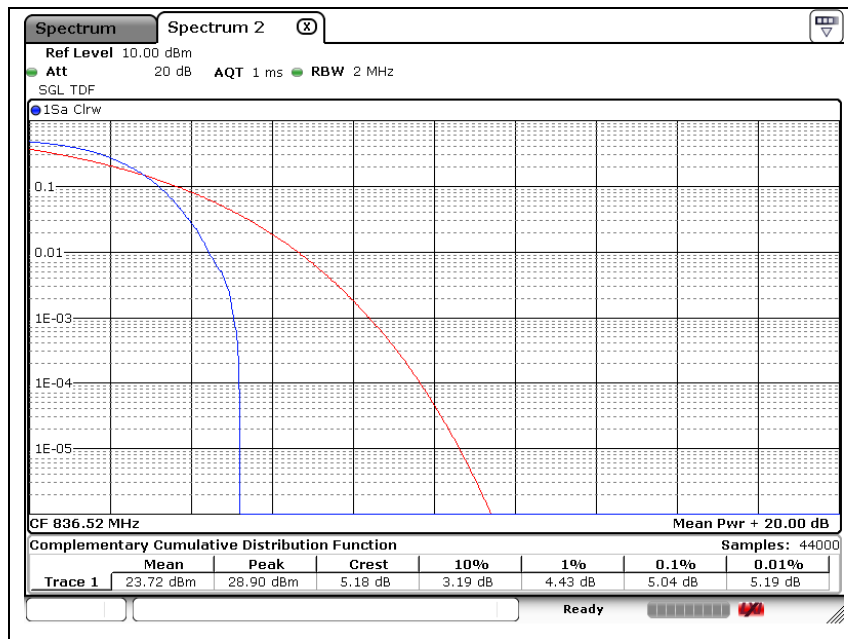

The results shown in this test report refer only to the sample(s) tested unless otherwise stated. This test report cannot be reproduced, except in full, without prior written permission of the Company. This test report does not assure KOLAS accreditation.

High Channel

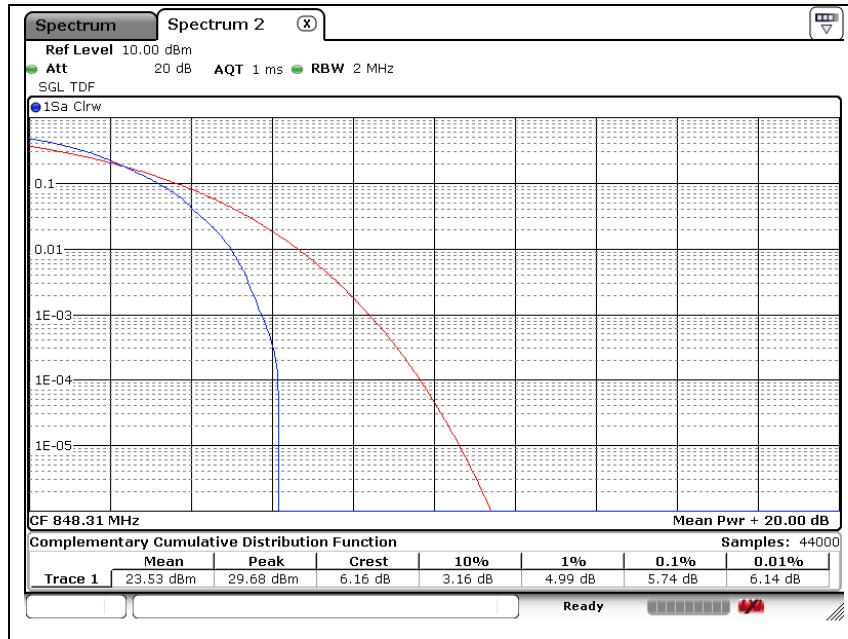

The results shown in this test report refer only to the sample(s) tested unless otherwise stated. This test report cannot be reproduced, except in full, without prior written permission of the Company. This test report does not assure KOLAS accreditation.

CDMA BC1 (1xRTT)
Low Channel

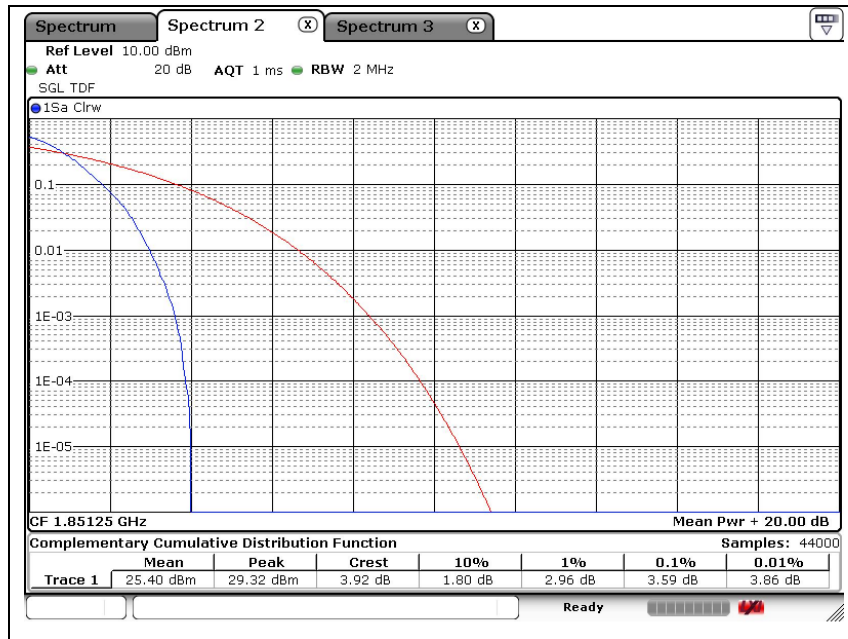

Middle Channel

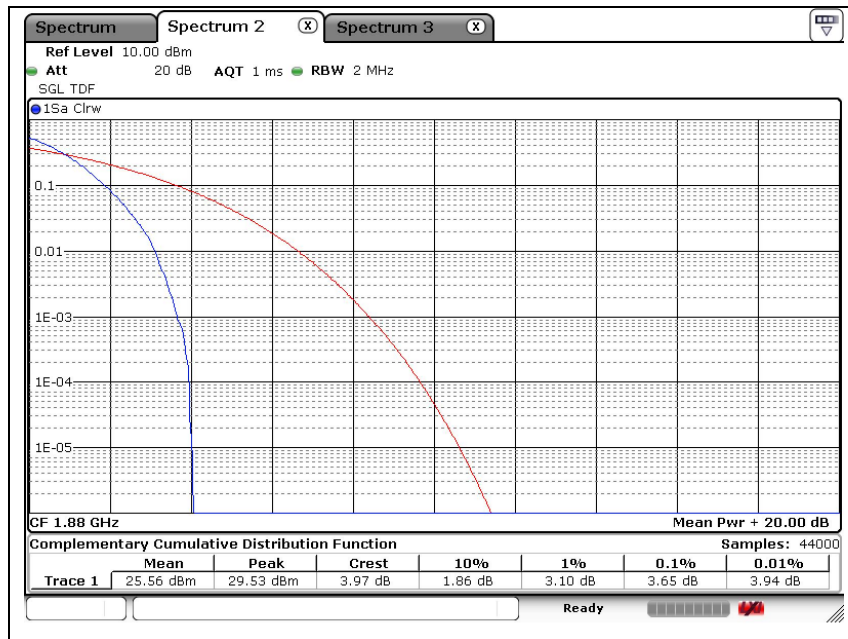

The results shown in this test report refer only to the sample(s) tested unless otherwise stated. This test report cannot be reproduced, except in full, without prior written permission of the Company. This test report does not assure KOLAS accreditation.

High Channel

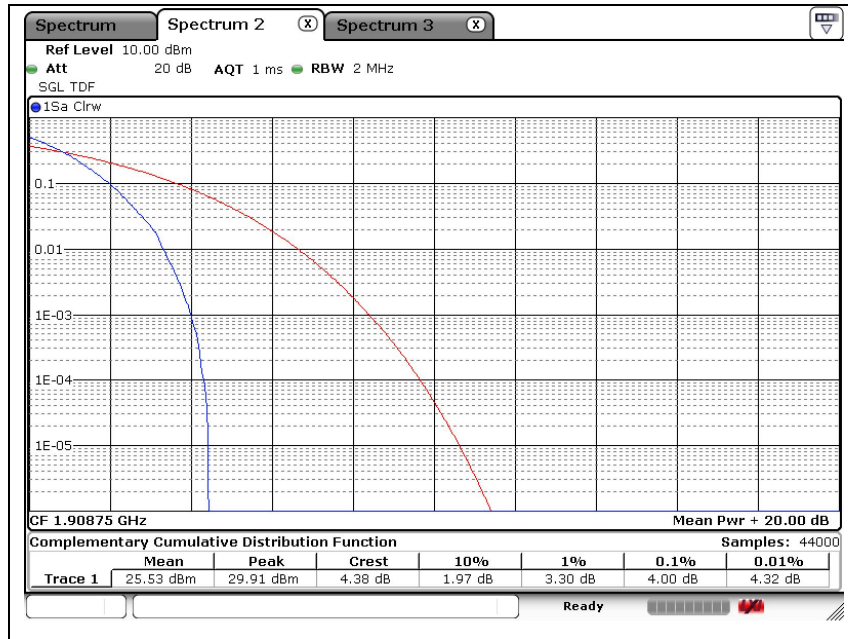

The results shown in this test report refer only to the sample(s) tested unless otherwise stated. This test report cannot be reproduced, except in full, without prior written permission of the Company. This test report does not assure KOLAS accreditation.

CDMA BC1 (EV-DO)
Low Channel

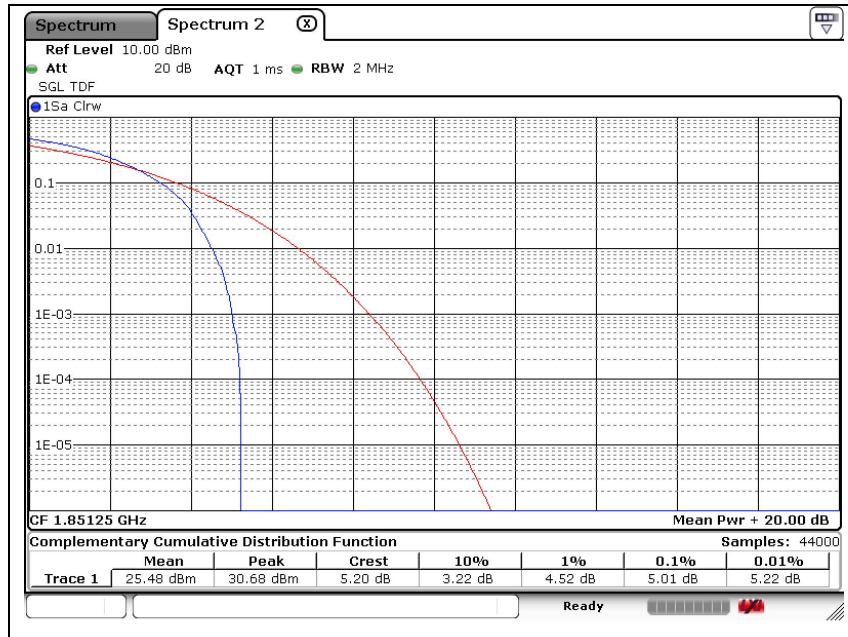

Middle Channel

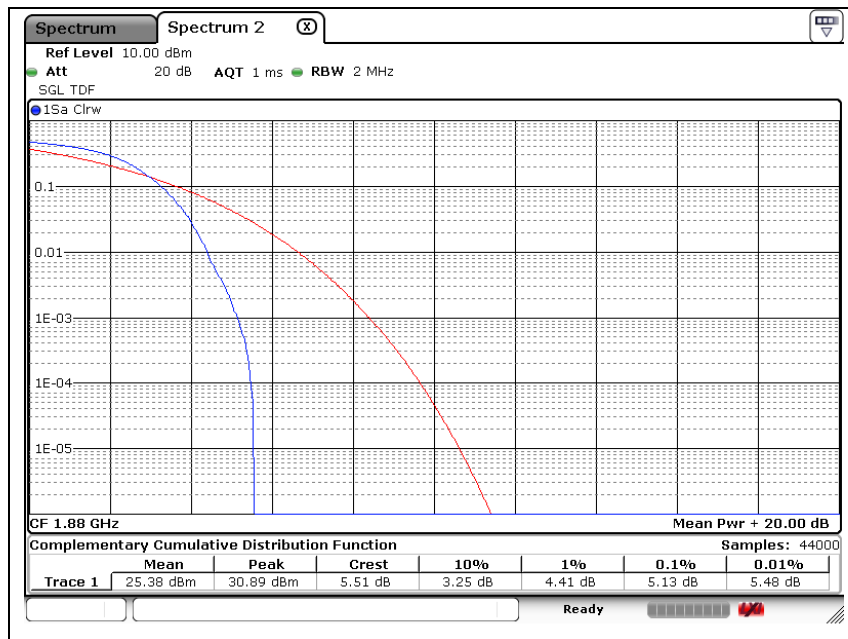

The results shown in this test report refer only to the sample(s) tested unless otherwise stated. This test report cannot be reproduced, except in full, without prior written permission of the Company. This test report does not assure KOLAS accreditation.

High Channel

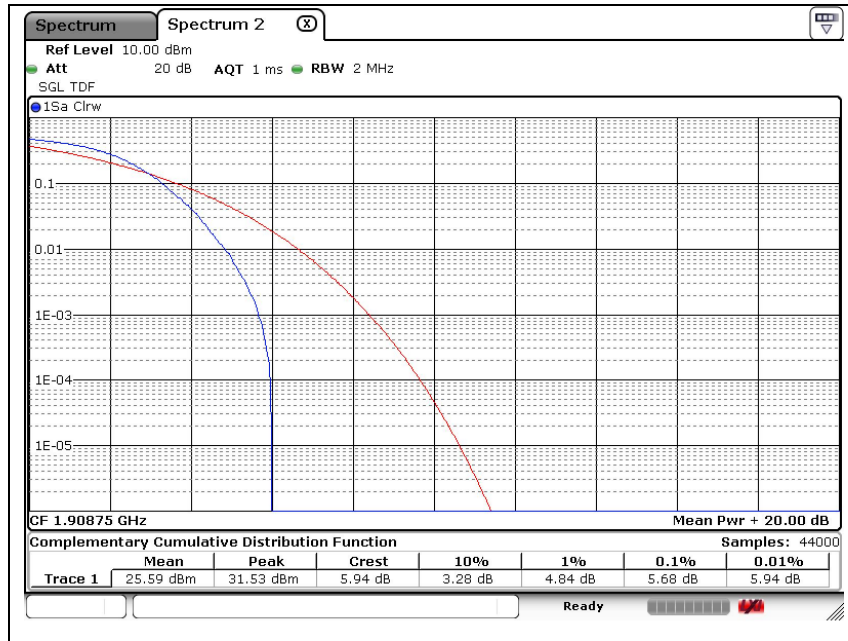

The results shown in this test report refer only to the sample(s) tested unless otherwise stated. This test report cannot be reproduced, except in full, without prior written permission of the Company. This test report does not assure KOLAS accreditation.

6. Spurious Emissions at Antenna Terminal

6.1. Limit

- §22.917(a), the power of any emission outside of the authorized operating frequency ranges must be attenuated below the transmitting power (P) by a factor of at least $43 + 10\log(P)$ dB.

- §24.238(a), the power of any emission outside of the authorized operating frequency ranges must be attenuated below the transmitting power (P) by a factor of at least $43 + 10 \log(P)$ dB.

6.2. Test Procedure

The test follows section 6 of FCC KDB Publication 971168 D01 v02r02.

1. Start frequency was set to 30 MHz and stop frequency was set to at least 10* the fundamental frequency.
2. Detector = Peak.
3. Trace mode = Max hold.
4. Sweep time = Auto couple.
5. The trace was allowed to stabilize.
6. Please see notes below for RBW and VBW settings.
7. For plots showing conducted spurious emissions from 30 MHz to 20 GHz, all path loss of wide frequency range was investigated and compensated to spectrum analyzer as correction factor.

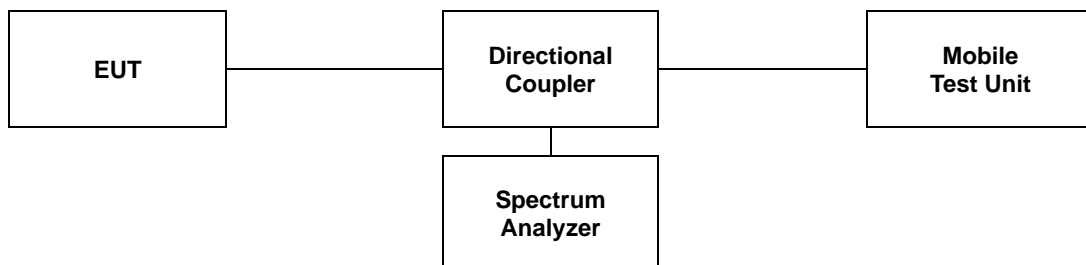

Notes;

Compliance with the applicable limits is based on the use of measurement instrumentation employing a resolution bandwidth of 100 kHz or greater for frequencies less than 1 GHz and frequencies greater than 1 GHz. However, in the 1 MHz bands immediately outside and adjacent to the frequency block a resolution bandwidth of at least one percent of the emission bandwidth of the fundamental emission of the transmitter may be employed. The emission bandwidth is defined as the width of the signal between two point, one below the carrier center frequency and one above the carrier center frequency, outside of which all emission are attenuated at least 26 dB below the transmitter power.

The results shown in this test report refer only to the sample(s) tested unless otherwise stated. This test report cannot be reproduced, except in full, without prior written permission of the Company. This test report does not assure KOLAS accreditation.

6.3. Test Results

Ambient temperature : (23 ± 1) °C
 Relative humidity : 47 % R.H.

Please refer to the following plots.

CDMA BC0 (1xRTT) Low Channel

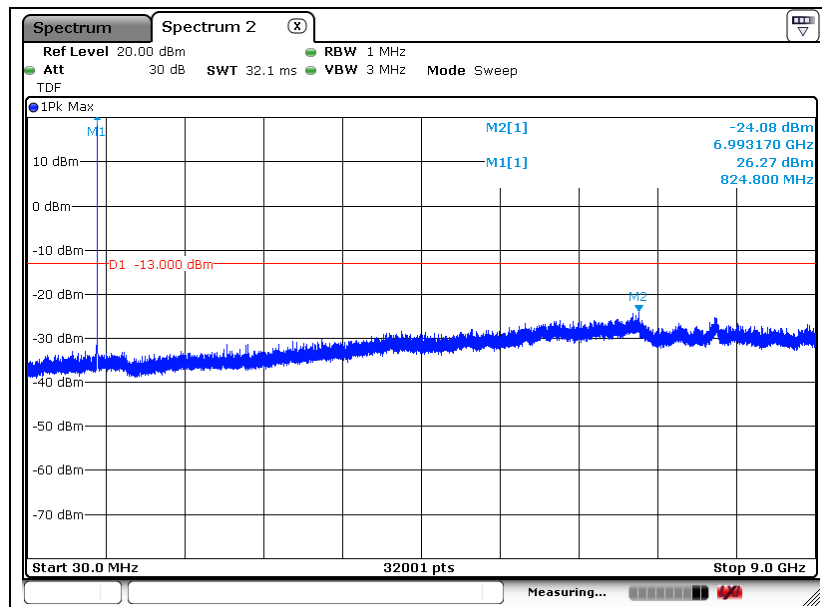

Middle Channel

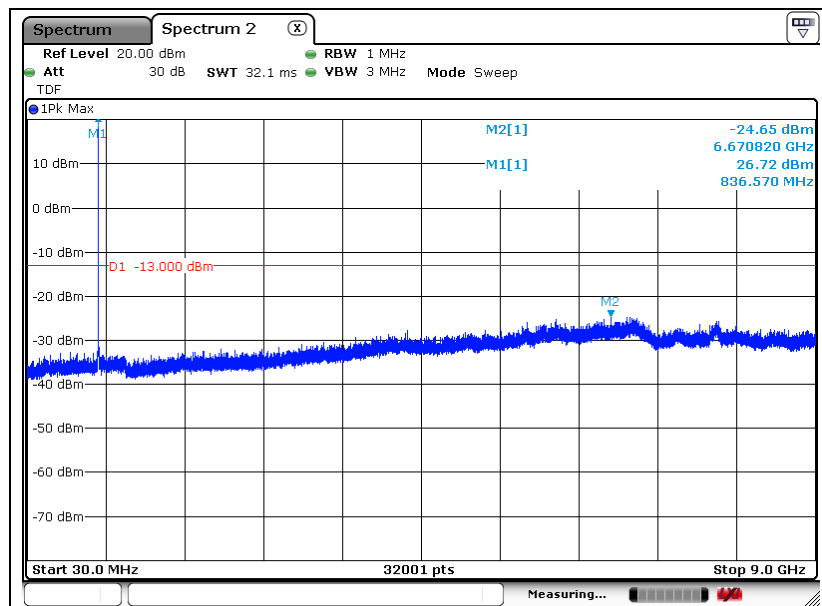

The results shown in this test report refer only to the sample(s) tested unless otherwise stated. This test report cannot be reproduced, except in full, without prior written permission of the Company. This test report does not assure KOLAS accreditation.

High Channel

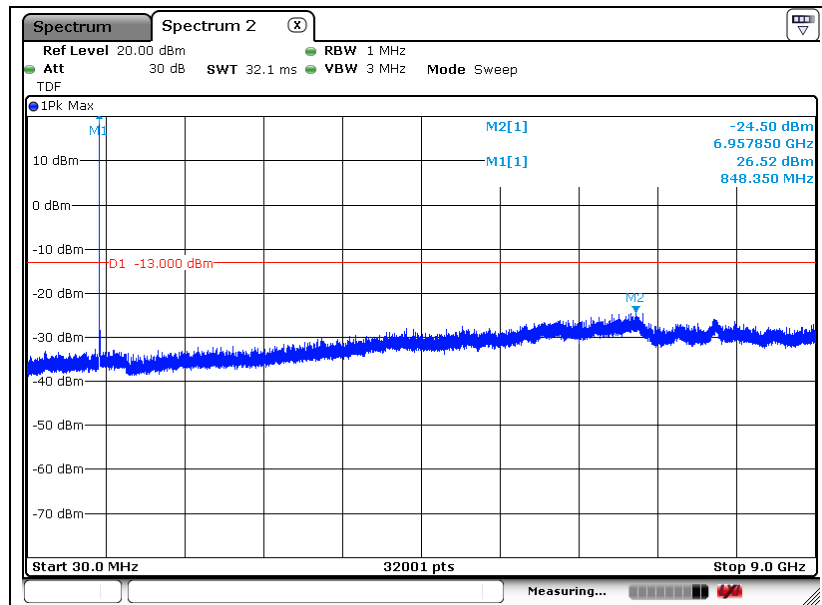

The results shown in this test report refer only to the sample(s) tested unless otherwise stated. This test report cannot be reproduced, except in full, without prior written permission of the Company. This test report does not assure KOLAS accreditation.

CDMA BC0 (EV-DO) Low Channel

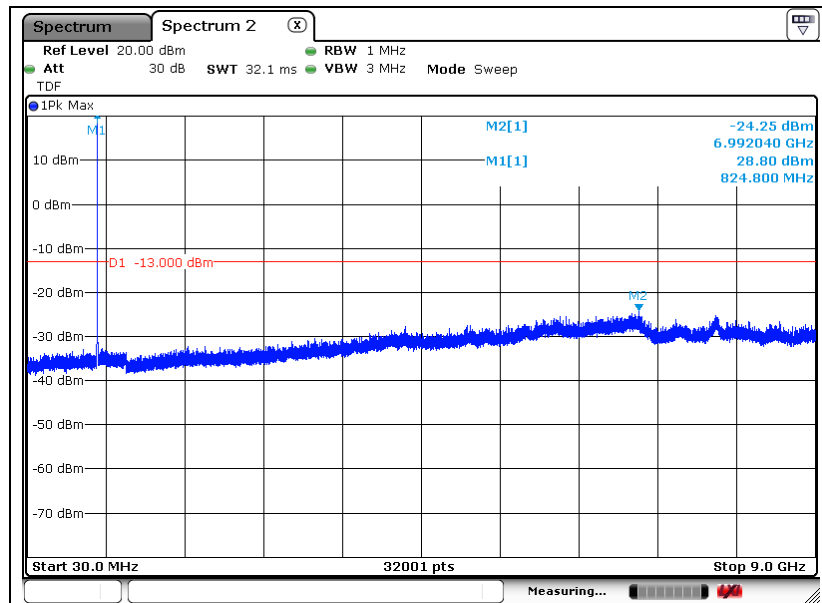

Middle Channel

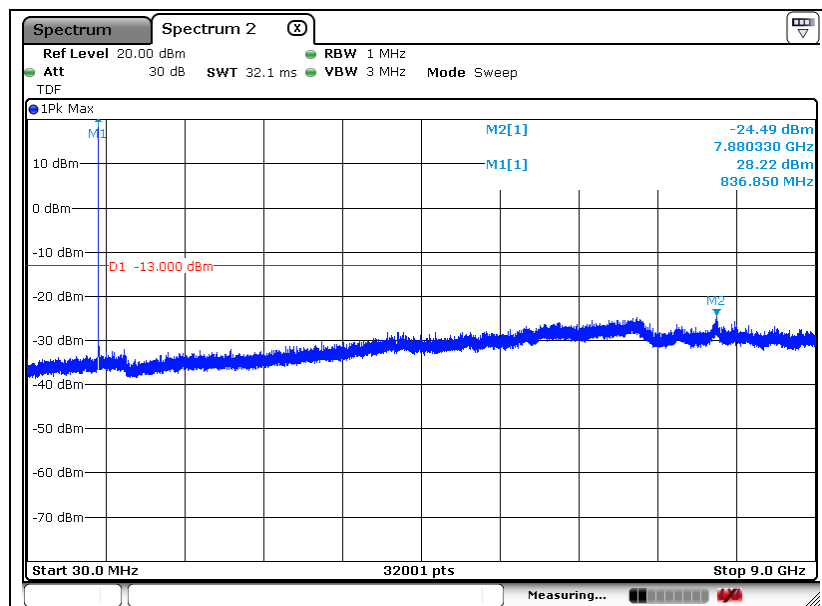

The results shown in this test report refer only to the sample(s) tested unless otherwise stated. This test report cannot be reproduced, except in full, without prior written permission of the Company. This test report does not assure KOLAS accreditation.

High Channel

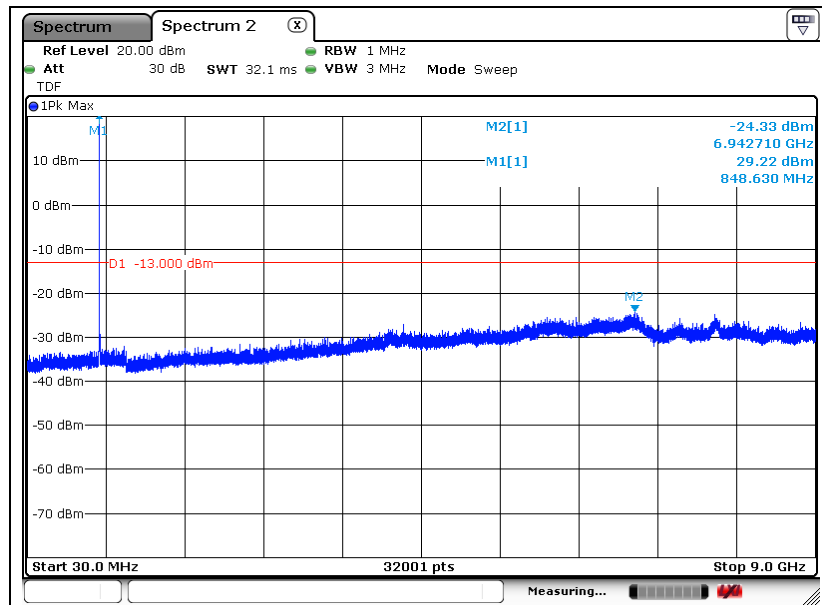

The results shown in this test report refer only to the sample(s) tested unless otherwise stated. This test report cannot be reproduced, except in full, without prior written permission of the Company. This test report does not assure KOLAS accreditation.

High Channel

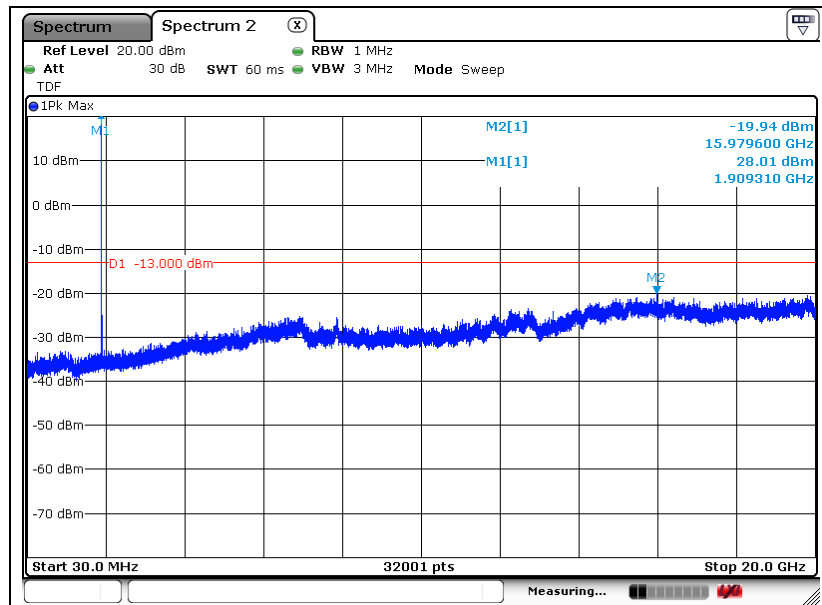

The results shown in this test report refer only to the sample(s) tested unless otherwise stated. This test report cannot be reproduced, except in full, without prior written permission of the Company. This test report does not assure KOLAS accreditation.

CDMA BC1 (EV-DO)
Low Channel

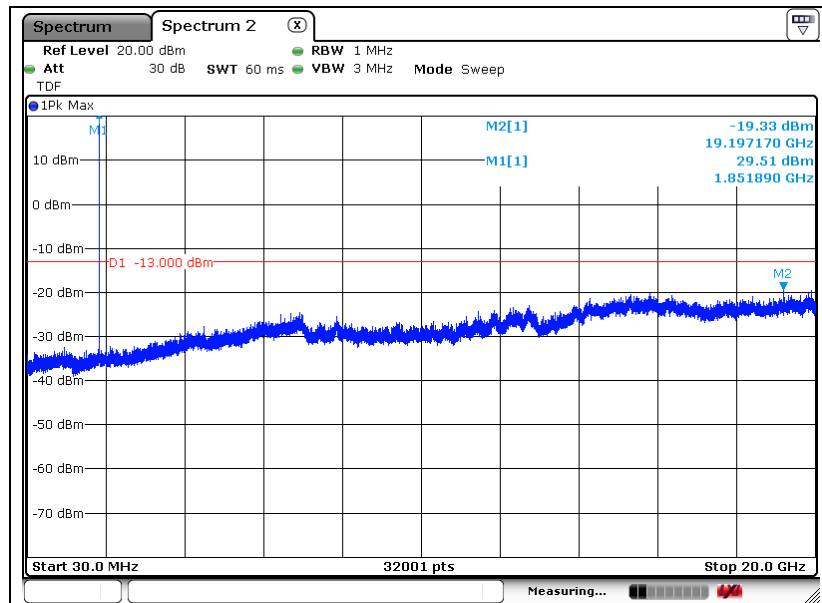

Middle Channel

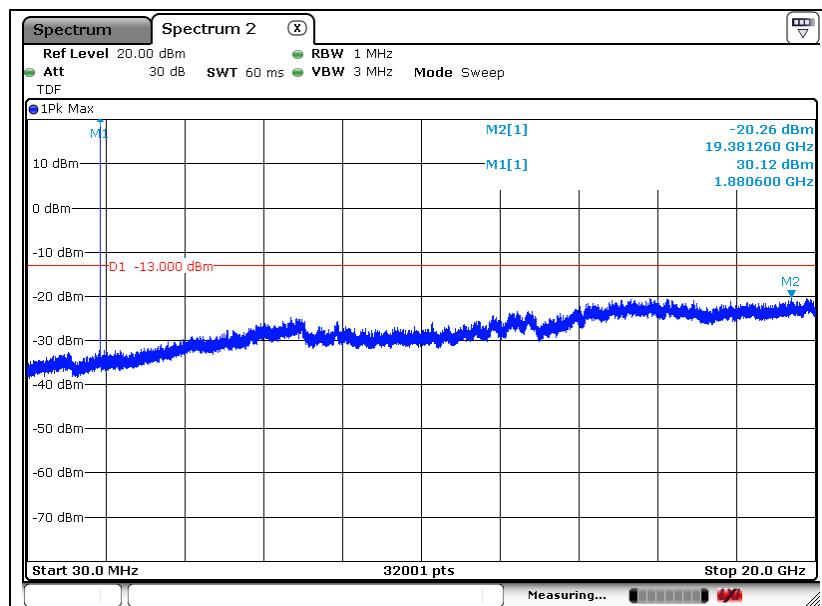

The results shown in this test report refer only to the sample(s) tested unless otherwise stated. This test report cannot be reproduced, except in full, without prior written permission of the Company. This test report does not assure KOLAS accreditation.

High Channel

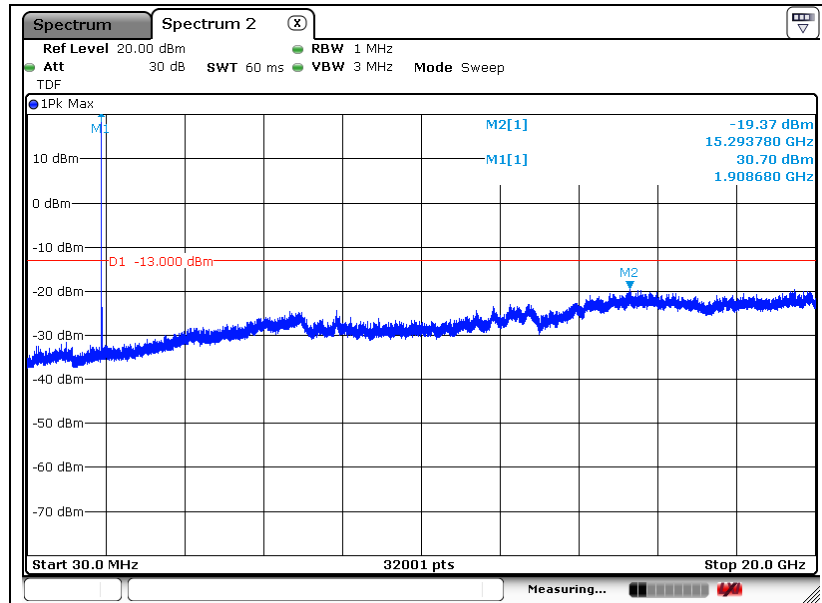

The results shown in this test report refer only to the sample(s) tested unless otherwise stated. This test report cannot be reproduced, except in full, without prior written permission of the Company. This test report does not assure KOLAS accreditation.

7. Band Edge

7.1. Limit

- §22.917(a), the power of any emission outside of the authorized operating frequency ranges must be attenuated below the transmitting power (P) by a factor of at least $43 + 10\log(P)$ dB.

- §24.238(a), the power of any emission outside of the authorized operating frequency ranges must be attenuated below the transmitting power (P) by a factor of at least $43 + 10 \log(P)$ dB.

7.2. Test Procedure

The test follows section 6 of FCC KDB Publication 971168 D01 v02r02.

1. Span was set large enough so as to capture all out of band emissions near the band edge.
2. RBW ≥ 1 % of OBW
3. VBW $\geq 3 \times$ RBW.
4. Detector = RMS.
5. Trace mode = Average.
6. Sweep time = Auto.
7. The trace was allowed to stabilize.
8. All path loss of frequency range was investigated and compensated to spectrum analyzer as correction factor.

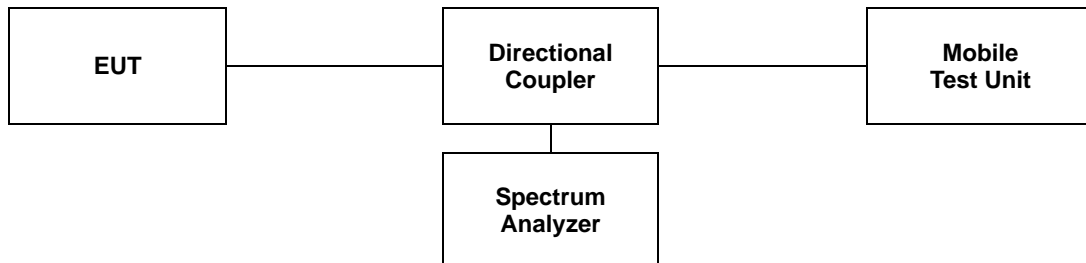

The results shown in this test report refer only to the sample(s) tested unless otherwise stated. This test report cannot be reproduced, except in full, without prior written permission of the Company. This test report does not assure KOLAS accreditation.

7.3. Test Results

Ambient temperature : (23 ± 1) °C
 Relative humidity : 47 % R.H.

Please refer to the following plots.

CDMA BC0 (1xRTT)

Low Channel

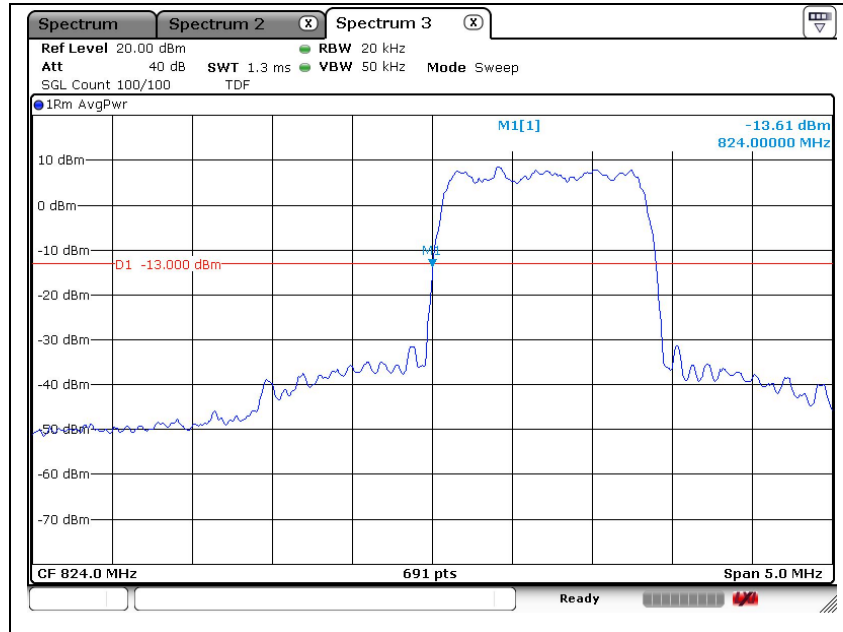

High Channel

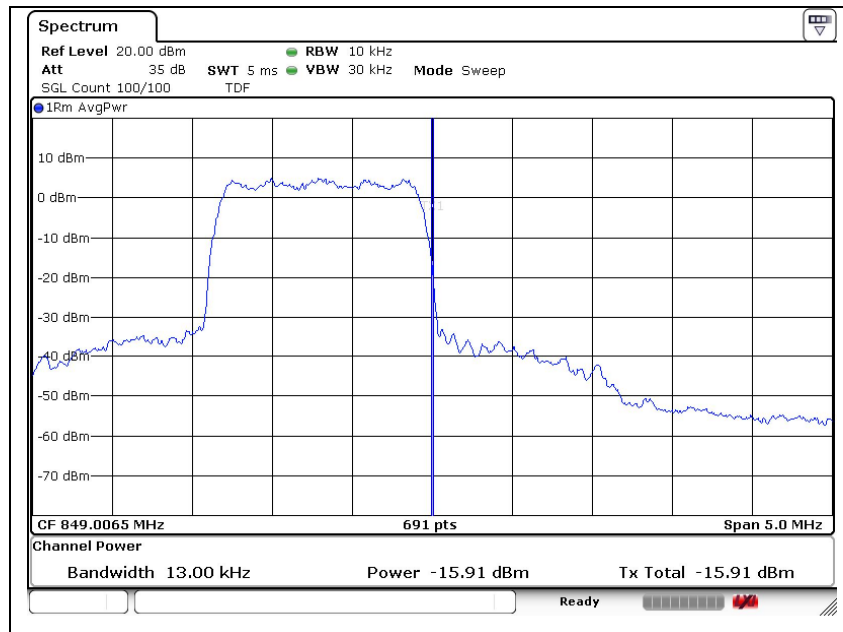

The results shown in this test report refer only to the sample(s) tested unless otherwise stated. This test report cannot be reproduced, except in full, without prior written permission of the Company. This test report does not assure KOLAS accreditation.

CDMA BC0 (EV-DO) Low Channel

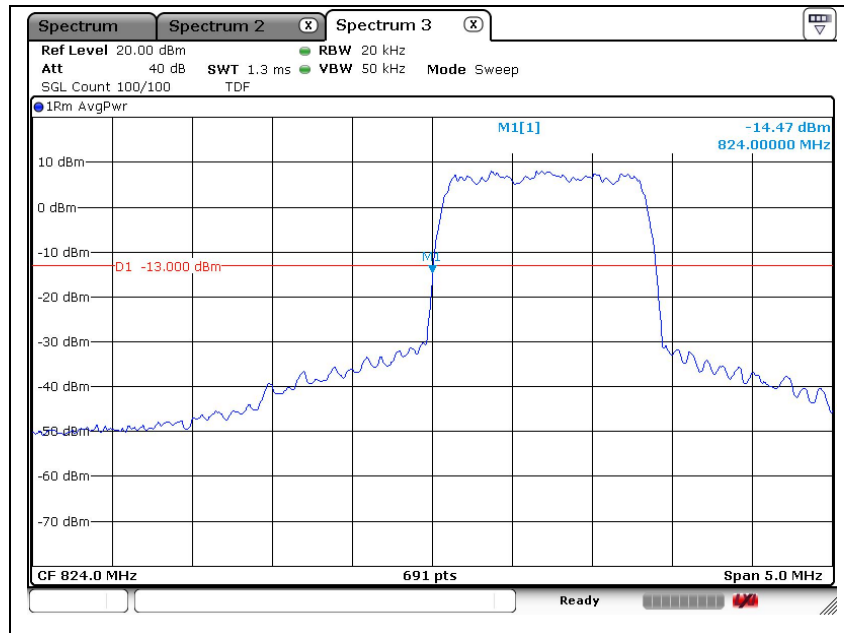

High Channel

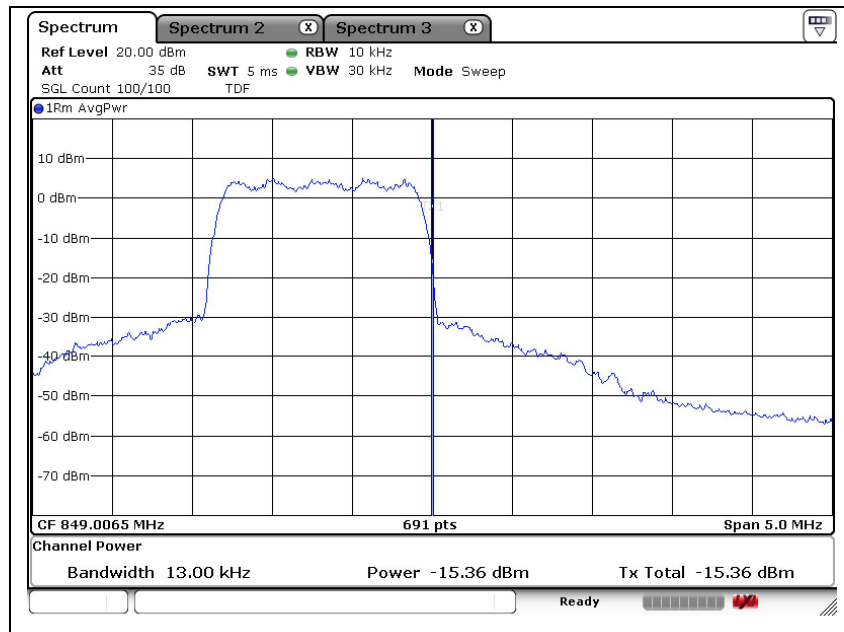

The results shown in this test report refer only to the sample(s) tested unless otherwise stated. This test report cannot be reproduced, except in full, without prior written permission of the Company. This test report does not assure KOLAS accreditation.

CDMA BC1 (1xRTT)
Low Channel



High Channel

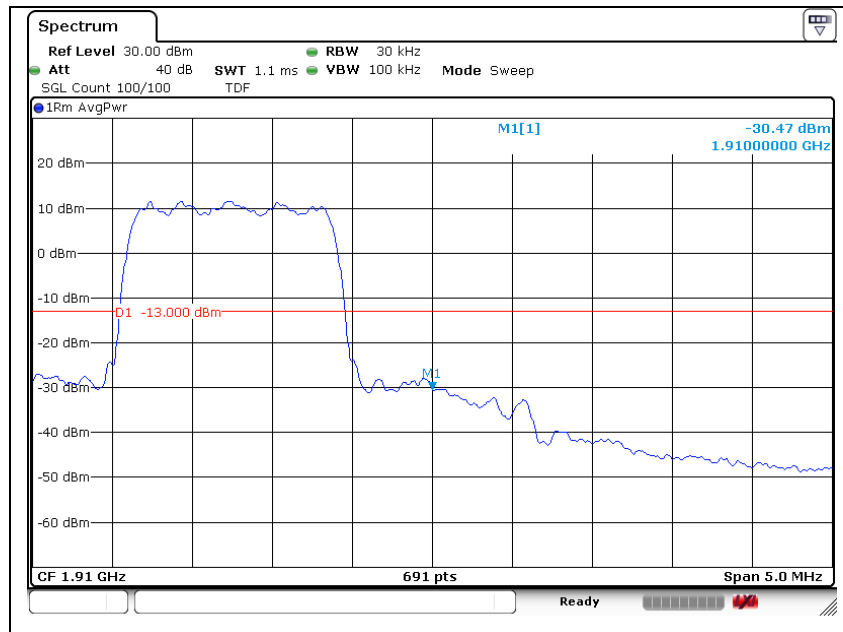

The results shown in this test report refer only to the sample(s) tested unless otherwise stated. This test report cannot be reproduced, except in full, without prior written permission of the Company. This test report does not assure KOLAS accreditation.

CDMA BC1 (EV-DO) Low Channel

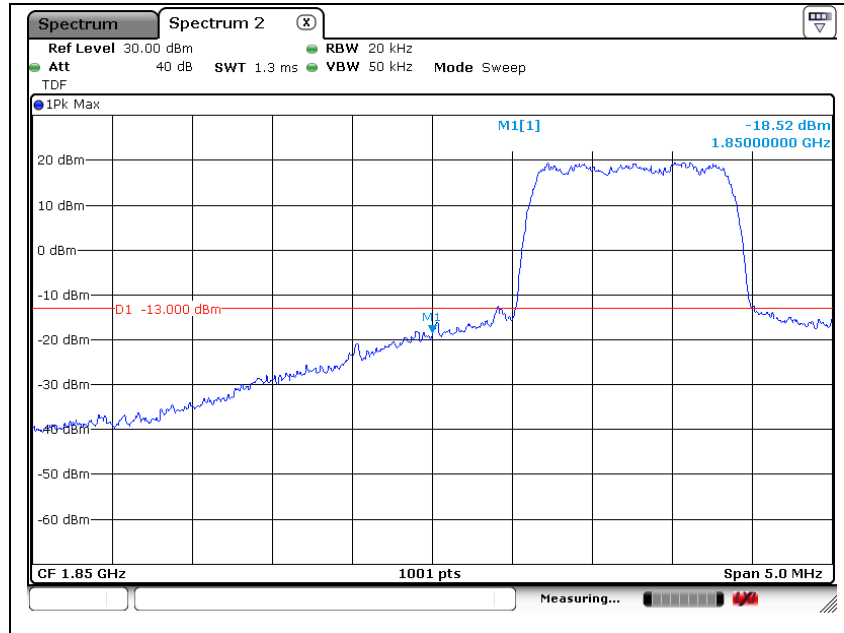

High Channel

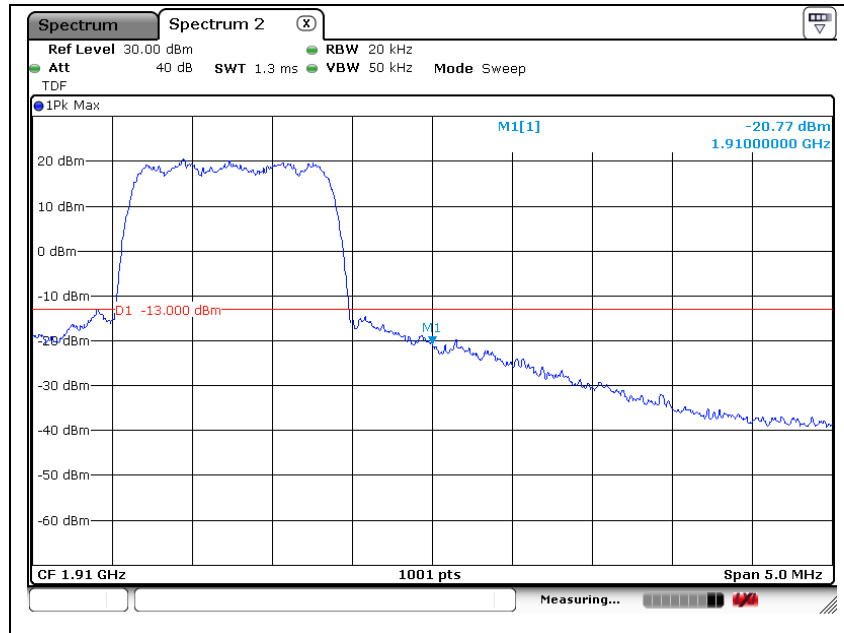

The results shown in this test report refer only to the sample(s) tested unless otherwise stated. This test report cannot be reproduced, except in full, without prior written permission of the Company. This test report does not assure KOLAS accreditation.

8. Frequency Stability

8.1. Limit

- § 2.1055 (a), § 2.1055 (d) & following:

- §22.355, the carrier frequency of each transmitter in the Public Mobile Services must be maintained within the tolerances given in Table of this section.

For Mobile devices operating in the 824 to 849 MHz band at a power level less than or equal to 3 Watts, the limit specified in Table C-1 is +/- 2.5 ppm.

- §24.235, the frequency stability shall be sufficient to ensure that the fundamental emission stays within the authorized frequency block.

8.2. Test Procedure

1. Frequency Stability vs. Temperature: The equipment under test was connected to an external DC power supply and the RF output was connected to a Mobile Test Unit via feed-through attenuators.
2. The EUT was placed inside the temperature chamber.
3. After the temperature stabilized for approximately 20 minutes, the frequency output was recorded from Mobile Test Unit.

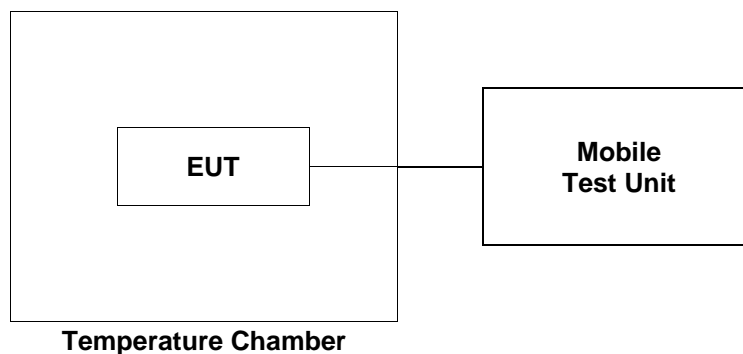

The results shown in this test report refer only to the sample(s) tested unless otherwise stated. This test report cannot be reproduced, except in full, without prior written permission of the Company. This test report does not assure KOLAS accreditation.

8.3. Test Results

Ambient temperature : (23 ± 1) °C
 Relative humidity : 47 % R.H.

CDMA BC0 1xRTT mode at middle channel

Reference Frequency: 836.52 MHz			
Frequency Stability versus Temperature			
Environment Temperature (°C)	Power Supplied (V _{dc})	Frequency Measure with Time Elapse	
		Frequency Error (Hz)	ppm
50	4.0	2	0.002 4
40		4	0.004 8
30		-1	-0.001 2
23		2	0.002 4
10		4	0.004 8
0		-5	-0.006 0
-10		3	0.003 6
-20		7	0.008 4
-30		4	0.004 8
Frequency Stability versus Power Supply			
Environment Temperature (°C)	Power Supplied (V _{dc})	Frequency Measure with Time Elapse	
		Frequency Error (Hz)	ppm
23	4.6	2	0.002 4
	3.4	-2	-0.002 4

The results shown in this test report refer only to the sample(s) tested unless otherwise stated. This test report cannot be reproduced, except in full, without prior written permission of the Company. This test report does not assure KOLAS accreditation.

CDMA BC0 EV-DO mode at middle channel

Reference Frequency: 836.52 MHz			
Frequency Stability versus Temperature			
Environment Temperature (°C)	Power Supplied (V _{dc})	Frequency Measure with Time Elapse	
		Frequency Error (Hz)	ppm
50	4.0	1	0.001 2
40		5	0.006 0
30		2	0.002 4
23		-3	-0.003 6
10		1	0.001 2
0		4	0.004 8
-10		3	0.003 6
-20		-2	-0.002 4
-30		-2	-0.002 4
Frequency Stability versus Power Supply			
Environment Temperature (°C)	Power Supplied (V _{dc})	Frequency Measure with Time Elapse	
		Frequency Error (Hz)	ppm
23	4.6	-3	-0.003 6
	3.4	1	0.001 2

The results shown in this test report refer only to the sample(s) tested unless otherwise stated. This test report cannot be reproduced, except in full, without prior written permission of the Company. This test report does not assure KOLAS accreditation.

CDMA BC0 1xRTT mode at middle channel

Reference Frequency: 1 880.00 MHz			
Frequency Stability versus Temperature			
Environment Temperature (°C)	Power Supplied (V _{dc})	Frequency Measure with Time Elapse	
		Frequency Error (Hz)	ppm
50	4.0	-7	-0.003 7
40		2	0.001 1
30		3	0.001 6
23		1	0.000 5
10		-2	-0.001 1
0		5	0.002 7
-10		2	0.001 1
-20		3	0.001 6
-30		-1	-0.000 5
Frequency Stability versus Power Supply			
Environment Temperature (°C)	Power Supplied (V _{dc})	Frequency Measure with Time Elapse	
		Frequency Error (Hz)	ppm
23	4.6	-2	-0.001 1
	3.4	5	0.002 7

The results shown in this test report refer only to the sample(s) tested unless otherwise stated. This test report cannot be reproduced, except in full, without prior written permission of the Company. This test report does not assure KOLAS accreditation.

CDMA BC1 EV-DO mode at middle channel

Reference Frequency: 1 880.00 MHz			
Frequency Stability versus Temperature			
Environment Temperature (°C)	Power Supplied (V _{dc})	Frequency Measure with Time Elapse	
		Frequency Error (Hz)	ppm
50	4.0	5	0.002 7
40		-3	-0.001 6
30		-2	-0.001 1
23		-3	-0.001 6
10		1	0.000 5
0		4	0.002 1
-10		-2	-0.001 1
-20		-1	-0.000 5
-30		-2	-0.001 1
Frequency Stability versus Power Supply			
Environment Temperature (°C)	Power Supplied (V _{dc})	Frequency Measure with Time Elapse	
		Frequency Error (Hz)	ppm
23	4.6	1	0.000 5
	3.4	3	0.001 6

- End of the Test Report -

The results shown in this test report refer only to the sample(s) tested unless otherwise stated. This test report cannot be reproduced, except in full, without prior written permission of the Company. This test report does not assure KOLAS accreditation.