

# RF TEST REPORT

Test item : Telematics Modem  
Model No. : LTD-VL2000  
Order No. : DTNC1503-00940  
Date of receipt : 2015-03-03  
Test duration : 2015-03-04 ~ 2015-03-19  
Date of issue : 2015-04-13  
Use of report : FCC Original Grant

Applicant : LG Innotek Co.,Ltd.  
978-1, Jangduk-dong, Gwangsan-gu, Gwangju-City, South Korea

Test laboratory : DT&C Co., Ltd.  
42, Yurim-ro, 154beon-gil, Cheoin-gu, Yongin-si, Gyeonggi-do, Korea 449-935

Test specification : §22(H), §24(E)  
Test environment : See appended test report  
Test result :  Pass  Fail

The test results presented in this test report are limited only to the sample supplied by applicant and the use of this test report is inhibited other than its purpose. This test report shall not be reproduced except in full, without the written approval of DT&C Co., Ltd.

Tested by:



Engineer  
Chulmin Kim

Reviewed by:



Technical Manager  
Bongjin Kim

## Test Report Version

| Test Report No.    | Date          | Description   |
|--------------------|---------------|---|
| DRTFCC1503-0069    | Mar. 26, 2015 | Initial issue   |
| DRTFCC1503-0069(1) | Apr. 06, 2015 | Revise the conducted output power                     |
| DRTFCC1503-0069(2) | Apr. 13, 2015 | Update max target power (tolerance), max antenna gain |
|                    |               |   |
|                    |               |   |
|                    |               |   |
|                    |               |   |
|                    |               |   |
|                    |               |   |

## Table of Contents

|   |           |
|---|-----------|
| <b>1. GENERAL INFORMATION .....</b>                                     | <b>4</b>  |
| <b>2. INTRODUCTION .....</b>  | <b>5</b>  |
| 2.1. EUT DESCRIPTION .....  | 5         |
| 2.2. Support equipment.....   | 5         |
| 2.3. MEASURING INSTRUMENT CALIBRATION.....                              | 5         |
| 2.4. TEST FACILITY .....  | 5         |
| <b>3. DESCRIPTION OF TESTS.....</b>                                     | <b>6</b>  |
| 3.1 ERP & EIRP .....  | 6         |
| 3.2 PEAK TO AVERAGE RATIO.....  | 8         |
| 3.3 OCCUPIED BANDWIDTH.....   | 10        |
| 3.4 BAND EDGE EMISSIONS AT ANTENNA TERMINAL.....                        | 11        |
| 3.5 SPURIOUS AND HARMONIC EMISSIONS AT ANTENNA TERMINAL.....            | 12        |
| 3.6 RADIATED SPURIOUS EMISSIONS .....                                   | 13        |
| 3.7 FREQUENCY STABILITY / VARIATION OF AMBIENT TEMPERATURE .....        | 14        |
| <b>4. LIST OF TEST EQUIPMENT.....</b>                                   | <b>15</b> |
| <b>5. SUMMARY OF TEST RESULTS .....</b>                                 | <b>16</b> |
| <b>6. SAMPLE CALCULATION .....</b>                                      | <b>17</b> |
| <b>7. TEST DATA .....</b>   | <b>18</b> |
| 7.1 CONDUCTED OUTPUT POWER.....   | 18        |
| 7.2 PEAK TO AVERAGE RATIO.....  | 19        |
| 7.3 OCCUPIED BANDWIDTH.....   | 19        |
| 7.4 SPURIOUS AND HARMONIC EMISSIONS AT ANTENNA TERMINAL.....            | 19        |
| 7.5 BAND EDGE.....  | 19        |
| 7.6 EFFECTIVE RADIATED POWER.....                                       | 20        |
| 7.7 EQUIVALENT ISOTROPIC RADIATED POWER .....                           | 20        |
| 7.8 RADIATED SPURIOUS EMISSIONS .....                                   | 21        |
| 7.8.1 RADIATED SPURIOUS EMISSIONS (Cellular CDMA 1x).....               | 21        |
| 7.8.2 RADIATED SPURIOUS EMISSIONS (Cellular CDMA 1x EVDO (Rev. A))..... | 22        |
| 7.8.3 RADIATED SPURIOUS EMISSIONS (PCS CDMA 1x).....                    | 23        |
| 7.8.4 RADIATED SPURIOUS EMISSIONS (PCS CDMA 1x EVDO (Rev. A)).....      | 24        |
| 7.9 FREQUENCY STABILITY / VARIATION OF AMBIENT TEMPERATURE .....        | 25        |
| 7.9.1 FREQUENCY STABILITY (Cellular CDMA 1x).....                       | 25        |
| 7.9.2 FREQUENCY STABILITY (Cellular CDMA 1x EVDO (Rev. A)) .....        | 26        |
| 7.9.3 FREQUENCY STABILITY (PCS CDMA 1x).....                            | 27        |
| 7.9.4 FREQUENCY STABILITY (PCS CDMA 1xEVDO (Rev. A)).....               | 28        |
| <b>8. TEST PLOTS .....</b>  | <b>29</b> |
| 8.1 Peak to Average Ratio.....  | 29        |
| 8.2 Occupied Bandwidth (99 % Bandwidth).....                            | 30        |
| 8.3 Spurious Emissions at Antenna Terminal .....                        | 38        |
| 8.4 Band Edge .....   | 48        |

## 1. GENERAL INFORMATION

**Applicant Name:** LG Innotek Co.,Ltd.

**Address:** 978-1, Jangduk-dong, Gwangsan-gu, Gwangju-City, South Korea

**FCC ID** : YZP-VL2000

**FCC Classification** : PCS Licensed Transmitter (PCB)

**EUT** : Telematics Modem

**Model Name** : LTD-VL2000

**Add Model Name** : N/A

**Supplying power** : DC 12V

**Antenna Information** : Cellular & PCS band for CDMA 1x EVDO(Rev. A) : External type  
LTE for Band 13 and Band 4 : External type

| Mode                                | Tx Frequency (MHz)        | Emission Designator | Conducted Output Power |                  |
|-------------------------------------|---------------------------|---------------------|------------------------|------------------|
|                                     |                           |                     | Max. Power (W)         | Max. Power (dBm) |
| Cellular band CDMA 1x               | 824.70 MHz ~ 848.31 MHz   | 1M27F9W             | 0.267                  | 24.26            |
| Cellular band CDMA 1x EVDO(Rev. A): | 824.70 MHz ~ 848.31 MHz   | 1M27F9W             | 0.268                  | 24.28            |
| PCS band CDMA 1x                    | 1851.25 MHz ~ 1908.75 MHz | 1M27F9W             | 0.266                  | 24.25            |
| PCS band CDMA 1x EVDO(Rev. A):      | 1851.25 MHz ~ 1908.75 MHz | 1M27F9W             | 0.269                  | 24.29            |

## 2. INTRODUCTION

### 2.1. EUT DESCRIPTION

The Equipment Under Test(EUT) supports CDMA and EVDO(Rev. A) of Cellular/PCS bands and LTE(Band 4, 13). The EUT has below 2 transceivers.

1. CDMA 1x/ EVDO(Rev. A)
2. LTE

### 2.2. Support equipment

| Equipment | Model No. | Serial No. | Manufacturer | Note |
|-----------|-----------|------------|--------------|------|
| -         | -         | -          | -            | -    |
| -         | -         | -          | -            | -    |

Note: The above equipment was supported by manufacturer.

### 2.3. MEASURING INSTRUMENT CALIBRATION

The measuring equipment, which was utilized in performing the tests documented herein, has been calibrated in accordance with the manufacturer's recommendations for utilizing calibration equipment, which is traceable to recognized national standards.

### 2.4. TEST FACILITY

The 3m test site and conducted measurement facility used to collect the radiated data are located at the 42, Yurim-ro, 154beon-gil, Cheoin-gu, Yongin-si, Gyeonggi-do, Korea 449-935. The site is constructed in conformance with the requirements.

- 3m test site registration Number: 165783

### 3. DESCRIPTION OF TESTS

#### 3.1 ERP & EIRP

(Effective Radiated Power & Equivalent Isotropic Radiated Power)

##### *Test Set-up*

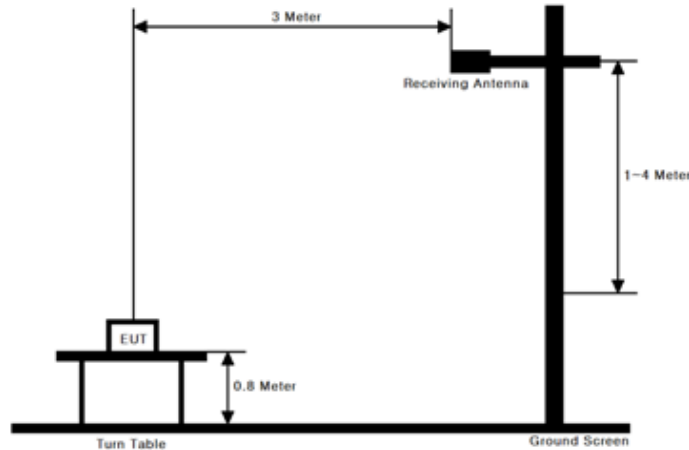

##### *Test Procedure*

- ANSI/TIA-603-C-2004 - Section 2.2.17
- KDB971168 v02r02 - Section 5.2.1

These measurements were performed at 3 & 10 m test site. The equipment under test is placed on a non-conductive table 0.8-meters above a turntable which is flush with the ground plane and 3 meters from the receive antenna.

##### Test setting

1. Set span to at least 1.5 times the OBW.
2. Set RBW = 1-5 % of the OBW, not to exceed 1 MHz.
3. Set VBW  $\geq 3 \times$  RBW.
4. Set number of points in sweep  $\geq 2 \times$  span / RBW.
5. Sweep time = auto couple.
6. Detector = RMS (power averaging).
7. If the EUT can be configured to transmit continuously (i.e., burst duty cycle  $\geq 98$  %), then set the trigger to free run.
8. If the EUT cannot be configured to transmit continuously (i.e., burst duty cycle  $< 98$  %), then use a sweep trigger with the level set to enable triggering only on full power bursts and configure the EUT to transmit at full power for the entire duration of each sweep.  
Ensure that the sweep time is less than or equal to the transmission burst duration.
9. Trace average at least 100 traces in power averaging (i.e., RMS) mode.
10. Compute the power by integrating the spectrum across the OBW of the signal using the instrument's band power measurement function, with the band limits set equal to the OBW band edges. If the instrument does not have a band power function, then sum the spectrum levels (in linear power units) at intervals equal to the RBW extending across the entire OBW of the spectrum.

The receive antenna height and turntable rotations were adjusted for the highest reading on the receive spectrum analyzer.

A half-wave dipole was substituted in place of the EUT. This dipole antenna was driven by a signal generator and the level of the signal generator was adjusted to obtain the same receive spectrum analyzer reading. The conducted power at the terminal of the substitute antenna is measured.

The ERP/EIRP is calculated using the following formula:

**ERP/EIRP = The conducted power at the substitute antenna's terminal [dBm] + Substitute Antenna gain [dBd for ERP , dBi for EIRP]**

For readings above 1 GHz, the above procedure is repeated using horn antennas and the difference between the gain of the horn antenna and an isotropic antenna are taken into consideration.

## 3.2 PEAK TO AVERAGE RATIO

### Test set-up

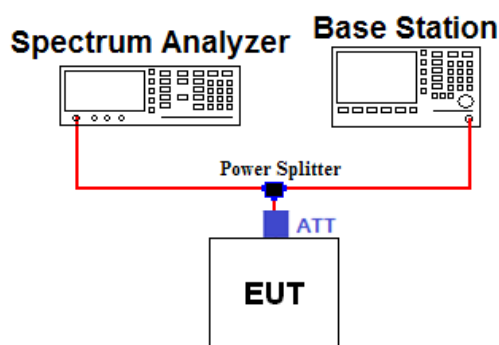

### Test Procedure

A peak to average ratio measurement is performed using the following procedure.

#### ■ CCDF Procedure

##### - KDB971168 v02r02-Section 5.7.1

1. Set resolution/measurement bandwidth  $\geq$  signal's occupied bandwidth
2. Set the number of counts to a value that stabilizes the measured CCDF curve
3. Set the measurement interval as follows:
  - 1) For continuous transmissions, set to 1 ms
  - 2) For burst transmissions, employ an external trigger that is synchronized with the EUT burst timing sequence, or use the internal burst trigger with a trigger level that allows the burst to stabilize and set the measurement interval to a time that is less than or equal to the burst duration.
4. Record the maximum PAPR level associated with a probability of 0.1%



**■ Alternate Procedure****- KDB971168 v02r02-Section 5.7.2**

Use one of the measurement procedures of the peak power and record as  $P_{Pk}$ .

Use one of the measurement procedures of the average power and record as  $P_{Avg}$ .

Both the peak and average power levels must be expressed in the same logarithmic units (e.g., dBm). Determine the PAPR from:

$$\text{PAPR (dB)} = P_{Pk} \text{ (dBm)} - P_{Avg} \text{ (dBm)}.$$

**- Peak Power Measurement**

1. Set the RBW  $\geq$  OBW
2. Set VBW  $\geq 3 \times$  RBW
3. Set span  $\geq 2 \times$  RBW
4. Sweep time = auto couple
5. Detector = peak
6. Ensure that the number of measurement points  $\geq$  span/RBW.
7. Trace mode = max hold
8. Allow trace to fully stabilize.
9. Use the peak marker function to determine the peak amplitude level.

**- Average Power Measurement**

1. Set span to at least 1.5 times the OBW.
2. Set RBW = 1-5% of the OBW, not to exceed 1 MHz.
3. Set VBW  $\geq 3 \times$  RBW.
4. Set number of points in sweep  $\geq 2 \times$  span / RBW.
5. Sweep time = auto-couple.
6. Detector = RMS (power averaging).
7. If the EUT can be configured to transmit continuously (i.e., burst duty cycle  $\geq 98\%$ ), then set the trigger to free run.
8. If the EUT cannot be configured to transmit continuously (i.e., burst duty cycle  $< 98\%$ ), then use a sweep trigger with the level set to enable triggering only on full power bursts and configure the EUT to transmit at full power for the entire duration of each sweep.  
Ensure that the sweep time is less than or equal to the transmission burst duration.
9. Trace average at least 100 traces in power averaging (i.e., RMS) mode.
10. Compute the power by integrating the spectrum across the OBW of the signal using the instrument's band power measurement function, with the band limits set equal to the OBW band edges. If the instrument does not have a band power function, then sum the spectrum levels (in linear power units) at intervals equal to the RBW extending across the entire OBW of the spectrum.

### 3.3 OCCUPIED BANDWIDTH.

#### Test set-up

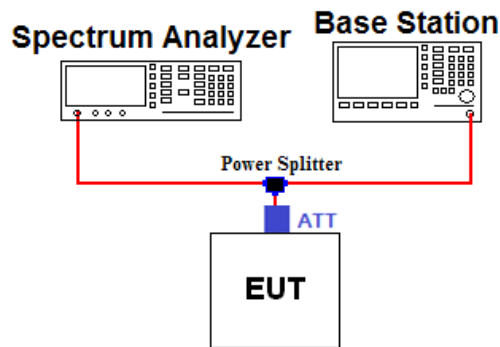

#### Offset value information

| Frequency (MHz) | Offset Value (dB) | Frequency (MHz) | Offset Value (dB) |
|-----------------|-------------------|-----------------|-------------------|
| 824.70          | 12.20             | 1851.25         | 12.17             |
| 836.52          | 12.21             | 1880.00         | 12.17             |
| 848.31          | 12.23             | 1908.75         | 12.21             |
| -               | -                 | -               | -                 |
| -               | -                 | -               | -                 |
| -               | -                 | -               | -                 |

Note. 1: The offset values from EUT to Spectrum analyzer were measured and used for test.  
Offset value = Cable A + Splitter + ATT + Cable B

#### Test Procedure

##### - KDB971168 v02r02-Section 4.2

The occupied bandwidth, that is the frequency bandwidth such that, below its lower and above its upper frequency limits, the mean powers radiated are each equal to 0.5 percent of the total mean power of a given emission.

#### Test setting

1. The signal analyzer's automatic bandwidth measurement capability was used to perform the 99 % occupied bandwidth and the 26 dB bandwidth. The bandwidth measurement was not influenced by any intermediate power nulls in the fundamental emission.
2.  $RBW = 1 \sim 5 \%$  of the expected OBW &  $VBW \geq 3 \times RBW$
3. Detector = Peak
4. Trance mode = Max hold
5. Sweep = Auto couple
6. The trace was allowed to stabilize
7. If necessary, step 2 ~ 6 were repeated after changing the RBW such that it would be within 1 ~ 5 % of the 99 % occupied bandwidth observed in step 6.

### 3.4 BAND EDGE EMISSIONS AT ANTENNA TERMINAL.

#### Test set-up

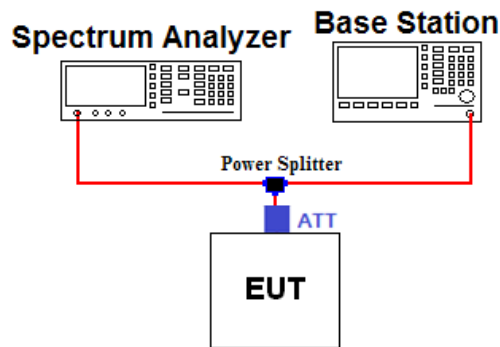

#### Offset value information

| Frequency (MHz) | Offset Value (dB) | Frequency (MHz) | Offset Value (dB) |
|-----------------|-------------------|-----------------|-------------------|
| 824.70          | 12.20             | 1851.25         | 12.17             |
| 836.52          | 12.21             | 1880.00         | 12.17             |
| 848.31          | 12.23             | 1908.75         | 12.21             |
| -               | -                 | -               | -                 |
| -               | -                 | -               | -                 |

Note. 1: The offset value from EUT to Spectrum analyzer was measured and used for test.  
Offset value = Cable A + Splitter + ATT + Cable B

#### Test Procedure

##### - KDB971168 v02r02 - Section 6.0

All out of band emissions are measured by means of a calibrated spectrum analyzer. The EUT was setup to maximum output power at its lowest and highest channel with all modulations.

The power of any spurious emission shall be attenuated below the transmitter power (P) by at least  $43 + 10 \log(P)$  dB

#### Test setting

1. Start and stop frequency were set such that the band edge would be placed in the center of the plot
2. Span was set large enough so as to capture all out of band emissions near the band edge
3. RBW  $\geq 1\%$  of the emission
4. VBW  $\geq 3 \times$  RBW
5. Detector = RMS & Trace mode = Max hold
6. Sweep time = Auto couple or 1 s for band edge
7. Number of sweep point  $\geq 2 \times$  span / RBW
8. The trace was allowed to stabilize

Note 1: In the 1 MHz bands immediately outside and adjacent to the frequency block a resolution bandwidth of **at least one percent** of the emission bandwidth of the fundamental emission of the transmitter may be employed to demonstrate compliance with the out-of-band emissions limit. The emission bandwidth is defined as the width of the signal between two points, one below the carrier center frequency and one above the carrier center frequency, outside of which all emission are attenuated at least 26 dB below the transmitter power.

### 3.5 SPURIOUS AND HARMONIC EMISSIONS AT ANTENNA TERMINAL.

#### Test set-up

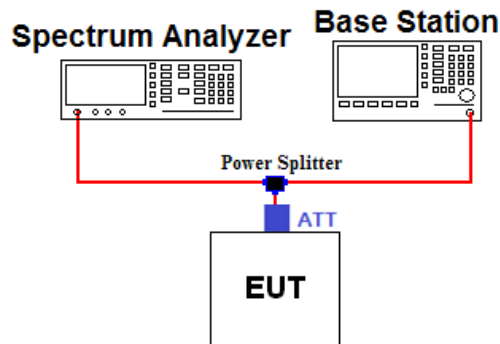

#### Offset value information

| Frequency (MHz) | Offset Value (dB) | Frequency (MHz) | Offset Value (dB) |
|-----------------|-------------------|-----------------|-------------------|
| 5000.0          | 13.16             | 15000.0         | 15.22             |
| 10000.0         | 14.27             | 20000.0         | 16.02             |
| -               | -                 | -               | -                 |
| -               | -                 | -               | -                 |

Note. 1: The offset value from EUT to Spectrum analyzer was measured and used for test.  
Offset value = Cable A + Splitter + ATT + Cable B

#### Test Procedure

##### - KDB971168 v02r02 - Section 6.0

The level of the carrier and the various conducted spurious and harmonic frequencies is measured by means of a calibrated spectrum analyzer. The EUT was setup to maximum output power at its low, middle, high channel with all bandwidths. The spectrum is scanned from 30 MHz up to a frequency including its 10<sup>th</sup> harmonic.

The power of any spurious emission shall be attenuated below the transmitter power (P) by at least  $43 + 10 \log(P)$  dB

#### Test setting

1. RBW = 100 KHz or 1 MHz & VBW  $\geq 3 \times$  RBW ( Refer to Note 1)
2. Detector = RMS & Trace mode = Max hold
3. Sweep time = Auto couple
4. Number of sweep point  $\geq 2 \times$  span / RBW
5. The trace was allowed to stabilize

Note 1: Compliance with these provisions is based on the use of measurement instrumentation employing a resolution bandwidth of 100 kHz or greater for Part 22 and 1 MHz or greater for Part 24.

### 3.6 RADIATED SPURIOUS EMISSIONS

#### Test Set-up

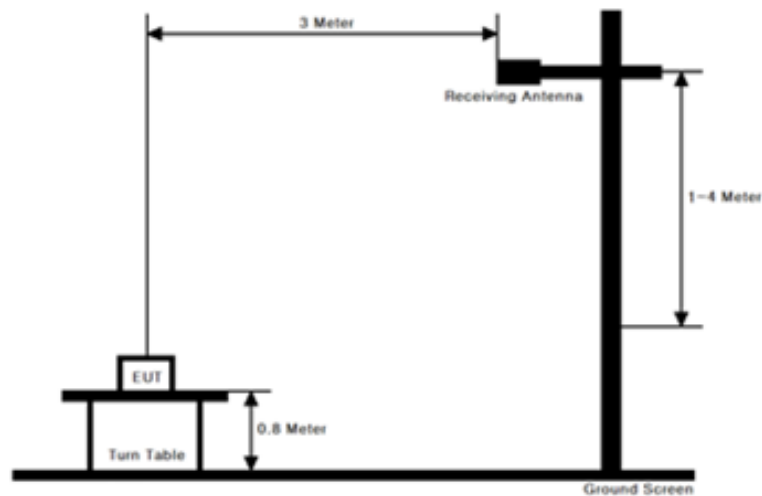

#### Test Procedure

- ANSI/TIA-603-C-2004 - Section 2.2.12
- KDB971168 v02r02 - Section 5.8

These measurements were performed at 3 & 10m test site. The equipment under test is placed on a non-conductive table 0.8-meters above a turntable which is flush with the ground plane and 3 meters from the receive antenna.

#### Test setting

1. RBW = 100 kHz for below 1 GHz and 1 MHz for above 1 GHz / VBW  $\geq$  3 X RBW
2. Detector = Peak & Trace mode = Max hold
3. Sweep time = Auto couple
4. Number of sweep point  $\geq$  2 X span / RBW
5. The trace was allowed to stabilize

The receive antenna height and turntable rotations were adjusted for the highest reading on the receive spectrum analyzer.

For radiated power measurements below 1 GHz, a half-wave dipole was substituted in place of the EUT. This dipole antenna was driven by a signal generator and the level of the signal generator was adjusted to obtain the same spectrum analyzer reading.

For radiated power measurements above 1 GHz, a Horn antenna was substituted in place of the EUT. This Horn antenna was driven by a signal generator and the level of the signal generator was adjusted to obtain the same spectrum analyzer reading. The difference between the gain of the horn and an isotropic antenna are taken into consideration.

This measurement was performed with the EUT oriented in 3 orthogonal axis.

### 3.7 FREQUENCY STABILITY / VARIATION OF AMBIENT TEMPERATURE

#### Test Set-up

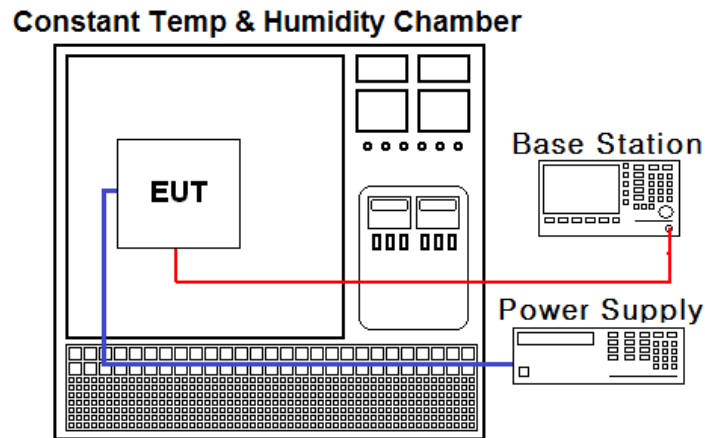

#### Test Procedure

- ANSI/TIA-603-C-2004
- KDB971168 v02r02 - Section 9.0

The frequency stability of the transmitter is measured by:

#### a.) Temperature:

The temperature is varied from - 30 °C to + 50 °C using an environmental chamber.

#### b.) Primary Supply Voltage:

The primary supply voltage is varied from 85 % to 115 % of the nominal value for non hand-carried battery and AC powered equipment. For hand-carried, battery-powered equipment, primary supply voltage is reduced to the battery operating end point which shall be specified by the manufacturer.

#### Specification:

The frequency stability shall be sufficient to ensure that the fundamental emission stays within the authorized frequency block for Part 24. The frequency stability of the transmitter shall be maintained within  $\pm 0.00025\%$  ( $\pm 2.5$  ppm) of the center frequency for Part 22.

#### Time Period and Procedure:

1. The carrier frequency of the transmitter is measured at room temperature.  
(25 °C to provide a reference)
2. The equipment is turned on in a “standby” condition for one minute before applying power to the transmitter. Measurement of the carrier frequency of the transmitter is made within one minute after applying power to the transmitter.
3. Frequency measurements are made at 10 °C intervals ranging from -30 °C to +50 °C.  
A period of at least one half-hour is provided to allow stabilization of the equipment at each temperature level.

**4. LIST OF TEST EQUIPMENT**

| Type                                   | Manufacturer         | Model                       | Cal.Date<br>(yy/mm/dd) | Next.Cal. Date<br>(yy/mm/dd) | S/N              |
|--|----------------------|-----------------------------|------------------------|------------------------------|------------------|
| Signal Generator                       | Rohde Schwarz        | SMF100A                     | 14/07/01               | 15/07/01                     | 102341           |
| Vector Signal Generator                | Rohde Schwarz        | SMBV100A                    | 15/01/06               | 16/01/06                     | 255571           |
| Digital Multimeter                     | FLUKE                | 17B                         | 14/05/12               | 15/05/12                     | 26030065WS       |
| Thermohygrometer                       | BODYCOM              | BJ5478                      | 15/02/26               | 16/02/26                     | 1209             |
| MXA Signal Analyzer                    | Agilent Technologies | N9020A                      | 14/09/15               | 15/09/15                     | MY50200867       |
| Dynamic Measurement DC Source          | Agilent Technologies | 66332A                      | 14/09/11               | 15/09/11                     | MY43000211       |
| Temp & Humi Test Chamber               | SJ Science           | SJ-TH-S50                   | 14/10/21               | 15/10/21                     | SJ-TH-S50-130930 |
| 8960 Series 10 Wireless Comms Test Set | Agilent Technologies | E5515C                      | 14/09/12               | 15/09/12                     | GB41321164       |
| Power Splitter                         | Anritsu              | K241B                       | 14/10/21               | 15/10/21                     | 1701061          |
| 2W 3dB Attenuator                      | SMAJK                | SMAJK-2-3                   | 14/10/21               | 15/10/21                     | 3                |
| 2W 3dB Attenuator                      | SMAJK                | SMAJK-2-3                   | 14/10/21               | 15/10/21                     | 4                |
| Dipole Antenna                         | Schwarzbeck          | VHA9103                     | 13/10/24               | 15/10/24                     | 2116             |
| Dipole Antenna                         | Schwarzbeck          | VHA9103                     | 14/04/01               | 16/04/01                     | 2117             |
| Dipole Antenna                         | Schwarzbeck          | UHA9105                     | 13/10/24               | 15/10/24                     | 2261             |
| Dipole Antenna                         | Schwarzbeck          | UHA9105                     | 14/04/01               | 16/04/01                     | 2262             |
| HORN ANT                               | ETS                  | 3115                        | 15/02/09               | 17/02/09                     | 00021097         |
| HORN ANT                               | ETS                  | 3117                        | 14/05/12               | 16/05/12                     | 140394           |
| HORN ANT                               | A.H.Systems          | SAS-574                     | 13/03/20               | 15/03/20                     | 154              |
| HORN ANT                               | A.H.Systems          | SAS-574                     | 13/05/27               | 15/05/27                     | 155              |
| Low Noise Pre Amplifier                | TSJ                  | MLA-010K01-B01-27           | 14/04/09               | 15/04/09                     | 1844538          |
| Amplifier (30dB)                       | Agilent              | 8449B                       | 14/11/06               | 15/11/06                     | 3008A02108       |
| High-pass filter                       | Wainwright           | WHKX12-935-1000-15000-40SS  | 14/09/11               | 15/09/11                     | 7                |
| High-pass filter                       | Wainwright           | WHKX12-2580-3000-18000-80SS | 14/09/11               | 15/09/11                     | 3                |
| TRILOG Broadband Test-Antenna          | SCHWARZBECK          | VULB 9160                   | 14/04/04               | 16/04/04                     | 3357             |
| Amplifier                              | EMPOWER              | BBS3Q7ELU                   | 14/09/12               | 15/09/12                     | 1020             |

**5. SUMMARY OF TEST RESULTS**

| <b>FCC Part Section(s)</b>       | <b>RSS Section(s)</b>  | <b>Parameter</b>   | <b>Status</b><br>Note 1 |
|----------------------------------|--|--|-------------------------|
| 2.1046                           | RSS-132 (5.4)<br>RSS-133 (4.1)   | Conducted Output Power   | <b>C</b>                |
| 22.913(a)<br>24.232(c)           | RSS-132 [5.4]<br>[SRSP-503(5.1.3)]<br>RSS-133 [6.4]<br>[SRSP-510(5.1.2)] | Effective Radiated Power<br>Equivalent Isotropic Radiated Power  | <b>C</b>                |
| 22.917(a)<br>24.238(a)<br>2.1049 | RSS-Gen [6.6]  | Occupied Bandwidth   | <b>C</b>                |
| 22.917(a)<br>24.238(a)<br>2.1051 | RSS-132 [5.5]<br>RSS-133 [6.5]   | Band Edge<br>Spurious and Harmonic Emissions at Antenna Terminal | <b>C</b>                |
| 24.232(d)                        | RSS-133 [6.4]  | Peak to Average Ratio  | <b>C</b>                |
| 22.917(a)<br>24.238(a)<br>2.1053 | RSS-132 [5.5]<br>RSS-133 [6.5]   | Radiated Spurious and Harmonic Emissions                         | <b>C</b>                |
| 22.355<br>24.235<br>2.1055       | RSS-132 [5.3]<br>RSS-133 [6.3]   | Frequency Stability  | <b>C</b>                |

Note 1: **C**=Comply    **NC**=Not Comply    **NT**=Not Tested    **NA**=Not Applicable

Note 2: This test report is for CDMA 1x and CDMA 1x EVDO(Rev. A) functions.

The sample was tested according to the following specification:  
**ANSI/TIA/EIA-603-C-2004 and KDB 971168 D01 v02r02**



## 6. SAMPLE CALCULATION

### A. Emission Designator

#### Cellular CDMA1x

Emission Designator = **1M27F9W**  
 CDMAOBW = 1.2694 MHz  
 (Measured at the 99.75% power bandwidth)  
 F = Frequency Modulation  
 9 = Composite Digital Information  
 W = Combination (Audio/Data)

#### PCS CDMA1x

Emission Designator = **1M27F9W**  
 CDMAOBW = 1.2723 MHz  
 (Measured at the 99.75% power bandwidth)  
 F = Frequency Modulation  
 9 = Composite Digital Information  
 W = Combination (Audio/Data)

#### Cellular CDMA 1x EVDO(Rev. A)

Emission Designator = **1M27F9W**  
 CDMAOBW = 1.2704 MHz  
 (Measured at the 99.75% power bandwidth)  
 F = Frequency Modulation  
 9 = Composite Digital Information  
 W = Combination (Audio/Data)

#### PCS CDMA 1x EVDO(Rev. A)

Emission Designator = **1M27F9W**  
 CDMAOBW = 1.2734 MHz  
 (Measured at the 99.75% power bandwidth)  
 F = Frequency Modulation  
 9 = Composite Digital Information  
 W = Combination (Audio/Data)

### B. RADIATED SPURIOUS EMISSIONS Sample Calculation

| MODE    | Spectrum Reading |             | EUT Axis | Ant Pol (H/V) | Level(dBm)<br>@ Ant Terminal | TX Ant<br>Gain(dBd) | Result |             |
|---------|------------------|-------------|----------|---------------|------------------------------|---------------------|--------|-------------|
|         | Freq.(MHz)       | Value (dBm) |          |               |                              |                     | (dBm)  | Margin (dB) |
| CDMA850 | 1650.22          | -60.09      | Y        | H             | -59.49                       | 6.64                | -52.85 | 39.85       |

#### RADIATED SPURIOUS EMISSIONS = @ Ant Terminal LEVEL(dBm) + Ant. Gain

- 1) The EUT mounted on a non-conductive turntable is 0.8 meter above test site ground level.
- 2) During the test, the turn table is rotated until the maximum signal is found.
- 3) Record the field strength meter's level.
- 4) Replace the EUT with dipole/Horn antenna that is connected to a calibrated signal generator.
- 5) Increase the signal generator output till the field strength meter's level is equal to the item (3).
- 6) The signal generator output level with Ant. Gain is the rating of RADIATED SPURIOUS EMISSIONS.

## 7. TEST DATA

### 7.1 CONDUCTED OUTPUT POWER

A base station simulator was used to establish communication with the EUT. The base station simulator parameters were set to produce the maximum power from the EUT. This device was tested under all configurations and the highest power is reported. Conducted Output Powers of EUT are reported below.

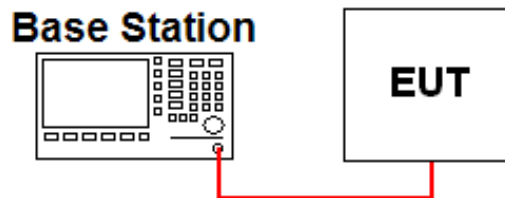

The output power was measured using the Agilent E5515C

•CDMA

| Band     | CH.  | CDMA 1x      |       |       |       |            |              | EVDO   |              |
|----------|------|--------------|-------|-------|-------|------------|--------------|--------|--------------|
|          |      | RC1          |       | RC3   |       |            |              | Rev. 0 | Rev. A       |
|          |      | SO 2         | SO55  | SO 2  | SO55  | SO32 (SCH) | SO32 (F-SCH) | RTAP   | RETAP        |
| Cellular | 1013 | 24.06        | 23.99 | 24.05 | 23.98 | 24.02      | 24.03        | 24.05  | 24.25        |
|          | 384  | <b>24.26</b> | 24.17 | 24.23 | 24.17 | 24.22      | 24.24        | 24.18  | <b>24.28</b> |
|          | 777  | 24.18        | 23.97 | 24.15 | 24.11 | 24.05      | 24.04        | 24.07  | 24.09        |
| PCS      | 25   | 24.17        | 24.12 | 24.28 | 24.14 | 24.15      | 24.15        | 24.15  | 24.19        |
|          | 600  | <b>24.25</b> | 24.23 | 24.22 | 24.24 | 24.22      | 24.24        | 24.25  | <b>24.29</b> |
|          | 1175 | 24.05        | 24.01 | 24.03 | 24.03 | 23.99      | 23.98        | 24.04  | 24.08        |

## 7.2 PEAK TO AVERAGE RATIO

- Plots of the EUT's Peak- to- Average Ratio are shown in Clause 8.1

## 7.3 OCCUPIED BANDWIDTH

| Band     | Mode            | Channel     | Test Result(KHz) |
|----------|-----------------|-------------|------------------|
| Cellular | CDMA 1x         | <b>1013</b> | <b>1269.40</b>   |
|          |                 | 384         | 1267.50          |
|          |                 | 777         | 1268.90          |
|          | CDMA 1x<br>EVDO | 1013        | 1269.70          |
|          |                 | <b>384</b>  | <b>1270.40</b>   |
|          |                 | 777         | 1266.70          |
| PCS      | CDMA 1x         | <b>25</b>   | <b>1272.30</b>   |
|          |                 | 600         | 1269.80          |
|          |                 | 1175        | 1269.70          |
|          | CDMA 1x<br>EVDO | 25          | 1272.90          |
|          |                 | 600         | 1268.70          |
|          |                 | <b>1175</b> | <b>1273.40</b>   |

- Plots of the EUT's Occupied Bandwidth are shown in Clause 8.2

## 7.4 SPURIOUS AND HARMONIC EMISSIONS AT ANTENNA TERMINAL

- Plots of the EUT's Conducted Spurious Emissions are shown in Clause 8.3

## 7.5 BAND EDGE

- Plots of the EUT's Band Edge are shown in Clause 8.4

**7.6 EFFECTIVE RADIATED POWER**

| Band     | Mode         | Maximum Output Power(dBm) | Antenna Gain (dBd) | ERP (dBm) | LIMIT (dBm) |
|----------|--------------|---------------------------|--------------------|-----------|-------------|
| Cellular | CDMA 1X      | 25.50                     | 3.85               | 29.35     | 38.45       |
| Cellular | CDMA 1X EVDO | 25.50                     | 3.85               | 29.35     | 38.45       |

**Note.**

The maximum output power used max tune-up power.

Available max Antenna gain is 6 dBi in cellular band of CDMA, and compliant with MPE requirement.

**7.7 EQUIVALENT ISOTROPIC RADIATED POWER**

| Band | Mode         | Maximum Output Power(dBm) | Antenna Gain (dBi) | EIRP (dBm) | LIMIT (dBm) |
|------|--------------|---------------------------|--------------------|------------|-------------|
| PCS  | CDMA 1X      | 25.50                     | 7.50               | 33.00      | 33.01       |
| PCS  | CDMA 1X EVDO | 25.50                     | 7.50               | 33.00      | 33.01       |

**Note.**

The maximum output power used max tune-up power.

Available max Antenna gain is 7.00 dBi in pcs band of CDMA, and compliant with MPE requirement.

**7.8 RADIATED SPURIOUS EMISSIONS****7.8.1 RADIATED SPURIOUS EMISSIONS (Cellular CDMA 1x)**

| Channel | Freq. (MHz) | EUT Position (Axis) | POL (H/V) | LEVEL@ ANTENNA TERMINAL (dBm) | Substitute Antenna Gain (dBd) | Correct Generator Level (dBm) | Margin (dB) | Limit (dBm) |
|---------|-------------|---------------------|-----------|-------------------------------|-------------------------------|-------------------------------|-------------|-------------|
| 1013    | 1650.22     | Y                   | H         | -59.49                        | 6.64                          | -52.85                        | 39.85       | -13.00      |
|         | 4945.88     | Y                   | H         | -51.28                        | 8.55                          | -42.73                        | 29.73       |             |
|         | 7419.13     | Y                   | H         | -53.32                        | 9.39                          | -43.93                        | 30.93       |             |
|         | 8250.56     | Y                   | H         | -45.17                        | 9.19                          | -35.98                        | 22.98       |             |
| 384     | 1673.66     | Y                   | H         | -58.64                        | 6.66                          | -51.98                        | 38.98       |             |
|         | 5019.82     | Y                   | H         | -46.62                        | 8.54                          | -38.08                        | 25.08       |             |
|         | 7528.92     | Y                   | H         | -52.94                        | 9.35                          | -43.59                        | 30.59       |             |
|         | 8367.73     | Y                   | H         | -49.26                        | 9.19                          | -40.07                        | 27.07       |             |
| 777     | 1695.46     | Y                   | H         | -59.74                        | 6.69                          | -53.05                        | 40.05       |             |
|         | 5087.88     | Y                   | H         | -47.14                        | 8.57                          | -38.57                        | 25.57       |             |
|         | 7637.85     | Y                   | H         | -54.07                        | 9.31                          | -44.76                        | 31.76       |             |
|         | 8482.03     | Y                   | H         | -50.460                       | 9.19                          | -41.27                        | 28.27       |             |

- No other spurious and harmonic emissions were reported greater than listed emissions above table.

**NOTES:**

This EUT was tested under all configurations and the highest power is reported and CDMA 1x EVDO mode used a Power control bits of "All up". Also, we have done x, y, z planes in EUT and horizontal and vertical polarization of detecting antenna.

The worst case data is reported.

**7.8.2 RADIATED SPURIOUS EMISSIONS (Cellular CDMA 1x EVDO (Rev. A))**

| Channel | Freq. (MHz) | EUT Position (Axis) | POL (H/V) | LEVEL@ ANTENNA TERMINAL (dBm) | Substitute Antenna Gain (dBd) | Correct Generator Level (dBm) | Margin (dB) | Limit (dBm) |
|---------|-------------|---------------------|-----------|-------------------------------|-------------------------------|-------------------------------|-------------|-------------|
| 1013    | 1650.39     | Y                   | H         | -59.96                        | 6.64                          | -53.32                        | 40.32       | -13.00      |
|         | 4945.95     | Y                   | H         | -51.68                        | 8.55                          | -43.13                        | 30.13       |             |
|         | 7418.89     | Y                   | H         | -54.28                        | 9.40                          | -44.88                        | 31.88       |             |
|         | 8250.78     | Y                   | H         | -45.04                        | 9.19                          | -35.85                        | 22.85       |             |
| 384     | 1673.39     | Y                   | H         | -58.44                        | 6.66                          | -51.78                        | 38.78       |             |
|         | 5019.79     | Y                   | H         | -46.19                        | 8.54                          | -37.65                        | 24.65       |             |
|         | 7528.81     | Y                   | H         | -52.48                        | 9.35                          | -43.13                        | 30.13       |             |
|         | 8367.55     | Y                   | H         | -49.71                        | 9.19                          | -40.52                        | 27.52       |             |
| 777     | 1696.03     | Y                   | H         | -59.58                        | 6.69                          | -52.89                        | 39.89       |             |
|         | 5087.83     | Y                   | H         | -46.91                        | 8.57                          | -38.34                        | 25.34       |             |
|         | 7636.03     | Y                   | H         | -54.93                        | 9.31                          | -45.62                        | 32.62       |             |
|         | 8483.88     | Y                   | H         | -49.780                       | 9.19                          | -40.59                        | 27.59       |             |

- No other spurious and harmonic emissions were reported greater than listed emissions above table.

**NOTES:**

This EUT was tested under all configurations and the highest power is reported and CDMA 1x EVDO mode used a Power control bits of "All up". Also, we have done x, y, z planes in EUT and horizontal and vertical polarization of detecting antenna.

The worst case data is reported.

**7.8.3 RADIATED SPURIOUS EMISSIONS (PCS CDMA 1x)**

| Channel | Freq. (MHz) | EUT Position (Axis) | POL (H/V) | LEVEL@ ANTENNA TERMINAL (dBm) | Substitute Antenna Gain (dBi) | Correct Generator Level (dBm) | Margin (dB) | Limit (dBm) |
|---------|-------------|---------------------|-----------|-------------------------------|-------------------------------|-------------------------------|-------------|-------------|
| 25      | 3702.13     | Y                   | H         | -35.14                        | 9.91                          | -25.23                        | 12.23       | -13.00      |
|         | 5554.77     | Y                   | H         | -49.24                        | 10.98                         | -38.26                        | 25.26       |             |
|         | 7404.81     | Y                   | H         | -43.45                        | 11.55                         | -31.90                        | 18.90       |             |
| 600     | 3760.80     | X                   | H         | -33.53                        | 9.85                          | -23.68                        | 10.68       |             |
|         | 5639.74     | Y                   | H         | -50.26                        | 11.11                         | -39.15                        | 26.15       |             |
|         | 7520.01     | Y                   | H         | -41.44                        | 11.51                         | -29.93                        | 16.93       |             |
| 1175    | 3816.86     | X                   | H         | -30.40                        | 9.80                          | -20.60                        | 7.60        |             |
|         | 5726.30     | Y                   | H         | -50.86                        | 11.24                         | -39.62                        | 26.62       |             |
|         | 7633.66     | Y                   | H         | -40.68                        | 11.47                         | -29.21                        | 16.21       |             |

- No other spurious and harmonic emissions were reported greater than listed emissions above table.

**NOTES:**

This EUT was tested under all configurations and the highest power is reported and CDMA 1x EVDO mode used a Power control bits of "All up". Also, we have done x, y, z planes in EUT and horizontal and vertical polarization of detecting antenna.

The worst case data is reported.

**7.8.4 RADIATED SPURIOUS EMISSIONS (PCS CDMA 1x EVDO (Rev. A))**

| Channel | Freq. (MHz) | EUT Position (Axis) | POL (H/V) | LEVEL@ ANTENNA TERMINAL (dBm) | Substitute Antenna Gain (dBi) | Correct Generator Level (dBm) | Margin (dB) | Limit (dBm) |
|---------|-------------|---------------------|-----------|-------------------------------|-------------------------------|-------------------------------|-------------|-------------|
| 25      | 3702.38     | Y                   | H         | -35.87                        | 9.91                          | -25.96                        | 12.96       | -13.00      |
|         | 5554.51     | Y                   | H         | -48.85                        | 10.98                         | -37.87                        | 24.87       |             |
|         | 7404.94     | Y                   | H         | -43.37                        | 11.55                         | -31.82                        | 18.82       |             |
| 600     | 3760.11     | X                   | H         | -33.30                        | 9.86                          | -23.44                        | 10.44       |             |
|         | 5639.48     | Y                   | H         | -50.10                        | 11.11                         | -38.99                        | 25.99       |             |
|         | 7520.03     | Y                   | H         | -41.57                        | 11.51                         | -30.06                        | 17.06       |             |
| 1175    | 3816.34     | X                   | H         | -30.03                        | 9.80                          | -20.23                        | 7.23        |             |
|         | 5726.11     | Y                   | H         | -50.67                        | 11.24                         | -39.43                        | 26.43       |             |
|         | 7634.07     | Y                   | H         | -40.05                        | 11.47                         | -28.58                        | 15.58       |             |

- No other spurious and harmonic emissions were reported greater than listed emissions above table.

**NOTES:**

This EUT was tested under all configurations and the highest power is reported and CDMA 1x EVDO mode used a Power control bits of "All up". Also, we have done x, y, z planes in EUT and horizontal and vertical polarization of detecting antenna.

The worst case data is reported.



### 7.9 FREQUENCY STABILITY / VARIATION OF AMBIENT TEMPERATURE

#### 7.9.1 FREQUENCY STABILITY (Cellular CDMA 1x)

OPERATING FREQUENCY : 836,520,000 Hz  
 CHANNEL : 384 (Mid)  
 REFERENCE VOLTAGE : 12.0 V DC  
 DEVIATION LIMIT : ± 0.00025 % or 2.5 ppm

| VOLTAGE (%)   | POWER (V DC) | TEMP (°C) | FREQ (Hz)   | Deviation |             |
|---------------|--------------|-----------|-------------|-----------|-------------|
|               |              |           |             | (ppm)     | (%)         |
| 100%          | 12.0         | +25(Ref)  | 836,520,015 | 0.018     | 0.00000179  |
| 100%          |              | -30       | 836,520,012 | 0.014     | 0.00000143  |
| 100%          |              | -20       | 836,520,014 | 0.017     | 0.00000167  |
| 100%          |              | -10       | 836,519,994 | -0.007    | -0.00000072 |
| 100%          |              | 0         | 836,519,992 | -0.010    | -0.00000096 |
| 100%          |              | +10       | 836,519,987 | -0.016    | -0.00000155 |
| 100%          |              | +20       | 836,520,014 | 0.017     | 0.00000167  |
| 100%          |              | +30       | 836,519,983 | -0.020    | -0.00000203 |
| 100%          |              | +40       | 836,520,011 | 0.013     | 0.00000131  |
| 100%          |              | +50       | 836,520,010 | 0.012     | 0.00000120  |
| 85%           | 10.2         | +25       | 836,519,991 | -0.011    | -0.00000108 |
| 115%          | 13.8         | +25       | 836,520,015 | 0.018     | 0.00000179  |
| BATT.ENDPOINT | N/A          | -         | -           | -         | -           |

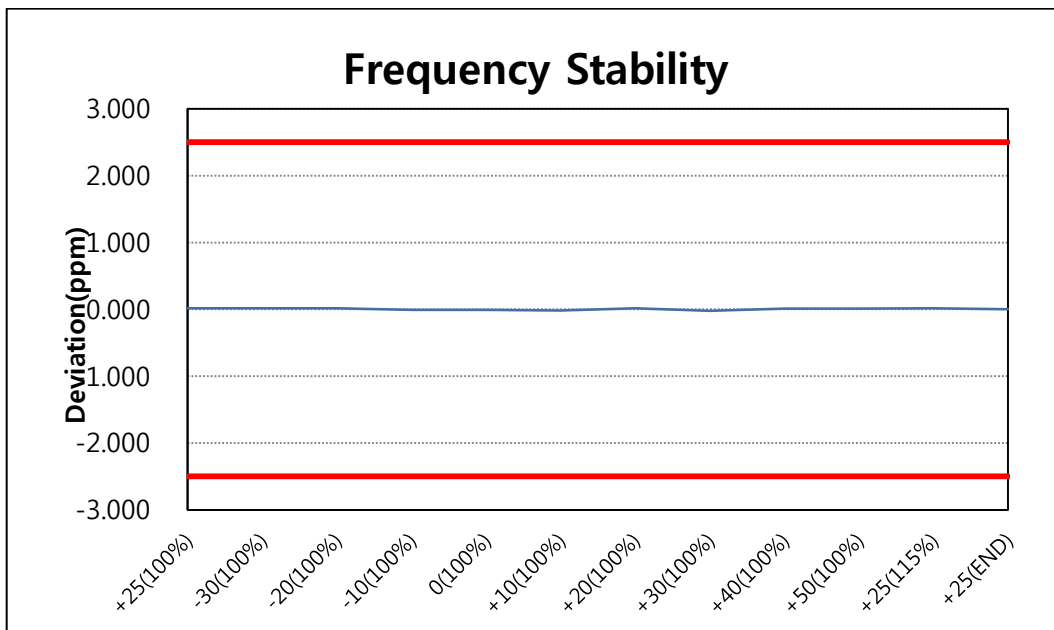

**7.9.2 FREQUENCY STABILITY (Cellular CDMA 1x EVDO (Rev. A))**

OPERATING FREQUENCY : 836,520,000 Hz  
 CHANNEL : 384 (Mid)  
 REFERENCE VOLTAGE : 3.800 V DC  
 DEVIATION LIMIT : ± 0.00025 % or 2.5 ppm

| VOLTAGE (%)   | POWER (V DC) | TEMP (°C) | FREQ (Hz)   | Deviation |             |
|---------------|--------------|-----------|-------------|-----------|-------------|
|               |              |           |             | (ppm)     | (%)         |
| 100%          | 12.0         | +25(Ref)  | 836,519,987 | -0.016    | -0.00000155 |
| 100%          |              | -30       | 836,520,007 | 0.008     | 0.00000084  |
| 100%          |              | -20       | 836,520,008 | 0.010     | 0.00000096  |
| 100%          |              | -10       | 836,520,005 | 0.006     | 0.00000060  |
| 100%          |              | 0         | 836,519,986 | -0.017    | -0.00000167 |
| 100%          |              | +10       | 836,519,990 | -0.012    | -0.00000120 |
| 100%          |              | +20       | 836,519,993 | -0.008    | -0.00000084 |
| 100%          |              | +30       | 836,519,996 | -0.005    | -0.00000048 |
| 100%          |              | +40       | 836,520,014 | 0.017     | 0.00000167  |
| 100%          |              | +50       | 836,520,011 | 0.013     | 0.00000131  |
| 85%           | 10.2         | +25       | 836,519,992 | -0.010    | -0.00000096 |
| 115%          | 13.8         | +25       | 836,519,985 | -0.018    | -0.00000179 |
| BATT.ENDPOINT | N/A          | -         | -           | -         | -           |

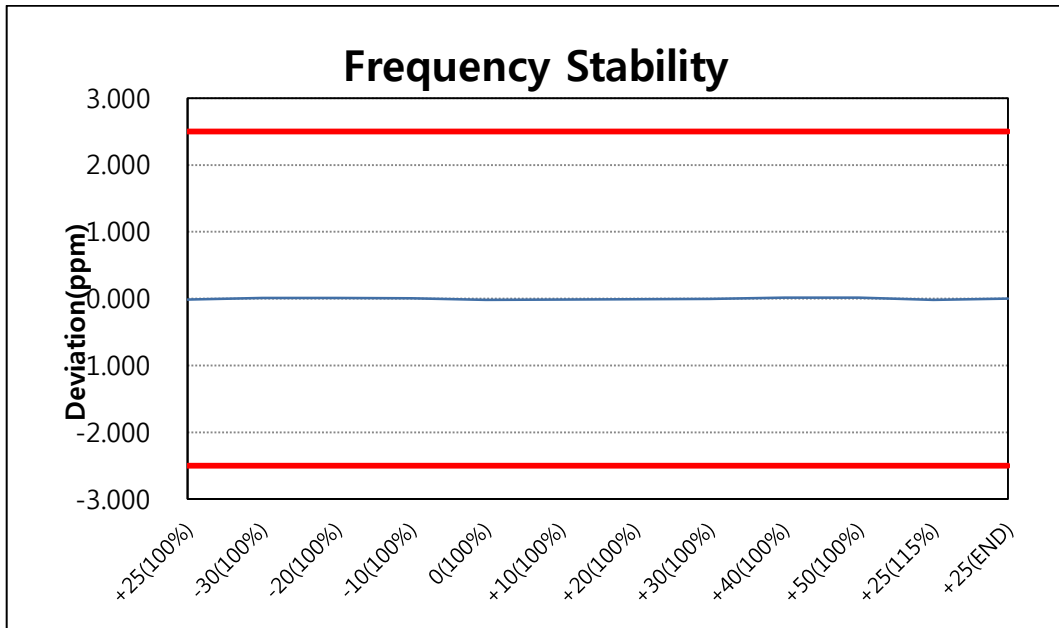

**7.9.3 FREQUENCY STABILITY (PCS CDMA 1x)**

OPERATING FREQUENCY : 1,880,000,000 Hz  
 CHANNEL : 600 (Mid)  
 REFERENCE VOLTAGE : 3.800 V DC  
 DEVIATION LIMIT : The frequency stability shall be sufficient to ensure that the fundamental emission stays within the authorized frequency block.

| VOLTAGE (%)   | POWER (V DC) | TEMP (°C) | FREQ (Hz)     | Deviation     |             |
|---------------|--------------|-----------|---------------|---------------|-------------|
|               |              |           |               | (ppm)         | (%)         |
| 100%          | 12.0         | +25(Ref)  | 1,879,999,978 | -0.012        | -0.00000117 |
| 100%          |              | -30       | 1,880,000,024 | 0.013         | 0.00000128  |
| 100%          |              | -20       | 1,879,999,981 | -0.010        | -0.00000101 |
| 100%          |              | -10       | 1,879,999,983 | -0.009        | -0.00000090 |
| 100%          |              | 0         | 1,880,000,015 | 0.008         | 0.00000080  |
| 100%          |              | +10       | 1,880,000,017 | 0.009         | 0.00000090  |
| 100%          |              | +20       | 1,879,999,979 | -0.011        | -0.00000112 |
| 100%          |              | +30       | 1,880,000,020 | 0.011         | 0.00000106  |
| 100%          |              | +40       | 1,879,999,974 | -0.014        | -0.00000138 |
| 100%          |              | +50       | 1,880,000,023 | 0.012         | 0.00000122  |
| 85%           |              | 10.2      | +25           | 1,879,999,963 | -0.020      |
| 115%          | 13.8         | +25       | 1,879,999,969 | -0.016        | -0.00000165 |
| BATT.ENDPOINT | N/A          | -         | -             | -             | -           |

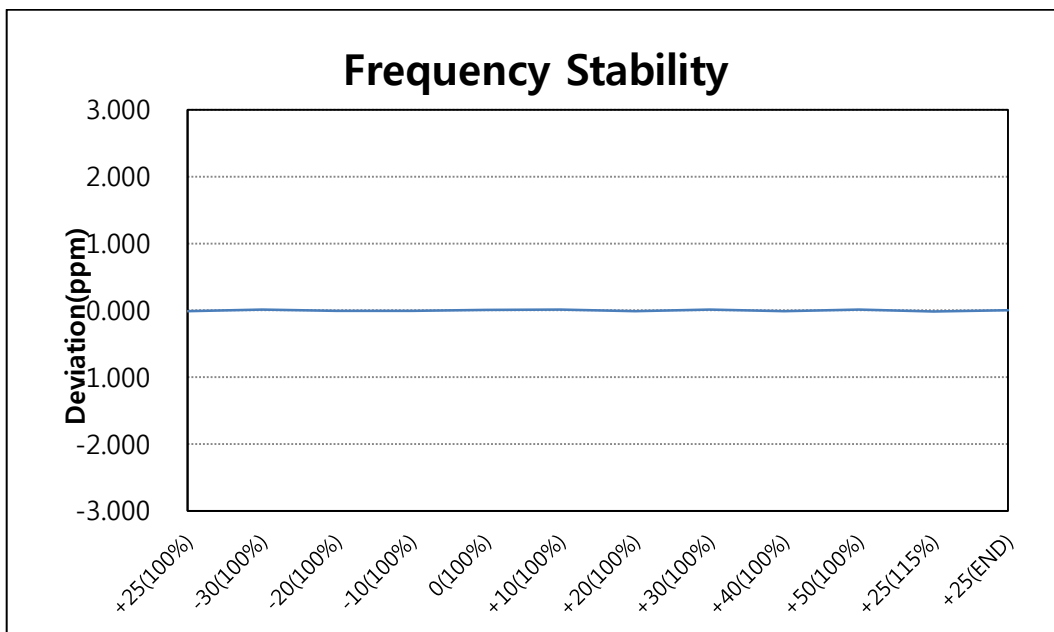

**Note.** Based on the results of the frequency stability test at the center channel the frequency deviation results measured are very small. as such it is determined that the channels at the band edge would remain inband when the maximum measured frequency deviation noted during the frequency stability tests is applied. therefore the device is determined to remain operating in band over the temperature and voltage range as tested.

**7.9.4 FREQUENCY STABILITY (PCS CDMA 1xEVDO (Rev. A))**

OPERATING FREQUENCY : 1,880,000,000 Hz  
 CHANNEL : 600 (Mid)  
 REFERENCE VOLTAGE : 3.800 V DC  
 LIMIT : The frequency stability shall be sufficient to ensure that the fundamental emission stays within the authorized frequency block.

| VOLTAGE (%)   | POWER (V DC) | TEMP (°C) | FREQ (Hz)     | Deviation     |             |
|---------------|--------------|-----------|---------------|---------------|-------------|
|               |              |           |               | (ppm)         | (%)         |
| 100%          | 12.0         | +25(Ref)  | 1,880,000,014 | 0.007         | 0.00000074  |
| 100%          |              | -30       | 1,880,000,009 | 0.005         | 0.00000048  |
| 100%          |              | -20       | 1,880,000,005 | 0.003         | 0.00000027  |
| 100%          |              | -10       | 1,880,000,007 | 0.004         | 0.00000037  |
| 100%          |              | 0         | 1,880,000,006 | 0.003         | 0.00000032  |
| 100%          |              | +10       | 1,880,000,002 | 0.001         | 0.00000011  |
| 100%          |              | +20       | 1,880,000,003 | 0.002         | 0.00000016  |
| 100%          |              | +30       | 1,879,999,989 | -0.006        | -0.00000059 |
| 100%          |              | +40       | 1,880,000,014 | 0.007         | 0.00000074  |
| 100%          |              | +50       | 1,880,000,013 | 0.007         | 0.00000069  |
| 85%           |              | 10.2      | +25           | 1,879,999,985 | -0.008      |
| 115%          | 13.8         | +25       | 1,879,999,985 | -0.008        | -0.00000080 |
| BATT.ENDPOINT | N/A          | -         | -             | -             | -           |

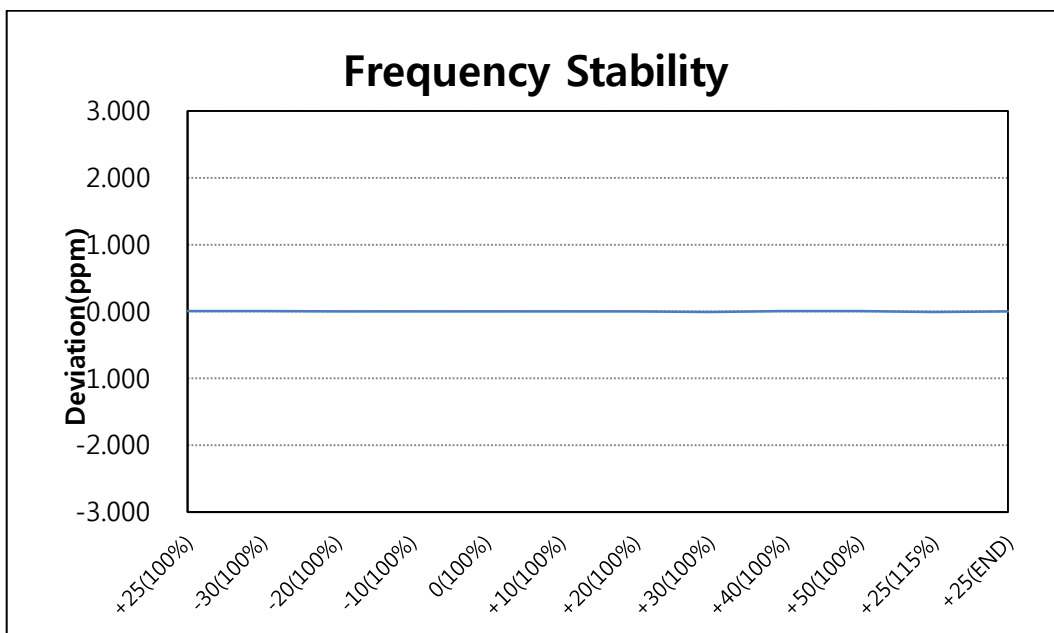

**Note.** Based on the results of the frequency stability test at the center channel the frequency deviation results measured are very small. as such it is determined that the channels at the band edge would remain inband when the maximum measured frequency deviation noted during the frequency stability tests is applied. therefore the device is determined to remain operating in band over the temperature and voltage range as tested.

## 8. TEST PLOTS

### 8.1 Peak to Average Ratio

CDMA 1x & PCS band Channel: 600

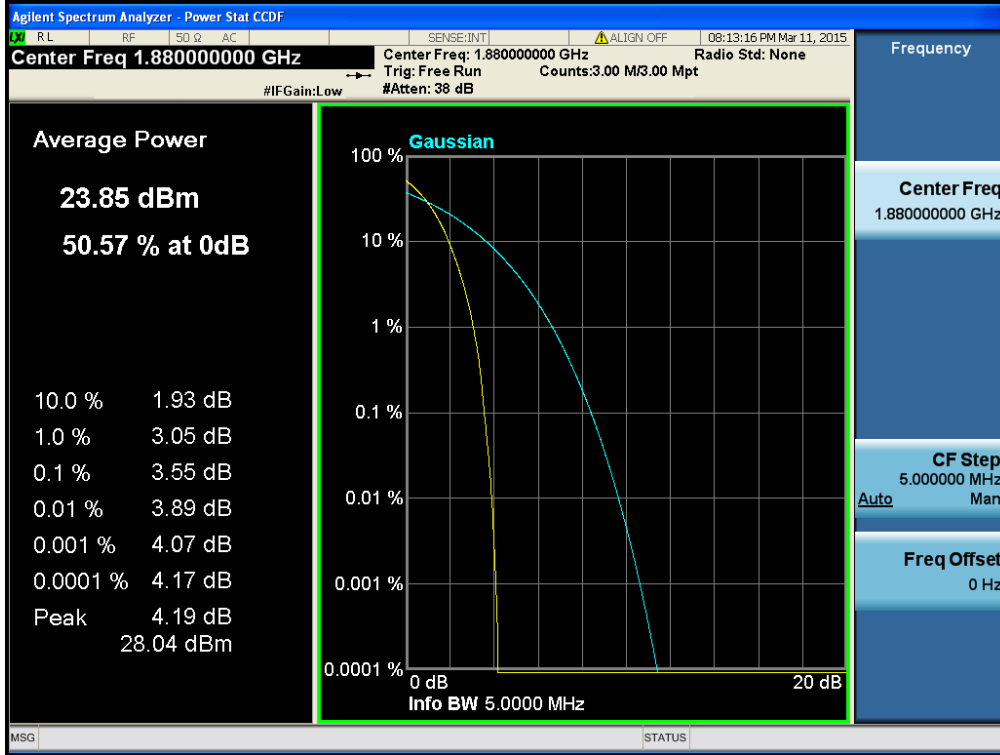

CDMA EVDO 1x EVDO(Rev. A) & PCS band Channel: 600

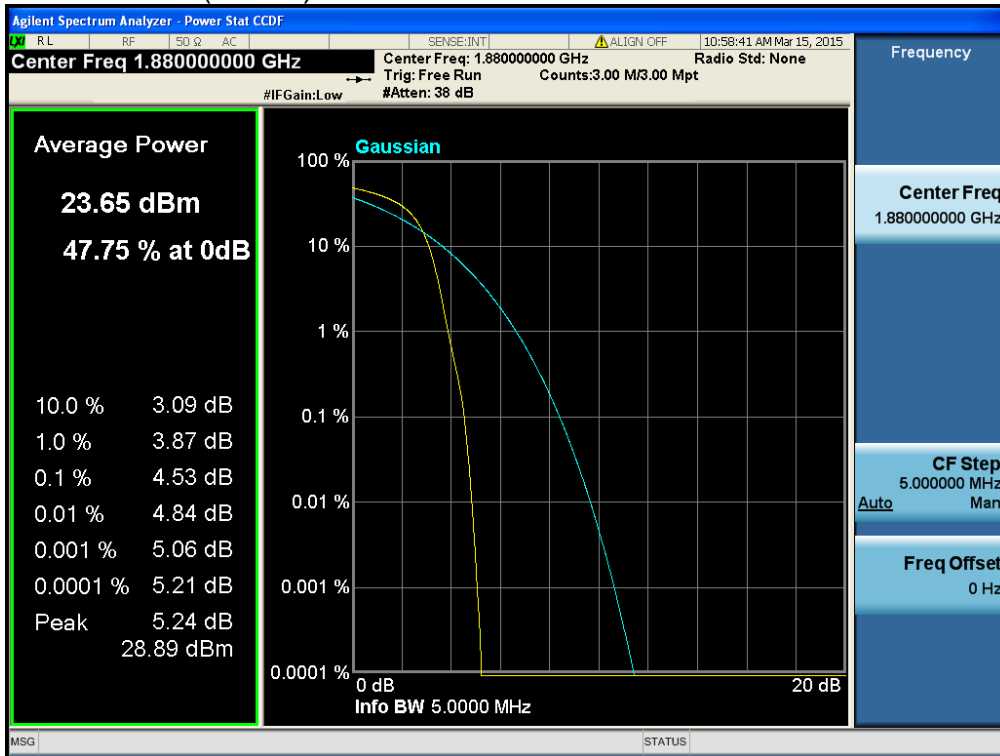

### 8.2 Occupied Bandwidth (99 % Bandwidth)

CDMA 1x & Cellular band Channel: 1013

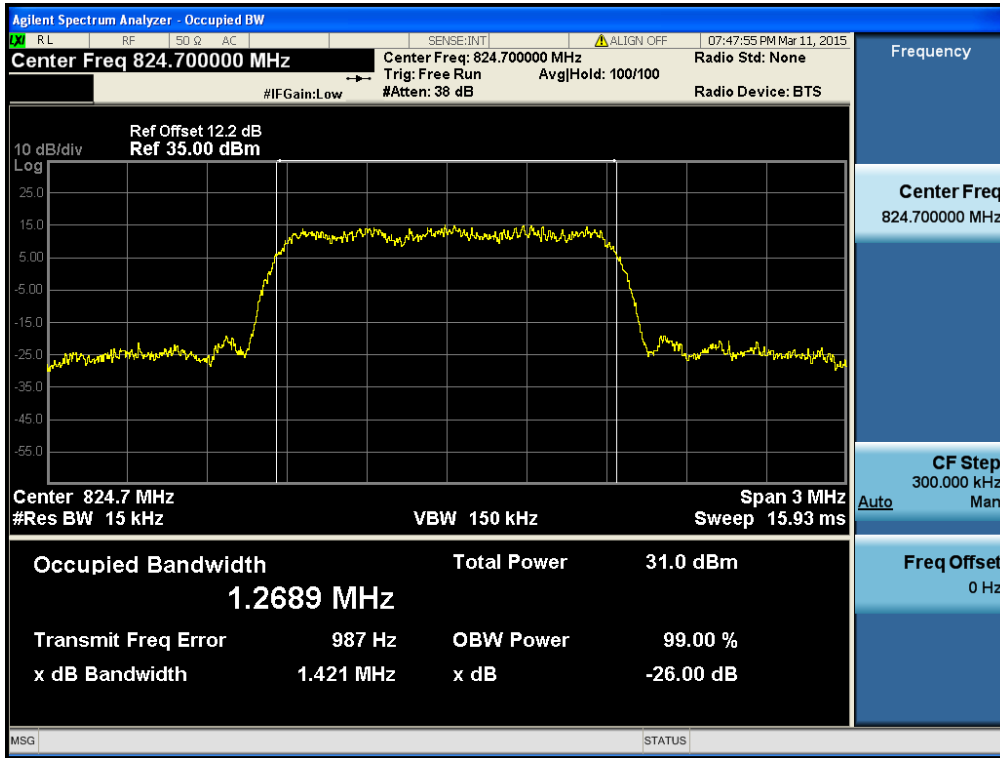

CDMA 1x & Cellular band Channel: 384

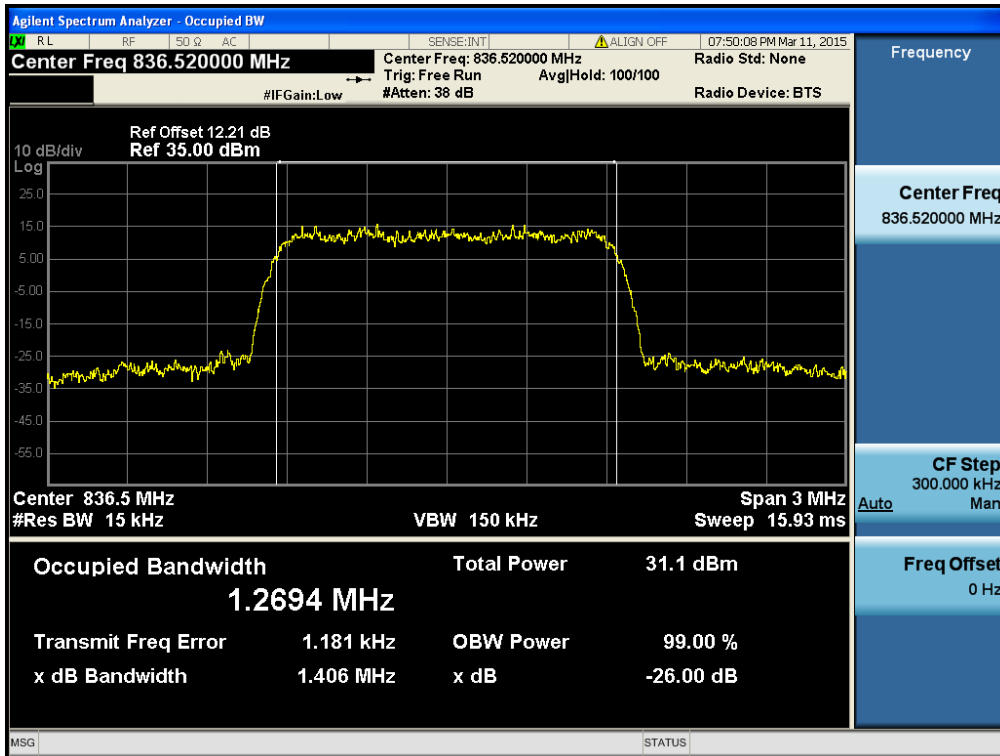

CDMA 1x & Cellular band Channel: 777

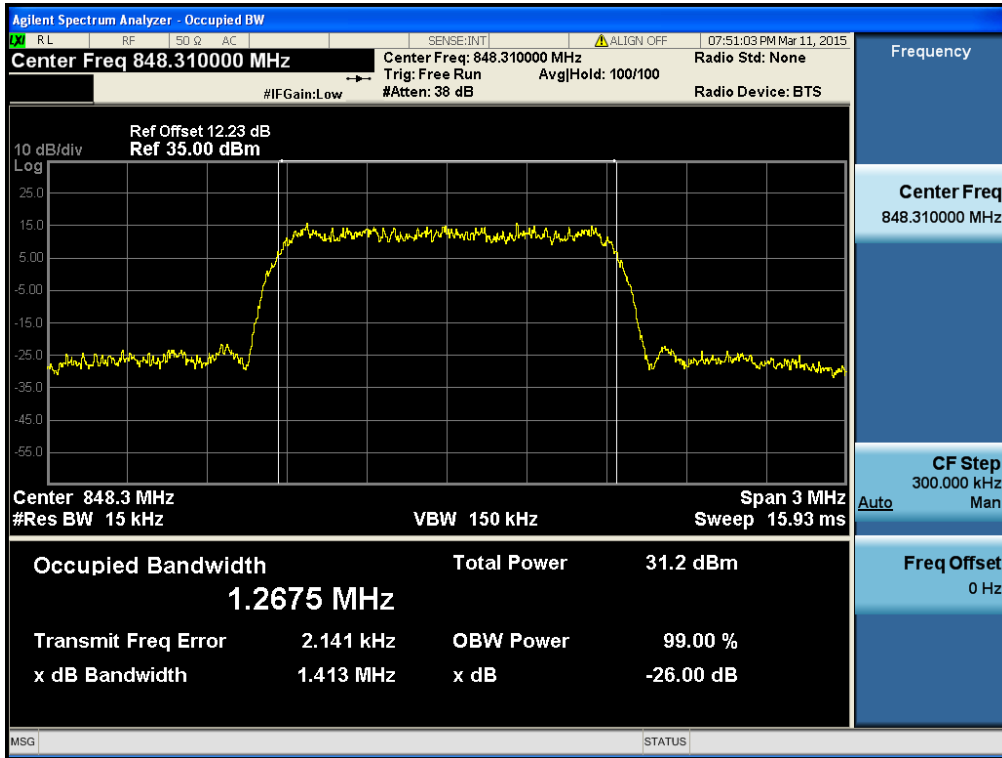

CDMA 1x EVDO(Rev. A) & Cellular band Channel: 1013

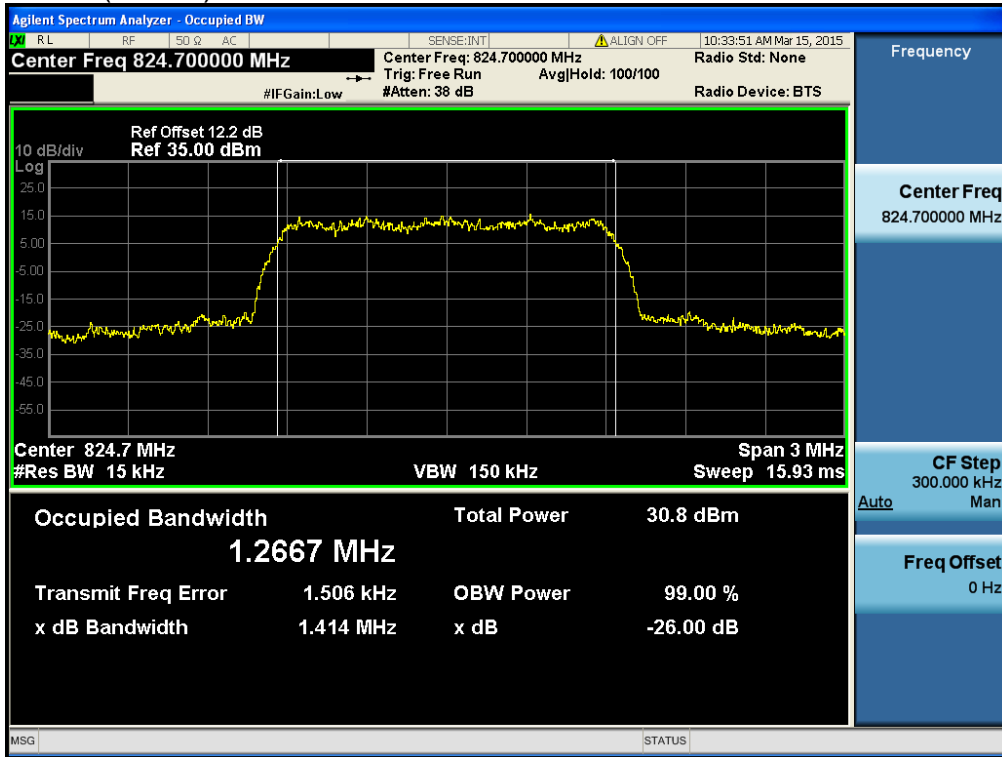

CDMA 1x EVDO(Rev. A) & Cellular band Channel: 384

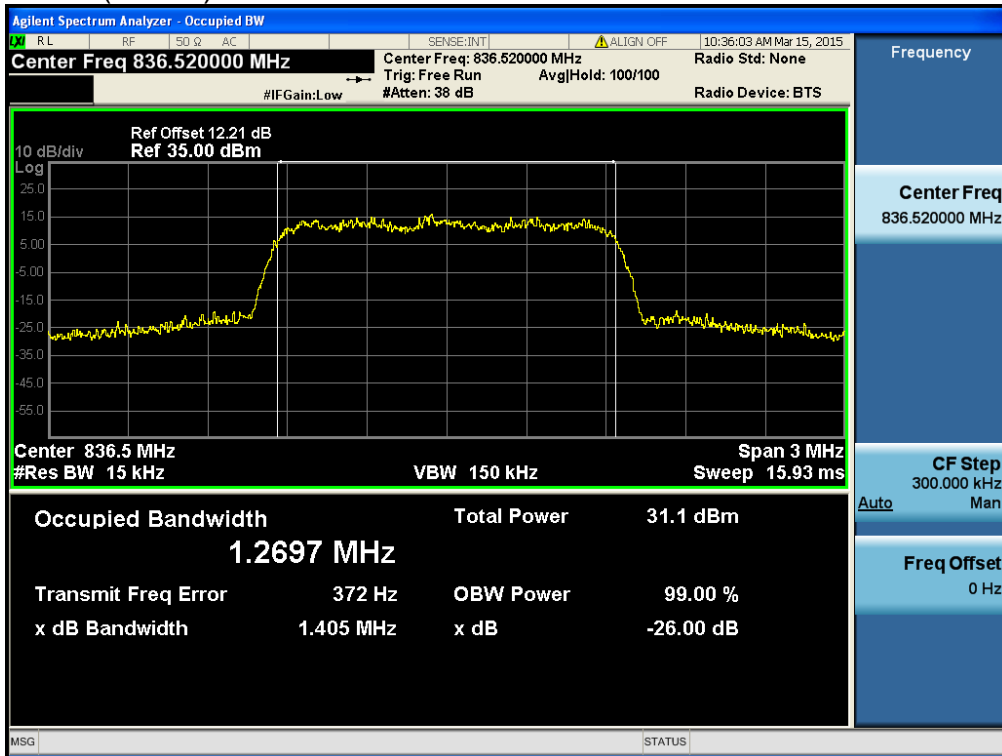



CDMA 1x EVDO(Rev. A) & Cellular band Channel: 777

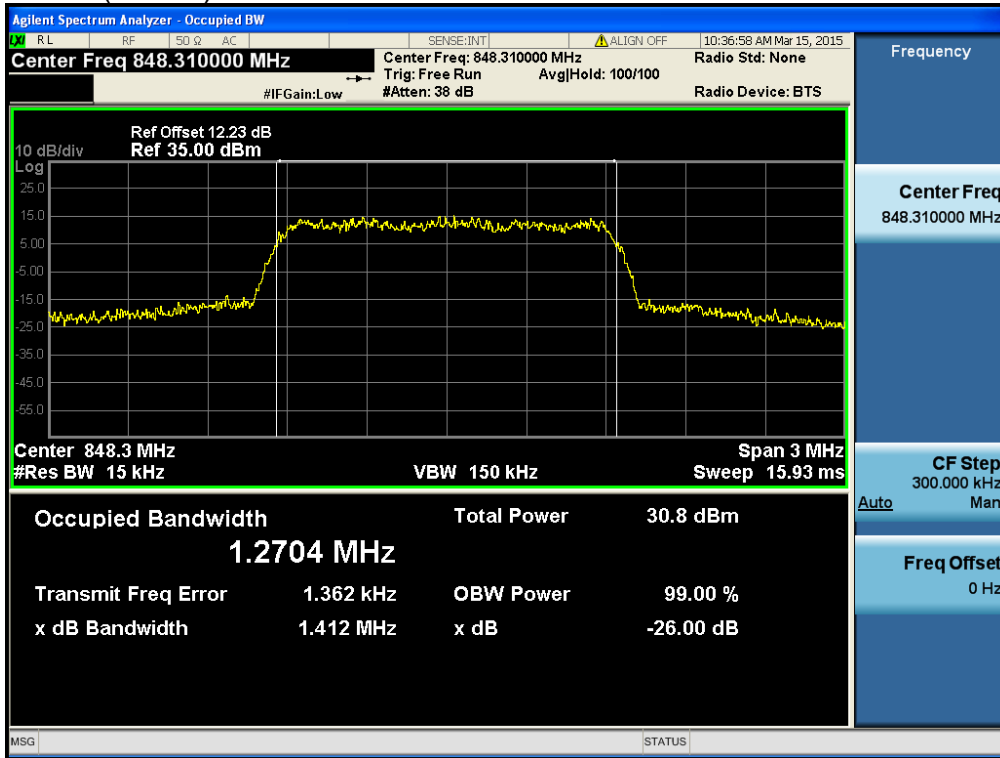

### CDMA 1x & PCS band Channel: 25

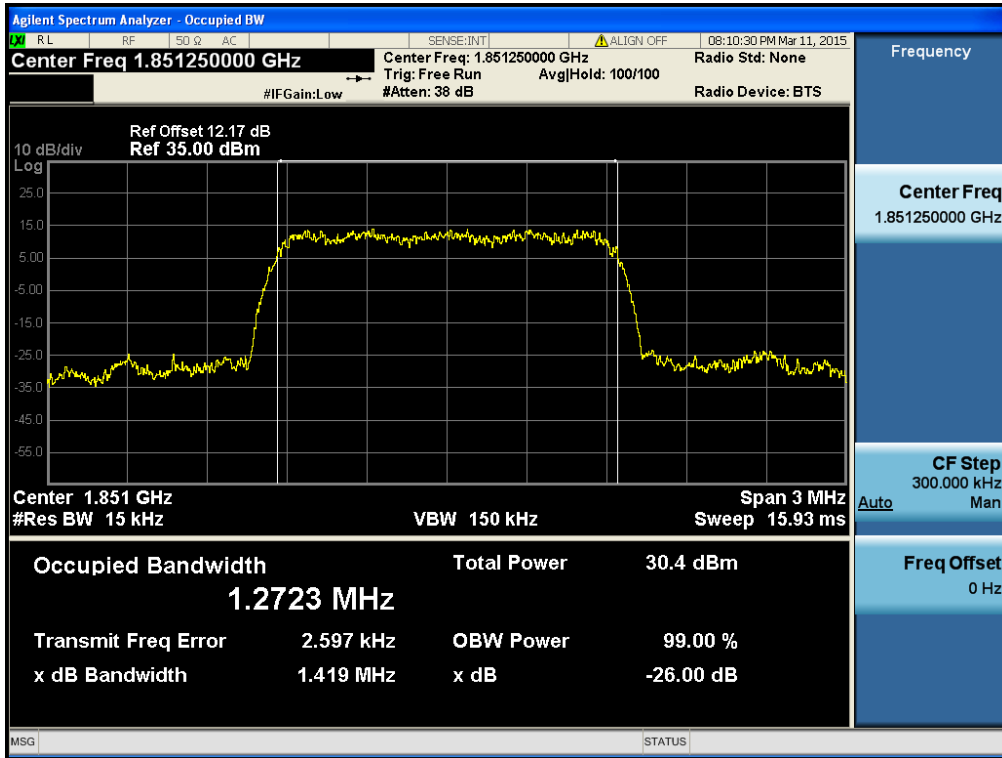

### CDMA 1x & PCS band Channel: 600

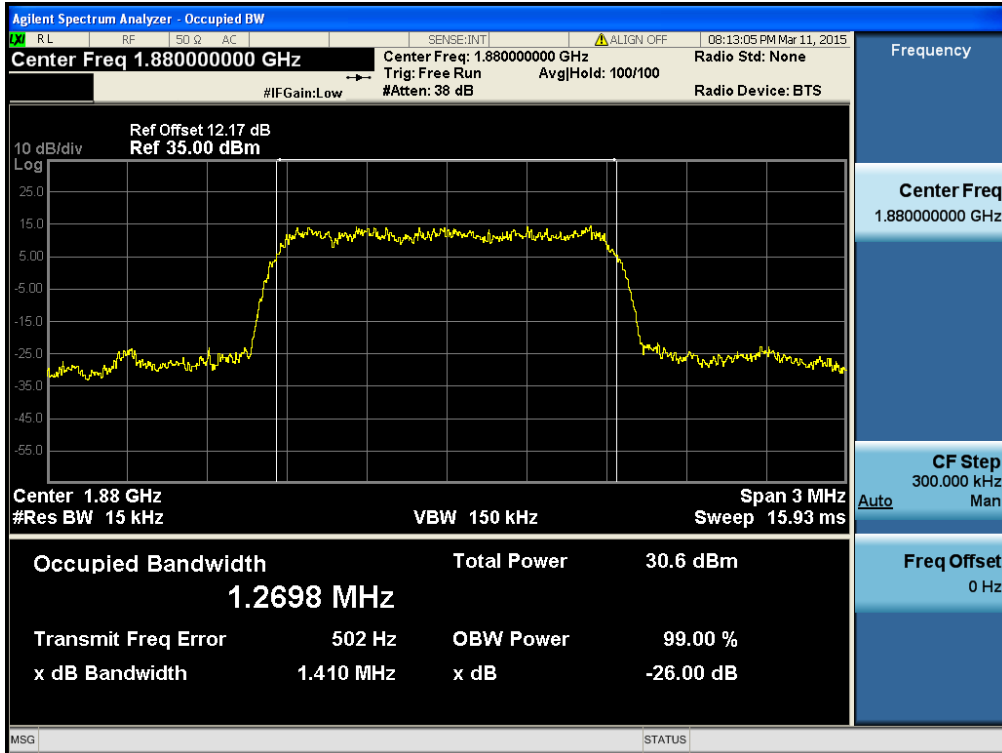

CDMA 1x & PCS band Channel: 1175

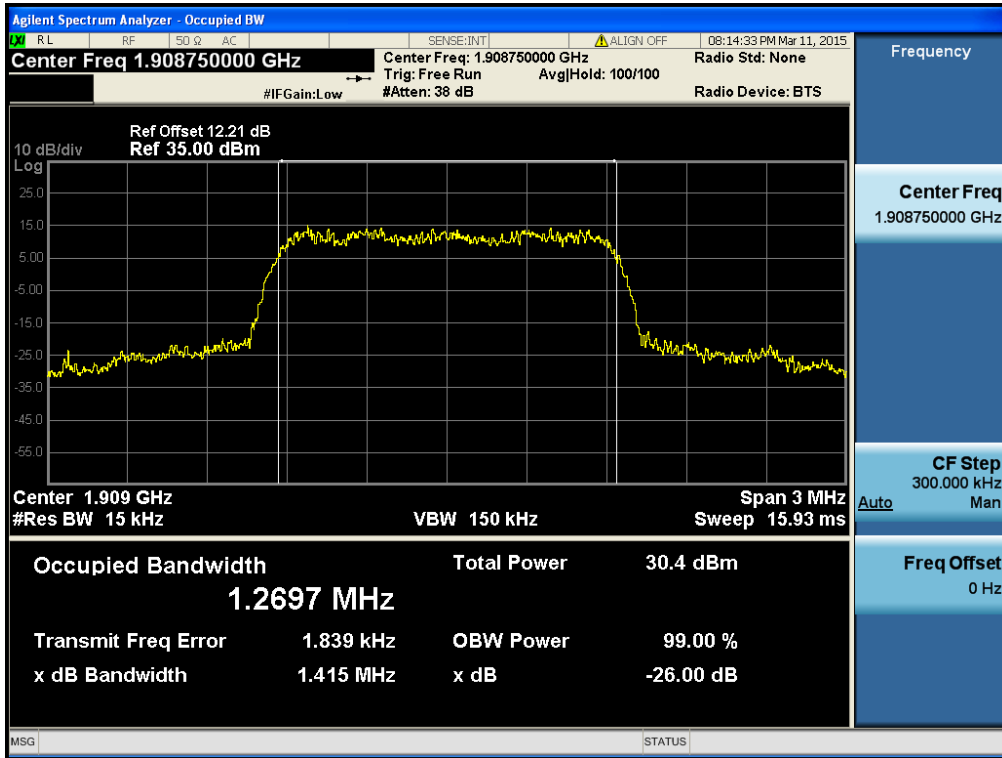

CDMA 1x EVDO(Rev. A) & PCS band Channel: 25

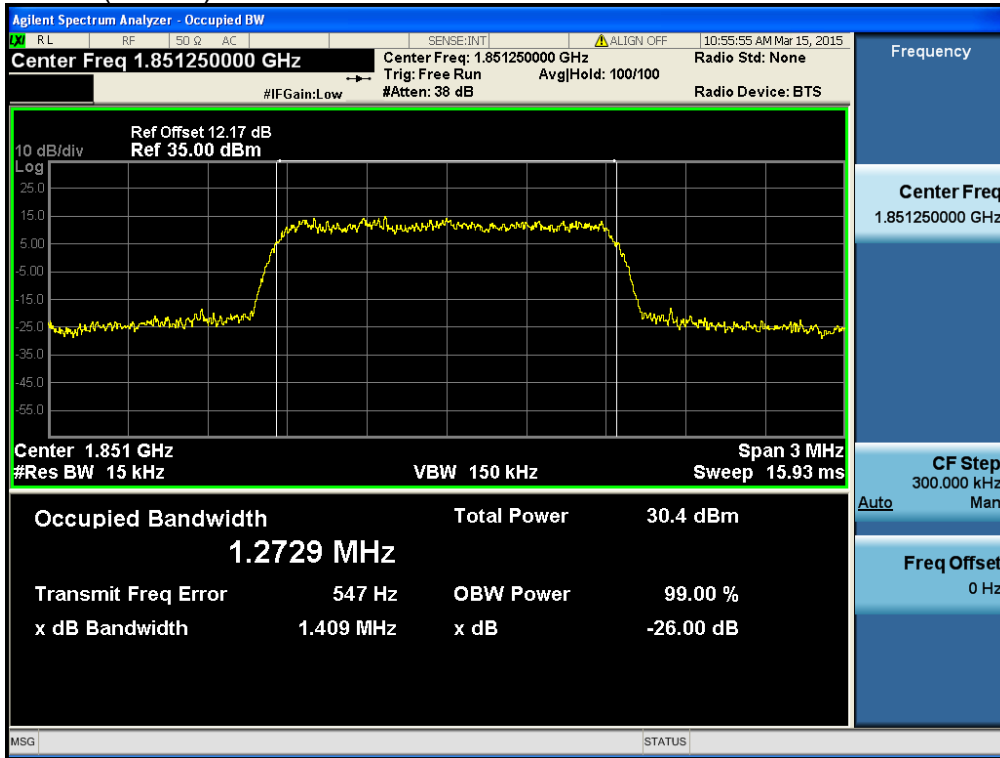

CDMA 1x EVDO(Rev. A) & PCS band Channel: 600

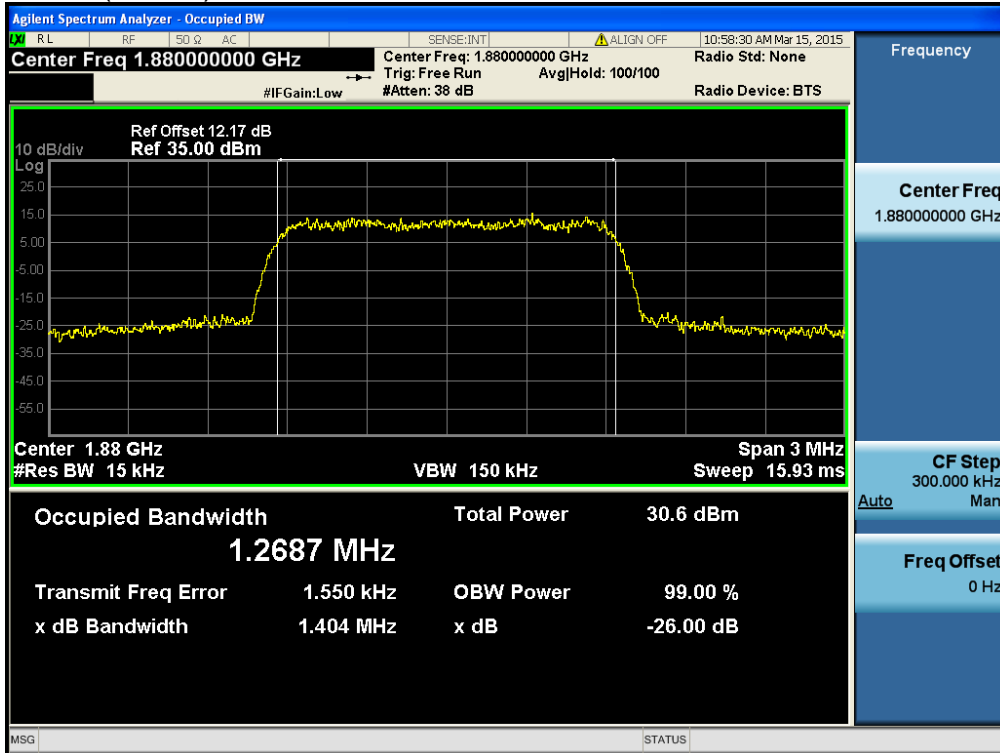

CDMA 1x EVDO(Rev. A) & PCS band Channel: 1175

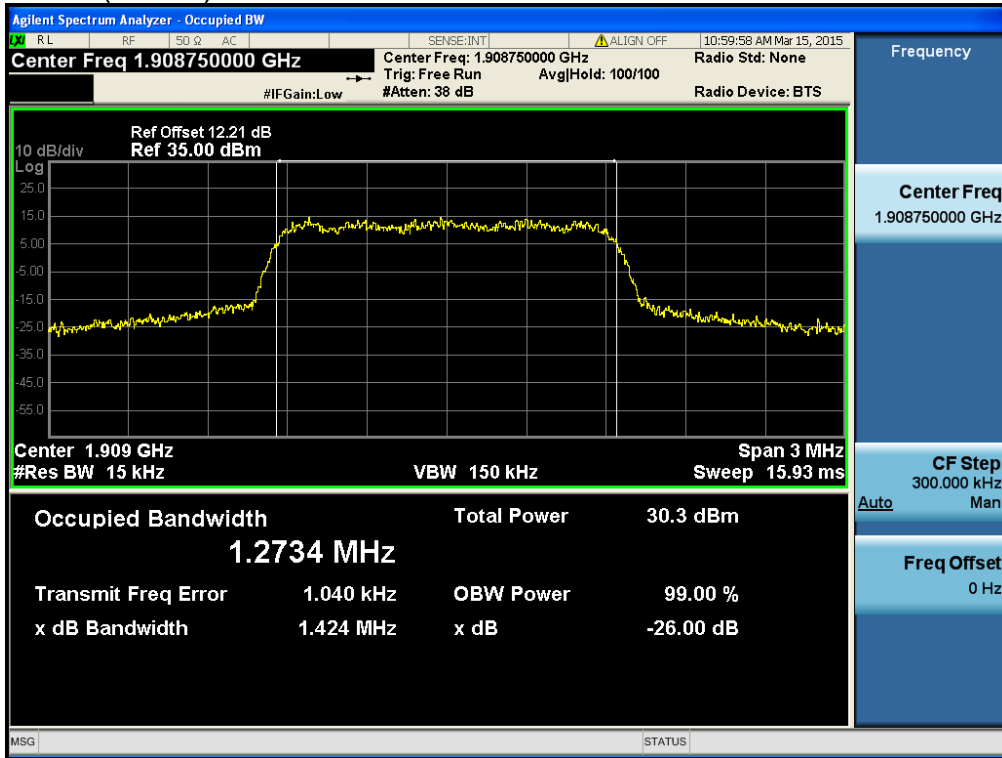

### 8.3 Spurious Emissions at Antenna Terminal

CDMA 1x & Cellular band Channel: 1013

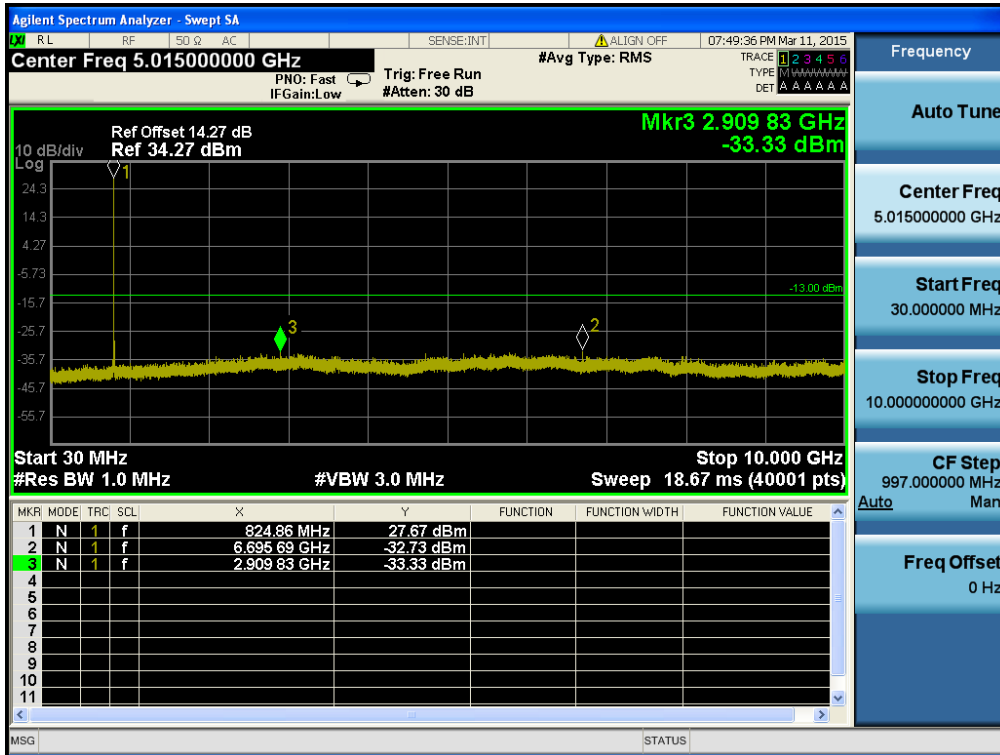

CDMA 1x & Cellular band Channel: 384

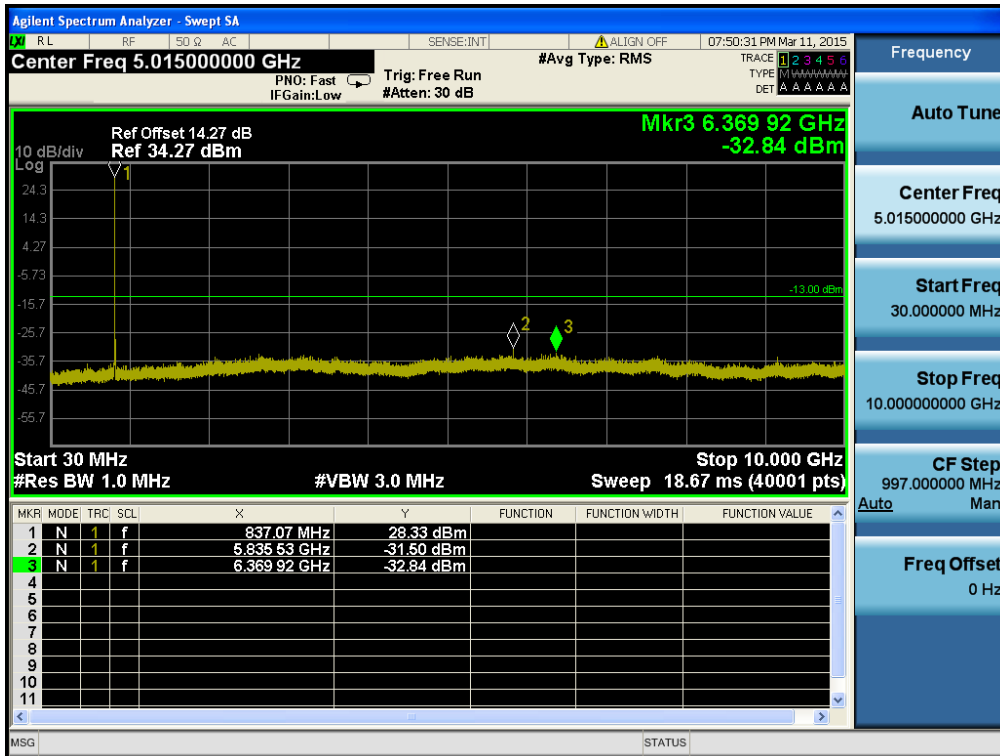

CDMA 1x & Cellular band Channel: 777

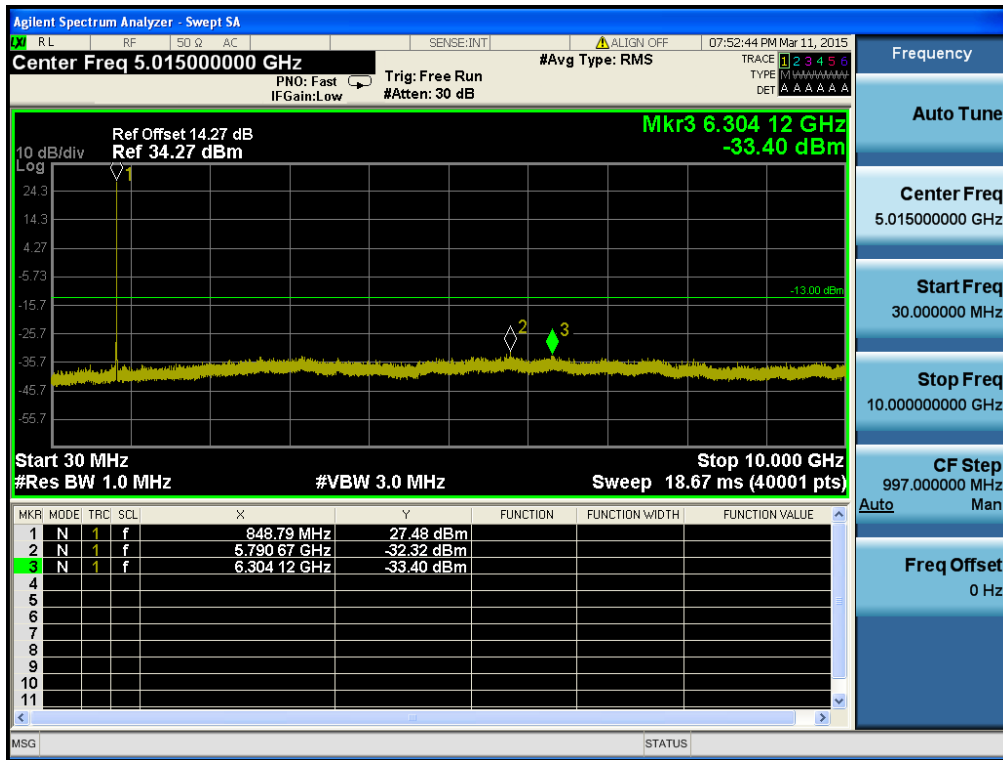

CDMA 1x EVDO(Rev. A) & Cellular band Channel: 1013

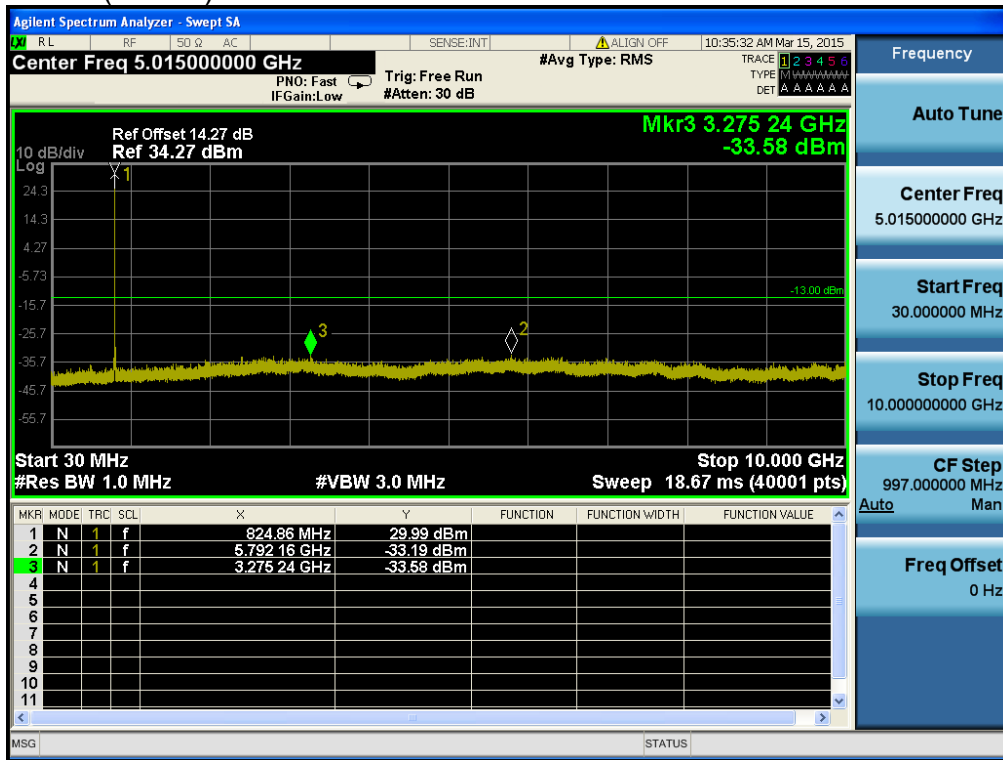

CDMA 1x EVDO(Rev. A) & Cellular band Channel: 384

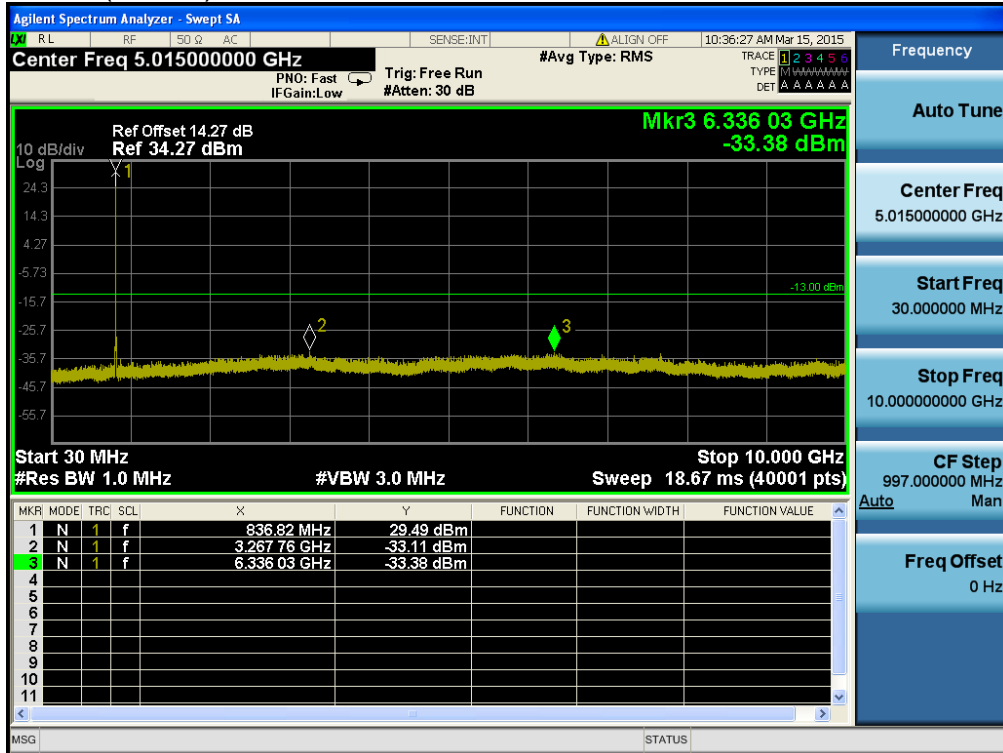



CDMA 1x EVDO(Rev. A) & Cellular band Channel: 777

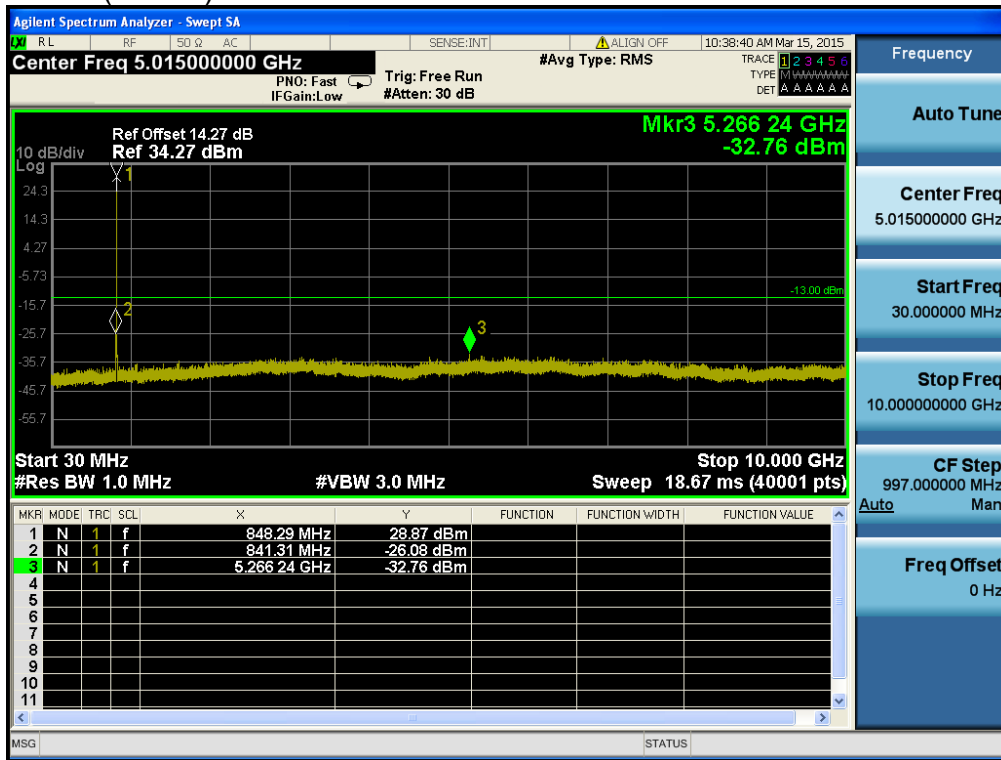

CDMA 1x & PCS band Channel: 25

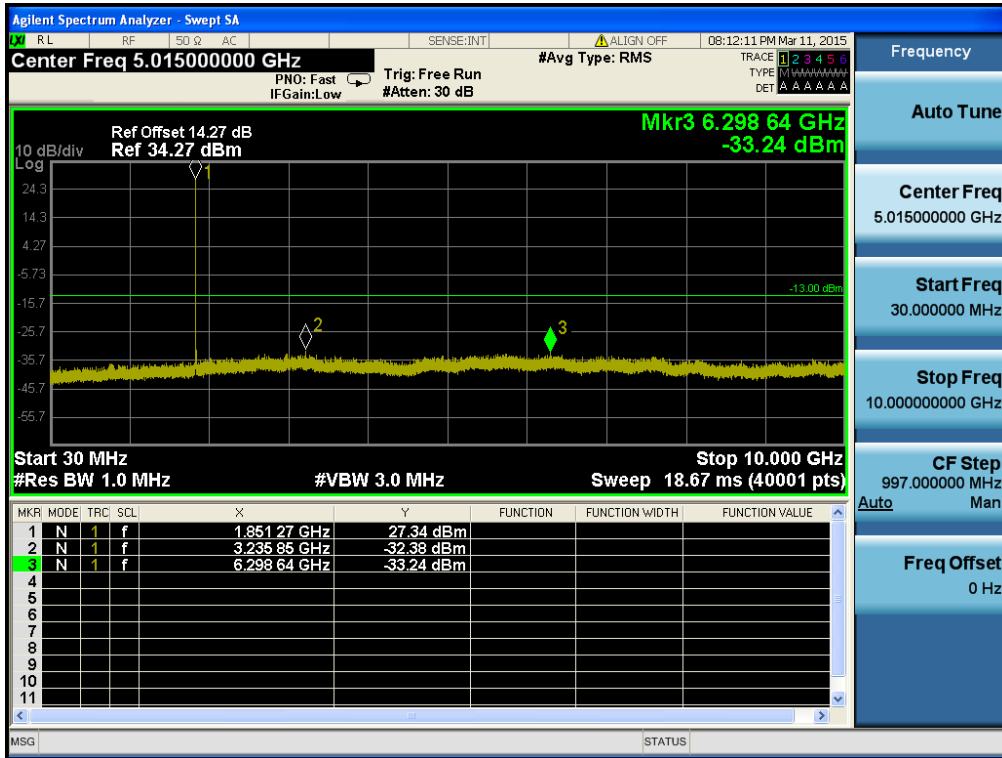

CDMA 1x & PCS band Channel: 25

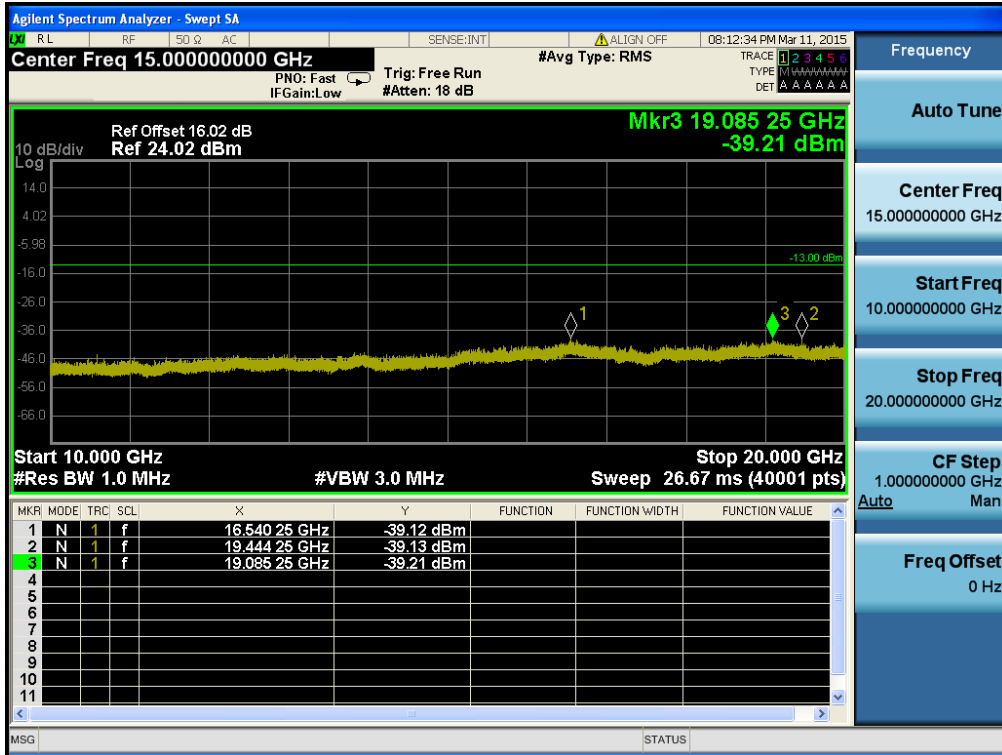

CDMA 1x & PCS band Channel: 600

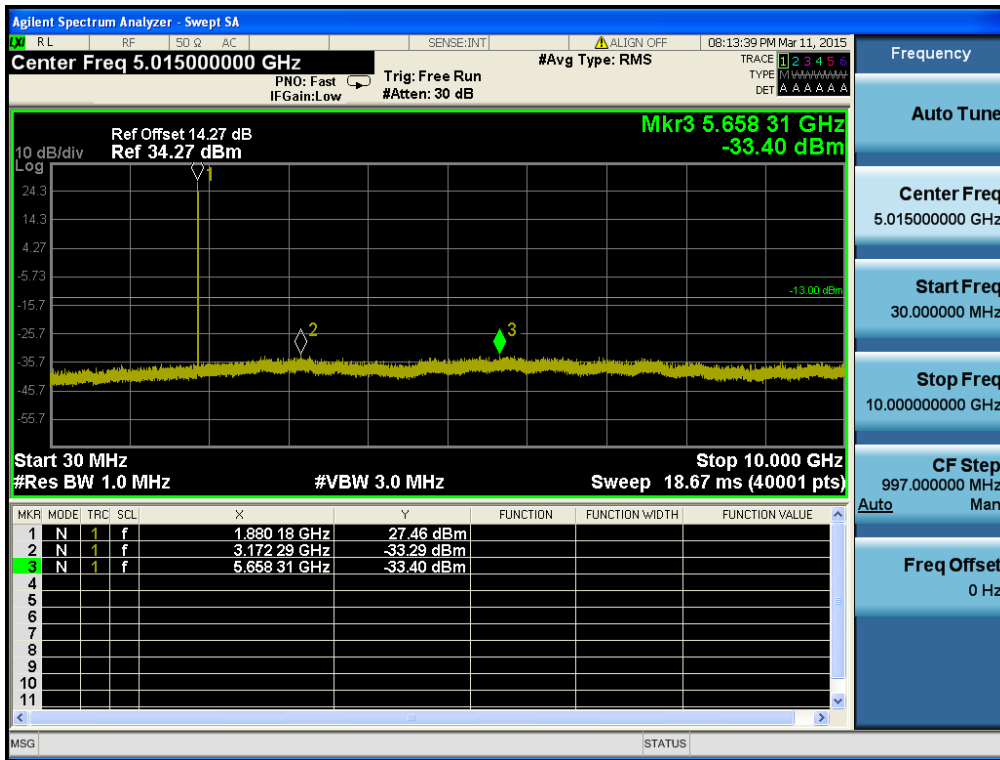

CDMA 1x & PCS band Channel: 600

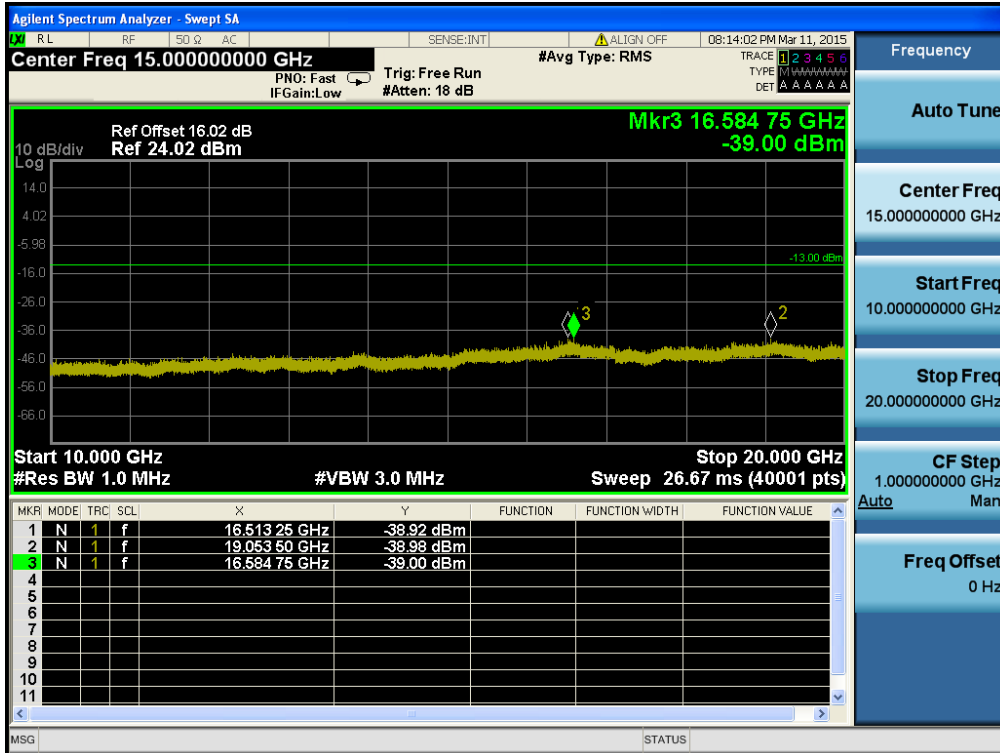

CDMA 1x & PCS band Channel: 1175

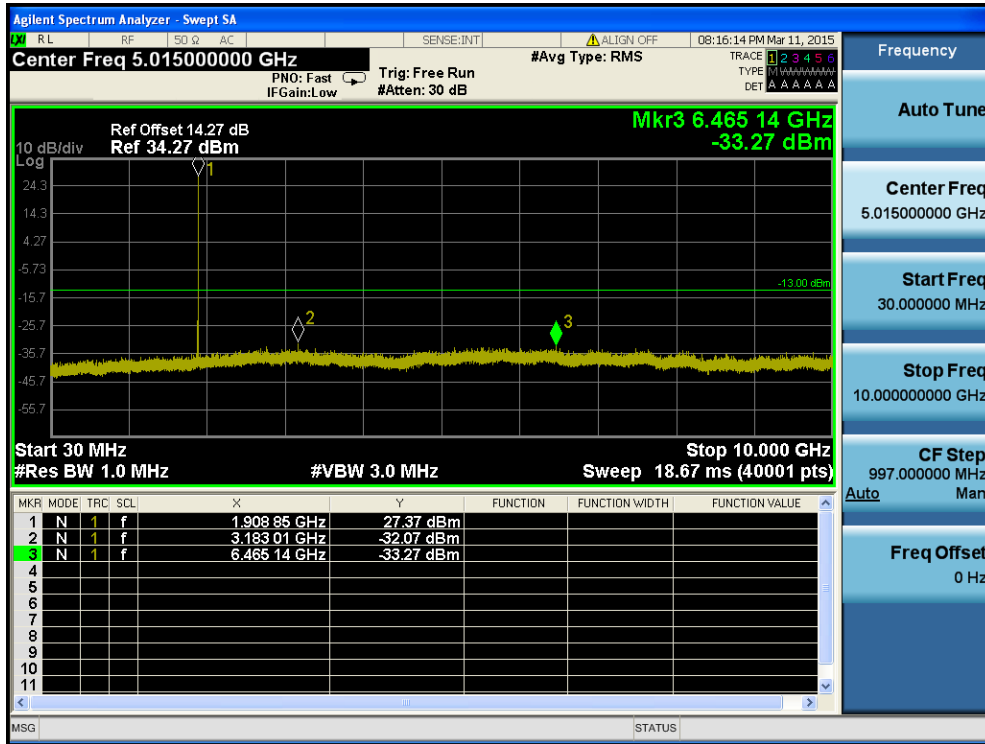

CDMA 1x & PCS band Channel: 1175

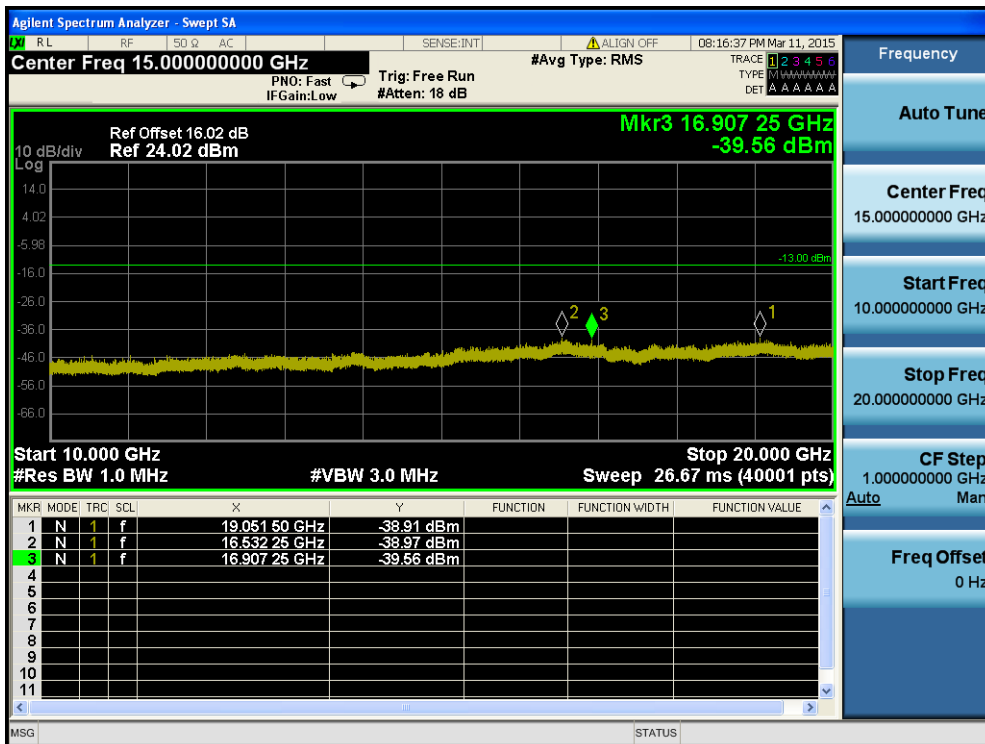

CDMA 1x EVDO(Rev. A) & PCS band Channel: 25

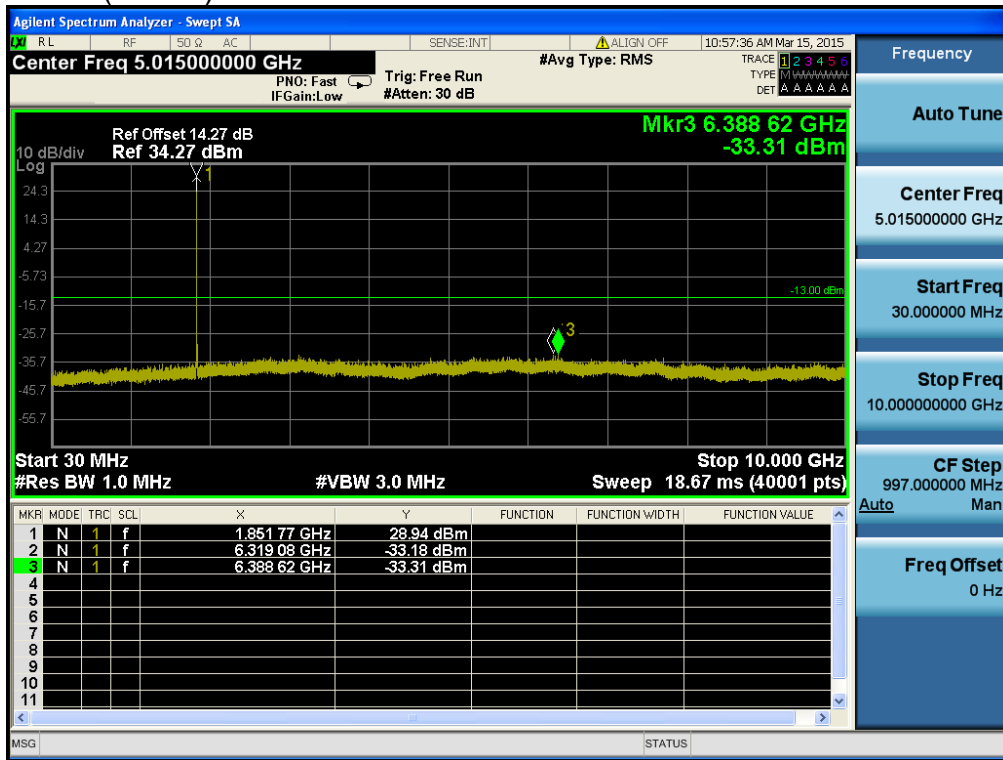

CDMA 1x EVDO(Rev. A) & PCS band Channel: 25

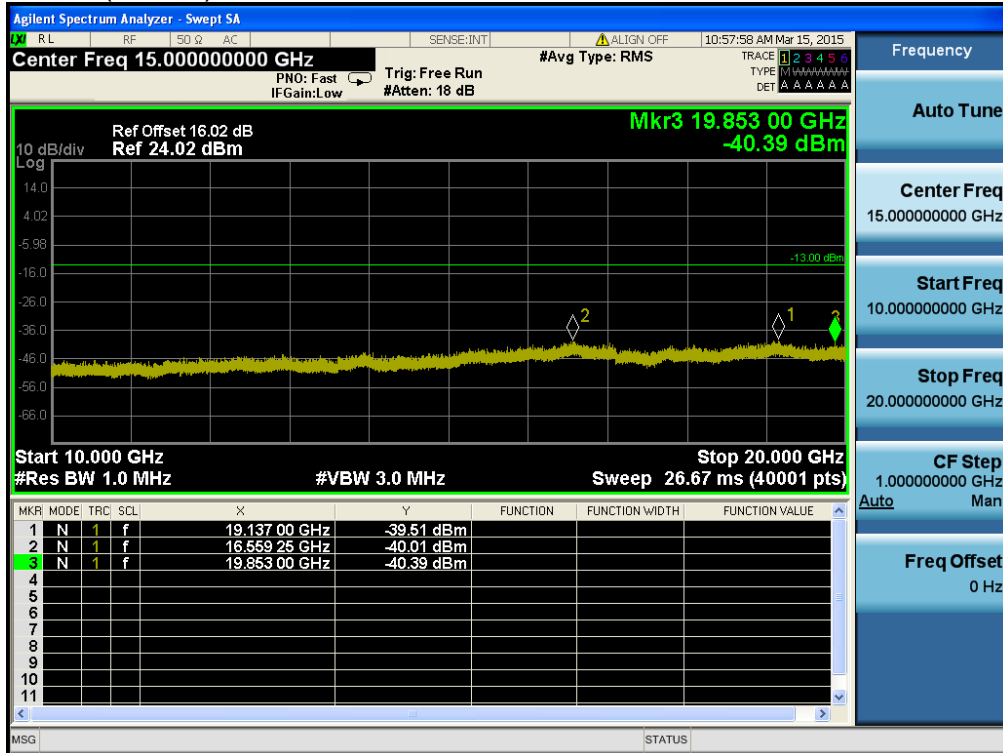

CDMA 1x EVDO(Rev. A) & PCS band Channel: 600

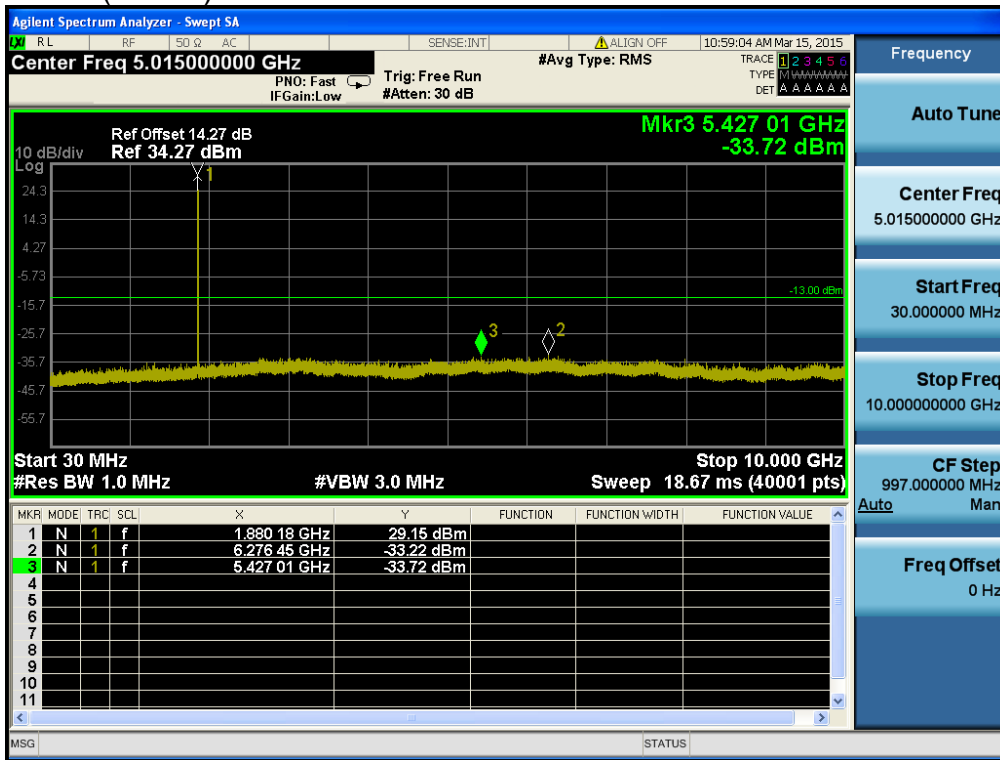

CDMA 1x EVDO(Rev. A) & PCS band Channel: 600

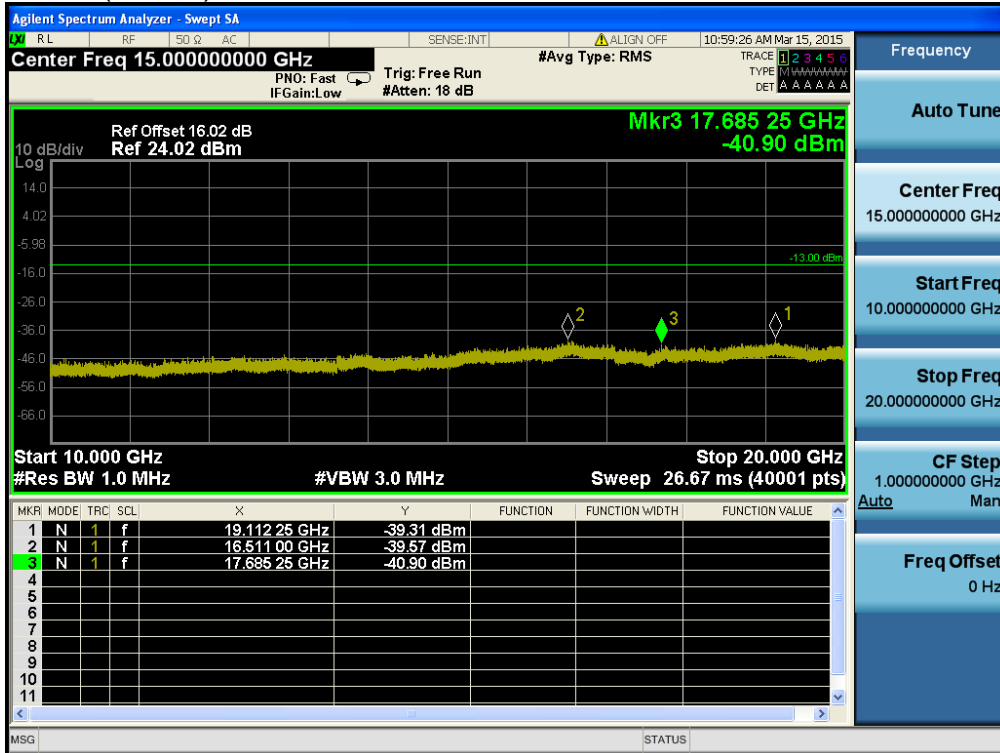

CDMA 1x EVDO(Rev. A) & PCS band Channel: 1175

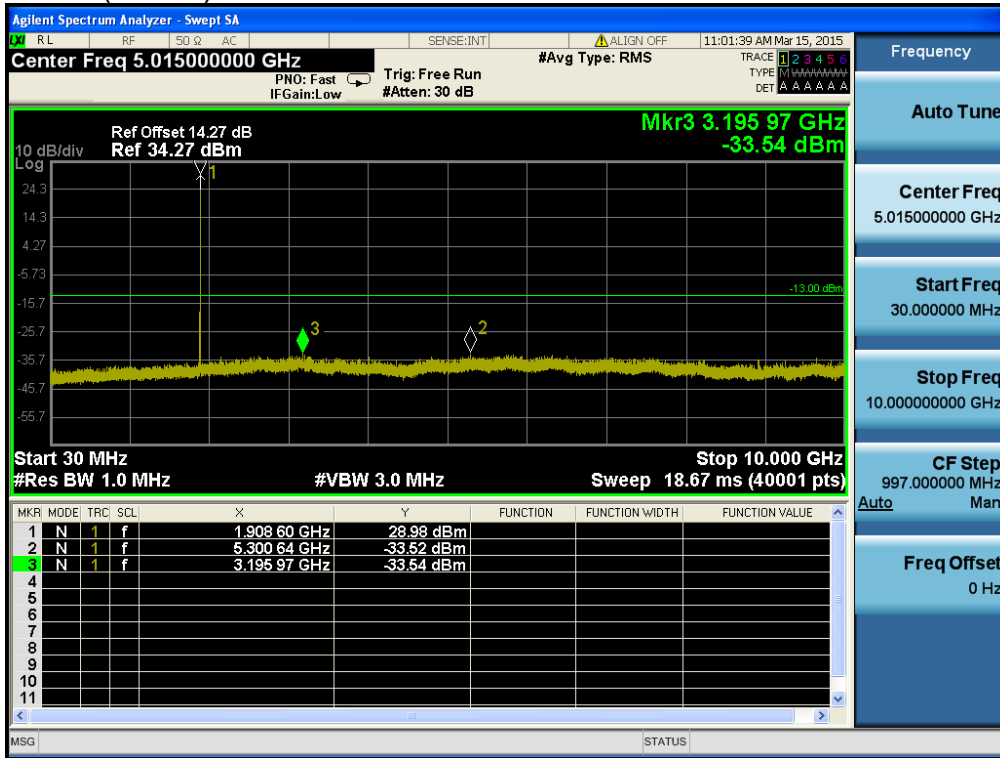

CDMA 1x EVDO(Rev. A) & PCS band Channel: 1175

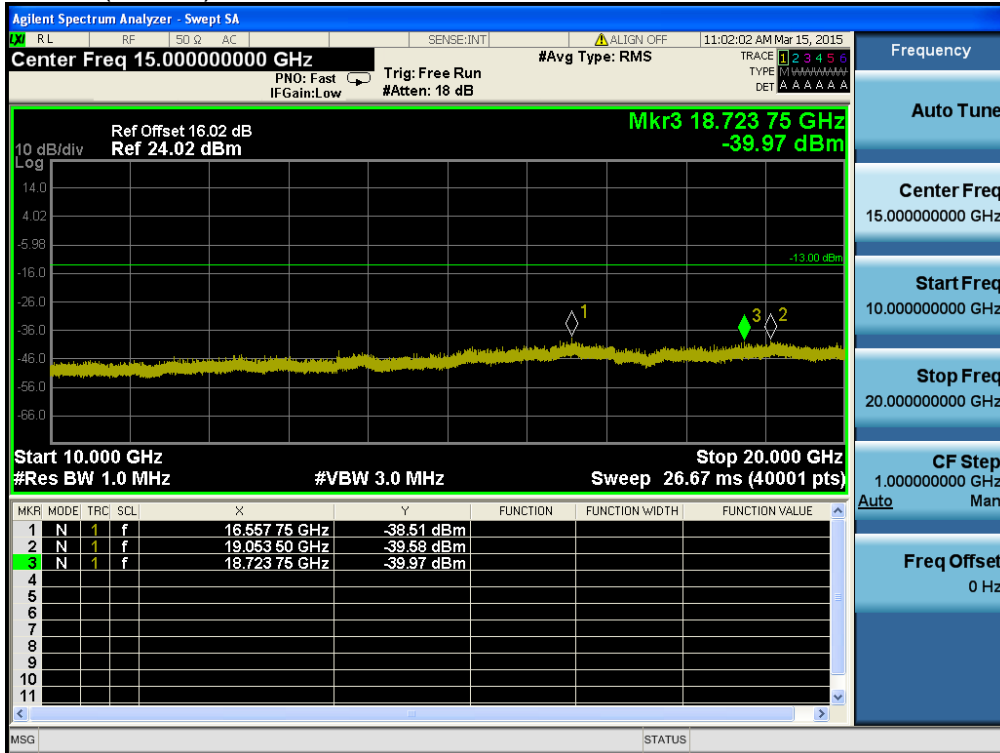

### 8.4 Band Edge

#### CDMA 1x & Cellular band Channel: 1013

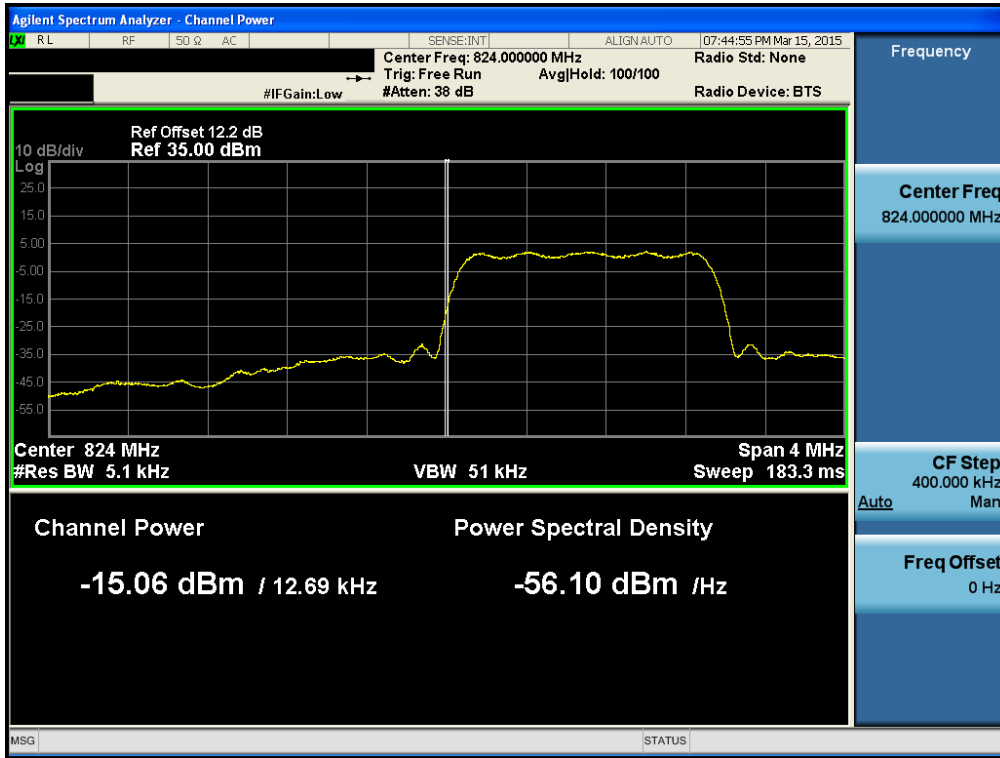

#### CDMA 1x & Cellular band Channel: 1013

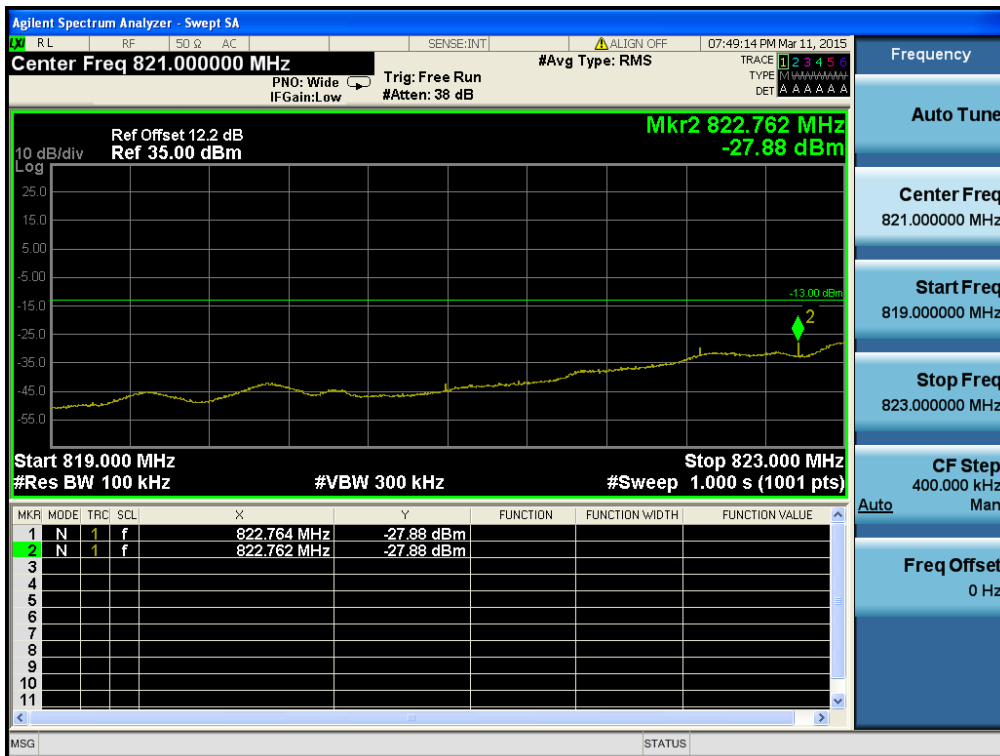



CDMA 1x & Cellular band Channel: 777

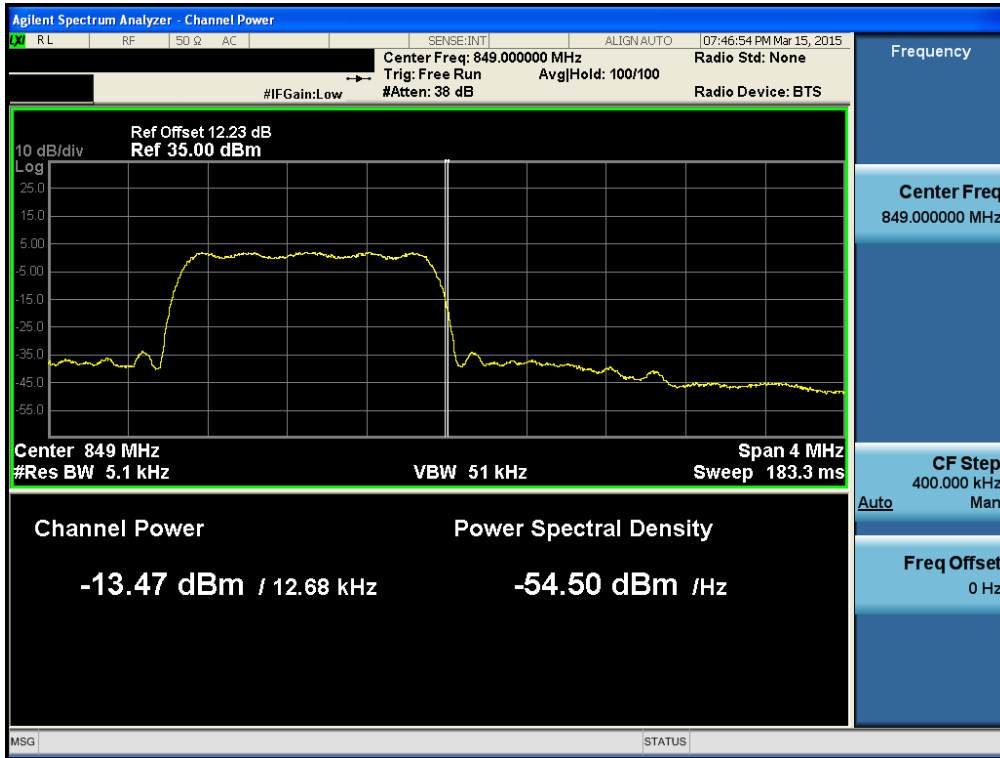

CDMA 1x & Cellular band Channel: 777

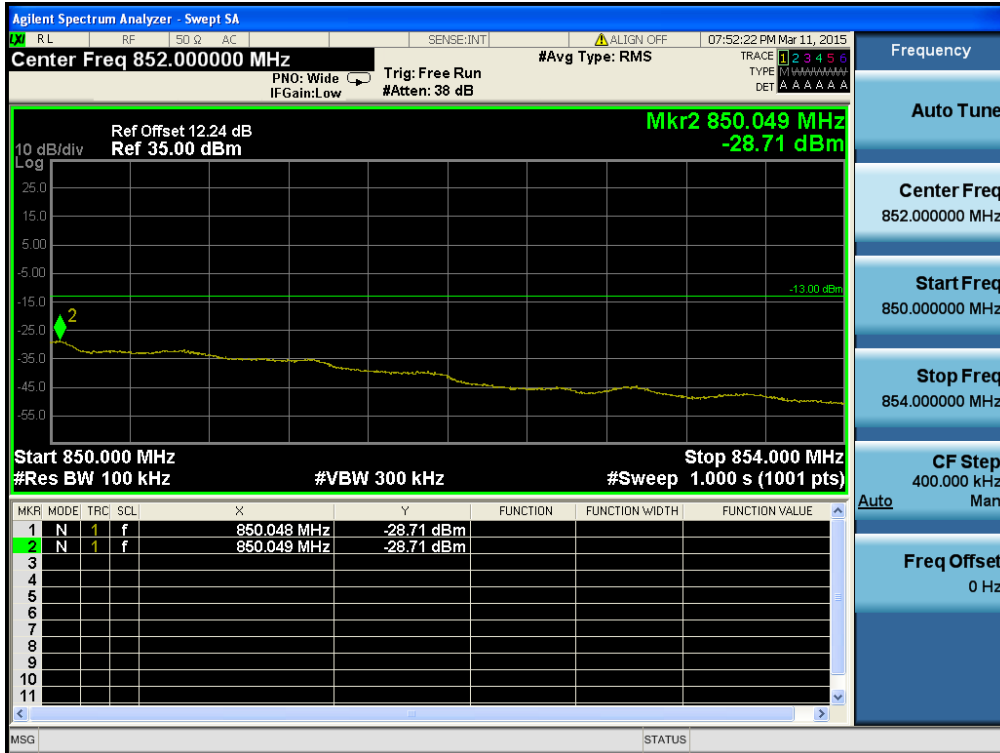

CDMA 1x EVDO(Rev. A) & Cellular band Channel: 1013

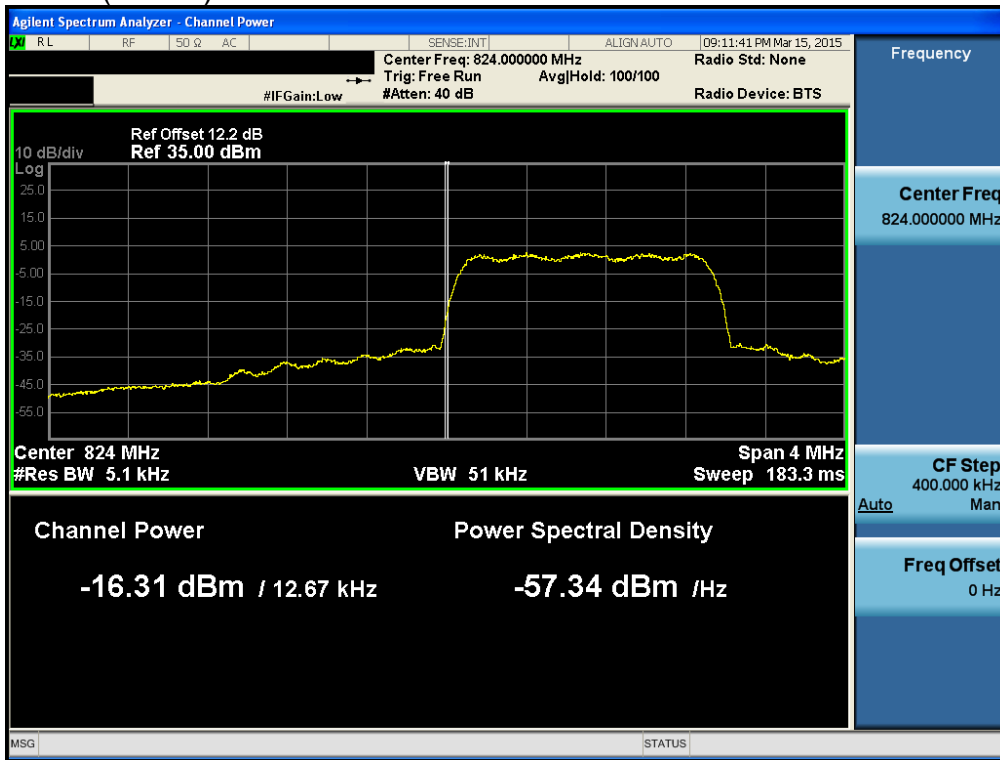

CDMA 1x EVDO(Rev. A) & Cellular band Channel: 1013

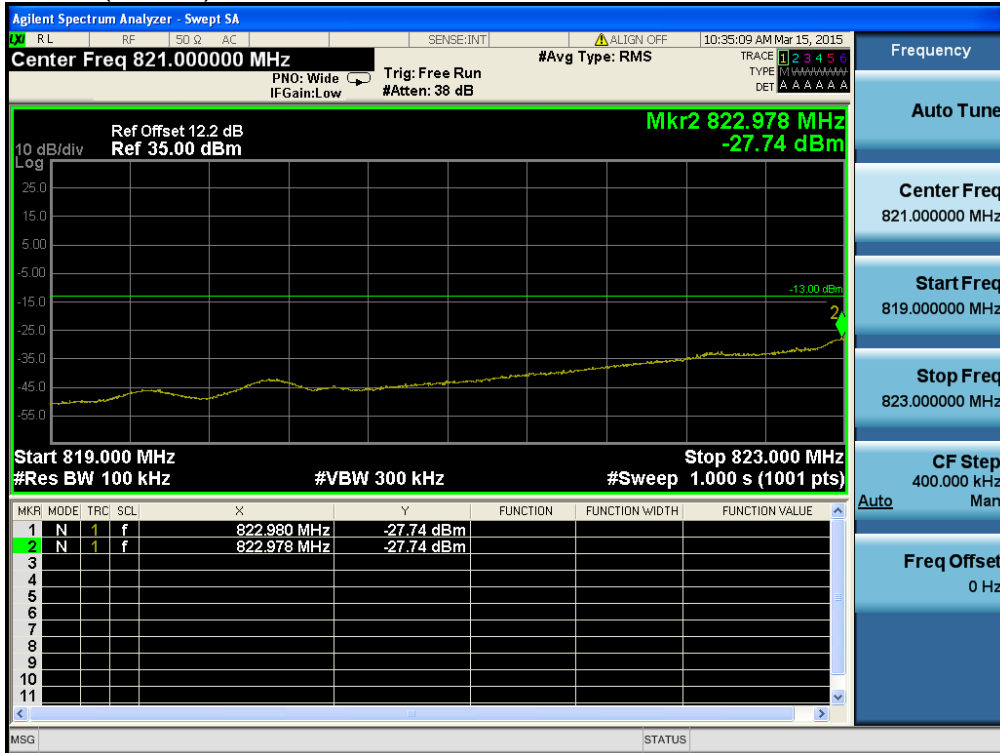

CDMA 1x EVDO(Rev. A) & Cellular band Channel: 777

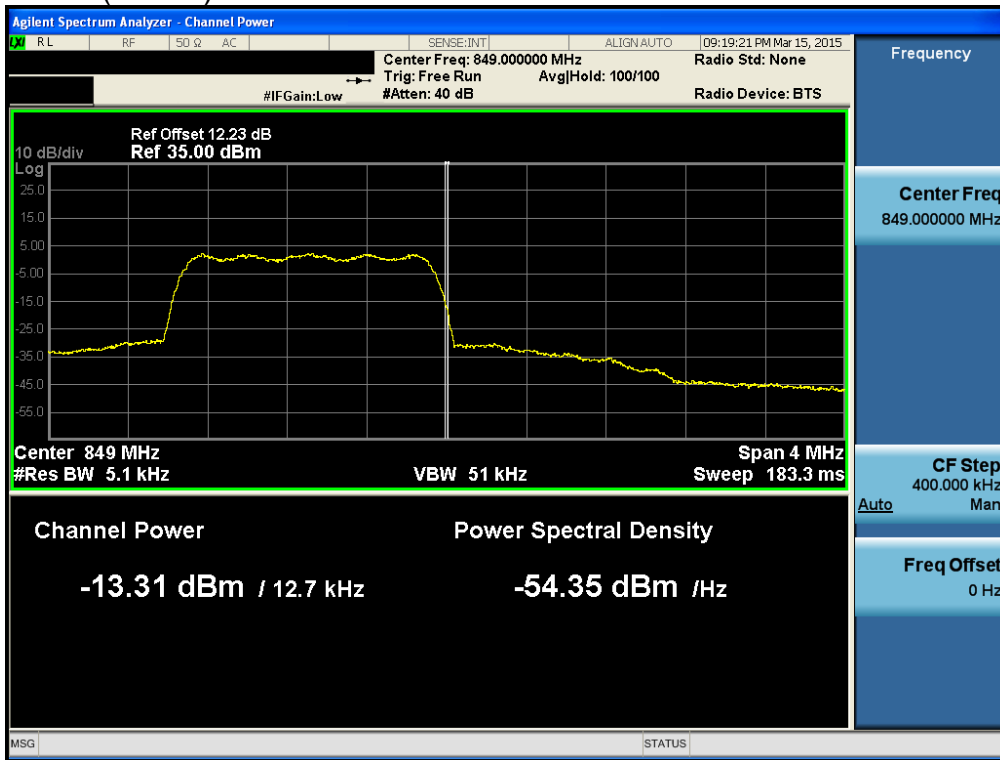

CDMA 1x EVDO(Rev. A) & Cellular band Channel: 777

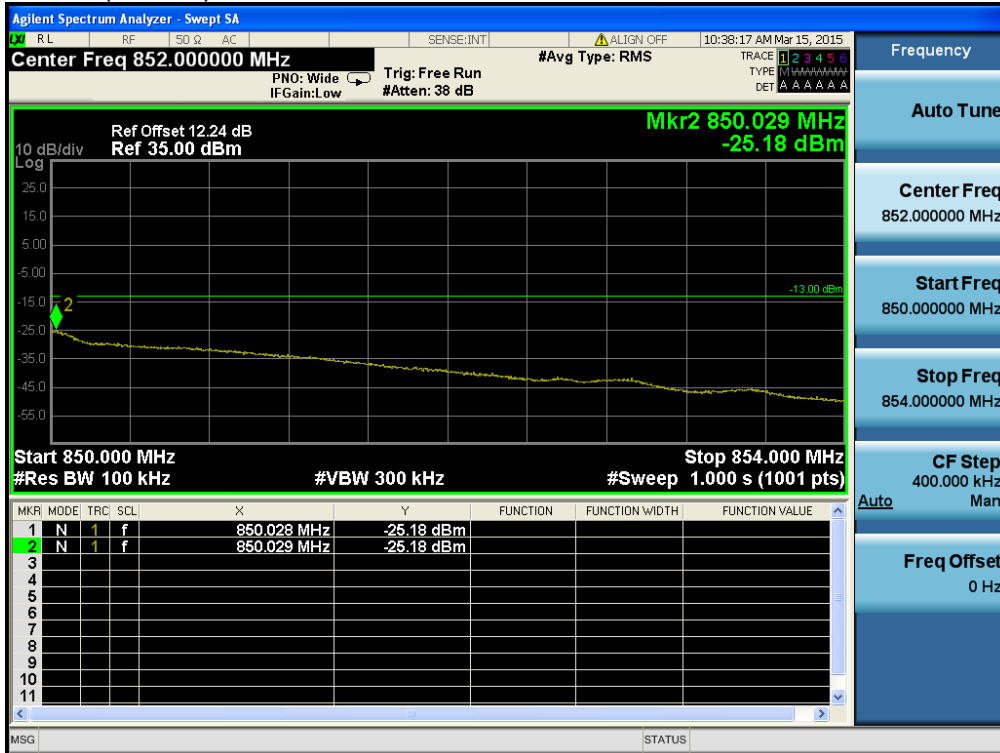

CDMA 1x & PCS band Channel: 25

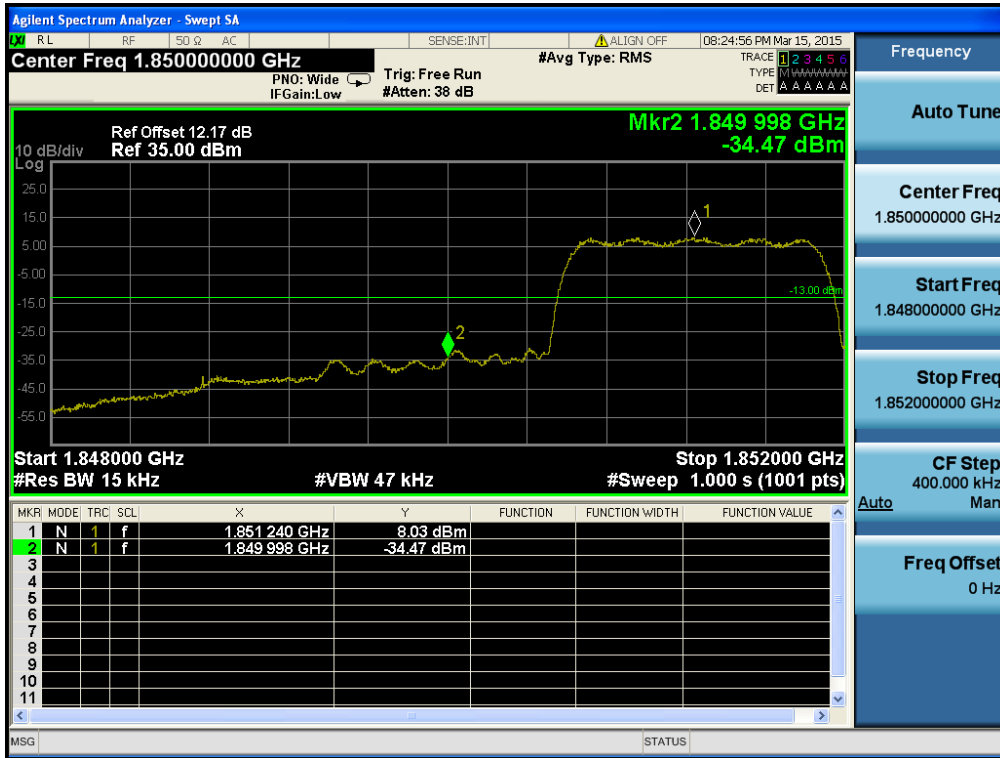

CDMA 1x & PCS band Channel: 25



CDMA 1x & PCS band Channel: 1175



CDMA 1x & PCS band Channel: 1175

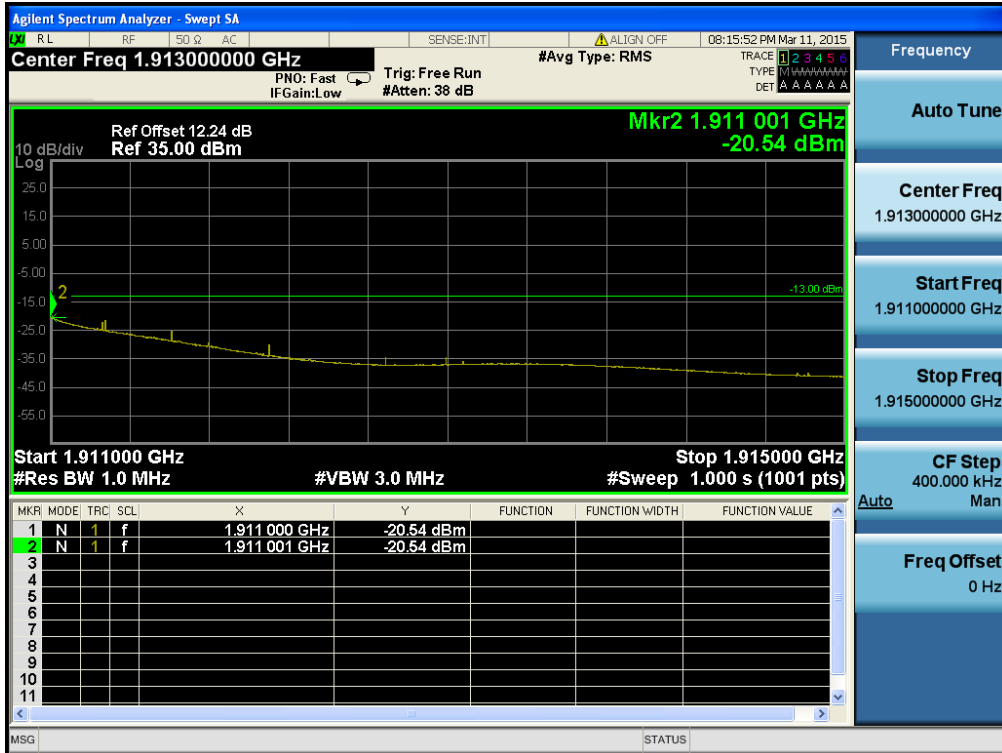

CDMA 1x EDVO(Rev. A) & PCS band Channel: 25



CDMA 1x EDVO(Rev. A) & PCS band Channel: 25

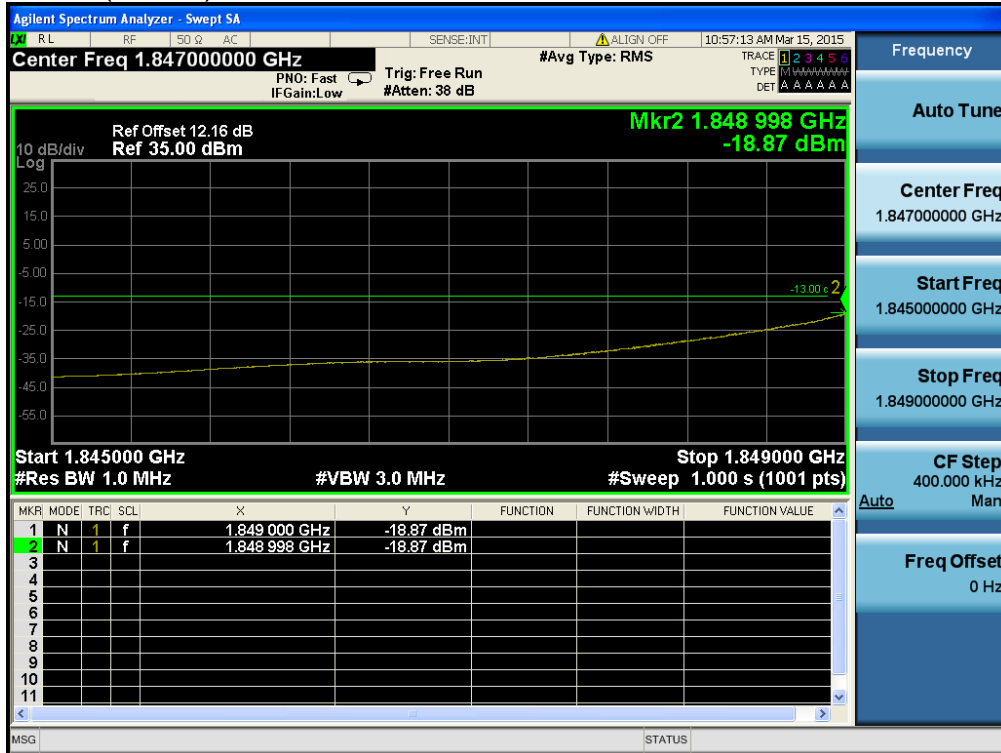

CDMA 1x EDVO(Rev. A) & PCS band Channel: 1175



CDMA 1x EDVO(Rev. A) & PCS band Channel: 1175

