

RF TEST REPORT

Test item : Telematics Modem
Model No. : LTD-VL2000
Order No. : DTNC1503-00940
Date of receipt : 2015-03-03
Test duration : 2015-03-09 ~ 2015-03-19
Date of issue : 2015-04-13
Use of report : FCC Original Grant

Applicant : LG Innotek Co.,Ltd.
978-1, Jangduk-dong, Gwangsan-gu, Gwangju-City, South Korea

Test laboratory : DT&C Co., Ltd.
42, Yurim-ro, 154beon-gil, Cheoin-gu, Yongin-si, Gyeonggi-do, Korea 449-935

Test specification : FCC Part 27
Test environment : See appended test report
Test result : Pass Fail

The test results presented in this test report are limited only to the sample supplied by applicant and the use of this test report is inhibited other than its purpose. This test report shall not be reproduced except in full, without the written approval of DT&C Co., Ltd.

Tested by:



Engineer
Chulmin Kim

Reviewed by:



Technical Manager
Bongjin Kim

Test Report Version

Test Report No.	Date	Description
DRTFCC1503-0068	Mar. 26, 2015	Initial issue
DRTFCC1503-0068(1)	Apr. 06, 2015	Add article 8.3, 8.4 note
DRTFCC1503-0068(2)	Apr. 13, 2015	Update max target power (tolerance), max antenna gain

Table of Contents

1. GENERAL INFORMATION	5
2. INTRODUCTION	6
2.1 EUT DESCRIPTION	6
2.2 MEASURING INSTRUMENT CALIBRATION.....	6
2.3 TEST FACILITY.....	6
3. DESCRIPTION OF TESTS.....	7
3.1 ERP&EIRP	7
3.2 PEAK TO AVERAGE RATIO	9
3.3 OCCUPIED BANDWIDTH.....	10
3.4 BAND EDGE EMISSIONS (Conducted).....	11
3.5 SPURIOUS AND HARMONIC EMISSIONS (Conducted).....	12
3.6 UNDESIRABLE EMISSIONS (Radiated).....	13
3.7 FREQUENCY STABILITY	14
4. LIST OF TEST EQUIPMENT	15
5. SUMMARY OF TEST RESULTS	16
6. SAMPLE CALCULATION	17
7. TEST DATA.....	18
7.1 CONDUCTED OUTPUT POWER.....	18
7.2 OCCUPIED BANDWIDTH.....	20
7.3 PEAKTOAVERAGERATIO.....	20
7.4 BAND EDGE EMISSIONS (Conducted).....	20
7.5 SPURIOUS AND HARMONICS EMISSIONS (Conducted)	20
7.6 EFFECTIVE RADIATED POWER (LTE Band 13)	21
7.7 EQUIVALENT ISOTROPIC RADIATED POWER (LTE Band 4).....	21
7.8 UNDESIRABLE EMISSIONS (RADIATED)	22
7.8.1 UNDESIRABLE EMISSIONS (LTE Band 13)	22
7.8.2 UNDESIRABLE EMISSIONS IN 763 ~ 775 MHz & 793 ~ 805 MHz(LTE Band 13)	23
7.8.3 UNDESIRABLE EMISSIONS IN 1559 ~ 1610 MHz(LTE Band 13).....	24
7.8.4 UNDESIRABLE EMISSIONS (LTE Band 4)	25
7.9 FREQUENCY STABILITY	26
7.9.1 LTE Band 13.....	26
7.9.2 LTE Band 4.....	27
8. TEST PLOTS	28
8.1 OCCUPIED BANDWIDTH.....	28
8.1.1 LTE Band 13.....	28
8.1.2 LTE Band 4.....	30
8.2 PEAK TO AVERAGE RATIO	36
8.2.1 LTE Band 13.....	36
8.2.2 LTE Band 4.....	38
8.3 BAND EDEG EMISSIONS(Conducted).....	44

8.3.1 LTE Band 13..... 44
8.3.2 LTE Band 4..... 51
8.4 SPURIOUS AND HARMONICS EMISSIONS(Conducted) 63
8.4.1 LTE Band 13..... 63
8.4.2 LTE Band 4..... 65

1. GENERAL INFORMATION

Applicant Name: LG Innotek Co.,Ltd.

Address: 978-1, Jangduk-dong, Gwangsan-gu, Gwangju-City, South Korea

FCC ID : YZP-VL2000

FCC Classification : PCS Licensed Transmitter (PCB)

EUT Type : Telematics Modem

Model Name : LTD-VL2000

Add Model Name : N/A

Supplying power : DC 12V

Antenna Type : Cellular & PCS band for CDMA 1x EVDO(Rev. A) : External type
LTE for Band 13 and Band 4 : External type

Mode	Tx Frequency (MHz)	Emission Designator	Modulation	Conducted output power	
				Max power(dBm)	Max power(W)
LTE Band 13	779.5 ~ 784.5	4M49G7D	QPSK	22.940	0.197
LTE Band 13	779.5 ~ 784.5	4M49W7D	16QAM	22.020	0.159
LTE Band 13	782	8M95G7D	QPSK	22.760	0.189
LTE Band 13	782	8M92W7D	16QAM	22.050	0.160
LTE Band 4	1710.7 ~ 1754.3	1M09G7D	QPSK	23.600	0.229
LTE Band 4	1710.7 ~ 1754.3	1M09W7D	16QAM	22.890	0.195
LTE Band 4	1711.5 ~ 1753.5	2M69G7D	QPSK	23.580	0.228
LTE Band 4	1711.5 ~ 1753.5	2M70W7D	16QAM	22.890	0.195
LTE Band 4	1712.5 ~ 1752.5	4M48G7D	QPSK	23.670	0.233
LTE Band 4	1712.5 ~ 1752.5	4M48W7D	16QAM	23.400	0.219
LTE Band 4	1715 ~ 1750	8M94G7D	QPSK	23.950	0.248
LTE Band 4	1715 ~ 1750	8M95W7D	16QAM	23.080	0.203
LTE Band 4	1717.5 ~ 1747.5	13M4G7D	QPSK	23.530	0.225
LTE Band 4	1717.5 ~ 1747.5	13M4W7D	16QAM	23.060	0.202
LTE Band 4	1720 ~ 1745	17M9G7D	QPSK	23.800	0.240
LTE Band 4	1720 ~ 1745	17M9W7D	16QAM	23.100	0.204

2. INTRODUCTION

2.1 EUT DESCRIPTION

The Equipment Under Test(EUT) supports CDMA and EVDO(Rev. A) of Cellular/PCS bands and LTE(Band 4, 13). The EUT has below 2 transceivers.

1. CDMA 1x/ EVDO(Rev. A)
2. LTE

2.2 MEASURING INSTRUMENT CALIBRATION

The measuring equipment, which was utilized in performing the tests documented herein, has been calibrated in accordance with the manufacturer's recommendations for utilizing calibration equipment, which is traceable to recognized national standards.

2.3 TEST FACILITY

The 3M test site and conducted measurement facility used to collect the radiated data are located at the 42, Yurim-ro, 154beon-gil, Cheoin-gu, Yongin-si, Gyeonggi-do, Korea 449-935. The site is constructed in conformance with the requirements.

- 3M test site registration Number: 165783

3. DESCRIPTION OF TESTS

3.1 ERP&EIRP

(Effective Radiated Power & Equivalent Isotropic Radiated Power)

Test Set-up

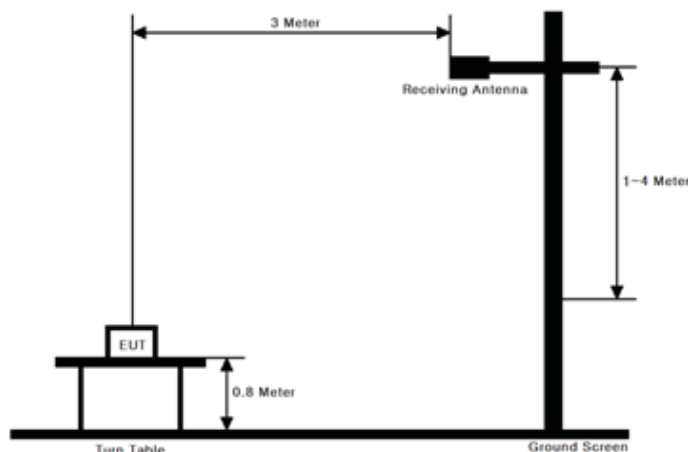

Test Procedure

- ANSI/TIA-603-C-2004 - Section 2.2.17
- KDB971168 v02r02 - Section 5.2.1

These measurements were performed at 3 & 10 m test site. The equipment under test is placed on a non-conductive table 0.8-meters above a turntable which is flush with the ground plane and 3 meters from the receive antenna.

Test setting

1. Set span to at least 1.5 times the OBW.
2. Set RBW = 1-5 % of the OBW, not to exceed 1 MHz.
3. Set VBW $\geq 3 \times$ RBW.
4. Set number of points in sweep $\geq 2 \times$ span / RBW.
5. Sweep time = auto couple.
6. Detector = RMS (power averaging).
7. If the EUT can be configured to transmit continuously (i.e., burst duty cycle ≥ 98 %), then set the trigger to free run.
8. If the EUT cannot be configured to transmit continuously (i.e., burst duty cycle < 98 %), then use a sweep trigger with the level set to enable triggering only on full power bursts and configure the EUT to transmit at full power for the entire duration of each sweep.
Ensure that the sweep time is less than or equal to the transmission burst duration.
9. Trace average at least 100 traces in power averaging (i.e., RMS) mode.
10. Compute the power by integrating the spectrum across the OBW of the signal using the instrument's band power measurement function, with the band limits set equal to the OBW band edges. If the instrument does not have a band power function, then sum the spectrum levels (in linear power units) at intervals equal to the RBW extending across the entire OBW of the spectrum.

The receive antenna height and turntable rotations were adjusted for the highest reading on the receive spectrum analyzer.

A half-wave dipole was substituted in place of the EUT. This dipole antenna was driven by a signal generator and the level of the signal generator was adjusted to obtain the same receive spectrum analyzer reading. The conducted power at the terminal of the substitute antenna is measured.

The ERP/EIRP is calculated using the following formula:

ERP/EIRP = The conducted power at the substitute antenna's terminal [dBm] + Substitute Antenna gain [dBd for ERP , dBi for EIRP]

For readings above 1 GHz, the above procedure is repeated using horn antennas and the difference between the gain of the horn antenna and an isotropic antenna are taken into consideration.

3.2 PEAK TO AVERAGE RATIO

Test set-up

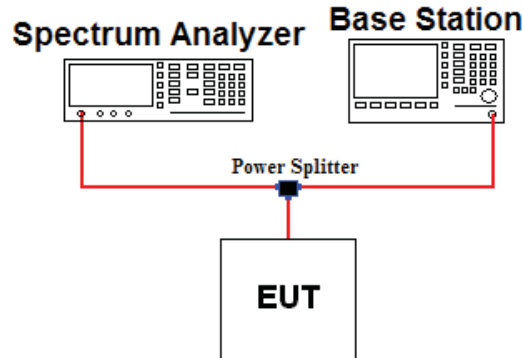

Test Procedure

- KDB971168 v02r02 - Section 5.7.1

A peak to average ratio measurement is performed at the conducted port of the EUT. The spectrum analyzer's Complementary Cumulative Distribution Function (CCDF) measurement profile is used to determine the largest deviation between the average and the peak power of the EUT in a given bandwidth. The CCDF curve shows how much time the peak waveform spends at or above a given average power level. The present of time the signal spends at or above the level defines the probability for that particular power level.

Test setting

The spectrum Analyzer's CCDF measurement function is enabled.

1. Set resolution/measurement bandwidth \geq signal's occupied bandwidth.
2. Set the number of counts to a value that stabilizes the measured CCDF curve
3. Set the measurement interval as follows:
 - 1) For continuous transmissions, set to 1 ms.
 - 2) For burst transmissions, employ an external trigger that is synchronized with the EUT burst timing sequence, or use the internal burst trigger with a trigger level that allows the burst to stabilize and set the measurement interval to a time that is less than or equal to the burst duration.
4. Record the maximum PAPR level associated with a probability of 0.1 %

3.3 OCCUPIED BANDWIDTH.

Test set-up

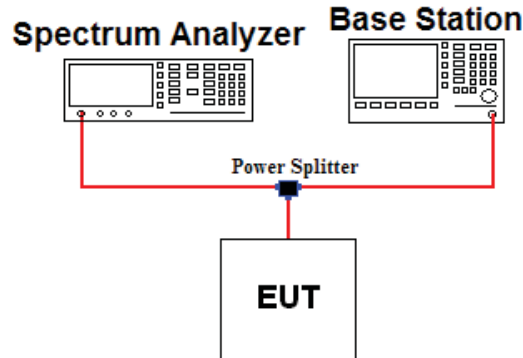

Test Procedure

- KDB971168 v02r02 - Section 4.2

The occupied bandwidth, that is the frequency bandwidth such that, below its lower and above its upper frequency limits, the mean powers radiated are each equal to 0.5 percent of the total mean power of a given emission. And worst case data are reported in the plot.

Test setting

1. The signal analyzer's automatic bandwidth measurement capability was used to perform the 99 % occupied bandwidth and the 26 dB bandwidth. The bandwidth measurement was not influenced by any intermediate power nulls in the fundamental emission.
2. $RBW = 1 \sim 5 \%$ of the expected OBW & $VBW \geq 3 \times RBW$
3. Detector = Peak
4. Trance mode = Max hold
5. Sweep = Auto couple
6. The trace was allowed to stabilize
7. If necessary, step 2 ~ 6 were repeated after changing the RBW such that it would be within $1 \sim 5 \%$ of the 99 % occupied bandwidth observed in step 6.

3.4 BAND EDGE EMISSIONS (Conducted)

Test set-up

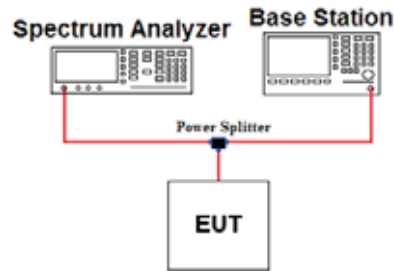

Test Procedure

- KDB971168 v02r02 - Section 6.0

All out of band emissions are measured by means of a calibrated spectrum analyzer. The EUT was setup to maximum output power at its lowest and highest channel with all bandwidths, modulations and RB configurations.

The power of any spurious emission shall be attenuated below the transmitter power (P) by at least $43 + 10 \log(P)$ dB or requirements on note 2 in case of band 7 and 41.

Test setting

1. Start and stop frequency were set such that the band edge would be placed in the center of the plot
2. Span was set large enough so as to capture all out of band emissions near the band edge
3. RBW $\geq 1\%$ of the emission bandwidth or 2% of the emission bandwidth (refer to note 2)
4. VBW $\geq 3 \times$ RBW
5. Detector = RMS & Trace mode = Max hold
6. Sweep time = Auto couple or 1 s for band edge
7. Number of sweep point $\geq 2 \times$ span / RBW
8. The trace was allowed to stabilize

Note 1: In the 1 MHz bands immediately outside and adjacent to the frequency block a resolution bandwidth of **at least one percent** of the emission bandwidth of the fundamental emission of the transmitter may be employed to demonstrate compliance with the out-of-band emissions limit. The emission bandwidth is defined as the width of the signal between two points, one below the carrier center frequency and one above the carrier center frequency, outside of which all emission are attenuated at least 26 dB below the transmitter power.

Note 2: For part 27.53(m)(4) the attenuation factor shall be not less than $40 + 10 \log(P)$ dB on all frequencies between the channel edge and 5 MHz from the channel edge, $43 + 10 \log(P)$ dB on all frequencies between 5 MHz and X MHz from the channel edge, and $55 + 10 \log(P)$ dB on all frequencies more than X MHz from the channel edge, where X is the greater of 6 MHz or the actual emission bandwidth as defined in paragraph (m)(6) of this section. In addition, the attenuation factor shall not be less that $43 + 10 \log(P)$ dB on all frequencies between 2490.5 MHz and 2496 MHz and $55 + 10 \log(P)$ dB at or below 2490.5 MHz. For mobile digital stations, in the 1 MHz bands immediately outside and adjacent to the frequency block a resolution bandwidth of **at least two percent** may be employed, except when the 1 MHz band is 2495-2496 MHz, in which case a resolution bandwidth of **at least one percent** may be employed.

3.5 SPURIOUS AND HARMONIC EMISSIONS (Conducted)

Test set-up

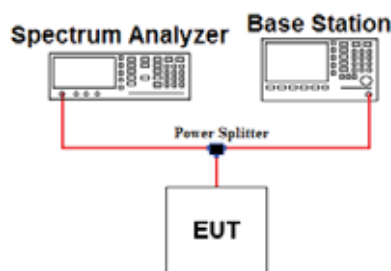

Test Procedure

- KDB971168 v02r02 - Section 6.0

The level of the carrier and the various conducted spurious and harmonic frequencies is measured by means of a calibrated spectrum analyzer. The EUT was setup to maximum output power at its low, middle, high channel with all bandwidths, modulations and RB configurations. The spectrum is scanned from 30 MHz up to a frequency including its 10th harmonic.

The power of any spurious emission shall be attenuated below the transmitter power (P) by at least $43 + 10 \log(P)$ dB or $55 + 10 \log(P)$ in case of band 7 and 41.

Test setting

1. RBW = 100 KHz or 1 MHz & VBW $\geq 3 \times$ RBW (Refer to Note 1)
2. Detector = RMS & Trace mode = Max hold
3. Sweep time = Auto couple
4. Number of sweep point $\geq 2 \times$ span / RBW
5. The trace was allowed to stabilize

Note 1: Compliance with these provisions is based on the use of measurement instrumentation employing a resolution bandwidth of 100 kHz or greater for Part 22 and 1 MHz or greater for Part 24, 27.

3.6 UNDESIRABLE EMISSIONS (Radiated)

Test Set-up

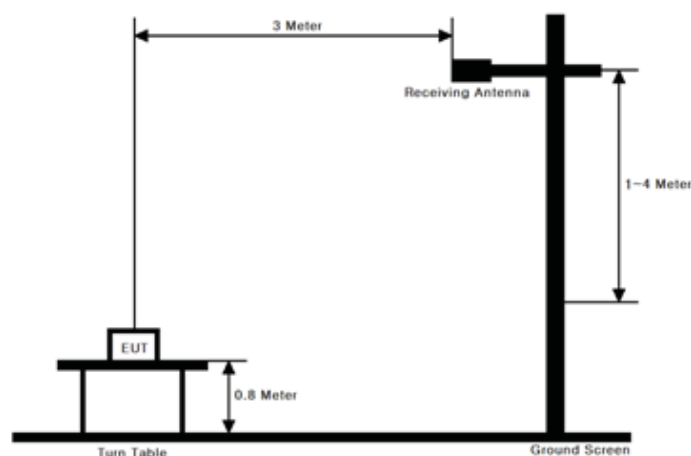

Test Procedure

- ANSI/TIA-603-C-2004 - Section 2.2.12
- KDB971168 v02r02 - Section 5.8

These measurements were performed at 3 & 10m test site. The equipment under test is placed on a non-conductive table 0.8-meters above a turntable which is flush with the ground plane and 3 meters from the receive antenna.

Test setting

1. RBW = 100 kHz for below 1 GHz and 1 MHz for above 1 GHz / VBW \geq 3 X RBW
2. Detector = Peak & Trace mode = Max hold
3. Sweep time = Auto couple
4. Number of sweep point \geq 2 X span / RBW
5. The trace was allowed to stabilize

The receive antenna height and turntable rotations were adjusted for the highest reading on the receive spectrum analyzer.

For radiated power measurements below 1 GHz, a half-wave dipole was substituted in place of the EUT. This dipole antenna was driven by a signal generator and the level of the signal generator was adjusted to obtain the same spectrum analyzer reading.

For radiated power measurements above 1 GHz, a Horn antenna was substituted in place of the EUT. This Horn antenna was driven by a signal generator and the level of the signal generator was adjusted to obtain the same spectrum analyzer reading. The difference between the gain of the horn and an isotropic antenna are taken into consideration.

This measurement was performed with the EUT oriented in 3 orthogonal axis.

3.7 FREQUENCY STABILITY

Test Set-up

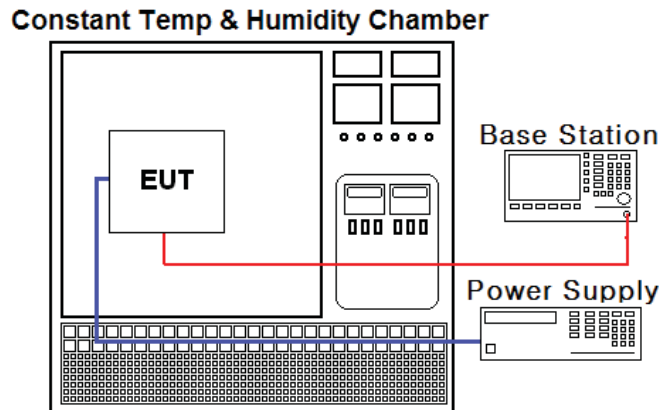

Test Procedure

- ANSI/TIA-603-C-2004
- KDB971168 v02r02 - Section 9.0

The frequency stability of the transmitter is measured by:

a.) Temperature:

The temperature is varied from - 30 °C to + 50 °C using an environmental chamber.

b.) Primary Supply Voltage:

The primary supply voltage is varied from 85 % to 115 % of the nominal value for non hand-carried battery and AC powered equipment. For hand-carried, battery-powered equipment, primary supply voltage is reduced to the battery operating end point which shall be specified by the manufacturer.

Specification:

The frequency stability shall be sufficient to ensure that the fundamental emission stays within the authorized frequency block for Part 24. The frequency stability of the transmitter shall be maintained within $\pm 0.00025\%$ (± 2.5 ppm) of the center frequency for Part 22.

Time Period and Procedure:

1. The carrier frequency of the transmitter is measured at room temperature.
(25 °C to provide a reference)
2. The equipment is turned on in a "standby" condition for one minute before applying power to the transmitter. Measurement of the carrier frequency of the transmitter is made within one minute after applying power to the transmitter.
3. Frequency measurements are made at 10 °C intervals ranging from -30 °C to +50 °C.
A period of at least one half-hour is provided to allow stabilization of the equipment at each temperature level.

4. LIST OF TEST EQUIPMENT

Type	Manufacturer	Model	Cal.Date (yy/mm/dd)	Next.Cal. Date (yy/mm/dd)	S/N
Multimeter	Fluke	17B	14/05/12	15/05/12	26030065WS
DC Power Supply	Agilent	66332A	15/01/22	16/01/22	GB37470200
Power Splitter	Anritsu	K241B	14/10/21	15/10/21	1701101
Thermohygrometer	BODYCOM	BJ5478	15/02/26	16/02/26	1209
Temp &Humi Test Chamber	SJ Science	SJ-TH-S50	14/10/21	15/10/21	SJ-TH-S50-130930
MXA Signal Analyzer	Agilent	N9020A	14/08/21	15/08/21	MY49060056
Signal Generator	Rohde Schwarz	SMF100A	14/07/01	15/07/01	102341
Vector Signal Generator	Rohde Schwarz	SMBV100A	15/01/06	16/01/06	255571
Loop Antenna	Schwarzbeck	FMZB1513	14/04/29	16/04/29	1513-128
Dipole Antenna	Schwarzbeck	VHA9103	13/10/24	15/10/24	2116
Dipole Antenna	Schwarzbeck	VHA9103	14/04/01	16/04/01	2117
Dipole Antenna	Schwarzbeck	UHA9105	13/10/24	15/10/24	2261
Dipole Antenna	Schwarzbeck	UHA9105	14/04/01	16/04/01	2262
Bilog Antenna	Schwarzbeck	VULB 9160	14/04/04	16/04/04	3357
HORN ANT	ETS	3115	15/02/09	17/02/09	00021097
HORN ANT	ETS	3117	14/05/12	16/05/12	140394
HORN ANT	A.H.Systems	SAS-574	13/03/20	15/03/20	154
HORN ANT	A.H.SYSTEMS	SAS-574	13/05/27	15/05/27	155
Low Noise Pre Amplifier	TSJ	MLA-010K01-B01-27	14/04/09	15/04/09	1844538
PreAmplifier	Agilent	8449B	14/11/06	15/11/06	3008A02108
PreAmplifier	A.H. SYSTEMS	PAM-1840VH	14/12/12	15/12/12	163
High-pass filter	Wainwright	WHKX12-935-1000-15000-40SS	14/09/11	15/09/11	7
High-pass filter	Wainwright	WHKX12-2580-3000-18000-80SS	14/09/11	15/09/11	3
High-pass filter	Wainwright	WHNX5.0	14/09/12	15/09/12	8
RadioCommunication Analyzer	Anritsu	MT8820C	15/01/09	16/01/09	6201274516

5. SUMMARY OF TEST RESULTS

FCC Part Section(s)	Test Description	Test Limit	Test Condition	Status Note 1	Reference
2.1046	Conducted Output Power	N/A	Conducted	C	Section 7.1
2.1049	Occupied Bandwidth	N/A		C	Section 7.2, 8.1, 8.2
24.232(d)	Peak to Average Ratio	< 13dB		C	Section 7.3, 8.3, 8.4
2.1051 27.53(c.2) 27.53(h)	Undesirable Emissions at band edge and for all out-of-band emissions	< 43+10log ₁₀ (P) dB		C	Section 7.4, 8.5, 8.6
27.53(c.4)	Undesirable Emissions in 763 ~ 775MHz & 793 ~ 805MHz	< 65+10log ₁₀ (P) dB		C	Section 7.4, 8.5
2.1055 27.54	Frequency Stability	Fundamental emissions must stay within authorized frequency block		C	Section 7.8
27.50(b.10)	Effective Radiated Power	< 3W ERP	Radiated	C	Section 7.5
27.50(d.4)	Equivalent Isotropic Radiated Power	< 1W EIRP		C	Section 7.6
2.1051 27.53(c.2) 27.53(h)	Undesirable Emissions at band edge and for all out-of-band emissions	< 43+10log ₁₀ (P) dB		C	Section 7.7
27.53(f)	Undesirable Emissions in 1559 ~ 1610MHz	< -70dBW/MHz (-40dBm/MHz)		C	Section 7.7
27.53(c.4)	Undesirable Emissions in 763 ~ 775MHz & 793 ~ 805MHz	< 65+10log ₁₀ (P) dB		C	Section 7.7
Note1: C =Comply NC =Not Comply NT =Not Tested NA =Not Applicable					

The sample was tested according to the following specification:
ANSI/TIA/EIA-603-C-2004 and KDB 971168 D01 v02r02

6. SAMPLE CALCULATION

A. Emission Designator

LTE Band 13(QPSK)

Emission Designator = **8M95G7D**

LTE OBW = 8.947 MHz

G = Phase Modulation

7 = Quantized/Digital Info

D = Data Transmission

LTE Band 13(16QAM)

Emission Designator = **8M92W7D**

LTE OBW = 8.915 MHz

W = Amplitude/Angle Modulated

7 = Quantized/Digital Info

D = Data Transmission

LTE Band 4(QPSK)

Emission Designator = **17M86G7D**

LTE OBW = 17.863 MHz

G = Phase Modulation

7 = Quantized/Digital Info

D = Data Transmission

LTE Band 4(16QAM)

Emission Designator = **17M89W7D**

LTE OBW = 17.892 MHz

W = Amplitude/Angle Modulated

7 = Quantized/Digital Info

D = Data Transmission

B. RADIATED SPURIOUS EMISSIONS Sample Calculation

Test Freq. (MHz)	RB Size/ Offset	Test Mode	Spectrum Reading		EUT Axis	Ant Pol (H/V)	Level(dBm) @ Ant Terminal	TX Ant Gain(dBd)	Result	
			Freq.(MHz)	Value (dBm)					(dBm)	Margin (dB)
782	1/49	QPSK	1572.99	-54.44	Y	V	-55.60	6.55	-49.05	36.05

RADIATED SPURIOUS EMISSIONS = @ Ant Terminal LEVEL(dBm) + Ant. Gain

- 1) The EUT mounted on a non-conductive turntable is 0.8 meter above test site ground level.
- 2) During the test, the turn table is rotated until the maximum signal is found.
- 3) Record the field strength meter's level.
- 4) Replace the EUT with dipole/Horn antenna that is connected to a calibrated signal generator.
- 5) Increase the signal generator output till the field strength meter's level is equal to the item (3).
- 6) The signal generator output level with Ant. Gain is the rating of RADIATED SPURIOUS EMISSIONS.

7. TEST DATA

7.1 CONDUCTED OUTPUT POWER

A base station simulator was used to establish communication with the EUT. The base station simulator parameters were set to produce the maximum power from the EUT. This device was tested under all configurations and the highest power is reported. Conducted Output Powers of EUT are reported below.

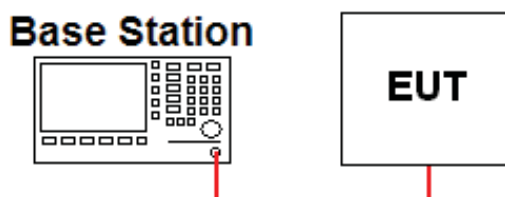

▪ Band 13

Conducted Power [dBm]									
RB Alloc			1 RB			MID RB			FULL RB
B.W(MHz)	Freq.(MHz)	Modulation	LOW	MID	HIGH	LOW	MID	HIGH	
10	782	QPSK	22.750	22.610	22.760	21.650	21.580	21.500	21.390
		16QAM	22.050	21.710	21.890	20.670	20.610	20.590	20.370
5	779.5	QPSK	22.940	22.770	22.740	21.710	21.670	21.790	21.710
		16QAM	22.020	21.970	21.940	20.800	20.770	20.800	20.730
	784.5	QPSK	22.600	22.590	22.610	21.370	21.490	21.610	21.460
		16QAM	21.750	21.780	21.720	20.500	20.610	20.660	20.500

Note 1: The conducted output power was measured using the Anritsu MT8820C

Note 2: The number of Mid RB are used 25,12 for 10,5MHz B.W

▪ Band 4

Conducted Power [dBm]									
RB Alloc			1 RB			MID RB			FULL RB
B.W(MHz)	Freq.(MHz)	Modulation	LOW	MID	HIGH	LOW	MID	HIGH	
20	1720	QPSK	23.550	23.290	23.800	22.170	22.170	22.120	22.140
		16QAM	22.980	22.640	23.100	21.470	21.350	21.370	21.480
	1745	QPSK	23.510	22.990	23.350	22.090	21.740	21.980	22.060
		16QAM	22.950	22.460	22.780	21.450	21.090	21.260	21.410
15	1717.5	QPSK	23.530	23.490	23.290	22.280	22.230	22.060	22.090
		16QAM	22.910	22.760	22.640	21.720	21.550	21.350	21.450
	1732.5	QPSK	23.390	23.520	23.400	22.520	22.390	22.290	22.420
		16QAM	22.790	23.060	22.920	21.780	21.750	21.710	21.600
	1747.5	QPSK	23.310	23.080	23.380	21.810	21.880	22.110	21.840
		16QAM	22.850	22.400	22.750	21.150	21.320	21.480	21.170
10	1715	QPSK	23.480	23.520	23.280	22.320	22.340	22.460	22.170
		16QAM	22.940	22.900	22.570	21.700	21.770	21.630	21.590
	1732.5	QPSK	23.950	23.600	23.600	22.530	22.420	22.410	22.230
		16QAM	23.080	23.080	22.900	21.840	21.830	21.760	21.640
	1750	QPSK	22.960	23.270	23.390	21.930	22.190	22.170	21.940
		16QAM	22.350	22.700	22.760	21.280	21.530	21.550	21.270
5	1712.5	QPSK	23.510	23.350	23.470	22.340	22.370	22.340	22.290
		16QAM	22.880	22.780	22.790	21.700	21.760	21.790	21.730
	1732.5	QPSK	23.670	23.580	23.670	22.500	22.480	22.420	22.410
		16QAM	23.030	22.960	23.050	21.830	21.880	21.750	21.740
	1752.5	QPSK	23.340	23.340	23.440	22.320	22.300	22.300	22.280
		16QAM	22.640	23.400	22.730	21.630	21.650	21.610	21.560
3	1711.5	QPSK	23.540	23.470	23.440	22.400	22.300	22.350	22.360
		16QAM	22.730	22.770	22.680	21.590	21.560	21.580	21.710
	1732.5	QPSK	23.570	23.480	23.580	22.510	22.460	22.380	22.390
		16QAM	22.770	22.890	22.860	21.740	21.640	21.660	21.730
	1753.5	QPSK	23.380	23.330	23.420	22.280	22.290	22.270	22.320
		16QAM	22.560	22.600	22.600	21.550	21.570	21.540	21.570
1.4	1710.7	QPSK	23.290	23.380	23.310	23.310	23.320	23.280	22.330
		16QAM	22.660	22.610	22.580	22.550	22.640	22.630	21.710
	1732.5	QPSK	23.600	23.520	23.490	23.490	23.450	23.410	22.460
		16QAM	22.890	22.870	22.780	22.790	22.740	22.690	21.860
	1754.3	QPSK	23.320	23.420	23.480	23.290	23.290	23.330	22.360
		16QAM	22.600	22.600	22.620	22.460	22.420	22.460	21.560

Note 1: The conducted output power was measured using the Anritsu MT8820C

Note 2: The number of Mid RB are used 50,36,25,12,8,3 for 20,15,10,5,3,1.4MHz B.W

7.2 OCCUPIED BANDWIDTH

- Plots of the EUT's Occupied Bandwidth are shown in Clause 8.1

7.3 PEAK TO AVERAGE RATIO

- Plots of the EUT's Peak- to- Average Ratio are shown in Clause 8.2

7.4 BAND EDGE EMISSIONS (Conducted)

- Plots of the EUT's Band Edge Emissions are shown in Clause 8.3

7.5 SPURIOUS AND HARMONICS EMISSIONS (Conducted)

- Plots of the EUT's Spurious Emissions are shown in Clause 8.4

7.6 EFFECTIVE RADIATED POWER (LTE Band 13)

Band	Mode	Maximum Output Power(dBm)	Antenna Gain (dBd)	ERP (dBm)	LIMIT (dBm)
13	QPSK	24.50	4.34	28.84	34.77
13	16QAM	24.50	4.34	28.84	34.77

Note 1: The maximum output power used max tune-up power.

Note 2: Available max Antenna gain is 6.49 dBi in Band 13 of LTE, and compliant with MPE requirement.

7.7 EQUIVALENT ISOTROPIC RADIATED POWER (LTE Band 4)

Band	Mode	Maximum Output Power(dBm)	Antenna Gain (dBi)	EIRP (dBm)	LIMIT (dBm)
4	QPSK	24.50	5.49	29.99	30.00
4	16QAM	24.50	5.49	29.99	30.00

Note 1: The maximum output power used max tune-up power.

Note 2: Available max Antenna gain is 5.49 dBi in Band4 of LTE, and compliant with MPE requirement.

7.8 UNDESIRABLE EMISSIONS (RADIATED)**7.8.1 UNDESIRABLE EMISSIONS (LTE Band 13)**

B.W (MHz)	Test Freq. (MHz)	RB Size/Offset	Test Mode	Freq.(MHz)	EUT Axis	Ant Pol (H/V)	Level(dBm) @ Ant Terminal	TX Ant Gain(dBd)	Result (dBm)	Margin (dB)	Limit (dBm)
10	782	1/49	QPSK	1572.99	Y	V	-55.60	6.55	-49.05	36.05	-13
				3145.87	Y	V	-54.67	7.66	-47.01	34.01	
5	779.5	1/0	QPSK	1544.65	Y	V	-56.11	6.52	-49.59	36.59	
				3109.39	Y	V	-56.54	7.62	-48.92	35.92	
	784.5	1/24	QPSK	1573.32	Y	V	-58.14	6.55	-51.59	38.59	
				3146.69	Y	V	-56.53	7.66	-48.87	35.87	

Note 1: Limit Calculation= $43 + 10\log_{10}(P_{\text{Watts}})$

Note 2: This device was tested under all modulations, RB size and RB offsets and the worst case data are reported in the table above. (The worst case mode is the QPSK modulation type with RB Size 1)

Note 3: No other spurious and harmonic emissions were reported greater than listed emissions above table.

7.8.2 UNDESIRABLE EMISSIONS IN 763 ~ 775 MHz & 793 ~ 805 MHz(LTE Band 13)

B.W (MHz)	Test Freq. (MHz)	RB Size/ Offset	Test Mode	Freq.(MHz)	EUT Axis	Ant Pol (H/V)	Level(dBm) @ Ant Terminal	TX Ant Gain(dBd)	Result (dBm)	Margin (dB)	Limit (dBm)
10	782	1/49	QPSK	774.30	X	H	-42.90	1.34	-41.56	6.56	-35
				804.30	X	H	-49.03	1.33	-47.70	12.70	
5	779.5	1/24	QPSK	774.34	X	H	-43.24	1.34	-41.90	6.90	
				796.81	X	H	-49.05	1.37	-47.68	12.68	
	784.5	1/0	QPSK	773.82	X	H	-48.93	1.34	-47.59	12.59	
				796.29	X	H	-49.94	1.37	-48.57	13.57	

Note 1: This device was tested under all modulations, RB size and RB offsets and the worst case data are reported in the table above. (The worst case mode is the QPSK modulation type with RB Size 1)

Note 2: For part 27.53(c)(4) measurement, the FCC limit is $65 + 10\log_{10}(P_{\text{Watts}}) = -35\text{dBm}$ in a 6.25kHz bandwidth. Since it was not possible to set the resolution bandwidth to 6.25kHz with the available equipment, a bandwidth of 10kHz was used instead to show compliance. By using a 10kHz bandwidth, the result was adjusted by $10\log_{10}(10\text{kHz}/6.25\text{kHz}) = 2.04\text{dB}$.

Note 3: No other spurious and harmonic emissions were reported greater than listed emissions above table.

7.8.3 UNDESIRABLE EMISSIONS IN 1559 ~ 1610 MHz(LTE Band 13)

B.W (MHz)	Test Freq. (MHz)	RB Size/ Offset	Test Mode	Freq.(MHz)	EUT (Axis)	Ant Pol (H/V)	Level(dBm) @ Ant Terminal	TX Ant Gain(dBi)	Result (dBm)	Margin (dB)	Limit (dBm/MHz)
10	782	1/49	QPSK	1563.98	Y	V	-60.28	6.54	-53.74	13.74	-40.00
		-	-	-	-	-	-	-	-	-	
5	779.5	1/24	QPSK	1563.59	Y	V	-60.12	6.54	-53.58	13.58	
		-	-	-	-	-	-	-	-	-	
	784.5	1/0	QPSK	1564.81	Y	V	-59.94	6.54	-53.40	13.40	
		-	-	-	-	-	-	-	-	-	

Note 1: This device was tested under all modulations, RB size and RB offsets and the worst case data are reported in the table above. (The worst case mode is the QPSK modulation type with RB Size 1 and Full RB)

Note 2: No other spurious and harmonic emissions were reported greater than listed emissions above table.

7.8.4 UNDESIRABLE EMISSIONS (LTE Band 4)

B.W (MHz)	Test Freq. (MHz)	RB Size/ Offset	Test Mode	Freq.(MHz)	EUT Axis	Ant Pol (H/V)	Level(dBm) @ Ant Terminal	TX Ant Gain(dBi)	Result (dBm)	Margin (dB)	Limit (dBm)
20	1720	1/99	QPSK	3457.74	Y	V	-31.74	10.07	-21.67	8.67	-13
				5186.59	Y	V	-52.08	10.76	-41.32	28.32	
	1745	1/0	QPSK	3472.17	Y	V	-28.59	10.09	-18.50	5.50	
				5208.13	Y	V	-51.76	10.77	-40.99	27.99	
15	1717.5	1/0	QPSK	2421.80	Y	V	-34.14	9.67	-24.47	11.47	
				5132.55	Y	V	-53.33	10.74	-42.59	29.59	
	1732.5	1/37	QPSK	3465.03	Y	V	-28.10	10.08	-18.02	5.02	
				5197.48	Y	V	-50.43	10.77	-39.66	26.66	
	1747.5	1/74	QPSK	3508.49	Y	V	-30.77	10.10	-20.67	7.67	
				5262.75	Y	V	-53.02	10.80	-42.22	29.22	
10	1715	1/25	QPSK	3430.08	Y	V	-33.05	10.05	-23.00	10.00	
				5145.18	Y	V	-54.30	10.74	-43.56	30.56	
	1732.5	1/0	QPSK	3456.18	Y	V	-27.60	10.07	-17.53	4.53	
				5184.35	Y	V	-50.82	10.76	-40.06	27.06	
	1750	1/49	QPSK	3508.75	Y	V	-31.43	10.10	-21.33	8.33	
				5263.02	Y	V	-51.59	10.80	-40.79	27.79	
5	1712.5	1/0	QPSK	3420.68	Y	V	-32.63	10.04	-22.59	9.59	
				5130.78	Y	V	-53.25	10.74	-42.51	29.51	
	1732.5	1/24	QPSK	3469.50	Y	V	-28.07	10.08	-17.99	4.99	
				5204.08	Y	V	-52.93	10.77	-42.16	29.16	
	1752.5	1/24	QPSK	3509.33	Y	V	-30.88	10.10	-20.78	7.78	
				5264.03	Y	V	-52.18	10.80	-41.38	28.38	
3	1711.5	1/0	QPSK	3420.42	Y	V	-31.70	10.04	-21.66	8.66	
				5130.68	Y	V	-51.78	10.74	-41.04	28.04	
	1732.5	1/14	QPSK	3467.67	Y	V	-28.33	10.08	-18.25	5.25	
				5201.45	Y	V	-54.53	10.77	-43.76	30.76	
	1753.5	1/14	QPSK	3509.57	Y	V	-30.63	10.10	-20.53	7.53	
				5264.17	Y	V	-53.07	10.80	-42.27	29.27	
1.4	1710.7	1/3	QPSK	3421.51	Y	V	-32.40	10.04	-22.36	9.36	
				5132.29	Y	V	-52.25	10.74	-41.51	28.51	
	1732.5	1/0	QPSK	3464.05	Y	V	-28.49	10.08	-18.41	5.41	
				5196.22	Y	V	-49.16	10.77	-38.39	25.39	
	1754.3	1/5	QPSK	3509.58	Y	V	-30.06	10.10	-19.96	6.96	
				5264.52	Y	V	-47.07	10.80	-36.27	23.27	

Note 1: Limit Calculation= $43 + 10\log_{10}(P_{\text{Watts}})$

Note 2: This device was tested under all modulations, RB size and RB offsets and the worst case data are reported in the table above. (The worst case mode is the QPSK modulation type with RB Size 1)

Note 3: No other spurious and harmonic emissions were reported greater than listed emissions above table.

7.9 FREQUENCY STABILITY

7.9.1 LTE Band 13

OPERATING FREQUENCY : 782,000,000 Hz
 CHANNEL : 23230
 REFERENCE VOLTAGE : 12 VDC
 DEVIATION LIMIT : ± 0.00025 % or 2.5 ppm

VOLTAGE (%)	POWER (V DC)	TEMP (°C)	FREQUENCY (Hz)	FREQ.Dev (Hz)	Deviation	
					(ppm)	(%)
100%	12.0	+25(Ref)	781,999,989	-12	-0.0147	-0.00000147
100%		-30	781,999,994	-6	-0.0082	-0.00000082
100%		-20	782,000,009	9	0.0118	0.00000118
100%		-10	781,999,989	-11	-0.0145	-0.00000145
100%		0	781,999,990	-10	-0.0130	-0.00000130
100%		10	782,000,014	14	0.0173	0.00000173
100%		20	782,000,008	8	0.0107	0.00000107
100%		30	781,999,992	-8	-0.0100	-0.00000100
100%		40	781,999,991	-10	-0.0121	-0.00000121
100%		50	781,999,975	-25	-0.0324	-0.00000324
85%		10.2	25	781,999,978	-22	-0.0283
115%	13.8	25	781,999,985	-15	-0.0196	-0.00000196
BATT.ENDPOINT	N/A	-	-	-	-	-

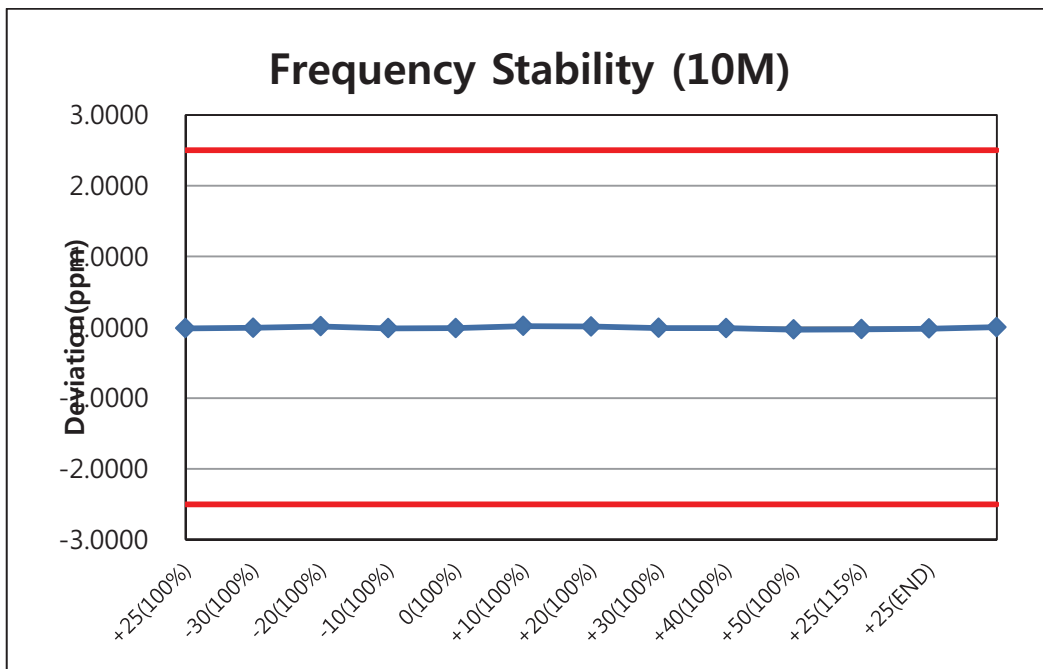

7.9.2 LTE Band 4

OPERATING FREQUENCY : 1,732,500,000 Hz
 CHANNEL : 20175
 REFERENCE VOLTAGE : 12 VDC
 DEVIATION LIMIT : ± 0.00025 % or 2.5 ppm

VOLTAGE (%)	POWER (V DC)	TEMP (°C)	FREQUENCY (Hz)	FREQ.Dev (Hz)	Deviation	
					(ppm)	(%)
100%	12.0	+25(Ref)	1,732,499,994	-6	-0.0035	-0.00000035
100%		-30	1,732,499,996	-4	-0.0023	-0.00000023
100%		-20	1,732,500,005	5	0.0030	0.00000030
100%		-10	1,732,499,978	-22	-0.0127	-0.00000127
100%		0	1,732,499,980	-20	-0.0118	-0.00000118
100%		10	1,732,499,993	-7	-0.0042	-0.00000042
100%		20	1,732,500,016	16	0.0094	0.00000094
100%		30	1,732,500,024	24	0.0139	0.00000139
100%		40	1,732,499,996	-4	-0.0024	-0.00000024
100%		50	1,732,499,987	-14	-0.0078	-0.00000078
85%		10.2	25	1,732,499,989	-11	-0.0063
115%	13.8	25	1,732,499,995	-5	-0.0031	-0.00000031
BATT.ENDPOINT	N/A	-	-	-	-	-

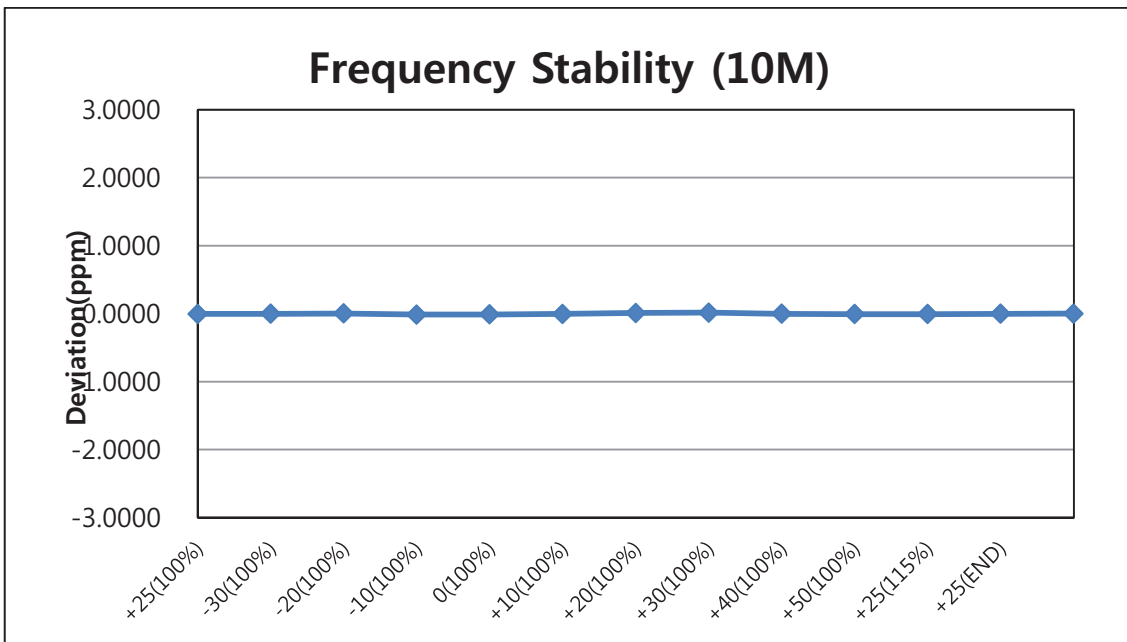

8. TEST PLOTS

Note: All bandwidths, RB configurations, and modulations were investigated. The worst case test results are reported below.

8.1 OCCUPIED BANDWIDTH

8.1.1 LTE Band 13

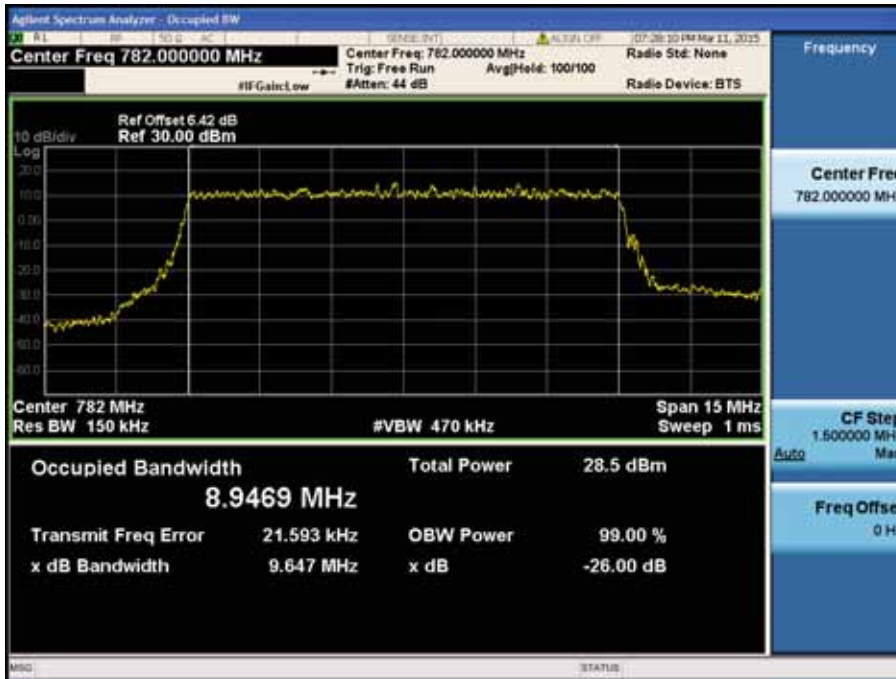

LTE Band 13 / 10MHz / QPSK - RB Size 50



LTE Band 13 / 10MHz / 16QAM - RB Size 50



LTE Band 13 / 5MHz / QPSK - RB Size 25



LTE Band 13 / 5MHz / 16QAM - RB Size 25

8.1.2 LTE Band 4

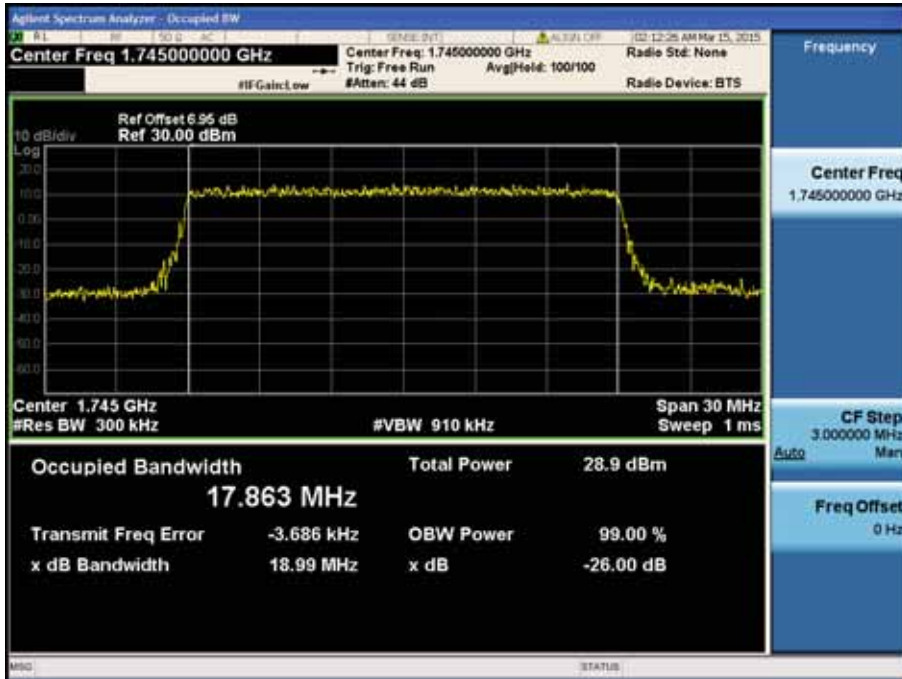

LTE Band 4 / 20MHz / QPSK - RB Size 100



LTE Band 4 / 20MHz / 16QAM - RB Size 100



LTE Band 4 / 15MHz / QPSK - RB Size 75

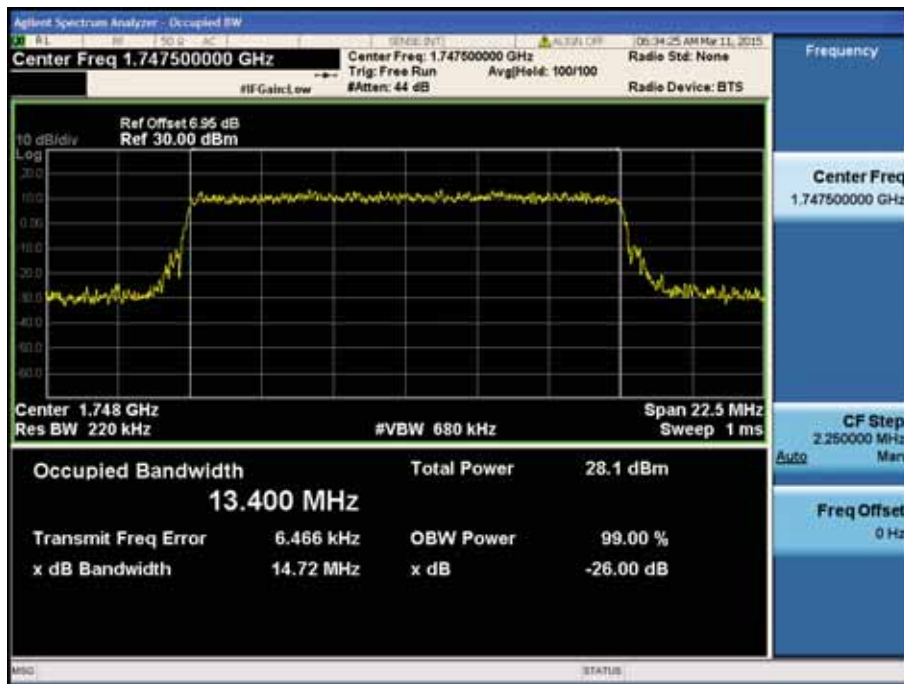

LTE Band 4 / 15MHz / 16QAM - RB Size 75



LTE Band 4 / 10MHz / QPSK - RB Size 50

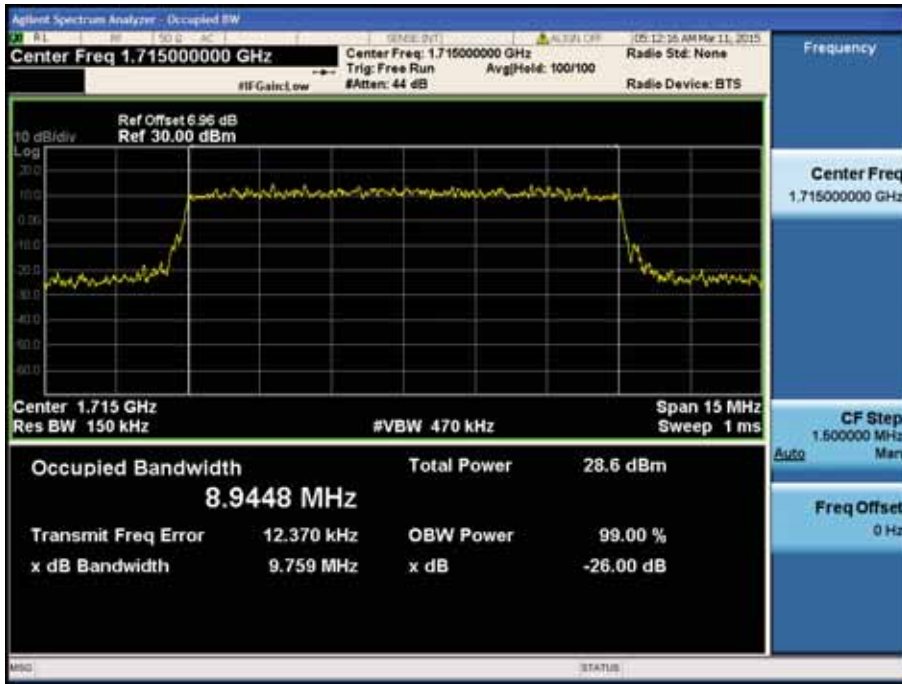

LTE Band 4 / 10MHz / 16QAM - RB Size 50



LTE Band 4 / 5MHz / QPSK - RB Size 25



LTE Band 4 / 5MHz / 16QAM - RB Size 25

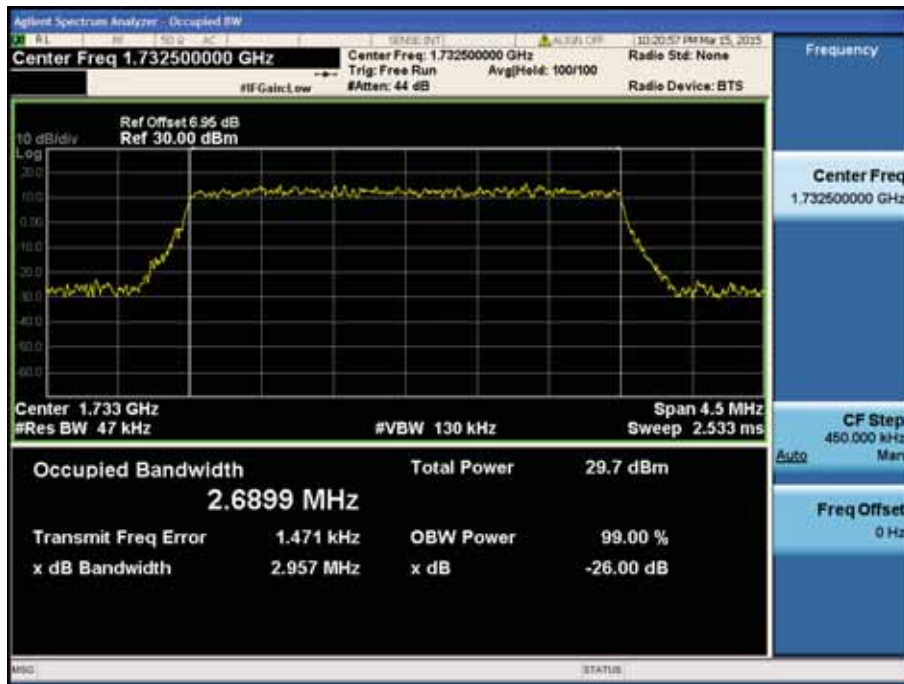

LTE Band 4 / 3MHz / QPSK - RB Size 15



LTE Band 4 / 3MHz / 16QAM - RB Size 15



LTE Band 4 / 1.4MHz / QPSK - RB Size 6



LTE Band 4 / 1.4MHz / 16QAM - RB Size 6

8.2 PEAK TO AVERAGE RATIO

8.2.1 LTE Band 13

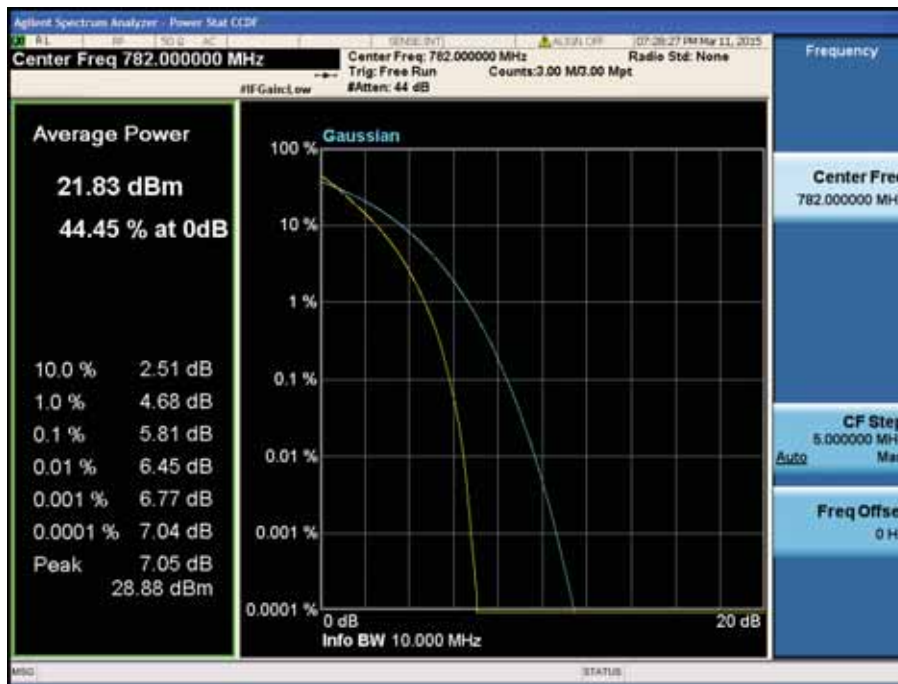

LTE Band 13 / 10MHz / QPSK - RB Size 50

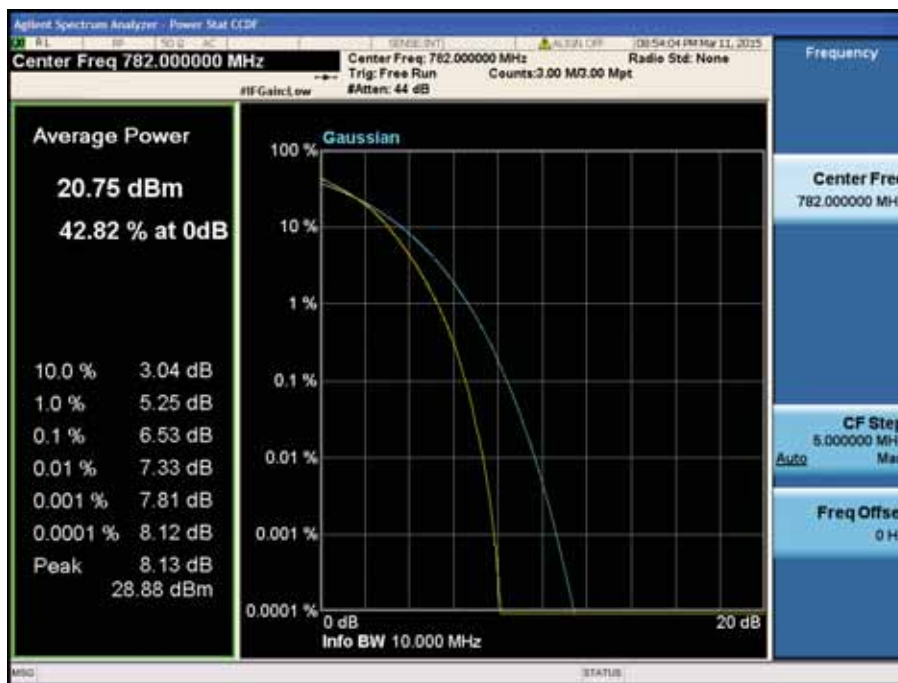

LTE Band 13 / 10MHz / 16QAM - RB Size 50



LTE Band 13 / 5MHz / QPSK - RB Size 25



LTE Band 13 / 5MHz / 16QAM - RB Size 25

8.2.2 LTE Band 4

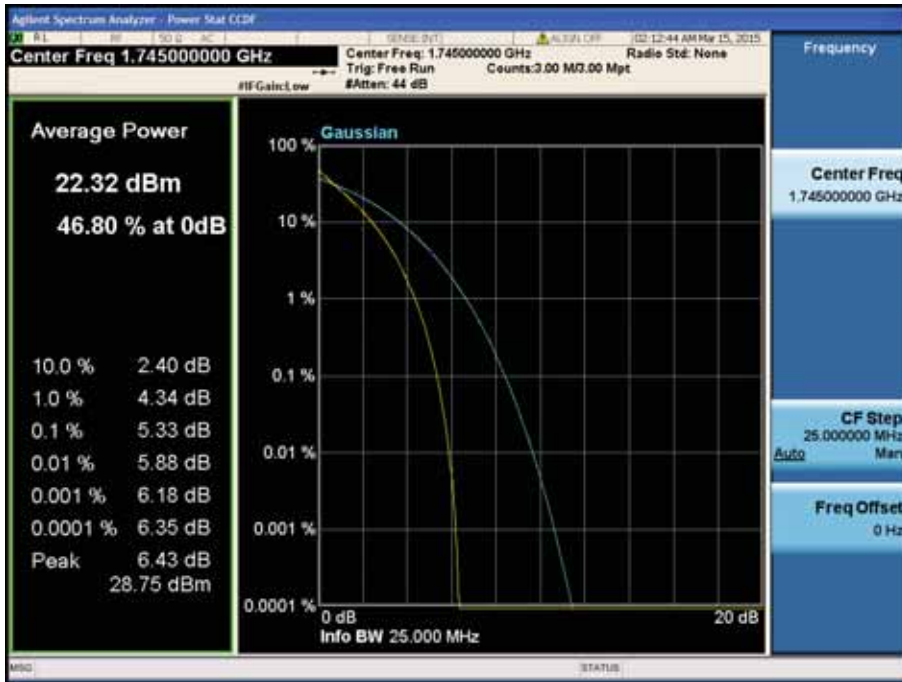

LTE Band 4 / 20MHz / QPSK - RB Size 100

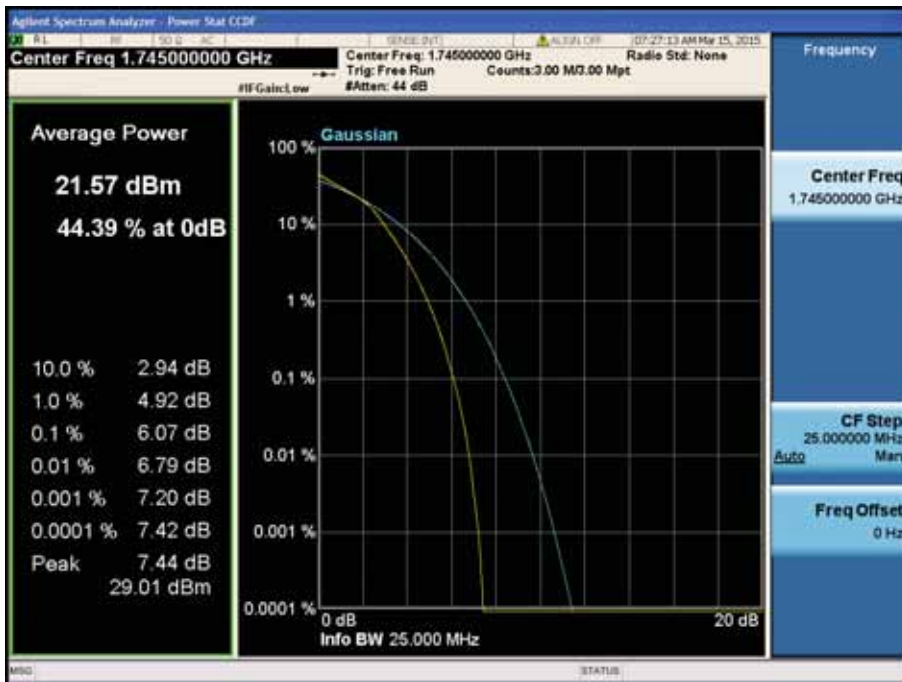

LTE Band 4 / 20MHz / 16QAM - RB Size 100

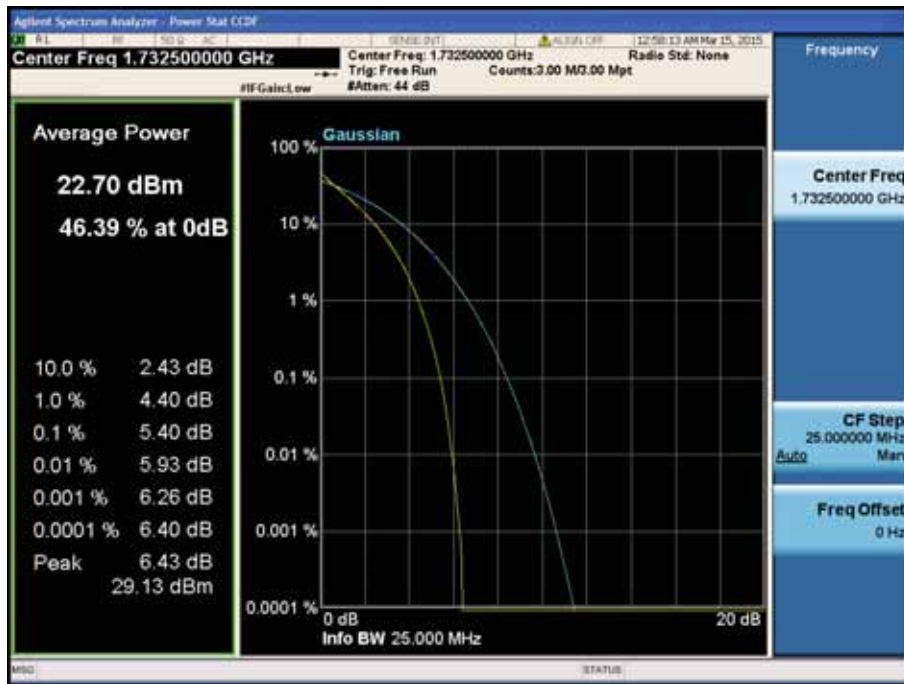

LTE Band 4 / 15MHz / QPSK - RB Size 75



LTE Band 4 / 15MHz / 16QAM - RB Size 75

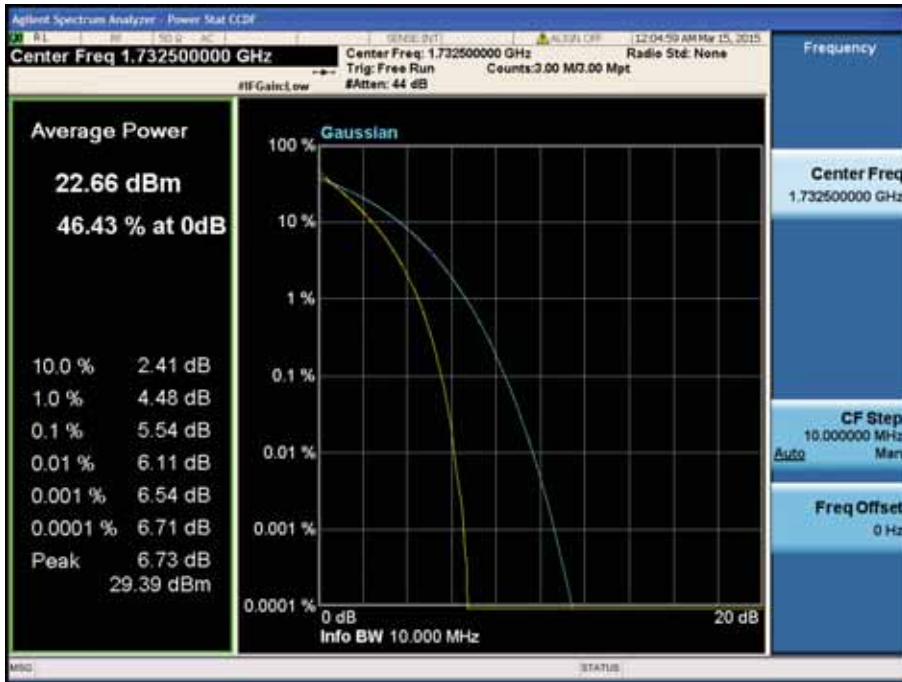

LTE Band 4 / 10MHz / QPSK - RB Size 50

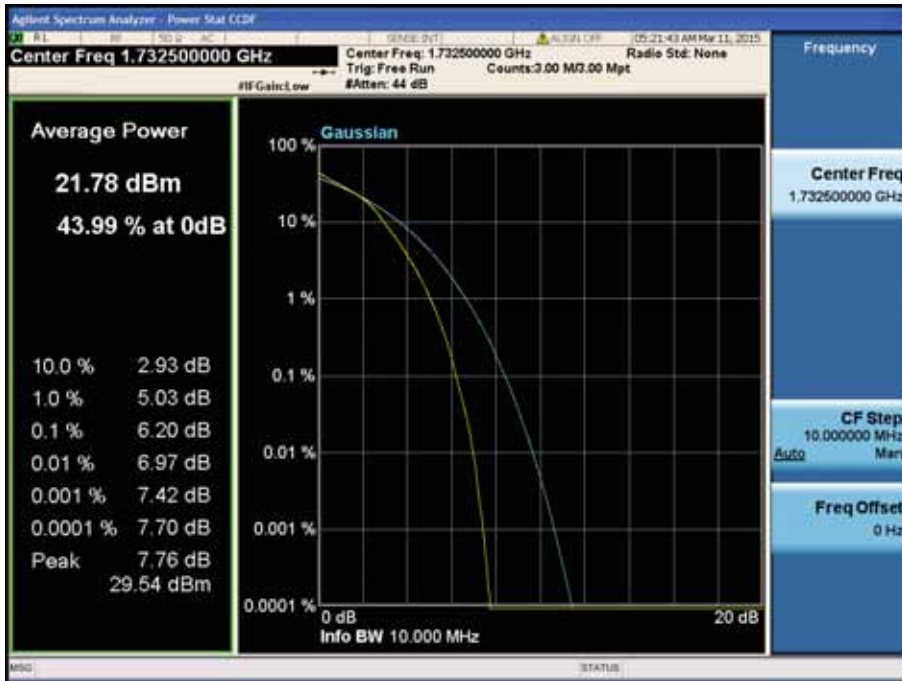

LTE Band 4 / 10MHz / 16QAM - RB Size 50

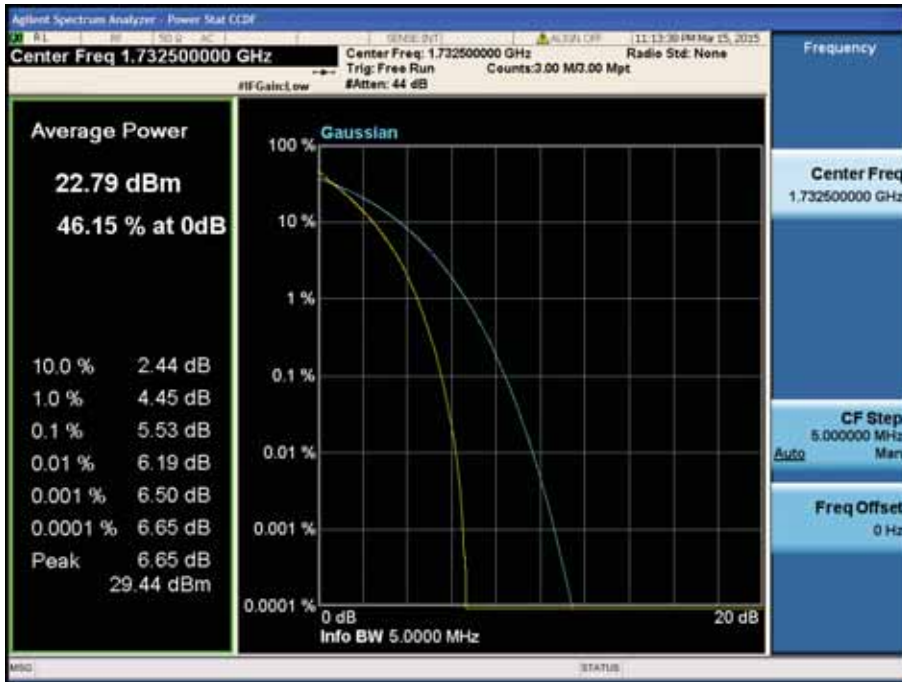

LTE Band 4 / 5MHz / QPSK - RB Size 25



LTE Band 4 / 5MHz / 16QAM - RB Size 25

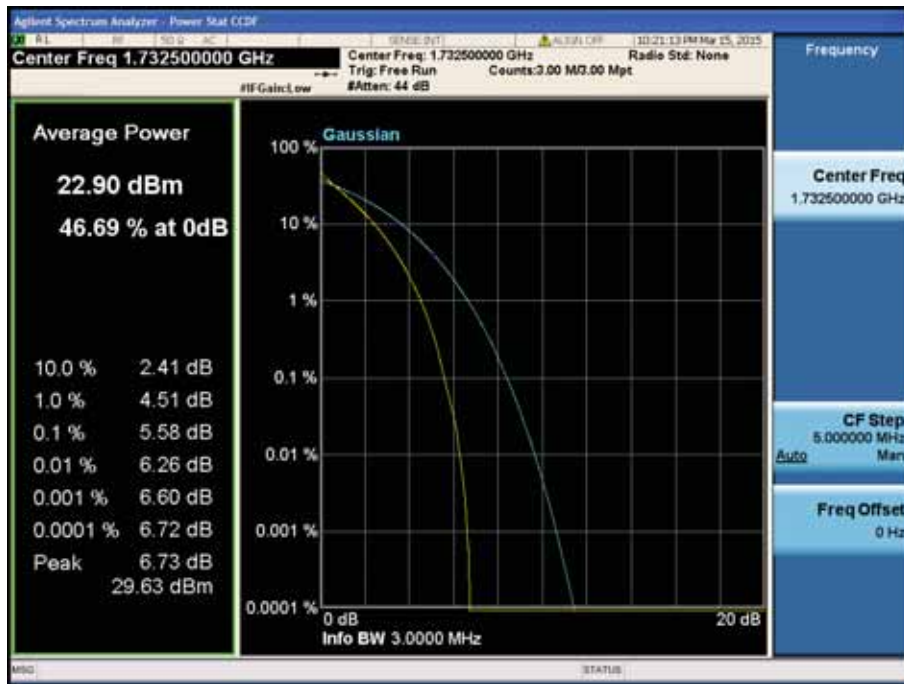

LTE Band 4 / 3MHz / QPSK - RB Size 15



LTE Band 4 / 3MHz / 16QAM - RB Size 15

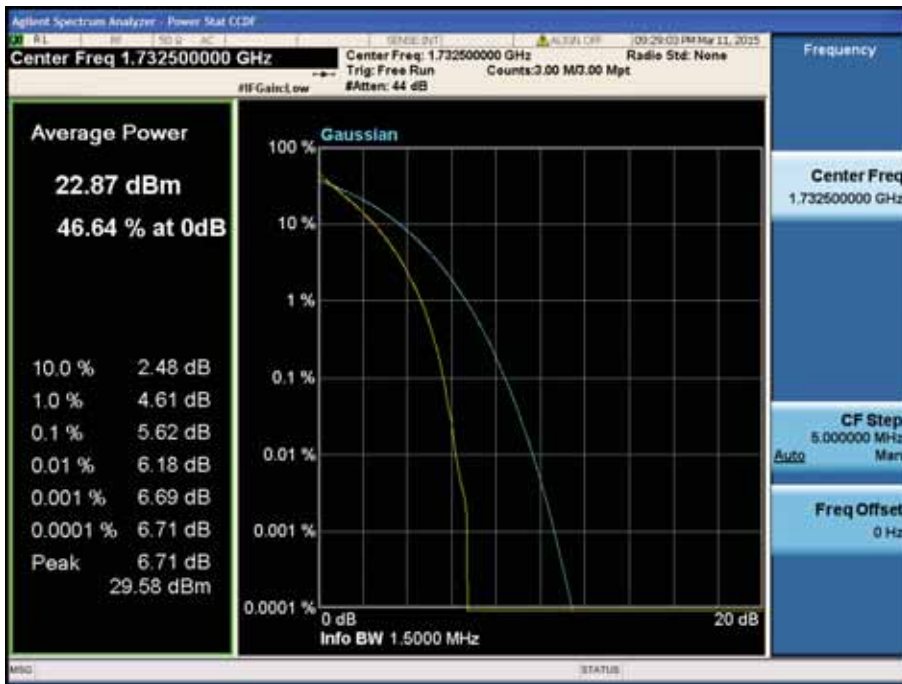

LTE Band 4 / 1.4MHz / QPSK - RB Size 6



LTE Band 4 / 1.4MHz / 16QAM - RB Size 6

8.3 BAND EDEG EMISSIONS(Conducted)

Note: All bandwidths, RB configurations, and modulations were investigated. The worst case test results are reported below.

8.3.1 LTE Band 13

- Lower Band Edge

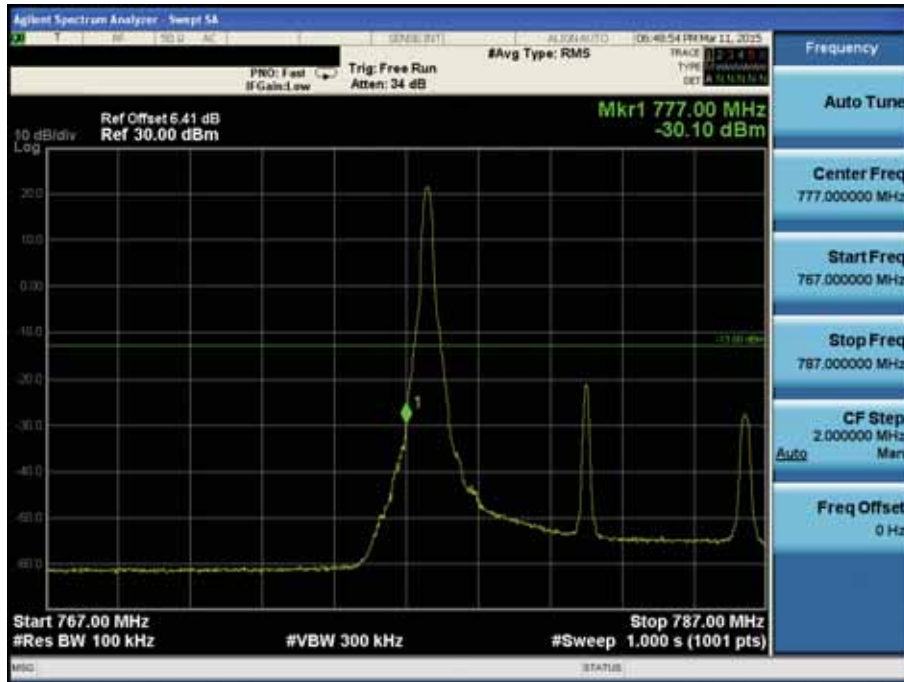

LTE Band 13 / 10MHz / QPSK - RB Size/Offset (1/0)

- Lower Extended Band Edge



LTE Band 13 / 10MHz / QPSK - RB Size/Offset (25/0)

- Lower (763 ~ 775 MHz)



LTE Band 13 / 10MHz / QPSK - RB Size/Offset (25/0)

- Upper Band Edge

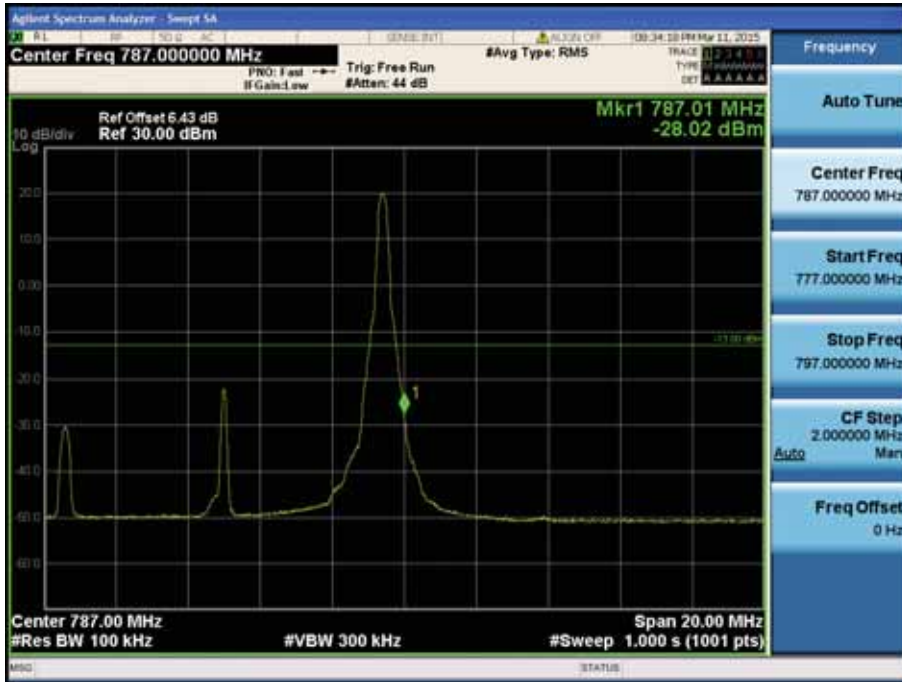

LTE Band 13 / 10MHz / 16QAM - RB Size/Offset (1/49)

- Upper Extended Band Edge

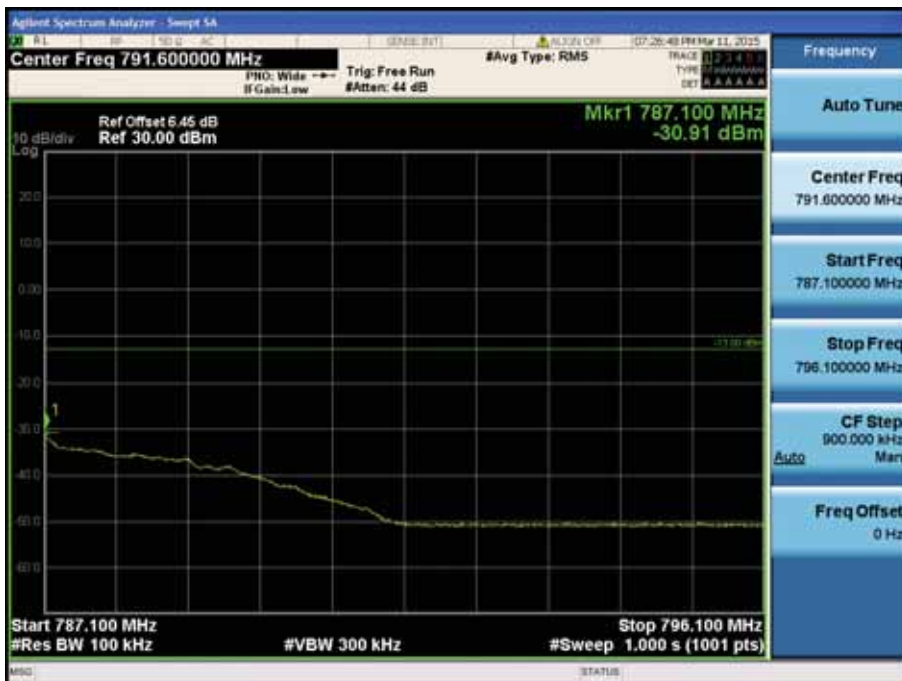

LTE Band 13 / 10MHz / QPSK - RB Size/Offset (25/25)

- Upper (793 ~ 805 MHz)



LTE Band 13 / 10MHz / QPSK - RB Size/Offset (50/0)

- Lower Band Edge

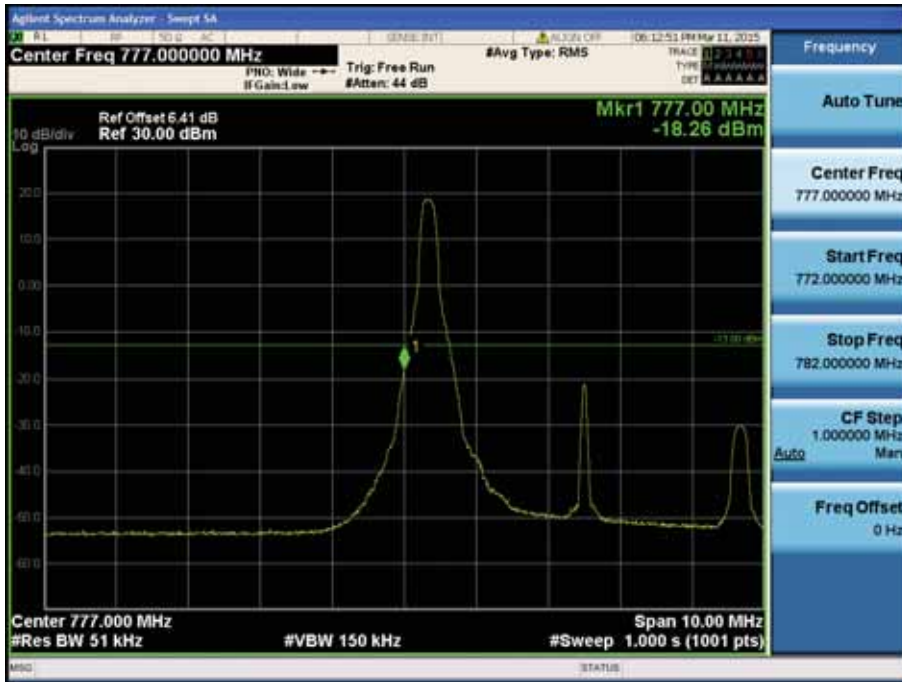

LTE Band 13 / 5MHz / QPSK - RB Size/Offset (1/0)

- Lower Extended Band Edge

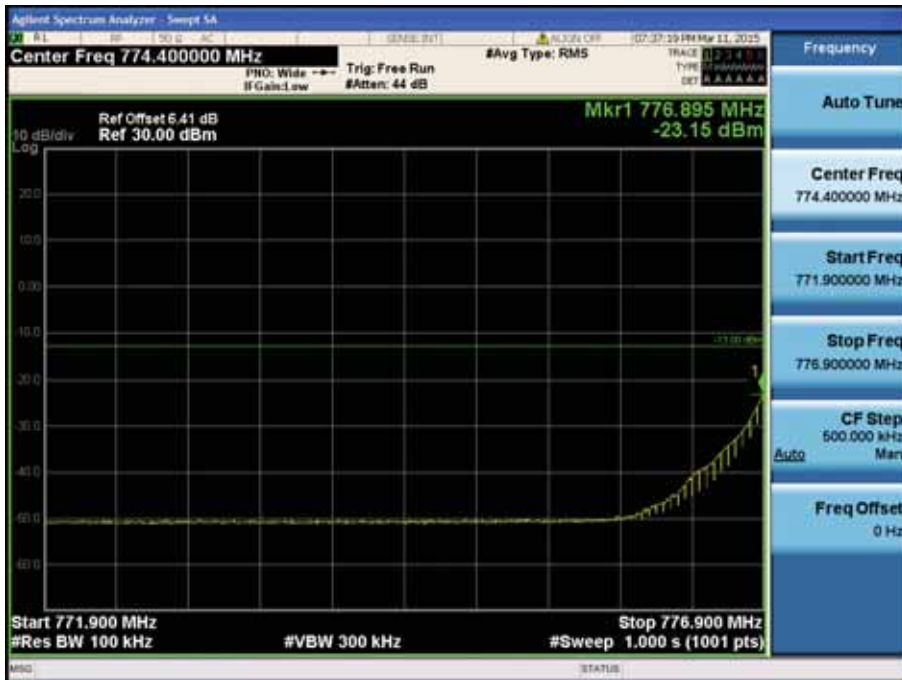

LTE Band 13 / 5MHz / 16QAM - RB Size/Offset (1/0)

- Lower (763 ~ 775 MHz)



LTE Band 13 / 5MHz / QPSK - RB Size/Offset (25/0)

- Upper Band Edge

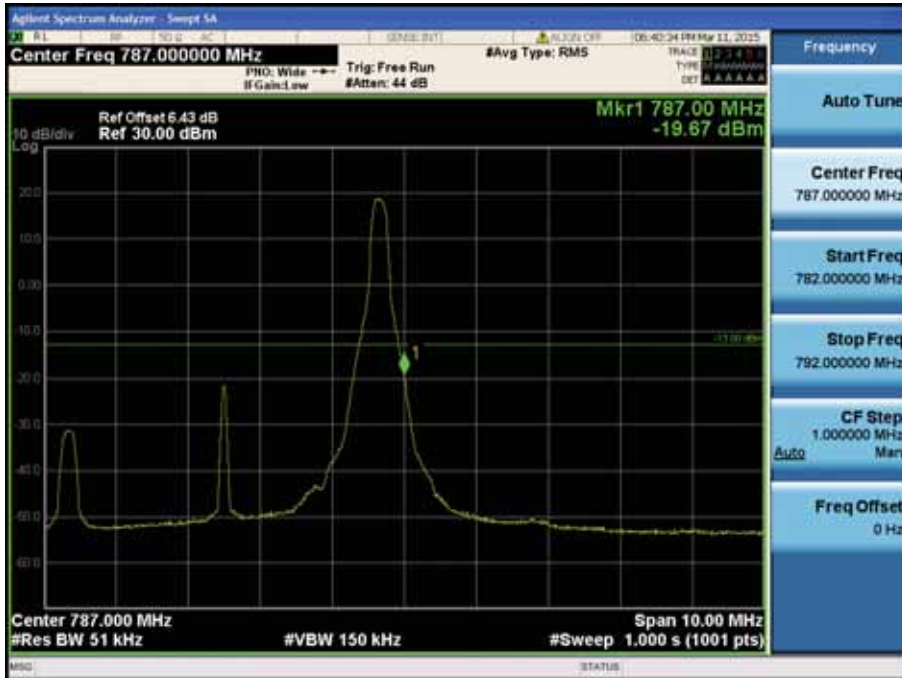

LTE Band 13 / 5MHz / QPSK - RB Size/Offset (1/24)

- Upper Extended Band Edge



LTE Band 13 / 5MHz / 16QAM - RB Size/Offset (1/24)

- Upper (793 ~ 805 MHz)



LTE Band 13 / 5MHz / 16QAM - RB Size/Offset (12/6)

8.3.2 LTE Band 4

- Lower Band Edge

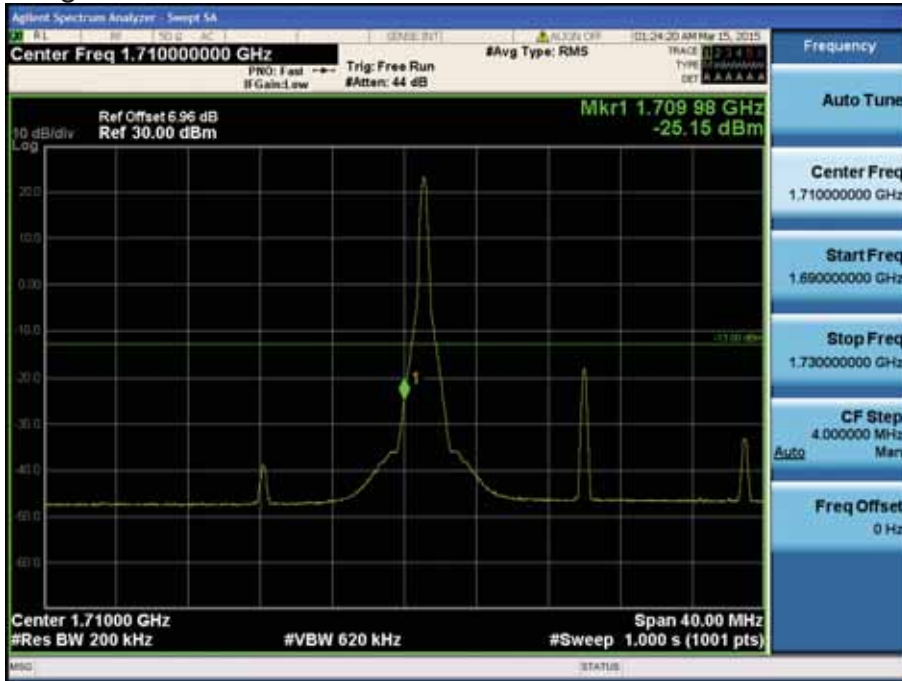

LTE Band 4 / 20MHz / QPSK - RB Size/Offset (1/0)

- Lower Extended Band Edge



LTE Band 4 / 20MHz / QPSK - RB Size/Offset (50/0)

- Upper Band Edge

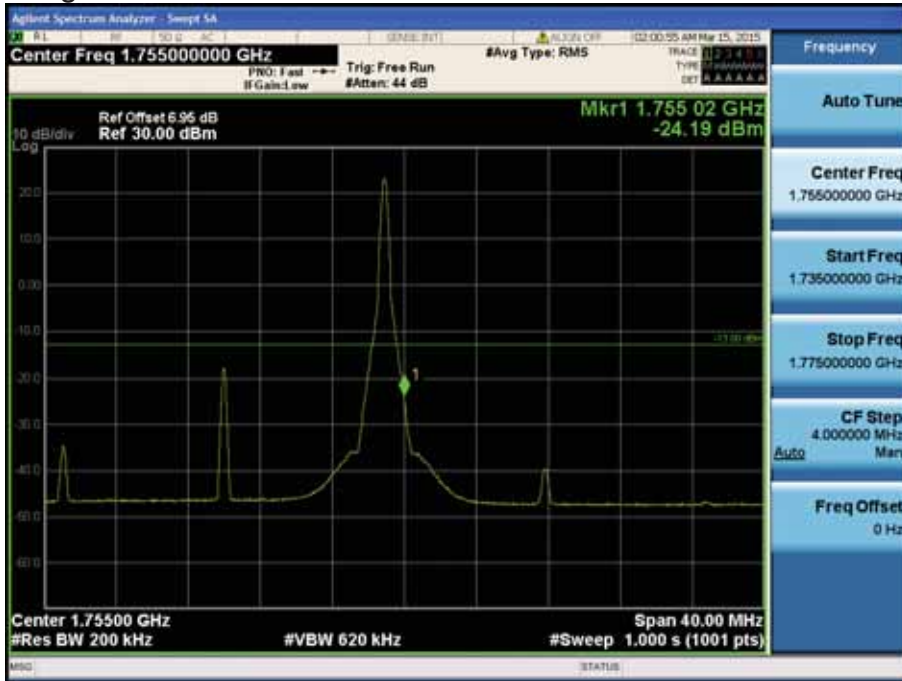

LTE Band 4 / 20MHz / QPSK - RB Size/Offset (1/99)

- Upper Extended Band Edge



LTE Band 4 / 20MHz / QPSK - RB Size/Offset (50/50)

- Lower Band Edge

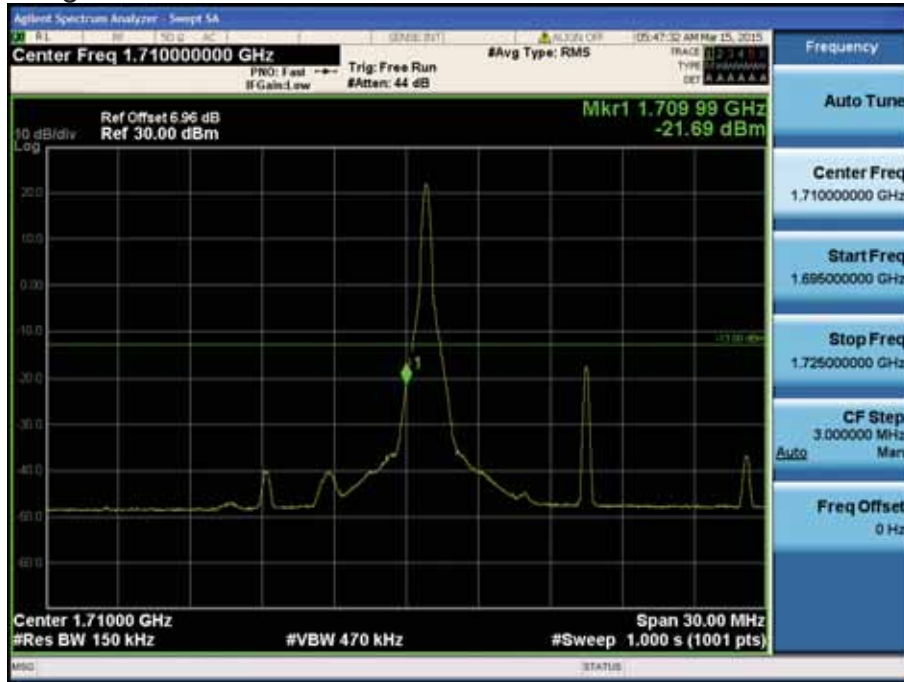

LTE Band 4 / 15MHz / 16QAM - RB Size/Offset (1/0)

- Lower Extended Band Edge



LTE Band 4 / 15MHz / QPSK - RB Size/Offset (36/0)

- Upper Band Edge

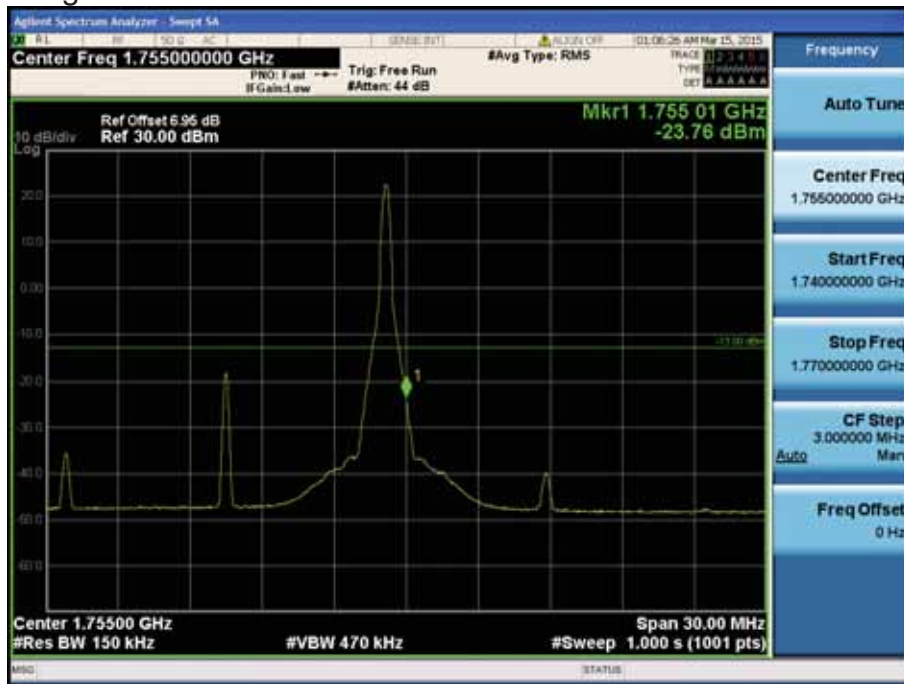

LTE Band 4 / 15MHz / QPSK - RB Size/Offset (1/74)

- Upper Extended Band Edge



LTE Band 4 / 15MHz / QPSK - RB Size/Offset (36/39)

- Lower Band Edge



LTE Band 4 / 10MHz / QPSK - RB Size/Offset (25/0)

- Lower Extended Band Edge



LTE Band 4 / 10MHz / QPSK - RB Size/Offset (25/0)

- Upper Band Edge



LTE Band 4 / 10MHz / QPSK - RB Size/Offset (25/25)

- Upper Extended Band Edge



LTE Band 4 / 10MHz / QPSK - RB Size/Offset (25/25)

- Lower Band Edge

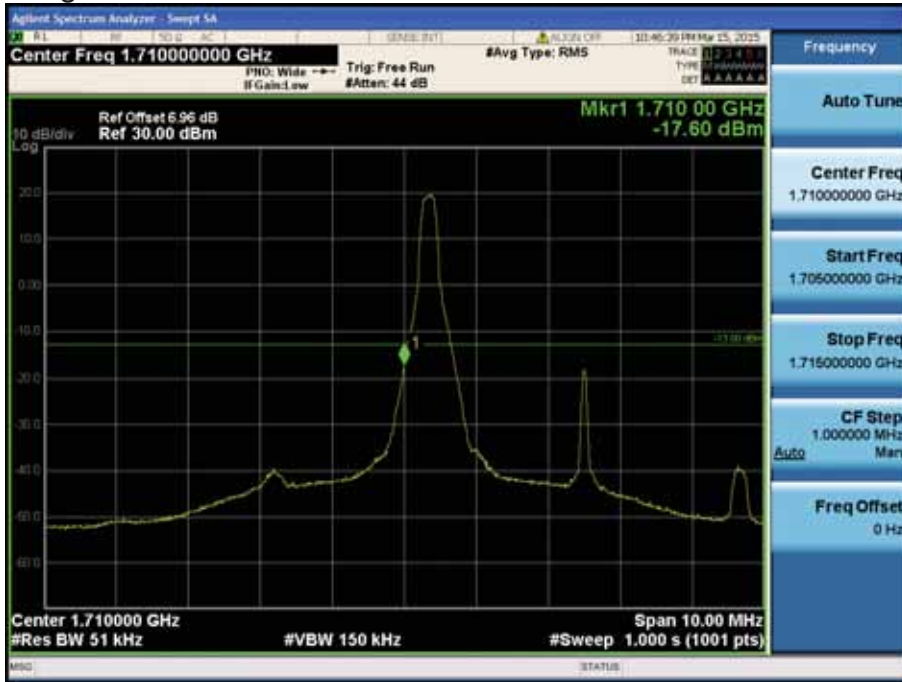

LTE Band 4 / 5MHz / QPSK - RB Size/Offset (1/0)

- Lower Extended Band Edge



LTE Band 4 / 5MHz / QPSK - RB Size/Offset (25/0)

- Upper Band Edge

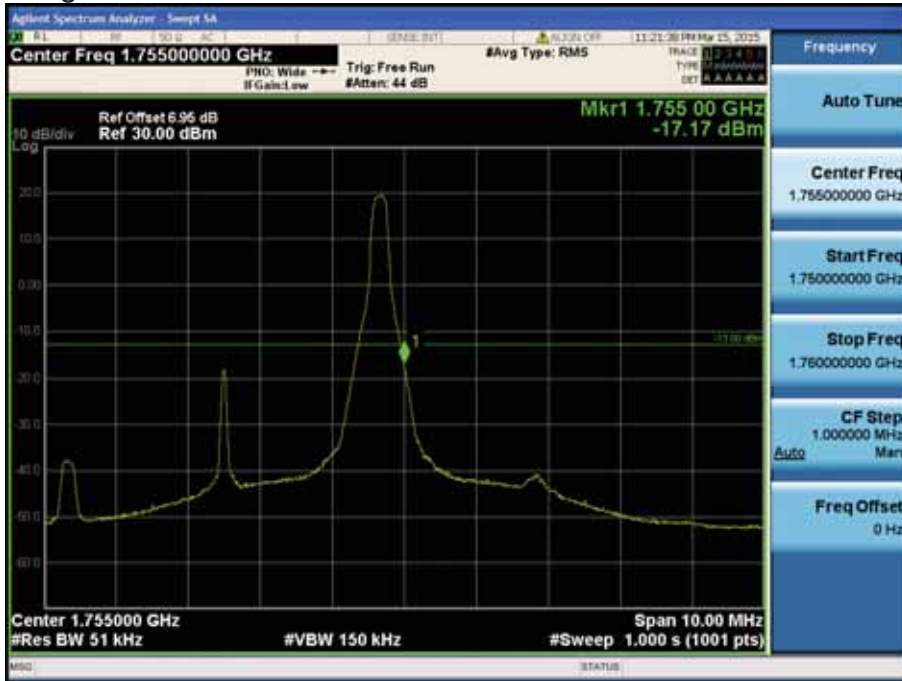

LTE Band 4 / 5MHz / QPSK - RB Size/Offset (1/24)

- Upper Extended Band Edge

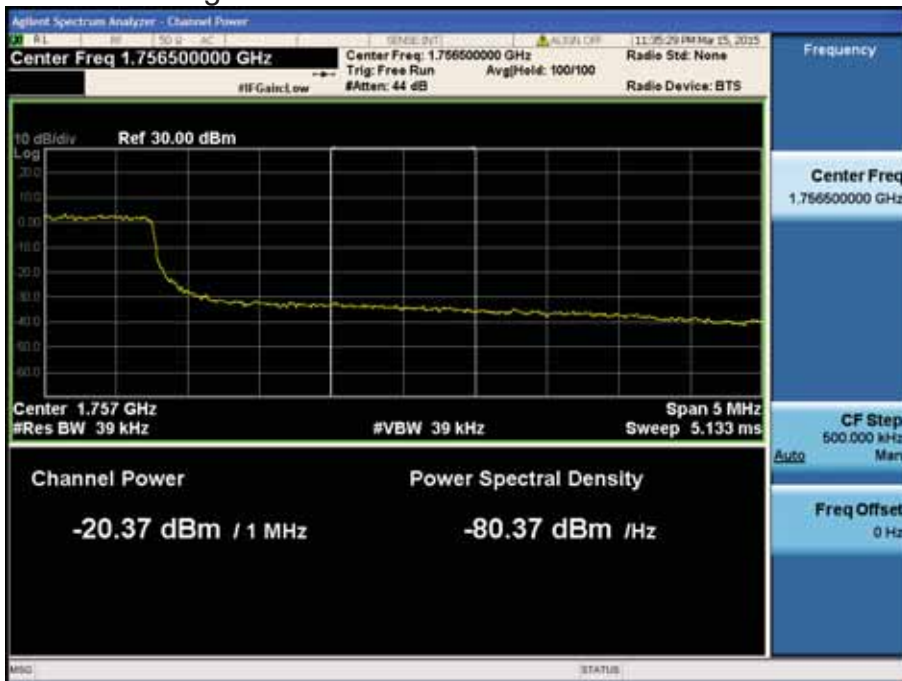

LTE Band 4 / 5MHz / QPSK - RB Size/Offset (25/0)

- Lower Band Edge

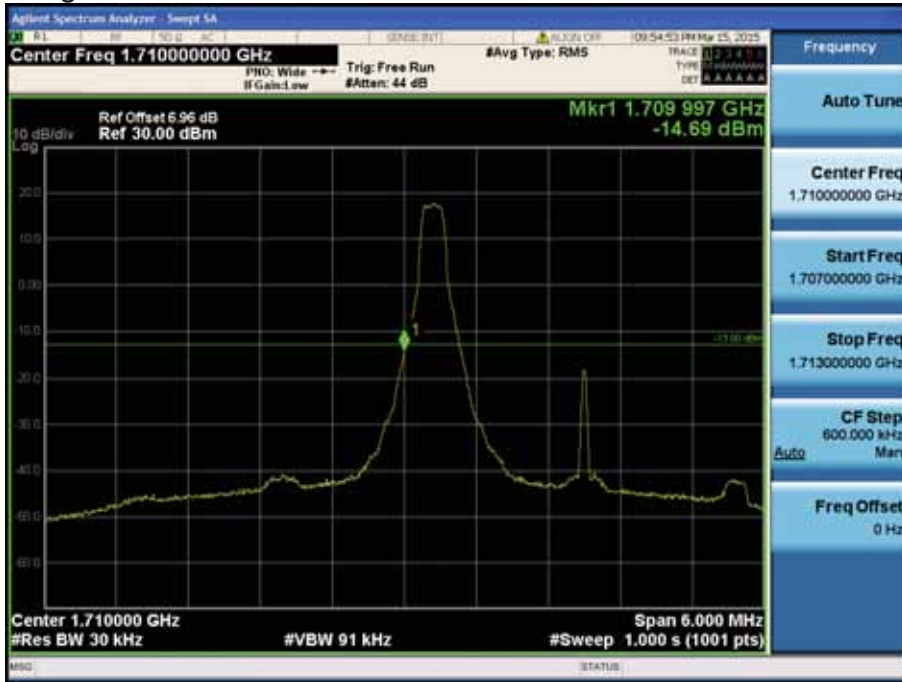

LTE Band 4 / 3MHz / QPSK - RB Size/Offset (1/0)

- Lower Extended Band Edge



LTE Band 4 / 3MHz / QPSK - RB Size/Offset (15/0)

- Upper Band Edge

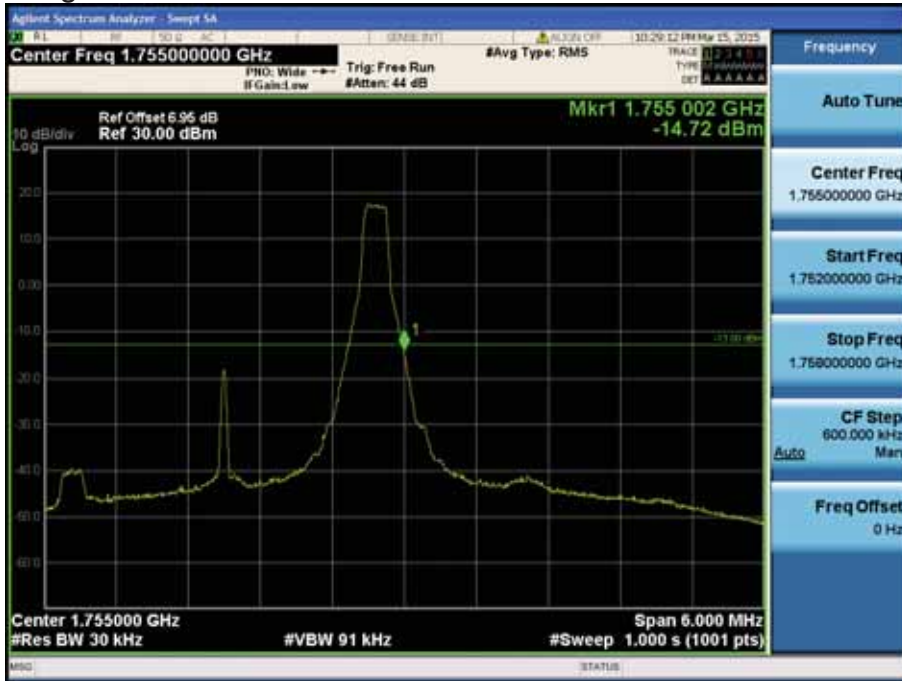

LTE Band 4 / 3MHz / QPSK - RB Size/Offset (1/14)

- Upper Extended Band Edge



LTE Band 4 / 3MHz / QPSK - RB Size/Offset (15/0)

- Lower Band Edge



LTE Band 4 / 1.4MHz / QPSK - RB Size/Offset (3/0)

- Lower Extended Band Edge



LTE Band 4 / 1.4MHz / 16QAM - RB Size/Offset (3/1)

- Upper Band Edge



LTE Band 4 / 1.4MHz / QPSK - RB Size/Offset (3/3)

- Upper Extended Band Edge



LTE Band 4 / 1.4MHz / QPSK - RB Size/Offset (3/0)

8.4 SPURIOUS AND HARMONICS EMISSIONS(Conducted)

Note: All bandwidths, RB configurations, and modulations were investigated. The worst case test results are reported below.

8.4.1 LTE Band 13

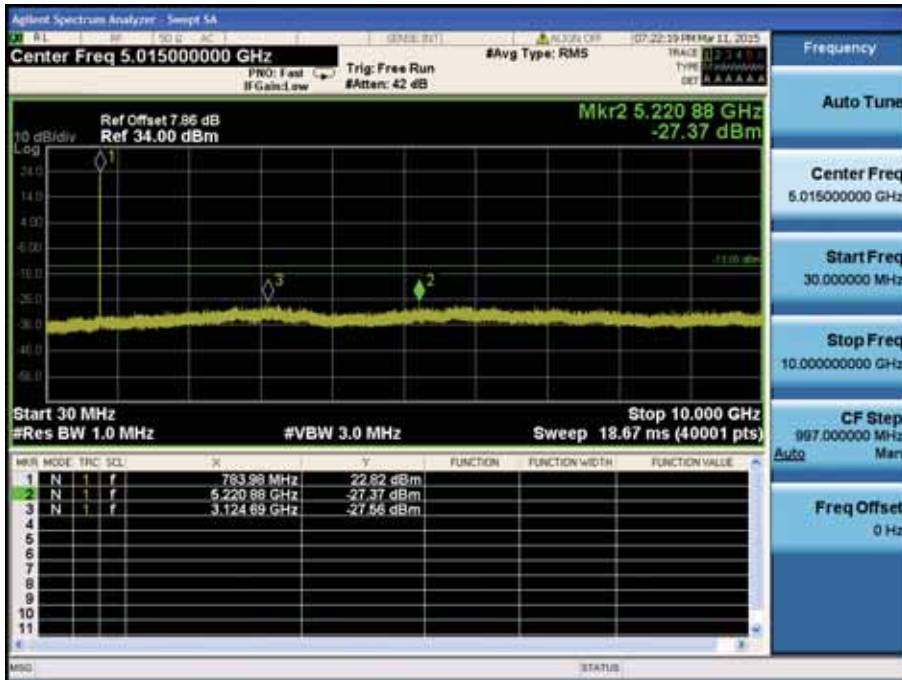

LTE Band 13 / 10MHz / QPSK - RB Size/Offset (25/12)

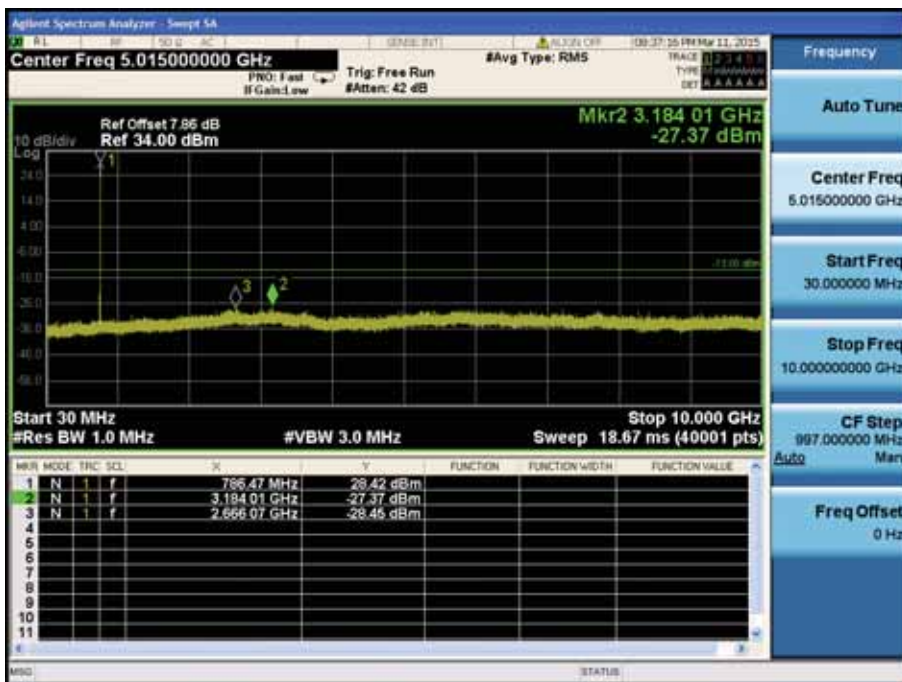

LTE Band 13 / 10MHz / 16QAM - RB Size/Offset (1/49)

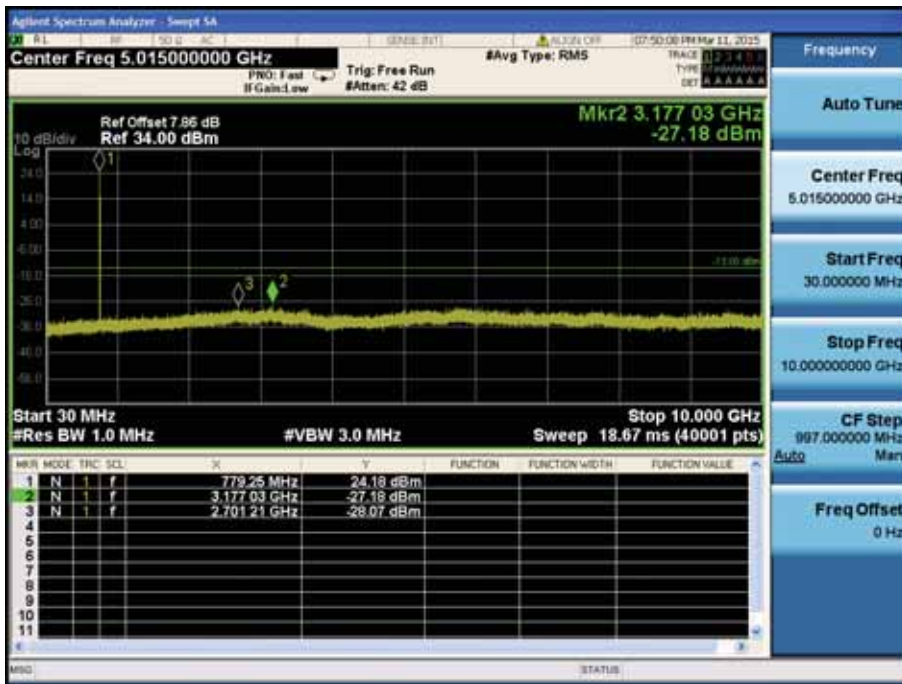

LTE Band 13 / 5MHz / 16QAM - RB Size/Offset (12/6) – Low Channel

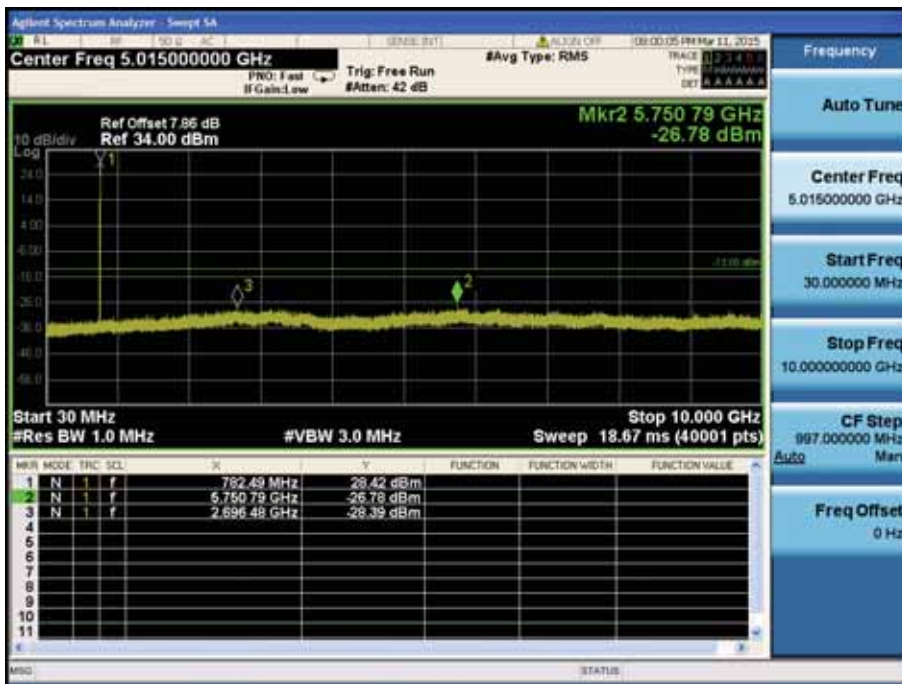

LTE Band 13 / 5MHz / 16QAM - RB Size/Offset (1/0) – High Channel

8.4.2 LTE Band 4

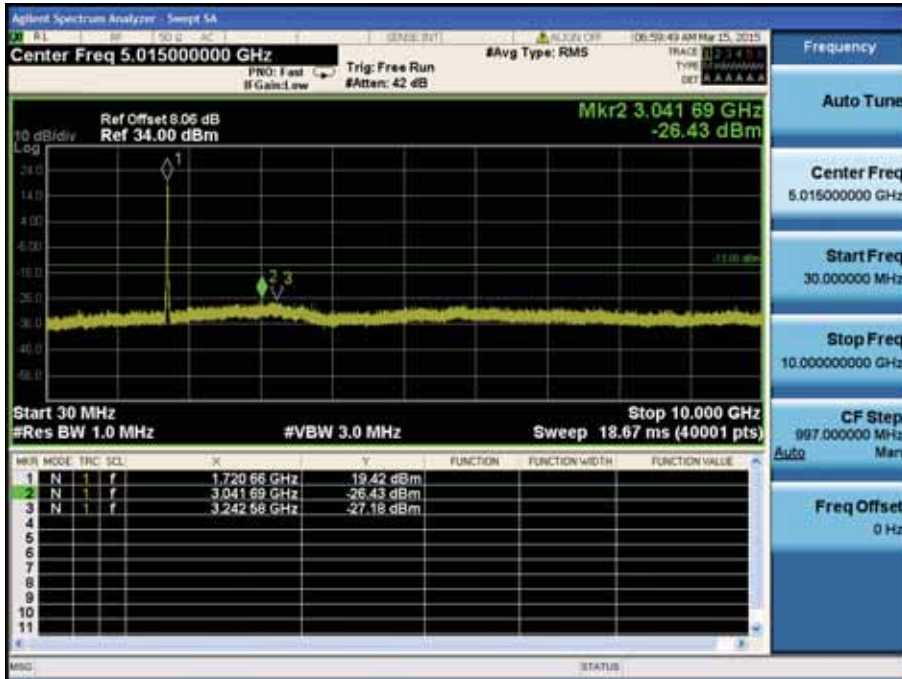

LTE Band 4 / 20MHz / 16QAM - RB Size/Offset (100/0) – Low Channel

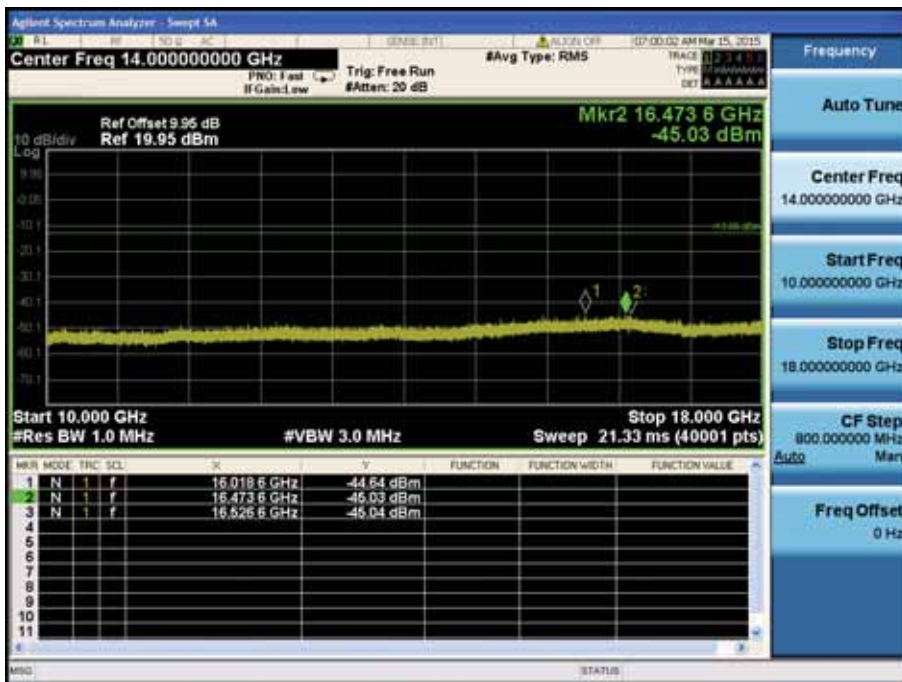

LTE Band 4 / 20MHz / 16QAM - RB Size/Offset (100/0) – Low Channel

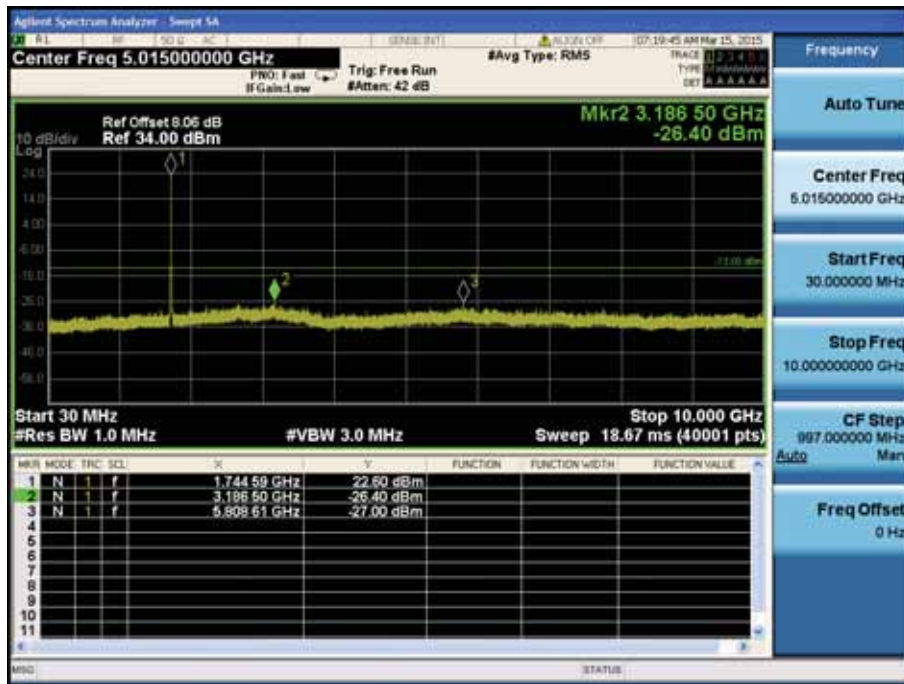

LTE Band 4 / 20MHz / 16QAM - RB Size/Offset (50/0) – High Channel

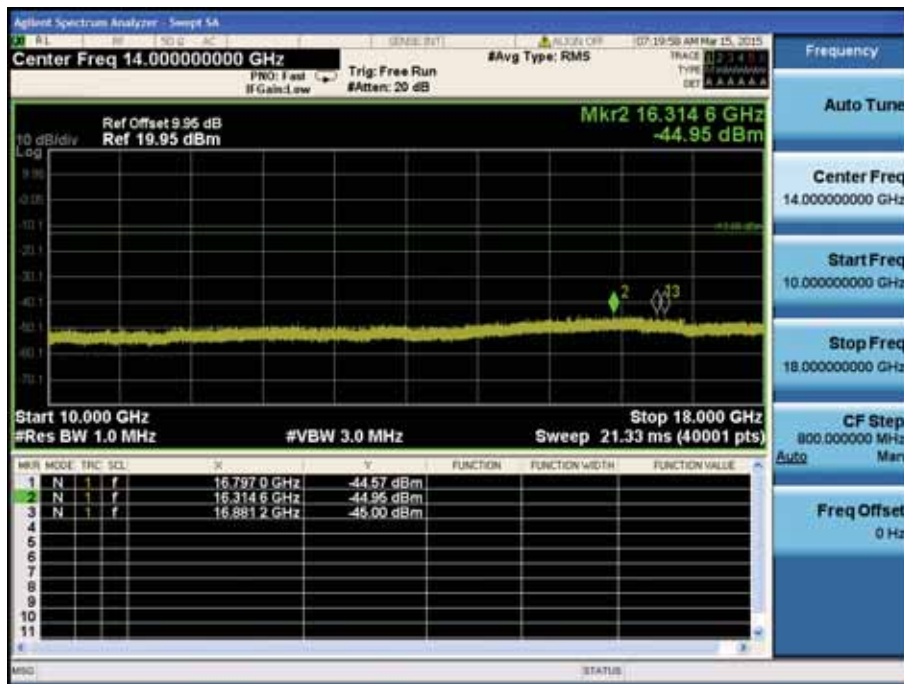

LTE Band 4 / 20MHz / 16QAM - RB Size/Offset (50/0) – High Channel

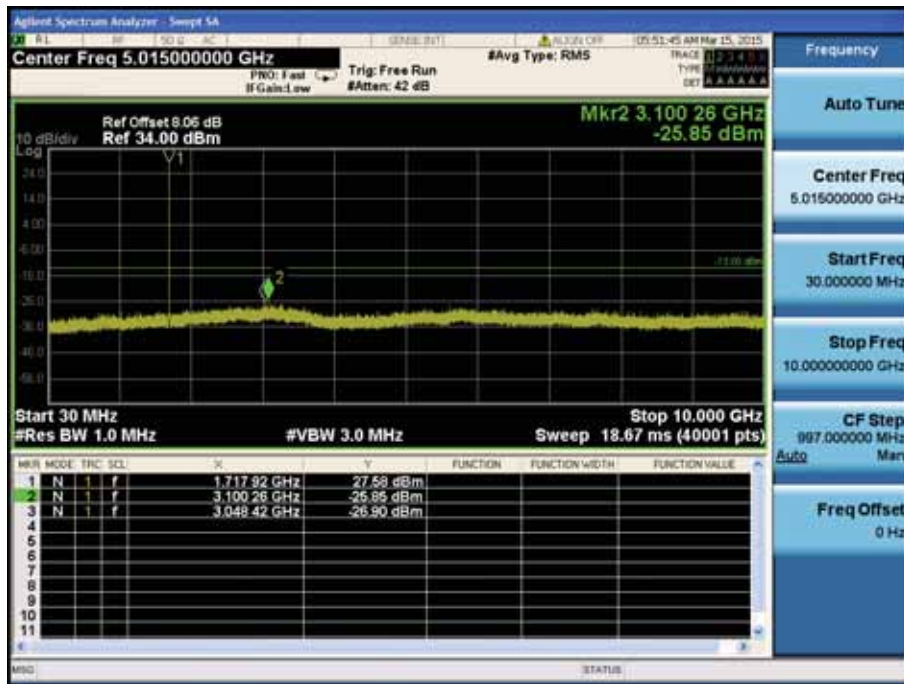

LTE Band 4 / 15MHz / 16QAM - RB Size/Offset (1/37) – Low Channel

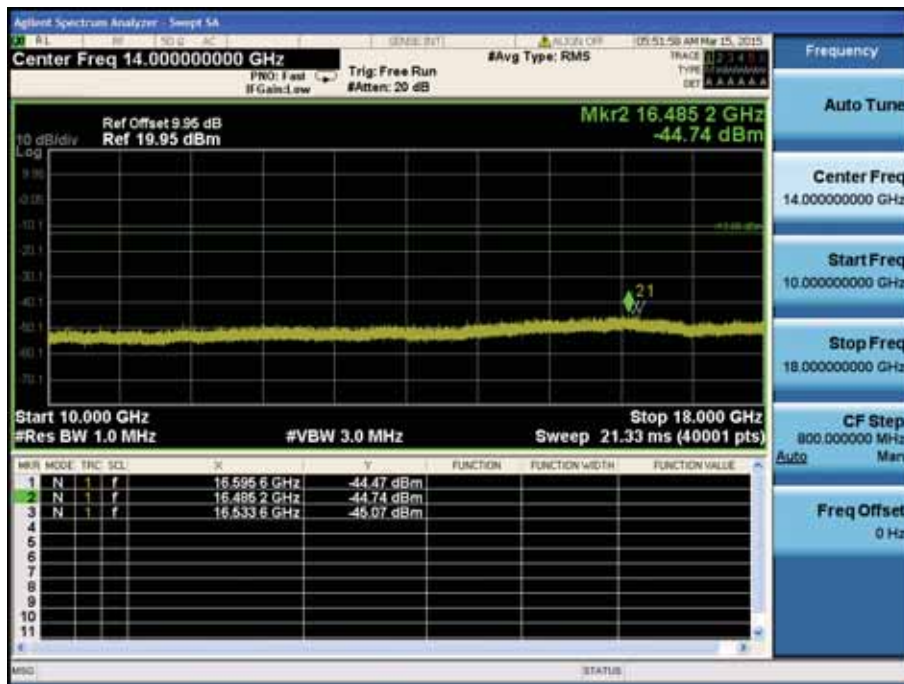

LTE Band 4 / 15MHz / 16QAM - RB Size/Offset (1/37) – Low Channel

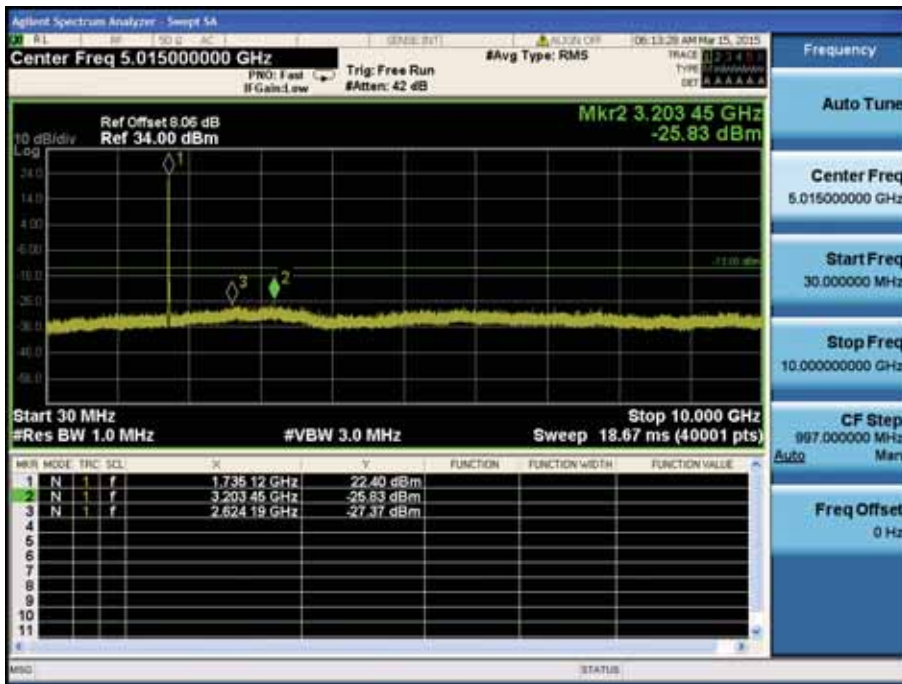

LTE Band 4 / 15MHz / 16QAM - RB Size/Offset (36/39) – Mid Channel

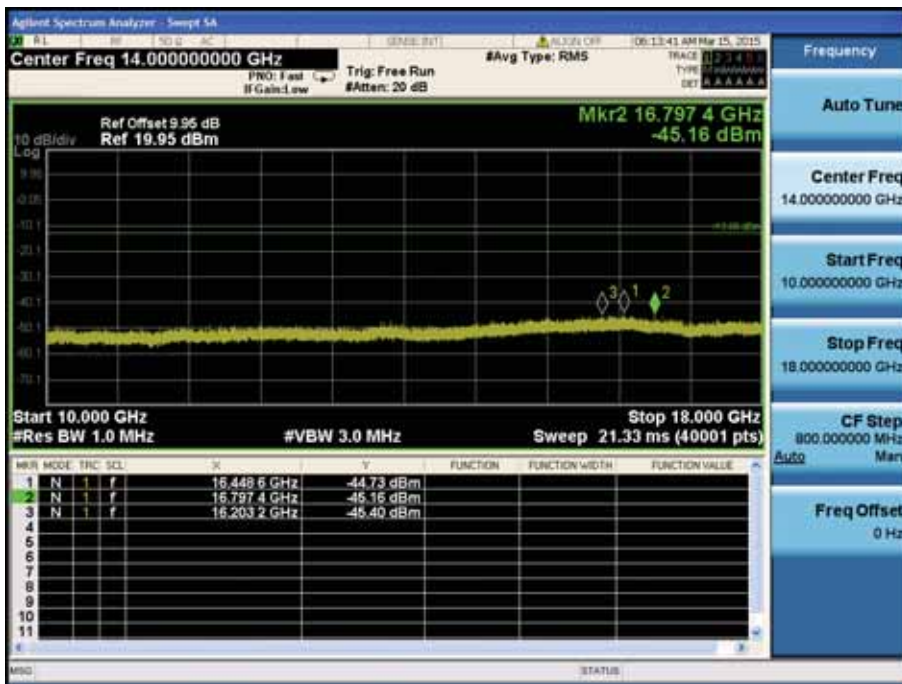

LTE Band 4 / 15MHz / 16QAM - RB Size/Offset (36/39) – Mid Channel

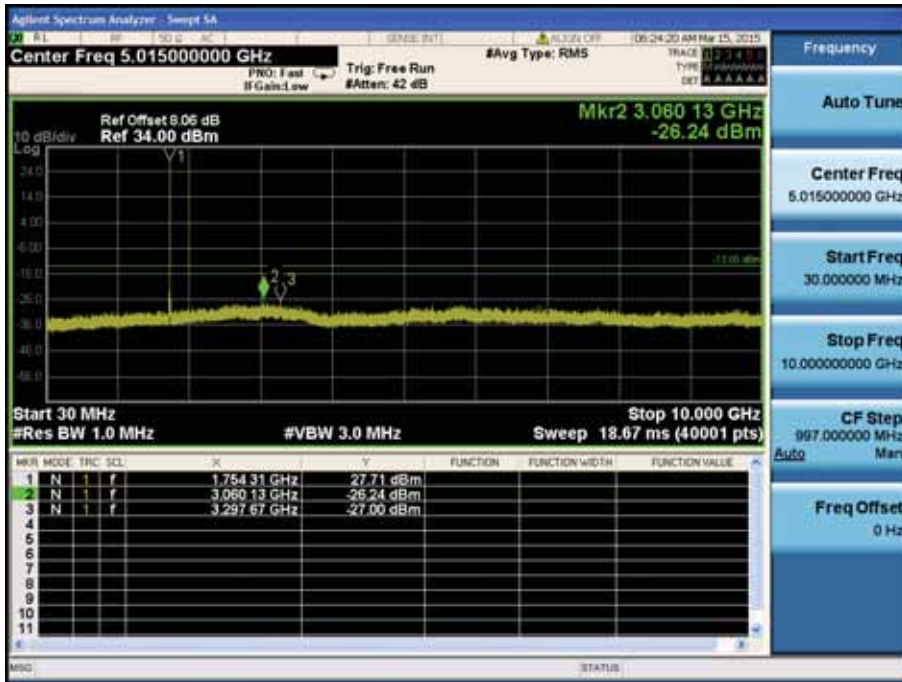

LTE Band 4 / 15MHz / 16QAM - RB Size/Offset (1/74) – High Channel

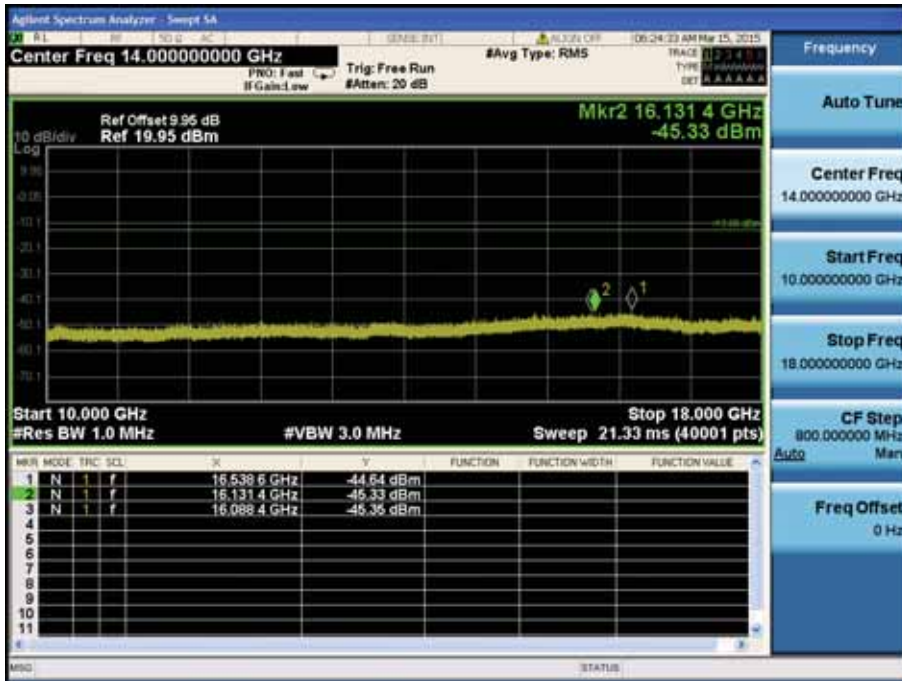

LTE Band 4 / 15MHz / 16QAM - RB Size/Offset (1/74) – High Channel

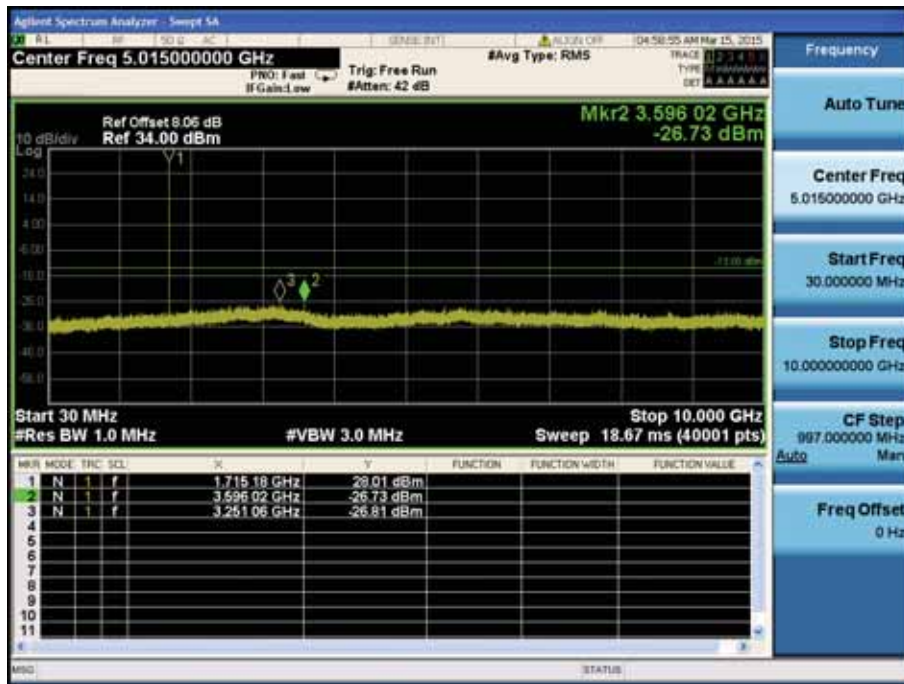

LTE Band 4 / 10MHz / 16QAM - RB Size/Offset (1/25) – Low Channel

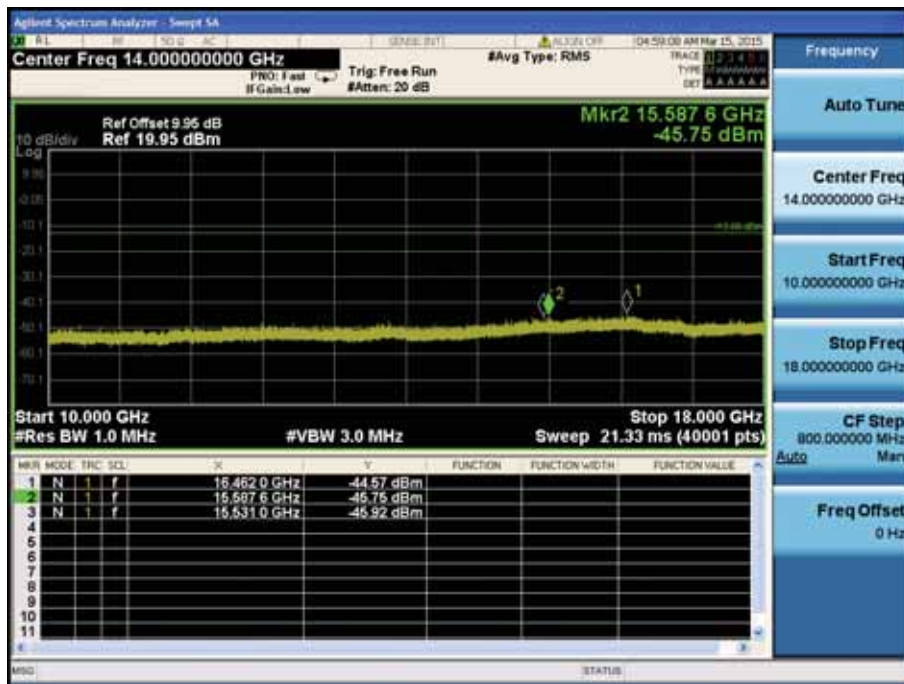

LTE Band 4 / 10MHz / 16QAM - RB Size/Offset (1/25) – Low Channel

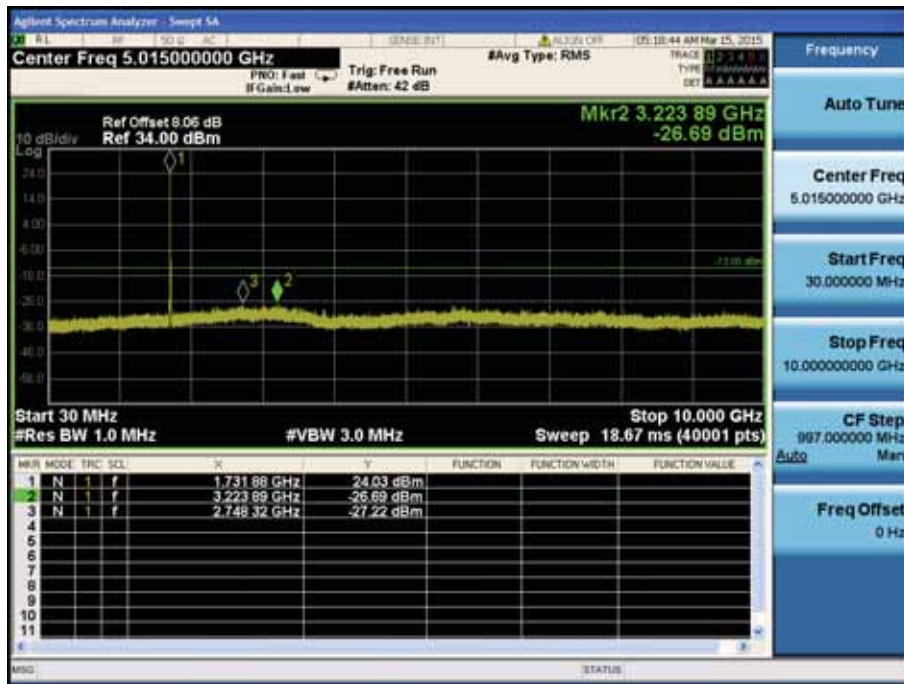

LTE Band 4 / 10MHz / 16QAM - RB Size/Offset (25/0) – Mid Channel

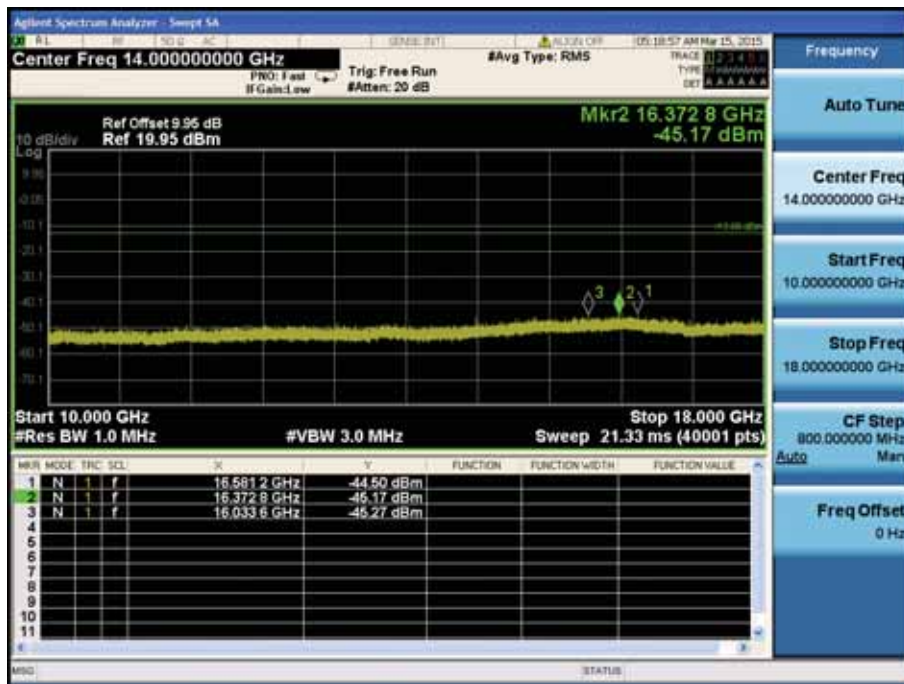

LTE Band 4 / 10MHz / 16QAM - RB Size/Offset (25/0) – Mid Channel

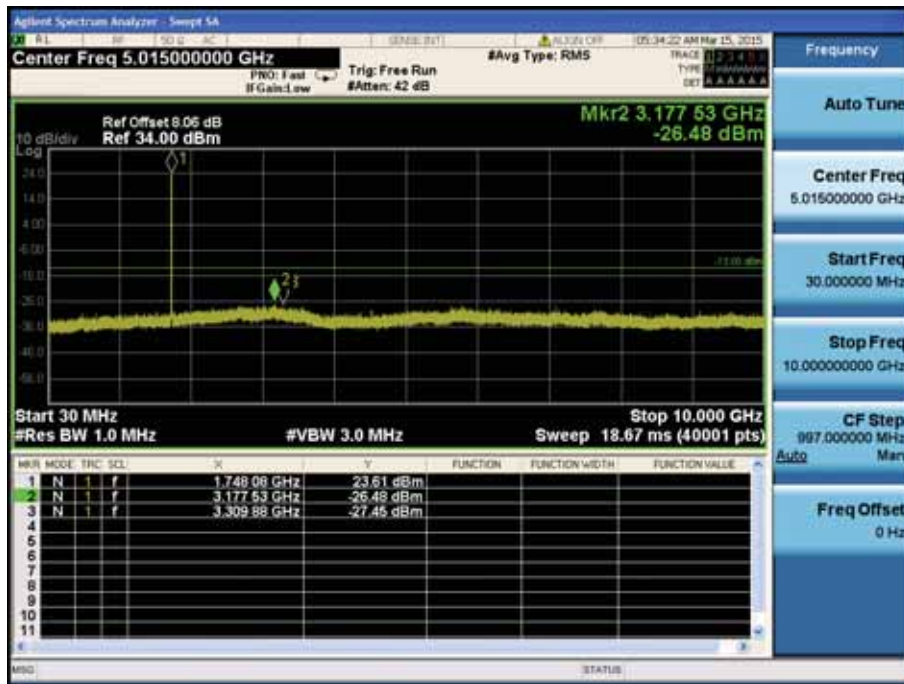

LTE Band 4 / 10MHz / 16QAM - RB Size/Offset (25/0) – High Channel

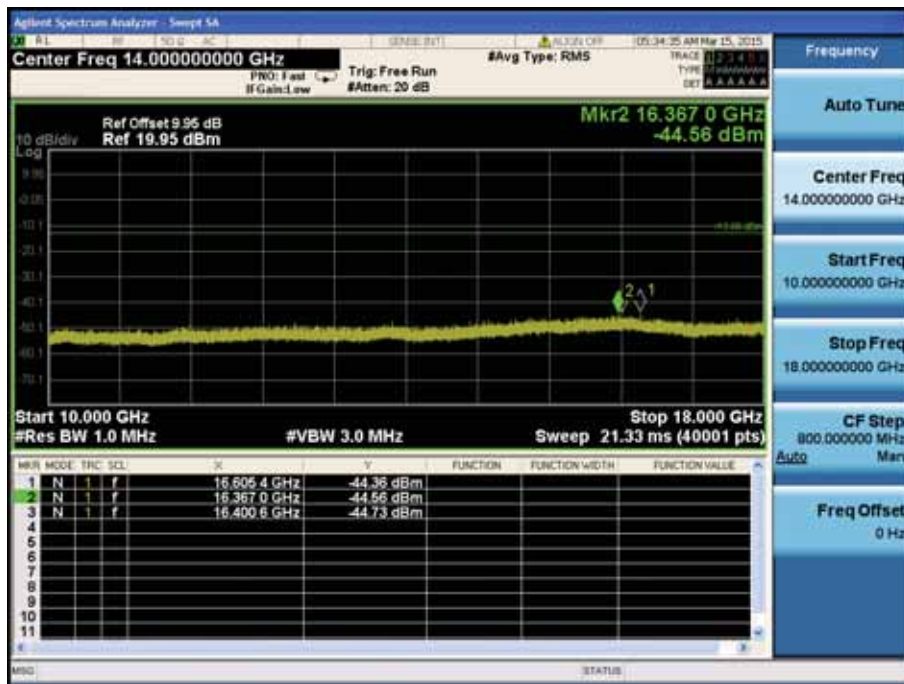

LTE Band 4 / 10MHz / 16QAM - RB Size/Offset (25/0) – High Channel

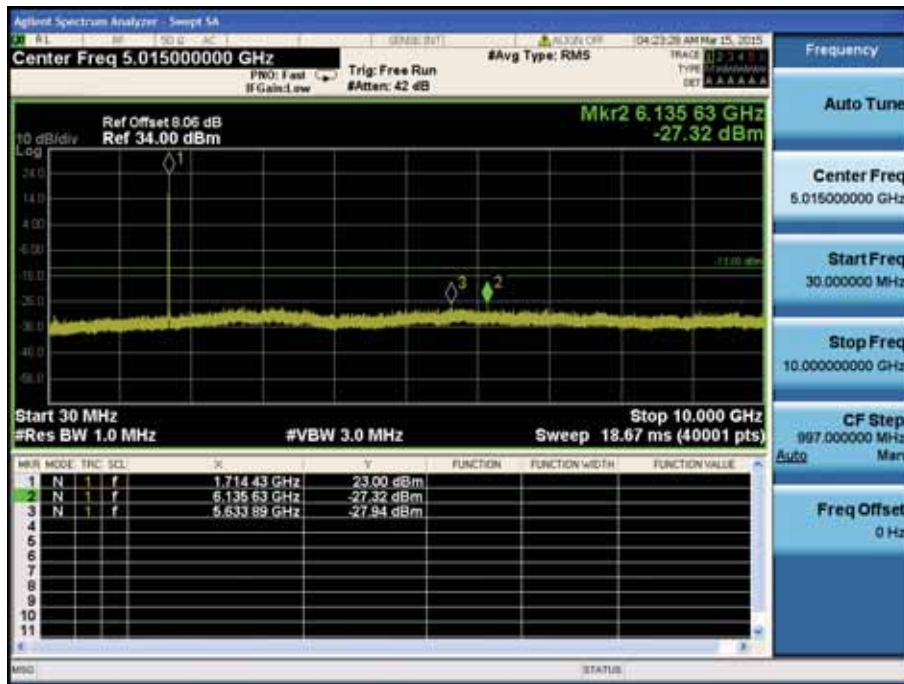

LTE Band 4 / 5MHz / 16QAM - RB Size/Offset (25/0) – Low Channel

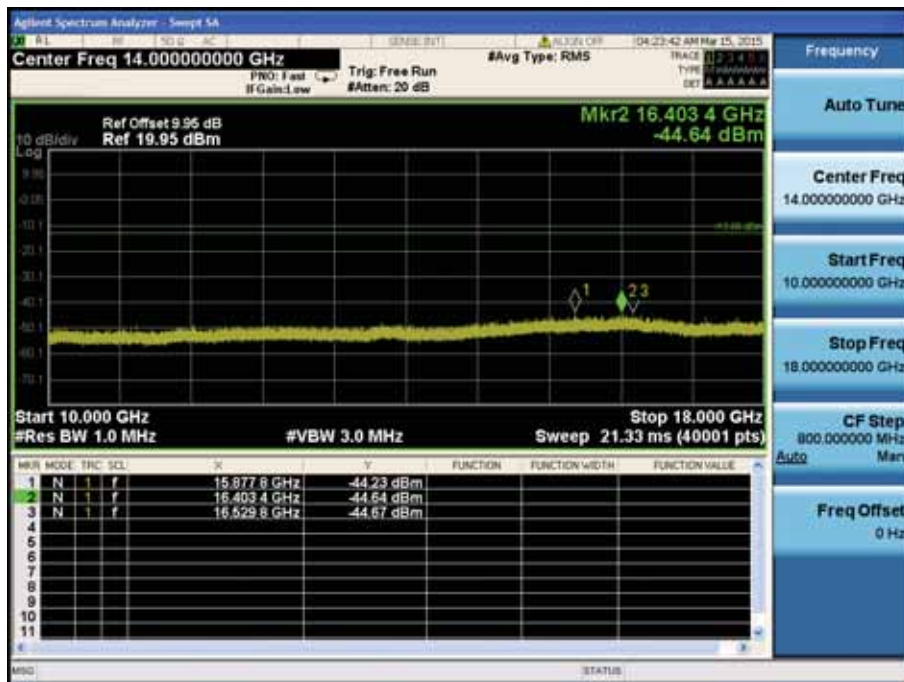

LTE Band 4 / 5MHz / 16QAM - RB Size/Offset (25/0) – Low Channel

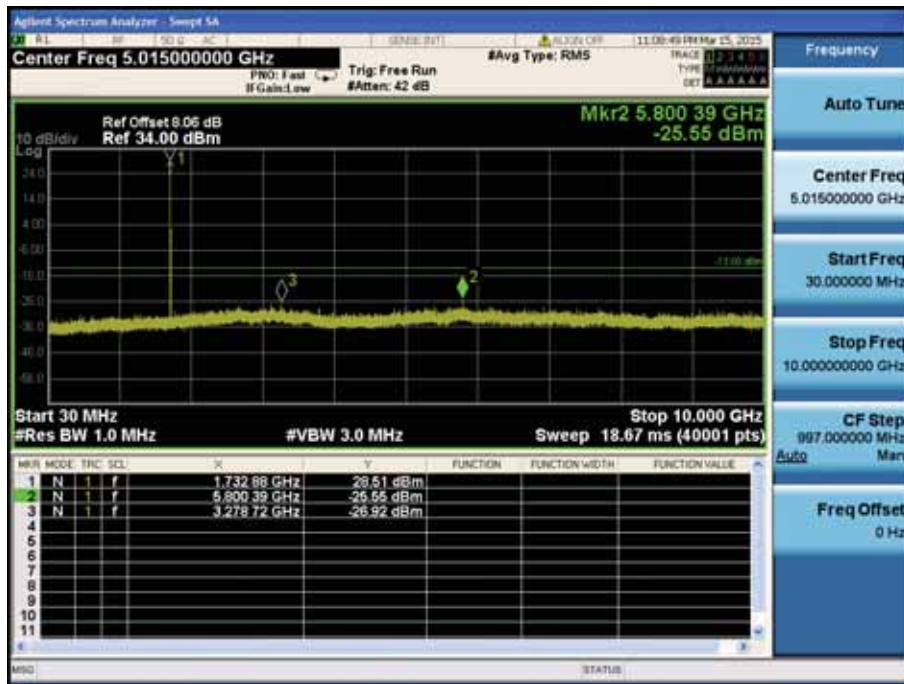

LTE Band 4 / 5MHz / QPSK - RB Size/Offset (1/12) – Mid Channel

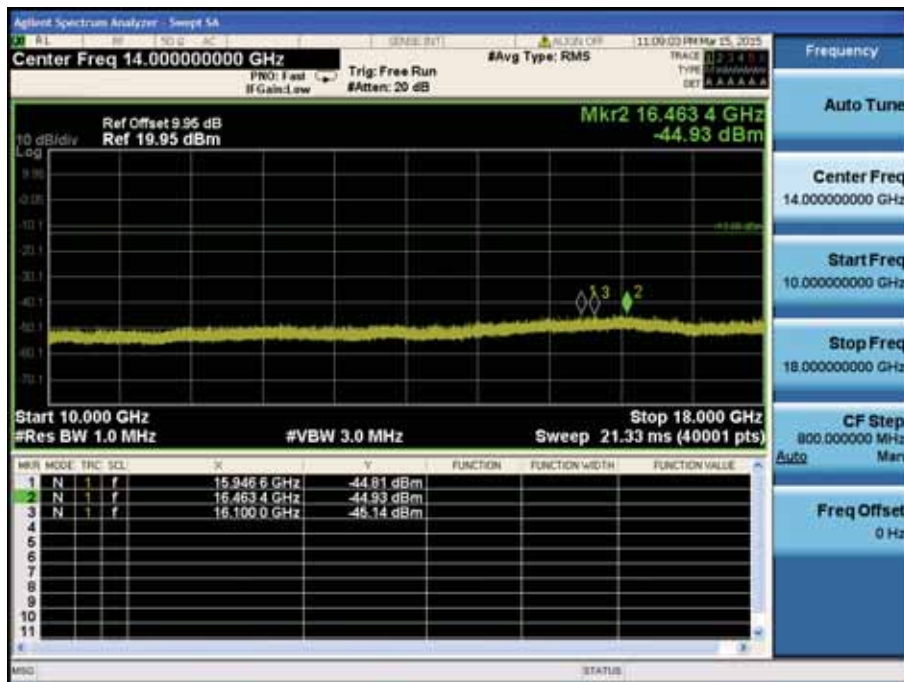

LTE Band 4 / 5MHz / QPSK - RB Size/Offset (1/12) – Mid Channel

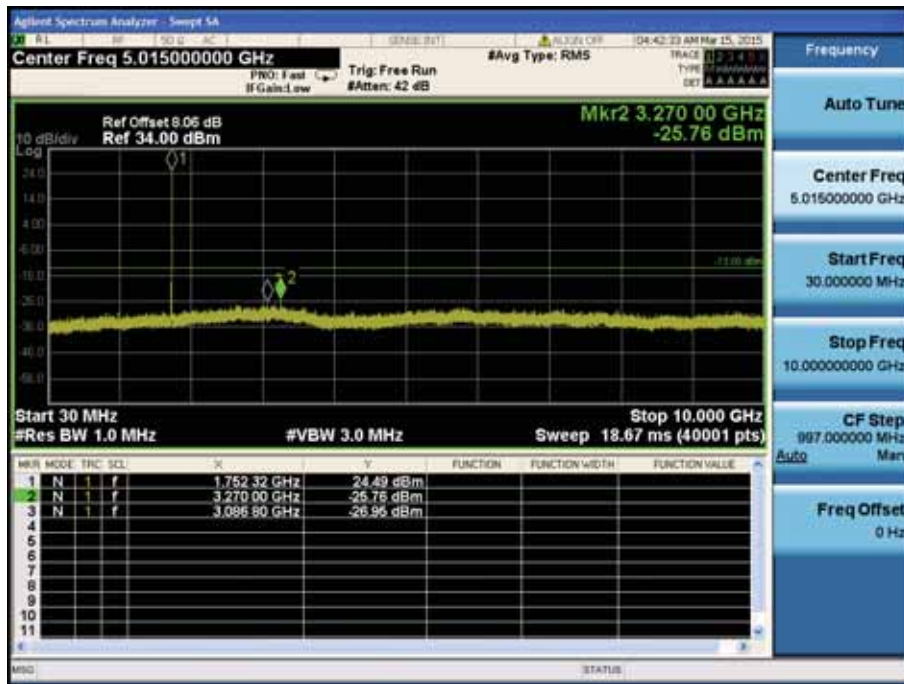

LTE Band 4 / 5MHz / 16QAM - RB Size/Offset (12/0) – High Channel

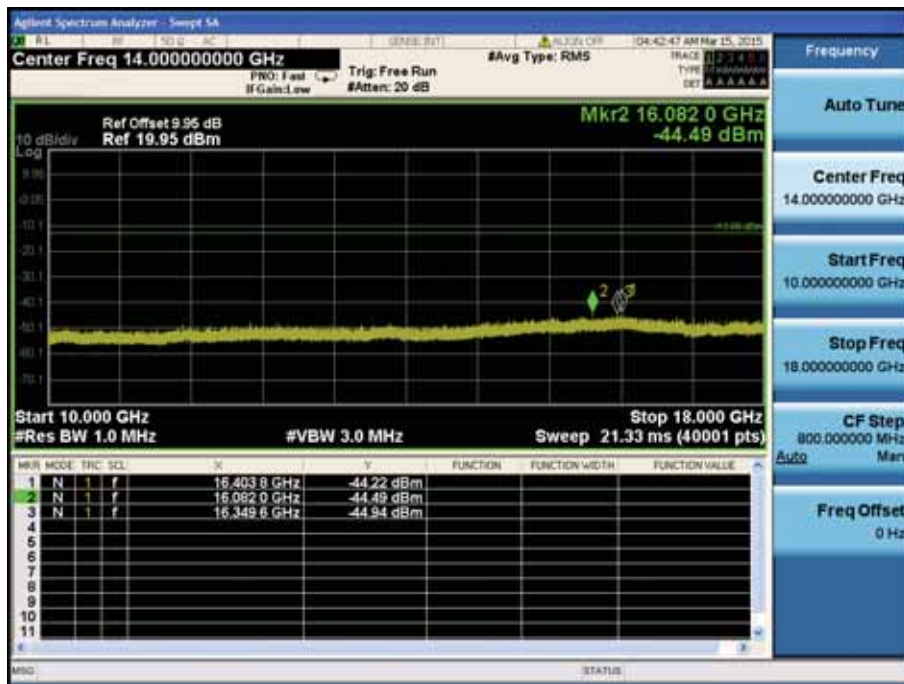

LTE Band 4 / 5MHz / 16QAM - RB Size/Offset (12/0) – High Channel

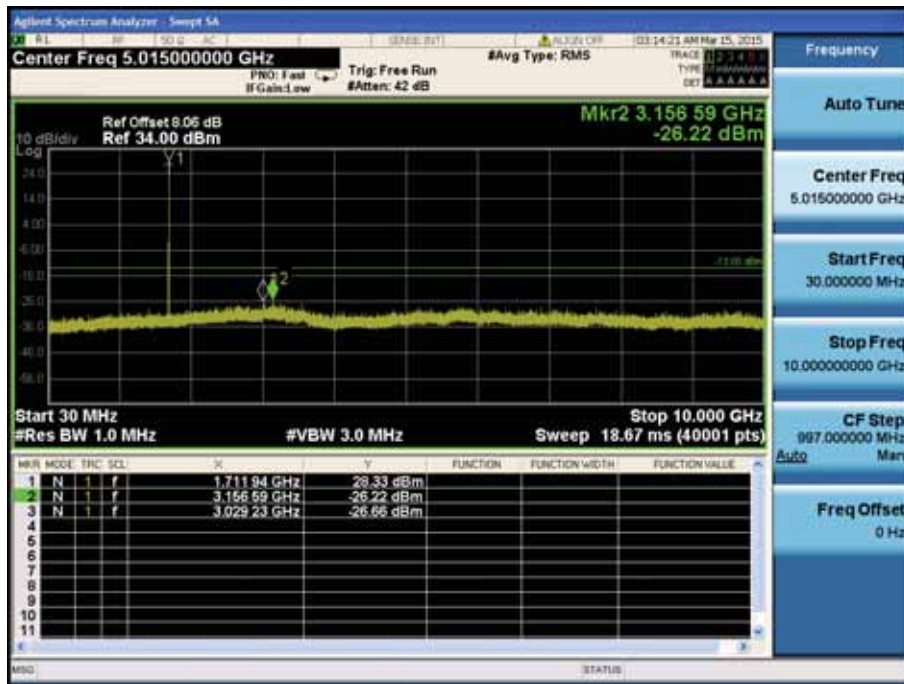

LTE Band 4 / 3MHz / 16QAM - RB Size/Offset (1/7) – Low Channel

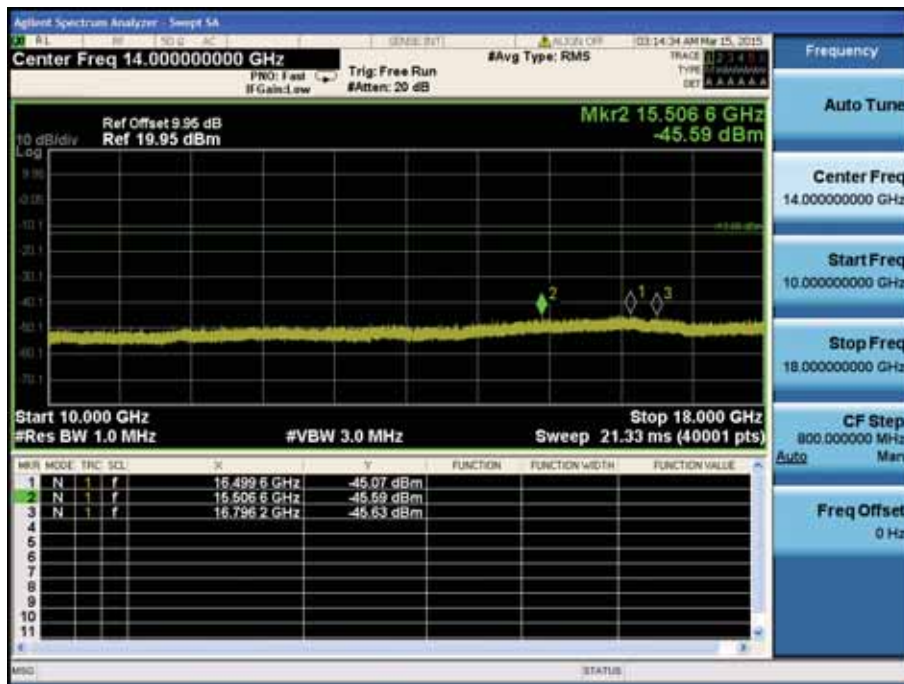

LTE Band 4 / 3MHz / 16QAM - RB Size/Offset (1/7) – Low Channel

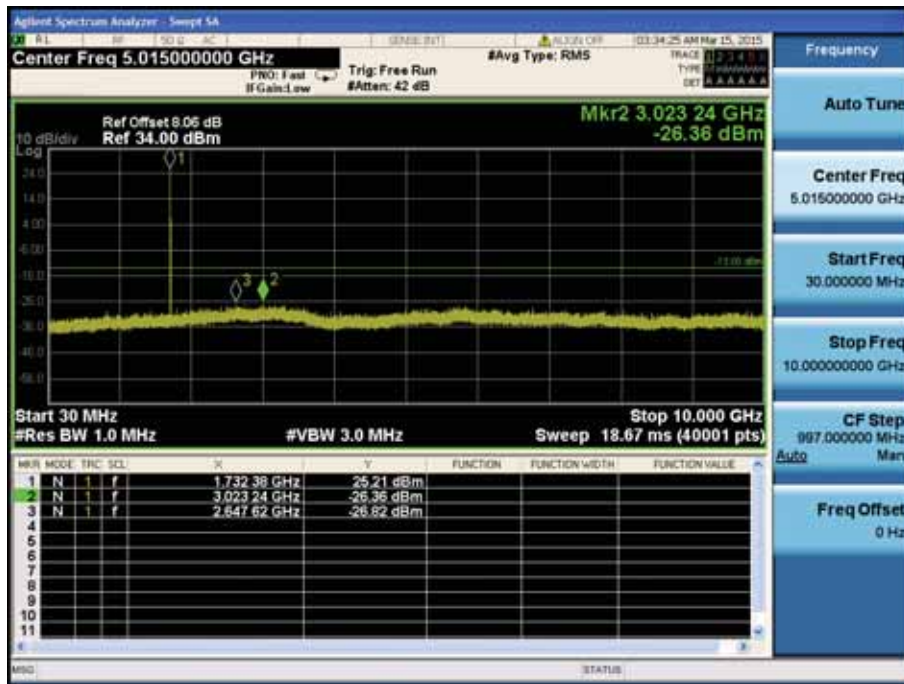

LTE Band 4 / 3MHz / 16QAM - RB Size/Offset (8/3) – Mid Channel

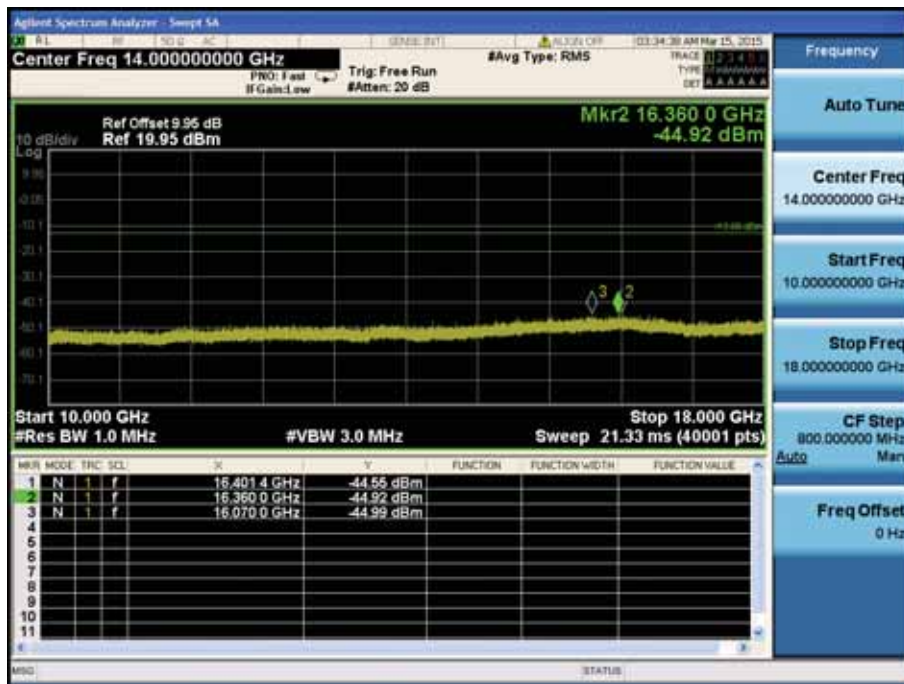

LTE Band 4 / 3MHz / 16QAM - RB Size/Offset (8/3) – Mid Channel

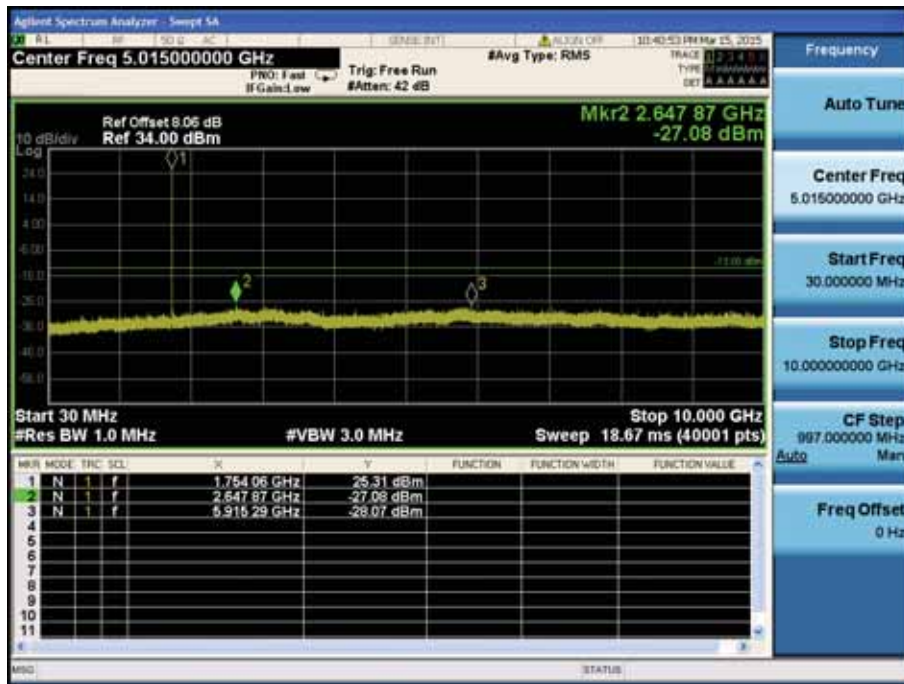

LTE Band 4 / 3MHz / QPSK - RB Size/Offset (8/7) – High Channel

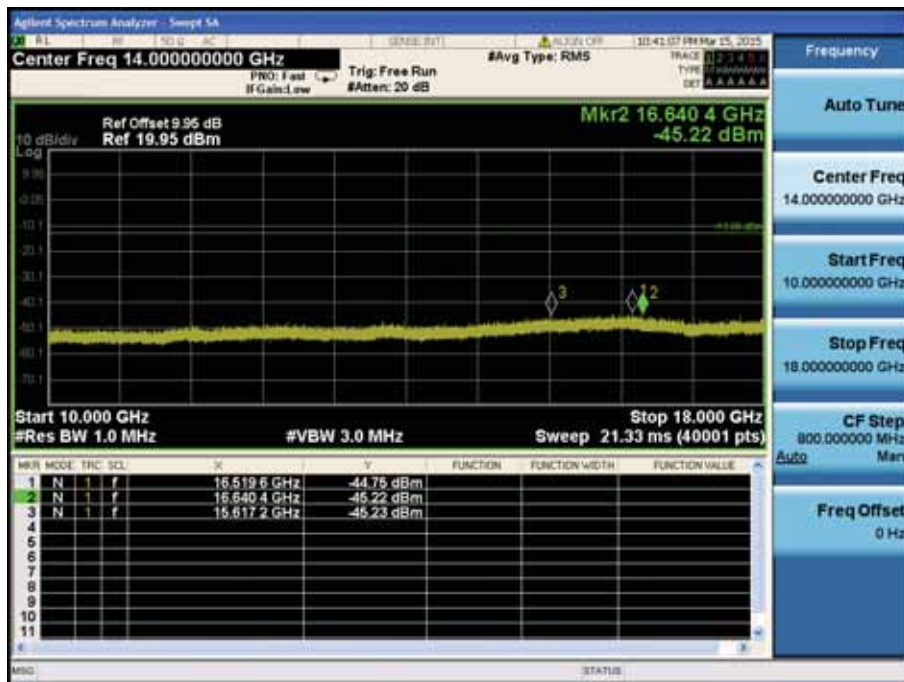

LTE Band 4 / 3MHz / QPSK - RB Size/Offset (8/7) – High Channel

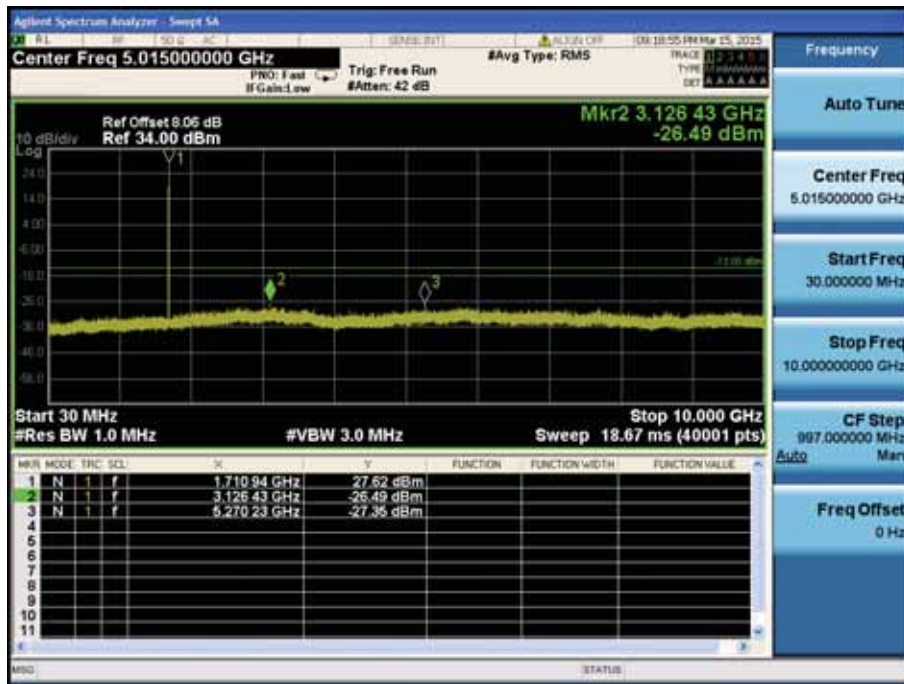

LTE Band 4 / 1.4MHz / QPSK - RB Size/Offset (3/3) – Low Channel

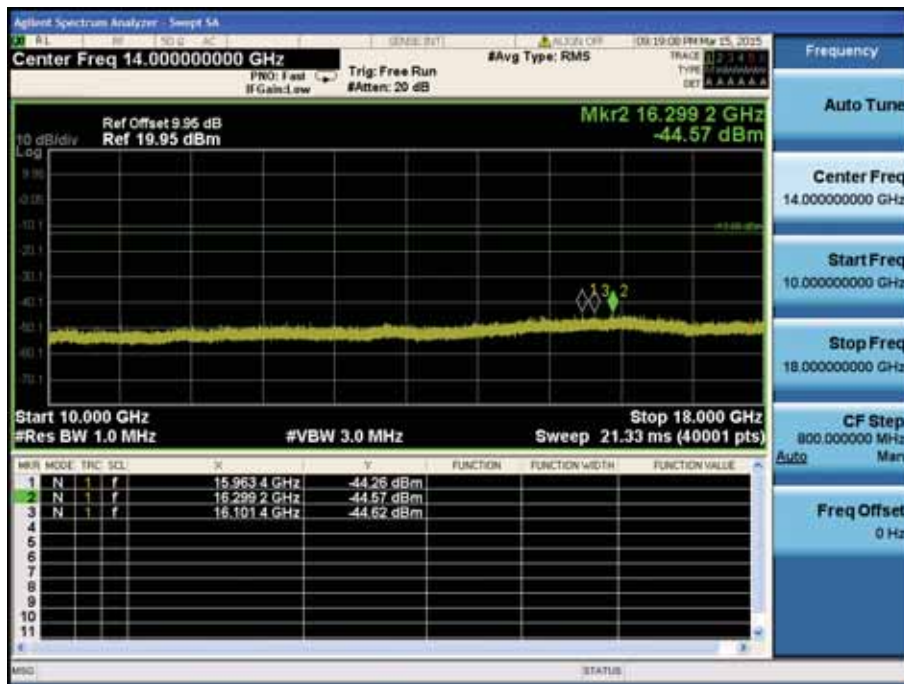

LTE Band 4 / 1.4MHz / QPSK - RB Size/Offset (3/3) – Low Channel

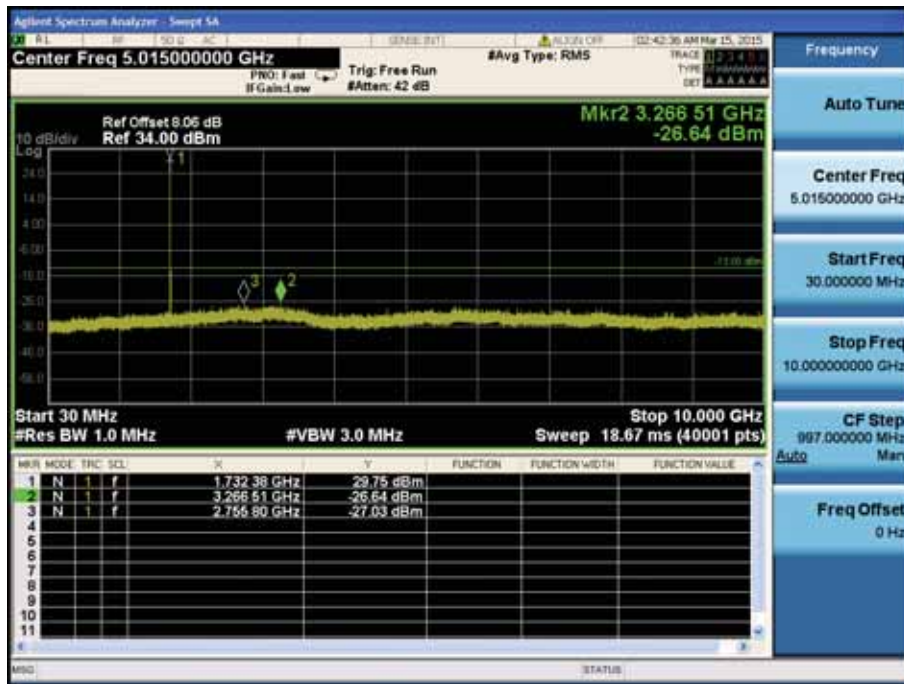

LTE Band 4 / 1.4MHz / 16QAM - RB Size/Offset (3/0) – Mid Channel

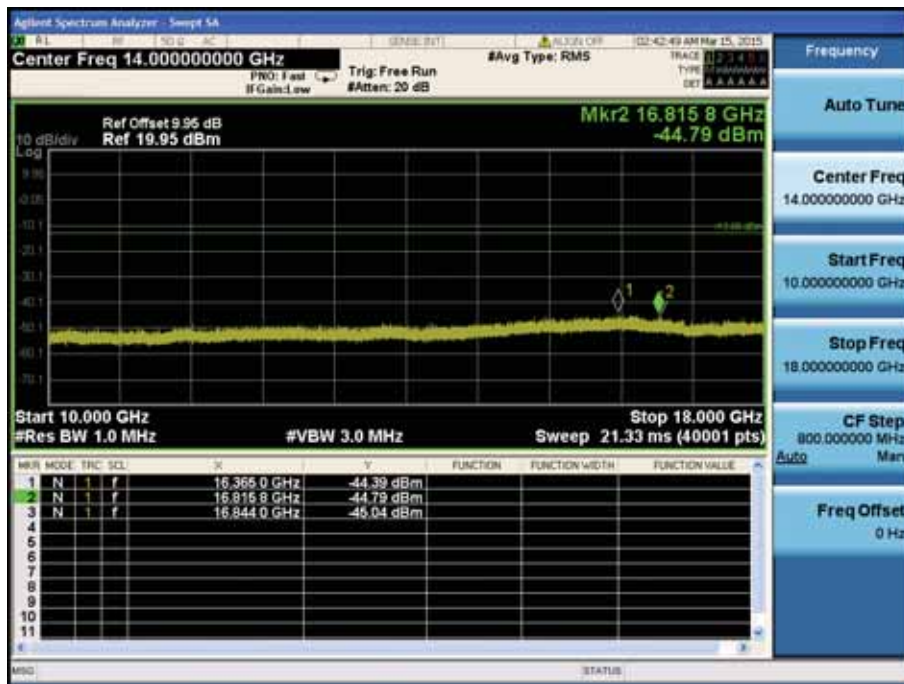

LTE Band 4 / 1.4MHz / 16QAM - RB Size/Offset (3/0) – Mid Channel

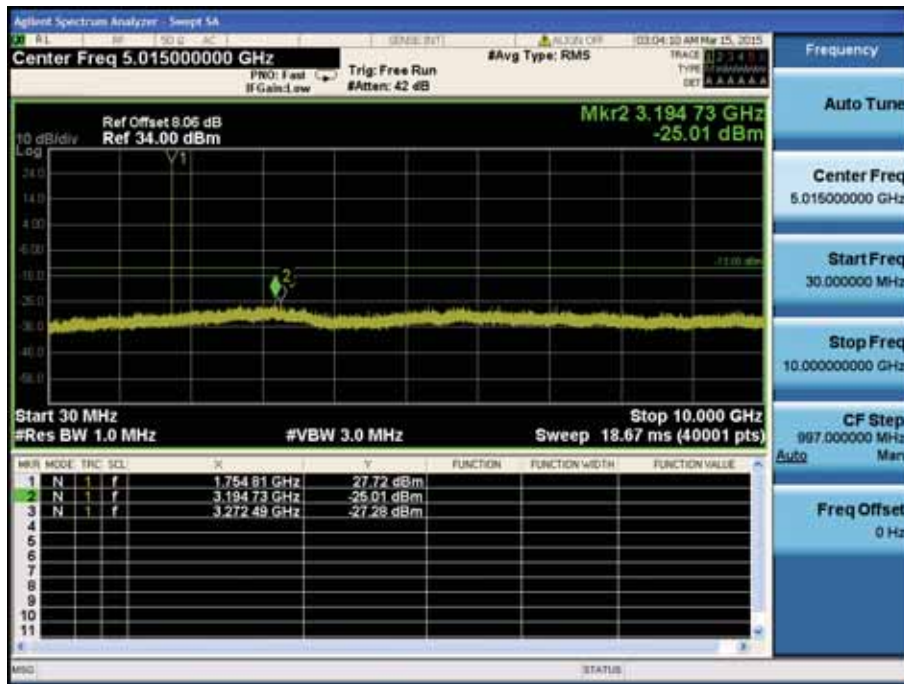

LTE Band 4 / 1.4MHz / 16QAM - RB Size/Offset (3/3) – High Channel

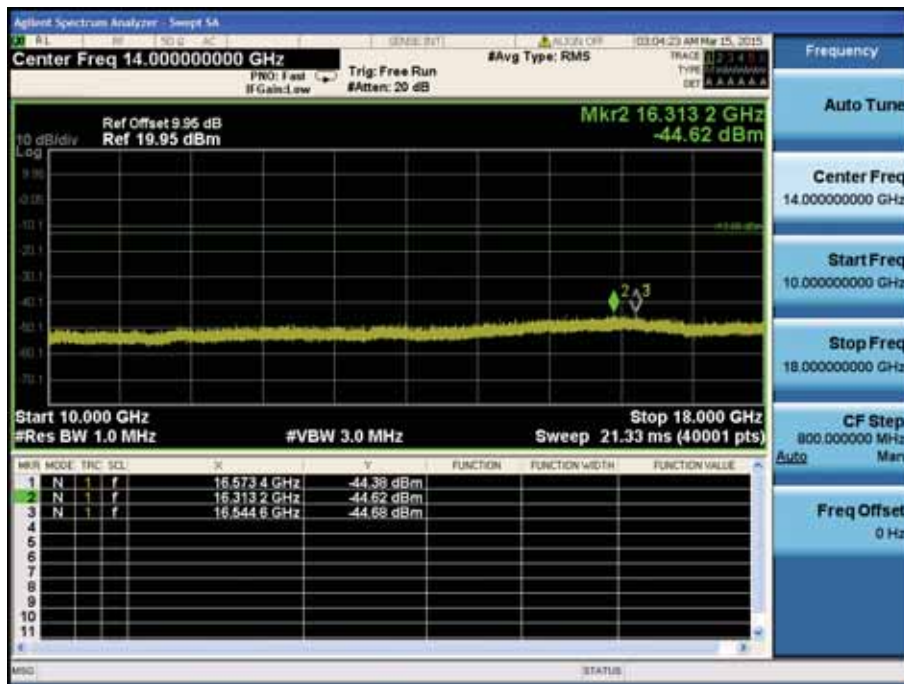

LTE Band 4 / 1.4MHz / 16QAM - RB Size/Offset (3/3) – High Channel