User Guide for LTD-VL1110 (Eagle)

Product : LTE/CDMA(EVDO) Wireless Modem

Model name : LTD-VL1110

Table of Contents

1. Overview
2. Major feature
3. Interface
4. Electrical specification
5. RF specification
6. Mechanical specification
7. General specification
8. Connector
9. RFx information
10. FCC Approval

1. Overview

The LTD-VL1110 is achieved as personal mobile communication devices of the compact radio equipment, the latest design of the parts becoming smaller, lighter weight having the LTE(700/1700MHz), CDMA(850/1900MHz) bands. It is the vehicle's telematics system that connect with LTE and CDMA(EVDO) wireless network and the wireless module with voice and data communication. It can be operated at land, rivers, and other similar areas.

On LTE operating mode, It can be communicated with uplink 50Mbps, downlink up to 100Mbps data transfer speed such as a movie or a video call. It may be able to receive large amounts of data.

Standard RS-232 port and USB port communicating with the host system via AT-command or control commands can be used to send data. Voice calls are possible.

2. Major feature

Mechanical	Dimension	93.15(L) x 45.0(W) x 7.6(T) mm
	Weight	45g(max)
	Interface	USB, UART, General Purpose I/O pins
	Antenna	FAKRA Connector
	Temperature *	Operation : -20℃ ~ +70 ℃ Storage : -40 ℃ ~ +85 ℃
Technology	Main Chipset	MDM 9615
	Memory	2048Mb(NAND) / 1024Mb(SDRAM)
	Standard	3GPP Rel.8 LTE Cat.3 - DL Speed : 100 Mbps(20M bandwidth) - UL Speed : 50 Mbps(20M bandwidth) 3GPP2 CDMA 1X, EVDO Rev.A - DL Speed : 3.1 Mbps - UL Speed : 1.8 Mbps
	Band	LTE B4, B13 CDMA 850(Cellular), 1900 (PCS) GPS Not Supported
	Power	LTE : Typ. 23dBm(Power Class 3) CDMA : Typ. 24dBm (Power Class 3)
ETC	DC Power	3.8V
	Functions	Voice, Data, SMS

3. Interface

3.1 Pin output

Customer P/N is connected with outer device using 40 pin connector

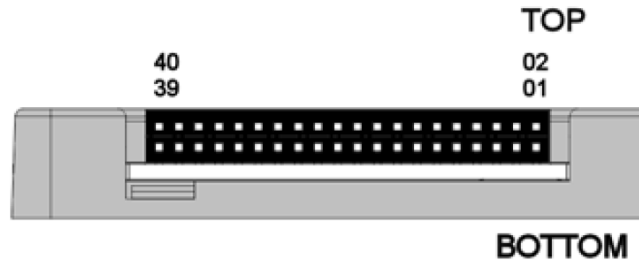

NC	1	2	NC
NC	3	4	NC
NC	5	6	NC
UART_RFR	7	8	UART_CTS
NC	9	10	NC
BOOT_OK	11	12	MSG
NC	13	14	NC
NC	15	16	PCM_3.3V_TXD
NC	17	18	PCM_3.3V_RXD
PCM_3.3V_CLK	19	20	PCM_3.3V_SYNC
GND	21	22	GND
NC	23	24	NC
NC	25	26	NC
48H_END	27	28	RESET_IN
USB_VBUS	29	30	ACC_ON_SLEEP
V_BATT	31	32	V_BATT
GND	33	34	GND
USB_D+	35	36	USB_D-
UART_TX_TCU	37	38	NC
UART_RX_TCU	39	40	GND

Figure 1. Connector pin arrangement

3. Interface

3.2 Pin description

	Pin NO.	Signal Name	In/Out	Function
NC	1, 2, 3, 4, 5, 6, 9, 10, 13, 14, 15, 17, 23, 24, 25, 26, 38	NC		
V_BATT	31, 32	POWER		POWER
GND	21, 22, 33, 34, 40	GND		GND
Audio PCM	16	PCM_3.3V_TXD	O	PCM DATA OUT
	18	PCM_3.3V_RXD	I	PCM DATA IN
	19	PCM_3.3V_CLK	I	PCM CLK
	20	PCM_3.3V_SYNC	I	PCM SYNC
UART2 (DM Port)	37	UART_RXD	I	UART RX DATA
	39	UART_TXD	O	UART TX DATA
	7	UART_RFR	O	UART ready-for-receive
	8	UART_CTS	I	UART clear-to-send
USB (USB2.0)	29	USB_VBUS	I	Power supply for the USB transceiver
	35	USB_D+	I/O	USB differential data (+)
	36	USB_D-	I/O	USB differential data (-)
User Interface	11	BOOT_OK	O	Modem Booting Completion / Modem Wake Up
	12	MSG	O	Received emergency message from Center
	27	96H_END	O	Signified in 96 hours standby mode ending
	28	RESET_IN	I	Modem Hardware reset input
	30	ACC_ON_SLEEP	I	Modem Power ON / Modem POWER Sleep

Table 1. Pin descriptions

3. Interface

3.3 UART(RS-232 Interface)

This module is provided with interface supporting Standard RS-232 protocol. DCE(modem) communicate with DTE(host) through data or control AT-Command.

Pin No.	Signal Name	Direction	Function
37	UART_RXD	I	UART RX DATA
39	UART_TXD	O	UART TX DATA
7	UART_RFR	O	UART ready-for-receive
8	UART_CTS	I	UART clear-to-send

Table 2. UART Pin descriptions

3.4 USB

It is supported with universal serial bus for high data communication. And It is satisfied with USB2.0 specification and supported with max.480Mbps

Pin No.	Signal Name	Direction	Function
37	UART_RXD	I	UART RX DATA
39	UART_TXD	O	UART TX DATA
7	UART_RFR	O	UART ready-for-receive
8	UART_CTS	I	UART clear-to-send

Table 3. USB Pin descriptions

3. Interface

3.5 Audio

This module is provided with PCM interface. The resistor of pulled-up or pulled-down in this pin must be over 50Kohm.

Pin No.	Signal Name	Direction	Function
37	UART_RXD	I	UART RX DATA
39	UART_TXD	O	UART TX DATA
7	UART_RFR	O	UART ready-for-receive
8	UART_CTS	I	UART clear-to-send

Table 4. PCM Pin descriptions

3.6 User interface

Pin No.	Signal Name	Direction	Function
11	BOOT_OK	O	Modem booting end / Modem Wake Up
12	MSG	O	Received emergency message from center
27	96H_END	O	Signified in 96 hours standby mode ending
28	RESET_IN-	I	Modem Hardware reset input
30	ACC_ON_SLEEP	I	Modem Power ON / Modem Power Sleep

Table 5. User interface Pin descriptions

4. Electrical specification

4.1 Power supply specification

Modem power(V_BATT) should be provided DC3.8V \pm 0.1V, 2.0A. Modem power is provided according to inner function and per block using DC regulated circuit. It is controlled with each power depending on the mechanism to reduce power consumption to a minimum. PA is used directly V_BATT because of a lot of power input power source. Thus, It can be resulted in breakage of PA in excess of the rated input power. In addition, surge and ESD should be designed to block the influx in order to prevent damage to the modem.

Pin No.	Signal Name	Direction	MIN	TYP	MAX
32, 33	V_BATT	I	3.7V	3.8V	3.9V

Table 6. Power supply specification

4. Electrical specification

4.2 Logic level specification

4.2.1 Digital logic level specification

Basic interface level : CMOS 1.8V

Parameter		Comments	Min	Max	Unit
V_{IH}	High-level input voltage	CMOS/Schmitt	$0.65 * V_{DD_PX}$	$V_{DD_PX} + 0.3$	V
V_{IL}	Low-level input voltage	CMOS/Schmitt	-0.3	$0.35 * V_{DD_PX}$	V
V_{SHYS}	Schmitt hysteresis voltage		100	–	mV
I_{IH}	Input high leakage current ¹	No pulldown	–	1	μ A
I_{IL}	Input low leakage current ²	No pullup	-1	–	μ A
R_P	Pull up/down resistance		55	390	k Ω
R_{PSD}	High-V pad pull up/down resistance	For SDC1_CLK, SDC1_CMD, SDC1_DATA[3:0], GPIO[3:1], and GPIO[7:5] pins	10	100	k Ω
V_{OH}	High-level output voltage ³	CMOS, at pin-rated drive strength	$V_{DD_PX} - 0.45$	V_{DD_PX}	V
V_{OL}	Low-level output voltage ³	CMOS, at pin-rated drive strength	0	0.45	V
I_{OZH}	Tri-state leakage current ¹	Logic high output, no pulldown	–	1	μ A
I_{OZL}	Tri-state leakage current ²	Logic low output, no pullup	-1	–	μ A
R_K	Keeper resistance		30	150	k Ω
R_{KSD}	High-V pad keeper resistance	For SDC1_CLK, SDC1_CMD, SDC1_DATA[3:0], GPIO[3:1], and GPIO[7:5] pins	10	100	k Ω
I_{ISL}	Sleep crystal input leakage		-0.15	0.15	μ A
I_{IHVKP}	High-V tolerant input leakage	With keeper	-1	–	μ A
C_{IN}	Input capacitance ⁴		–	5	pF

Table 7. Digital logic level specification

5. RF specification

5.1 CDMA

5.1.1 Receiver

- .- Bandwidth : 1.25MHz
- .- Frequency : 869MHz – 894MHz (BC0), 1930MHz – 1990MHz (BC1)
- .- RF to Baseband Direct conversion (Zero IF)
- .- Modulation method : QPSK, 8PSK and 16QAM
- .- Sensitivity : ≤ -104 dBm (BER = Under 0.5%)

5.1.2 Transmitter

- .- Frequency: 824MHz – 849MHz (BC0), 1850MHz – 1910MHz (BC1)
- .- Maximum RF Output : Power class3 (BC0), 23.01dBm ~ 26dBm
Power class2 (BC1), 23.01dBm ~ 26dBm
- .- Modulation method : BPSK, QPSK AND 8PSK
- .- Baseband to RF Direct conversion (Zero IF)

5.2 LTE

5.2.1 Receiver

- .- Bandwidth : B4(20MHz), B13(10MHz)
- .- Frequency : 2110MHz – 2155MHz (B4), 746MHz – 756MHz (B13)
- .- RF to Baseband Direct conversion (Zero IF)
- .- Modulation method : QPSK, 16QAM and 64QAM
- .- 수신감도 : Main - B4 (≤ -93.3 dBm @QPSK), B13(≤ -93.3 dBm @QPSK)
Diversity - B4 (≤ -93.3 dBm @QPSK), B13(≤ -93.3 dBm @QPSK)

5.2.2 Transmitter

- .- Frequency : B4 (1710MHz – 1755MHz), B13(777MHz – 787MHz)
- .- Maximum RF Output : Power class 3, 20.3dBm ~ 25.7dBm
- .- Modulation method : QPSK and 16QAM
- .- Baseband to RF Direct conversion (Zero IF)

6. Mechanical specification

6.1 Mechanical dimensions

Dimensions	93.15 x 45.0 x 7.6 mm
Weight	45 grams(max.)
Modem Interface connector	KM17E-40DS (Vendor : HIROSE)
Modem Antenna Connector (Plug)	Main Antenna : KR15006-DD (Vendor : KET) Diversity Antenna : KR15003-SG (Vendor : KET)

Table 8. Mechanical specification

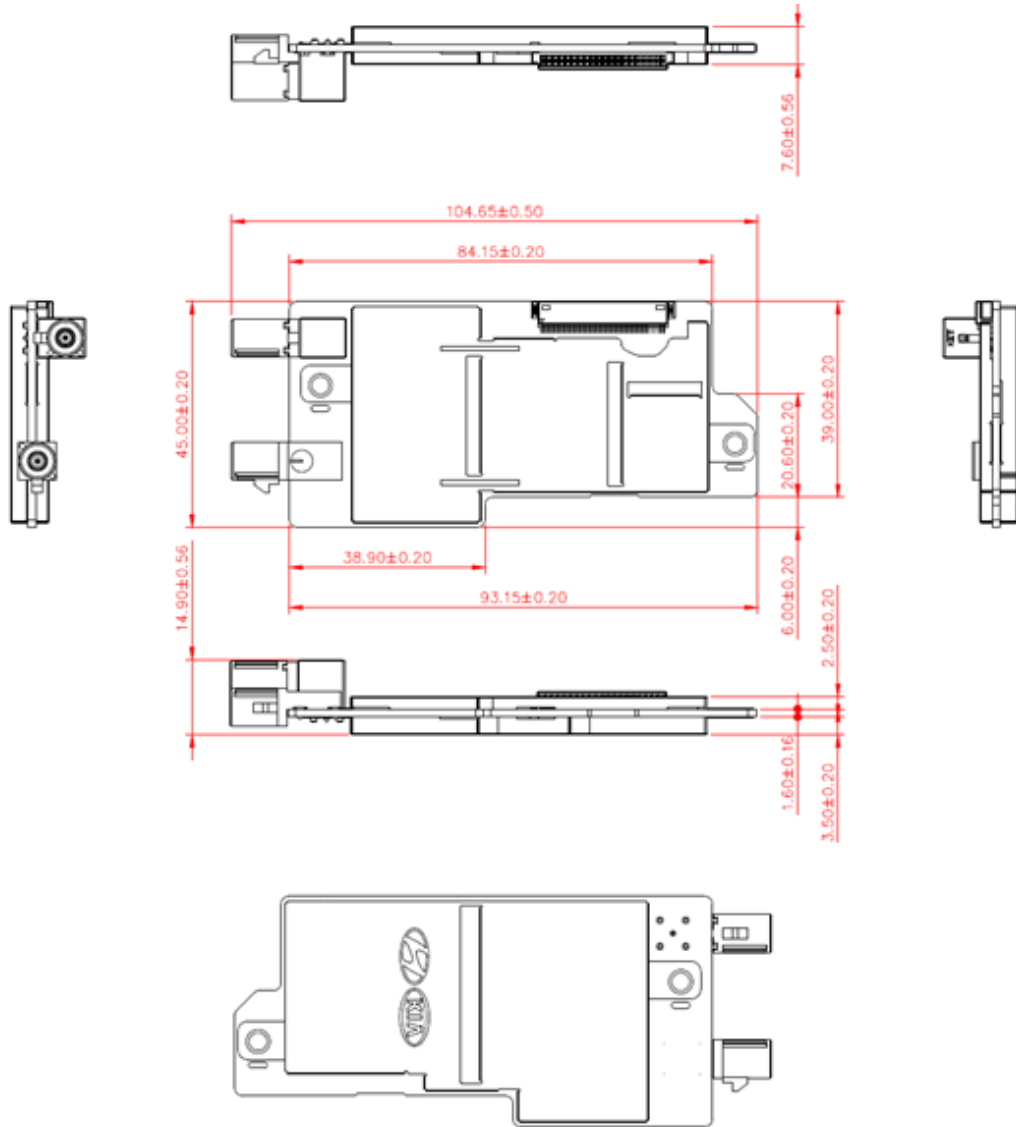

Figure 2. Mechanical dimension

6. Mechanical specification

6.1 Environment specification

- .- Storage Temp : -40°C ~ +85°C
- .- Operating Temp : -20°C ~ +70°C
 - (-20°C ~ +70°C : 3GPP specifications are satisfied
 - 30°C~-20°C, +70°C~+80°C : It can be performance degradation)
- .- Operating humidity : 80% (60°C) relative humidity

7. General specification

7.1 CDMA electrical specification

	Test item		Spec.	CHANNEL		
				1011/25	384/600	779/1175
4.4.5	Maximum Output Power		23.01~26dBm	PASS	PASS	PASS
4.5.1	Conducted Spurious Emissions	885 kHz to 1.98 MHz	-42 dBc↓/30 kHz	PASS	PASS	PASS
		1.98 MHz to 4.00 MHz	-54 dBc↓/30 kHz (BC0) -50 dBc↓/30 kHz (BC1)	PASS	PASS	PASS
4.4.6	Minimum Controlled Output Power		-50dBm↓	PASS	PASS	PASS
4.3.4	Waveform Quality	Rho	0.94 ~1.00	PASS	PASS	PASS
		Freq_E	+/-300.00Hz(BC0) +/-150.00Hz(BC1)	PASS	PASS	PASS
		Time_E	-1.00~1.00 us	PASS	PASS	PASS
4.4.4	Range of Closed Loop Power Control	up @ Full rate	24↑	PASS	PASS	PASS
		down @ Full Rate	-24↓	PASS	PASS	PASS
		up @ Half rate	24↑	PASS	PASS	PASS
		down @ Half Rate	-24↓	PASS	PASS	PASS
		up @ Quarter rate	24↑	PASS	PASS	PASS
		down @ Quarter Rate	-24↓	PASS	PASS	PASS
		up @ Eighth rate	24↑	PASS	PASS	PASS
		down @ Eighth Rate	-24↓	PASS	PASS	PASS
4.4.2	Time Response of Open Loop Control		PASS	PASS	PASS	PASS
4.4.1	Range of Open Loop Power	Open Loop Power Upper	-57.50~-38.50(BC0) -60.50~-41.50(BC1)	PASS	PASS	PASS
		Open Loop Power Mid	-17.50~1.50(BC0) -20.50~-1.50(BC1)	PASS	PASS	PASS
		Open Loop Power Sense	10.50~29.50(BC0) 10.50~29.50(BC1)	PASS	PASS	PASS
3.5.1	Reference Sensitivity Level(-104/-25)		0.5%↓	PASS	PASS	PASS

Table 9. CDMA RF specification

7. General specification

7.2 LTE B4(20M) electrical specification

	시험 항목	Spec.	Test Temperature	Channel		
				2050	2175	2300
6.2.2	Maximum Output Power(class 3)	23±2.7dBm	Normal, Temp L, Temp H	PASS	PASS	PASS
6.3.2	Minimum Output Power	-39dBm ↓	Normal, Temp L, Temp H	PASS	PASS	PASS
6.5.1	Frequency Error	±0.1ppm	Normal, Temp L, Temp H	PASS	PASS	PASS
6.5.2.1	Error Vector Magnitude(EVM)	17.5%↓ (QPSK)	Normal	PASS	PASS	PASS
		12.5%↓ (16QAM)		PASS	PASS	PASS
6.5.2.2	Relative Carrier Leakage Power	Carrier Leakage (3.2dBm ± 3.2dB)	Normal, Temp L, Temp H	PASS	PASS	PASS
		Carrier Leakage (-26.8dBm ± 3.2dB)		PASS	PASS	PASS
		Carrier Leakage (-36.8dBm ± 3.2dB)		PASS	PASS	PASS
6.5.2.4	EVM equalizer spectrum flatness	EVM equalizer spectrum flatness Range1	Normal, Temp L, Temp H	PASS	PASS	PASS
		EVM equalizer spectrum flatness Range2		PASS	PASS	PASS
6.6.1	Occupied Bandwidth (OBW)	20 MHz ↓	Normal	PASS	PASS	PASS
6.6.2.1	Spectrum emission mask	Spectrum Emission Mask upper/lower Area 1	Normal	PASS	PASS	PASS
		Spectrum Emission Mask upper/lower Area 2		PASS	PASS	PASS
		Spectrum Emission Mask upper/lower Area 3		PASS	PASS	PASS
		Spectrum Emission Mask upper/lower Area 4		PASS	PASS	PASS
6.6.2.3	Adjacent Channel Leakage Power Ratio (ACLR)	ACLR E-UTRA ±	Normal, Temp L, Temp H	PASS	PASS	PASS
		ACLR UTRA Offset 1 ±		PASS	PASS	PASS
		ACLR UTRA Offset 2 ±		PASS	PASS	PASS
7.3	Reference Sensitivity Level @ 20MHz	Main Ref Sense throughput shall be ≥ 95%	Normal, Temp L, Temp H	PASS	PASS	PASS
		Div. Ref Sense throughput shall be ≥ 95%		PASS	PASS	PASS
7.4	Maximum Input Level	throughput shall be ≥ 95%	Normal	PASS	PASS	PASS

Table 10. LTE B4(20M) RF specification

7. General specification

7.3 LTE B13(10M) electrical specification

	시험 항목	Spec.	Test Temperature	Channel		
				2050	2175	2300
6.2.2	Maximum Output Power(class 3)	23±2.7dBm	Normal, Temp L, Temp H	PASS	PASS	PASS
6.3.2	Minimum Output Power	-39dBm ↓	Normal, Temp L, Temp H	PASS	PASS	PASS
6.5.1	Frequency Error	±0.1ppm	Normal, Temp L, Temp H	PASS	PASS	PASS
6.5.2.1	Error Vector Magnitude(EVM)	17.5%↓ (QPSK)	Normal	PASS	PASS	PASS
		12.5%↓ (16QAM)		PASS	PASS	PASS
6.5.2.2	Relative Carrier Leakage Power	Carrier Leakage (3.2dBm ± 3.2dB)	Normal, Temp L, Temp H	PASS	PASS	PASS
		Carrier Leakage (-26.8dBm ± 3.2dB)		PASS	PASS	PASS
		Carrier Leakage (-36.8dBm ± 3.2dB)		PASS	PASS	PASS
6.5.2.4	EVM equalizer spectrum flatness	EVM equalizer spectrum flatness Range1	Normal, Temp L, Temp H	PASS	PASS	PASS
		EVM equalizer spectrum flatness Range2		PASS	PASS	PASS
6.6.1	Occupied Bandwidth (OBW)	10 MHz ↓	Normal	PASS	PASS	PASS
6.6.2.1	Spectrum emission mask	Spectrum Emission Mask upper/lower Area 1	Normal	PASS	PASS	PASS
		Spectrum Emission Mask upper/lower Area 2		PASS	PASS	PASS
		Spectrum Emission Mask upper/lower Area 3		PASS	PASS	PASS
		Spectrum Emission Mask upper/lower Area 4		PASS	PASS	PASS
6.6.2.3	Adjacent Channel Leakage Power Ratio (ACLR)	ACLR E-UTRA ±	Normal, Temp L, Temp H	PASS	PASS	PASS
		ACLR UTRA Offset 1 ±		PASS	PASS	PASS
		ACLR UTRA Offset 2 ±		PASS	PASS	PASS
7.3	Reference Sensitivity Level @ 10MHz	Main Ref Sense throughput shall be ≥ 95%	Normal, Temp L, Temp H	PASS	PASS	PASS
		Div. Ref Sense throughput shall be ≥ 95%		PASS	PASS	PASS
7.4	Maximum Input Level	throughput shall be ≥ 95%	Normal	PASS	PASS	PASS

Table 11. LTE B13(10M) RF specification

8. Connector

8.1 Antenna Connector(Main): KR15006-DD (Vendor : KET)

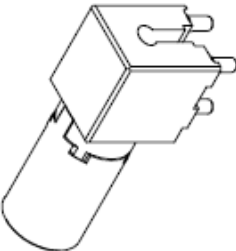
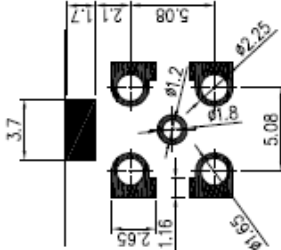
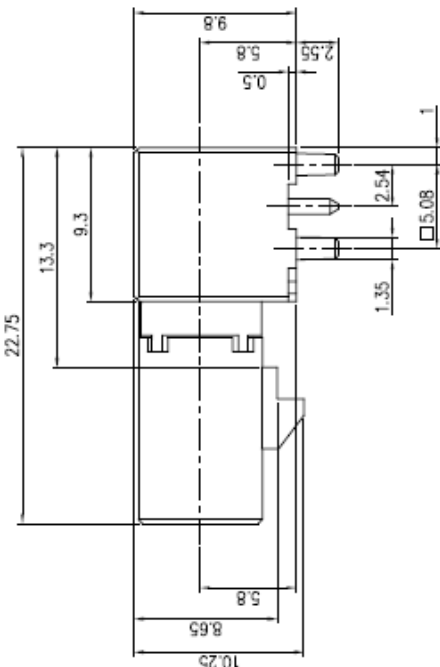
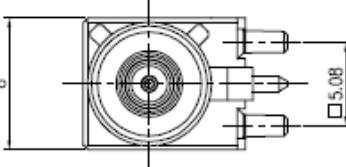
<p>ISOMETRIC VIEW</p> 	 <p>PCB LAYOUT (General Tolerance: ±0.05)</p>																																																																																																																		
<p>CUSTOMER DRAWING PART NO. KR15006-DD DATE 14 DEC 2014</p>																																																																																																																			
<table border="1" style="width: 100%; border-collapse: collapse;"> <tr> <td>5 CONTACT</td> <td>BRASS</td> <td>-</td> <td></td> <td>PHOSPOR BRONZE</td> <td>-</td> <td>NH-SP</td> <td>1</td> <td></td> <td></td> <td rowspan="7"> ISSUE MARK KET KETRA ELECTRIC TERMINAL CO., LTD. CLASS RF CONN PART TYPE - UNDER LOCK PART NO. KR15006-DD PART NAME FAKRACT WAFER II ASSY(DP.J) </td> </tr> <tr> <td>4 SHELL</td> <td>PHOSPOR BRONZE</td> <td>-</td> <td></td> <td>WHITE</td> <td>-</td> <td>NH-SP</td> <td>1</td> <td></td> <td></td> </tr> <tr> <td>3 GASKET HOUSING</td> <td>NYLON</td> <td></td> <td></td> <td>WHITE</td> <td></td> <td>-</td> <td></td> <td></td> <td></td> </tr> <tr> <td>2 INSULATOR</td> <td>NYLON</td> <td></td> <td></td> <td>WHITE</td> <td></td> <td>-</td> <td></td> <td></td> <td></td> </tr> <tr> <td>1 HOUSING</td> <td>TEFLOPLASTIC</td> <td></td> <td></td> <td>BLACK</td> <td></td> <td>-</td> <td></td> <td></td> <td></td> </tr> <tr> <td>No.</td> <td>Part Name</td> <td>Material</td> <td>Color</td> <td></td> <td></td> <td>Finish</td> <td>Qty</td> <td>Remark</td> <td></td> </tr> <tr> <td colspan="5"></td> <td></td> <td></td> <td></td> <td></td> <td></td> </tr> <tr> <td colspan="10" style="text-align: center;">REVISION TABLE</td> </tr> <tr> <td>REV</td> <td>DESCRIPTION</td> <td>BY</td> <td>CHK</td> <td>APP</td> <td>DATE</td> <td>REASON</td> <td>QUANTITY</td> <td>REMARK</td> <td></td> </tr> <tr> <td>001</td> <td>PJM 14.01.08</td> <td></td> <td></td> <td></td> <td></td> <td></td> <td>±0.2</td> <td>4:1</td> <td>DIP Type - UNDER LOCK</td> </tr> <tr> <td>002</td> <td></td> <td></td> <td></td> <td></td> <td></td> <td></td> <td></td> <td></td> <td>FAKRACT WAFER II ASSY(DP.J)</td> </tr> </table>					5 CONTACT	BRASS	-		PHOSPOR BRONZE	-	NH-SP	1			ISSUE MARK KET KETRA ELECTRIC TERMINAL CO., LTD. CLASS RF CONN PART TYPE - UNDER LOCK PART NO. KR15006-DD PART NAME FAKRACT WAFER II ASSY(DP.J)	4 SHELL	PHOSPOR BRONZE	-		WHITE	-	NH-SP	1			3 GASKET HOUSING	NYLON			WHITE		-				2 INSULATOR	NYLON			WHITE		-				1 HOUSING	TEFLOPLASTIC			BLACK		-				No.	Part Name	Material	Color			Finish	Qty	Remark												REVISION TABLE										REV	DESCRIPTION	BY	CHK	APP	DATE	REASON	QUANTITY	REMARK		001	PJM 14.01.08						±0.2	4:1	DIP Type - UNDER LOCK	002									FAKRACT WAFER II ASSY(DP.J)
5 CONTACT	BRASS	-		PHOSPOR BRONZE	-	NH-SP	1			ISSUE MARK KET KETRA ELECTRIC TERMINAL CO., LTD. CLASS RF CONN PART TYPE - UNDER LOCK PART NO. KR15006-DD PART NAME FAKRACT WAFER II ASSY(DP.J)																																																																																																									
4 SHELL	PHOSPOR BRONZE	-		WHITE	-	NH-SP	1																																																																																																												
3 GASKET HOUSING	NYLON			WHITE		-																																																																																																													
2 INSULATOR	NYLON			WHITE		-																																																																																																													
1 HOUSING	TEFLOPLASTIC			BLACK		-																																																																																																													
No.	Part Name	Material	Color			Finish	Qty	Remark																																																																																																											
REVISION TABLE																																																																																																																			
REV	DESCRIPTION	BY	CHK	APP	DATE	REASON	QUANTITY	REMARK																																																																																																											
001	PJM 14.01.08						±0.2	4:1	DIP Type - UNDER LOCK																																																																																																										
002									FAKRACT WAFER II ASSY(DP.J)																																																																																																										

주 기

1. DOWING REVERSE TABLE "A" 일대기
2. 포장 방법 : REEL PACKING

* 5 hazardous substances in parts: Lead, Mercury, Cadmium, Hexavalent Chromium, Pbb, Pbr
 * This product complies with European Union Restriction of Hazardous Substances (RoHS) Directive
 * E.U. Directive & RoHS Regulations.*

DESIGN REVISION NO. 0

8. Connector

8.2 Antenna Connector(Div.) KR15003-SG (Vendor : KET)

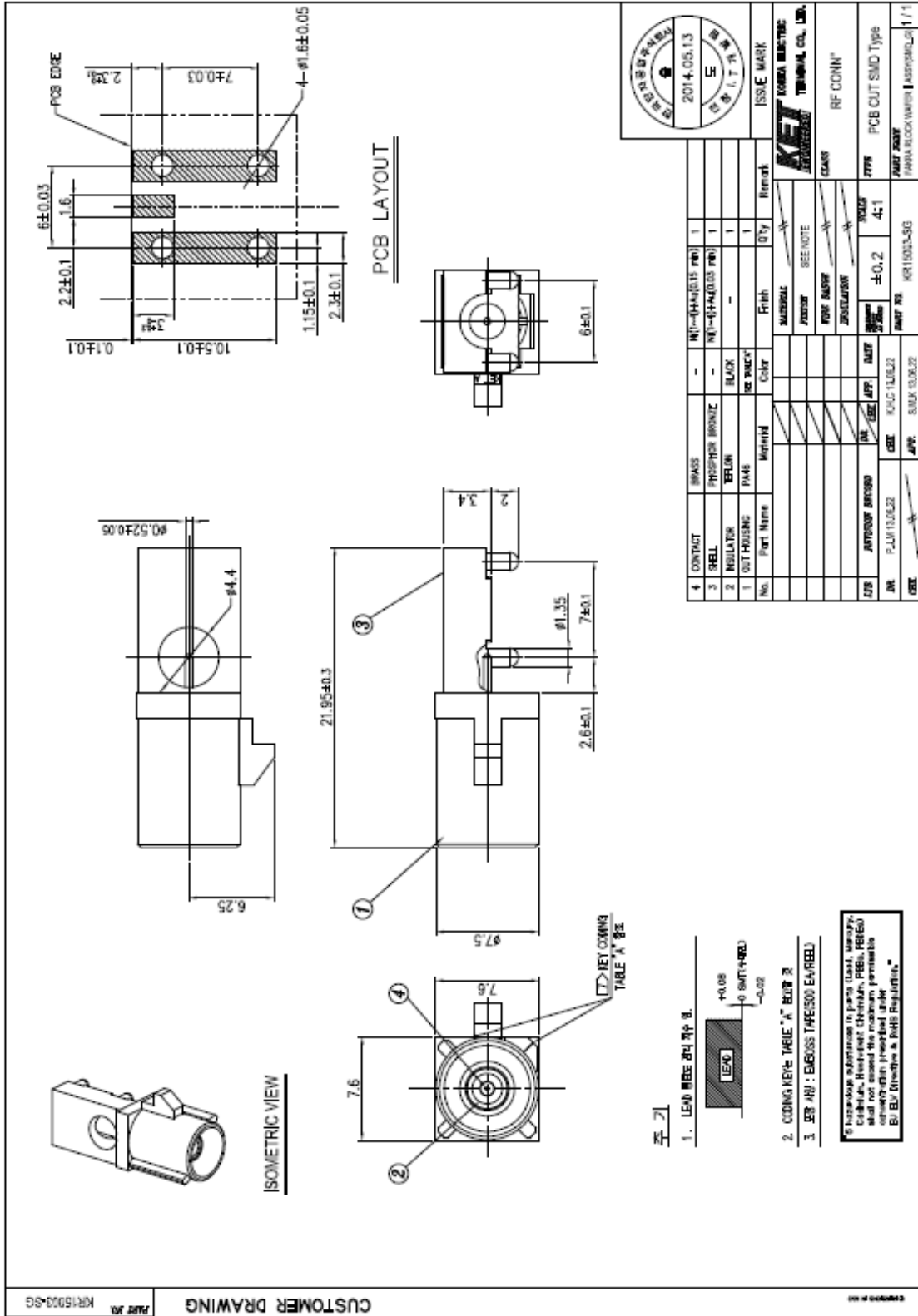

8. Connector

8.3 40Pin Connector : KM17E-40DS (Vendor : HIROSE)

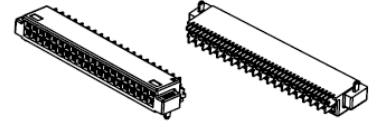
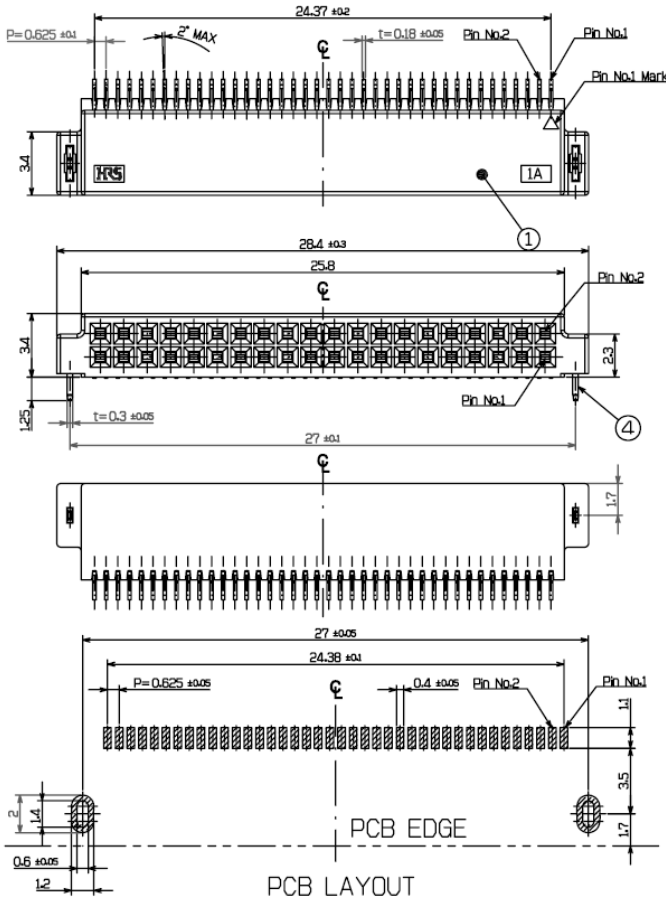

Isometric view

주 기

1. 유타한 Burr, 거스러미는 0.1 이하로 할 것.
2. 제조규격은 이경외 같다.
3. 도금시약은 희기와 같이 할 것.
 - ① SMT부 평탄도 : 0.12mm 이하
4. 다음과 같은 경우에는 기술 연구소의 승인을 요한다.
 - a. 각 부품업체에서 제작된 양산 승인전의 견본에 대하여.
 - b. 기 승인된 양산 제품의 설계 구성 부품 또는 공정상의 어떠한 변경을 요할시.

9. RFx Information

The RF field strength of the wireless module or modules that may be embedded in your TCU is well all international RF exposure limits as known at this time. Because the wireless modules(which may be embedded into your TCU) emit less energy than is allowed in radio frequency safety standards and recommendations, manufacturer believes these modules are safe for use.

Regardless of the power levels, care should be taken to minimize human contact during normal operation. This module should be used more than 20cm(8 inches) from the body when wireless devices are on and transmitting.

This transmitter must not be collocated or operate in conjunction with any other antenna or transmitter. Operation is subject to the following two conditions: (1) this module may not cause interference , (2) this module must accept any interference that may cause undesired operation.

10.1 Information for integrator

The integrator has to be aware not to provide information to the end user regarding how to install or remove this RF module in the user manual of the end product. The user manual which is provided by integrators for end users must include the following information in a prominent location. To comply with FCC RF exposure compliance requirements, the antenna used for this transmitter must be installed to provide a separation distance of at least 20cm from all persons and must not be collocated or operating in conjunction with any other antenna or transmitter. Label for end product must include contains FCC ID : YZP-VL1000 or A RF transmitter inside, FCC ID : YZP-VL1000

10. FCC Approval

This Module complies with parts 22, 24, 27 of the FCC rules.

This device complies with FCC radiation exposure limits set forth for an uncontrolled environment.

This module should be installed and operated with minimum distance 20cm between the radiating element of this device and the user.

This module may not be co-located with any other transmitters or antennas. To comply with FCC regulations limiting both maximum RF output power and human exposure to RF radiation, the maximum antenna gain including cable loss in a mobile-only exposure condition must not exceed the table below.

Band	Frequency Range [MHz]	Maximum Antenna Gain[dBi]
CDMA(Cellular)	824.70~848.31	5.50
CDMA(PCS)	1851.25~1908.75	7.00
LTE(B13)	779.50~874.50	5.31
LTE(B4)	1710.70~1754.30	4.29

To satisfy FCC exterior labeling requirements, the following text must be placed on the exterior of the end product.

Contains Transmitter module FCC ID: YZP-VL1000

Changes or modifications to this equipment may cause harmful interference unless the modifications are expressly approved in the instruction manual. The user could lose the authority to operate this equipment if an unauthorized change or codification is made.

Note: If this module is intended for use in a portable device, additional testing will be required to satisfy RF Exposure, including SAR requirements of FCC Part 2.1093.