

# TEST REPORT

of

FCC Part 15 Subpart C §15.209

FCC ID : YZP-PWMAW637C

Equipment Under Test : Wireless Charger  
Model Name : PWMA-W637C  
Applicant : LG Innotek Co., Ltd.  
Manufacturer : LG Innotek Yantai Co., Ltd.  
Date of Receipt : 2017.02.06  
Date of Test(s) : 2017.03.03 ~ 2017.03.14  
Date of Issue : 2017.03.23

In the configuration tested, the EUT complied with the standards specified above.

Tested By:

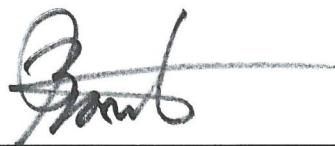

Brant Jang

Date:

2017.03.23

Technical  
Manager:



Hyunchoe You

Date:

2017.03.23

*The results shown in this test report refer only to the sample(s) tested unless otherwise stated. This test report cannot be reproduced, except in full, without prior written permission of the Company.*

SGS Korea Co., Ltd. (Gunpo Laboratory) 4, LS-ro 182beon-gil, Gunpo-si, Gyeonggi-do, Korea, 15807 <http://www.sgsgroup.kr>

## Table of contents

1. General information -----	3
2. Field Strength of Fundamental and Spurious Emission -----	7
3. 20 dB Bandwidth -----	40
4. Transmitter AC Power Line Conducted Emission -----	43

---

*The results shown in this test report refer only to the sample(s) tested unless otherwise stated. This test report cannot be reproduced, except in full, without prior written permission of the Company.*

## 1. General information

### 1.1. Testing laboratory

SGS Korea Co., Ltd. (Gunpo Laboratory)

- Wireless Div. 2FL, 10-2, LS-ro 182beon-gil, Gunpo-si, Gyeonggi-do, Korea, 15807

All SGS services are rendered in accordance with the applicable SGS conditions of service available on request and accessible at <http://www.sgs.com/en/Terms-and-Conditions.aspx>.

Phone No. : +82 31 688 0901

Fax No. : +82 31 688 0921

### 1.2. Details of applicant

Applicant : LG Innotek Co., Ltd.

Address : 26, Hanamsandan 5beon-ro, Gwangsan-gu, Gwangju, 62229, Korea

Contact Person : Yoon, Dong-Hyun

Phone No. : +82 10 8643 2099

### 1.3. Description of EUT

<b>Kind of Product</b>	Wireless Charger
<b>Model Name</b>	PWMA-W637C
<b>Power Supply</b>	DC 12.0 V
<b>Frequency Range</b>	5W: 111 kHz ~ 135 kHz 15W: 111 kHz ~ 125 kHz
<b>Antenna Type</b>	Inductive loop coil antenna
<b>Operating Temperature</b>	0 °C ~ 40 °C
<b>H/W Version</b>	1.0
<b>S/W Version</b>	1.0

*The results shown in this test report refer only to the sample(s) tested unless otherwise stated. This test report cannot be reproduced, except in full, without prior written permission of the Company.*

**SGS Korea Co., Ltd. (Gunpo Laboratory)** 4, LS-ro 182beon-gil, Gunpo-si, Gyeonggi-do, Korea, 15807 <http://www.sgsgroup.kr>

## 1.4. Test Equipment List

Equipment	Manufacturer	Model	S/N	Cal. Date	Cal. Interval	Cal. Due
Spectrum Analyzer	R&S	FSV30	103102	Jun. 08, 2016	Annual	Jun. 08, 2017
Signal Generator	R&S	SMBV100A	255834	Jun. 20, 2016	Annual	Jun. 20, 2017
DC Power Supply	R&S	HMP2020	019922876	Apr. 26, 2016	Annual	Apr. 26, 2017
Test Receiver	R&S	ESU26	100109	Feb. 17, 2017	Annual	Feb. 17, 2018
Loop Antenna	Schwarzbeck Mess-Elektronik	FMZB 1519	1519-039	Aug. 19, 2015	Biennial	Aug. 19, 2017
Turn Table	Innco systems GmbH	DS 1200 S	N/A	N.C.R.	N/A	N.C.R.
Controller	Innco systems GmbH	CONTROLLER CO3000-4P	CO3000/963/38330516/L	N.C.R.	N/A	N.C.R.
Anechoic Chamber	SY Corporation	L x W x H (9.6 m x 6.4 m x 6.6 m)	N/A	N.C.R.	N/A	N.C.R.
Shield Room	SY Corporation	L x W x H (6.5 m x 3.5 m x 3.5 m)	N/A	N.C.R.	N/A	N.C.R.
Test Receiver	R&S	ESCI 7	100911	Feb. 22, 2017	Annual	Feb. 22, 2018
Two-Line V-Network	R&S	ENV216	100190	Dec. 21, 2016	Annual	Dec. 21, 2017

### ► Support equipment

Description	Manufacturer	Model	FCC ID
Mobile Cellular Phone	Motorola Mobility, LLC	4079	IHDT56PK2
Test Zigboard	LG Innotek Co., Ltd	-	-

## 1.5. Sample calculation

Where relevant, the following sample calculation is provided:

Field strength level (dB $\mu$ V/m) = Measured level (dB $\mu$ V) + Antenna factor (dB) + Cable loss (dB)

*The results shown in this test report refer only to the sample(s) tested unless otherwise stated. This test report cannot be reproduced, except in full, without prior written permission of the Company.*

**SGS Korea Co., Ltd. (Gunpo Laboratory)** 4, LS-ro 182beon-gil, Gunpo-si, Gyeonggi-do, Korea, 15807 <http://www.sgsgroup.kr>

### 1.6. Worst case of test configurations

In order to check all kinds of possible configurations, EUT was evaluated with appropriate client and under each charging condition as below table.

EUT configuration	Description
Charging Mode with client device (Model : 4079 FCC ID : IHDT56PK2)	Less than 1 % of battery
	Less than 50 % of battery
	100 % full charging of battery
Charging Mode With Zigboard	Operating Mode: 5W
	Operating Mode: 15W

#### EUT setup configuration:

- The EUT can be capable of charging one client at a time.
- The measurement is performed with a typical WPT client device on the power transfer zone.

#### Operating configurations:

Client device

- While the wireless charger is charging with the client device turned off. (Trace#1 "M1")
  - While the client device was in airplane mode (Trace#2 "M2")
  - While the client device was connected to an active data connection (Trace#3 "M3")
- The device was tested under all modes and bands like WLAN and Bluetooth. In the result, **airplane mode** was found.

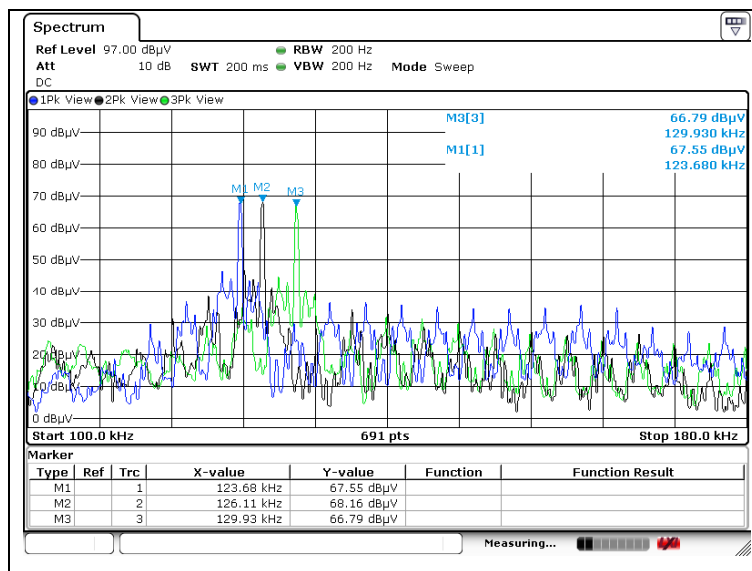

Plot – fundamental emission comparison

- The level of Trace#2 was higher than Trace#1 and 3. So Trace#2 was selected.
- Trace#2 as **airplane mode** which was found should be tested with the client device as a worst case.

The results shown in this test report refer only to the sample(s) tested unless otherwise stated. This test report cannot be reproduced, except in full, without prior written permission of the Company.

## 1.7. Summary of Test Results

The EUT has been tested according to the following specifications:

APPLIED STANDARD: FCC Part 15 Subpart C §15.209		
Section in FCC Part 15 Subpart C	Test Item	Result
15.209	Radiated emission, Spurious Emission and Field Strength of Fundamental	Complied
2.1049	20 dB Bandwidth	Complied
15.207	Transmitter AC Power Line Conducted Emission	Complied

## 1.8. Test Report Revision

Revision	Report number	Date of Issue	Description
0	F690501/RF-RTL010954	2017.03.23	Initial

*The results shown in this test report refer only to the sample(s) tested unless otherwise stated. This test report cannot be reproduced, except in full, without prior written permission of the Company.*

## 2. Field Strength of Fundamental and Spurious Emission

### 2.1. Test Setup

The diagram below shows the test setup that is utilized to make the measurements for emission from 9 kHz to 30 MHz Emissions.

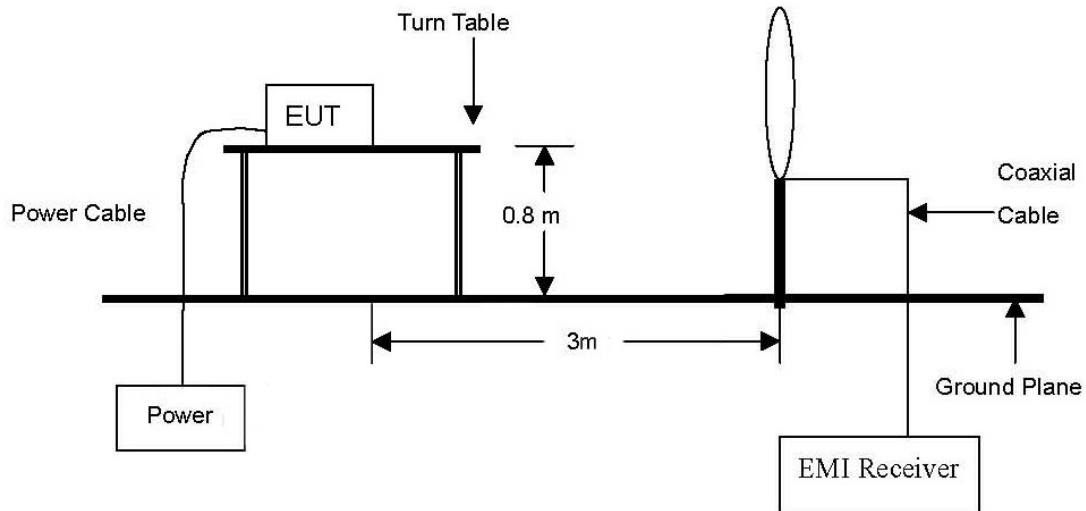

### 2.2. Limit

#### 2.2.1. Radiated emission limits, general requirements

According to §15.209 (a), except as provided elsewhere in this subpart, the emissions from an intentional radiator shall not exceed the field strength levels specified in the following table:

Frequency (MHz)	Field Strength (microvolts/meter)	Measurement Distance (meter)
0.009 - 0.490	2 400/F(kHz)	300
0.490 - 1.705	24 000/F(kHz)	30
1.705 - 30.0	30	30
30 - 88	100**	3
88 - 216	150**	3
216 - 960	200**	3
Above 960	500	3

\*\* Except as provided in paragraph (g), fundamental emissions from intentional radiators operating under this Section shall not be located in the frequency bands 54-72 MHz, 76-88 MHz, 174-216 MHz or 470-806 MHz. However, operation within these frequency bands is permitted under other sections of this Part, e.g., Sections §15.231 and §15.241

*The results shown in this test report refer only to the sample(s) tested unless otherwise stated. This test report cannot be reproduced, except in full, without prior written permission of the Company.*

## 2.3. Test Procedures

Radiated emissions from the EUT were measured according to the dictates of ANSI C63.10:2013.

### 2.3.1. Test Procedures for emission from 9 kHz to 30 MHz

- a. The EUT was placed on the top of a rotating table 0.8 meters above the ground at a 3 meter anechoic chamber test site. The table was rotated 360 degrees to determine the position of the highest radiation.
- b. Then antenna is a loop antenna is fixed at one meter above the ground to determine the maximum value of the field strength. Both parallel and perpendicular of the antenna are set to make the measurement.
- c. For each suspected emission, the EUT was arranged to its worst case and then the table was turned from 0 degrees to 360 degrees to find the maximum reading.
- d. The test-receiver system was set to Peak Detect Function and Specified Bandwidth with Maximum Hold Mode.

#### Note;

Although these tests were performed other than open field test site, adequate comparison measurements were confirmed against 30 meter open field test site. Therefore sufficient tests were made to demonstrate that the alternative site produces results that correlate with the ones of tests made in an open field based on KDB 937606.

---

*The results shown in this test report refer only to the sample(s) tested unless otherwise stated. This test report cannot be reproduced, except in full, without prior written permission of the Company.*

**SGS Korea Co., Ltd. (Gunpo Laboratory)** 4, LS-ro 182beon-gil, Gunpo-si, Gyeonggi-do, Korea, 15807 <http://www.sgsgroup.kr>



## 2.4. Field Strength of Fundamental Test Result

Ambient temperature : (23 ± 1) °C  
 Relative humidity : 47 % R.H.

The following table shows the highest levels of radiated emissions on both polarizations of horizontal and vertical. The field strength of spurious emission was measured in one orthogonal EUT position (x-axis). Definition of DUT for a orthogonal plane was described in the test setup photo.

Radiated Emissions			Ant.	Correction Factors		Total		Limit	
Frequency (MHz)	Reading (dB $\mu$ V)	Detect Mode	Pol.	Ant. (dB/m)	Cable (dB)	Actual (dB $\mu$ V/m) at 3 m	Actual (dB $\mu$ V/m) at 300 m	Limit (dB $\mu$ V/m) at 300 m	Margin (dB)
Charging mode with client device (less than 1 % battery status)									
0.121	59.10	Average	H	19.45	0.06	78.61	-1.39	25.95	27.34
Charging mode with client device (less than 50 % battery status)									
0.128	56.40	Average	H	19.43	0.06	75.89	-4.11	25.46	29.57
Charging mode with client device (100 % battery status)									
0.120	62.70	Average	H	19.45	0.06	82.21	2.21	26.02	23.81
Charging mode with Zigboard (5W)									
0.125	58.80	Average	H	19.44	0.06	78.30	-1.70	25.67	27.37
Charging mode with Zigboard (15W)									
0.120	57.80	Average	H	19.45	0.06	77.31	-2.69	26.02	28.71

### Note;

1. According to §15.31 (f)(2) 300 m Result(dB $\mu$ V/m) = 3 m Result(dB $\mu$ V/m) - 40log(300/3) (dB $\mu$ V/m).
2. According to §15.209 (d), the measurements were tested by using Quasi peak detector except for the frequency bands 9 – 90 kHz, 110 – 490 kHz and above 1 GHz in these three bands on measurements employing an average detector.
3. The limit above was calculated based on table of §15.209 (a).
4. Zigboard (5W) is same as client device.

*The results shown in this test report refer only to the sample(s) tested unless otherwise stated. This test report cannot be reproduced, except in full, without prior written permission of the Company.*

## Test plots

Charging mode (less than 1 % battery status of client device)

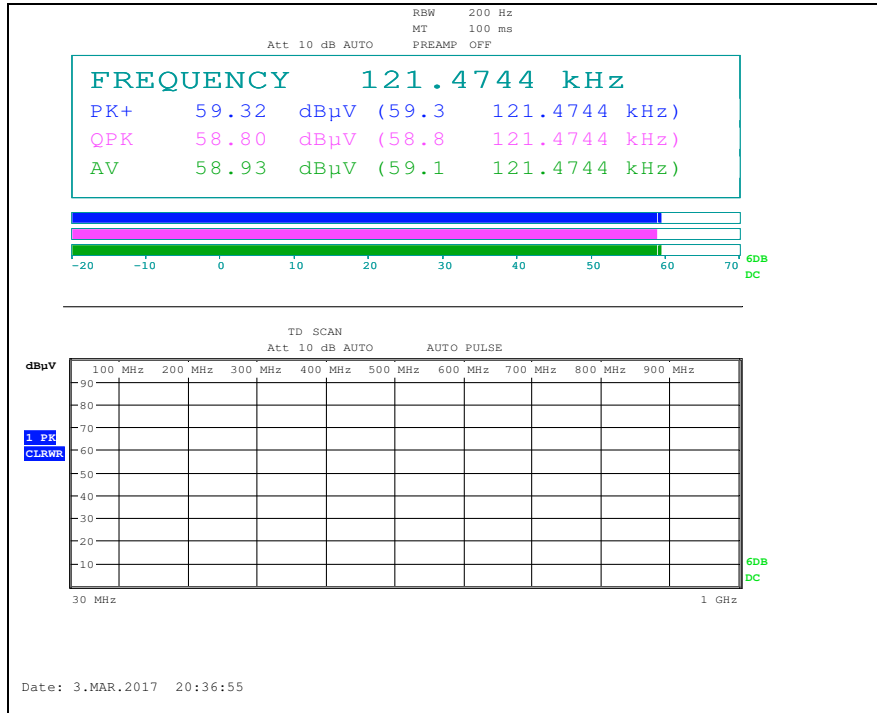

Charging mode (less than 50 % battery status of client device)

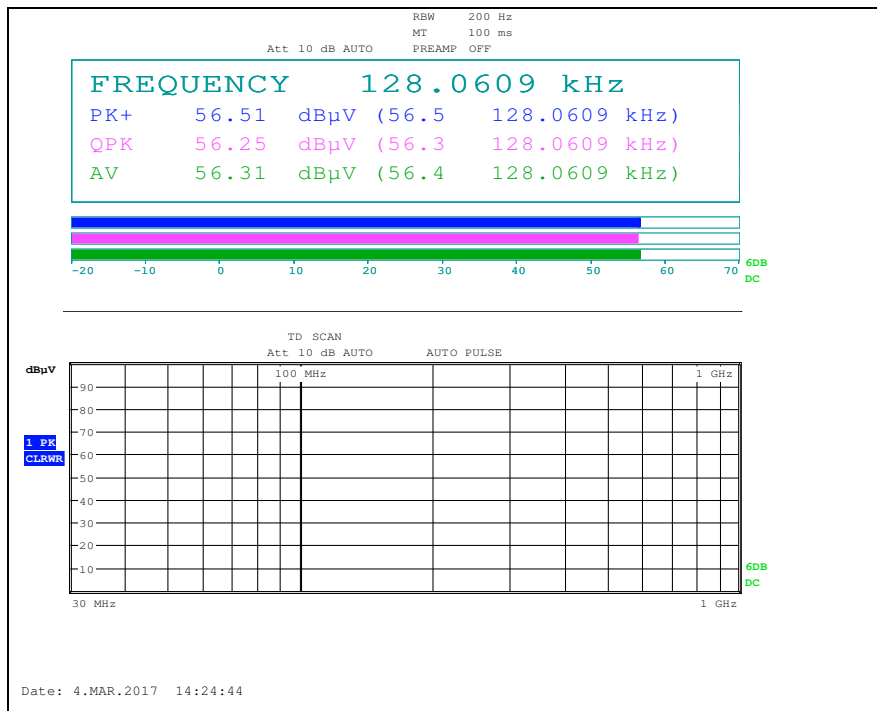

The results shown in this test report refer only to the sample(s) tested unless otherwise stated. This test report cannot be reproduced, except in full, without prior written permission of the Company.

Charging mode (100 % battery status of client device)

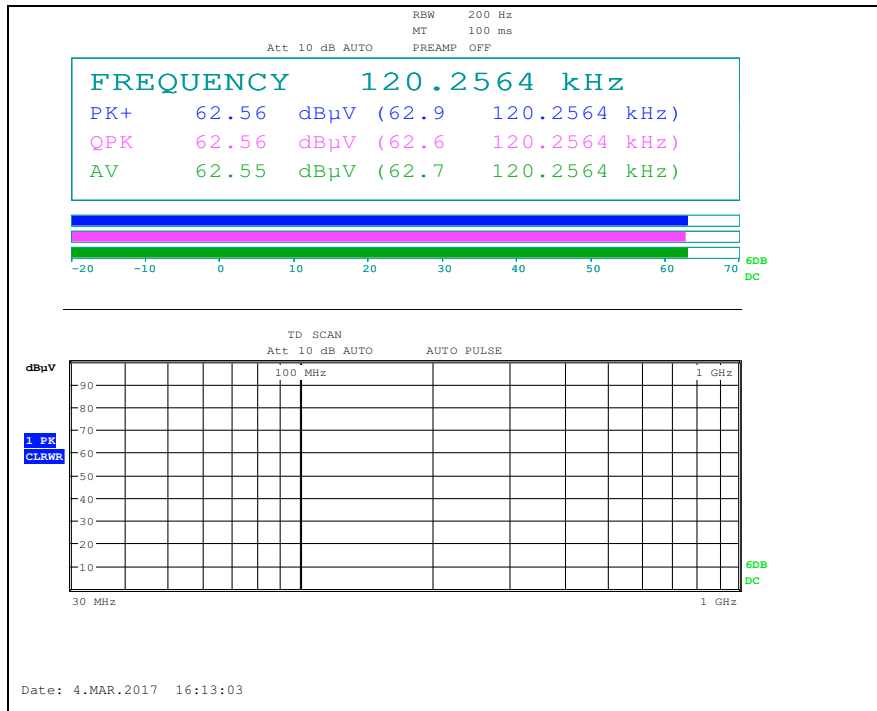

Charging mode (5W Zigboard)

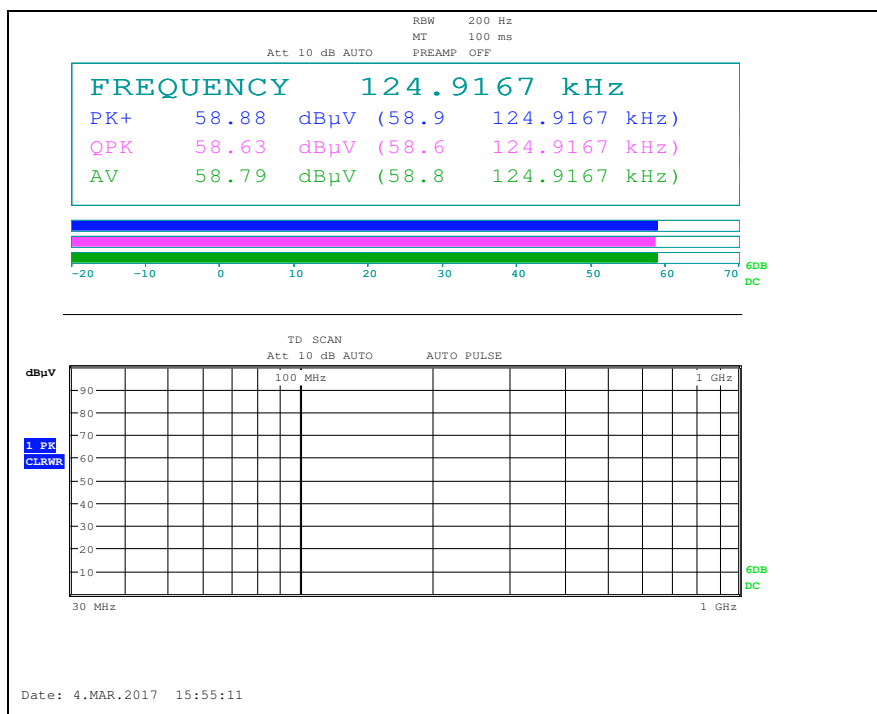

The results shown in this test report refer only to the sample(s) tested unless otherwise stated. This test report cannot be reproduced, except in full, without prior written permission of the Company.

Charging mode (15W Zigboard)

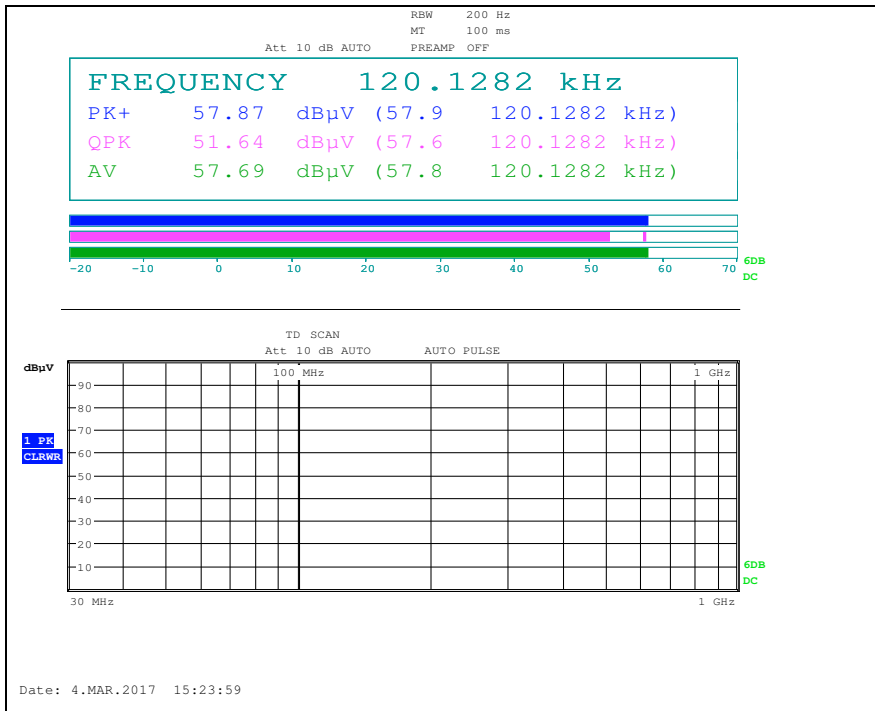

The results shown in this test report refer only to the sample(s) tested unless otherwise stated. This test report cannot be reproduced, except in full, without prior written permission of the Company.

## 2.5. Spurious Emission Test Result

Ambient temperature : (23 ± 1) °C  
 Relative humidity : 47 % R.H.

The following table shows the highest levels of radiated emissions on both polarizations of horizontal and vertical.

### Charging mode with client device (less than 1 % battery status)

Radiated Emissions			Ant.	Correction Factors		Total		Limit	
Frequency (MHz)	Reading (dB $\mu$ V)	Detect Mode	Pol.	Ant. (dB/m)	Cable (dB)	Actual (dB $\mu$ V/m) at 3 m	Actual (dB $\mu$ V/m) at 30m or 300 m	Limit (dB $\mu$ V/m) at 30m or 300 m	Margin (dB)
0.019	27.40	Average	H	19.52	0.02	46.94	-33.06	42.03	75.09
0.035	27.10	Average	H	19.30	0.03	46.43	-33.57	36.72	70.29
0.067	19.40	Average	H	19.37	0.03	38.80	-41.20	31.08	72.28
0.139	8.70	Average	H	19.40	0.07	28.17	-51.83	24.74	76.57
0.365	41.20	Average	H	19.03	0.27	60.50	-19.50	16.36	35.86
0.608	32.90	Quasi Peak	H	19.16	0.48	52.54	12.54	31.93	19.39
0.850	27.62	Quasi Peak	H	19.31	0.69	47.62	7.62	29.02	21.40
Above 1.000	Not detected	-	-	-	-	-	-	-	-

### Charging mode with client device (less than 50 % battery status)

Radiated Emissions			Ant.	Correction Factors		Total		Limit	
Frequency (MHz)	Reading (dB $\mu$ V)	Detect Mode	Pol.	Ant. (dB/m)	Cable (dB)	Actual (dB $\mu$ V/m) at 3 m	Actual (dB $\mu$ V/m) at 30m or 300 m	Limit (dB $\mu$ V/m) at 30m or 300 m	Margin (dB)
0.019	34.10	Average	H	19.52	0.02	53.64	-26.36	42.03	68.39
0.047	23.00	Average	H	19.30	0.03	42.33	-37.67	34.16	71.83
0.067	25.60	Average	H	19.37	0.03	45.00	-35.00	31.08	66.08
0.087	13.70	Average	H	19.45	0.04	33.19	-46.81	28.81	75.62
0.384	36.90	Average	H	19.04	0.29	56.23	-23.77	35.92	59.69
0.640	28.20	Quasi Peak	H	19.18	0.51	47.89	7.89	31.48	23.59
2.660	11.20	Quasi Peak	H	19.32	0.50	31.02	-8.98	29.54	38.52
Above 3.000	Not detected	-	-	-	-	-	-	-	-

The results shown in this test report refer only to the sample(s) tested unless otherwise stated. This test report cannot be reproduced, except in full, without prior written permission of the Company.

**Charging mode with client device (100 % battery status)**

Radiated Emissions			Ant.	Correction Factors		Total		Limit	
Frequency (MHz)	Reading (dB $\mu$ V)	Detect Mode	Pol.	Ant. (dB/m)	Cable (dB)	Actual (dB $\mu$ V/m) at 3 m	Actual (dB $\mu$ V/m) at 30m or 300 m	Limit (dB $\mu$ V/m) at 30m or 300 m	Margin (dB)
0.019	34.70	Average	H	19.52	0.02	54.24	-25.76	42.03	67.79
0.047	19.80	Average	H	19.30	0.03	39.13	-40.87	34.16	75.03
0.067	24.30	Average	H	19.37	0.03	43.70	-36.30	31.08	67.38
0.082	11.30	Average	H	19.43	0.04	30.77	-49.23	29.33	78.56
0.361	41.80	Average	H	19.03	0.27	61.10	21.10	36.45	15.35
0.601	32.60	Quasi peak	H	19.16	0.47	52.23	12.23	32.03	19.80
0.840	26.50	Quasi peak	H	19.30	0.68	46.48	6.48	29.12	22.64
2.644	13.20	Quasi peak	H	19.32	0.50	33.02	-6.98	29.54	36.52
Above 3.000	Not detected	-	-	-	-	-	-	-	-

**Charging mode with test zigboard (5W)**

Radiated Emissions			Ant.	Correction Factors		Total		Limit	
Frequency (MHz)	Reading (dB $\mu$ V)	Detect Mode	Pol.	Ant. (dB/m)	Cable (dB)	Actual (dB $\mu$ V/m) at 3 m	Actual (dB $\mu$ V/m) at 30m or 300 m	Limit (dB $\mu$ V/m) at 30m or 300 m	Margin (dB)
0.019	33.00	Average	H	19.52	0.02	52.54	-27.46	42.03	69.49
0.035	22.00	Average	H	19.30	0.03	41.33	-38.67	36.72	75.39
0.047	23.80	Average	H	19.30	0.03	43.13	-36.87	34.16	71.03
0.067	25.41	Average	H	19.37	0.03	44.81	-35.19	31.08	66.27
0.374	35.50	Average	H	19.04	0.28	54.82	-25.18	16.15	41.33
0.874	25.51	Quasi peak	H	19.32	0.71	45.54	5.54	28.77	23.23
2.699	11.20	Quasi peak	H	19.32	0.49	31.01	-8.99	29.54	38.53
Above 3.000	Not detected	-	-	-	-	-	-	-	-

The results shown in this test report refer only to the sample(s) tested unless otherwise stated. This test report cannot be reproduced, except in full, without prior written permission of the Company.

**Charging mode with test zigboard (15W)**

Radiated Emissions			Ant.	Correction Factors		Total		Limit	
Frequency (MHz)	Reading (dB $\mu$ V)	Detect Mode	Pol.	Ant. (dB/m)	Cable (dB)	Actual (dB $\mu$ V/m) at 3 m	Actual (dB $\mu$ V/m) at 30m or 300 m	Limit (dB $\mu$ V/m) at 30m or 300 m	Margin (dB)
0.019	32.70	Average	H	19.52	0.02	52.24	-27.76	42.03	69.79
0.046	20.60	Average	H	19.30	0.03	39.93	-40.07	34.35	74.42
0.067	24.80	Average	H	19.37	0.03	44.20	-35.80	31.08	66.88
0.090	10.00	Average	H	19.46	0.04	29.50	-50.50	28.52	79.02
0.240	42.20	Average	H	19.15	0.16	61.51	-18.49	20.00	38.49
0.360	36.93	Average	H	19.03	0.27	56.23	-23.77	16.48	40.25
0.478	32.70	Average	H	19.09	0.37	52.16	-27.84	14.02	41.86
0.718	28.70	Quasi peak	H	19.23	0.58	48.51	8.51	30.48	21.97
Above 1.000	Not detected	-	-	-	-	-	-	-	-

**Note;**

- According to §15.31 (f)(2)
  - 300 m Result(dB $\mu$ V/m) = 3 m Result(dB $\mu$ V/m) - 40log(300/3) (dB $\mu$ V/m)
  - 30 m Result(dB $\mu$ V/m) = 3 m Result(dB $\mu$ V/m) - 40log(30/3) (dB $\mu$ V/m)
- According to field strength table of general requirement in §15.209 (a), field strength limits below 1.705 MHz were calculated as below.
  - 9 kHz to 490 kHz : 20log(2 400 / F (kHz)) at 300 m (dB $\mu$ V/m)
  - 490 kHz to 1 705 kHz : 20log(24 000 / F (kHz)) at 30 m (dB $\mu$ V/m)
- According to §15.209 (d), the measurements were tested by using Quasi peak detector except for the frequency bands 9 – 90 kHz, 110 – 490 kHz and above 1 GHz in these three bands on measurements employing an average detector.

The results shown in this test report refer only to the sample(s) tested unless otherwise stated. This test report cannot be reproduced, except in full, without prior written permission of the Company.

## Test plots

### Below 30 MHz

Charging mode (less than 1 % battery status of client device)

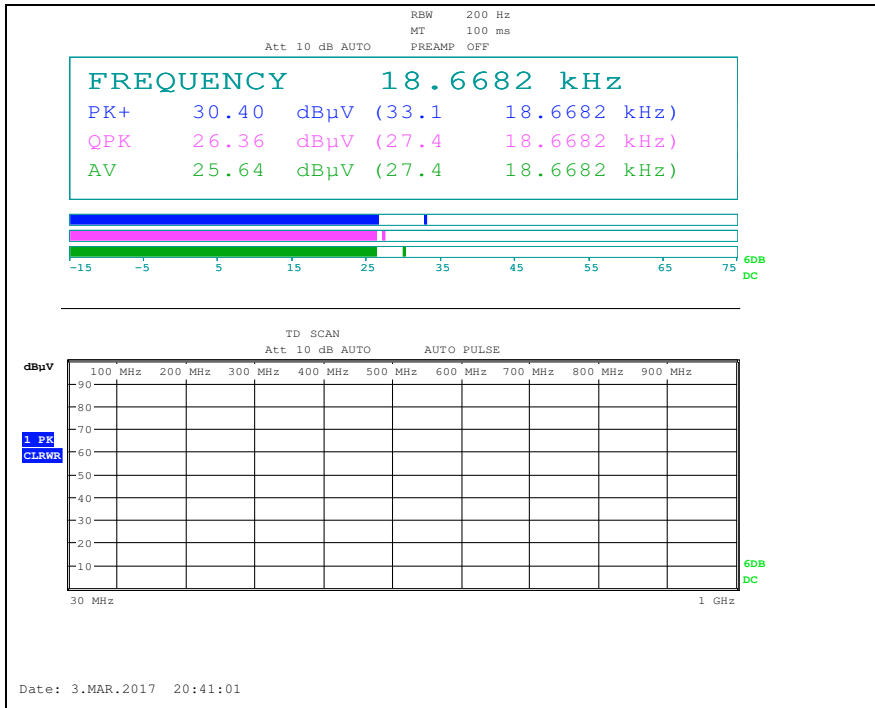
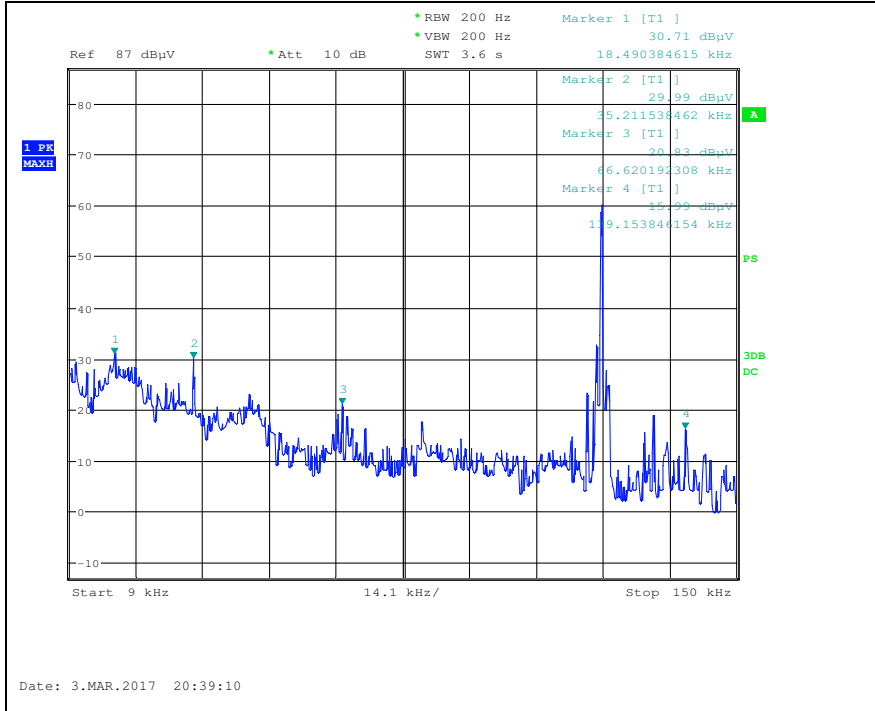

The results shown in this test report refer only to the sample(s) tested unless otherwise stated. This test report cannot be reproduced, except in full, without prior written permission of the Company.



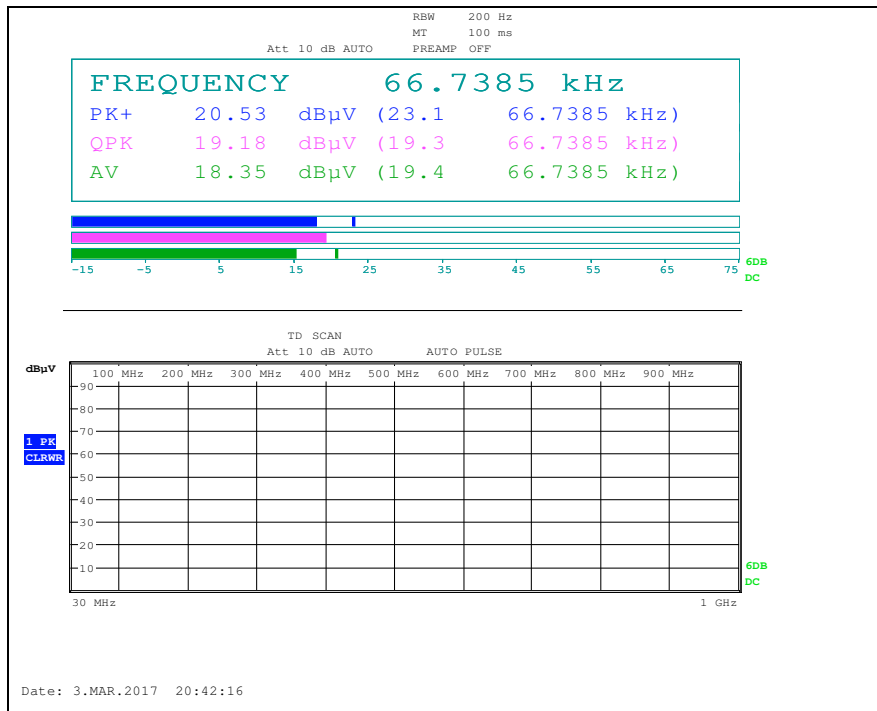
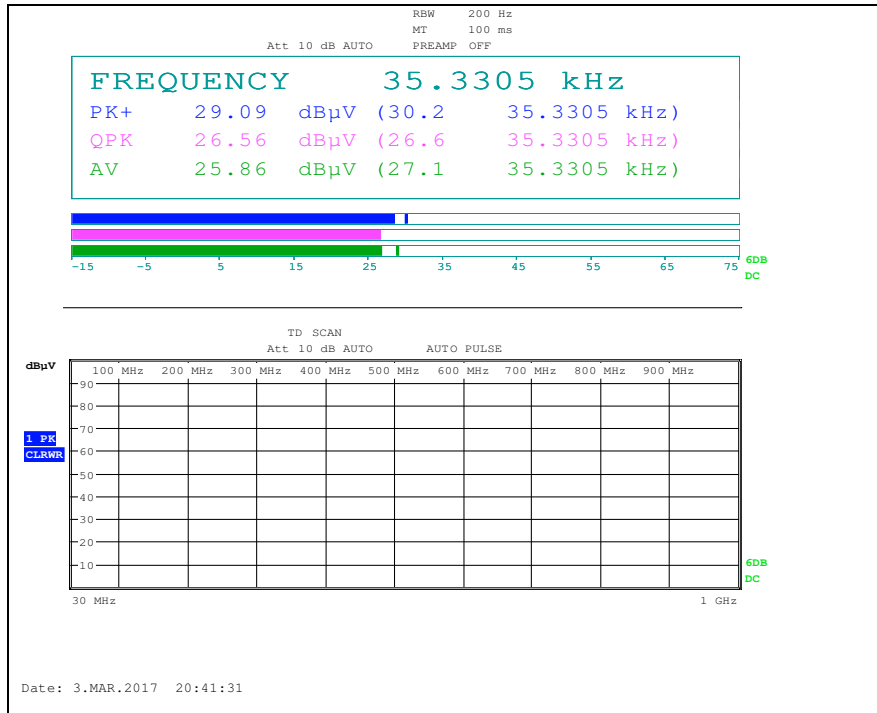

The results shown in this test report refer only to the sample(s) tested unless otherwise stated. This test report cannot be reproduced, except in full, without prior written permission of the Company.

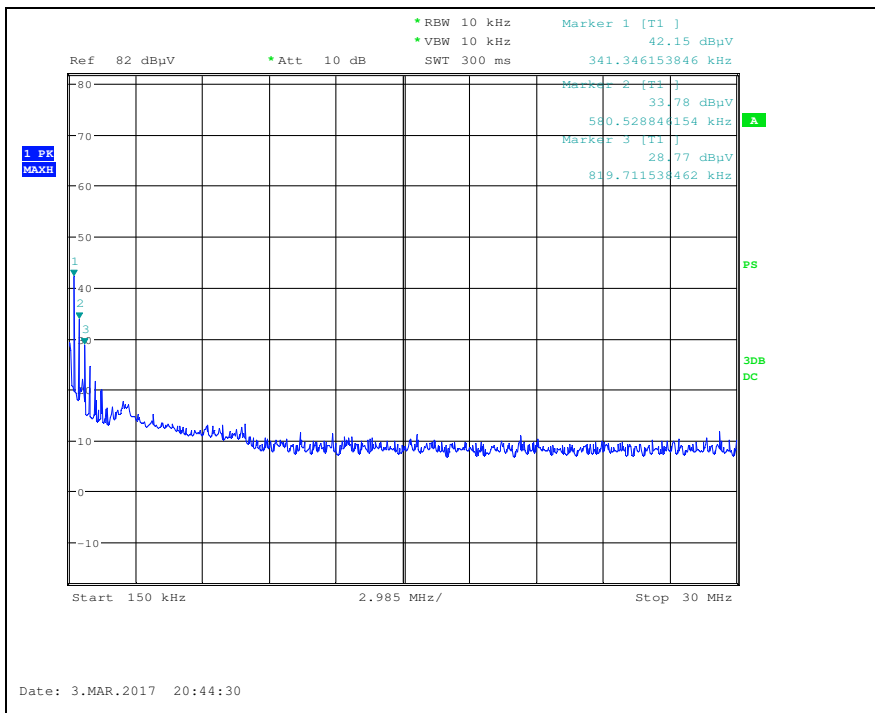
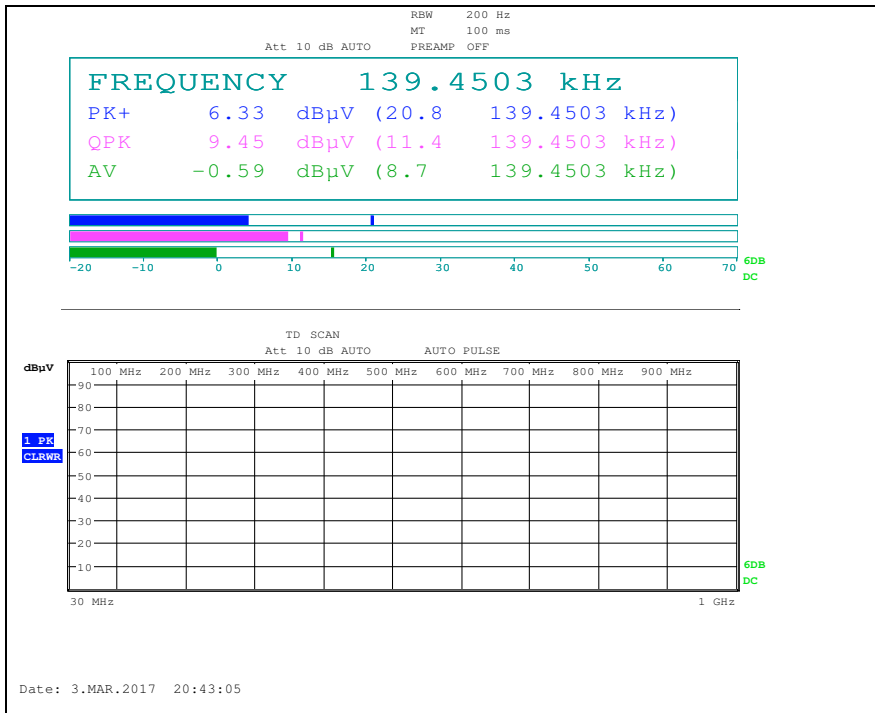

The results shown in this test report refer only to the sample(s) tested unless otherwise stated. This test report cannot be reproduced, except in full, without prior written permission of the Company.

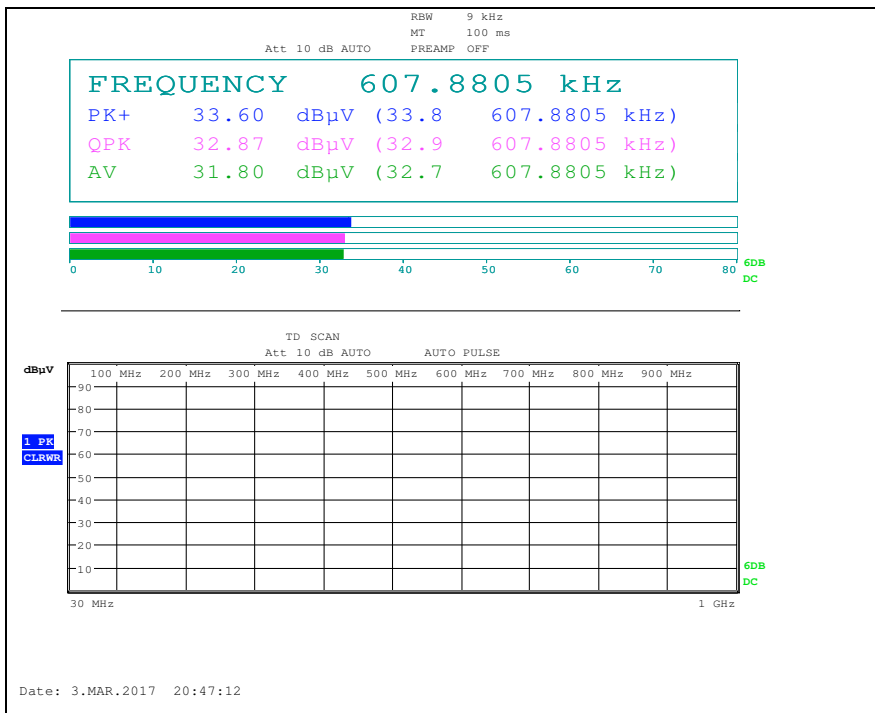
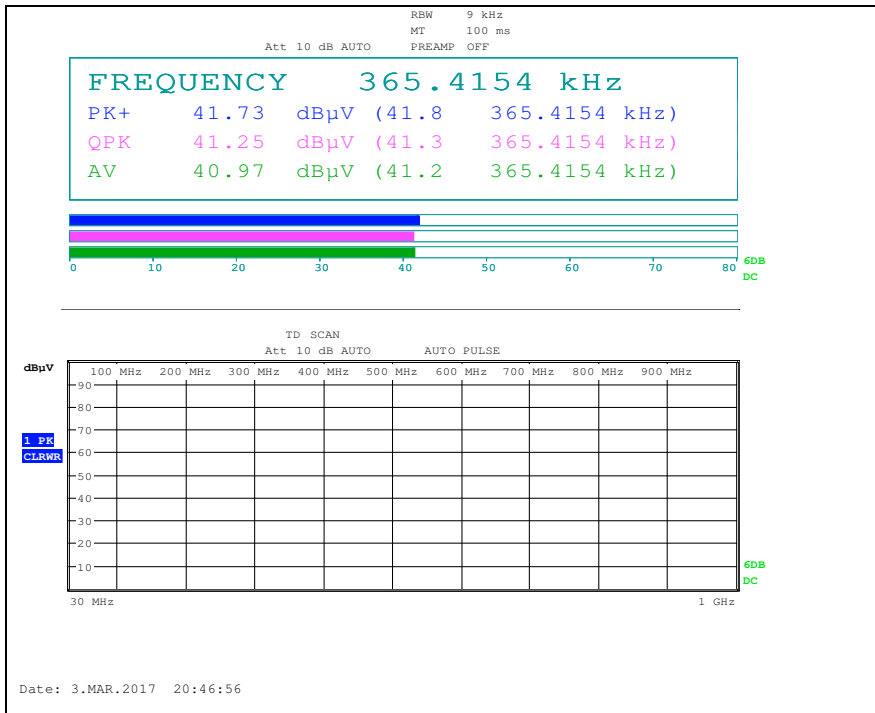

The results shown in this test report refer only to the sample(s) tested unless otherwise stated. This test report cannot be reproduced, except in full, without prior written permission of the Company.

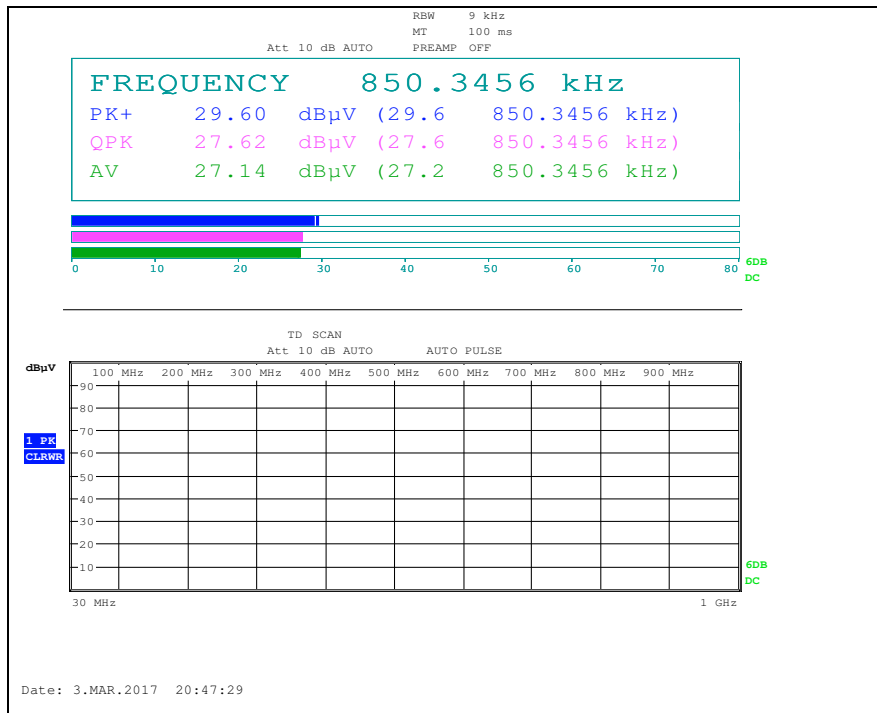

Charging mode (less than 50 % battery status of client device)

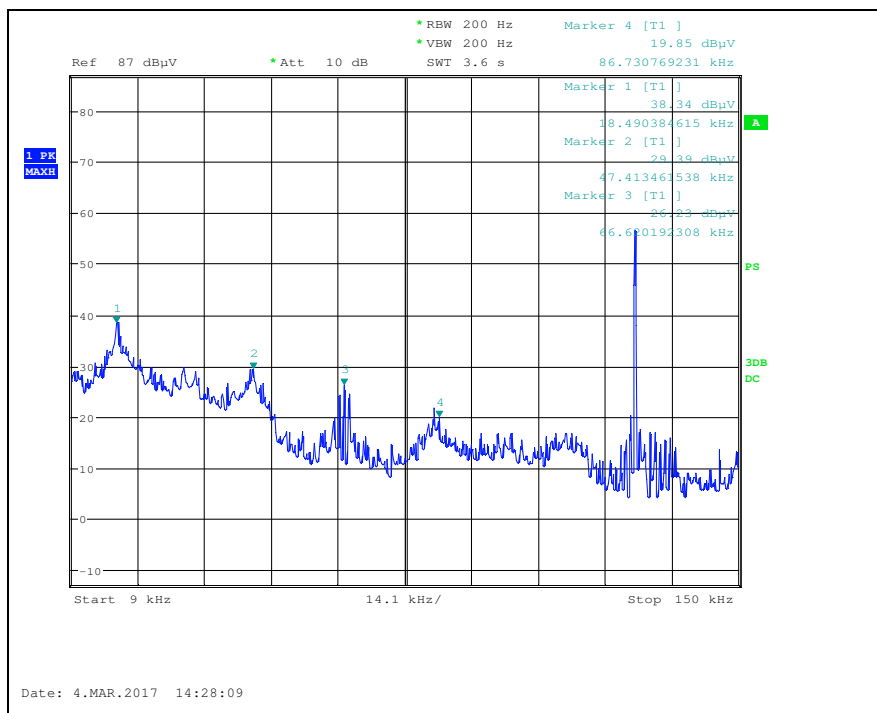

The results shown in this test report refer only to the sample(s) tested unless otherwise stated. This test report cannot be reproduced, except in full, without prior written permission of the Company.

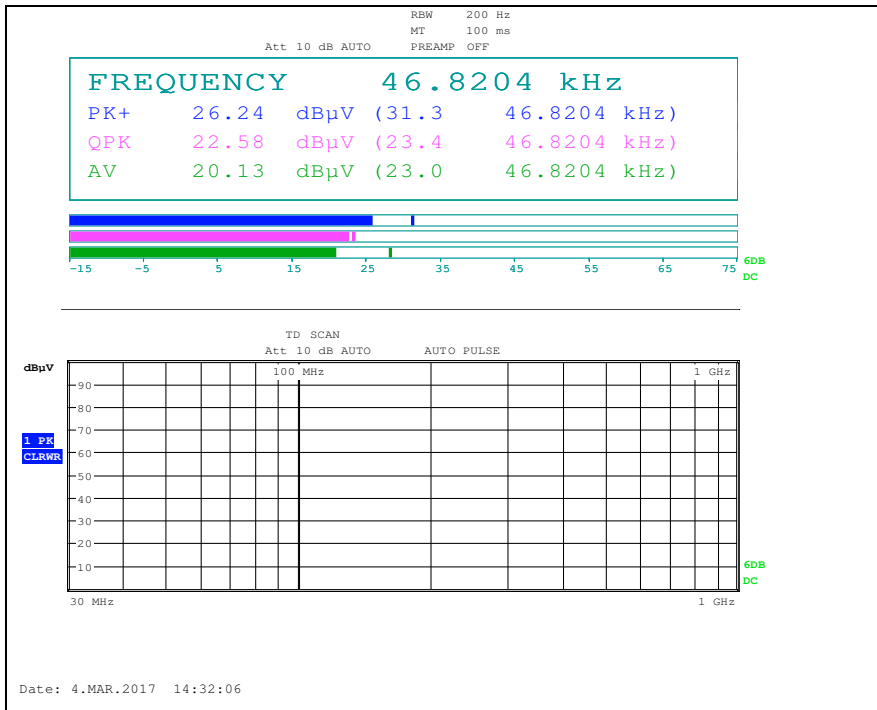
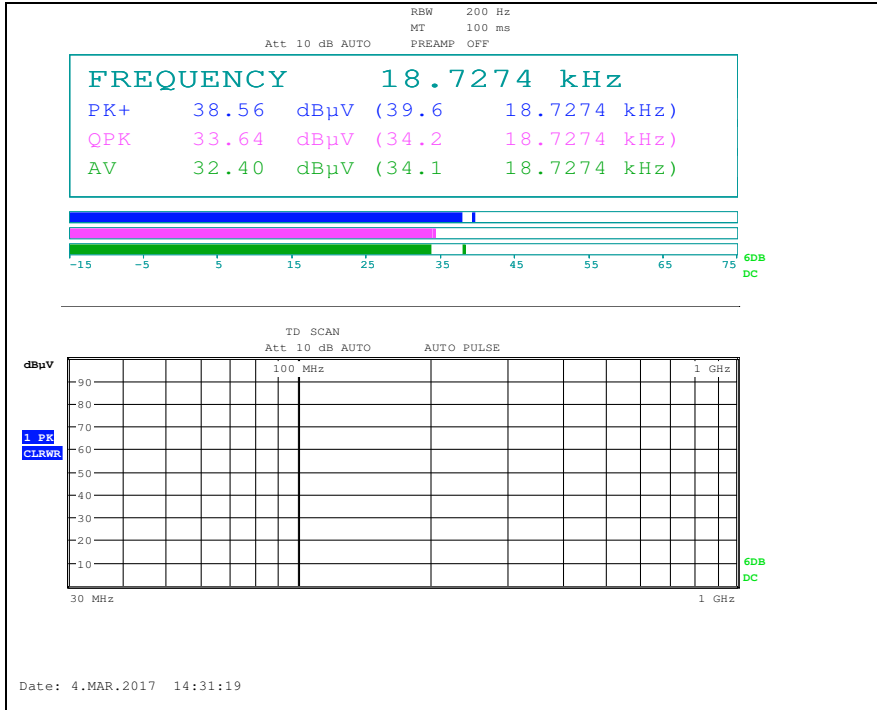

The results shown in this test report refer only to the sample(s) tested unless otherwise stated. This test report cannot be reproduced, except in full, without prior written permission of the Company.

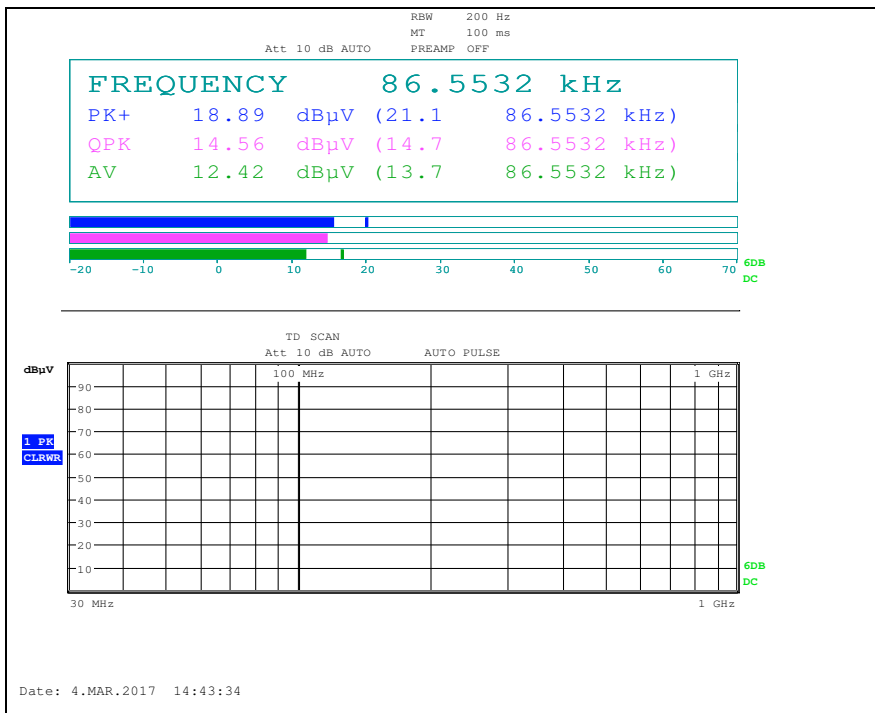
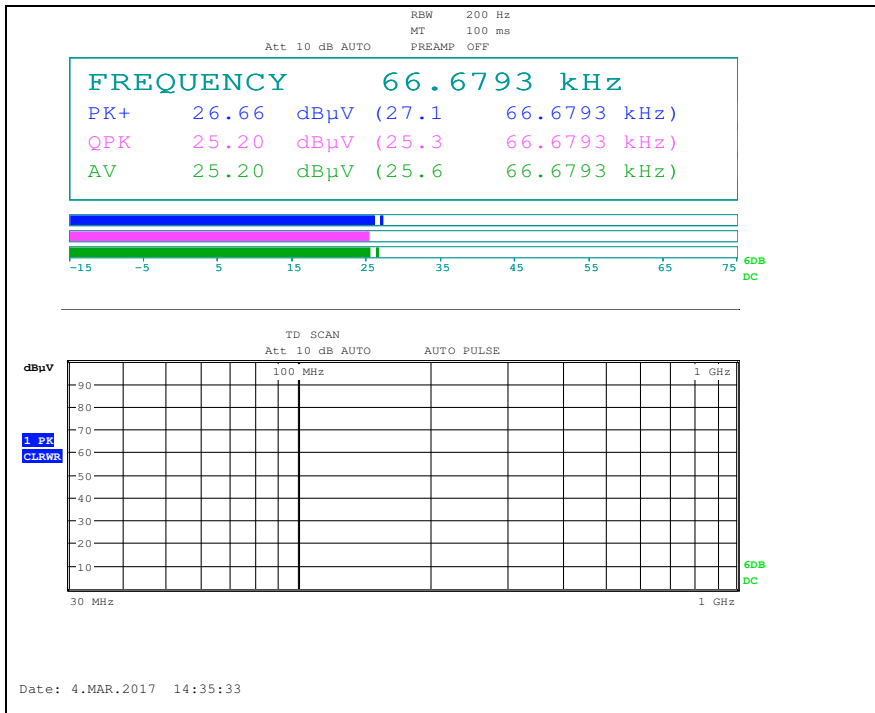

The results shown in this test report refer only to the sample(s) tested unless otherwise stated. This test report cannot be reproduced, except in full, without prior written permission of the Company.

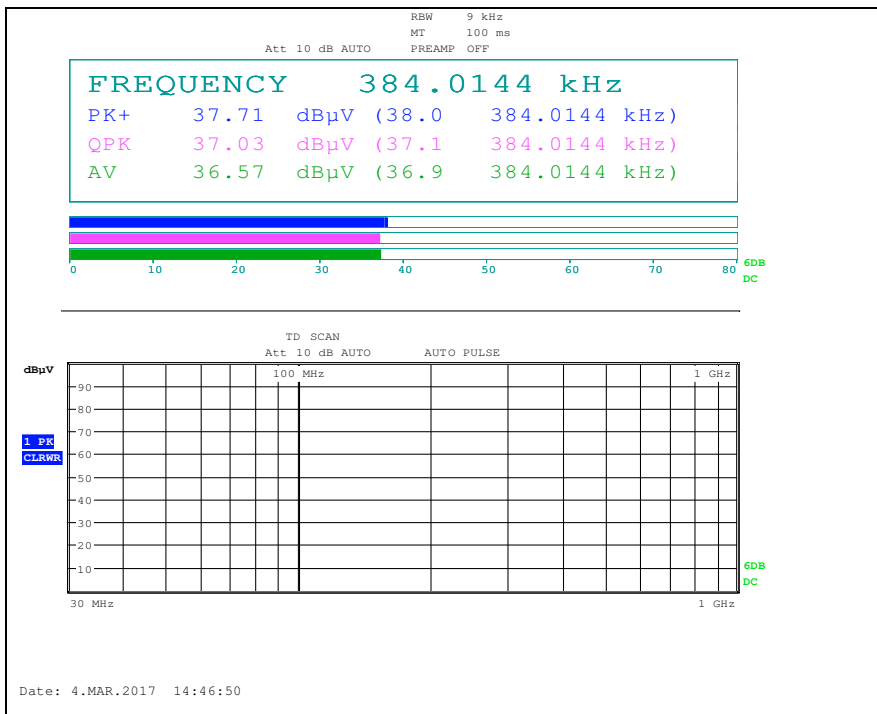
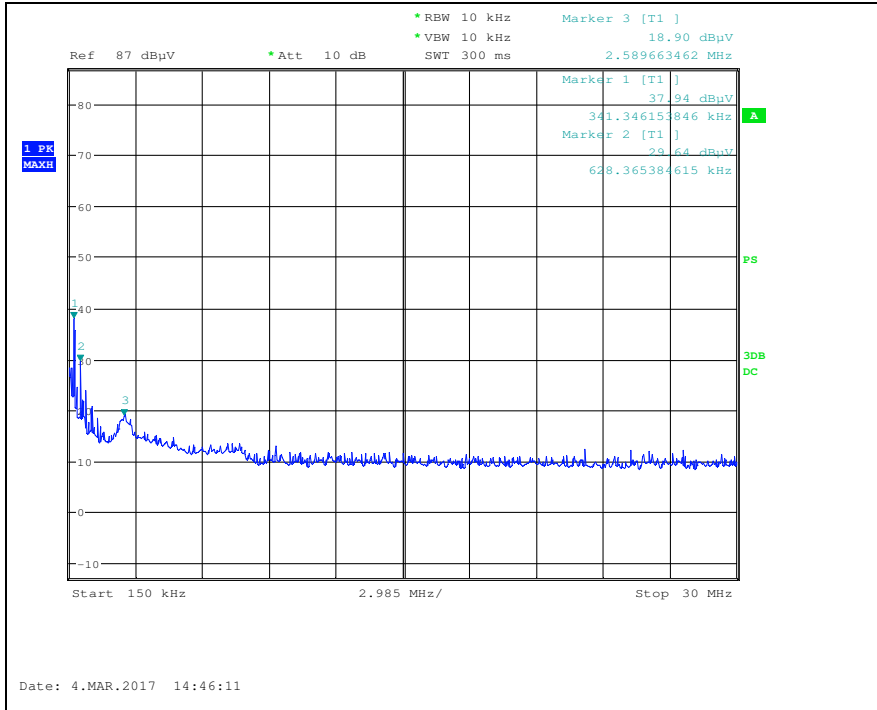

The results shown in this test report refer only to the sample(s) tested unless otherwise stated. This test report cannot be reproduced, except in full, without prior written permission of the Company.

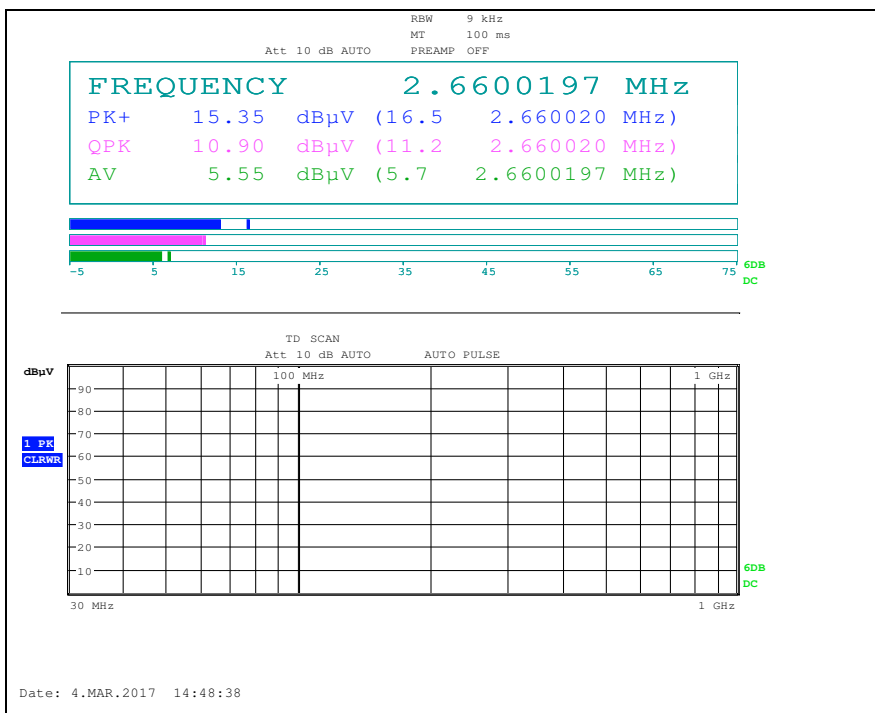
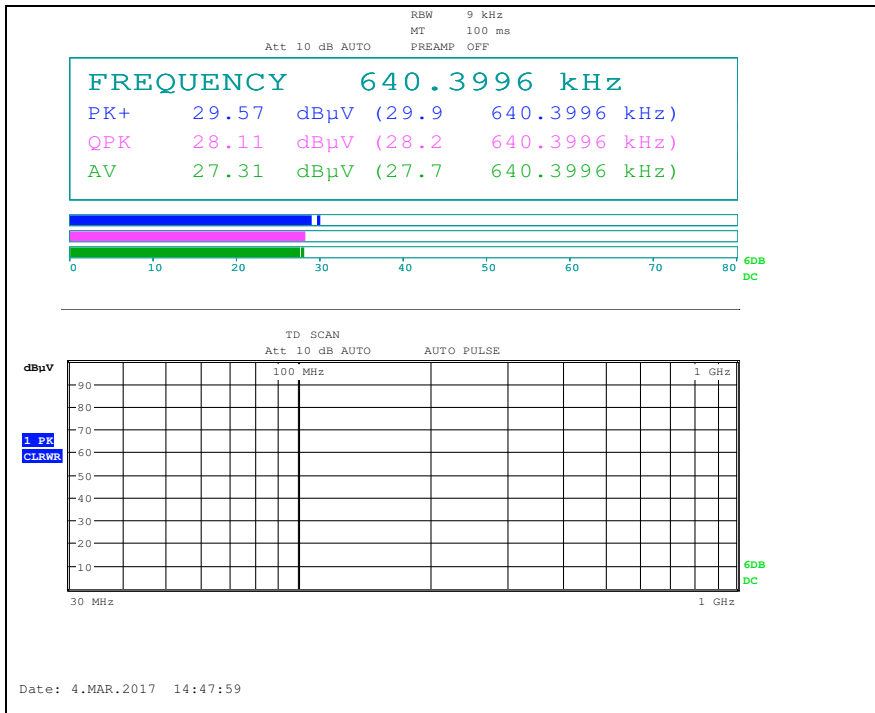

The results shown in this test report refer only to the sample(s) tested unless otherwise stated. This test report cannot be reproduced, except in full, without prior written permission of the Company.



Charging mode (100% battery status of client device)

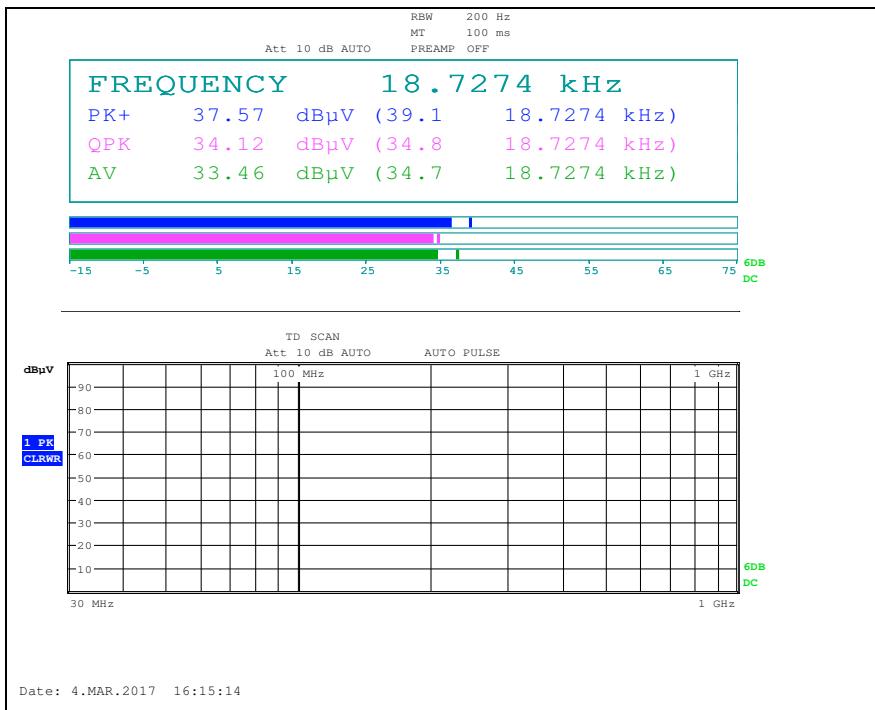
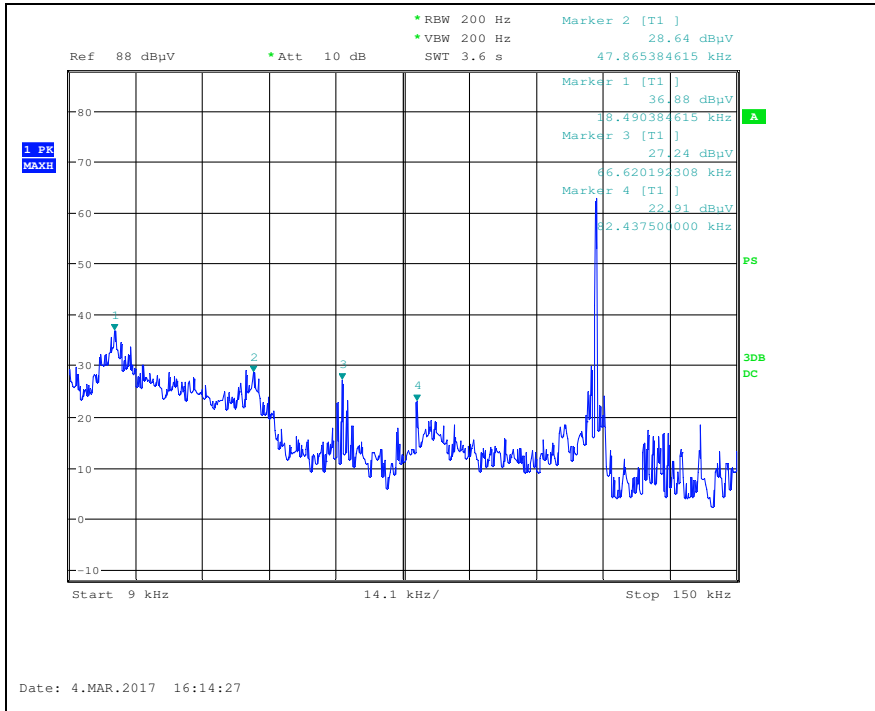

The results shown in this test report refer only to the sample(s) tested unless otherwise stated. This test report cannot be reproduced, except in full, without prior written permission of the Company.

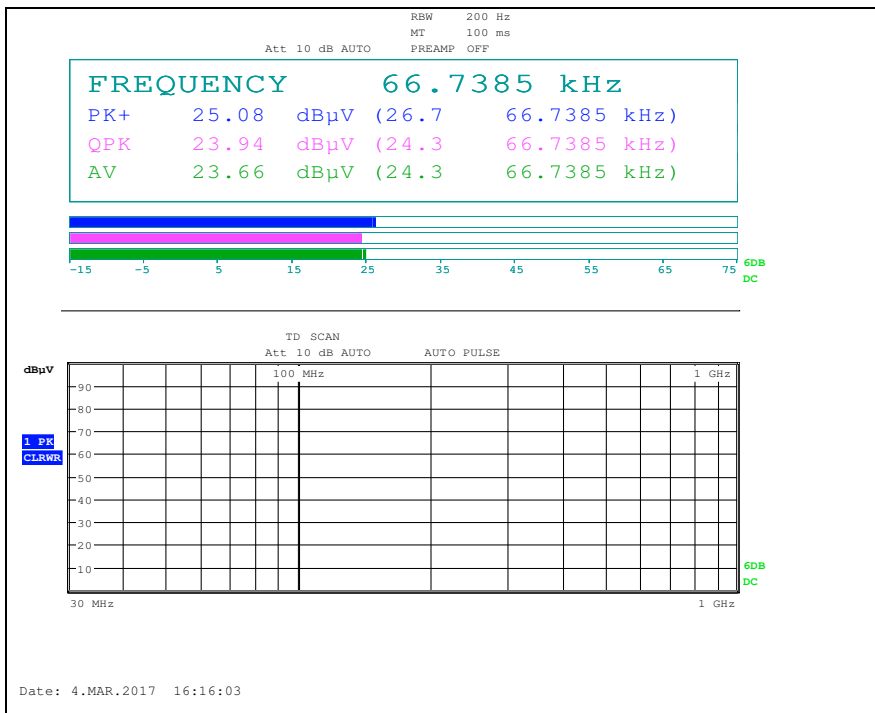
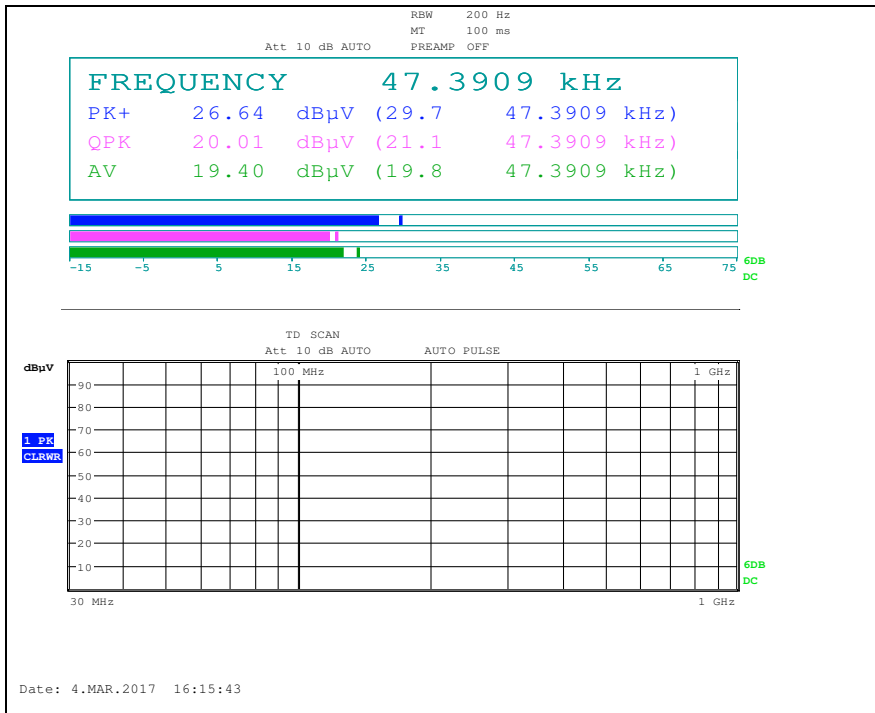

The results shown in this test report refer only to the sample(s) tested unless otherwise stated. This test report cannot be reproduced, except in full, without prior written permission of the Company.

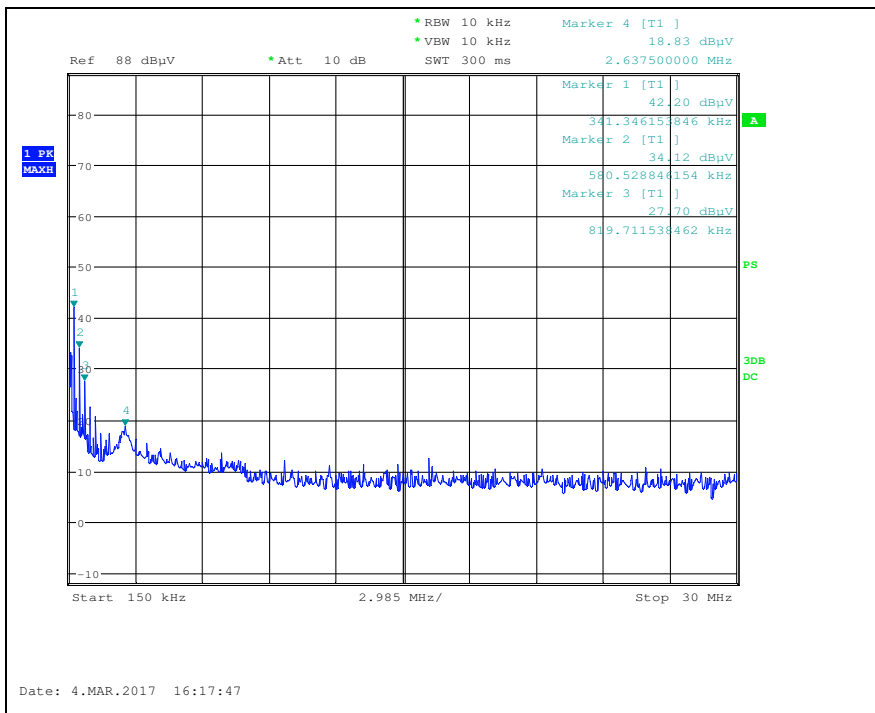
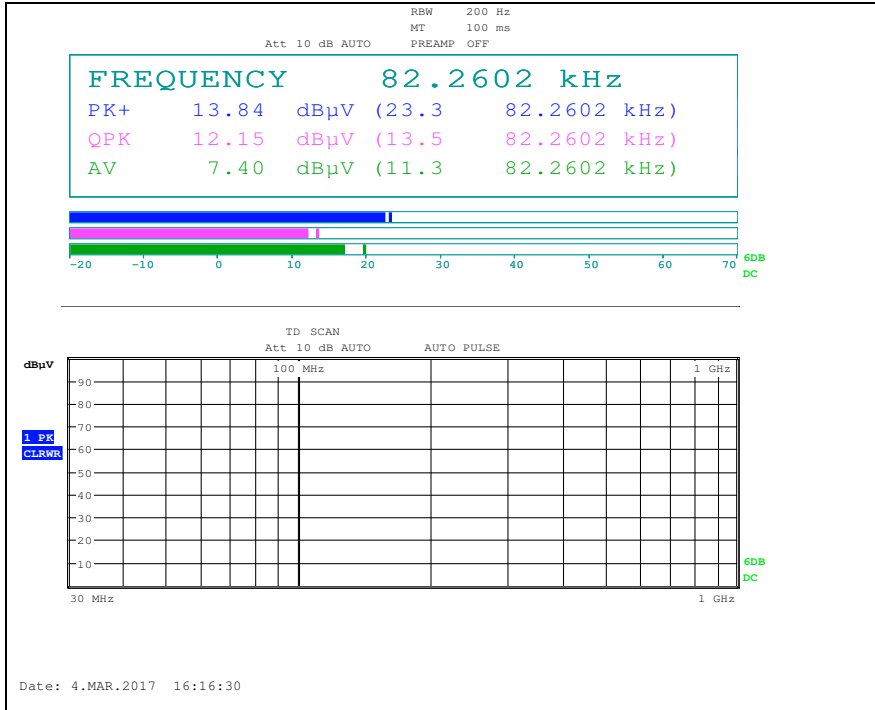

The results shown in this test report refer only to the sample(s) tested unless otherwise stated. This test report cannot be reproduced, except in full, without prior written permission of the Company.

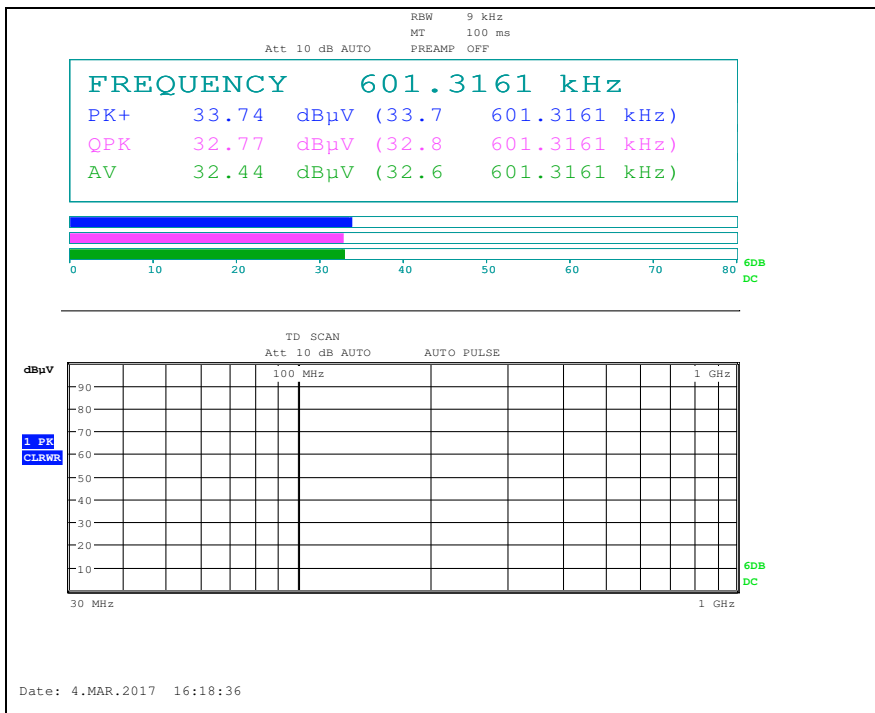
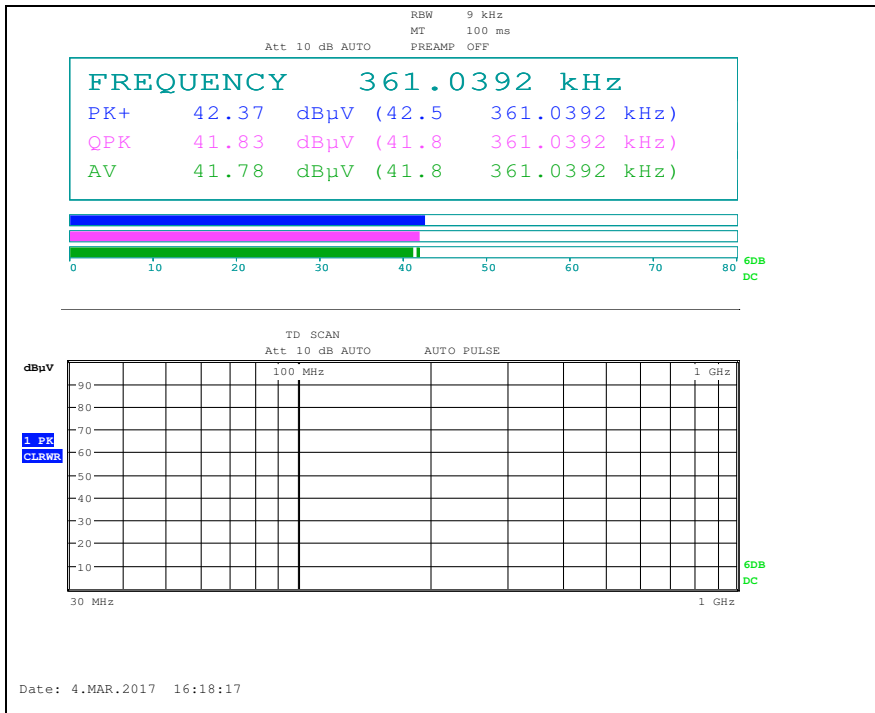

The results shown in this test report refer only to the sample(s) tested unless otherwise stated. This test report cannot be reproduced, except in full, without prior written permission of the Company.

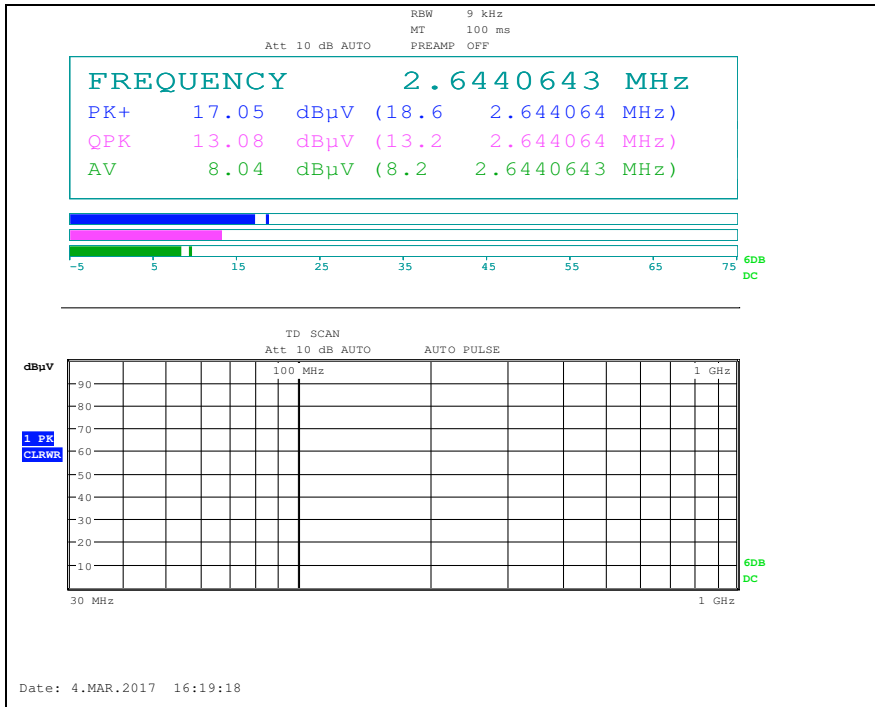
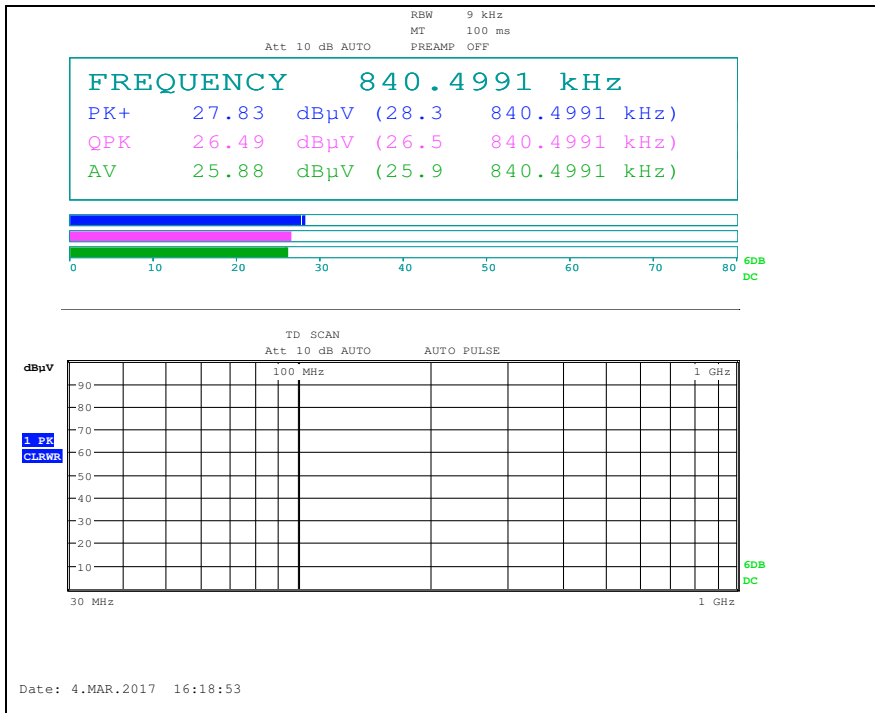

The results shown in this test report refer only to the sample(s) tested unless otherwise stated. This test report cannot be reproduced, except in full, without prior written permission of the Company.

Charging mode (5W)

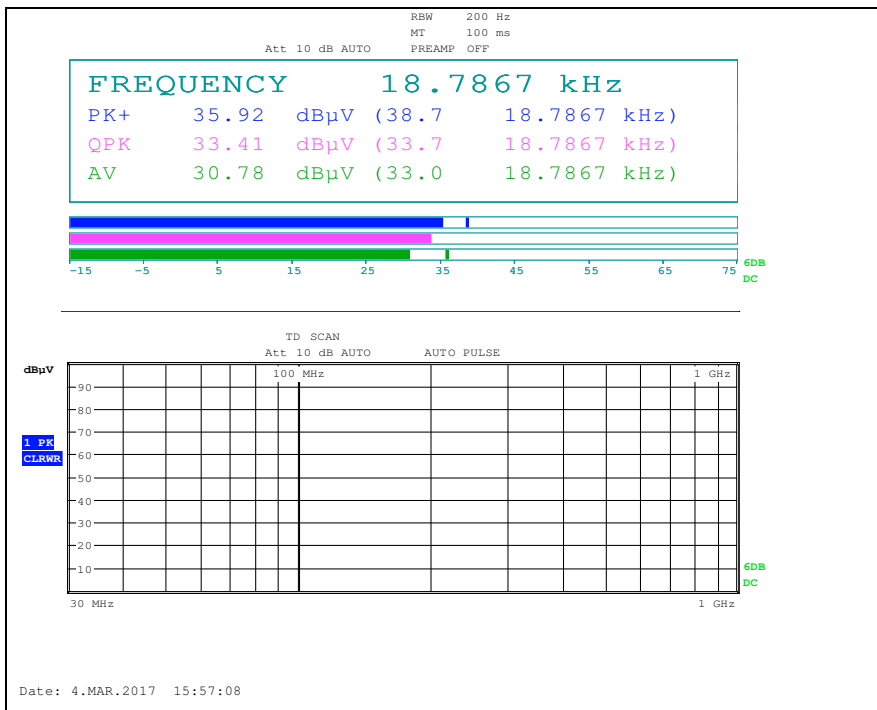
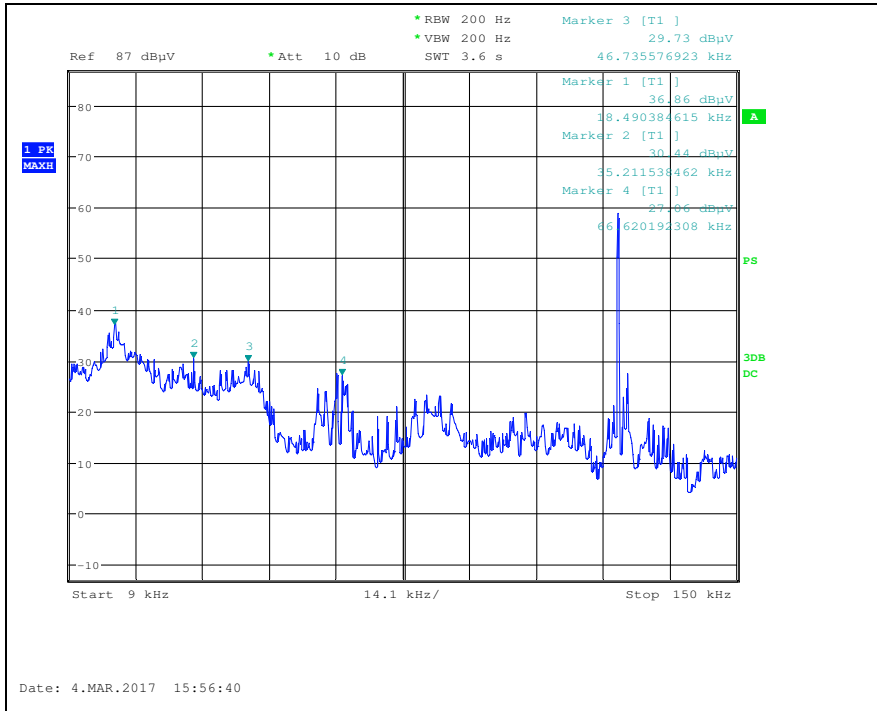

The results shown in this test report refer only to the sample(s) tested unless otherwise stated. This test report cannot be reproduced, except in full, without prior written permission of the Company.

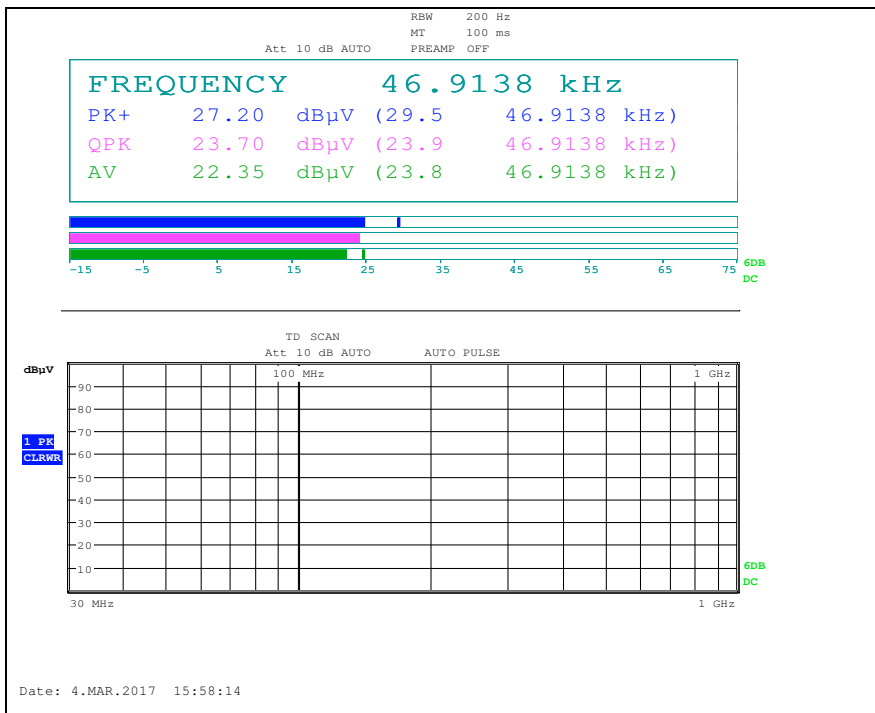
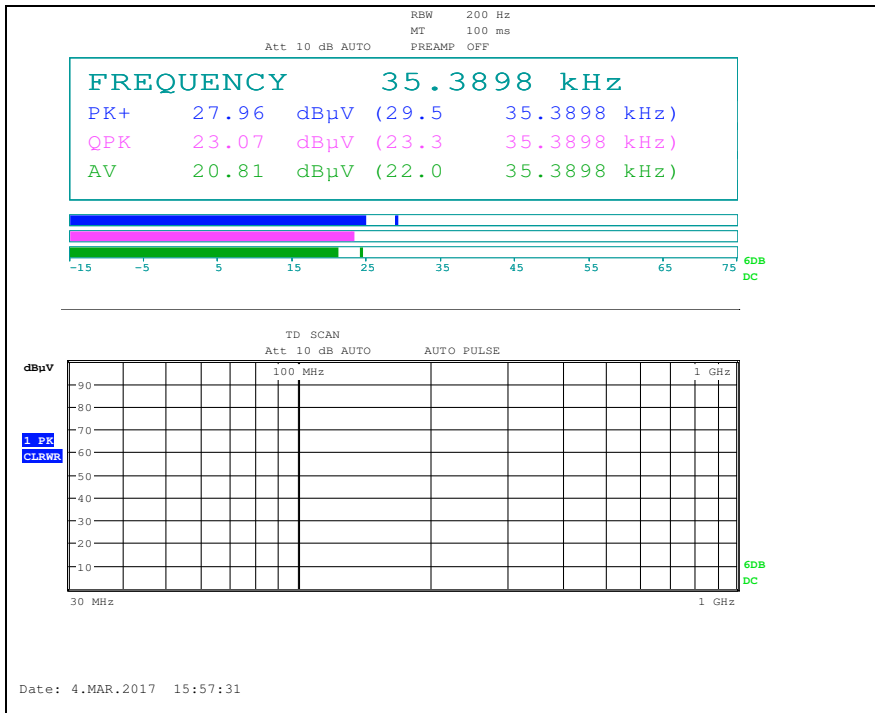

The results shown in this test report refer only to the sample(s) tested unless otherwise stated. This test report cannot be reproduced, except in full, without prior written permission of the Company.

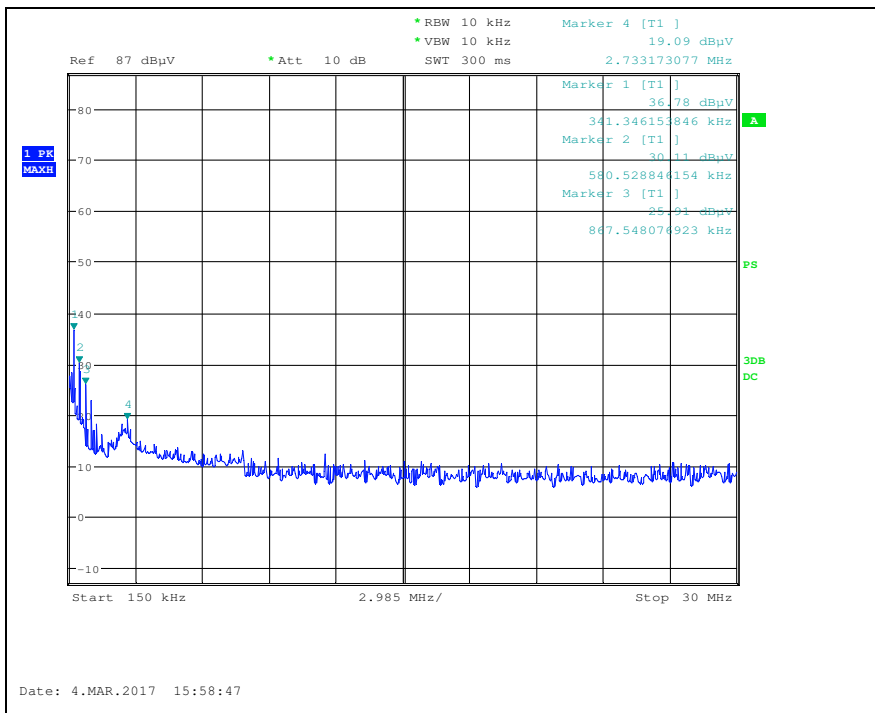
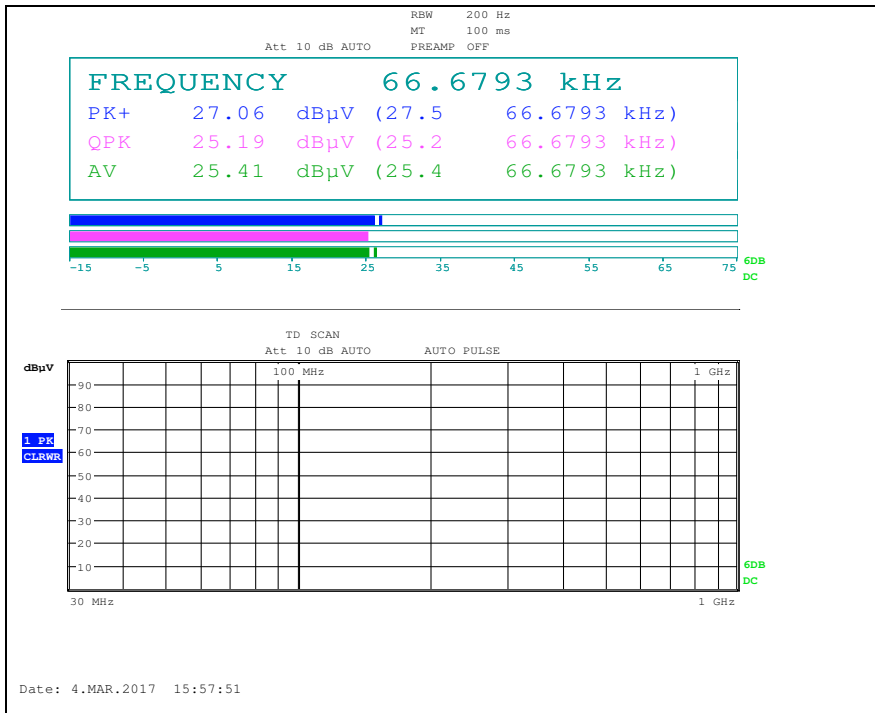

The results shown in this test report refer only to the sample(s) tested unless otherwise stated. This test report cannot be reproduced, except in full, without prior written permission of the Company.



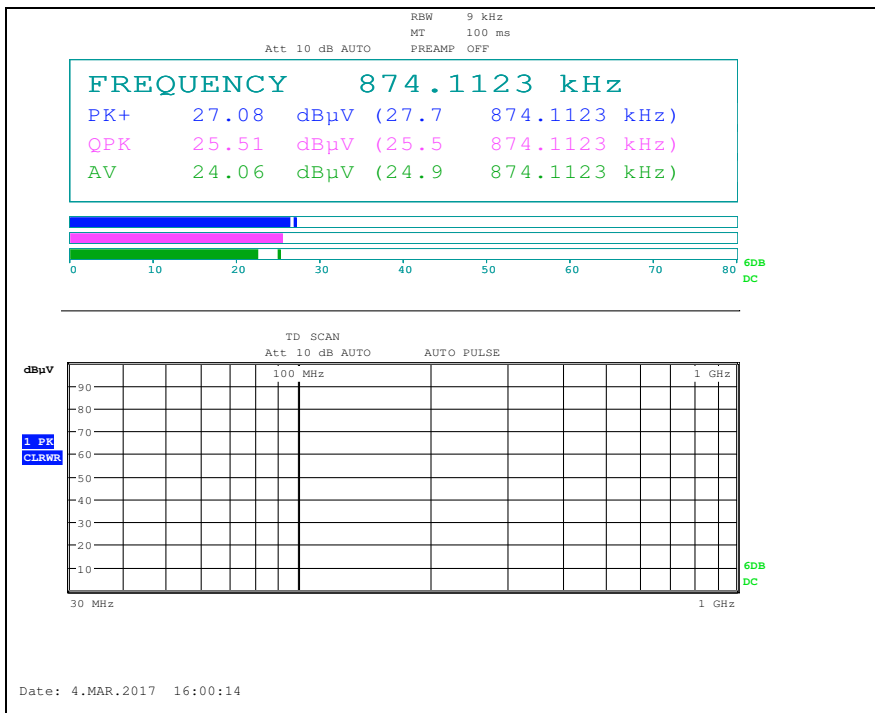
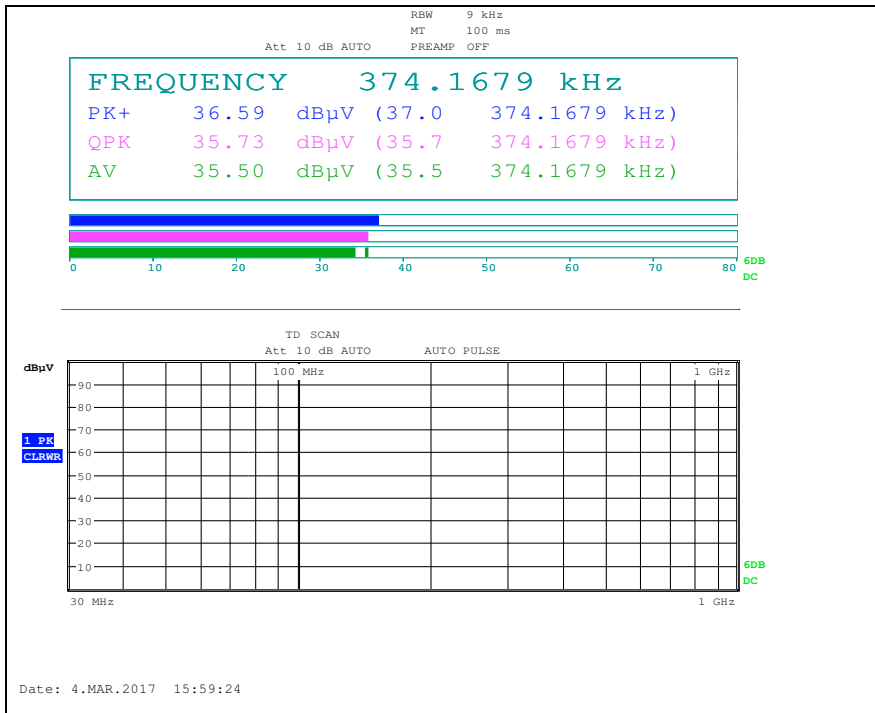

The results shown in this test report refer only to the sample(s) tested unless otherwise stated. This test report cannot be reproduced, except in full, without prior written permission of the Company.

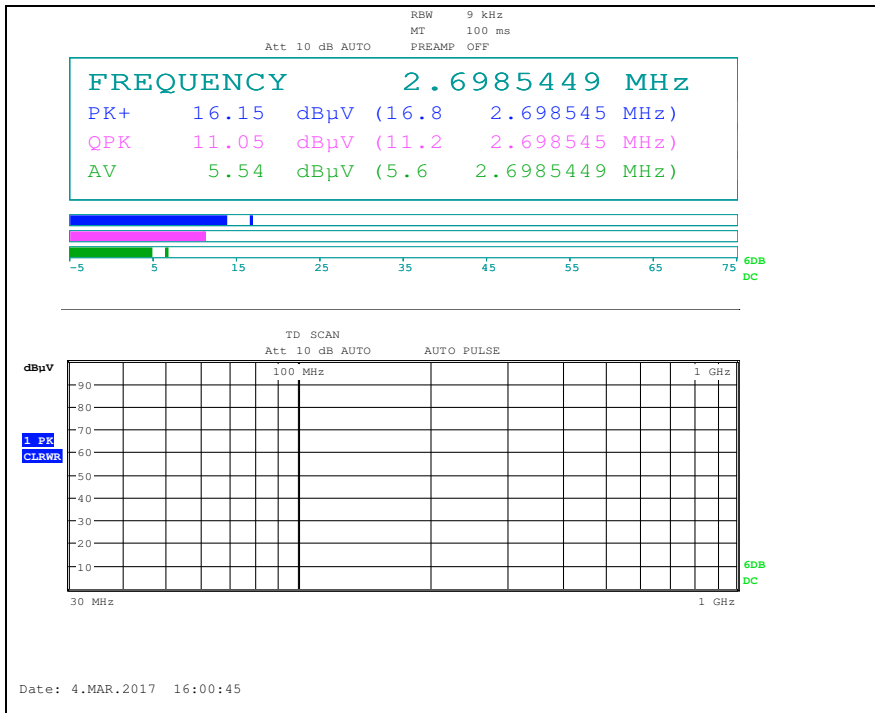

Charging mode (15W)

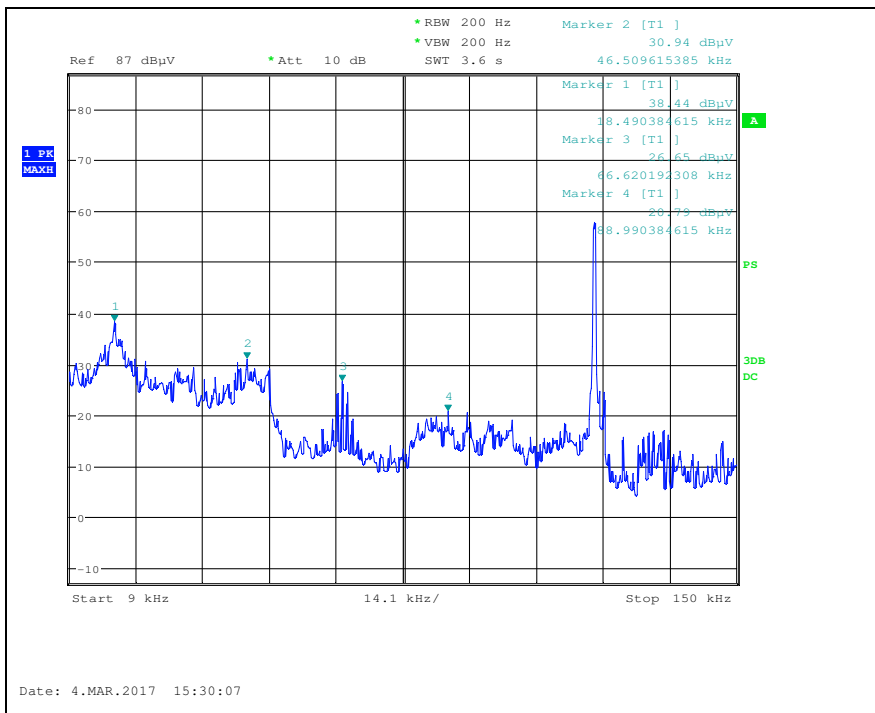

The results shown in this test report refer only to the sample(s) tested unless otherwise stated. This test report cannot be reproduced, except in full, without prior written permission of the Company.

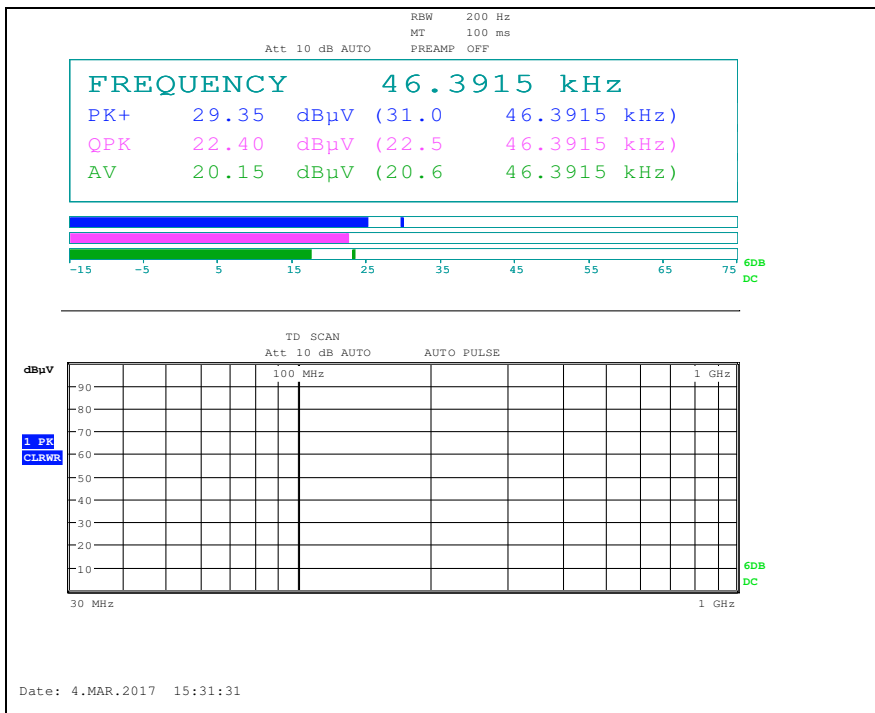
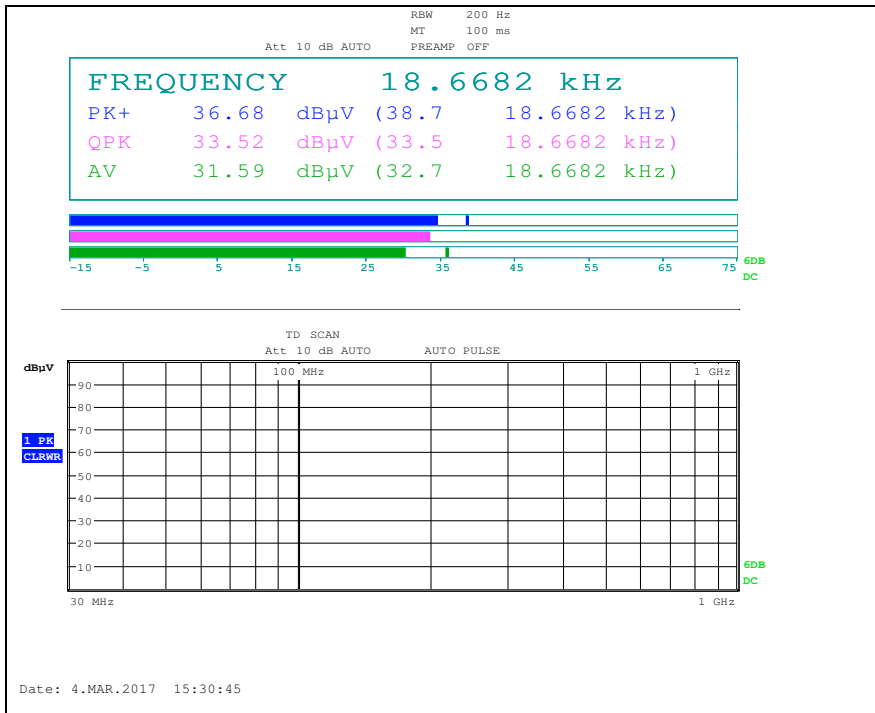

The results shown in this test report refer only to the sample(s) tested unless otherwise stated. This test report cannot be reproduced, except in full, without prior written permission of the Company.

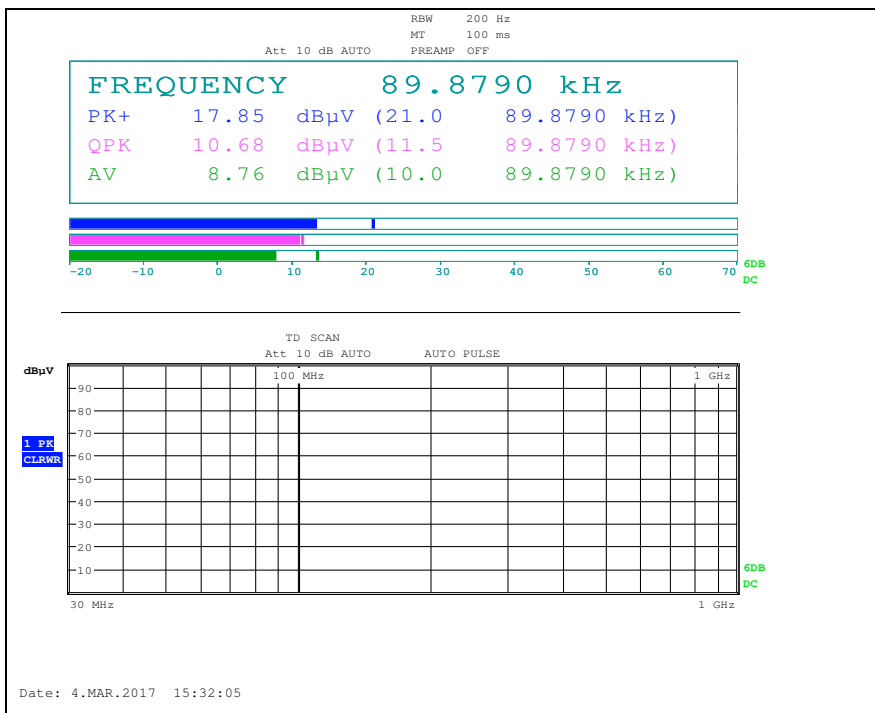
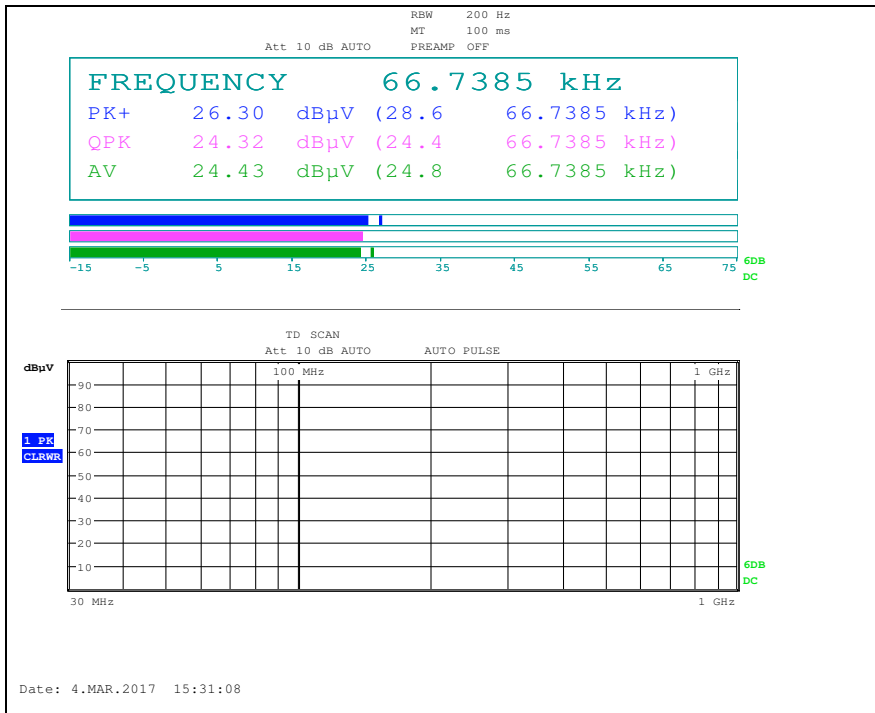

The results shown in this test report refer only to the sample(s) tested unless otherwise stated. This test report cannot be reproduced, except in full, without prior written permission of the Company.

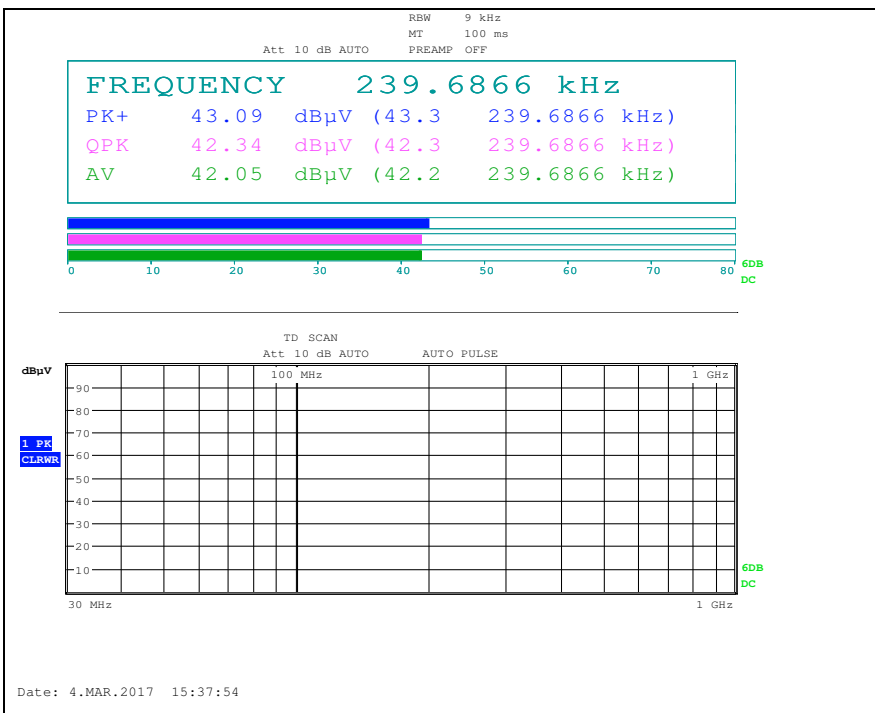
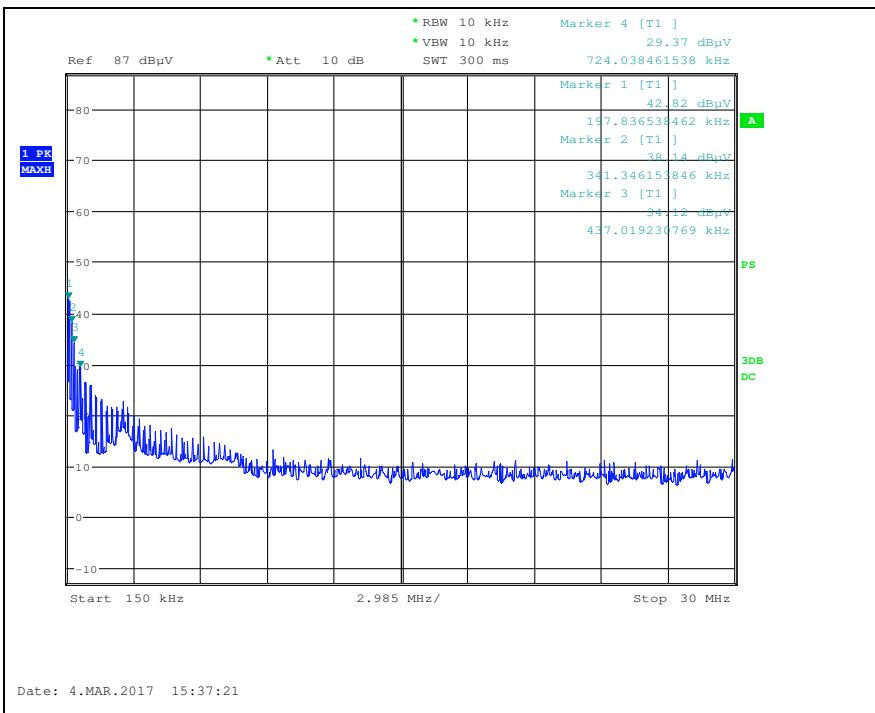

The results shown in this test report refer only to the sample(s) tested unless otherwise stated. This test report cannot be reproduced, except in full, without prior written permission of the Company.

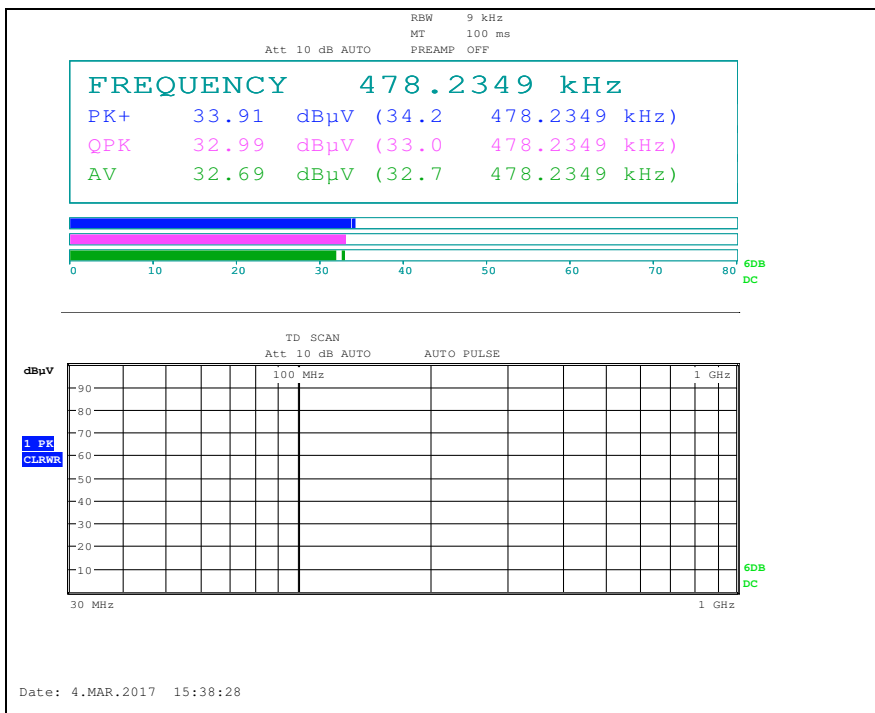
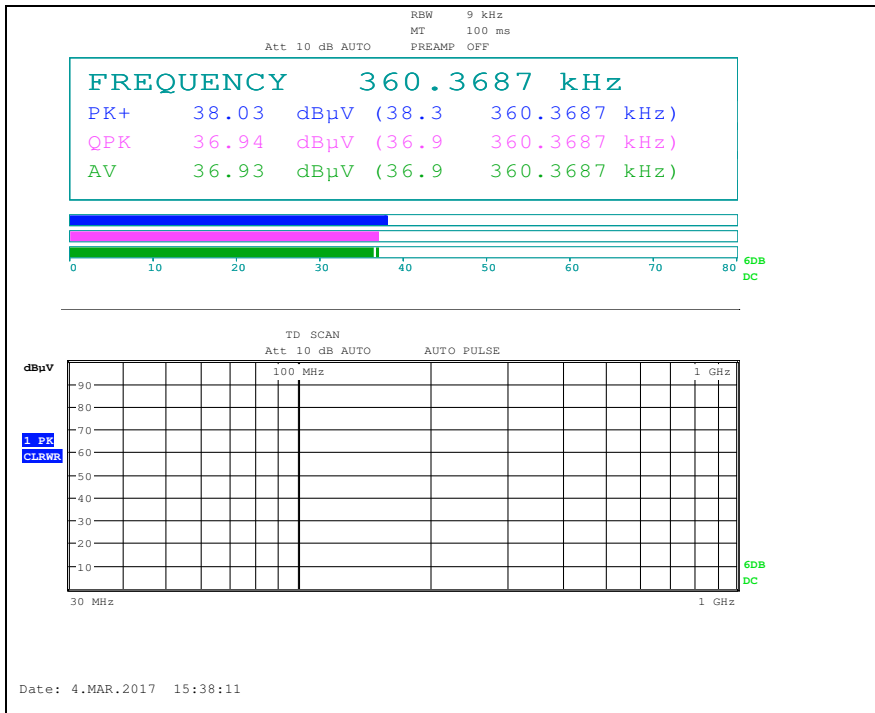

The results shown in this test report refer only to the sample(s) tested unless otherwise stated. This test report cannot be reproduced, except in full, without prior written permission of the Company.

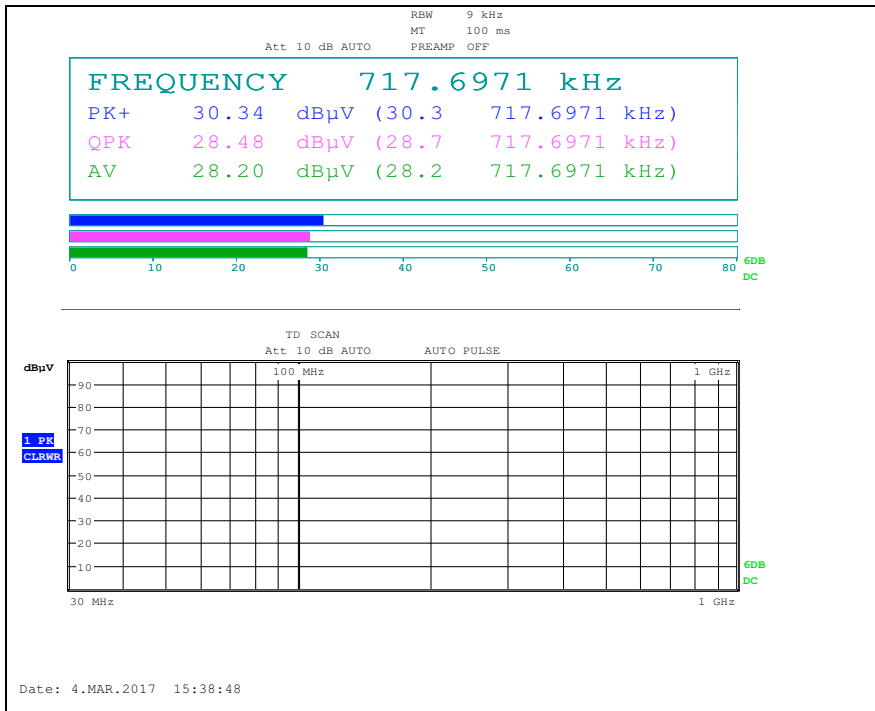

The results shown in this test report refer only to the sample(s) tested unless otherwise stated. This test report cannot be reproduced, except in full, without prior written permission of the Company.

### 3. 20 dB Bandwidth

#### 3.1. Test Setup

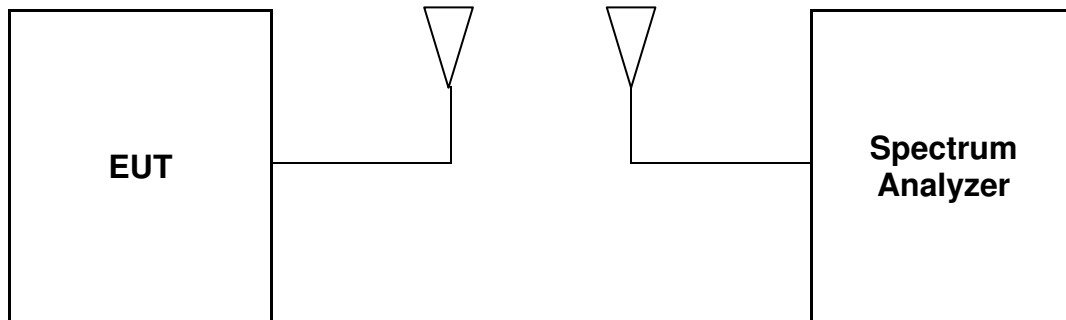

#### 3.2. Limit

None; for reporting purposed only

#### 3.3. Test Procedure

- a. Span = between 2 to 5 times the 20 dB Bandwidth,  
 RBW = in the range of 1 % to 5 % of the 20 dB Bandwidth,  
 VBW = approximately 3 x RBW, Sweep = auto, Detector = peak, Trace = max hold.
- b. The marker-to-peak function to set the mark to the peak of the emission. Use the marker-delta function to measure 20 dB down one side of the emission. Reset the function, and move the marker to the other side of the emission, until it is (as close as possible to) even with the reference marker level. The marker-delta reading at this point is 20 dB bandwidth of the emission.

*The results shown in this test report refer only to the sample(s) tested unless otherwise stated. This test report cannot be reproduced, except in full, without prior written permission of the Company.*

**SGS Korea Co., Ltd. (Gunpo Laboratory)** 4, LS-ro 182beon-gil, Gunpo-si, Gyeonggi-do, Korea, 15807 <http://www.sgsgroup.kr>



### 3.4. Test Result

Ambient temperature : (23 ± 1) °C  
 Relative humidity : 47 % R.H.

EUT status	20 dB Bandwidth (Hz)	Limit
With client device (100 % battery status)	532.8	Reporting proposed only
With Test Zigboard (5W)	532.6	
With Test Zigboard (15W)	518.1	

#### 20 dB Bandwidth

##### With client device (100 % battery status)

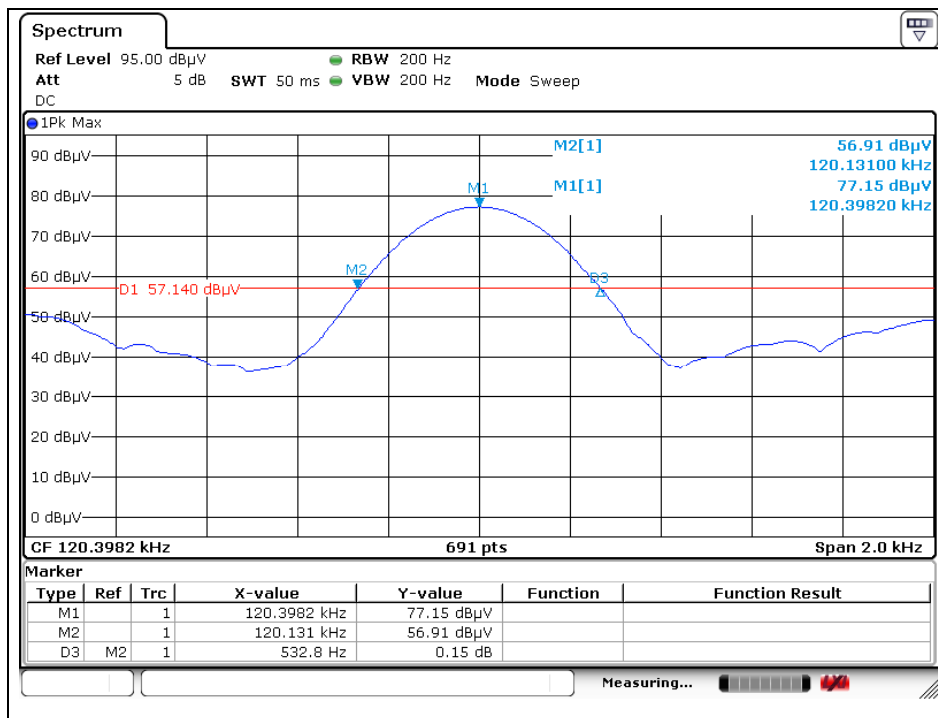

The results shown in this test report refer only to the sample(s) tested unless otherwise stated. This test report cannot be reproduced, except in full, without prior written permission of the Company.

## With Test Zigboard (5W)

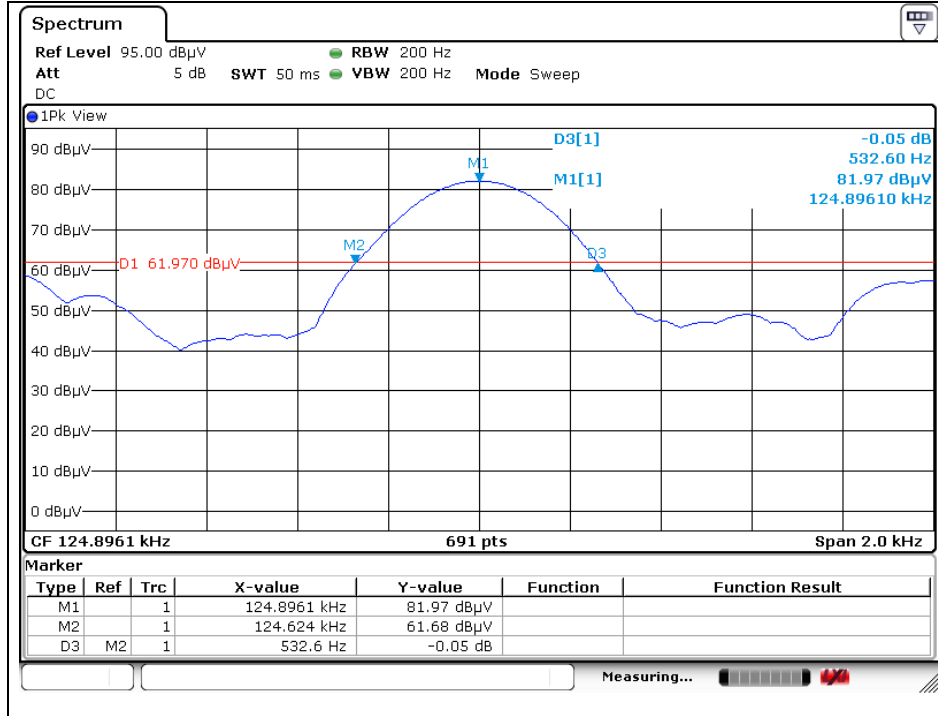

## With Test Zigboard (15W)

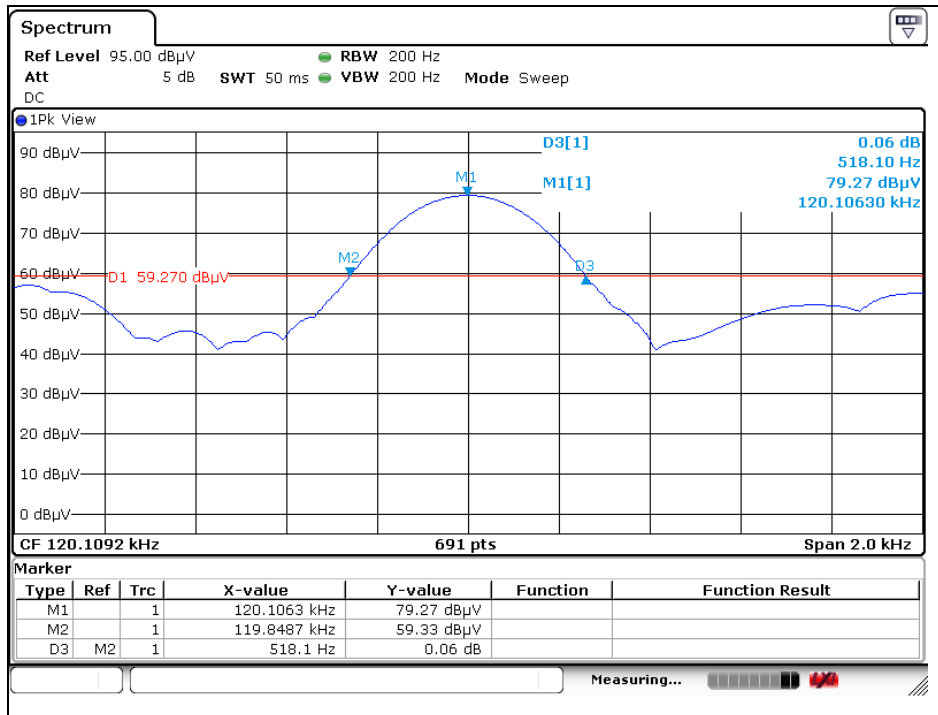

The results shown in this test report refer only to the sample(s) tested unless otherwise stated. This test report cannot be reproduced, except in full, without prior written permission of the Company.

## 4. Transmitter AC Power Line Conducted Emission

### 4.1. Test Setup

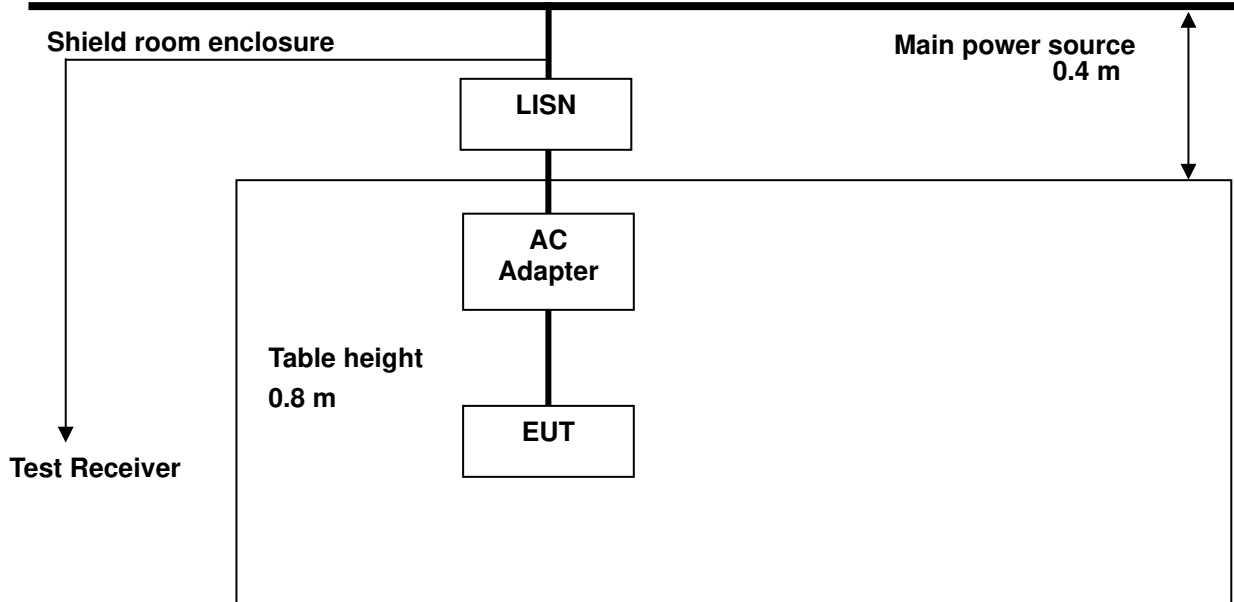

### 4.2. Limit

According to §15.207(a), for an intentional radiator that is designed to be connected to the public utility (AC) power line, the radio frequency voltage that is conducted back onto the AC power line on any frequency or frequencies, within the band 150 kHz to 30 MHz, shall not exceed the limits in the following table, as measured using a 50  $\mu$ H / 50 ohm line impedance stabilization network(LISN).

Compliance with the provision of this paragraph shall on the measurement of the radio frequency voltage between each power line and ground at the power terminal. The lower applies at the boundary between the frequency ranges.

Frequency of Emission (MHz)	Conducted limit (dB $\mu$ V)	
	Quasi-peak	Average
0.15 – 0.50	66 - 56*	56 - 46*
0.50 – 5.00	56	46
5.00 – 30.0	60	50

\* Decreases with the logarithm of the frequency.

The results shown in this test report refer only to the sample(s) tested unless otherwise stated. This test report cannot be reproduced, except in full, without prior written permission of the Company.

SGS Korea Co., Ltd. (Gunpo Laboratory) 4, LS-ro 182beon-gil, Gunpo-si, Gyeonggi-do, Korea, 15807 <http://www.sgsgroup.kr>

---

### 4.3. Test Procedures

AC conducted emissions from the EUT were measured according to the dictates of ANSI C63.10:2013

1. The test procedure is performed in a 6.5 m × 3.5 m × 3.5 m (L × W × H) shielded room. The EUT along with its peripherals were placed on a 1.0 m (W) × 1.5 m (L) and 0.8 m in height wooden table and the EUT was adjusted to maintain a 0.4 meter space from a vertical reference plane.
2. The EUT was connected to power mains through a line impedance stabilization network (LISN) which provides 50 ohm coupling impedance for measuring instrument and the chassis ground was bounded to the horizontal ground plane of shielded room.
3. All peripherals were connected to the second LISN and the chassis ground also bounded to the horizontal ground plane of shielded room.
4. The excess power cable between the EUT and the LISN was bundled. The power cables of peripherals were unbundled. All connecting cables of EUT and peripherals were moved to find the maximum emission.

---

*The results shown in this test report refer only to the sample(s) tested unless otherwise stated. This test report cannot be reproduced, except in full, without prior written permission of the Company.*

**SGS Korea Co., Ltd. (Gunpo Laboratory)** 4, LS-ro 182beon-gil, Gunpo-si, Gyeonggi-do, Korea, 15807 <http://www.sgsgroup.kr>

#### 4.4. Test Results

The following table shows the highest levels of conducted emissions on both phase of Hot and Neutral line.

Ambient temperature : (23 ± 1) °C  
 Relative humidity : 47 % R.H.  
 Frequency range : 0.15 MHz – 30 MHz  
 Measured Bandwidth : 9 kHz

##### Charging mode with Client device (100 % status)

FREQ. (MHz)	LEVEL(dB $\mu$ V)		LINE	LIMIT(dB $\mu$ V)		MARGIN(dB)	
	Q-Peak	Average		Q-Peak	Average	Q-Peak	Average
0.45	39.90	22.50	N	56.88	46.88	16.98	24.38
2.55	25.20	7.40	N	56.00	46.00	30.80	38.60
7.32	26.40	4.90	N	60.00	50.00	33.60	45.10
13.75	19.10	11.50	N	60.00	50.00	40.90	38.50
23.24	10.40	5.50	N	60.00	50.00	49.60	44.50
27.07	32.00	6.10	N	60.00	50.00	28.00	43.90
0.46	40.50	21.70	H	56.69	46.69	16.19	24.99
3.24	30.00	5.60	H	56.00	46.00	26.00	40.40
6.98	31.40	6.00	H	60.00	50.00	28.60	44.00
14.29	12.60	5.40	H	60.00	50.00	47.40	44.60
22.99	40.40	39.00	H	60.00	50.00	19.60	11.00
27.76	29.90	5.90	H	60.00	50.00	30.10	44.10

The results shown in this test report refer only to the sample(s) tested unless otherwise stated. This test report cannot be reproduced, except in full, without prior written permission of the Company.

**Charging mode with Test Zigboard (5W)**

FREQ. (MHz)	LEVEL(dB $\mu$ V)		LINE	LIMIT(dB $\mu$ V)		MARGIN(dB)	
	Q-Peak	Average		Q-Peak	Average	Q-Peak	Average
0.46	41.5	31.5	N	56.7	46.7	15.2	15.2
2.95	12.7	6.5	N	56.0	46.0	43.3	39.5
4.44	20.5	12.8	N	56.0	46.0	35.5	33.2
7.01	18.8	11.0	N	60.0	50.0	41.2	39.0
13.66	24.0	18.1	N	60.0	50.0	36.0	31.9
24.29	40.4	39.9	N	60.0	50.0	19.6	10.1
0.46	49.80	39.70	H	56.69	46.69	6.89	6.99
4.51	23.60	15.40	H	56.00	46.00	32.40	30.60
5.61	26.70	18.70	H	60.00	50.00	33.30	31.30
8.65	24.10	17.50	H	60.00	50.00	35.90	32.50
16.83	23.80	17.50	H	60.00	50.00	36.20	32.50
25.57	39.00	40.10	H	60.00	50.00	21.00	9.90

The results shown in this test report refer only to the sample(s) tested unless otherwise stated. This test report cannot be reproduced, except in full, without prior written permission of the Company.

**Charging mode with Test Zigboard (15W)**

FREQ. (MHz)	LEVEL(dB $\mu$ V)		LINE	LIMIT(dB $\mu$ V)		MARGIN(dB)	
	Q-Peak	Average		Q-Peak	Average	Q-Peak	Average
0.17	42.5	22.7	N	65.0	55.0	22.5	32.3
0.37	34.7	22.7	N	58.5	48.5	23.8	25.8
5.46	25.1	17.1	N	60.0	50.0	34.9	32.9
8.84	22.8	14.4	N	60.0	50.0	37.2	35.6
16.31	20.8	14.4	N	60.0	50.0	39.2	35.6
24.67	39.1	38.9	N	60.0	50.0	20.9	11.1
0.37	47.3	38.2	H	58.5	48.5	11.2	10.3
5.06	30.8	22.0	H	60.0	50.0	29.2	28.0
7.98	27.8	19.3	H	60.0	50.0	32.2	30.7
9.99	26.0	18.7	H	60.0	50.0	34.0	31.3
17.62	28.2	21.3	H	60.0	50.0	31.8	28.7
25.59	37.2	38.5	H	60.0	50.0	22.8	11.5

**Note;**

- Line ( H ): Hot, Line ( N ): Neutral
- All antennas of operation and charging mode with client device (1 %, 50 %, and 100 % of battery, Zigboard 5W, 15W) were tested.  
As worst condition of battery, charging mode with client device (100 %) is reported.
- The limit for Class B device(s) from 150 kHz to 30 MHz are specified in Section of the Title 47 CFR.
- Traces shown in plot were made by using a peak detector and average detector.
- Deviations to the Specifications: None.

*The results shown in this test report refer only to the sample(s) tested unless otherwise stated. This test report cannot be reproduced, except in full, without prior written permission of the Company.*

**Charging mode with Client device (100 % status)**

Test mode: (Neutral)

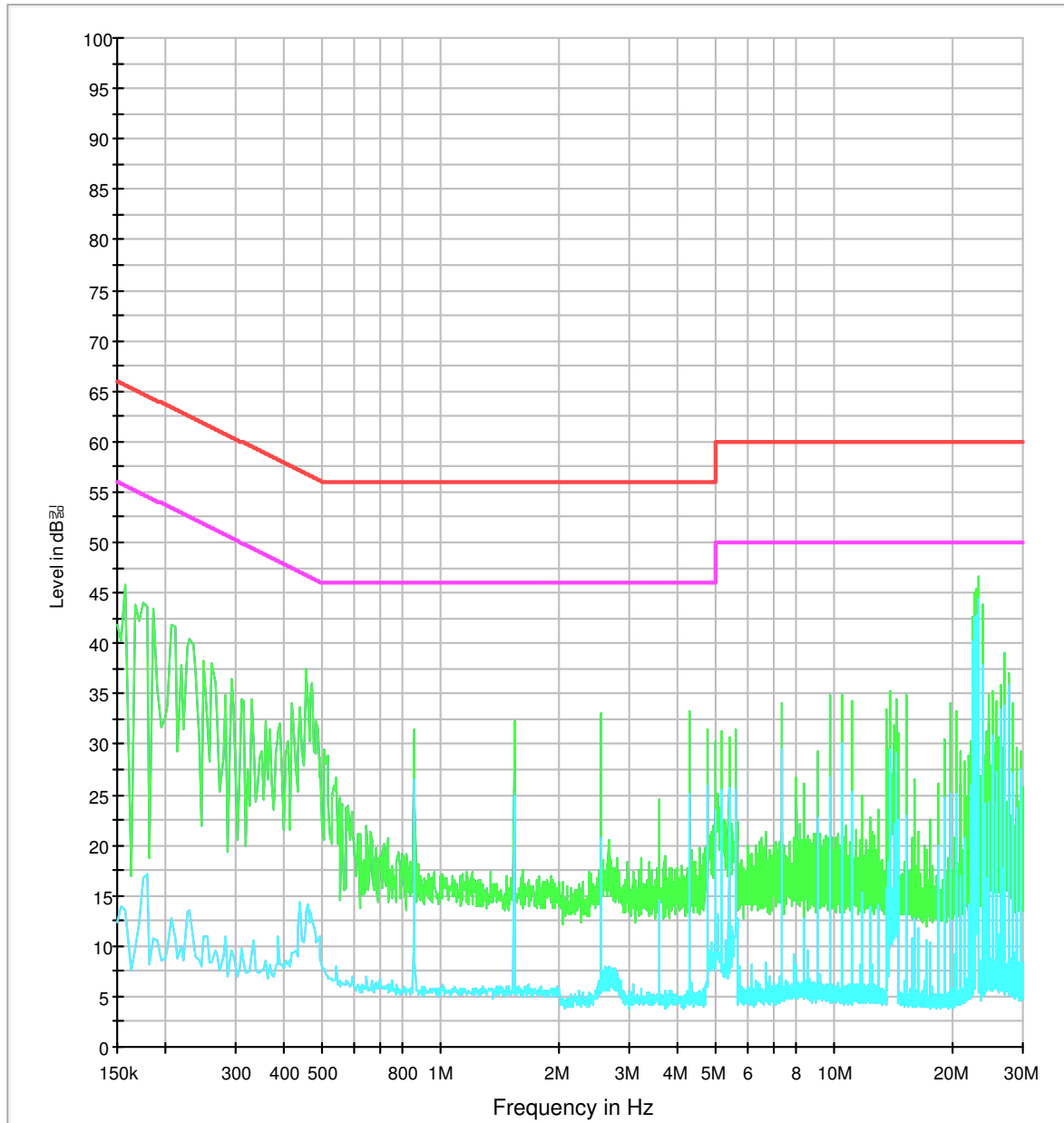

The results shown in this test report refer only to the sample(s) tested unless otherwise stated. This test report cannot be reproduced, except in full, without prior written permission of the Company.

SGS Korea Co., Ltd. (Gunpo Laboratory) 4, LS-ro 182beon-gil, Gunpo-si, Gyeonggi-do, Korea, 15807 <http://www.sgsgroup.kr>



Test mode: (Hot)

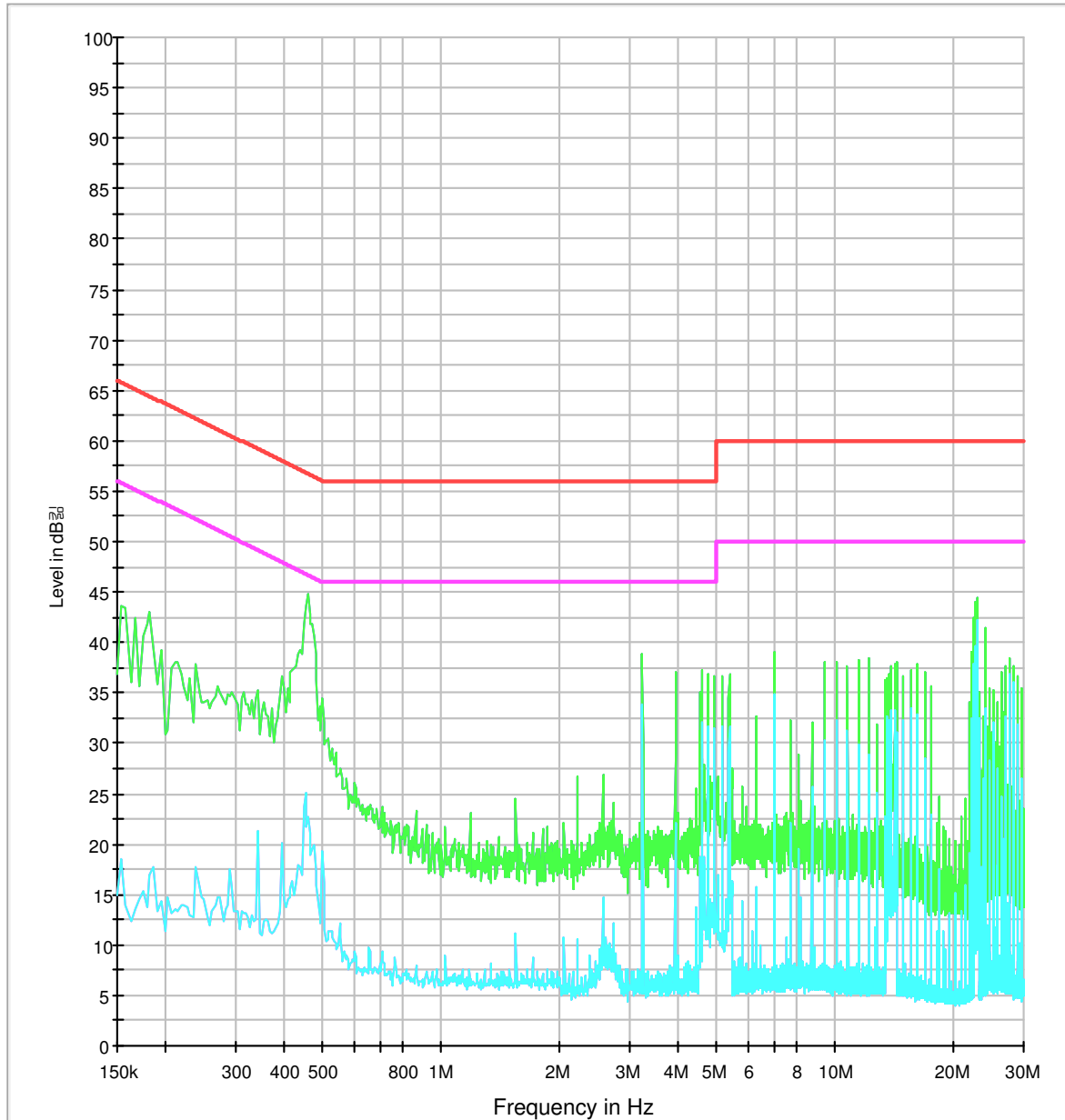

The results shown in this test report refer only to the sample(s) tested unless otherwise stated. This test report cannot be reproduced, except in full, without prior written permission of the Company.

SGS Korea Co., Ltd. (Gunpo Laboratory) 4, LS-ro 182beon-gil, Gunpo-si, Gyeonggi-do, Korea, 15807 <http://www.sgsgroup.kr>

## Charging mode with Test Zigboard (5W)

Test mode: (Neutral)

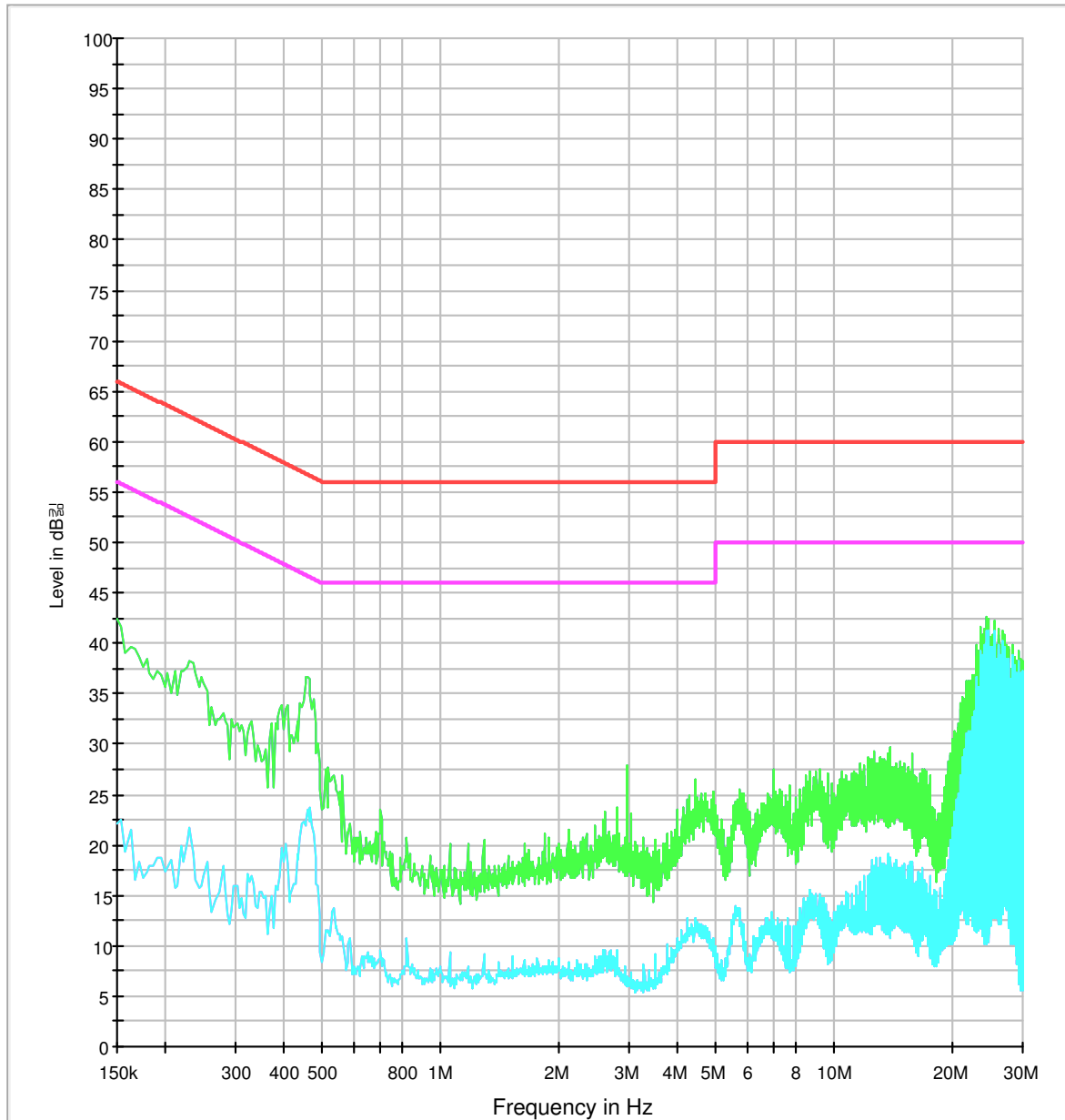

The results shown in this test report refer only to the sample(s) tested unless otherwise stated. This test report cannot be reproduced, except in full, without prior written permission of the Company.

SGS Korea Co., Ltd. (Gunpo Laboratory) 4, LS-ro 182beon-gil, Gunpo-si, Gyeonggi-do, Korea, 15807 <http://www.sgsgroup.kr>

Test mode: (Hot)

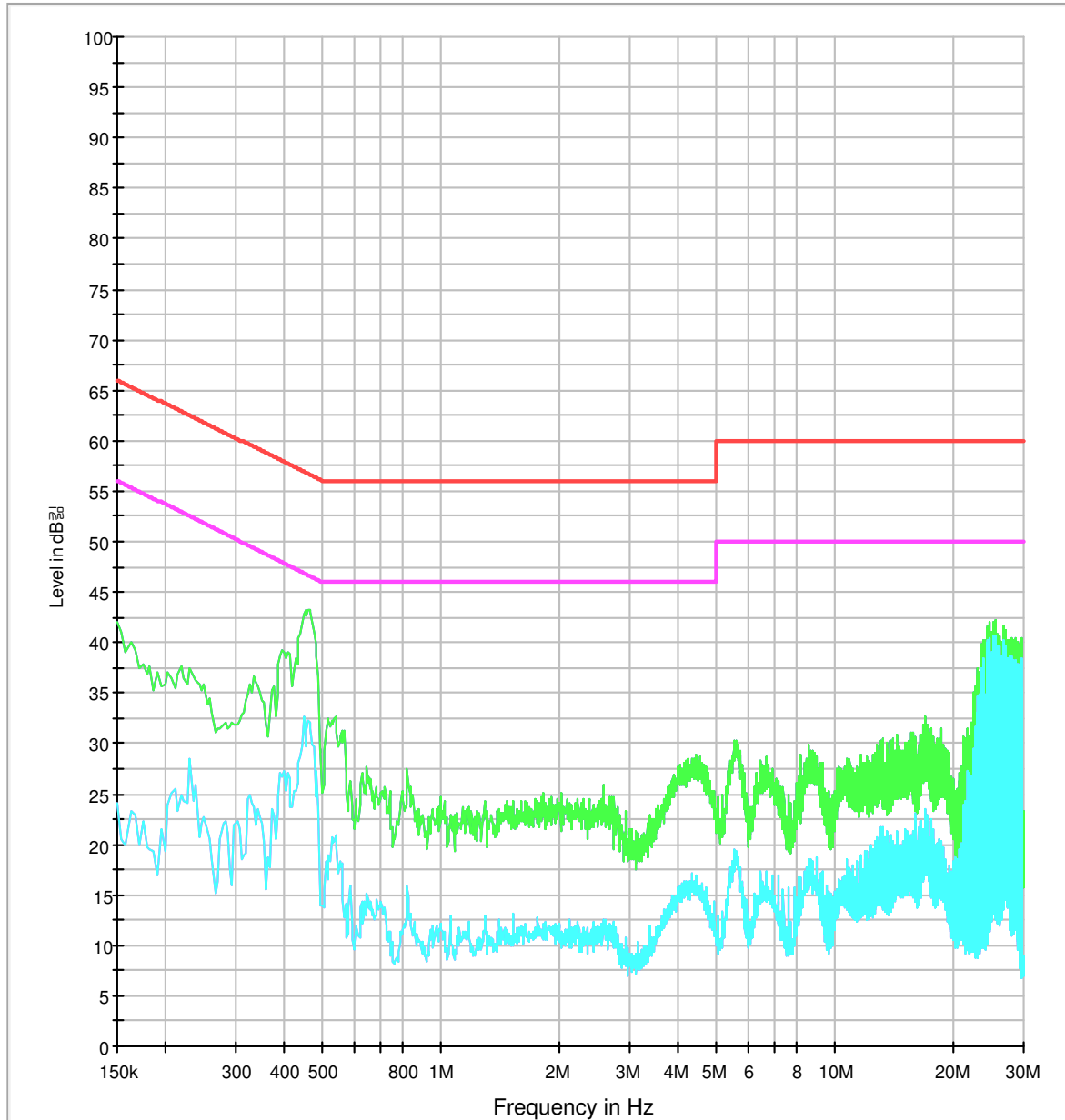

The results shown in this test report refer only to the sample(s) tested unless otherwise stated. This test report cannot be reproduced, except in full, without prior written permission of the Company.

## Charging mode with Test Zigboard (15W)

Test mode: (Neutral)

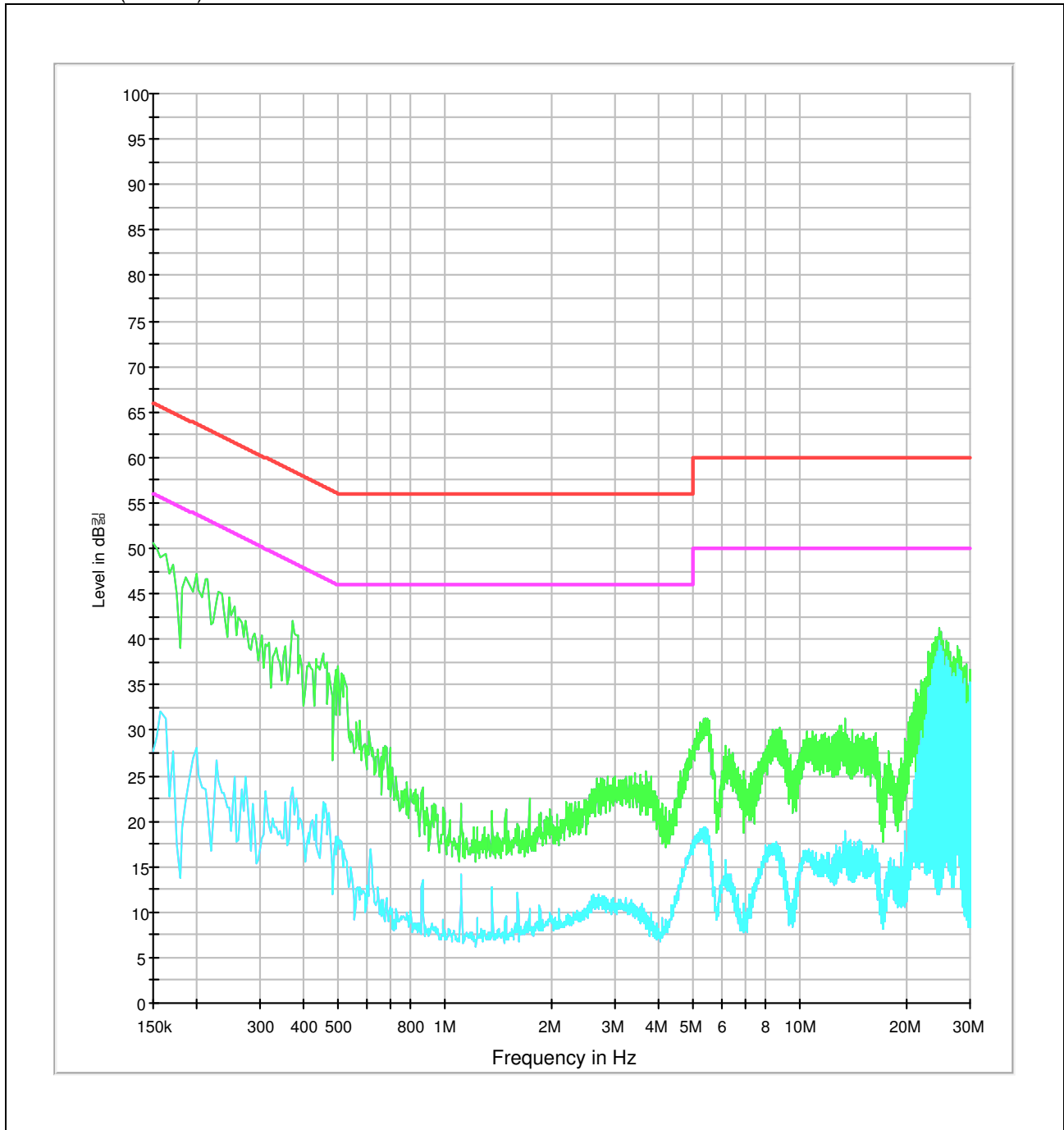

The results shown in this test report refer only to the sample(s) tested unless otherwise stated. This test report cannot be reproduced, except in full, without prior written permission of the Company.

SGS Korea Co., Ltd. (Gunpo Laboratory) 4, LS-ro 182beon-gil, Gunpo-si, Gyeonggi-do, Korea, 15807 <http://www.sgsgroup.kr>

Test mode: (Hot)

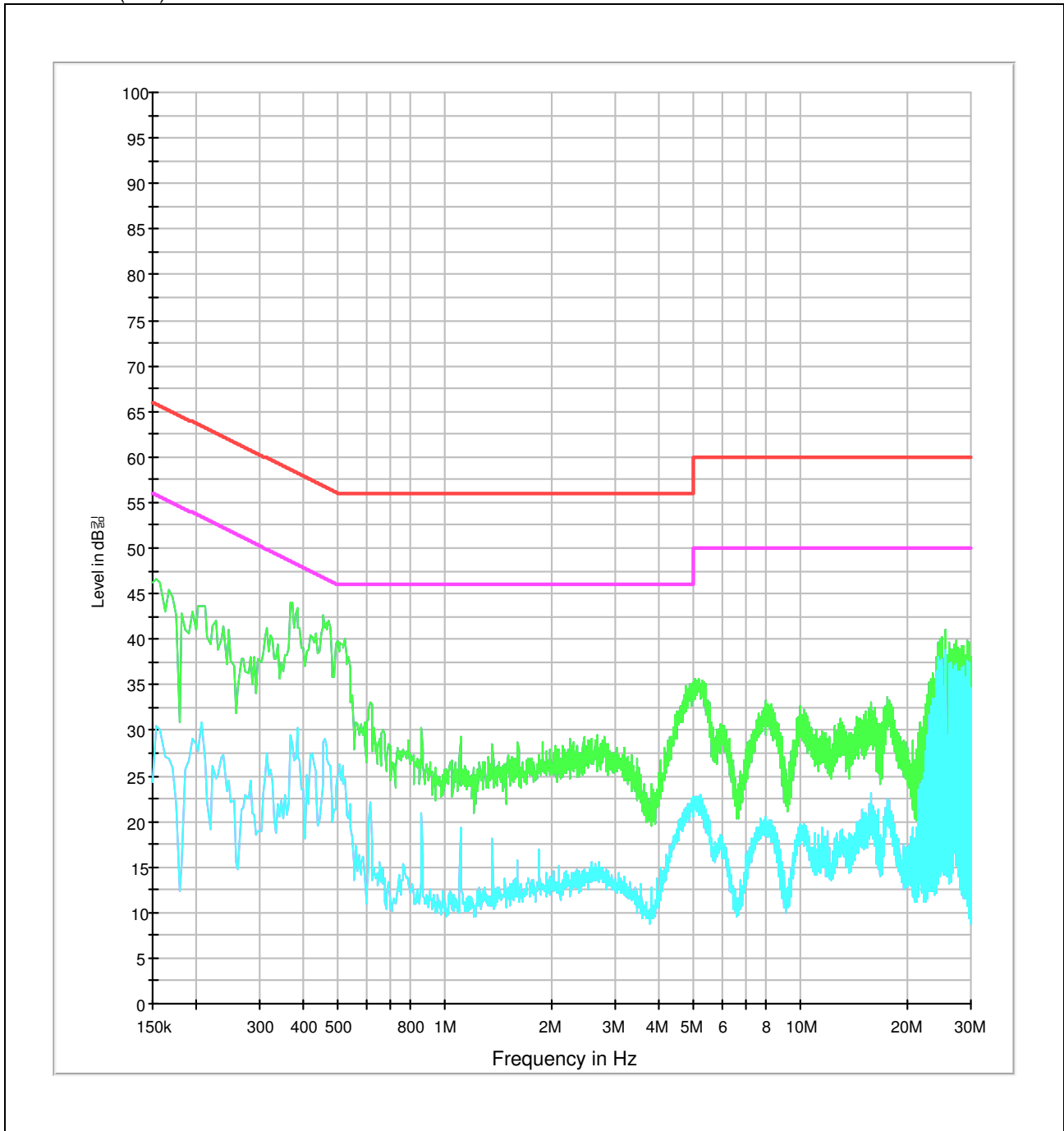

**- End of the Test Report -**

The results shown in this test report refer only to the sample(s) tested unless otherwise stated. This test report cannot be reproduced, except in full, without prior written permission of the Company.

SGS Korea Co., Ltd. (Gunpo Laboratory) 4, LS-ro 182beon-gil, Gunpo-si, Gyeonggi-do, Korea, 15807 <http://www.sgsgroup.kr>